



**HAL**  
open science

## **A methodologic project to characterize and model COTS component reliability**

André Durier, Alain Bensoussan, Moustafa Zerarka, Chaimae Ghfiri,  
Alexandre Boyer, H el ene Fr emont

► **To cite this version:**

Andr e Durier, Alain Bensoussan, Moustafa Zerarka, Chaimae Ghfiri, Alexandre Boyer, et al.. A methodologic project to characterize and model COTS component reliability. *Microelectronics Reliability*, 2015, 55 (9-10), pp.2097-2102. 10.1016/j.microrel.2015.06.140 . hal-01582570

**HAL Id: hal-01582570**

**<https://hal.science/hal-01582570>**

Submitted on 6 Sep 2017

**HAL** is a multi-disciplinary open access archive for the deposit and dissemination of scientific research documents, whether they are published or not. The documents may come from teaching and research institutions in France or abroad, or from public or private research centers.

L'archive ouverte pluridisciplinaire **HAL**, est destin ee au d ep ot et  a la diffusion de documents scientifiques de niveau recherche, publi es ou non,  emanant des  tablissements d'enseignement et de recherche fran ais ou  trangers, des laboratoires publics ou priv es.



## Open Archive TOULOUSE Archive Ouverte (OATAO)

OATAO is an open access repository that collects the work of Toulouse researchers and makes it freely available over the web where possible.

This is an author-deposited version published in : <http://oatao.univ-toulouse.fr/>  
Eprints ID : 18034

**To link to this article** : DOI: 10.1016/j.microrel.2015.06.140  
URL : <https://doi.org/10.1016/j.microrel.2015.06.140>

<p><b>To cite this version</b> : Durier, André and Bensoussan, Alain and Zerarka, Moustafa and Ghfiri, Chaimae and Boyer, Alexandre and Frémont, Hélène <i>A methodologic project to characterize and model COTS component reliability</i>. (2015) <i>Microelectronics Reliability</i>, vol. 55 (n° 9-10). pp. 2097-2102. ISSN 0026-2714</p>
--

Any correspondence concerning this service should be sent to the repository administrator: [staff-oatao@listes-diff.inp-toulouse.fr](mailto:staff-oatao@listes-diff.inp-toulouse.fr)

# A methodologic project to characterize and model COTS component reliability

A. Durier<sup>a,b,\*</sup>, A. Bensoussan<sup>a,c</sup>, M. Zerarka<sup>a</sup>, C. Ghfiri<sup>a</sup>, A. Boyer<sup>d</sup>, H. Frémont<sup>e</sup>

<sup>a</sup> Institut de Recherche Technologique Saint Exupery, 31432 Toulouse, France

<sup>b</sup> Continental Automotive France, 31036 Toulouse, France

<sup>c</sup> Thales Alenia Space France, 31037 Toulouse, France

<sup>d</sup> LAAS-CNRS France, 31031 Toulouse, France

<sup>e</sup> Laboratoire de l'Intégration du Matériau au Système, 33405 Talence, France

## A B S T R A C T

The industries of transportation as the space industry are faced with a strong global economic competition which sets economic constraints on the cost of the functions. The use of COTS (Commercial Off-The-Shelf) components in embedded systems is more and more necessary to shorten the development cycles and reduce manufacturing costs. The application of electronic components comes overwhelmingly from public sectors whose requirement is to provide, in short development cycles, technological innovations including risk and cost mitigation. These development cycles must incorporate the specific constraints of embedded systems in terms of reliability, dependability, and availability, held in harsh environment and life.

Due to the low volume of components supplying the market of embedded systems, component manufacturers are unlikely to provide information necessary to supporting folders for certification or qualification. It is therefore necessary for the Space, Aeronautics and Automotive industries to characterize the performance and robustness of these COTS components in the operational and environmental conditions of their applications.

This paper presents the objectives and main challenges of a sponsored project dedicated to characterize and model COTS reliability.

### Keywords:

COTS reliability

Reliability characterization

EMC IC modeling

Immunity to natural radiation modeling

Component Assembly modeling

Soldered join reliability characterization

## 1. Introduction

The Electronics Robustness Project managed by Technology Research Institute (IRT) Saint-Exupery has two main objectives:

- Develop a generic platform for COTS' reliability characterization,
  - Develop modeling tools for COTS' reliability prediction.
- To achieve these objectives, the project is divided in 4 work-packages (WPs):
- WP1: Characterization/modeling of reliability and life time expectancy,
  - WP2: Characterization/modeling of immunity to natural radiations,
  - WP3: Characterization/modeling of EMC behavior (emission, immunity, signal integrity) and immunity to transients,
  - WP4: Characterization/modeling of the mechanical assembly (package on substrate).

For the next 3 years, chosen technologies for study are GaN (gallium nitride) commercial technologies for power switching and a 28 nm FDSOI (Fully Depleted Silicon On Insulator) digital technology.

\* Corresponding author at: Institut de Recherche Technologique Saint Exupery, 31432 Toulouse, France.

## 2. Characterization/modeling of reliability and life time expectancy

The most used mathematical approach in forecasting reliability is based on the Arrhenius law. While in chemistry, transition state theory aimed to explain the kinetics of reaction for elementary chemical reactions. This theory postulates the existence of a kind of chemical equilibrium, the near-equilibrium between reactants and activated transition complex as illustrated by Fig. 1.

This theory allows to use the Free Gibbs Energy to calculate the probability of transition for a chemical reaction characterized by its rate of reaction proportional to the energy height of the transition state between the initial state and the intermediate state named  $\Delta G^\ddagger$  or  $E_a$ . Similarly to this physical law, electronic reliability prediction presented in paper [1] will postulate that the initial state of the component is corresponding to healthy devices considered electrically "good" within its specification limits and the final state of the component corresponds to out of specification limit devices then considered as failed.

This theory allows determining the time to failure (TTF) of a component based on the activation energy  $E_a$  expressed in eV and the temperature  $T$  expressed in Kelvin according Arrhenius law:

$$TTF = A \cdot \exp(E_a/kT) \quad (1)$$

where  $A$  is a frequency factor and  $k$  is the Boltzmann's constant.

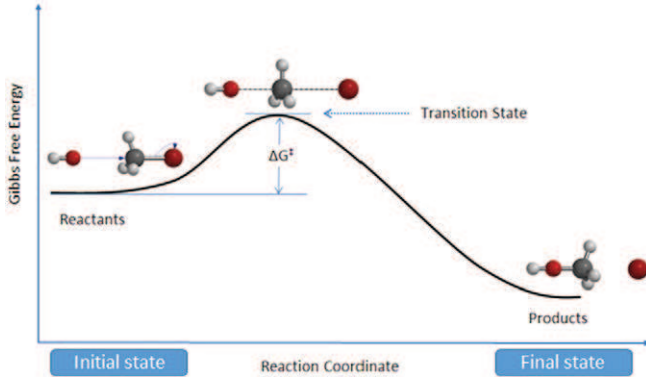

Fig. 1. Transition state theory principle.

From this theory, an extensive mathematical model was constructed whereas the energy provided by external stresses  $\gamma \cdot S$  acting on the components (e.g., electrical transient, overvoltage, natural radiations) decreases the activation energy necessary for a state change and therefore acts as a catalyst, accelerating the degradation process. As illustrated by Fig. 2, the new activation energy equals:

$$U_0 = E_a - \gamma \cdot S. \quad (2)$$

Applying Eq. (2) to Eq. (1), time to failure becomes:

$$TTF = A \cdot \exp(E_a - \gamma \cdot S/kT). \quad (3)$$

This model is known in literature as Boltzmann–Arrhenius–Zhurkov (BAZ) model [2,3].

Therefore, it becomes necessary to characterize  $E_a$  and  $\gamma \cdot S$  for each functional and physical parameter (e.g., value of leakage current) representative of the initial state of the component. As these settings are multiple and the stresses are combined, the development of a plan of experience becomes essential. A theoretical identification of the parameters affecting the robustness of the component must be realized first. Experience plan will promote environmental stress and the operating conditions to be applied to reveal this influence: High Temperature Operating Life (HTOL), Low Temperature Operating Life (LTOL), thermal shock, Electrical Over Stress, short circuit, Avalanche Breakdown....

To characterize  $E_a$  and  $\gamma \cdot S$ , DC/AC electrical parameters will be determined from MIL standard measurements in a temperature range of  $-55$  to  $+200$  °C. It is therefore necessary also to characterize the junction temperatures and hot points by infra-red or electrical method. The accelerated aging, representative of equipment mission profile, will provide time to failure TTF.

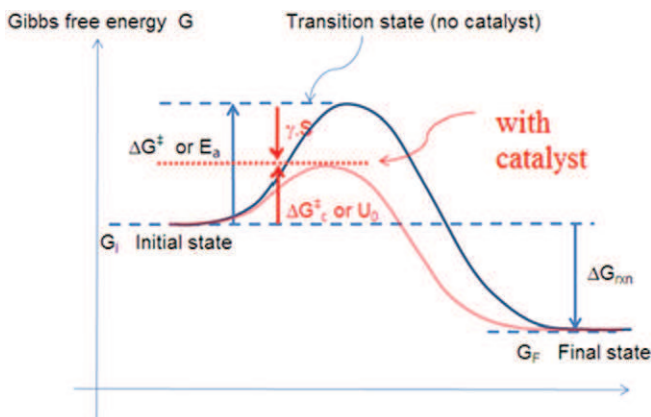

Fig. 2. Transition state theory considering a catalyst.

Finally, a failure analysis by appropriate techniques (electron microscopy, X-ray tomography, optical microscopy to light emission) will establish precisely the component wear out.

The reliability model of COTS components will be consolidated taking into account electrical and thermal operating conditions and the specific mission profile of final application. The project will establish a FIDES compatible guide to design COTS-based systems.

### 3. Characterization/modeling of immunity to natural radiations

Wide bandgap semiconductor presents a significant technological breakthrough compared to silicon semiconductor. Main benefits of these materials are higher junction temperature, higher critical electrical field allowing higher breakdown voltages, lower thermal resistivity, excellent reverse recovery inducing lower switching losses and allowing higher switching frequencies. GaN transistors foreseen in high power switching application (DC-DC converters, boosters, ...) shows better performance than Si or SiC transistors in terms of ratio "On resistance value/voltage breakdown", which is the most important figure of merit for a power switch. Fig. 3 illustrates the efficiency ratio comparison between Si and GaN for power switching.

This WP aims to characterize the sensitivity to cosmic/atmospheric radiation of GaN Normally OFF commercial technologies used in low frequency switching power conversion. Characterization will be made from the environmental constraints faced by different systems (space, aeronautics and terrestrials). The results of this WP will be used to enrich reliability models developed in WP1.

This WP will first address SEE (Single Event Effects) as SEB (Single Event Burnout). SEGR (Single Event Gate Rupture) are not expected in such devices with pGaN gate since there is no insulating layers which could be the source of failure.

We have proceeded to a detailed physical analysis of manufacturing processes of the GaN normally-off commercial used in power conversion. Considered GaN transistors were EPC 2019 (200 V/10 A) and GaN Systems GS66508P (650 V/19 A). The cross section analysis as shown by Fig. 4 enables to know about transistor's epitaxy.

A fine analysis was made at the level of the active area. This analysis shows that active area (drain to source distance  $\sim 7$   $\mu\text{m}$  for EPC and  $\sim 21$   $\mu\text{m}$  for GaN Systems transistor) is made of a complex multiple set of AlGaIn layers grown on a Si substrate. We have also proceeded to the identification of the constituent materials of the chip as well as analysis of the assembly of the chip into the package.

This construction analysis has been used to build TCAD (Technology Computed Aided Design) transistor model as illustrated by Fig. 5. Measurements of the static electrical characteristics allowed calibrating and validating this TCAD model.

Immunity to natural radiations will be simulated under TCAD (Sentaurus) in a temperature range of  $-55$  to  $+200$  °C to quantify

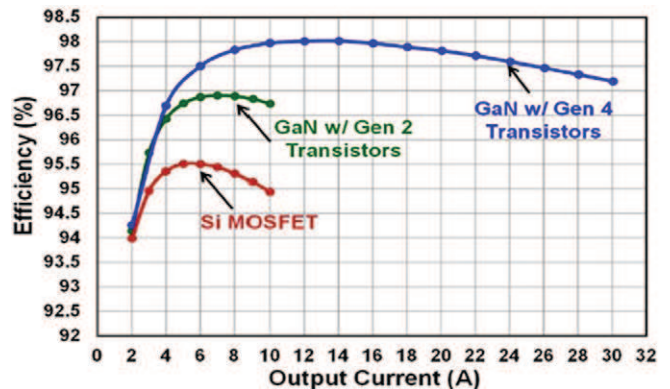

Fig. 3. Power conversion efficiency GaN vs Si.

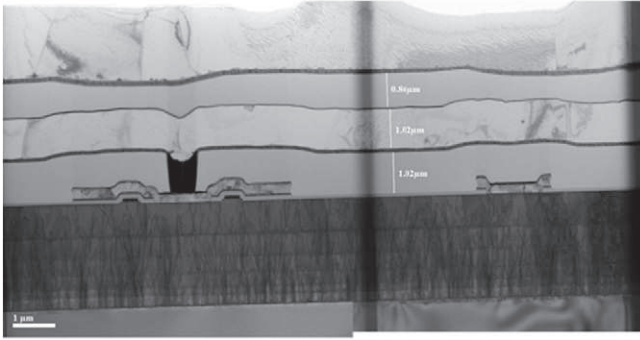

Fig. 4. EPC 2019 GaN transistor cross section.

the fullness of reactions, locate theoretically sensitive areas and to identify trigger mechanisms. Unlike Si MOS transistor, some previous works regarding RF HEMT [4,5,6] suggest that SEEs into AlGaIn/GaN HEMTs are mainly due to displacement damage more than to ionization effects. However, today's TCAD radiation models cannot take into account displacement damage, which would be the reason why TCAD tools are not yet well-suited to these new technologies and finally the study may become unsuccessful.

Fig. 6 shows the very first results obtained after a simulation of heavy ion impact. For the same LET (Linear Transfer Energy) of 1 pC/μm but two different drain to source voltages  $V_{DS}$ , we reproduce two levels of transients, one at  $V_{DS} = 200$  V with  $I_{DSmax} > 3$  A (red curve) the other at  $V_{DS} = 50$  V with  $I_{DSmax} = 1.2$  A.

Fig. 7 shows the evolution of electron density along the time. At  $t_0$ , an ElectroMagnetic field is created between the impacts by ionization points. At  $t_1$ , we observe the beginning of avalanche phenomena. At  $t_2$ , we observe holes injection near the drain. At  $t_3$ , we may observe the SEB.

An analysis of sensitivity under laser beam will be therefore implemented to assess areas of sensitivity and modes of failure prior to the irradiation under beams of particles (neutrons, protons and heavy ions).

Knowledge of the natural radiation environment for different applications (automotive, aeronautical and space) will then assess the Failure in Time (FIT) for a given application. Electrical characterization after campaigns under beams will allow the correlation of the measure with the modeling developed in the WP1. This WP will lead to enrich the predictive reliability model defined in WP1, determining the  $\gamma \cdot S$  linked to natural radiations.

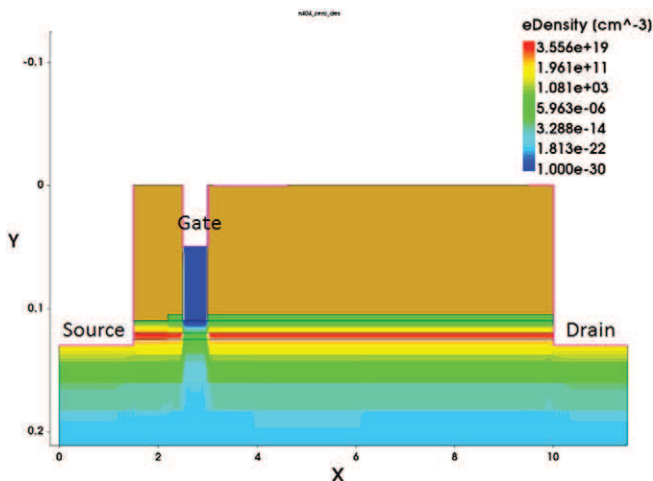

Fig. 5. EPC 2019 GaN transistor TCAD model.

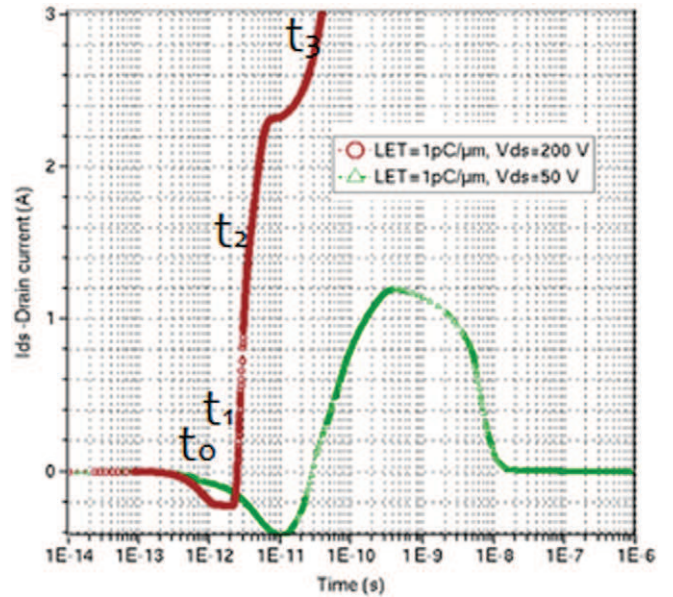

Fig. 6. Simulated transients events after heavy ion impact on EPC 2019 GaN transistor.

#### 4. Characterization/modeling of EMC behavior (emission, immunity, signal integrity) and immunity to transients

One of the embedded electronic industrial problems is to predict the risk of failures and non-compliance EMC of their equipment along their lifetime. This WP aims therefore to extend the current EMC IEC 62433 standards for Integrated Circuits to include the effects of aging and predict average derivatives and the dispersal of their emission and immunity levels. Then, it comes to demonstrate that these models allow prediction of the risk of non-compliance at the level of an electronic board.

This WP will address proven technologies for functions commonly used in aeronautical or automotive ECUs. As illustrated by Fig. 8, an application demonstrator called ELECIS (Electronic board for Long term Electromagnetic Compatibility Issues Simulation) has been designed around a FPGA addressing different types of memory (flash, MRAM, DDR3), communicating thru an external ETHERNET bus and supporting analog functions as Analog to Digital Converter (ADC), reference voltage and supplied by linear and switched power supplies.

Table 1 gives the list of components which will be modeled. Transient Voltage Suppressor (TVS) as well as passive elements will be also modeled.

For each component, we will choose the EMC (emission and immunity) and transient immunity measurement method adapted to extract the component model. A complete ELECIS demonstrator model will be established in white box by the association of different active, passive components models as well as the PCB tracks. EMC (emission and immunity) and transient's immunity normative set-up models will be established which will require the creation of cable, antennas, injection probe pulse generator, and ESD gun models. Fig. 9 shows an example of BCI (Bulk Current Injection) set-up modeling as presented in the paper [7]. This modeling allows to calculate the equivalent DPI (Direct Power Injection) level obtain at component level during a BCI test.

EMC measurement according CISPR25, DO160 or ISO standard will be performed on the application demonstrator ELECIS in order to correlate the model to the measure.

The same measurements and modeling will be conducted on aged demonstrators. The aging of components and the demonstrator will

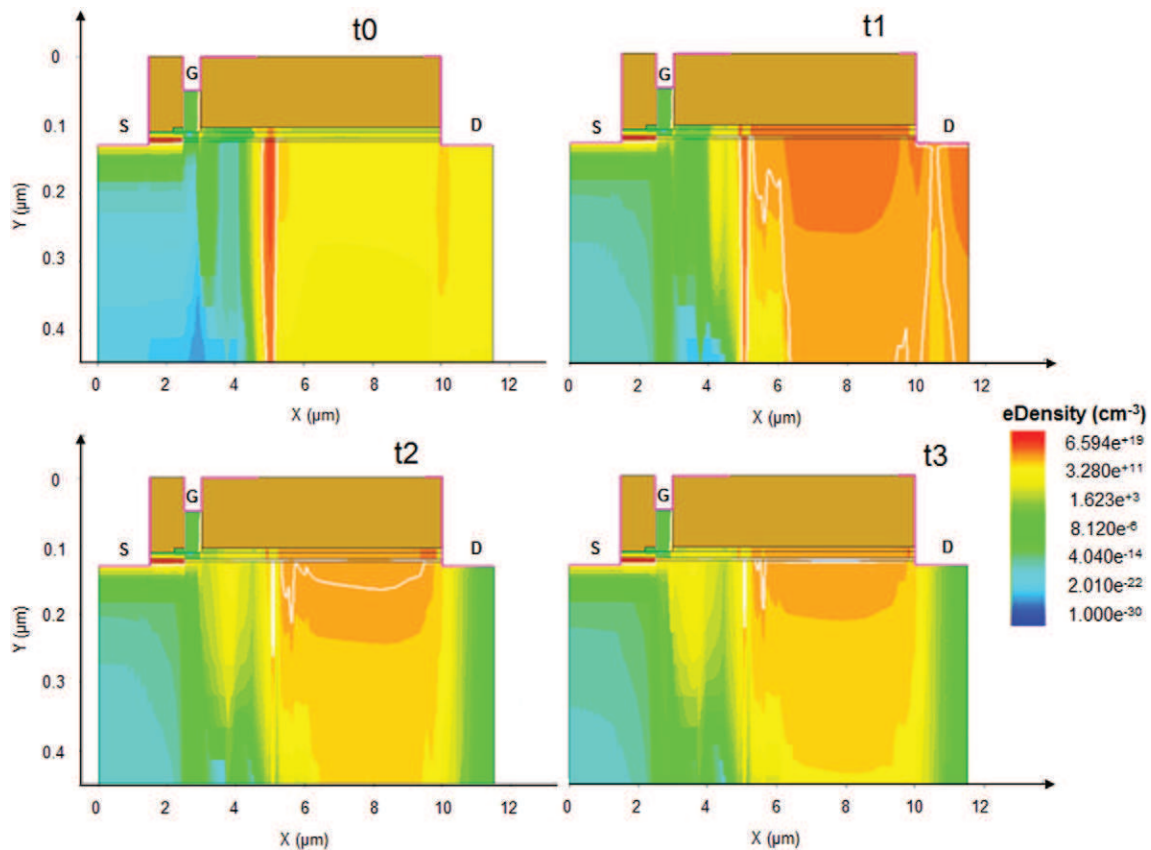

Fig. 7. E-density observed during a simulated Single Event after heavy ion impact on EPC 2019 GaN transistor.

be depending on the environment of the application. At the level of the component model, the goal is to affect a dependent parameter of time and equipment mission profiles. This will be the subject of a proposal for the evolution of standards in the IEC models ICEM (Integrated Circuit Emission Model), ICIM (Integrated Circuit Immunity Model) and IBIS (Input output Buffer Specifications) extended to aging consideration.

### 5. Characterization/modeling of package on substrate mechanical assembly

To ensure the required reliability level of their electronic equipment, manufacturers perform environmental tests. These tests validate the assembly of soldered components on substrate. The stresses damaging soldered joints can be classified into 5 types: thermal cycles, thermal

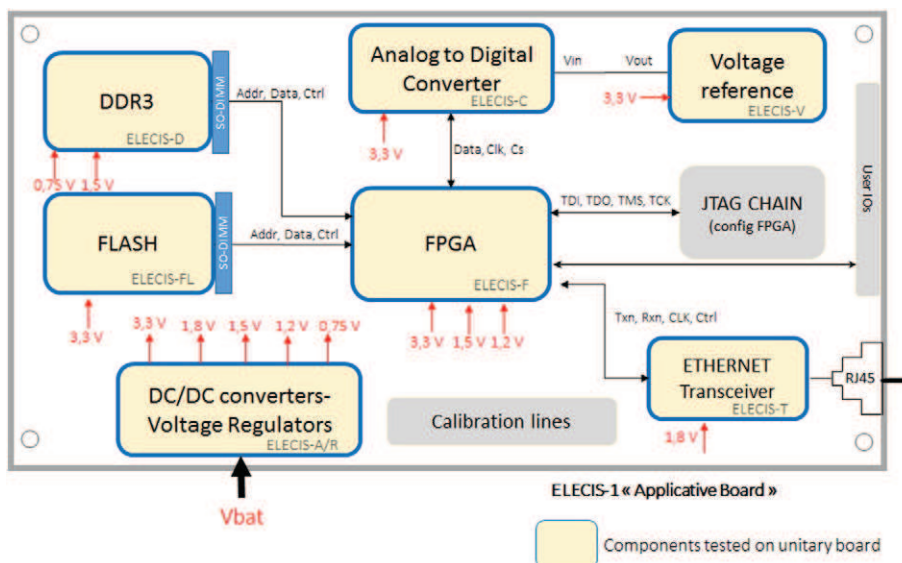
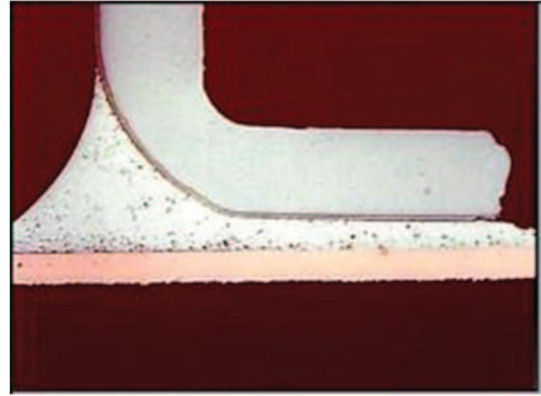

Fig. 8. ELECIS application demonstrator.

**Table 1**  
List of targeted components.

Board	Component
ELECIS-F	FPGA Xilinx Spartan 6 XC6SLX16-2FTG256I
ELECIS-FL	FLASH Spansion S34ML01G2
ELECIS-D	DDR3 Micron Technology MT41J256M16HA-125IT
ELECIS-M	MRAM Everspin Technologies MR4A08BCYS35
ELECIS-T	Ethernet Micrel KSZ9021RNI Transceiver
ELECIS-C	AD Converter Analog Device AD7476
ELECIS-V	Voltage Reference Linear Technology LTC1798
ELECIS-A	DC/DC converter Linear Technology LT3800
ELECIS-R	Voltage Regulator Texas Instruments TPS70348
ELECIS-TR	Buffer Texas Instruments 74FCT162543CTPACT



**Fig. 10.** Example of soldered joint geometry.

shock, swept sine vibration, random vibration and mechanical shock. The first two types are related to thermomechanical fatigue damage, the next two at a pure mechanical damage, and the last one to an extreme response in the fast dynamic type mechanics. As a result of these tests, a failure analysis allows observing if cracks appeared, or are propagated. A quantification of the duration of life of electronic equipment is then possible.

Thermo-mechanical simulations are widely used in the field of microelectronics to predict the robustness of the assemblies. Today, the knowledge to simulate the responses of an assembly subjected to thermal shocks or thermal cycles or even an assembly subjected to sinusoidal or random vibration responses is widely shared. But, on the other hand, the quantification of the lifetime of equipment subject to these stresses is not yet possible.

Furthermore, during the manufacturing process, the quality of the soldered joints can fluctuate. IPCA610 defines certain rules to accept or reject the imperfections. However, it is not possible to quantify the influence of imperfections on the assembly lifetime during thermo-mechanical stresses. The objective of this work is therefore to determine the influence of soldered joints geometry illustrated by Fig. 10 (form and imperfection) on the reliability of microelectronic assemblies.

The joint use of simulations and a degradation law allows studying the influence of the dispersion of a technological parameter on the distribution of the service life of an assembly [8]. The value of calculable parameters, such as the accumulated maximum deformation and the maximum stress or strain energy, is directly related to the dimensions and the geometry of the structure and also on material characteristics and the simulated load conditions. These parameters can themselves be dependent on fluctuations in the manufacturing process and of changes in the conditions of the environment of Assembly (mission profile). Therefore, they must be considered as random variables as soon as we want to evaluate the distribution of the life of the Assembly. To consider the influence of the variation of one of these measurable parameters on the distribution of the lifetime of the connection, we can start by studying its influence on the variation of one of the parameters calculated by finite elements.

Studied assemblies, provided by Continental Automotive France, behave 0.5 mm pitch BGA and QFN Packages. They must be characterized

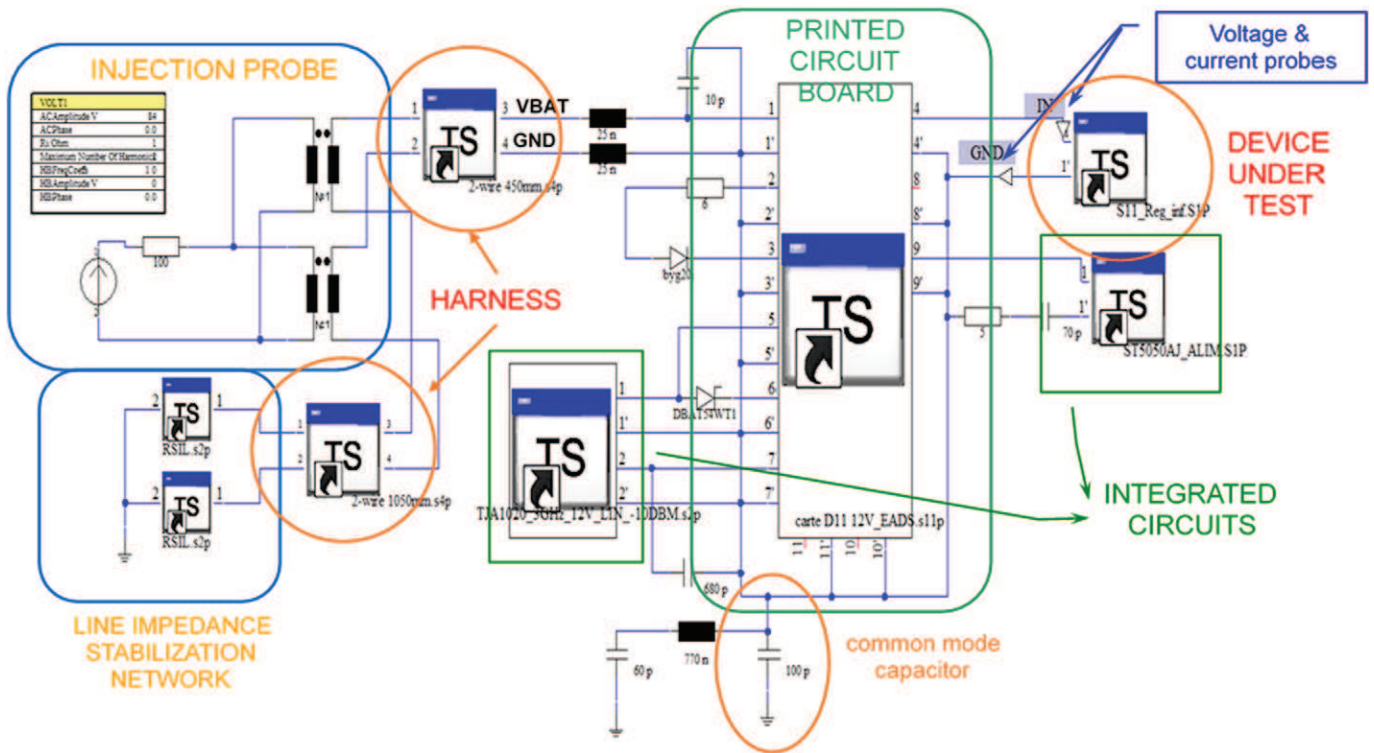

**Fig. 9.** Example of BCI set-up modeling.

after the manufacturing phase to determine the most fluctuating geometric parameters: heights of joints, the presence and size of voids, etc. From these measurements on real soldered joints, e.g., by 3D Rx measuring, relevant parameters must be identified, and then their dispersion modeled. A set of numerical simulations by finite element will be undertaken to assess the impact of dispersal on the thermomechanical constraints of Assembly.

The final objective would be to identify a measurable parameter representative of aging, and then connect it to a calculable setting in order to predict lifetimes and their dispersion under operational conditions.

## 6. Conclusion

The project is still ongoing and the first results are expected in December 2015. First WP3 demonstrators are expected in June 2015. WP1 GaN based demonstrators allowing robust measurements for a statistical approach are still under development and are expected in July 2015.

## Acknowledgments

This project is sponsored by Airbus Operations, Airbus Group Innovations, Continental Automotive France, Hirex Engineering, Labinal Power Systems, Nexio, Thales Alenia Space France, Thales Avionics and French National Agency for Research (ANR). The authors thank Serma Technologies for GaN transistor construction analyses.

## References

- [1] A. Bensoussan, E. Suhir, P. Henderson, M. Zahir, A unified multiple stress reliability model for microelectronic devices — application to 1.55  $\mu\text{m}$  DFB laser diode module for space validation, ESREF, October 5th–9th, 2015, Toulouse, France. 2015.
- [2] E. Suhir, Predicted reliability of aerospace electronics: application of two advanced probabilistic concepts March 2–9 IEEE Aerospace Conference, Big Sky, Montana, 2013 Paper 2037.
- [3] A. Bensoussan, E. Suhir, “Design-for-reliability (DfR) of Aerospace Electronics: attributes and challenges”, 2013 IEEE Aerospace Conference, March 2–9, 2013, Big Sky, Montana, Paper 2057, 2013.
- [4] O. Aktas, A. Kuliev, V. Kumar, R. Schwindt, S. Toshkov, D. Costescu, J. Stubbins, I. Adesida, Co-60 gamma radiation effects on DC, RF, and pulsed I-V characteristics of AlGaIn/GaN HEMTs, Solid State Electron. 48 (3) (2004) 471–475.
- [5] S.A. Vitusevich, N. Klein, A.E. Belyaev, S.V. Danylyuk, M.V. Petrychuk, R.V. Konakova, A.M. Kurakin, A.E. Rengevich, A.Y. Avksentyev, B.A. Danilchenko, V. Tilak, J. Smart, A. Vertiatkikh, L.F. Eastman, Effects of  $\gamma$ -irradiation on AlGaIn/GaN-based HEMTs, Phys. Status Solidi A 195 (1) (Jan. 2003) 101–105.
- [6] X. Hu, B.K. Choi, H.J. Barnaby, D.M. Fleetwood, R.D. Schrimpf, S.C. Lee, S. Shojah-Ardalan, R. Wilkins, U.K. Mishra, R. Dettmer, The energy dependence of proton-induced degradation in AlGaIn/GaN high electron mobility transistors, IEEE Trans. Nucl. Sci. 51 (2) (April 2004) 293–297.
- [7] A. Durier, C. Marot, O. Alilou, Using the EM simulation tools to predict EMC immunity behaviour of a automotive electronic board after a component change EMC Europe International Symposia and Workshops on Electromagnetic Compatibility 2013, Brugge, Belgium, 2013.
- [8] J.Y. Delétage, Study of microelectronic assemblies lifetime by the use of simulations, degradation models and test specific integrated circuits, 1, University of Bordeaux, 2003 (PhD thesis).