

# Uncoordinated vs Coordinated Charging of Electric Vehicles in Distribution Systems Performance

**Ahmed R. Abul'Wafa**

Electrical Power & Machines department  
Faculty of Engineering, Ain Shams University  
Cairo, Egypt

**Aboul'Fotouh El'Garably**

Electrical Power & Machines department  
The High Institute of Engineering at El-Shorouk City  
Cairo, Egypt

**Wael A.Fatah Mohamed**

Electrical Power & Machines department  
The High Institute of Engineering at El-Shorouk City  
Cairo, Egypt  
w.abdelfattah@sha.edu.eg

**Abstract**—Now a days, Electric Vehicle (EV) integration to the distribution system is gradually increasing and is hitting with much power quality issues. This paper investigates the impacts of EVs integration into the distribution systems and highlights possible detrimental operational performance such as feeders and transformers overloading, lower voltage profiles, higher system losses and operational cost. EV integration is realized with two charging schemes; coordinated and uncoordinated for two EV penetration levels; 30% and 100%. A benchmark (RBTS) test system, and a real distribution network in Egypt (ShC-D8) are modeled. Each test system includes its own daily load and cost variations model. Simulations are performed to investigate the influence of EVs penetration and coordination on voltage profile, feeders and transformers loading, system losses, operational cost, voltage profile, and the daily load curves. Simulation results show that: the EVs penetration levels have a major effects on system performance, uncoordinated charging result in a negative impacts on system performance, and coordinate charging mitigate that negative impacts.

**Keywords**—Electric Vehicles (EVs); coordinated and uncoordinated charging, operation cost; charging cost; voltage profile; system losses; daily load curve and cost variations.

## 1. INTRODUCTION

Due to depleting of natural oil and fossil fuel reserves, and in an effort to overcome the problems of rising petrol costs and pollution, the Electric vehicles (EVs) are growing in popularity in developing nations.

EVs charging will add extra load on distribution systems, which were not designed originally to accommodate EVs. The current distribution systems can withstand low penetrations of EVs. However, the penetration levels are expected to rise rapidly in the next few years due to price drop, availability of charging stations, and wide range manufacturing. This extra load will cause severe impacts if not managed properly. These impacts include thermal limits violation due to feeders and transformer overloading, voltage profile degradation, higher system losses and operational cost [1]. Therefore, the distribution system operators have to control EVs load by deploying smart EVs coordination structure in order to rely on the infrastructure of the future smart grids otherwise, the system feeders and equipment must be upgraded to withstand this extra uncontrolled loads. Most of the researchers agree this solution which has more beneficial for the utility and customers [2], and that is the main focus of the presented work in this paper.

Therefore, the aim of this paper is to propose a methodology to coordinate charging of EVs in distribution networks. The proposed methodology can efficiently mitigate the impacts of EVs uncontrolled charging. This will lead to improvement in system performance high penetration of EVs.

Previous work in this area presents different techniques to deal with coordinated EVs charging. In [3], a real time coordinated EVs charging method is presented taking into consideration the EV owner preferred charging time and pricing zone. Also a real-time coordinated is given in [4] based on moving time window, and also given in [5]. The impacts of different EV battery charging profiles on the performance of smart grid distribution systems are studies in [6] and the impacts of EVs on voltage profile and losses of residential system in [7]. Also, a coordinated charging is proposed in [8] to minimize distribution system losses, and in [9] to minimize the power losses and to maximize the main grid load factor.

This paper investigates the impact of EV integration into a distribution system and highlights possible detrimental operational performance such as feeders and transformers overloading, lower voltage profiles and higher system losses and operational cost. A standard and a real distribution test systems will be modeled and analyzed without and with EV integration. Two EV penetration levels (30% and 100%), and two charging schemes (uncoordinated and coordinated) will be considered. Simulation results will be used to highlight the impacts of EV penetration and coordination on system losses, cost, voltage profile and the feeder daily load curve.

## 2. PROPOSED UNCOORDINATED AND COORDINATED CHARGING

Charging profile of EVs has major effects on the distribution systems. There are a different charging strategies for which manage the time and frequency of EVs charge as un-controlled/un-coordinated, controlled/coordinated, delayed, and off-peak charging [10]. In this paper, the distribution systems under study will be simulated and examined with two EV charging schemes:

- Uncoordinated charging
- Coordinated charging

### 2.1 Uncoordinated (uncontrolled) Charging

In the uncoordinated charging scheme, the batteries of the EVs either start charging immediately when arrived at home and plugged in (usually during peak hours), or after a user-adjustable fixed start delay. Most of EVs arrive at home at the same period of peak demand see Fig. 5. So if the EVs charged when arrived, that charging could create a large load coincident with the peak, and hence over loading problem occurs for system transformers and cables... etc. Fig. 1 show the uncoordinated charging EVs corresponding to their home arrival time as a p.u of total number of customers. Negative impacts appear with uncoordinated charging such as over loading, more losses, more voltage deviation, and more cost, etc.

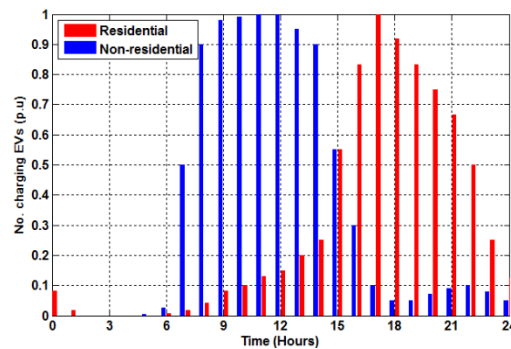

Fig. 1. Uncoordinated charging

### 2.2 Coordinated (controlled) Charging

EVs integration into distribution system can be improved when EVs charging at off-peak period this called coordinated charging; as shown in Fig. 2, Fig. 3, and Fig. 4 for residential, of non-residential, and Egyptian load type respectively. In present case coordinated charging has been considered based on the calculation of spare capacity available in the distribution transformer. By central aggregator control that send a signals to the connected EVs to start or stop charging, coordinated charging can be achieved.

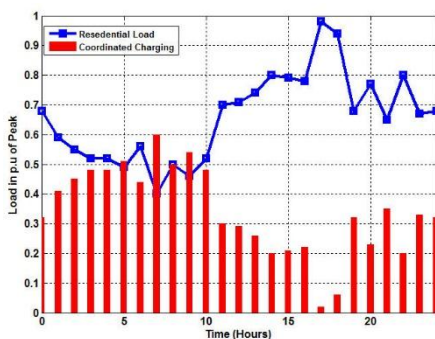

Fig. 2. Coordinated charging of residential load type

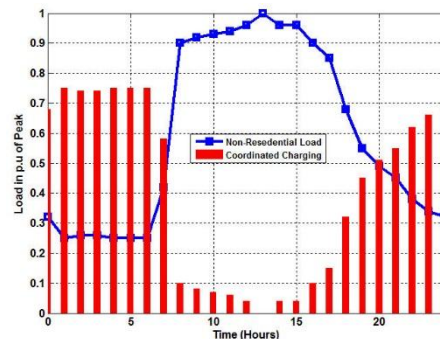

Fig. 3. Coordinated charging of non-residential load type

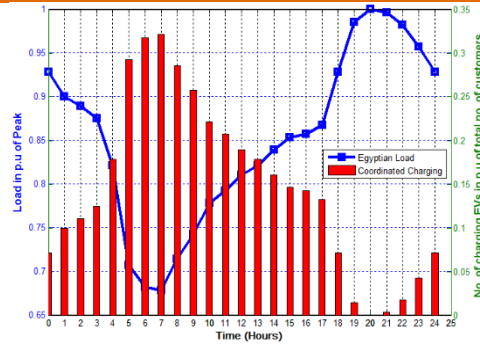

Fig. 4. Coordinated charging corresponding to Egyptian load type

### 3. CASE STUDY AND DATA SELECTION

#### 3.1 Electric Vehicles data

*EV Type:* For the purpose of simplification, here only battery electric vehicle (BEV) is assumed for all of vehicles. In this case the battery size is **28.8 kWh**. The energy consumption by an EV depends on the driving cycle. The starts and stops and also on the ups and downs in the road. However this kind of data will vary due to various reasons like geography, traffic rules etc. In this case an average value of energy consumption is considered as **0.231 kWh/km**.

*EV Charging:* In this study, charging types considered as slow and fast charging. Slow charging take about 8 hours at power **3.7 kW**, while fast charging approximately draw **9 kW** for 3 hours.

*EVs number:* The number of vehicles that are considered in the test system depends on what scenario is being studied. There can be many cases ranging from 10% penetration to a 100% penetration of EVs. This paper consider two cases. First case, 30% penetration of EVs; This means that 30% of the total consumers use an electric vehicle. Second case, 100 % penetration of EVs; This means that 100% of the total consumers use an electric vehicle.

*Driving habits:* The driving habits of the customers very important in thesis study, as the following assumptions are:

- The residential customers travel to the commercial complexes and the government/institutions area.
- During night all electric vehicles in the residential complex are connected to the distribution system.
- During the day all vehicles travel to the commercial complexes where they are connected to the plug in points available.

The percentage of vehicles arriving home in a day is given in Fig. 5 which shows the distribution of home arrival times [11].

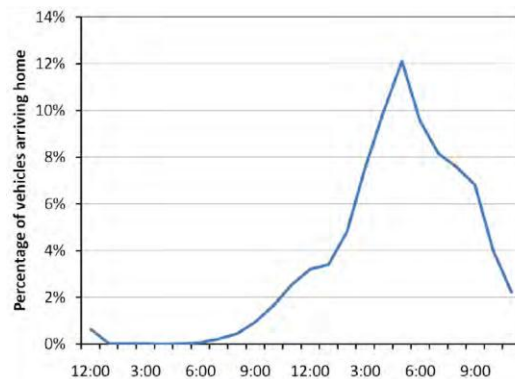

Fig. 5. Home arrival time distribution [11]

#### 3.2 Load Profiles and Cost data

For all kind of customers, here two major classifications have been made for deciding the load curve, residential and non-residential (government/institutions and commercial) customers. Fig. 6 shows the daily load curve for residential and non-residential customers [12]. For real system in Egypt, Egyptian daily load is considered [13] which given in Fig. 7 to achieve more realistic results for this system.

The cost of electricity also varies over time during a day and is also dependent on the season. To study economic benefit of EV penetration in distribution system, time varying cost data has been assumed. This data has been extracted ONLINE from Nord Pool website [14] and gives the variation of cost over one particular day as shown in Fig. 8. The energy cost can be calculated by the cumulative multiplication of the cost variation (in Fig. 8) and energy variation curve corresponding to the calculated cost required (such as operation, and charging energy curves).

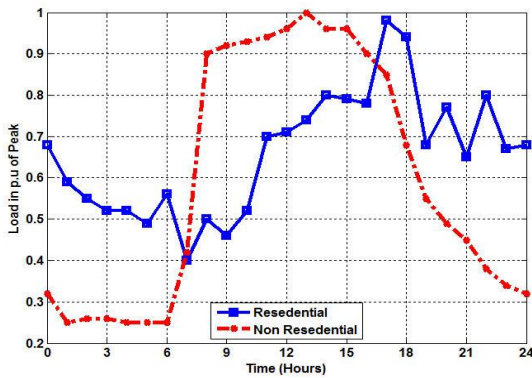

Fig. 6. Daily load curves [12]

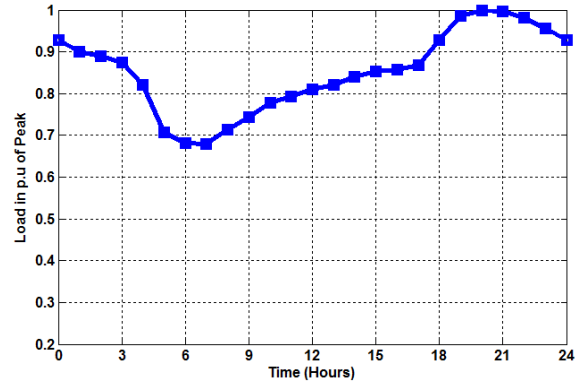

Fig. 7. Egyptian daily load curve [13]

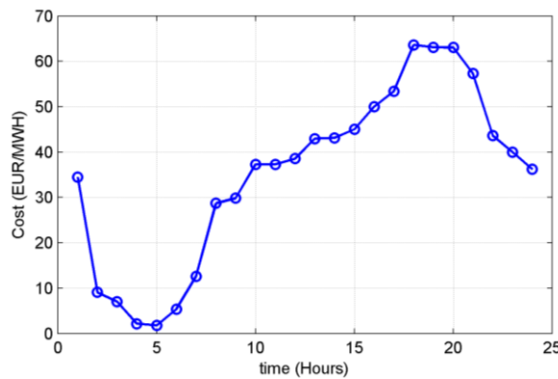

Fig. 8. Hourly cost data for (Average of cost at 4-8/6/2017) [14]

### 3.3 Data of distribution Systems under Study

To analyze the integration impacts of EV charging on the distribution systems performance, two distribution networks (RBTS-bus2 and ShC-D8) are considered and modified to include different levels of EV penetration. First network is the benchmark RBTS-bus2 test system, the distribution system is shown in Fig. 9 and further details of the test system are presented in [15].

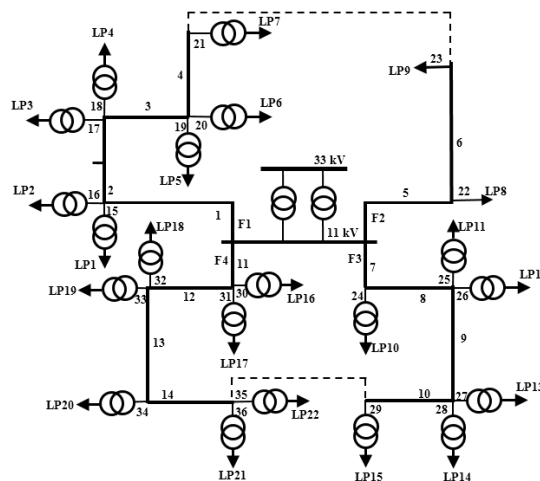

Fig. 9. RBTS Bus 2 Distribution Test System [15]

**Table 1:** Line and load parameters of the ShC-D8 real system

Feeder No.	Line Data				Transformer				Peak Load LP kW	Customers No. N
	Line No.	from Bus	to Bus	length m	TP No.	rating kVA	Customer Type	Area		
Feeder 1	1	MD	T1	480	T1	500	Residential	R1	308.4	120
	2	T1	T2	185	T2	500	Residential	R1	359.8	140
	3	T2	T3	70	T3	500	Residential	R1	359.8	140
	4	T3	T4	100	T4	500	Residential	R1	334.1	130
	5	T4	T5	240	T5	500	Residential	R1	334.1	130
	6	T5	T6	460	T6	500	Residential	R2	308.4	120
	7	T6	T7	100	T7	500	Residential	R2	257	100
	8	T7	T8	150	T8	500	Residential	R2	334.1	130
	9	T8	T9	150	T9	500	Residential	R2	308.4	120
	10	T9	T10	250	T10	500	Gov./Inst.	C1	205.6	80
	11	T10	T11	50	T11	500	Gov./Inst.	C1	257	100
	12	T11	T12	105	T12	500	Commercial	C1	308.4	120
	13	T12	T13	130	T13	500	Commercial	C1	205.6	80
	14	T13	T14	110	T14	500	Commercial	C1	205.6	80
	15	T14	T15	110	T15	500	Gov./Inst.	C2	308.4	120
	16	T15	T16	115	T16	500	Gov./Inst.	C2	231.3	90
	17	T16	T17	150	T17	500	Gov./Inst.	C2	205.6	80
	18	T17	MD	565						
Feeder 2	1	MD	T18	25	T18	500	Commercial	C3	257	100
	2	T18	T19	350	T19	500	Commercial	C3	282.7	110
	3	T19	T20	195	T20	500	Commercial	C3	308.4	120
	4	T20	T21	200	T21	500	Residential	R3	334.1	130
	5	T21	T22	200	T22	500	Residential	R3	257	100
	6	T22	T23	125	T23	500	Residential	R3	282.7	110
	7	T23	T24	105	T24	500	Residential	R3	257	100
	8	T24	T25	460	T25	500	Residential	R4	334.1	130
	9	T25	T26	125	T26	500	Residential	R4	257	100
	10	T26	T27	175	T27	500	Residential	R4	308.4	120
	11	T27	T28	250	T28	500	Residential	R4	308.4	120
	12	T28	T29	100	T29	500	Gov./Inst.	C4	308.4	120
	13	T29	T30	80	T30	500	Gov./Inst.	C4	334.1	130
	14	T30	T31	170	T31	500	Gov./Inst.	C4	308.4	120
	15	T31	T32	250	T32	500	Gov./Inst.	C4	308.4	120
	16	T32	MD	270						
Feeder 3	1	MD	T33	380	T33	500	Commercial	C6	308.4	120
	2	T33	T34	400	T34	500	Commercial	C6	308.4	120
	3	T34	T35	400	T35	500	Gov./Inst.	C5	308.4	120
	4	T35	T36	280	T36	500	Gov./Inst.	C5	334.1	130
	5	T36	T37	160	T37	500	Gov./Inst.	C5	308.4	120
	6	T37	T38	200	T38	500	Residential	R5	308.4	120
	7	T38	T39	200	T39	500	Residential	R5	334.1	130
	8	T39	T40	400	T40	500	Residential	R5	308.4	120
	9	T40	T41	200	T41	500	Commercial	C6	205.6	80
	10	T41	T42	200	T42	500	Residential	R6	334.1	130
	11	T42	T43	200	T43	500	Residential	R6	308.4	120
	12	T43	T44	450	T44	500	Residential	R6	308.4	120
	13	T44	T45	250	T45	500	Residential	R6	308.4	120
	14	T45	MD	320						

To study the impact of EVs integration on distribution system in Egypt, the distribution system in a district #8 of Shorouk City (ShC-D8) is selected for investigation. ShC distribution network is supplied by Four 66/22 kV, 25 MVA transformers substation.

Further distribution of the supply is done from the 22 kV switchgear. The distribution system has both high voltage and low voltage customers via 17 distributor. The distributor (MDE3) located at District#8 is the subject of this study as a second test system. ShC-D8 shown in Fig. 10. Table 1 present the line and load parameters of the ShC-D8 system. There are 45 load points supplying various kinds of customers. The 0.4 kV low voltage customers are supplied via a 45 transformer point each of 22/0.415 kV, 500kVA transformers and the 22 kV customers are supplied directly. All feeders conductors are 3\*240 mm<sup>2</sup> AL, XLPE cables.

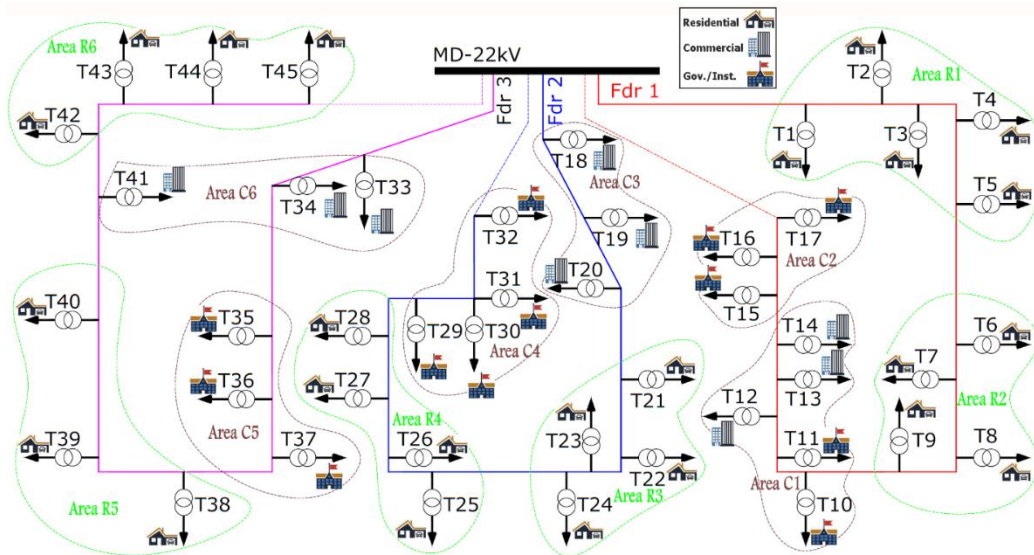

Fig. 10. ShC-D8 Distribution Test System

The two distribution systems is simulated using the **DigSILENT PowerFactory** software. In order to cover a wide range of possible scenarios, two different EV penetration levels (30% and 100%) are considered in both uncoordinated and coordinated integration of EVs.

#### 4. SIMULATION RESULTS

In order to investigate the impact of uncoordinated and coordinated EV charging on the operational performance of the grid as feeders and transformers loading, voltage profile, operation cost and losses. The proposed coordinated charging strategy is implemented to RBTS-bus2 and ShC-D8 distribution test systems using *DigSILENT PowerFactory* software. The integration results is summarized in next figures and tables.

##### 4.1 RBTS-Bus2 test system

###### 4.1.1 Case 1: Uncoordinated Charging Results

Fig. 11 shows the daily load variation in feeder 1 and its corresponding losses is given in Fig. 12. Fig. 13 and Fig. 14 show the loading of transformer point 1 and 4 respectively. Voltage profile of load point 1 and 4 are shown in Fig. 15 and Fig. 16 respectively. These figures are show clearly the negative impacts of uncoordinated integration of EVs; since more feeder loading, more losses, more loading for transformers, and more voltage deviations.

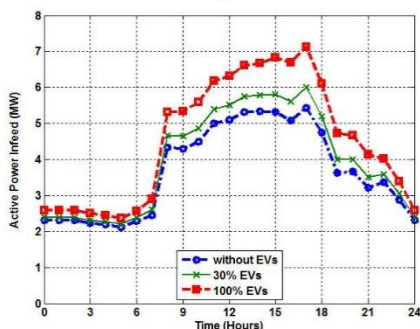

Fig. 11. Load profile of Feeder Fdr1

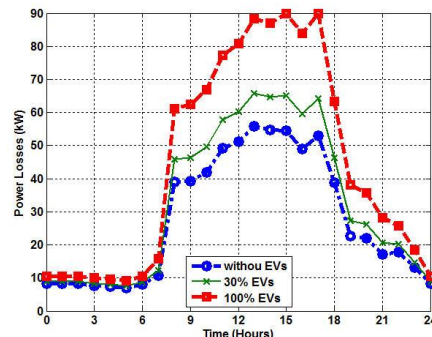

Fig. 12. Power losses of Feeder Fdr1

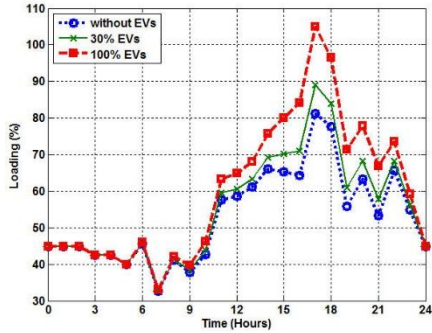

Fig. 13. Load profile of transformer TP1

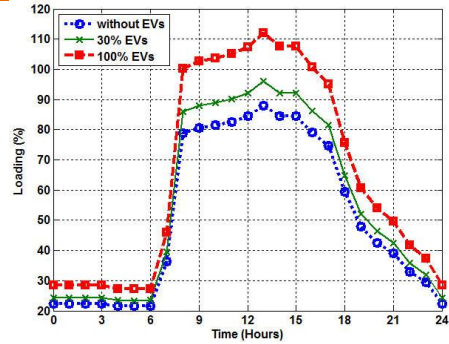

Fig. 14. Load profile of transformer TP4

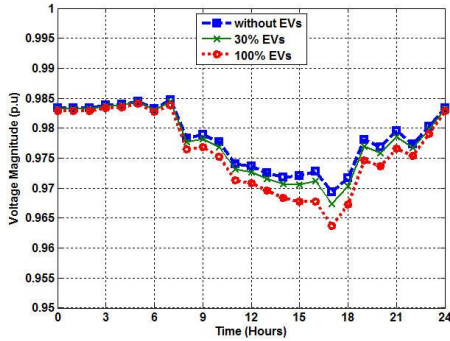

Fig. 15. Voltage profile at LP1

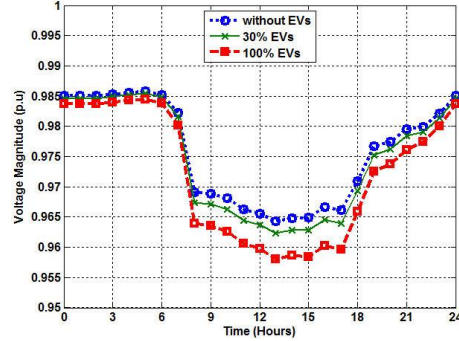

Fig. 16. Voltage profile at LP4

#### 4.1.2 Case 2: Coordinated Charging Results

Fig. 17 shows the daily load variation in feeder 1 and its corresponding losses is given in Fig. 18. Fig. 19 and Fig. 20 show the loading of transformer point 1 and 4 respectively. Voltage profile of load point 1 and 4 are shown in Fig. 21 and Fig. 22 respectively. The results of the coordinated charging summarized shows an improved profile for losses, voltage, feeder and transformer loading.

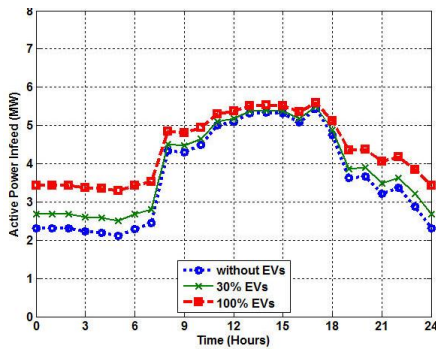

Fig. 17. Load profile of Feeder Fdr1

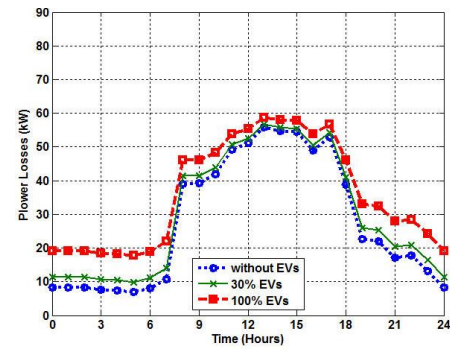

Fig. 18. Power losses of Feeder Fdr1

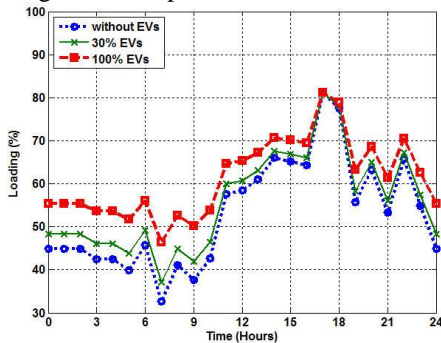

Fig. 19. Load profile of transformer TP1

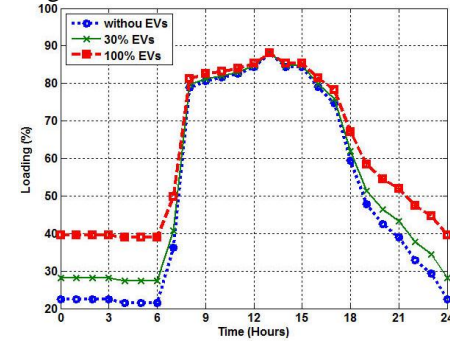

Fig. 20. Load profile of transformer TP4

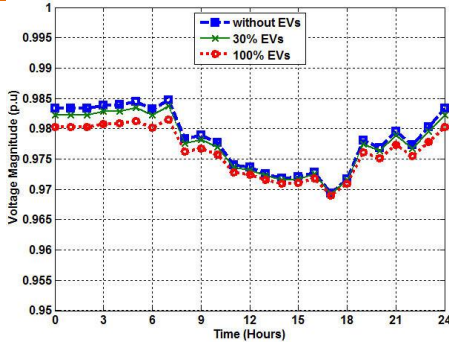

Fig. 21. Voltage profile at LP1

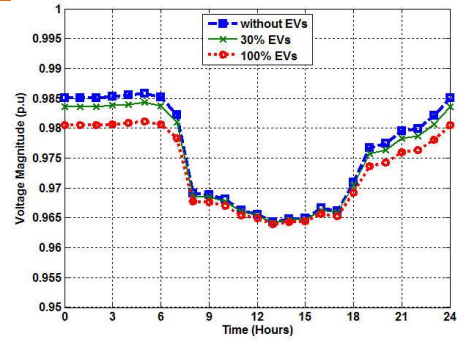

Fig. 22. Voltage profile at LP4

## 4.2 ShC-D8 real test system

### 4.2.1 Case 1: Uncoordinated Charging Results

Fig. 23 shows the daily load variation in feeder 1 and its corresponding losses is given in Fig. 24. Fig. 25 and Fig. 26 show the loading of transformer point 1 and 2 respectively. Voltage profile of load point 17 and 45 are shown in Fig. 27 and Fig. 28 respectively.

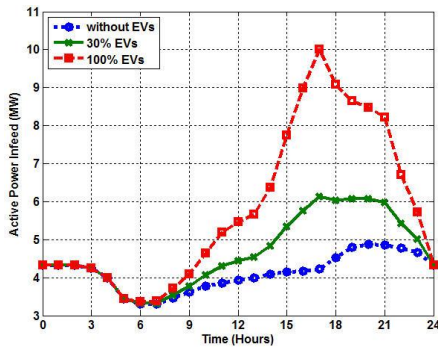

Fig. 23. Load profile of Feeder Fdr1

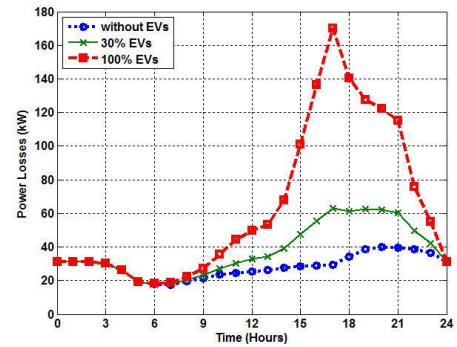

Fig. 24. Power losses of Feeder Fdr1

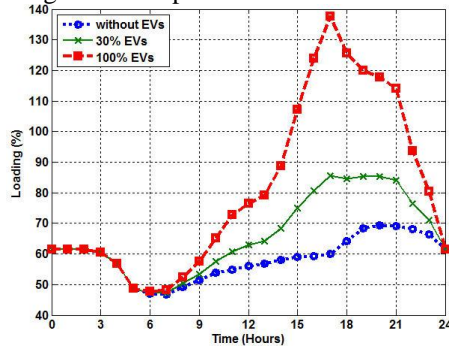

Fig. 25. Load profile of transformer TP1

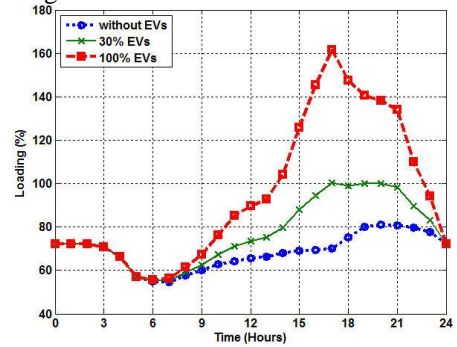

Fig. 26. Load profile of transformer TP2

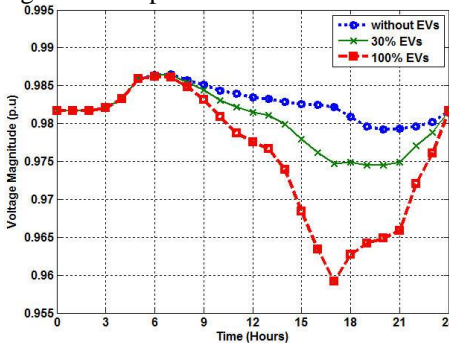

Fig. 27. Voltage profile at LP17

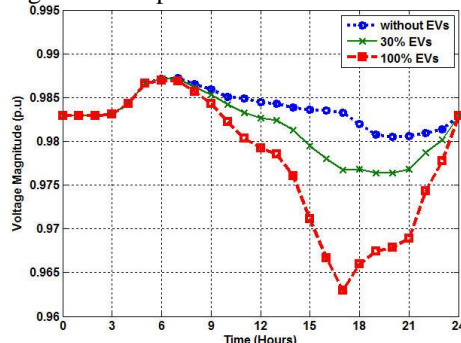

Fig. 28. Voltage profile at LP45



It is clear that there are overload and increase of losses in feeders, and more loading also transformers. Furthermore more voltage drop at bus bars of load points. These negative impacts can improved by using the coordinated integration in next subsection.

4.2.2 Case 2: Coordinated Charging Results

Fig. 29 shows the daily load variation in feeder 1 and its corresponding losses is given in Fig. 30. Fig. 31 and Fig. 32 show the loading of transformer point 30 and 40 respectively. Voltage profile of load point 32 and 45 are shown in Fig. 33 and Fig. 34 respectively.

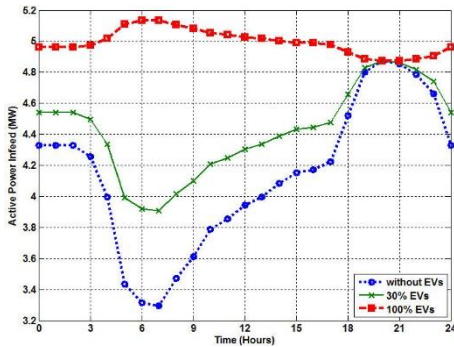

Fig. 29. Load profile of Fdr1

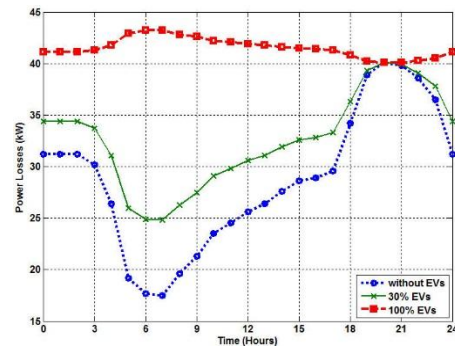

Fig. 30. Power losses of Feeder Fdr1

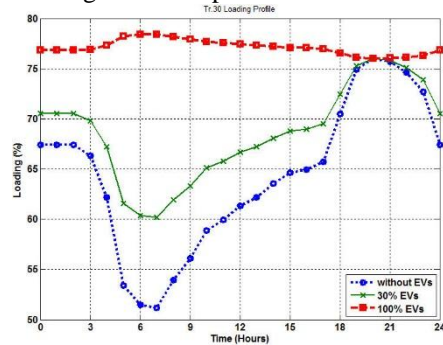

Fig. 31. Load profile of transformer TP30

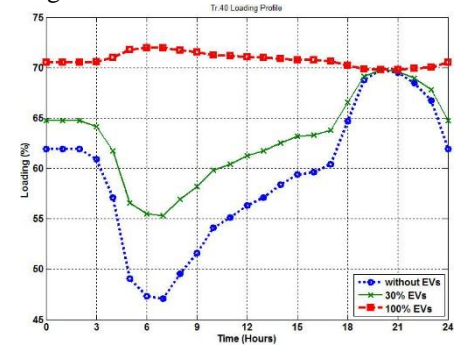

Fig. 32. Load profile of transformer TP40

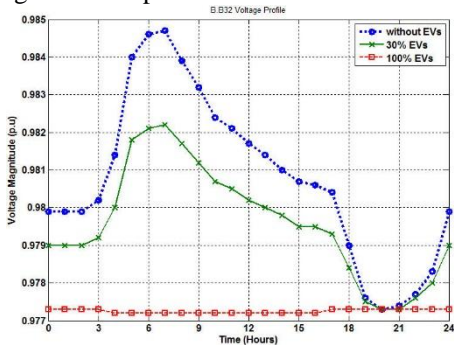

Fig. 33. Voltage profile at LP32

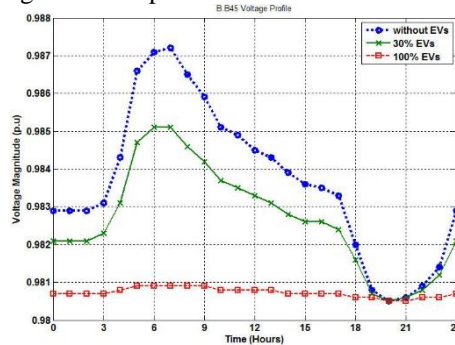

Fig. 34. Voltage profile at LP45

5. COMPARISON ANALYSIS

Comparison analysis between coordinated and uncoordinated EVs charging at penetration level of 100% is given in this section for RBTS-Bus2 and ShC-D8 test systems as following.

5.1 RBTS-Bus2 test system

Table 2 and Figures from Fig.35 to Fig. 40 show that the system performance is enhanced in case of coordinated integration. Table 3 show the total operational & charging costs and profits of coordinated integration. The charging cost is reduced in case of coordinated charging by about 50.42% cost reduction over uncoordinated charging.

**Table 2:** Coordinated and uncoordinated Energies of RBTS-Bus2 test system

Type of Integration	EVs (%)	Total Energy Infeed (MWh)	Total Energy Load (MWh)	Total Energy Losses (MWh)
Without EVs	0%	300.369	297.457	2.918
Uncoordinated	30%	307.343	304.303	3.047
	100%	321.324	317.995	3.338
Coordinated	30%	305.873	302.898	2.981
	100%	316.899	313.781	3.125

**Table 3:** Operational & charging costs and profits of RBTS-Bus2 test system

Type of Integration		Total Operation Cost		Charging Cost	
		30%	100%	30%	100%
Without EVs	EUR	3543.79		---	
Uncoordinated	EUR	3845.56	4449.08	301.77	905.29
Coordinated	EUR	3693.41	3992.64	149.62	448.86
Profit using coordinated	EUR	152.15	456.43	152.15	455.43
	%	4%	10.3%	50.42%	50.42%

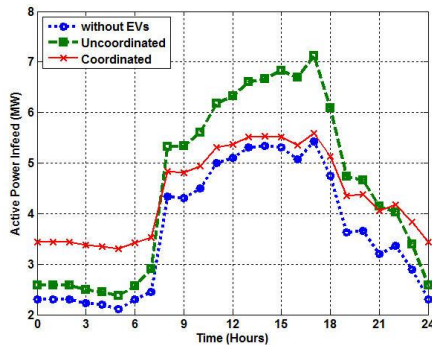

Fig. 35. Load profile of Feeder Fdr1

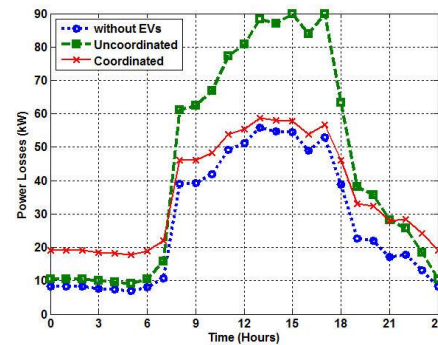

Fig. 36. Power losses of Feeder Fdr1

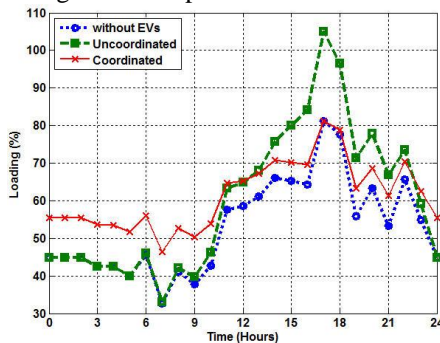

Fig. 37. Load profile of transformer TP1

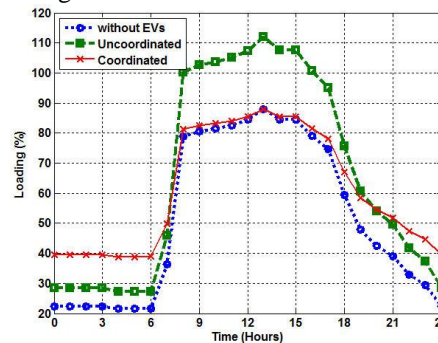

Fig. 38. Load profile of transformer TP4

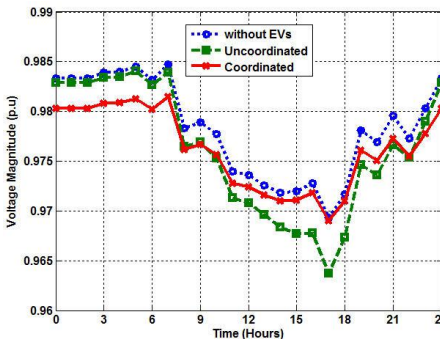

Fig. 39. Voltage profile at LP1

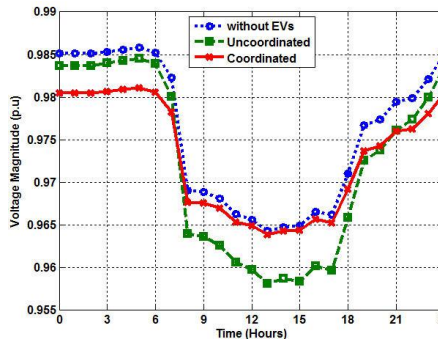

Fig. 40. Voltage profile at LP4

## 5.2 ShC-D8 real test system

Table 4 and Figures from Fig. 41 to Fig. 46 show that the system performance is enhanced in case of coordinated integration. Table 5 show the total operational & charging costs and profits of coordinated integration. The charging cost is reduced in case of coordinated charging by about 70.70% cost reduction over uncoordinated charging.

**Table 4:** Coordinated and uncoordinated Energies of ShC-D8 real test system

Type of Integration	EVs (%)	Total Energy Infeed (MWh)	Total Energy Load (MWh)	Total Energy Losses (MWh)
Without EVs	0%	273.116	271.384	1.733
Uncoordinated	30%	310.662	308.364	2.300
	100%	386.184	382.323	3.867
Coordinated	30%	292.023	290.062	1.963
	100%	329.909	327.416	2.495

**Table 5:** Operational & charging costs and profits of ShC-D8 real test system

Type of Integration		Total Operation Cost		Charging Cost	
		30%	100%	30%	100%
Without EVs	EUR	3555.68		---	
Uncoordinated	EUR	4259.03	5665.69	703.35	2110.01
Coordinated	EUR	3761.74	4173.85	206.06	618.17
Profit using coordinated	EUR	497.29	1491.85	497.29	1491.84
	%	11.68%	26.33%	70.70%	70.70%

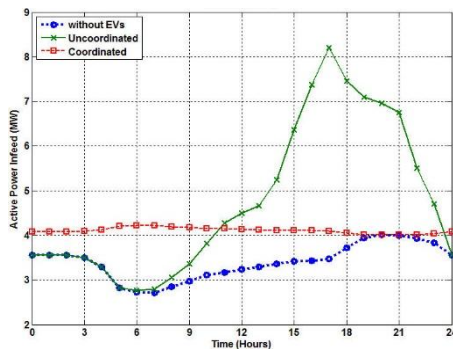

Fig. 41. Load profile of Feeder Fdr3

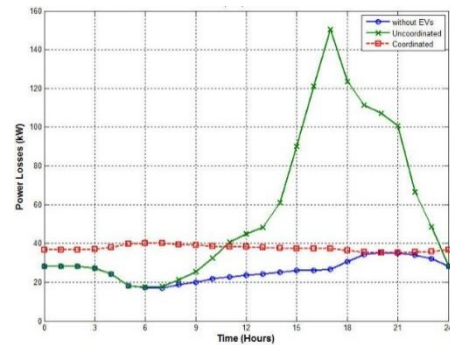

Fig. 42. Power losses of Feeder Fdr2

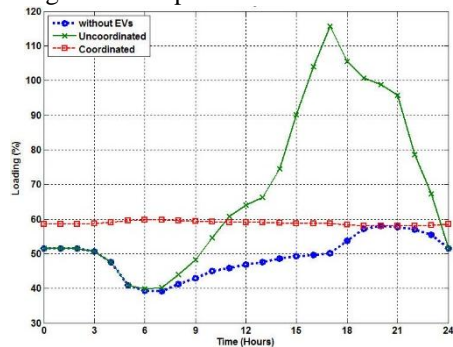

Fig. 43. Load profile of transformer TP22

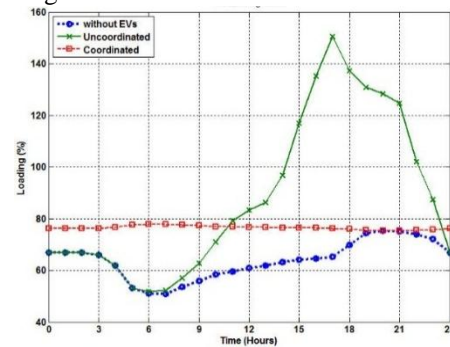

Fig. 44. Load profile of transformer TP36

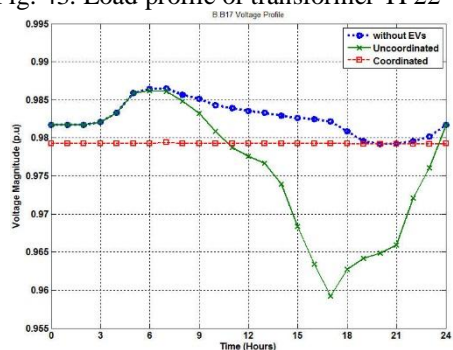

Fig. 45. Voltage profile at LP17

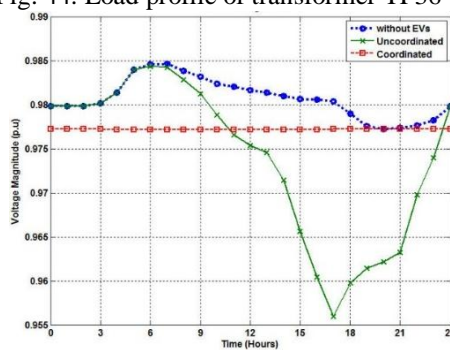

Figure 45: Voltage profile at LP32

## 6. CONCLUSION

This paper investigates the impact of integration of Electric Vehicles (EVs) into the distribution systems through extensive simulations. This research considered two charging schemes (uncoordinated and coordinated) and two EV penetration levels (30% and 100%). Both coordinated and uncoordinated integrations implemented on benchmark RBTS-Bus2 test system and Sh.C-D8 real

distribution system in Egypt. Actual real time pricing profile and actual daily load curves are considered in this work. From the presented results tables as well as figures, the following main conclusions can be stated:

- Uncoordinated integration of EVs can result in feeders and transformers overloading, lower voltage profiles, higher system losses and higher operational and charging cost.
- Coordinate integrations can considerably mitigate the negative impacts of system performance in case of uncoordinated integration.
- The penetration levels of EVs have major effects on system performance.

## REFERENCES

- [1] R.Liu, L.Dow, and E.Liu, "A Survey of PEV Impacts on Electric Utilities", in Proc. ISGT'11, pp.1-8, Oct.2011.
- [2] R.A.Verzijlbergh, M.O.W.Gron, Z.Lukszo, J.G.Slootweg, M.D.Ilic, "Network Impacts and Cost Savings of Controlled EV Charging", IEEE Transactions on Smart Grid, vol.3, no.3, pp.1203-12, Sep.2012.
- [3] S.Deilami, A.S.Masoum, P.S.Moses, and M.S.Masoum, "Realtime coordination of plug-in electric vehicle charging in smart grids to minimize power losses and improve voltage profile", IEEE Trans. on Smart Grid, vol.2, no.3, pp.456-67, Sep.2011.
- [4] M.F.Shaaban, M.Ismail, and E.F.El-Saadany, "PEVs Real-time Coordination in Smart Grid Based on Moving Time Window", IEEE, 2014.
- [5] M.F.Shaaban, M.Ismail, E.F.El-Saadany, and W.Zhuang, "RealTime PEV Charging/Discharging Coordination in Smart Distribution Systems", IEEE Trans. on Smart Grid, vol.5, no.4, July2014.
- [6] A.S.Masoum, S.Deilami, P.S.Moses, and A.Abu-Siada, "Impacts of Battery Charging Rates of Plug-in Electric Vehicle on Smart Grid Distribution Systems", IEEE
- [7] A.S.Masoum, S.Deilami, P.S.Moses, and A.A.Siada, "Impact of Plug-in Electrical Vehicles on Voltage Profile and Losses of Residential System", IEEE
- [8] E.Sortomme, M.M.Hindi, S.D.JamesMacPherson, and S.S.Venkata, "Coordinated Charging of Plug-In Hybrid Electric Vehicles to Minimize Distribution System Losses", IEEE Trans. on Smart Grid, Vol.2, No.1, March2011.
- [9] K.Nyns, E.Haesen, and J.Driesen, "The impact of charging plug-in hybrid electric vehicles on a residential distribution grid", IEEE Trans. Power Syst., vol.25, pp.371-80, 2010.
- [10] Salman Habib et al. "Impact analysis of vehicle-to-grid technology and charging strategies of electric vehicles on distribution networks - A review", Journal of Power Sources 277 (2015) 205-214.
- [11] "Transportation Electrification: A Technology Overview", 2011-TECHNICAL REPORT, Electric Power Research Institute (EPRI), July2011.
- [12] R.Walling and G.B.Shattuk, "DistributionTransformer Thermal Behaviour and Aging in Local Delivery Distribution System", Cired 19th International Conference on Electricity Distribution, Vienna, 21-24 May2007.
- [13] "Annual Report" 2014/2015, Egyptian Electricity Holding Company, 2015.
- [14] Online: <http://www.nordpoolspot.com/Market-data/#!/n2ex/chart>
- [15] R.Allan, R.Billinton, I.Sjarief, L.Goel, and K.So, "A Reliability Test System for Educational Purposes - Basic Distribution System Data and Results", IEEE Trans. Power Syst., vol.1.6, 1991.