

# Performance study of a cooling device coupled to a membrane distillation unit

P. Byrne<sup>1</sup>, Ahmadou Tidiane Diaby<sup>1,2</sup>, Patrick Loulergue<sup>1</sup>, Béatrice Balannec<sup>1</sup>, Anthony Szymczyk<sup>1</sup>, Thierry Maré<sup>1</sup>, Ousmane Sow<sup>2</sup>

<sup>1</sup> Université de Rennes 1, LGCGM and ISCR, France

<sup>2</sup> Université Cheikh Anta Diop, LEA Dakar, Sénégal

paul.byrne@univ-rennes1.fr

# Outline

- ↘ Context of air-conditioning
- ↘ Experimental bench
- ↘ Simulation model
- ↘ Results
- ↘ Conclusions
- ↘ Perspectives

# Refrigeration cycle

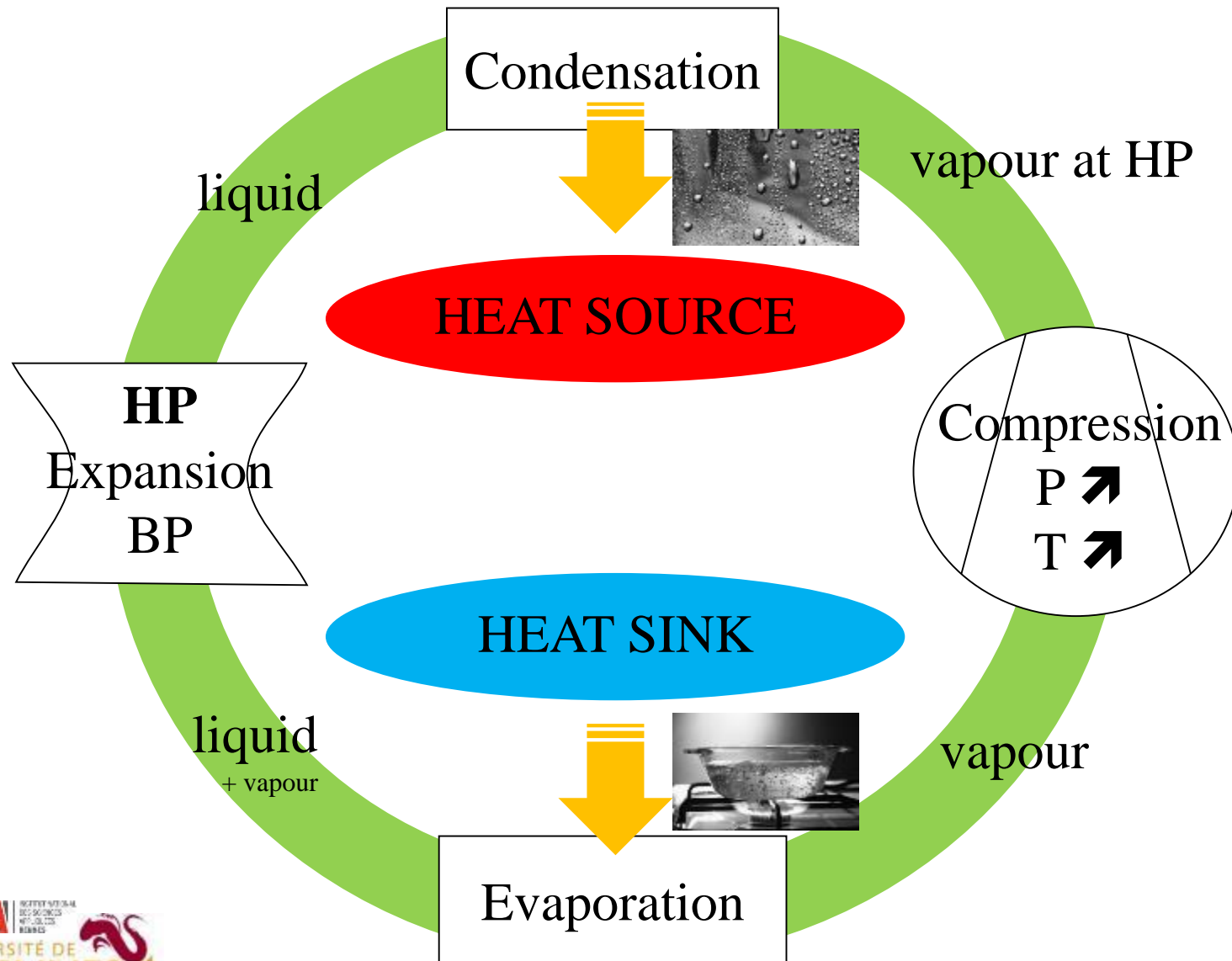

# Cooling devices

Air of the room



Air inside the refrigerator

Heat pumps for simultaneous heating and cooling (Lab)



Cold water

Hot water

Conditioned air



Outdoor air

# World's population

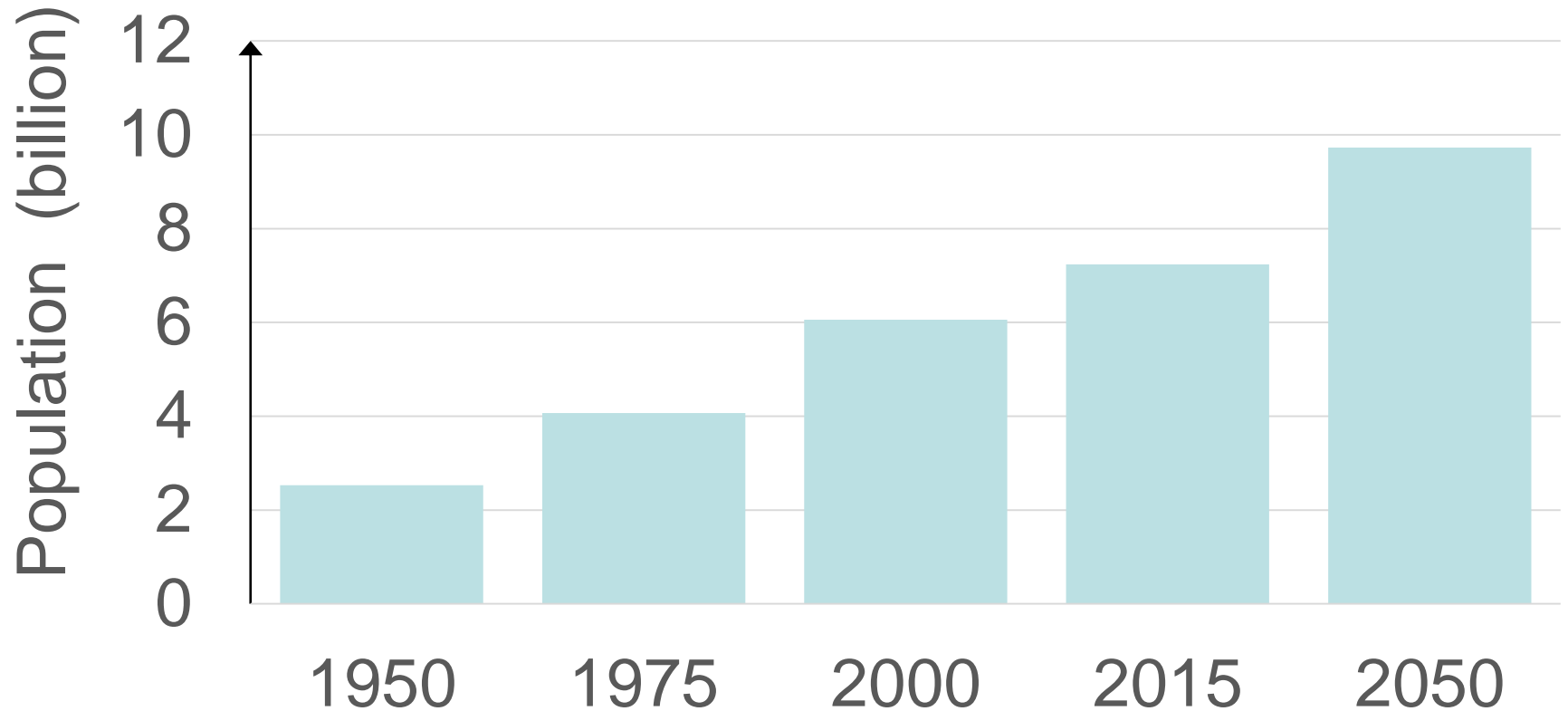

# Electricity consumption

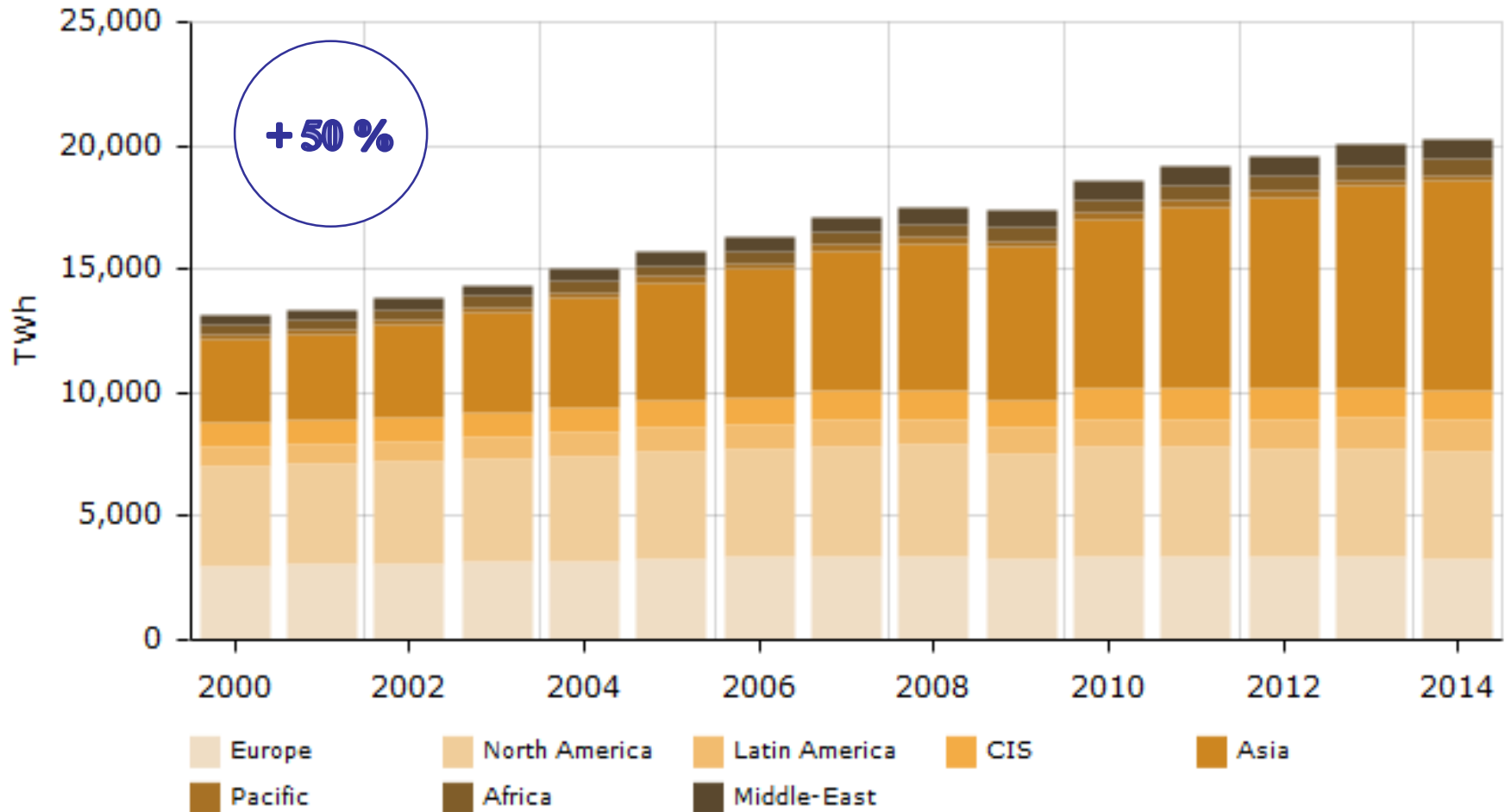

Source : Enerdata.net

# Air-conditioning situation

Vakiloroaya V. et al. *A review of different strategies for HVAC energy saving, Energy Conversion and Management* 77 (2014) 738–754

- In Europe, building = 40 % of energy consumption (in the US, 50 %)
- In India, air-conditioning = 32 % of electricity consumption
- In Hong Kong in 2006, refrigeration and air-conditioning = 33 % of electricity consumption
- In the Middle East, refrigeration and air-conditioning = more than 70 % of energy consumption

*Electricity consumption for air-conditioning in buildings*

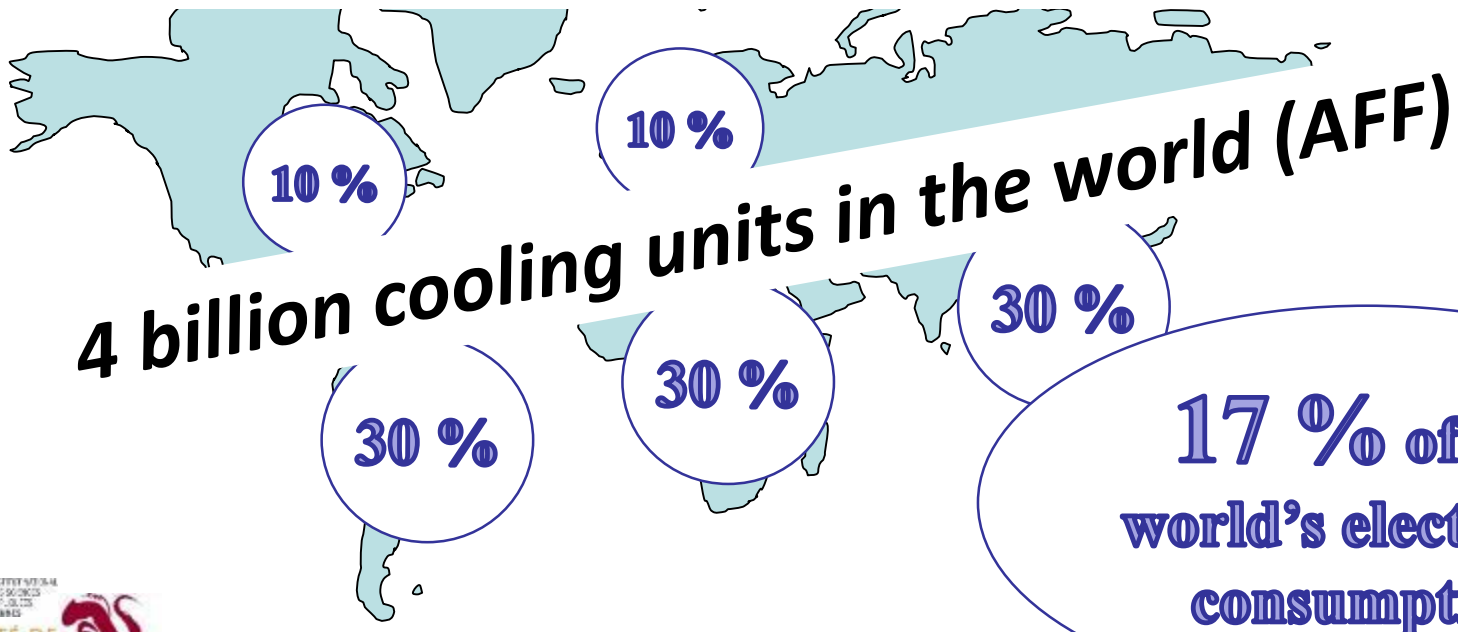

# Tendency 2000-2100

*Isaac M. et al. Modeling global residential sector energy demand for heating and air conditioning in the context of climate change, Energy Policy 37 (2009) 507–521*

Prospective of energy demand  
taking into account climate change:

-34 % for heating

+72 % for air-conditioning



**Let's valorize this heat loss!**

**62 condensers**  
**2 times the front area**  
**2 sides**  
**~3 kW**  
**62 x 2 x 2 x 3**

**= 744 kW thermal**

**Heat rejected by**  
**~620 refrigerators of 100 l**

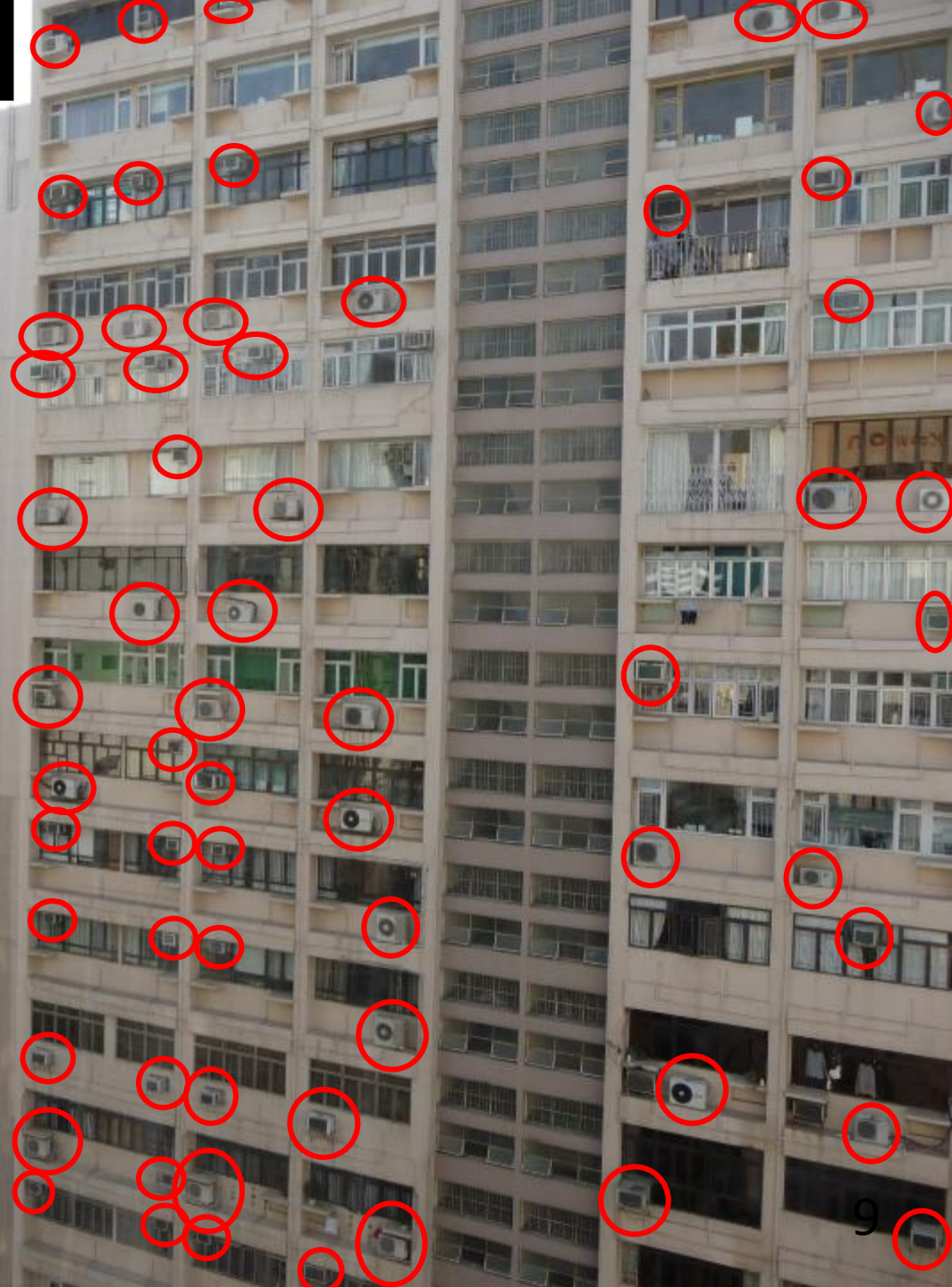

# Membrane Distillation

- $T = 25 \text{ à } 80 \text{ °C}$

Compatible with temperature levels of air-conditioning condensers

- Membranes
  - Microporous : pore size  $\sim 0,2 \text{ }\mu\text{m}$ , porosity 80%
  - Hydrophobic : only vapour transfers
  - Polypropylene, PTFE (Teflon), PVDF, PAN...

# Membrane distillation types

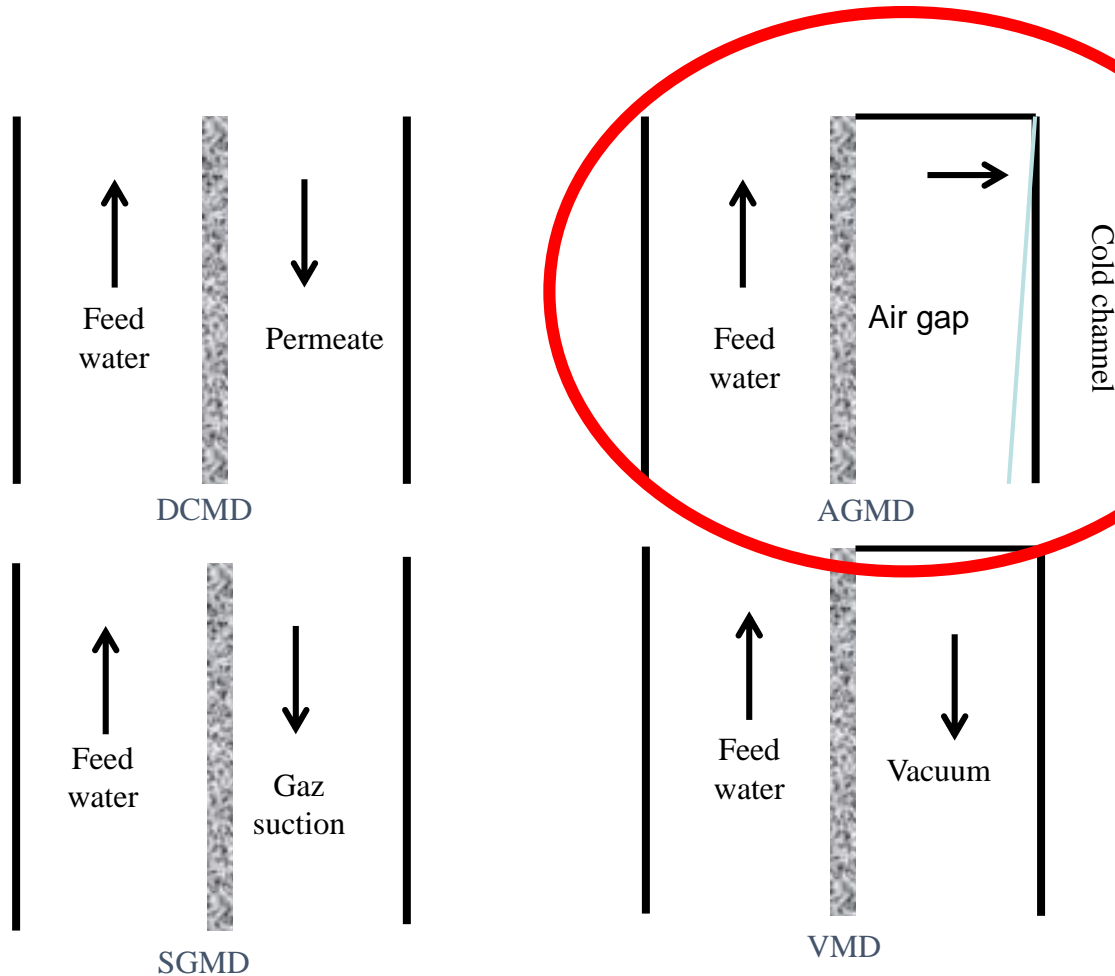

1 pump  
Gravitational  
Low pressure  
Less wetting  
Easy to build

# Pilot unit

Canal  
d'eau froide

Cassette

Perméat

Pompe



Réservoir

Chauffage  
électrique

Boîtier  
électrique

# Pilot unit scheme

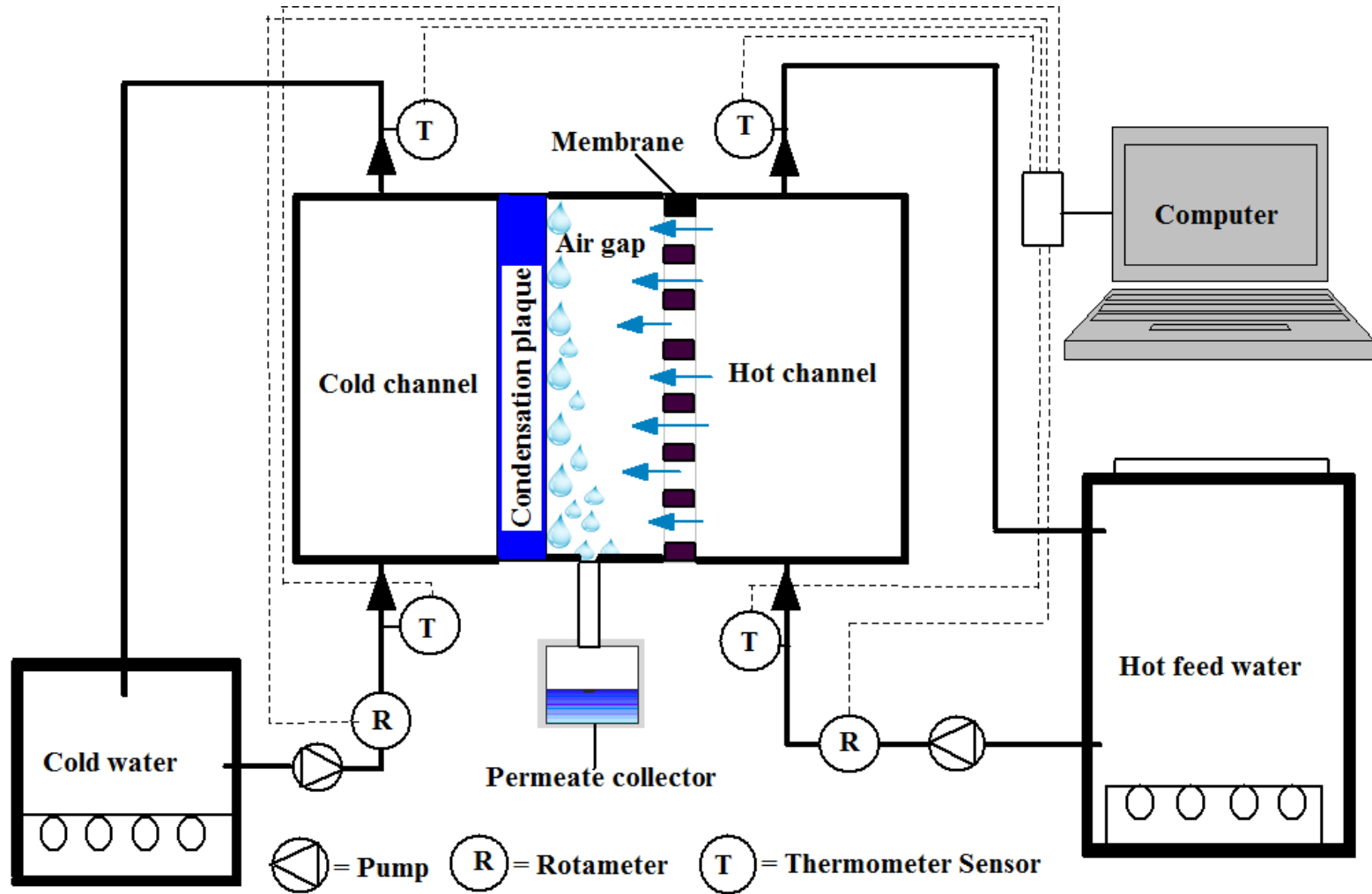

# Scheme of the coupled system

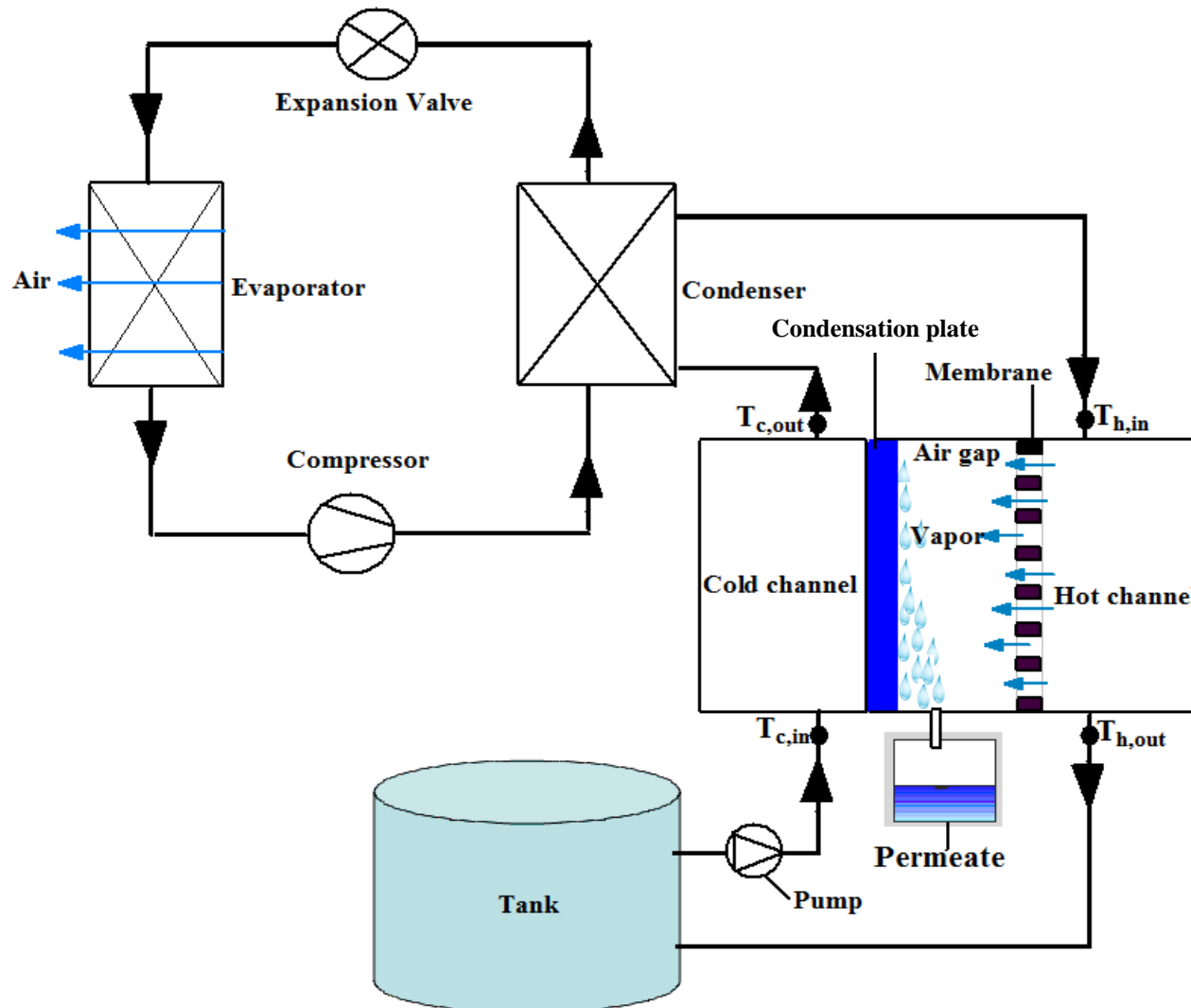

# AGMD principle

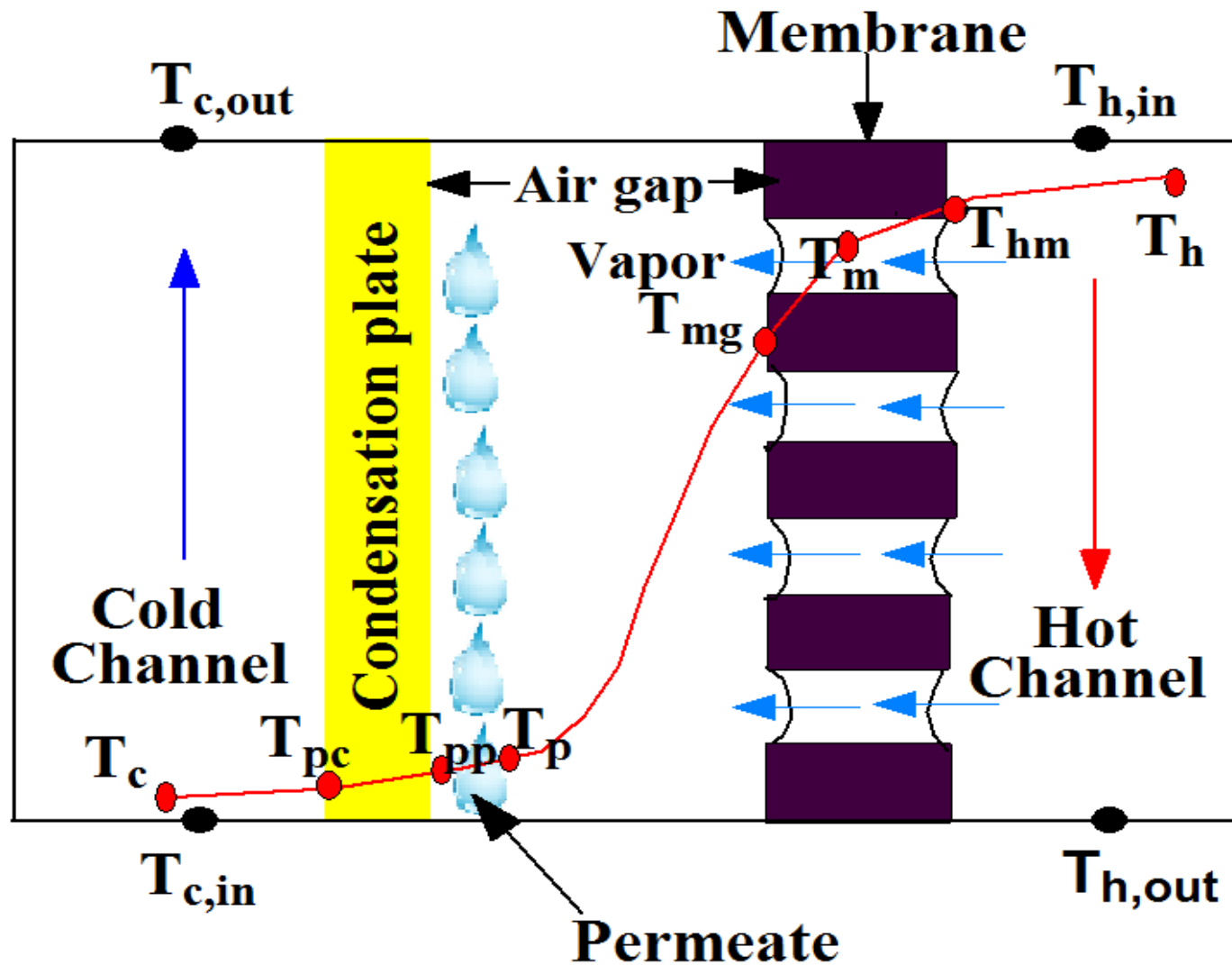

# Numerical model 1/2

- **Heat transfer**

- $\dot{Q}_h = \dot{Q}_m = \dot{Q}_{ag} = \dot{Q}_{plate} = \dot{Q}_c \quad (1)$

- $\dot{Q}_h = hc_h (T_h - T_{hm}) \quad (2)$

- $\dot{Q}_m = \frac{1}{R_{mT}} (T_{hm} - T_{mg}) + J_v \cdot \Delta h_{vap} \quad (3)$

- $\dot{Q}_{ag} = \frac{1}{R_{ag}} (T_{mg} - T_p) \quad (4)$

- $\dot{Q}_{plate} = \frac{k_p}{\delta_p} (T_{pc} - T_p) + J_v \cdot \Delta h_{cond} \quad (5)$

- $\dot{Q}_c = hc_c (T_p - T_c) \quad (6)$



# Numerical model 2/2

- **Mass transfer**

- $J_v = B_v \cdot \Delta P_v$  (7)

- $P_v = \exp\left(23,1964 - \frac{3816,44}{T-46.13}\right)$  (8)

- $B_v = \frac{\varepsilon M_v P D_{ia}}{RT_m(\delta_m \tau + \delta_g) |P_a| \ln, a}$  (9)

# Model validation

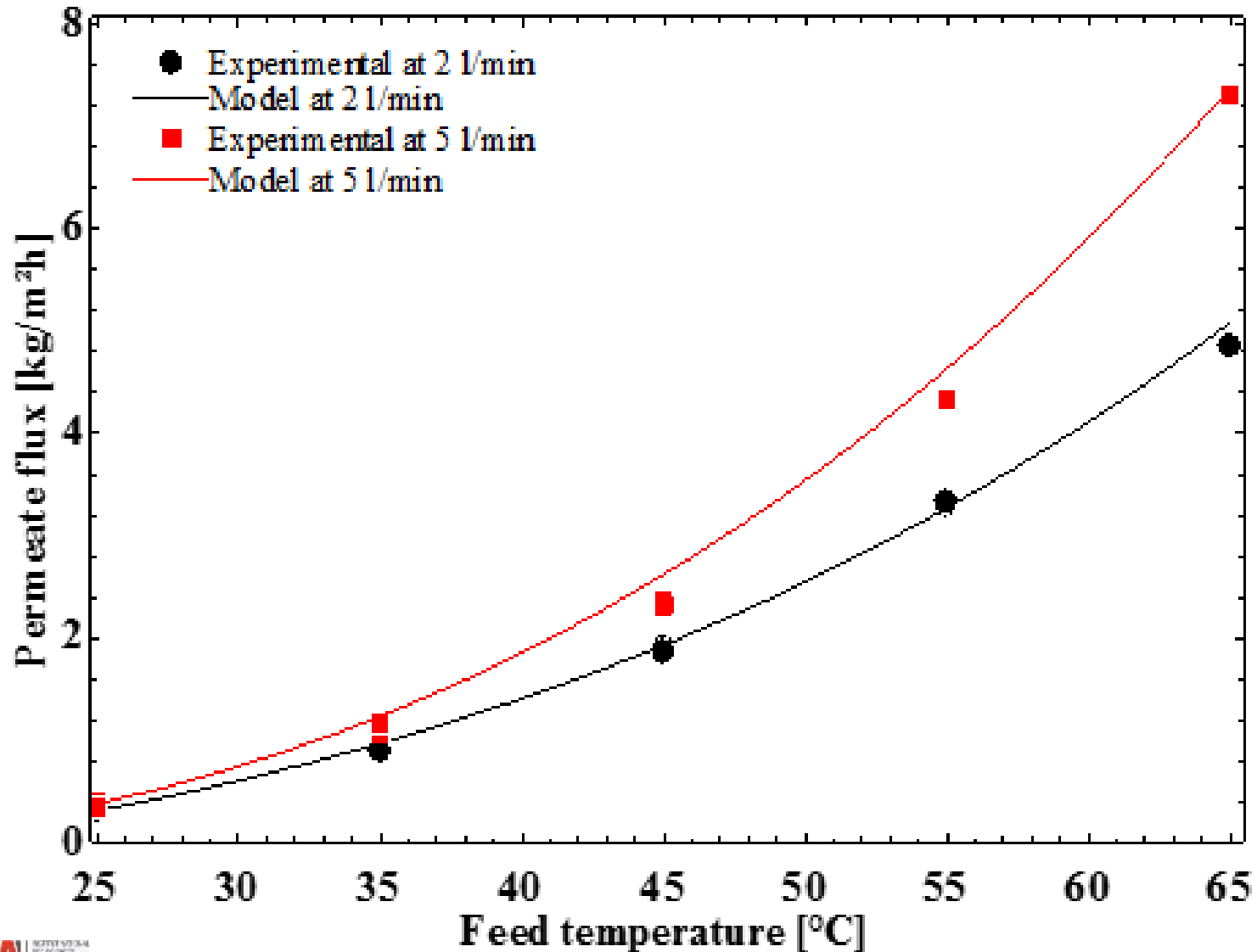

# Performance evaluation

- $\text{COP} = \frac{\text{cooling capacity}}{\text{electric power}}$
- $\text{GOR} = \frac{\text{heat to evaporate the permeate}}{\text{heat consumption}}$
- $\text{PR} = \frac{\text{permeate production in kg}}{\text{heat consumption}}$
- $\eta_{ex} = \frac{\text{exergy output (distilled water+cooling)}}{\text{exergy input (seawater+electricity)}}$

Exergy = mechanical work recoverable in a heat or mass transfer or a chemical reaction...

# Coefficient of performance

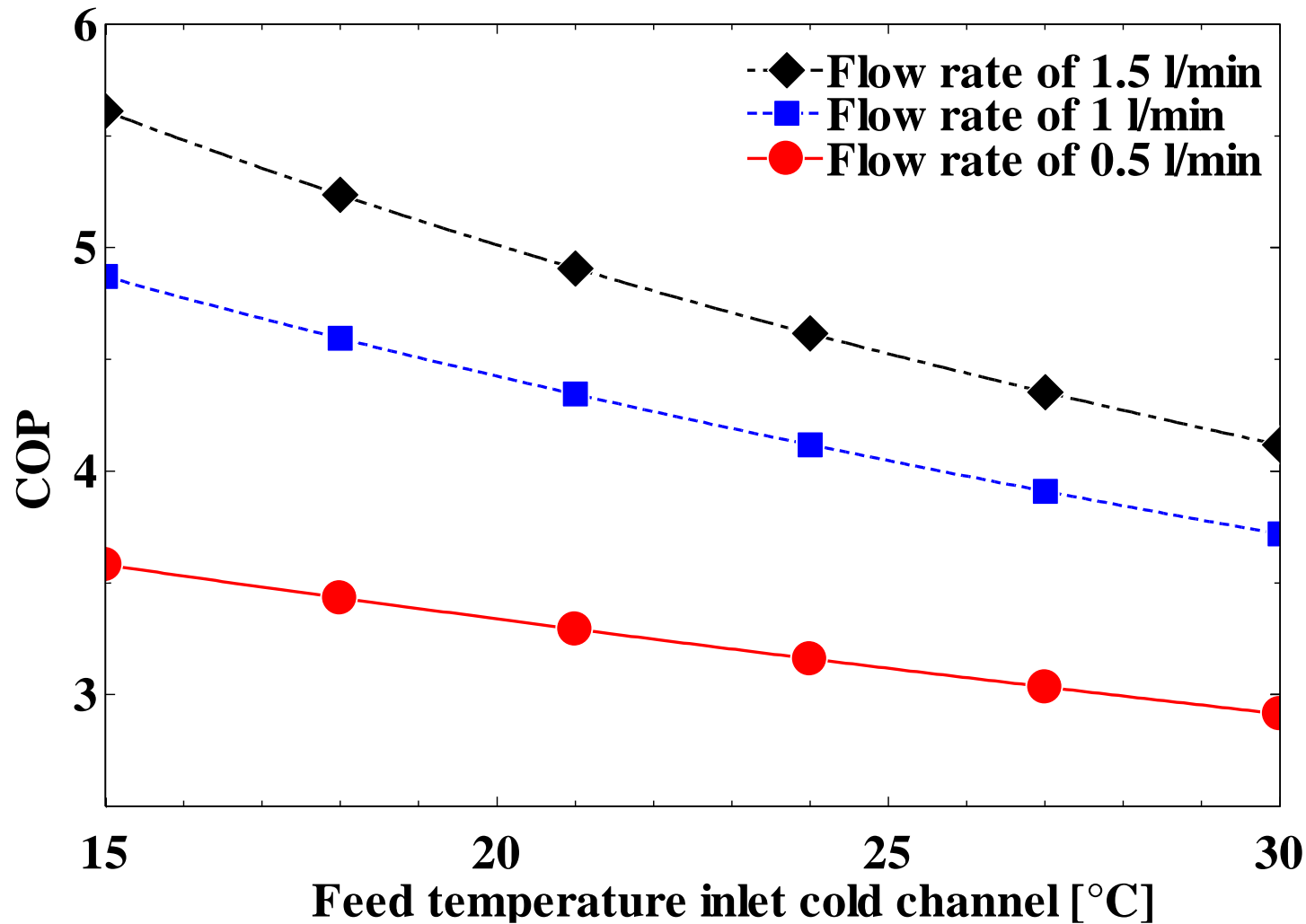

# a look back to the scheme...

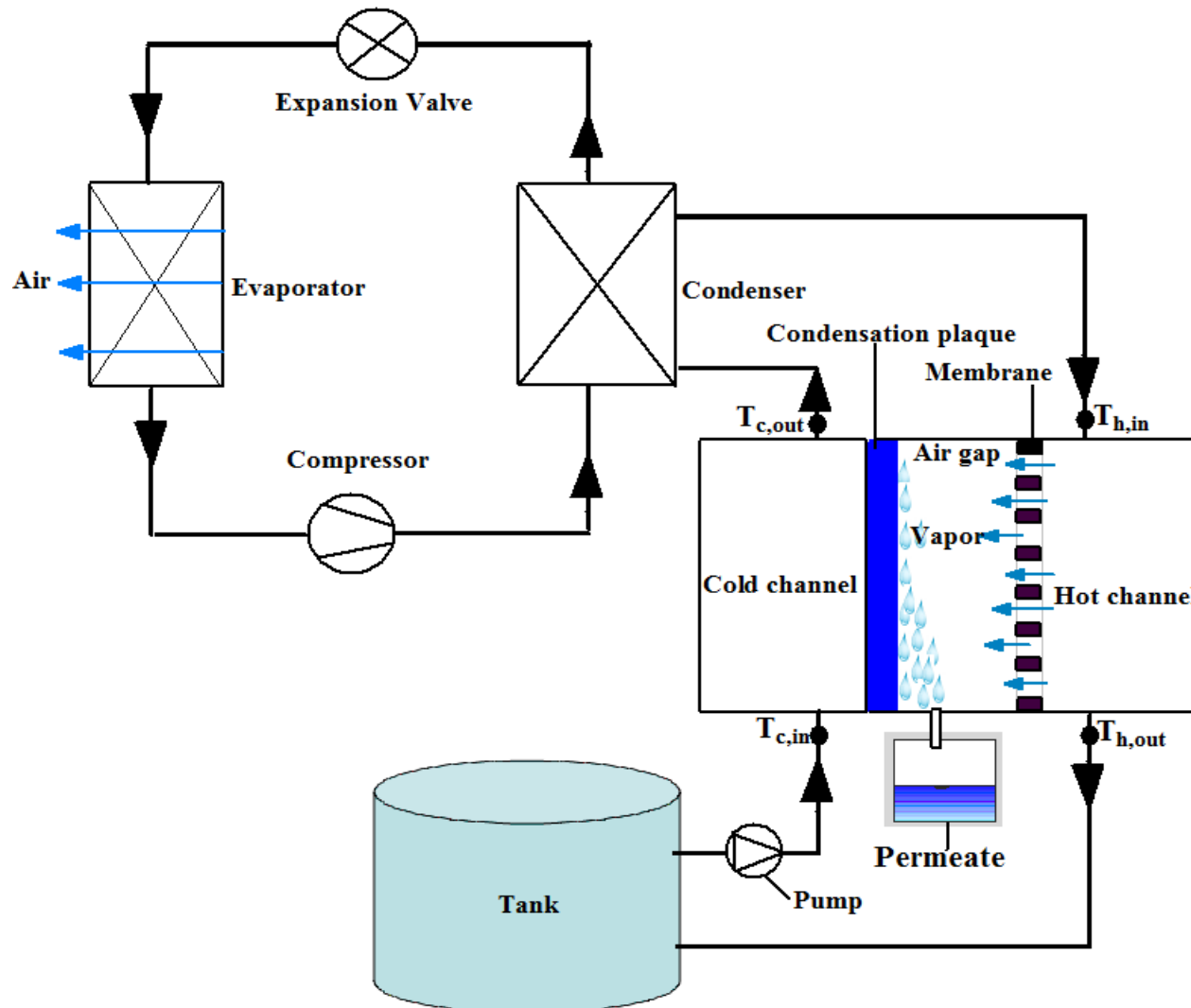

# Gained output ratio

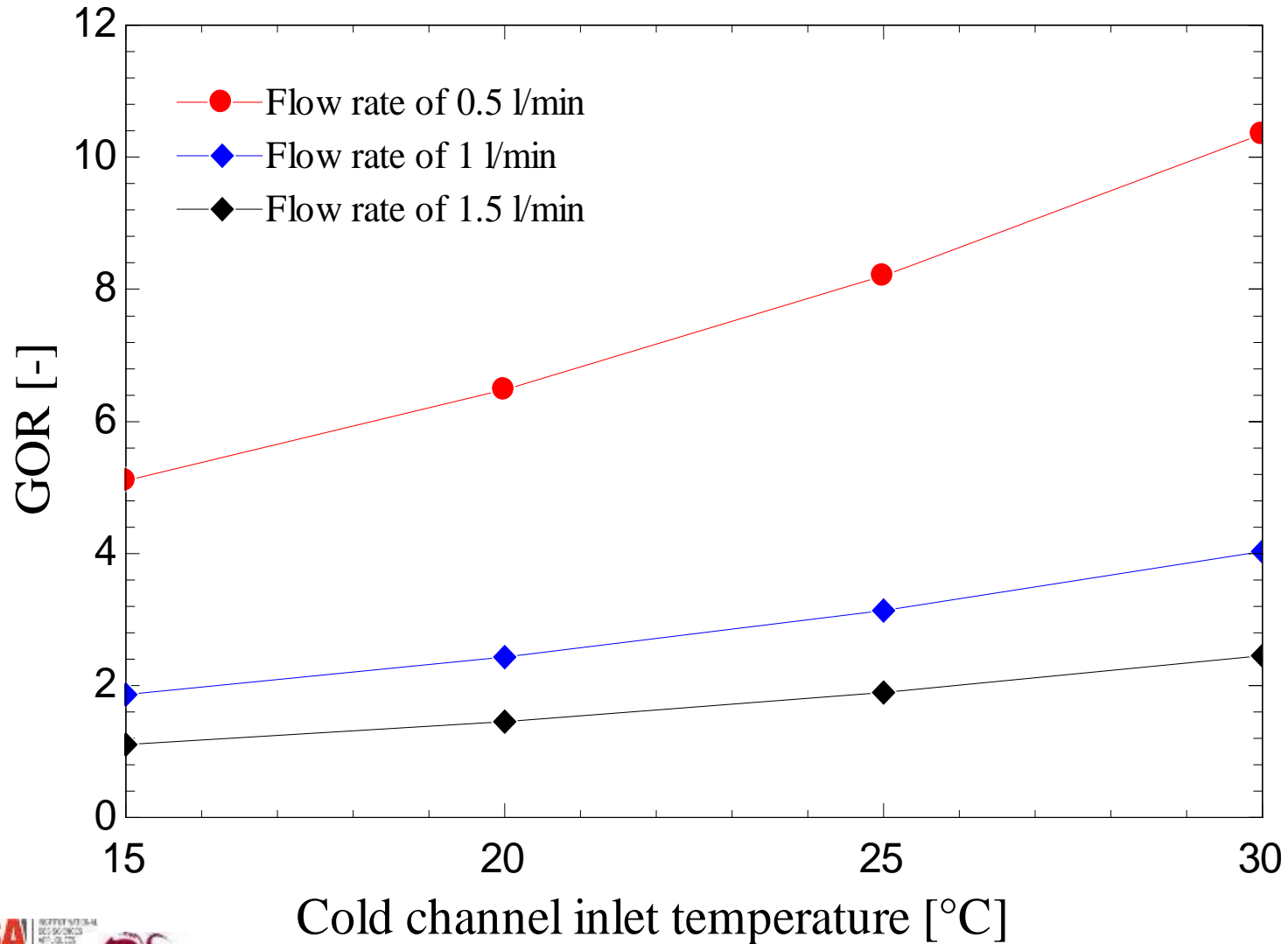

# Performance ratio

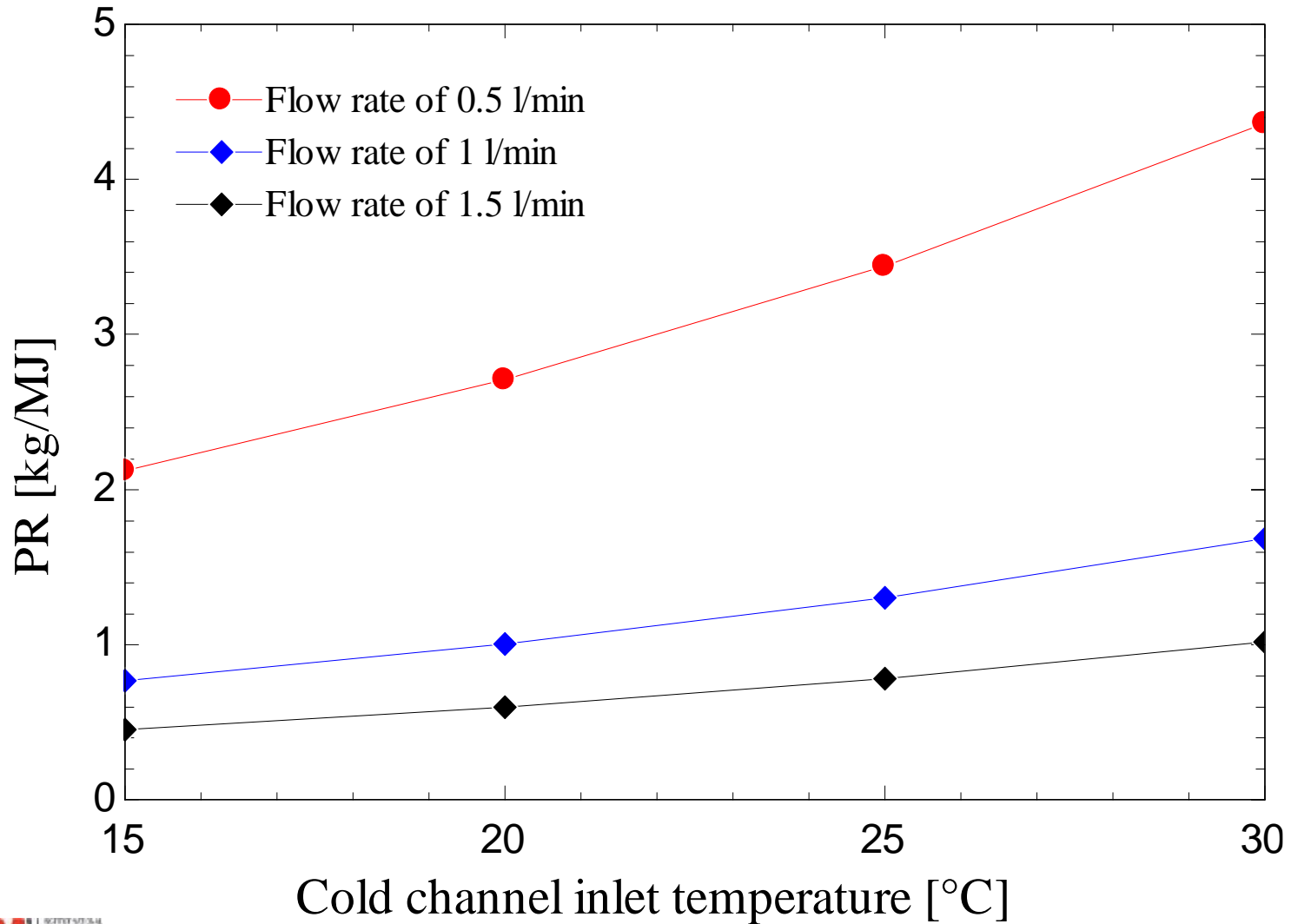

# Exergy efficiency

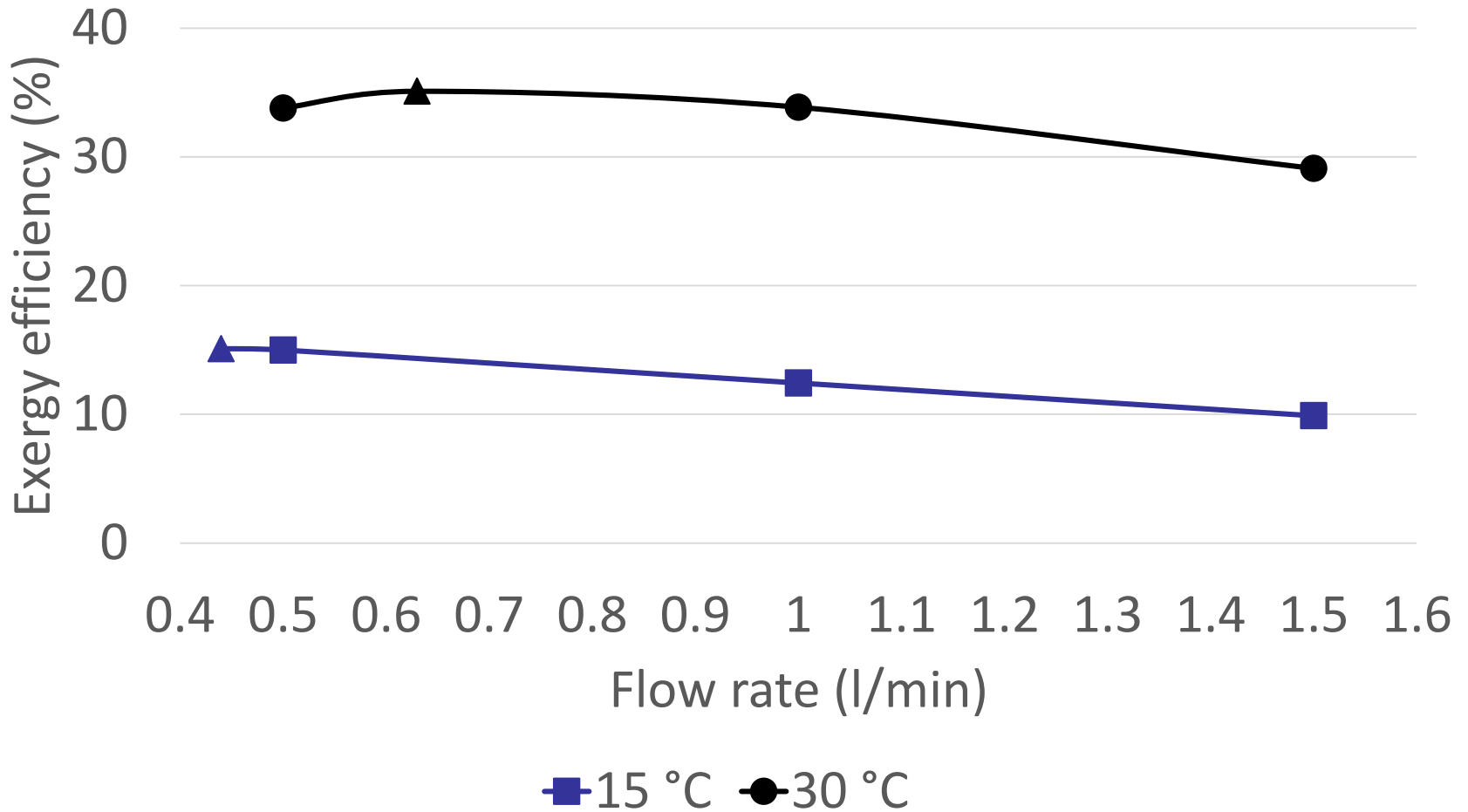



# Conclusions

- Best COP with low temperature and high flow rate
- Maximum GOR over 10
- Maximum PR over 4 kg/MJ
- Optimal exergy efficiency for low water flow rates and high temperature
  
- Low operating temperatures of MD
  - Compatible with a cooling device

# Perspective

Coupled prototype

MD unit fabricated with a 3D printer

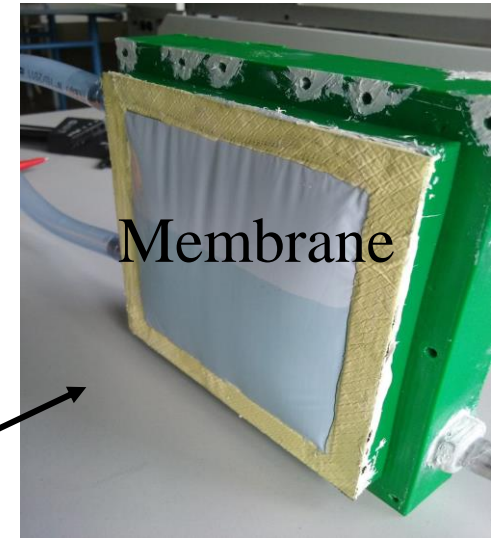
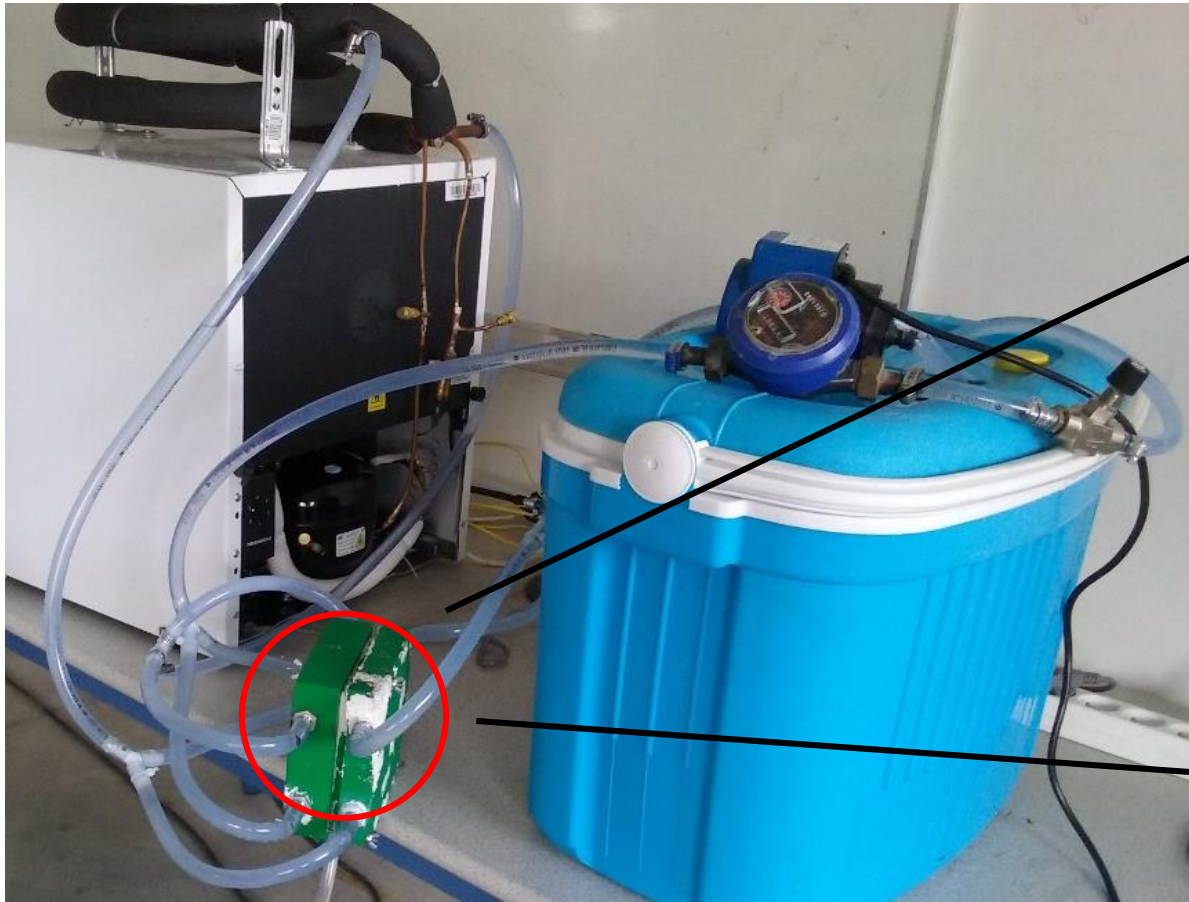

Membrane

Hot channel

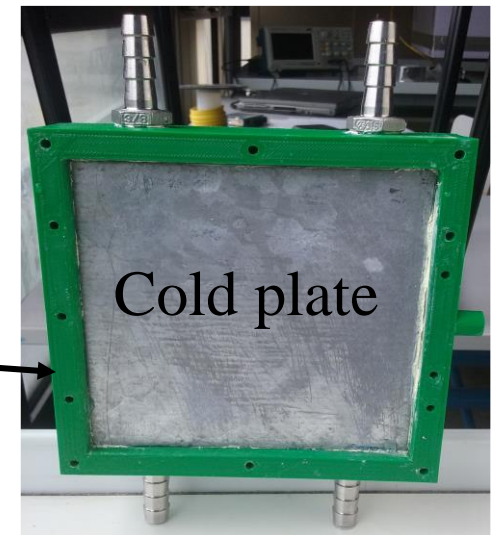

Cold plate

Cold channel

# Coupled prototype scheme

**RECOVERY  
HEAT  
EXCHANGER**

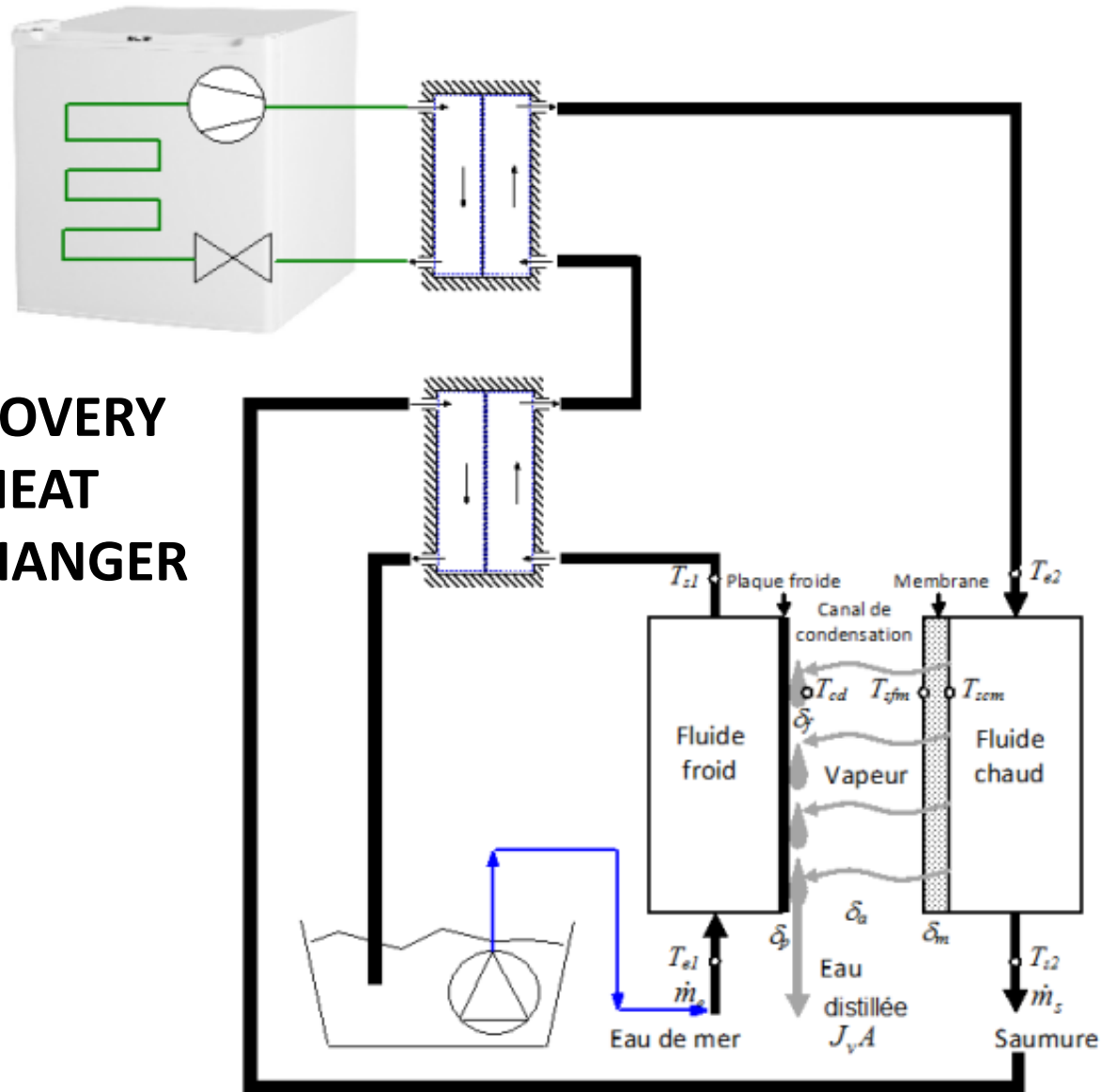

**Let's valorize lost heat !**

**Model :**

**PR = 3 kg/MJ**

**PR = 10.8 kg/kWh**

**For 1 apartment :**

**Condenser  $\sim 3 \text{ kW}_{\text{th}}$**

**32.4 kg/h**

**Hyp:  $2000 \text{ kWh}_{\text{elec}}/\text{year}$**

**COP = 3:  $6000 \text{ kWh}_{\text{th}}/\text{year}$**

**$64.8 \text{ m}^3$  per year !**



Acknowledgements to  
Regional Council of Brittany, BPO Foundation  
and Pascale Simon

Thank you for your kind attention!

[paul.byrne@univ-rennes1.fr](mailto:paul.byrne@univ-rennes1.fr)