



HAL
open science

Valorization of heat lost by refrigeration equipment for desalination by membrane distillation

Ahmadou Tidiane Diaby, Paul Byrne, Patrick Loulergue, Béatrice Balannec, Anthony Szymczyk, Thierry Mare, Ousmane Sow

► **To cite this version:**

Ahmadou Tidiane Diaby, Paul Byrne, Patrick Loulergue, Béatrice Balannec, Anthony Szymczyk, et al.. Valorization of heat lost by refrigeration equipment for desalination by membrane distillation. MemPro6 Intégration des membranes dans les procédés, Jun 2017, Saint-Malo, France. hal-01579709

HAL Id: hal-01579709

<https://hal.science/hal-01579709>

Submitted on 31 Aug 2017

HAL is a multi-disciplinary open access archive for the deposit and dissemination of scientific research documents, whether they are published or not. The documents may come from teaching and research institutions in France or abroad, or from public or private research centers.

L'archive ouverte pluridisciplinaire **HAL**, est destinée au dépôt et à la diffusion de documents scientifiques de niveau recherche, publiés ou non, émanant des établissements d'enseignement et de recherche français ou étrangers, des laboratoires publics ou privés.

Valorization of heat lost by refrigeration equipment for desalination by membrane distillation

Ahmadou Tidiane DIABY^{1,2}, Paul Byrne¹, Patrick LOULERGUE³, Béatrice BALANNEC³, Anthony SZYMCZYK³, Thierry MARE¹, Ousmane SOW²

¹ Laboratoire Génie Civil Génie Mécanique, INSA de Rennes et Université de Rennes1, France

² Laboratoire d'Energétique Appliquée, ESP, Université Cheikh Anta Diop de Dakar, Sénégal

³ Institut des sciences Chimiques de Rennes (UMR CNRS 6226), Université de Rennes1, France

Abstract

The objective of this project is the coupling of a refrigerating machine to a membrane distillation unit. This sea water desalination technique is based on the creation of a temperature gradient between a hot channel and a cold channel. The seawater is heated by the condenser of a refrigerating machine.

Presentation of the study

Fig. 1 shows the design of a coupling approach of a MD unit and a refrigeration machine for cooling and desalination.

Principle: this system allows the recovery of waste heat in the environment by refrigeration or air conditioning equipment to produce fresh water

Mass transfer through the membrane: It depends on the difference in partial pressure of vapour between the feed water in the hot channel and the air gap and on the permeability B of the membrane

$$J_v = B \Delta P \quad (1) \quad B = \frac{\varepsilon M_w P D_{ia}}{RT_m (\delta_m \tau + \delta_g) |P_a|_{ln,a}} \quad (2)$$

Validation of the numerical model: The theoretical model was developed and validated using experimental data obtained at the scale of an air gap membrane distillation pilot. The maximum difference between simulated and experimental results was 6% (Fig.4).

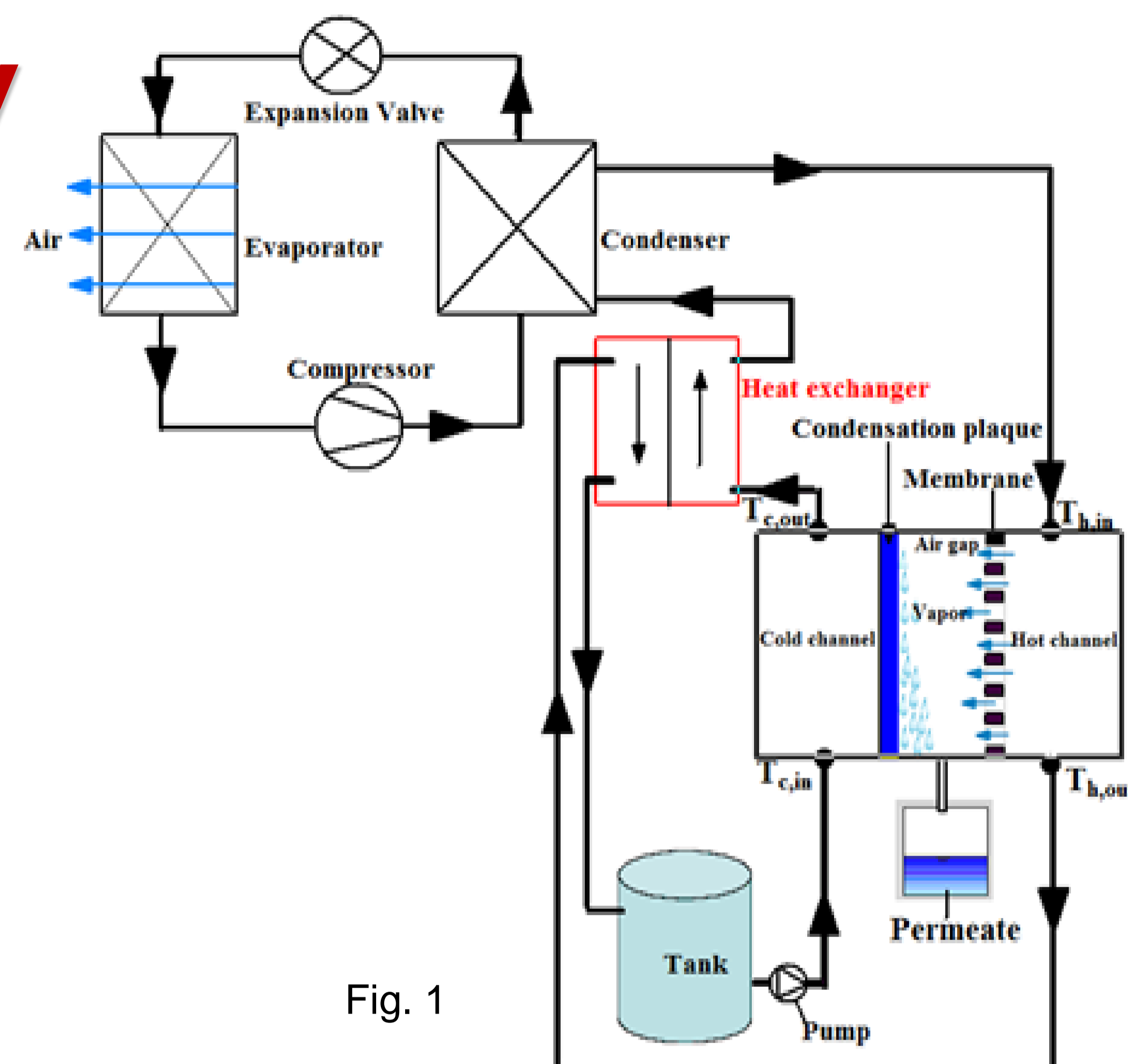
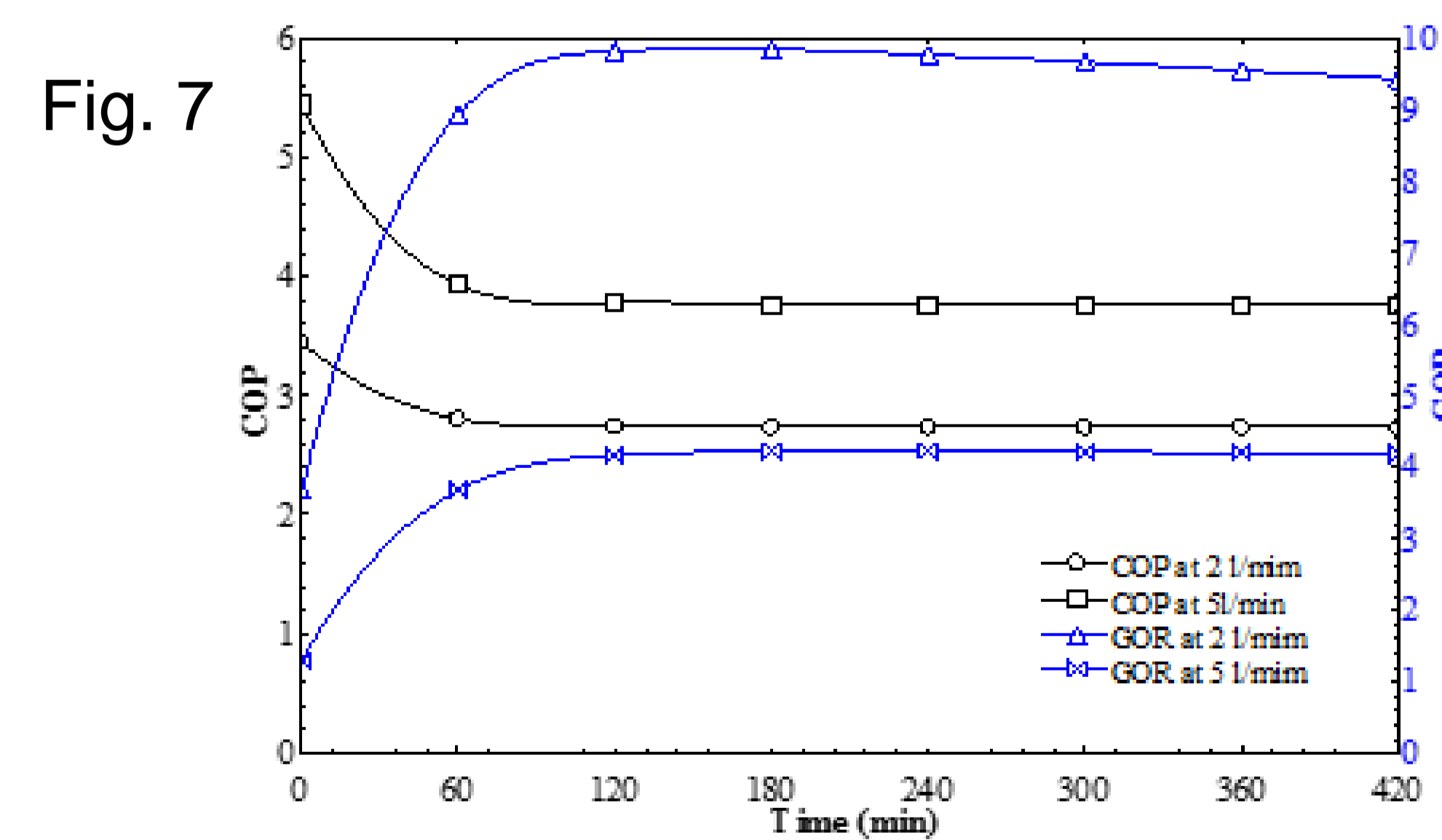
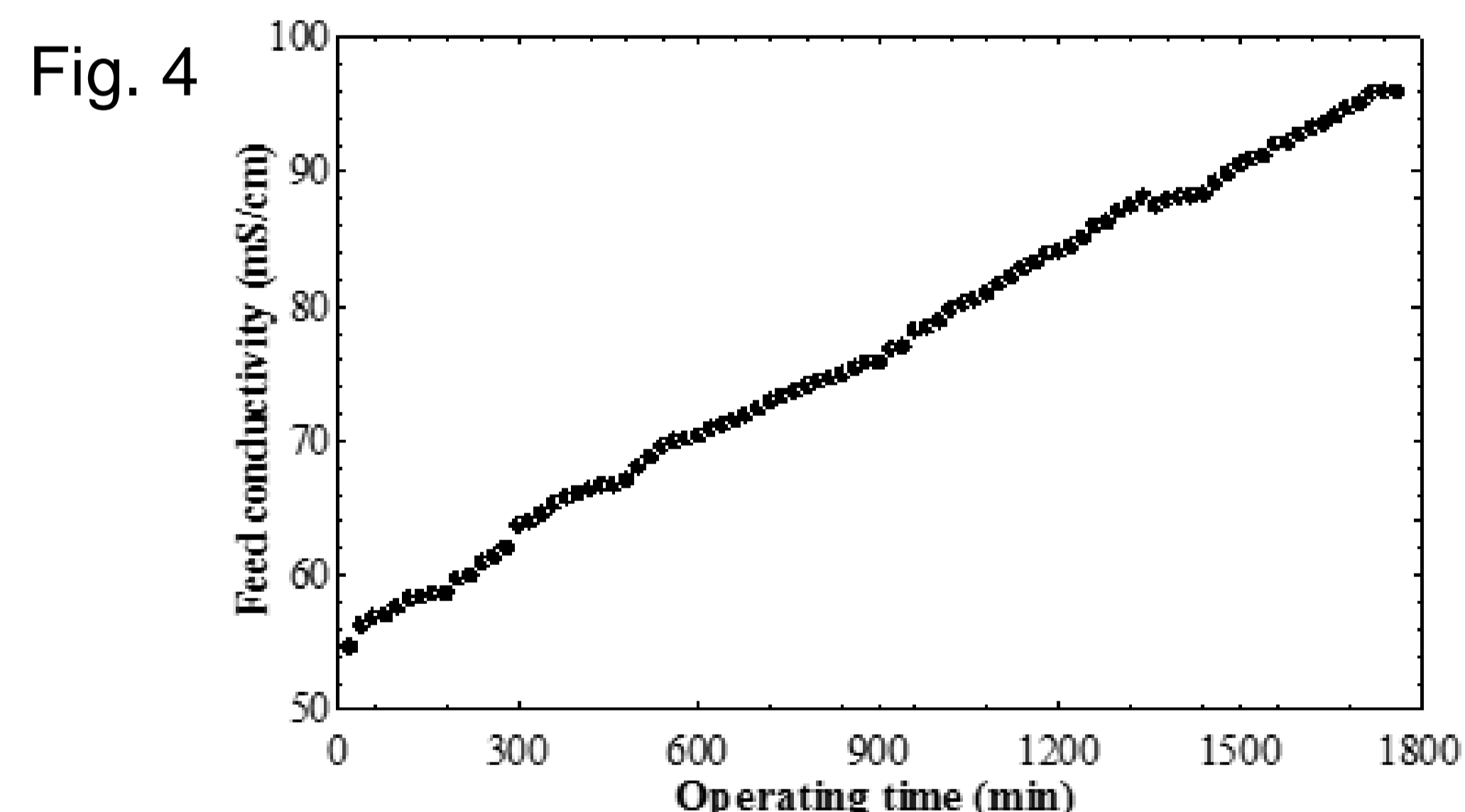
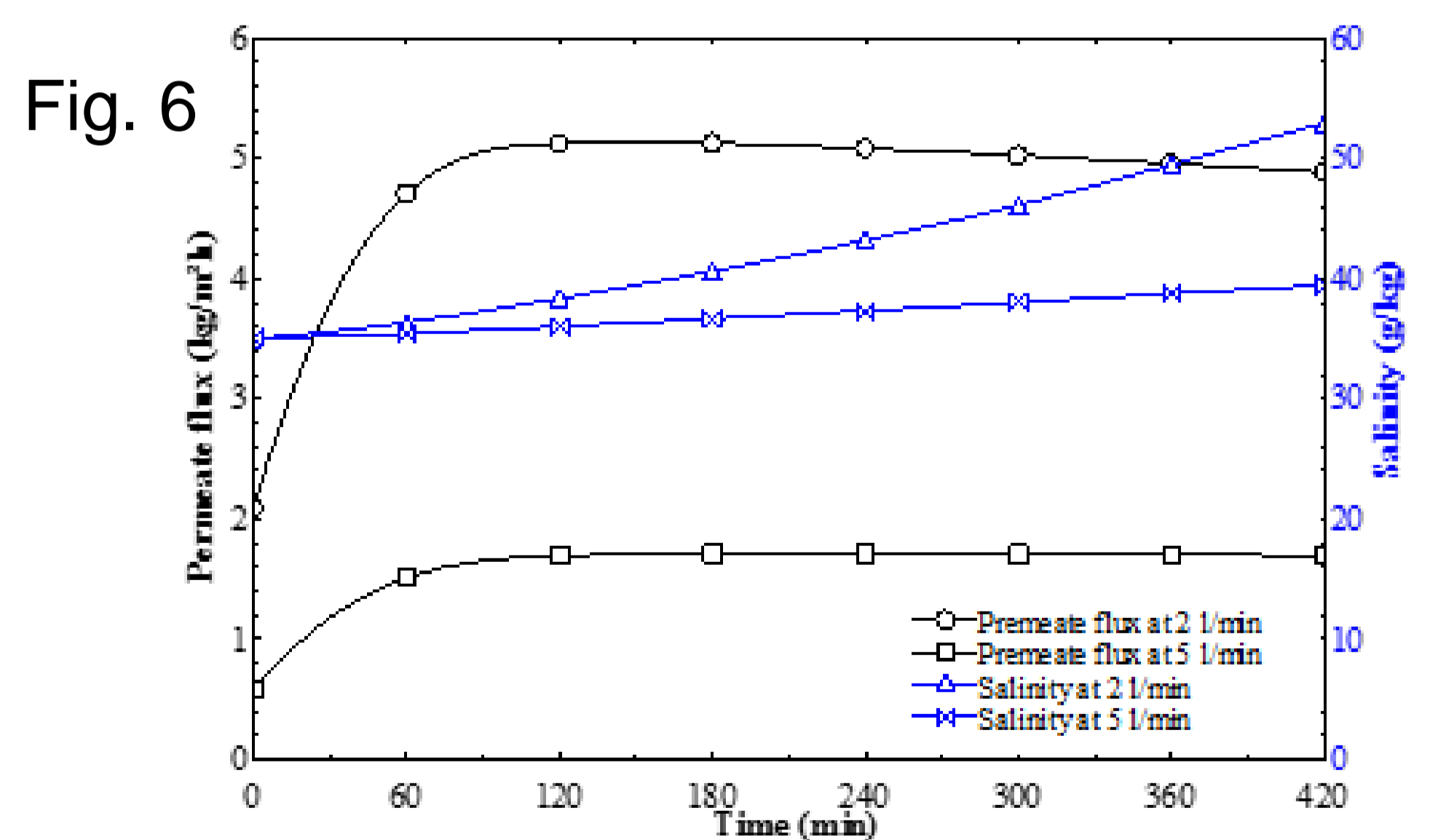
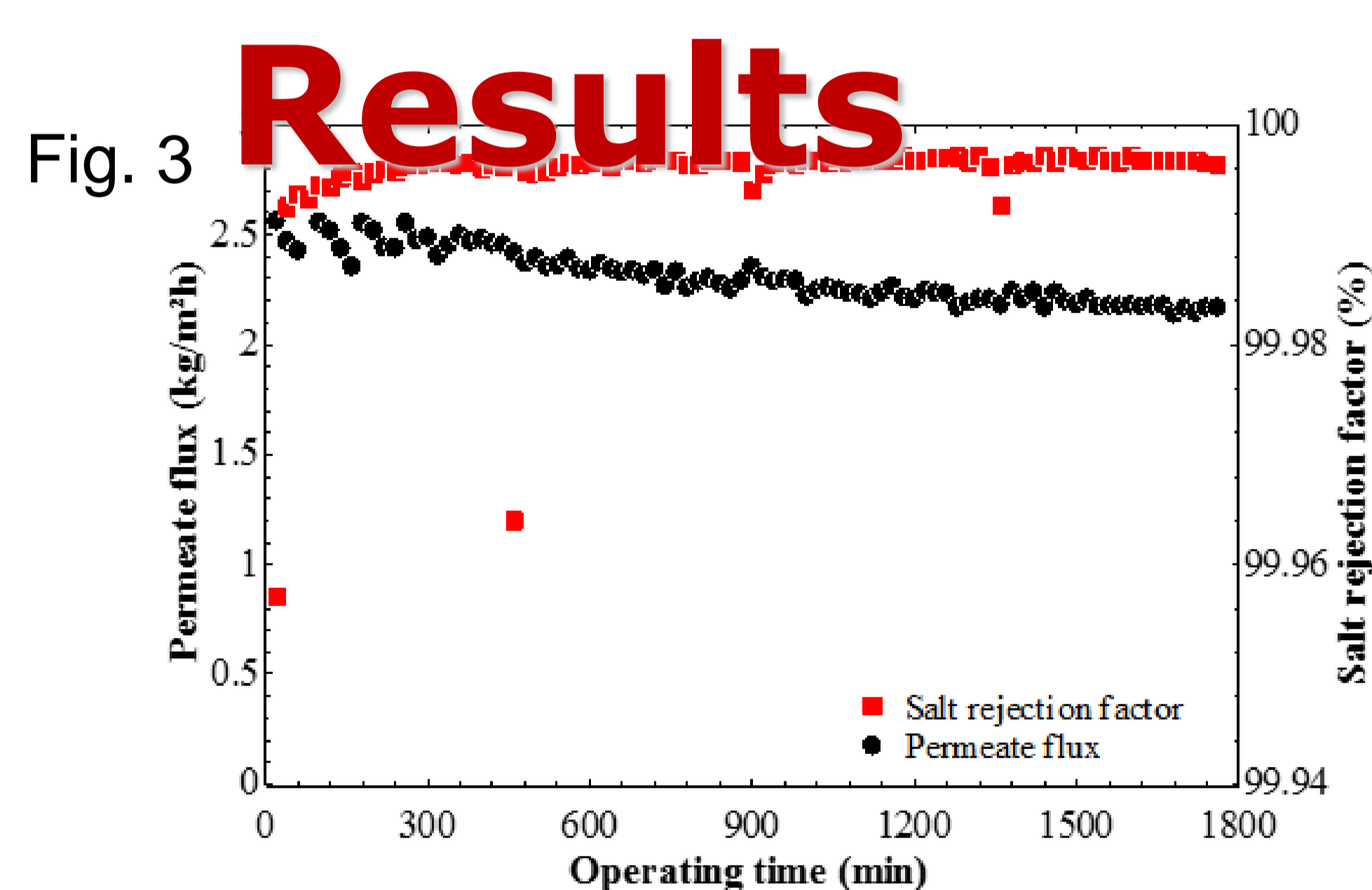
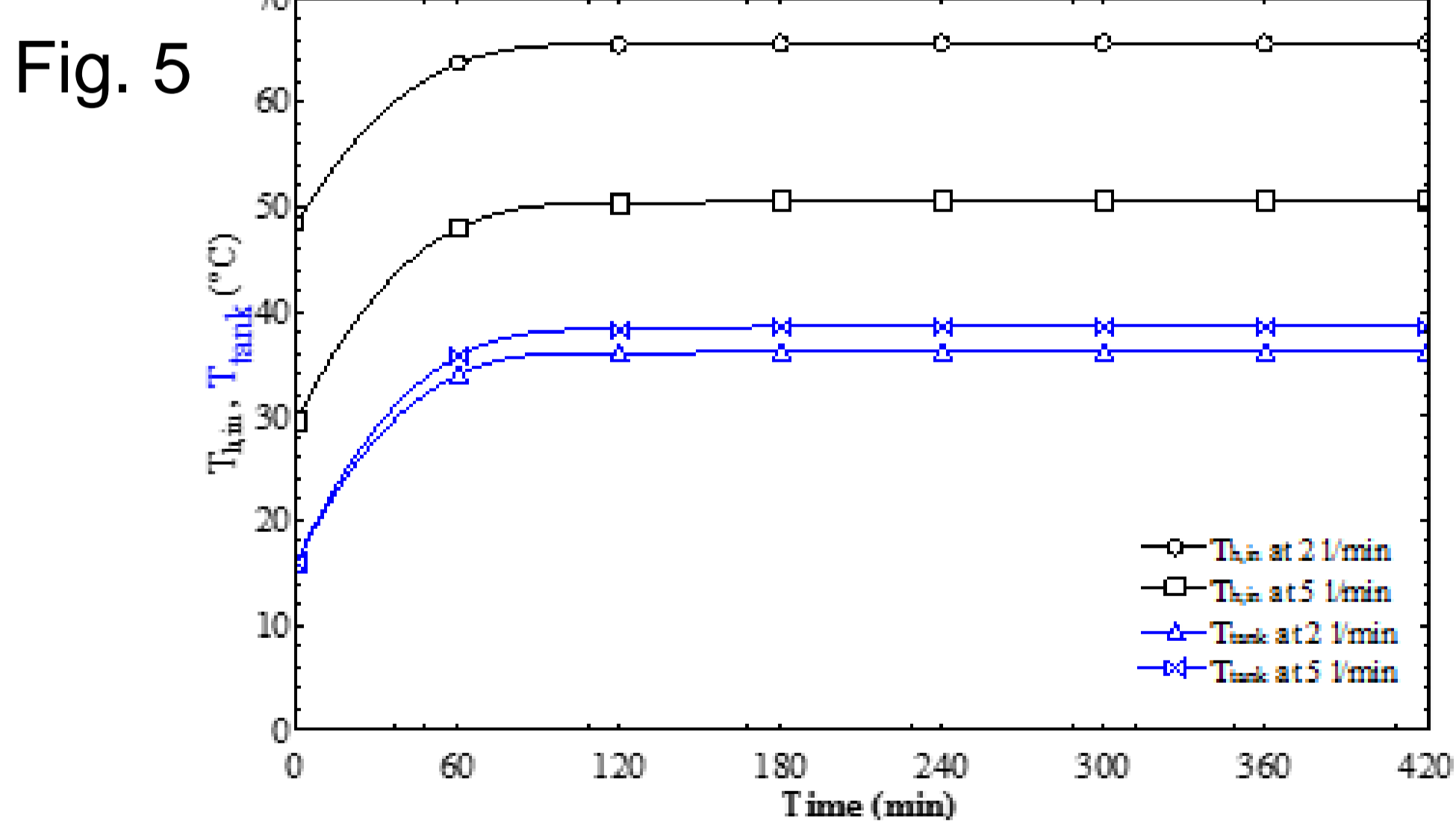
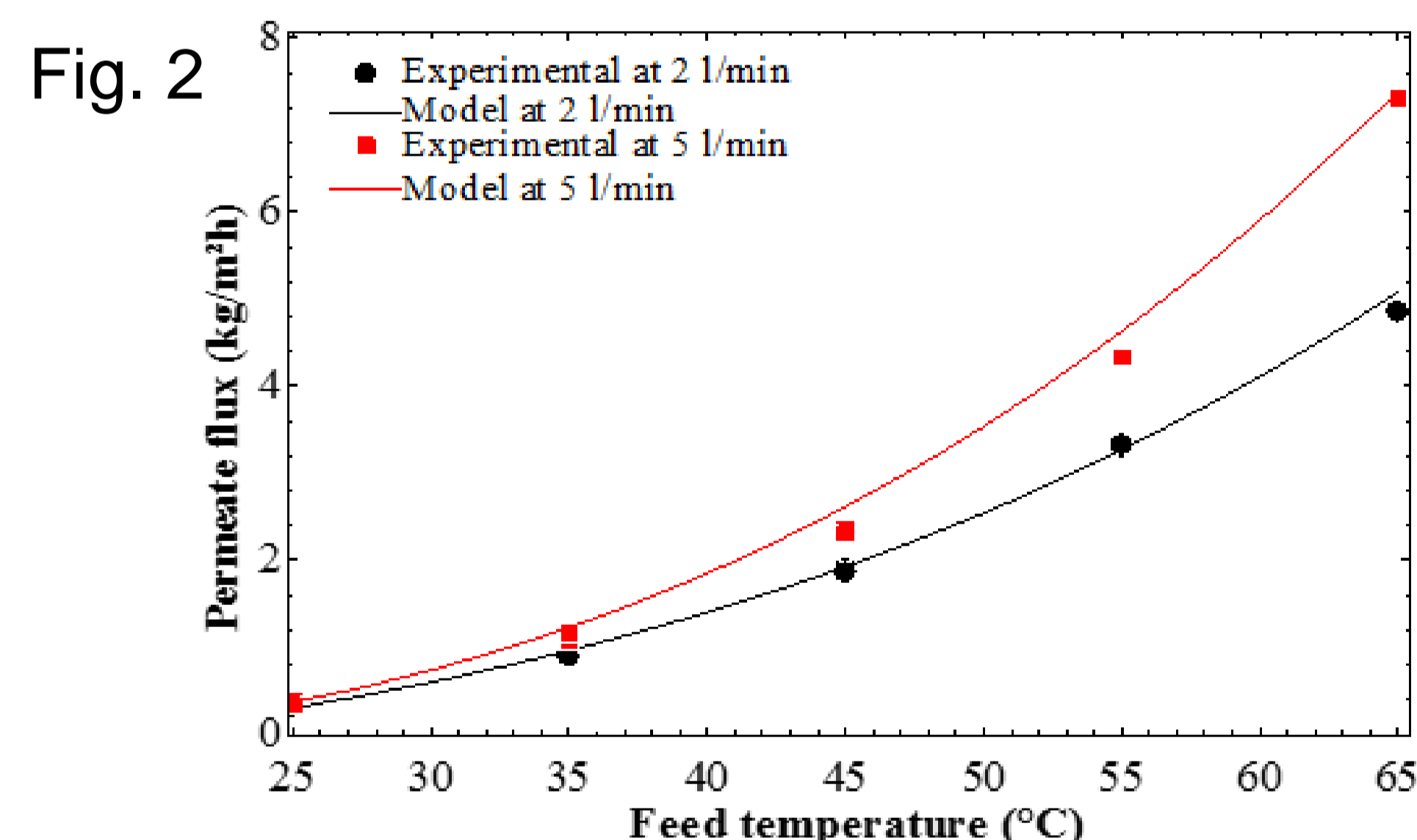

Fig. 1



Conclusions

- Fig. 3 shows that the permeate flux of the AGMD slightly decreases with time while the salt rejection rate remains greater than 99.9%.
- Fig. 4 shows that salinity increases during the same test as in Fig. 3.
- A low flow rate increases the $T_{h,in}$ while a high flow increases the T_{tank} (Fig. 5).
- The coupling shows that the permeate flux decreases despite the $T_{h,in}$ and T_{tank} , which results in an increase in the salt concentration (Fig. 6).
- GOR increases with a decrease in water flow and the effect of this decreases the COP (Fig. 7).