



HAL
open science

Anti-de Sitter strictly GHC-regular groups which are not lattices

Gye-Seon Lee, Ludovic Marquis

► **To cite this version:**

Gye-Seon Lee, Ludovic Marquis. Anti-de Sitter strictly GHC-regular groups which are not lattices. 2017. hal-01579212v1

HAL Id: hal-01579212

<https://hal.science/hal-01579212v1>

Preprint submitted on 30 Aug 2017 (v1), last revised 28 Feb 2018 (v2)

HAL is a multi-disciplinary open access archive for the deposit and dissemination of scientific research documents, whether they are published or not. The documents may come from teaching and research institutions in France or abroad, or from public or private research centers.

L'archive ouverte pluridisciplinaire **HAL**, est destinée au dépôt et à la diffusion de documents scientifiques de niveau recherche, publiés ou non, émanant des établissements d'enseignement et de recherche français ou étrangers, des laboratoires publics ou privés.

ANTI-DE SITTER STRICTLY GHC-REGULAR GROUPS WHICH ARE NOT LATTICES

GYE-SEON LEE AND LUDOVIC MARQUIS

ABSTRACT. For $d = 4, 5, 6, 7, 8$, we exhibit examples of $\text{AdS}^{d,1}$ strictly GHC-regular groups which are not quasi-isometric to the hyperbolic space \mathbb{H}^d , nor to any symmetric space. This provides a negative answer to Question 5.2 in [9A12] and disproves Conjecture 8.11 of Barbot–Mérigot [BM12].

We construct those examples using the Tits representation of well-chosen Coxeter groups. On the way, we give an alternative proof of Moussong’s hyperbolicity criterion [Mou88] for Coxeter groups built on Danciger–Guéritaud–Kassel [DGK17] and find examples of Coxeter groups W such that the space of strictly GHC-regular representations of W into $\text{PO}_{d,2}(\mathbb{R})$ up to conjugation is disconnected.

CONTENTS

1. Introduction	1
2. Coxeter groups and Davis complexes	5
3. Proof of Theorem B	7
4. Tits representations and Convex cocompactness	10
5. Topological actions of reflection groups	15
6. Proof of Theorems C and D	16
7. An alternative proof of Moussong’s criterion	18
8. Proof of Theorems E and F	18
Appendix A. The tables of the Coxeter groups	22
Appendix B. The spherical, affine and Lannér diagrams	26
References	27

1. INTRODUCTION

Let $\mathbb{R}^{d,e}$ be the vector space \mathbb{R}^{d+e} endowed with a non-degenerate symmetric bilinear form $\langle \cdot, \cdot \rangle_{d,e}$ of signature (d, e) , and let q be the associated quadratic form. A coordinate representation of q with respect to some basis of $\mathbb{R}^{d,e}$ is:

$$q(x) = x_1^2 + \cdots + x_d^2 - x_{d+1}^2 - \cdots - x_{d+e}^2$$

The $(d+e-1)$ -dimensional *pseudohyperbolic space* $\mathbb{H}^{d,e-1}$ is the quotient of the hyperquadric

$$\mathcal{Q} = \{x \in \mathbb{R}^{d,e} \mid q(x) = -1\}$$

2010 *Mathematics Subject Classification.* 22E40, 20F55, 20F65, 57M50, 20H10, 51F15.

Key words and phrases. Anti-de Sitter space, Anosov representation, Quasi-Fuchsian group, Coxeter group, Discrete subgroup of Lie group.

by the involution $x \mapsto -x$ and is endowed with the semi-Riemannian metric induced by the quadratic form q . It is a complete semi-Riemannian manifold of constant sectional curvature -1 . The isometry group of $\mathbb{H}^{d,e-1}$ is $\mathrm{PO}_{d,e}(\mathbb{R})$, and hence $\mathbb{H}^{d,e-1}$ may be identified with $\mathrm{PO}_{d,e}(\mathbb{R})/\mathrm{PO}_{d,e-1}(\mathbb{R})$. It will be more convenient for us to work with the projective model of $\mathbb{H}^{d,e-1}$, namely:

$$\mathbb{H}^{d,e-1} = \{[x] \in \mathbb{P}(\mathbb{R}^{d,e}) \mid q(x) < 0\}$$

In particular, for $e = 2$, the pseudohyperbolic space $\mathbb{H}^{d,e-1}$ is called the $(d+1)$ -dimensional *anti-de Sitter space* $\mathrm{AdS}^{d,1}$.

Let Γ be a finitely presented group. A representation $\rho : \Gamma \rightarrow \mathrm{PO}_{d,2}(\mathbb{R})$ is *strictly GHC-regular* if it is discrete, faithful and preserves an *acausal* (i.e. *negative*) subset¹ Λ_ρ in the boundary Ein^d of $\mathrm{AdS}^{d,1}$ such that Λ_ρ is homeomorphic to a $(d-1)$ -dimensional sphere and the action of Γ on the convex hull² of Λ_ρ in $\mathrm{AdS}^{d,1}$ is cocompact. An $\mathrm{AdS}^{d,1}$ *strictly GHC-regular group* (simply *strictly GHC-regular group*) is a subgroup of $\mathrm{PO}_{d,2}(\mathbb{R})$ which is the image of a strictly GHC-regular representation.

The first examples of strictly GHC-regular representations are *Fuchsian representations*. Namely, consider any uniform lattice Γ of $\mathrm{PO}_{d,1}(\mathbb{R})$, and let $\rho_0 : \Gamma \rightarrow \mathrm{PO}_{d,2}(\mathbb{R})$ be the restriction to Γ of the natural inclusion $\mathrm{PO}_{d,1}(\mathbb{R}) \hookrightarrow \mathrm{PO}_{d,2}(\mathbb{R})$ (and hence $\mathrm{PO}_{d,1}(\mathbb{R})$ corresponds to the stabilizer subgroup of $\mathrm{PO}_{d,2}(\mathbb{R})$ with respect to a point in $\mathrm{AdS}^{d,1}$). The representation ρ_0 is strictly GHC-regular and the convex hull of Λ_{ρ_0} is a copy of the hyperbolic d -space \mathbb{H}^d inside $\mathrm{AdS}^{d,1}$. Moreover, any small deformation $\rho_t : \Gamma \rightarrow \mathrm{PO}_{d,2}(\mathbb{R})$ of the representation ρ_0 is strictly GHC-regular (see Barbot–Mérigot [BM12]). Even more, Barbot [Bar15] proved that every representation $\rho : \Gamma \rightarrow \mathrm{PO}_{d,2}(\mathbb{R})$ in the connected component of $\mathrm{Hom}(\Gamma, \mathrm{PO}_{d,2}(\mathbb{R}))$ containing ρ_0 is strictly GHC-regular.

We will not use the following point of view, but we remark that strictly GHC-regular representations of torsion-free groups correspond to the holonomy of GHMC AdS manifolds (see Mess [Mes07] and Barbot [Bar08]). We quickly recall this terminology: An AdS manifold M is *globally hyperbolic spatially compact* (GHC) if it contains a compact *Cauchy hypersurface*, i.e. a space-like hypersurface S such that all inextendible time-like lines intersect S exactly once. It is *globally hyperbolic maximal compact* (GHMC) if in addition every isometric embedding of M into another GHC AdS manifold of the same dimension is an isometry.

Recently, Barbot–Mérigot [BM12] found an alternative description of $\mathrm{AdS}^{d,1}$ strictly GHC-regular group. In the case when Γ is isomorphic to the fundamental group of a closed, negatively curved Riemannian d -manifold, a representation $\rho : \Gamma \rightarrow \mathrm{PO}_{d,2}(\mathbb{R})$ is strictly GHC-regular if and only if it is $P_1^{d,2}$ -Anosov, where $P_1^{d,2}$ is the stabilizer subgroup of $\mathrm{PO}_{d,2}(\mathbb{R})$ with respect to an isotropic line of $\mathbb{R}^{d,2}$ (see Labourie [Lab06] or Guichard–Wienhard [GW12] for

¹We denote by $\partial\mathbb{H}^{d,e-1}$ the boundary of $\mathbb{H}^{d,e-1}$ in $\mathbb{P}(\mathbb{R}^{d,e})$. A subset Λ of $\partial\mathbb{H}^{d,e-1}$ is *negative* if it lifts to a cone of $\mathbb{R}^{d,e} \setminus \{0\}$ on which all inner products $\langle \cdot, \cdot \rangle_{d,e}$ of noncollinear points are negative. In the case $e = 2$, the boundary $\partial\mathbb{H}^{d,e-1} = \partial\mathrm{AdS}^{d,1}$ is called the *Einstein universe*, denoted Ein^d , and a negative subset of Ein^d is also called an *acausal* subset.

²In fact, the $\rho(\Gamma)$ -invariant subset Λ_ρ must be the limit set of $\rho(\Gamma)$, and the convex hull of Λ_ρ is well-defined because Λ_ρ is acausal.

more background on Anosov representations) and the limit set of $\rho(\Gamma)$ is a topological $(d-1)$ -sphere in the boundary Ein^d of $\text{AdS}^{d,1}$.

Very recently, Danciger–Guéritaud–Kassel [DGK17] introduced a notion of *convex cocompactness* in $\mathbb{H}^{d,e-1}$. A discrete subgroup Γ of $\text{PO}_{d,e}(\mathbb{R})$ is $\mathbb{H}^{d,e-1}$ -convex cocompact if it acts properly discontinuously and cocompactly on some closed properly convex³ subset \mathcal{C} of $\mathbb{H}^{d,e-1}$ with non-empty interior so that $\overline{\mathcal{C}} \setminus \mathcal{C}$ does not contain any non-trivial projective segment. A main result of [DGK17] is as follows: an irreducible discrete subgroup Γ of $\text{PO}_{d,e}(\mathbb{R})$ is $\mathbb{H}^{d,e-1}$ -convex cocompact if and only if Γ is Gromov-hyperbolic, the natural inclusion $\Gamma \hookrightarrow \text{PO}_{d,e}(\mathbb{R})$ is $P_1^{d,e}$ -Anosov, and the limit set Λ_Γ is negative.

In particular, for any discrete faithful representation $\rho : \Gamma \rightarrow \text{PO}_{d,2}(\mathbb{R})$, we have that ρ is strictly GHC-regular if and only if $\rho(\Gamma)$ is $\text{AdS}^{d,1}$ -convex cocompact (which imply that Γ is Gromov-hyperbolic) and the Gromov-boundary of Γ is homeomorphic to a $(d-1)$ -dimensional sphere.

In [9A12], the authors asked the following:

Question A (Question 5.2 of [9A12]). *Assume that $\rho : \Gamma \rightarrow \text{PO}_{d,2}(\mathbb{R})$ is a strictly GHC-regular representation. Is Γ isomorphic to a uniform lattice of $\text{PO}_{d,1}(\mathbb{R})$?*

The positive answer to this question was conjectured by Barbot and M erigot (see Conjecture 8.11 of [BM12]). In this paper, we give a negative answer to Question A.

Theorem A. *For $d = 4, 5, 6, 7, 8$, there exists an $\text{AdS}^{d,1}$ strictly GHC-regular group which is not isomorphic (even not quasi-isometric) to a uniform lattice in a semi-simple Lie group.*

The counterexamples are the Tits representation of well-chosen Coxeter groups. An important invariant of a Coxeter group W is *the signature* s_W of W . It means the signature of the Cosine matrix of W (see Section 2 for the basic terminology of Coxeter group). Recall that the signature of a symmetric matrix A is the triple (p, q, r) of the positive, negative and zero index of inertia of A .

The outline of the proof of Theorem A is as follows. First, observe that if the signature of a Coxeter group W is $(d, 2, 0)$, then the Tits representation ρ of W is a discrete faithful representation of W into $\text{PO}_{d,2}(\mathbb{R})$. Second, we prove Theorem 4.6 implying that if in addition W is Gromov-hyperbolic and the Coxeter diagram of W has no edge of label ∞ , then the representation $\rho : W \rightarrow \text{PO}_{d,2}(\mathbb{R})$ is $\text{AdS}^{d,1}$ -convex cocompact. Remark that Theorem 4.6 is a slight generalization of Theorem 8.2 of [DGK17]. Third, in order to prove that ρ is strictly GHC-regular, we need to check that the Gromov-boundary of W is a $(d-1)$ -dimensional sphere. Finally, the proof of Theorem A boils down to finding Coxeter groups satisfying the properties mentioned above.

Theorem B. *Every Coxeter group W in Tables 3, 4, 5, 6, 7 satisfies the following:*

- *the group W is Gromov-hyperbolic;*
- *the Gromov boundary ∂W of W is homeomorphic to a $(d-1)$ -sphere;*
- *the signature s_W of W is $(d, 2, 0)$.*

Here, d denotes the rank of W minus 2.

³A subset \mathcal{C} of $\mathbb{P}(\mathbb{R}^{d+e})$ is *properly convex* if its closure $\overline{\mathcal{C}}$ is contained and convex in some affine chart.

More precisely, we show the following:

Theorem C. *Let W be a Coxeter group in Tables 3, 4, 5, 6, 7. Then the Tits representation $\rho: W \rightarrow \mathrm{PO}_{d,2}(\mathbb{R})$ is strictly GHC-regular and the group W is not quasi-isometric to a uniform lattice of a semi-simple Lie group.*

Remark 1. With Selberg's lemma, Theorem C also allows us to obtain a finite index torsion-free subgroup Γ of W , and hence $\mathrm{AdS}^{d,1}/\rho(\Gamma)$ is a GHMC AdS manifold and Γ is not quasi-isometric to a uniform lattice of a semi-simple Lie group.

Remark 2. Recall that Cannon's conjecture claim that if Γ is a Gromov-hyperbolic group whose boundary is homeomorphic to \mathbb{S}^2 , then there exists a properly discontinuous, cocompact and isometric action of Γ on \mathbb{H}^3 . If Cannon's conjecture is true, then any $\mathrm{AdS}^{3,1}$ strictly GHC-regular group is isomorphic to a uniform lattice of $\mathrm{PO}_{3,1}(\mathbb{R})$. For Coxeter groups, the Cannon's conjecture is in fact known to be true (see Bourdon–Kleiner [BK13]).

Applying the same method as for Theorem B and Theorem C, we can prove:

Theorem D. *Let W be a Coxeter group in Table 8. Then the following hold:*

- *the group W is Gromov-hyperbolic;*
- *the Gromov boundary of W is homeomorphic to a 3-dimensional sphere;*
- *the signature of W is $(5, 1, 0)$;*
- *the Tits representation $\rho: W \rightarrow \mathrm{PO}_{5,1}(\mathbb{R})$ is quasi-Fuchsian;*
- *the group W is not quasi-isometric to a uniform lattice of a semi-simple Lie group.*

Here, a representation $\rho: \Gamma \rightarrow \mathrm{PO}_{d+1,1}(\mathbb{R})$ is called \mathbb{H}^d -quasi-Fuchsian (simply quasi-Fuchsian) if it is discrete and faithful, $\rho(\Gamma)$ is \mathbb{H}^d -convex cocompact and the Gromov boundary of Γ is homeomorphic to a $(d-1)$ -dimensional sphere.

We denote by $\mathrm{Hom}^s(\Gamma, \mathrm{PO}_{d,2}(\mathbb{R}))$ the space of strictly GHC-regular representations in $\mathrm{Hom}(\Gamma, \mathrm{PO}_{d,2}(\mathbb{R}))$ and by $\chi^s(\Gamma, \mathrm{PO}_{d,2}(\mathbb{R}))$ the space of strictly GHC-regular characters in the $\mathrm{PO}_{d,2}(\mathbb{R})$ -character variety of Γ . In [Bar15], Barbot asked the following:

Question B (Discussion after Theorem 1.5 of [Bar15]). *Assume that Γ is a lattice of $\mathrm{PO}_{d,1}(\mathbb{R})$. Is the space $\chi^s(\Gamma, \mathrm{PO}_{d,2}(\mathbb{R}))$ connected? In other words, does every strictly GHC-regular representation deform to a Fuchsian representation?*

It might be possible to extend Question B to the case when Γ is Gromov-hyperbolic.

Question C. *Let Γ be a Gromov-hyperbolic group. Assume that $\chi^s(\Gamma, \mathrm{PO}_{d,2}(\mathbb{R}))$ is non-empty. Is the space $\chi^s(\Gamma, \mathrm{PO}_{d,2}(\mathbb{R}))$ connected?*

The following theorem provides a negative answer to Question C.

Theorem E. *Let W be a Coxeter group in Tables 9 or 10, and let d be the rank of W minus 3. Then the space $\chi^s(W, \mathrm{PO}_{d,2}(\mathbb{R}))$ is disconnected.*

Similarly, we are able to prove:

Theorem F. *Let W be a Coxeter group in Tables 11 or 12, and let d be the rank of W minus 3. Then the space $\chi^q(W, \mathrm{PO}_{d+1,1}(\mathbb{R}))$ of quasi-Fuchsian characters in the $\mathrm{PO}_{d+1,1}(\mathbb{R})$ -character variety of W is disconnected.*

However, Question **B** is still an open problem.

Remark 3. Each Coxeter group W in Tables **9**, **10**, **11**, **12** is not quasi-isometric to \mathbb{H}^d even though it is a Gromov-hyperbolic group whose boundary is homeomorphic to \mathbb{S}^{d-1} .

In Section **7**, we also recover Moussong’s hyperbolicity criterion for Coxeter groups (see Theorem **3.4**) built on [DGK17].

Acknowledgments. We are thankful for helpful conversations with Ryan Greene, Olivier Guichard, Fanny Kassel and Anna Wienhard. We thank Daniel Monclair for introducing Question 5.2 in [9A12] to the second author a long time ago.

G.-S. Lee was supported by the European Research Council under ERC-Consolidator Grant 614733 and by DFG grant LE 3901/1-1 within the Priority Programme SPP 2026 “Geometry at Infinity”, and he acknowledges support from U.S. National Science Foundation grants DMS 1107452, 1107263, 1107367 “RNMS: Geometric structures And Representation varieties” (the GEAR Network).

2. COXETER GROUPS AND DAVIS COMPLEXES

A *pre-Coxeter system* is a pair (W, S) of a group W and a set S of elements of W of order 2 which generates W . A *Coxeter matrix* $M = (M_{st})_{s,t \in S}$ on a set S is a symmetric matrix with the entries $M_{st} \in \{1, 2, \dots, m, \dots, \infty\}$ such that the diagonal entries $M_{ss} = 1$ and others $M_{st} \neq 1$. For any pre-Coxeter system (W, S) , we have a Coxeter matrix M_W on S such that each entry $(M_W)_{st}$ of M_W is the order of st . To any Coxeter matrix $M = (M_{st})_{s,t \in S}$ is associated a presentation for a group \hat{W}_M : the set of generators for \hat{W}_M is S and the set of relations is $\{(st)^{M_{st}} = 1 \mid M_{st} \neq \infty\}$. A pre-Coxeter system (W, S) is called a *Coxeter system* if the surjective homomorphism $\hat{W}_{M_W} \rightarrow W$, defined by $s \mapsto s$, is an isomorphism. If this is the case, then W is a *Coxeter group* and S is a *fundamental set of generators*. We denote the Coxeter group W also by W_S or $W_{S,M}$ to indicate the fundamental set of generators or the Coxeter matrix of (W, S) . The *rank* of W_S is the cardinality $\#S$ of S .

The *Coxeter diagram* of $W_{S,M}$ is a labeled graph G_W such that (i) the set of nodes (i.e. vertices) of G_W is the set S ; (ii) two nodes $s, t \in S$ are connected by an edge \overline{st} of G_W if and only if $M_{st} \in \{3, \dots, m, \dots, \infty\}$; (iii) the label of the edge \overline{st} is M_{st} . It is customary to omit the label of the edge \overline{st} if $M_{st} = 3$. A Coxeter group W is *irreducible* if the Coxeter diagram G_W is connected. The *Cosine matrix* of $W_{S,M}$ is an $S \times S$ symmetric matrix C_W whose entries are:

$$(C_W)_{st} = -2 \cos\left(\frac{\pi}{M_{st}}\right) \quad \text{for every } s, t \in S$$

An irreducible Coxeter group W_S is *spherical* (resp. *affine* or *Lannér*) if for every $s \in S$, the (s, s) -minor of C_W is positive definite and the determinant $\det(C_W)$ of C_W is positive (resp. zero or negative). Remark that every irreducible Coxeter group W is spherical, affine or *large*, i.e. there is a surjective homomorphism of a finite index subgroup of W onto a free group of rank ≥ 2 (see Margulis–Vinberg [MV00]). For a Coxeter group W (not necessarily irreducible), each connected component of the Coxeter diagram G_W corresponds to a Coxeter group, called a *component* of the Coxeter group W . A Coxeter group W is *spherical* (resp. *affine*) if each component of W is spherical (resp. affine). We will often refer to Appendix **B** for the list of all the irreducible spherical, irreducible affine and Lannér Coxeter diagrams.

Let (W, S) be a Coxeter system. For each $T \subset S$, the subgroup W_T of W generated by T is called a *special subgroup* of W . It is well-known that (W_T, T) is a Coxeter system. A subset $T \subset S$ is said to be “something” if the Coxeter group W_T is “something”. For example, the word “something” can be replaced by “spherical”, “affine”, “Lannér” and so on. Two subsets $T, U \subset S$ are *orthogonal* if $M_{st} = 2$ for every $s \in T$ and every $t \in U$. This relationship is denoted $T \perp U$.

A *poset* is a partially ordered set. The *nerve* N_W of W is the poset of all non-empty spherical subsets of S partially ordered by inclusion. We remark that the nerve N_W is an abstract simplicial complex. Recall that an *abstract simplicial complex* \mathcal{S} is a pair (V, \mathcal{E}) of a set V , which we call the *vertex set* of \mathcal{S} , and a collection \mathcal{E} of (non-empty) finite subsets of V such that (i) for each $v \in V$, $\{v\} \in \mathcal{E}$; (ii) if $T \in \mathcal{E}$ and if $\emptyset \neq U \subset T$, then $U \in \mathcal{E}$. An element of \mathcal{E} is a *simplex* of \mathcal{S} , and the *dimension* of a simplex T is $\sharp T - 1$. The vertex set of the nerve N_W of a Coxeter group W_S is the set of generators S and a non-empty subset $T \subset S$ is a simplex of N_W if and only if T is spherical.

The *opposite* poset to a poset \mathcal{P} is the poset \mathcal{P}^{op} with the same underlying set and with the reversed order relation. Given a convex polytope P , let $\mathcal{F}(\partial P)$ denote the set of all non-empty faces of the boundary ∂P of P partially ordered by inclusion. A polytope P is *simplicial* (resp. *simple*) if $\mathcal{F}(\partial P)$ (resp. $\mathcal{F}(\partial P)^{op}$) is a simplicial complex.

Remark 2.1 (The nerve of a geometric reflection group, following Example 7.1.4 of [Dav08]). Let P be a simple convex polytope in $\mathbb{X} = \mathbb{R}^d$ or \mathbb{H}^d with dihedral angles integral submultiples of π . To the polytope P is associated a Coxeter matrix $M = (M_{st})_{s,t \in S}$ on a set S : (i) the set S consists of all facets⁴ of P ; (ii) for each pair of distinct facets s, t of P , if s, t are adjacent⁵ and if the dihedral angle between s and t is $\frac{\pi}{m_{st}}$, then we set $M_{st} = m_{st}$, and otherwise $M_{st} = \infty$. Let W_P be the reflection group generated by the set of reflections σ_s across the facets s of P . The homomorphism $\sigma : W_{S,M} \rightarrow W_P$ defined by $\sigma(s) = \sigma_s$ is an isomorphism by Poincaré’s polyhedron theorem, and hence the Coxeter group $W_{S,M}$ obtained in this way is called a *geometric reflection group*. Moreover, the nerve N_W of the Coxeter group $W_{S,M}$ identifies with the simplicial complex $\mathcal{F}(\partial P^*)$, where P^* is the dual polytope of P .

Inspired by the previous remark, we make the following:

Definition 2.2. A Coxeter group W is an *abstract geometric reflection group of dimension d* if the nerve N_W of W is isomorphic to the boundary complex $\mathcal{F}(\partial Q)$ of a simplicial d -polytope Q , or equivalently if the geometric realization of the nerve N_W of W is PL homeomorphic to a $(d - 1)$ -dimensional sphere.

A *spherical coset* of a Coxeter group W is a coset of a spherical special subgroup of W . We denote by WS the set of all spherical cosets of W , i.e.

$$WS = \bigcup_{T \in N_W \cup \{\emptyset\}} W/W_T$$

It is partially ordered by inclusion. To any poset \mathcal{P} is associated an abstract simplicial complex $\text{Flag}(\mathcal{P})$ consisting of all non-empty, finite, totally ordered subsets of \mathcal{P} . The geometric realization of $\text{Flag}(WS)$ is called the *Davis complex* Σ_W of W .

⁴A *facet* of a convex polytope P is a face of codimension 1.

⁵Two facets s, t of P are *adjacent* if the intersection of s and t is a face of codimension 2.

Theorem 2.3 (Moussong [Mou88], Stone [Sto76], Davis–Januszkiewicz [DJ91]). *If a Coxeter group W is an abstract geometric reflection group of dimension d , then the following hold:*

- *the Davis complex Σ_W of W admits a natural CAT(0)-metric;*
- *the cell complex Σ_W is homeomorphic to \mathbb{R}^d ;*
- *the CAT(0) boundary of Σ_W is homeomorphic to \mathbb{S}^{d-1} .*

Sketch of the proof. For the reader’s convenience, we outline the important steps of the proof as in the book [Dav08] and refer to the relevant theorems in [Dav08].

Moussong showed that the Davis complex Σ_W equipped with its natural piecewise Euclidean structure is CAT(0) (see Theorem 12.3.3), and hence Σ_W is contractible (see also Theorem 8.2.13). Since the (geometric realization of) nerve of W is PL homeomorphic to a $(d-1)$ -dimensional sphere, Σ_W is a PL d -manifold (see Theorem 10.6.1). Therefore, the cell complex Σ_W is a simply connected, nonpositively curved, piecewise Euclidean, PL manifold. By Stone’s theorem [Sto76], Σ_W is homeomorphic to \mathbb{R}^d and moreover by Davis–Januszkiewicz’s theorem, the boundary of Σ_W is a $(d-1)$ -sphere (see Theorem I.8.4). \square

3. PROOF OF THEOREM B

Proposition 3.1. *Let (W, S) be a Coxeter system with Coxeter diagram G_W in Tables 3, 4, 5, 6, 7, 8 and let d be the rank of W_S minus 2. Then W_S is an abstract geometric reflection group of dimension d .*

Proof. Let S_1 be the set of white nodes of G_W and S_2 the set of black nodes of G_W . First, observe that:

- the special subgroups W_{S_1} and W_{S_2} are Lannér;
- the special subgroup W_T with $T \subset S$ is spherical if and only if there exist $s_1 \in S_1$ and $s_2 \in S_2$ such that $T \subset (S_1 \setminus \{s_1\}) \cup (S_2 \setminus \{s_2\}) = S \setminus \{s_1, s_2\}$.

It therefore follows that the nerve N_W of W is isomorphic to the nerve of the Coxeter group $W_{S_1} \times W_{S_2}$ (as a poset). In other words, the nerve N_W is isomorphic to the join of N_1 and N_2 , where N_i denotes the nerve of W_{S_i} for each $i \in \{1, 2\}$.

Moreover, since W_{S_i} is Lannér, its nerve N_i is isomorphic to $\mathcal{F}(\partial\Delta_i)$ where Δ_i is the simplex of dimension $n_i = \#S_i - 1$, and in particular it is a simplicial complex whose geometric realization is a $(n_i - 1)$ -dimensional sphere. Finally, since the join of the n -sphere and the m -sphere is the $(n + m + 1)$ -sphere, the geometric realization of the nerve N_W is a $(d - 1)$ -dimensional sphere (recall that $d = n_1 + n_2$). \square

Remark 3.2. The proof of Proposition 3.1 is essentially the same as in Example 12.6.8 of [Dav08] (see also Section 18 of Moussong [Mou88]).

Corollary 3.3. *In the setting of Proposition 3.1, the Coxeter group W is Gromov-hyperbolic and the Gromov boundary of W is a $(d - 1)$ -dimensional sphere.*

Proof. First, we know from Theorem 2.3 that the Davis complex Σ_W of W is a CAT(0) space homeomorphic to \mathbb{R}^d and that the CAT(0) boundary of W is homeomorphic to \mathbb{S}^{d-1} . Second, it is easy to verify that the Coxeter group W is Gromov-hyperbolic using Moussong’s hyperbolicity criterion (see Theorem 3.4). Finally, since the action of W on Σ_W is proper and cocompact, we have that W is quasi-isometric to Σ_W and the Gromov boundary of W identifies to the CAT(0) boundary of Σ_W . \square

Theorem 3.4 (Moussong's hyperbolicity criterion [Mou88]). *Assume that W_S is a Coxeter group. Then the group W_S is Gromov-hyperbolic if and only if S does not contain any affine subset of rank ≥ 3 nor two orthogonal non-spherical subsets.*

In order to complete Theorem B, it remains to show the following:

Proposition 3.5. *In the setting of Proposition 3.1, the signature of W is $(d, 2, 0)$.*

Proof. The Coxeter group W contains a spherical special subgroup of rank d and a Lannér special subgroup. For example, if the Coxeter diagram G_W of W is the diagram (A) in Figure 1, then the diagram (B) corresponds to a spherical Coxeter group $B_3 \times I_2(p)$ (see Table 13) and the diagram (C) corresponds to a Lannér Coxeter group in Table 15.

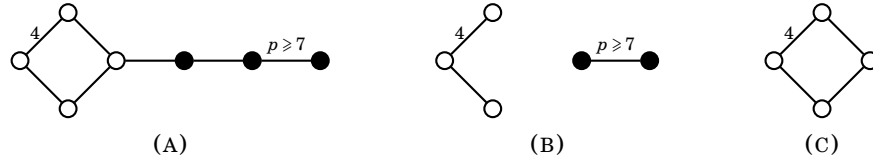
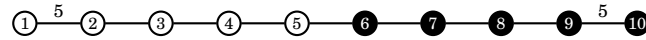

FIGURE 1. A Coxeter group W in Table 4 and two special subgroups of W

Since the signature of any spherical (resp. Lannér) Coxeter group of rank r is $(r, 0, 0)$ (resp. $(r - 1, 1, 0)$), the signature s_W of W can only be $(d, 2, 0)$, $(d, 1, 1)$ or $(d + 1, 1, 0)$, and hence s_W is determined by the sign of the determinant $\det(C_W)$ of C_W . More precisely, the signature s_W is $(d, 2, 0)$, $(d, 1, 1)$ and $(d + 1, 1, 0)$ if $\det(C_W) > 0$, $= 0$ and < 0 , respectively.

Now we check carefully the sign of $\det(C_W)$ in the decreasing order of dimension d .

In the case when $d = 8$ or 7 (see Tables 7 or 6), a simple computation shows that $\det(C_W)$ is positive. For example, if the Coxeter diagram G_W of W is:



then the Cosine matrix C_W is:

$$\begin{pmatrix} 2 & -c_5 & 0 & 0 & 0 & 0 & 0 & 0 & 0 & 0 \\ -c_5 & 2 & -c_3 & 0 & 0 & 0 & 0 & 0 & 0 & 0 \\ 0 & -c_3 & 2 & -c_3 & 0 & 0 & 0 & 0 & 0 & 0 \\ 0 & 0 & -c_3 & 2 & -c_3 & 0 & 0 & 0 & 0 & 0 \\ 0 & 0 & 0 & -c_3 & 2 & -c_3 & 0 & 0 & 0 & 0 \\ 0 & 0 & 0 & 0 & -c_3 & 2 & -c_3 & 0 & 0 & 0 \\ 0 & 0 & 0 & 0 & 0 & -c_3 & 2 & -c_3 & 0 & 0 \\ 0 & 0 & 0 & 0 & 0 & 0 & -c_3 & 2 & -c_3 & 0 \\ 0 & 0 & 0 & 0 & 0 & 0 & 0 & -c_3 & 2 & -c_5 \\ 0 & 0 & 0 & 0 & 0 & 0 & 0 & 0 & -c_5 & 2 \end{pmatrix}$$

where $c_m = 2 \cos(\frac{\pi}{m})$, and the determinant of C_W is $\frac{1}{2}(25 - 11\sqrt{5}) \approx 0.201626$.

In the case when $d = 6, 5, 4$ (see Tables 5, 4, 3), there are one parameter family $(W_p)_p$ or two parameters family $(W_{p,q})_{p,q}$ of Coxeter groups for each item of the Tables. The following Lemma 3.6 shows that the determinant of the Cosine matrix increases when the parameter increases. Here, the (partial) order on the set of two parameters (p, q) is given by:

$$(p', q') \geq (p'', q'') \Leftrightarrow p' \geq p'' \quad \text{and} \quad q' \geq q''$$

By an easy but long computation, we have $\det(C_{W_p})$ (resp. $\det(C_{W_{p,q}})$) is positive for every minimal element p (resp. (p,q)) in the set of parameters. For example, if the Coxeter diagram G_{W_p} of W_p is:

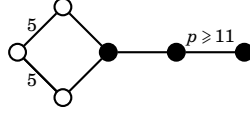

then the determinant of C_{W_p} is equal to $-4(3 + \sqrt{5}) + 8(1 + \sqrt{5}) \cos\left(\frac{2\pi}{p}\right) \approx 0.834557$ for $p = 11$. Remark that if $p = 10$, then $\det(C_{W_p}) = 0$ and hence W_p is the geometric reflection group of a compact hyperbolic 4-polytope with 6 facets (see Esselmann [Ess96]). \square

Lemma 3.6. *If $(W_p)_p$ is a one parameter family of Coxeter groups in Tables 3, 4, 5, then $(\det(C_{W_p}))_p$ is an increasing sequence and its limit is a positive number. Similarly, if $(W_{p,q})_{p,q}$ is a two parameters family of Coxeter groups in Table 3, then $(\det(C_{W_{p,q}}))_{p,q}$ is also an increasing sequence and its limit is a positive number.*

Proof. We only prove it for $(W_p)_p$; the argument is similar for $(W_{p,q})_{p,q}$. Denote W_p by $W_{S,M}$ (simply W_S). Let S_1 (resp. S_2) be the set of all white (resp. black) nodes of the Coxeter diagram G_{W_S} .

Assume first that there is a unique edge \overline{st} between S_1 and S_2 in G_{W_S} such that $s \in S_1$ and $t \in S_2$.⁶ By Proposition 13 of Vinberg [Vin84], we have:

$$\frac{\det(C_{W_S})}{\det(C_{W_{S \setminus \{s,t\}}})} = \frac{\det(C_{W_{S_1}})}{\det(C_{W_{S_1 \setminus \{s\}}})} \cdot \frac{\det(C_{W_{S_2}})}{\det(C_{W_{S_2 \setminus \{t\}}})} - 4 \cos^2\left(\frac{\pi}{M_{st}}\right)$$

which is equivalent to:

$$\det(C_{W_S}) = \det(C_{W_{S_1}}) \det(C_{W_{S_2}}) - 4 \det(C_{W_{S_1 \setminus \{s\}}}) \det(C_{W_{S_2 \setminus \{t\}}}) \cos^2\left(\frac{\pi}{M_{st}}\right)$$

Moreover, it is easy to see the following:

- the numbers $-\det(C_{W_{S_1}})$ and $\det(C_{W_{S_1 \setminus \{s\}}})$ are positive because W_{S_1} is Lannér;
- the sequence $p \mapsto -\det(C_{W_{S_2}})$ is positive and increasing to a positive number;
- the sequence $p \mapsto \det(C_{W_{S_2 \setminus \{t\}}})$ is positive and decreasing to zero.

Hence, the sequence $p \mapsto \det(C_{W_S})$ is increasing and converges to a positive number.

Now assume that there are two edges \overline{rt} and \overline{st} between S_1 and S_2 in G_{W_S} such that $r, s \in S_1$ and $t \in S_2$.⁷ By Proposition 12 of Vinberg [Vin84], we have:

$$\frac{\det(C_{W_S})}{\det(C_{W_{S \setminus \{t\}}})} - 2 = \left(\frac{\det(C_{W_{S_1 \cup \{t\}}})}{\det(C_{W_{S_1}})} - 2 \right) + \left(\frac{\det(C_{W_{S_2}})}{\det(C_{W_{S_2 \setminus \{t\}}})} - 2 \right)$$

which is equivalent to

$$\det(C_{W_S}) = \det(C_{W_{S_1}}) \det(C_{W_{S_2}}) + \det(C_{W_{S_1}}) \det(C_{W_{S_2 \setminus \{t\}}}) \left(\frac{\det(C_{W_{S_1 \cup \{t\}}})}{\det(C_{W_{S_1}})} - 2 \right)$$

⁶In practice, it means that G_{W_S} does not belong to the last row of Table 3.

⁷In other words, G_{W_S} belongs to the last row of Table 3.

Furthermore, it is easy to see (cf. Table 2 of Esselmann [Ess96]) that

$$\frac{\det(C_{W_{S_1 \cup \{t\}}})}{\det(C_{W_{S_1}})} = \begin{cases} \frac{5+2\sqrt{5}+3\sqrt{2}+\sqrt{10}}{2} & \text{if } G_{W_{S_1 \cup \{t\}}} \text{ is the left diagram in Figure 2;} \\ 3 + \sqrt{5} & \text{if } G_{W_{S_1 \cup \{t\}}} \text{ is the right diagram in Figure 2.} \end{cases}$$



FIGURE 2. Two possible Coxeter diagrams of $W_{S_1 \cup \{t\}}$

Hence, the sequence $p \mapsto \det(C_{W_S})$ is increasing and converges to a positive number. \square

Similarly, by an easy computation, we can prove:

Proposition 3.7. *Let (W, S) be a Coxeter system with Coxeter diagram G_W in Table 8. Then the signature of W_S is $(5, 1, 0)$.*

4. TITS REPRESENTATIONS AND CONVEX COCOMPACTNESS

4.1. Cartan matrices and Coxeter groups. An $n \times n$ matrix $A = (A_{ij})_{i,j=1,\dots,n}$ is called a *Cartan matrix* if the following hold:

- for all $i = 1, \dots, n$, $A_{ii} = 2$, and for all $i \neq j$, $A_{ij} \leq 0$, and $A_{ij} = 0 \Leftrightarrow A_{ji} = 0$;
- for all $i \neq j$, $A_{ij}A_{ji} \geq 4$ or $A_{ij}A_{ji} = 4 \cos^2\left(\frac{\pi}{m_{ij}}\right)$ with some $m_{ij} \in \mathbb{N} \setminus \{0, 1\}$.

A Cartan matrix A is *reducible* if (after a simultaneous permutation of rows and columns) A is the direct sum of smaller matrices. Otherwise, A is *irreducible*. It is obvious that every Cartan matrix A is the direct sum of irreducible matrices $A_1 \oplus \dots \oplus A_k$. Each irreducible matrix A_i , $i = 1, \dots, k$, is called a *component* of A . If $x = (x_1, \dots, x_n)$ and $y = (y_1, \dots, y_n) \in \mathbb{R}^n$, we write $x > y$ if $x_i > y_i$ for every i , and $x \geq y$ if $x_i \geq y_i$ for every i .

Proposition 4.1 (Theorem 3 of Vinberg [Vin71]). *If A is an irreducible Cartan matrix of size $n \times n$, then exactly one of the following holds:*

- (P) *The matrix A is nonsingular; for every vector $x \in \mathbb{R}^n$, if $Ax \geq 0$, then $x > 0$ or $x = 0$.*
- (Z) *The rank of A is $n - 1$; there exists a vector $y \in \mathbb{R}^n$ such that $y > 0$ and $Ay = 0$; for every vector $x \in \mathbb{R}^n$, if $Ax \geq 0$, then $Ax = 0$.*
- (N) *There exists a vector $y \in \mathbb{R}^n$ such that $y > 0$ and $Ay < 0$; for every vector $x \in \mathbb{R}^n$, if $Ax \geq 0$ and $x \geq 0$, then $x = 0$.*

We say that A is of *positive*, *zero* or *negative* type if (P), (Z) or (N) holds, respectively.

A Cartan matrix A is of *positive* (resp. *zero*) type if every component of A is of positive (resp. zero) type.

Corollary 4.2. *Let A be a Cartan matrix (not necessarily irreducible). If there exists a vector $x > 0$ such that $Ax = 0$, then A is of zero type.*

A Cartan matrix $A = (A_{st})_{s,t \in S}$ is *compatible* with a Coxeter group $W_{S,M}$ if for every $s \neq t \in S$, $A_{st}A_{ts} = 4 \cos^2\left(\frac{\pi}{M_{st}}\right)$ if $M_{st} < \infty$, and $A_{st}A_{ts} \geq 4$ otherwise. For any Coxeter group W , the Cosine matrix C_W of W is in fact compatible with W .

Proposition 4.3 (Propositions 22 and 23 of Vinberg [Vin71]). *Assume that a Cartan matrix A is compatible with a Coxeter group W . Then the following hold:*

- (1) *the matrix A is of positive type if and only if W is spherical;*
- (2) *if A is of zero type, then W is affine;*
- (3) *conversely, if $A = C_W$ and W is affine, then A is of zero type.*

4.2. Coxeter polytopes. Let V be a vector space over \mathbb{R} , and let $\mathbb{S}(V)$ be the projective sphere, i.e. the space of half-lines in V . We denote by $\mathrm{SL}^\pm(V)$ the group of automorphisms of $\mathbb{S}(V)$, i.e. $\mathrm{SL}^\pm(V) = \{X \in \mathrm{GL}(V) \mid \det(X) = \pm 1\}$. The projective sphere $\mathbb{S}(V)$ and the group $\mathrm{SL}^\pm(V)$ are double covers of the projective space $\mathbb{P}(V)$ and the group of projective transformations $\mathrm{PGL}(V)$, respectively.

We denote by \mathbb{S} the natural projection of $V \setminus \{0\}$ onto $\mathbb{S}(V)$. For each subspace U of V , $\mathbb{S}(U)$ denotes $\mathbb{S}(U \setminus \{0\})$ for the simplicity of the notation. A subset \mathcal{C} of $\mathbb{S}(V)$ is *convex* if for every 2-dimensional subspace U of V , $\mathcal{C} \cap \mathbb{S}(U)$ is connected, and \mathcal{C} is *properly convex* if in addition its closure $\overline{\mathcal{C}}$ does not contain a pair of antipodal points. In other words, \mathcal{C} is properly convex if and only if $\overline{\mathcal{C}}$ is contained and convex in some affine chart. Note that if \mathcal{C} is a properly convex subset of $\mathbb{S}(V)$, then the subgroup $\mathrm{SL}^\pm(\mathcal{C})$ of $\mathrm{SL}^\pm(V)$ preserving \mathcal{C} is naturally isomorphic to a subgroup of $\mathrm{PGL}(V)$.

A *projective polytope* is a properly convex subset P of $\mathbb{S}(V)$ such that P has a non-empty interior and $P = \bigcap_{i=1}^n \mathbb{S}(\{x \in V \mid \alpha_i(x) \leq 0\})$, where α_i , $i = 1, \dots, n$, are linear forms on V . We always assume that the set of linear forms is *minimal*, i.e. none of the half spaces $\mathbb{S}(\{x \in V \mid \alpha_i(x) \leq 0\})$ contains the intersection of all the others. A *projective reflection* is an element of $\mathrm{SL}^\pm(V)$ of order 2 which is the identity on a hyperplane. Every projective reflection σ can be written as:

$$\sigma = \mathrm{Id} - \alpha \otimes b$$

where α is a linear form on V and b is a vector of V such that $\alpha(b) = 2$.

A *pre-Coxeter polytope* is a pair of a projective polytope P of $\mathbb{S}(V)$:

$$P = \bigcap_{s \in S} \mathbb{S}(\{x \in V \mid \alpha_s(x) \leq 0\})$$

and a set of projective reflections $(\sigma_s = \mathrm{Id} - \alpha_s \otimes b_s)_{s \in S}$ with $\alpha_s(b_s) = 2$. A pre-Coxeter polytope is called a *Coxeter polytope* if

$$\gamma \overset{\circ}{P} \cap \overset{\circ}{P} = \emptyset \quad \text{for every } \gamma \in \Gamma_P \setminus \{\mathrm{Id}\}$$

where $\overset{\circ}{P}$ is the interior of P and Γ_P is the subgroup of $\mathrm{SL}^\pm(V)$ generated by the reflections $(\sigma_s)_{s \in S}$. If this is the case, then Γ_P is a *projective Coxeter group* generated by reflections $(\sigma_s)_{s \in S}$. In [Vin71], Vinberg showed that a pre-Coxeter polytope $(P, (\sigma_s = \mathrm{Id} - \alpha_s \otimes b_s)_{s \in S})$ is a Coxeter polytope if and only if the matrix $A = (\alpha_s(b_t))_{s, t \in S}$ is a Cartan matrix. We often denote the Coxeter polytope simply by P , and we call A the *Cartan matrix* of the Coxeter polytope P .

For any Coxeter polytope P , there is a unique Coxeter group, denoted W_P , compatible with the Cartan matrix of P . If q is a subset of P , then we set $S_q = \{s \in S \mid q \subset s\}$.

Theorem 4.4 (Tits, Chapter V of [Bou68], and Theorem 2 of Vinberg [Vin71]). *Let P be a Coxeter polytope of $\mathbb{S}(V)$ with Coxeter group W_P , and let Γ_P be the group generated by the projective reflections $(\sigma_s)_{s \in S}$. Then the following hold:*

- (1) *the homomorphism $\sigma : W_P \rightarrow \mathrm{SL}^\pm(V)$ defined by $\sigma(s) = \sigma_s$ is well-defined and is an isomorphism onto Γ_P , which is a discrete subgroup of $\mathrm{SL}^\pm(V)$;*
- (2) *the union of the Γ_P -orbit of P is a convex subset \mathcal{C}_P of $\mathbb{S}(V)$;*
- (3) *if Ω_P is the interior of \mathcal{C}_P , then the Γ_P -orbit of $P \cap \Omega_P$ is a tiling of Ω_P ;*
- (4) *for each point $x \in P$, the subgroup $\sigma(W_{S_x})$ is the stabilizer of x in Γ_P ;*
- (5) *an open face f of P lies in Ω_P if and only if the Coxeter group W_{S_f} is finite;*
- (6) *the discrete group Γ_P acts properly discontinuously on Ω_P .*

4.3. Tits representations. To a Cartan matrix $A = (A_{st})_{s,t \in S}$ is associated a Coxeter simplex Δ_A of $\mathbb{S}(\mathbb{R}^S)$ as follows:

- for each $t \in S$, we set $\tilde{\alpha}_t = e_t^*$, where $(e_t^*)_{t \in S}$ is the canonical dual basis of \mathbb{R}^S ;
- for each $t \in S$, we take the unique vector $\tilde{b}_t \in \mathbb{R}^S$ such that $\tilde{\alpha}_s(\tilde{b}_t) = A_{st}$ for all $s \in S$;
- the Coxeter simplex Δ_A is the pair of the projective simplex $\cap_{s \in S} \mathbb{S}(\{x \in \mathbb{R}^S \mid \tilde{\alpha}_s(x) \leq 0\})$ and the set of reflections $(\tilde{\sigma}_s = \mathrm{Id} - \tilde{\alpha}_s \otimes \tilde{b}_s)_{s \in S}$.

We let W_A denote the unique Coxeter group compatible with A . Then Theorem 4.4 provides the discrete faithful representation $\tilde{\sigma}_A : W_A \rightarrow \mathrm{SL}^\pm(\mathbb{R}^S)$ whose image $\tilde{\Gamma}_A = \tilde{\sigma}_A(W_A)$ is the group generated by the reflections $(\tilde{\sigma}_s)_{s \in S}$.

Assume now that none of the components of A is of zero type. We let V_A denote the linear span of $(\tilde{b}_s)_{s \in S}$. For each $s \in S$, we set $\alpha_s = \tilde{\alpha}_s|_{V_A}$, the restriction of $\tilde{\alpha}_s$ to V_A , and $b_s = \tilde{b}_s$. By Proposition 13 of Vinberg [Vin71], the convex subset

$$P_A = \bigcap_{s \in S} \mathbb{S}(\{x \in V_A \mid \alpha_s(x) \leq 0\})$$

of $\mathbb{S}(V_A)$ has a non-empty interior. Moreover, since $\dim(V_A) = \mathrm{rank}(A)$, the subset P_A is properly convex by Proposition 18 of Vinberg [Vin71]. In other words, P_A is a projective polytope of $\mathbb{S}(V_A)$ (cf. Corollary 1 of [Vin71]). We denote by P_A^* the convex hull of $(b_s)_{s \in S}$ in $\mathbb{S}(V_A)$. The projective polytope P_A of $\mathbb{S}(V_A)$ together with the reflections $(\sigma_s = \mathrm{Id} - \alpha_s \otimes b_s)_{s \in S}$ is a Coxeter polytope, denoted again P_A , and Theorem 4.4 provides the discrete faithful representation $\sigma_A : W_A \rightarrow \mathrm{SL}^\pm(V_A)$ whose image $\Gamma_A = \sigma_A(W_A)$ is the group generated by the reflections $(\sigma_s)_{s \in S}$.

Assume in addition that A is symmetric. By Theorem 6 of Vinberg [Vin71], there exists a Γ_A -invariant scalar product B_A on V_A such that $B_A(b_s, b_t) = A_{st}$ for every $s, t \in S$, i.e. $\alpha_s = B_A(b_s, \cdot)$ for all $s \in S$. Thus, the group Γ_A is a subgroup of the orthogonal group $\mathrm{O}(B_A)$ of the non-degenerate scalar product B_A on V_A , and preserves the *negative open set* of A :

$$O_A^\ell = \mathbb{S}(\{x \in V_A \mid B_A(x, x) < 0\})$$

Note that if the signature of A is (p, q, r) , then B_A is of signature (p, q) and $\mathrm{O}(B_A)$ is naturally isomorphic to $\mathrm{O}_{p,q}(\mathbb{R})$.

For any Coxeter group W_S , the Cosine matrix C_W of W_S is a symmetric Cartan matrix compatible with W_S , and hence if C_W has no component of zero type, there exists the representation $\sigma_{C_W} : W_S \rightarrow O(B_{C_W})$, which we call the *Tits–Vinberg representation* (simply *Tits representation*) of W_S .

Remark 4.5. The representation $\tilde{\sigma}_{C_W} : W \rightarrow \mathrm{SL}^\pm(\mathbb{R}^S)$ exists without any condition on C_W , and it is in fact conjugate to a representation of W introduced by Tits (see Chapter V of [Bou68]). However, if C_W is nonsingular, then C_W has no component of zero type, $V_{C_W} = \mathbb{R}^S$ and the representation $\sigma_{C_W} : W \rightarrow \mathrm{SL}^\pm(V_{C_W})$ is conjugate to $\tilde{\sigma}_{C_W} : W \rightarrow \mathrm{SL}^\pm(\mathbb{R}^S)$, i.e. the representations of W , σ_{C_W} and $\tilde{\sigma}_{C_W}$, are essentially the same.

4.4. Two Lemmas. In this section, we use the same notation as in Section 4.3 and prove Theorem 4.6, which is a generalization of Theorem 8.2 of Danciger–Guéritaud–Kassel [DGK17]. For any subset $U \subset S$, if X is an $S \times S$ matrix or a vector of \mathbb{R}^S , then X_U denotes the restriction of X to $U \times U$ or U , respectively.

Theorem 4.6. *Let $A = (A_{st})_{s,t \in S}$ be a symmetric Cartan matrix of signature (p, q, r) , and let W_A be the Coxeter group compatible with A . Assume that the following conditions are satisfied:*

- (H₀) *for every subset T of S , the matrix A_T is not of zero type;*
- (H₋) *there is no pair of orthogonal subsets U, T of S such that A_U and A_T are of negative type.*

Then the subgroup $\Gamma_A = \sigma_A(W_A)$ of $O(B_A) \simeq O_{p,q}(\mathbb{R})$ is $\mathbb{H}^{p,q-1}$ -convex cocompact.

Proof. In the paper [DGK17], the authors prove the Theorem in the case of right-angled Coxeter groups. The key lemmas, Lemmas 8.5 and 8.6 of [DGK17], of the proof are generalized to arbitrary Coxeter groups in Lemmas 4.7 and 4.8, and the rest of the proof is the same as in the proof of Theorem 8.2 of [DGK17]. \square

Lemma 4.7. *Let A be a symmetric Cartan matrix and O_A^ℓ the negative open set of A . Assume that A has no component of zero type. Then the matrix A satisfies (H₀) if and only if $P_A \cap P_A^* \subset O_A^\ell$.*

Proof. In the proof, the subscript A is omitted from the notation for simplicity. Assume A satisfies (H₀) and take $x \in P \cap P^*$. By definition, we have:

$$B(b_s, x) \leq 0 \quad \text{for every } s \in S \quad \text{and} \quad x = \sum_{s \in S} c_s b_s \quad \text{for some } c = (c_s)_{s \in S} \geq 0$$

which imply that:

$$B(x, x) = \sum_{s \in S} c_s B(b_s, x) \leq 0$$

and the equality holds if and only if $c_s B(b_s, x) = 0$ for all $s \in S$. Thus, $x \in \overline{O^\ell}$. Suppose by contradiction that $x \in \partial O^\ell$, i.e. $B(x, x) = 0$. If $S^>$ denotes $\{s \in S \mid c_s > 0\}$, then:

$$\begin{aligned} B(b_s, x) &= 0 \quad \forall s \in S^> \\ \sum_{t \in S^>} c_t B(b_s, b_t) &= 0 \quad \forall s \in S^> \\ A_{S^>} \cdot c_{S^>} &= 0 \end{aligned}$$

Therefore, we conclude by Corollary 4.2 that $A_{S^>}$ is of zero type, which contradicts the condition (H_0) .

To prove the converse we suppose by contradiction that there is a subset $U \subset S$ such that A_U is of zero type. Then there exists a vector $c = (c_s)_{s \in U} > 0$ such that $A_U \cdot c = 0$ by Proposition 4.1. Let $x = \sum_{s \in U} c_s b_s$. Now it is easy to see that $x \in P \cap P^*$ and $B(x, x) = 0$: contradiction. \square

Lemma 4.8. *In the setting of Theorem 4.4, if the Cartan matrix A_P of P (not necessarily symmetric) satisfies (H_0) and (H_-) then $P \cap P^* \subset \Omega_P$.*

Proof. In the proof, the subscript P is omitted from the notation for simplicity. Suppose that $x \in P \cap P^*$. In other words,

$$\alpha_s(x) \leq 0 \quad \text{for every } s \in S \quad \text{and} \quad x = \sum_{s \in S} c_s b_s \quad \text{for some } c = (c_s)_{s \in S} \geq 0.$$

Let $S_x = \{s \in S \mid \alpha_s(x) = 0\}$. We aim to show that the Coxeter group W_{S_x} is finite. Equivalently (Theorem 4.4), the stabilizer subgroup of x in Γ_P is finite. For this, we define the following subsets of S :

$$S^> = \{s \in S \mid c_s > 0\} \quad S_x^> = S_x \cap S^> \quad S_x^0 = S_x \setminus S_x^>$$

First, we claim that $S_x^0 \perp S^>$. Indeed, by definition, we have $S_x^0 \cap S^> = \emptyset$, which implies that $A_{st} \leq 0$ for every $s \in S_x^0$ and every $t \in S^>$. Moreover, for each $s \in S_x$

$$(1) \quad 0 = \alpha_s(x) = \sum_{t \in S^>} c_t \alpha_s(b_t) = \sum_{t \in S^>} c_t A_{st}.$$

If $s \in S_x^0$, then each term of the right-hand sum in (1) is nonpositive, hence must be zero. Thus $A_{st} = 0$ for every $s \in S_x^0$ and every $t \in S^>$, which exactly means that $S_x^0 \perp S^>$ as claimed.

Second, we claim that $A_{S_x^>}$ is of positive type. Indeed, if $s \in S_x^>$, then:

$$0 = \alpha_s(x) = \sum_{t \in S} c_t A_{st} = \sum_{t \in S_x^>} c_t A_{st} + \sum_{t \notin S_x^>} c_t A_{st}$$

which implies that $\sum_{t \in S_x^>} c_t A_{st} \geq 0$. Since $c_{S_x^>} > 0$ and $A_{S_x^>} \cdot c_{S_x^>} \geq 0$, we deduce from Proposition 4.1 that each component of $A_{S_x^>}$ is either of positive type or of zero type. Therefore, the condition (H_0) implies that the matrix $A_{S_x^>}$ is of positive type as claimed.

Third, we claim that the matrix $A_{S^>}$ has a component of negative type. Indeed, suppose by contradiction that every component of $A_{S^>}$ is not of negative type. Then the condition (H_0) implies that $A_{S^>}$ is of positive type, and hence by Lemma 13 of Vinberg [Vin71], we may assume without loss of generality that $A_{S^>}$ is a positive definite symmetric matrix. However, this is impossible because by the same reasoning as in the proof of Lemma 4.7,

$$0 > \sum_{s \in S^>} c_s \alpha_s(x) = \sum_{s, t \in S^>} c_s c_t A_{st} = c_{S^>}^T \cdot A_{S^>} \cdot c_{S^>}$$

where the superscript T of a vector v means the transpose of v .

Fourth, we claim that $A_{S_x^0}$ is of positive type. Indeed, assume by contradiction that $A_{S_x^0}$ is not of positive type. Once again, the condition (H_0) implies that $A_{S_x^0}$ has a component of negative type. This contradicts the condition (H_-) because $S_x^0 \perp S^>$ and $A_{S^>}$ has a component of negative type.

Finally, we claim that the Coxeter group W_{S_x} is finite. Indeed, since $A_{S_x} = A_{S_x^>} \oplus A_{S_x^0}$ is of positive type, by Proposition 4.3 we have that the Coxeter group W_{S_x} is spherical, i.e. it is finite as claimed.

In conclusion, we deduce from the item (5) of Theorem 4.4 that $x \in \Omega$. □

5. TOPOLOGICAL ACTIONS OF REFLECTION GROUPS

In this section, we recall some facts about actions of reflection groups on manifolds (see Chapters 5 and 10 of [Dav08]).

A *mirrored space over S* consists of a space X , an index set S and a family of closed subspaces $(X_s)_{s \in S}$. We denote the mirrored space simply by X . For each $x \in X$, put $S_x = \{s \in S \mid x \in X_s\}$.

Suppose X is a mirrored space over S and (W, S) is a Coxeter system. Define an equivalence relation \sim on $W \times X$ by $(g, x) \sim (h, y)$ if and only if $x = y$ and $g^{-1}h \in W_{S_x}$. Give $W \times X$ the product topology and let $\mathcal{U}(W, X)$ denote the quotient space:

$$\mathcal{U}(W, X) := W \times X / \sim$$

We let $[g, x]$ denote the image of (g, x) in $\mathcal{U}(W, X)$. The natural W -action on $W \times X$ is compatible with the equivalence relation, and hence it descends to an action on $\mathcal{U}(W, X)$, i.e. $\gamma \cdot [g, x] = [\gamma g, x]$. The map $i : X \rightarrow \mathcal{U}(W, X)$ defined by $x \mapsto [1, x]$ is an embedding and we identify X with its image under i . Note that X is a *strict fundamental domain* for the W -action on $\mathcal{U}(W, X)$, i.e. it intersects each W -orbit in exactly one point.

An involution on a connected manifold M is a *topological reflection* if its fixed set separates M . Suppose that a group W acts properly on a connected manifold M and that it is generated by topological reflections. Let R be the set of all topological reflections in W . For each $r \in R$, the fixed set of r , denoted H_r , is the *wall* associated to r . The closure of a connected component of $M \setminus \bigcup_{r \in R} H_r$ is a *chamber* of W . A wall H_r is a *wall of a chamber D* if there is a point $x \in D \cap H_r$ such that x belongs to no other wall. Fix a chamber D and let

$$S = \{r \in R \mid H_r \text{ is a wall of } D\}.$$

Theorem 5.1 (Proposition 10.1.5 of [Dav08]). *Suppose that W acts properly on a connected manifold M as a group generated by topological reflections. With the notation above, the following hold:*

- *the pair (W, S) is a Coxeter system;*
- *the natural W -equivariant map $\mathcal{U}(W, D) \rightarrow M$, induced by the inclusion $D \hookrightarrow M$, is a homeomorphism.*

Theorem 5.2 (Proposition 10.9.7 of [Dav08]). *Suppose a Coxeter group W acts faithfully, properly and cocompactly on a contractible manifold M . Then W acts on M as a group generated by topological reflections.*

Theorem 5.3 (Main Theorem of Charney–Davis [CD00]). *Suppose a Coxeter group W admits a faithful, proper and cocompact action on a contractible manifold. If S and S' are two fundamental sets of generators for W , then there is a unique element $w \in W$ such that $S' = wSw^{-1}$.*

Lemma 5.4. *Let (W, S) be a Coxeter system, and let $\tau : W \rightarrow \mathrm{SL}^\pm(V)$ be a faithful representation. Suppose that $\tau(W)$ acts properly discontinuously and cocompactly on some properly convex open subset Ω of $\mathbb{S}(V)$. Then the following hold:*

- (1) *for each $s \in S$, the image $\tau(s)$ of s is a projective reflection of $\mathbb{S}(V)$;*
- (2) *the group $\tau(W)$ is a projective Coxeter group generated by reflections $(\tau(s))_{s \in S}$.*

Proof. By Theorem 5.2, there exists a set of generators $S' \subset W$ such that for each $s \in S'$ the image $\tau(s)$ of s is a topological reflection, i.e. the fixed set of $\tau(s)$ separates Ω . We claim that $\tau(s)$ is a projective reflection. Indeed, since $\tau(s)$ is an automorphism of $\mathbb{S}(V)$, if $\tau(s)$ is not a projective reflection, then the fixed set of $\tau(s)$ is of codimension ≥ 2 , which is impossible.

Let R be the set of all reflections in $\tau(W)$. For each $r \in R$, we denote by H_r the wall associated to $\tau(r)$, which is a hyperplane in Ω . Fix a chamber D of $\tau(W)$, which is a closed connected subset of Ω , and let

$$S'' = \{r \in R \mid H_r \text{ is a wall of } D\}.$$

By Theorem 5.1, we have that (W, S'') is a Coxeter system and that the natural W -equivariant map $\mathcal{U}(W, D) \rightarrow \Omega$ is a homeomorphism. Since the group W acts faithfully, properly and cocompactly on Ω , by Theorem 5.3, there is a unique element $w \in W$ such that $S = wS''w^{-1}$. Thus, for each $s \in S$, the image $\tau(s)$ of s is a projective reflection of $\mathbb{S}(V)$, and the strict fundamental domain $P := \tau(w) \cdot D$ is bounded by the fixed hyperplanes of the reflections $\tau(s)$ for $s \in S$. In other words, each automorphism $\tau(s)$ of $\mathbb{S}(V)$ can be written as $\tau(s) = \mathrm{Id} - \alpha_s \otimes b_s$ for some linear form $\alpha_s \in V^*$ and some vector $b_s \in V$ so that $\alpha_s(b_s) = 2$ and

$$P = \bigcap_{s \in S} \mathbb{S}(\{x \in V \mid \alpha_s(x) \leq 0\}).$$

Therefore, the pair of the polytope P and the set of reflections $(\tau(s))_{s \in S}$ is a Coxeter polytope since P is the (strict) fundamental domain for the $\tau(W)$ -action on Ω . \square

6. PROOF OF THEOREMS C AND D

In the following theorem, we use the same notation as in Section 4.3.

Theorem 6.1. *If W is a Coxeter group with Coxeter diagram in Tables 3, 4, 5, 6, 7, then the following hold:*

- *the group W is Gromov-hyperbolic and its Gromov boundary is homeomorphic to \mathbb{S}^{d-1} ;*
- *the Cosine matrix C_W of W satisfies the conditions (H_0) and (H_-) ;*
- *the symmetric matrix C_W is of signature $(d, 2, 0)$;*
- *the Tits representation $\sigma_{C_W} : W \rightarrow \mathrm{O}(B_{C_W}) \simeq \mathrm{O}_{d,2}(\mathbb{R})$ is strictly GHC-regular.*

Proof. By Corollary 3.3, the Coxeter group W is Gromov-hyperbolic and the Gromov boundary of W is a $(d-1)$ -dimensional sphere. By Proposition 4.3, the Cosine matrix C_W of W satisfies the hypotheses (H_0) and (H_-) because the Coxeter diagram G_W of W has no edge of label ∞ and the Coxeter group W satisfies Moussong's hyperbolicity criterion (Theorem 3.4), namely S does not contain any affine subset of rank at least 3 nor two orthogonal non-spherical subsets. By Proposition 3.5, the signature of W is $(d, 2, 0)$, and hence the negative open set $O_{C_W}^\ell$ of C_W and the orthogonal group $\mathrm{O}(B_{C_W})$ may be identified with $\mathrm{AdS}^{d,1}$ and

$O_{d,2}(\mathbb{R})$, respectively. By Theorem 4.6, the subgroup $\sigma_{C_W}(W)$ of $O_{d,2}(\mathbb{R})$ is $\text{AdS}^{d,1}$ -convex compact, hence the representation σ_{C_W} is strictly GHC-regular because the Gromov boundary of W is homeomorphic to \mathbb{S}^{d-1} . \square

Applying the same method as for Theorem 6.1, we can prove:

Theorem 6.2. *If W is a Coxeter group with Coxeter diagram in Table 8, then the following hold:*

- *the group W is Gromov-hyperbolic and its Gromov boundary is homeomorphic to \mathbb{S}^3 ;*
- *the symmetric matrix C_W is of signature $(5, 1, 0)$;*
- *the Tits representation $\sigma_{C_W} : W \rightarrow O(B_{C_W}) \simeq O_{5,1}(\mathbb{R})$ is quasi-Fuchsian.*

Now, it only remains to show that every Coxeter group W in Tables 3, 4, 5, 6, 7, 8 is not quasi-isometric to a uniform lattice of a semi-simple Lie group. First, the properties of W being isomorphic to and quasi-isometric to a uniform lattice of a semi-simple Lie group respectively are almost same due to the following beautiful theorem:

Theorem 6.3 (Tukia [Tuk86], Pansu [Pan89], Chow [Cho96], Kleiner–Leeb [KL97], Eskin–Farb [EF97], for an overview see Farb [Far97] or Chapter 23 of Druţu–Kapovich [DK17]). *Let Γ be a finitely generated group and G a semi-simple Lie group. Then the group Γ is quasi-isometric to a uniform lattice of G if and only if there exists a homomorphism $\tau : \Gamma \rightarrow G$ with finite kernel and whose image is a uniform lattice of G .*

Moreover, if in addition Γ is an irreducible large Coxeter group W , then the homomorphism $\tau : \Gamma \rightarrow G$ must be injective.

Proposition 6.4 (Assertion 2 of the proof of Proposition 4.3 of Paris [Par07]). *Let W be an irreducible large Coxeter group. If N is a normal subgroup of W then N is infinite.*

Thus, an irreducible large Coxeter group W is quasi-isometric to a uniform lattice of a semi-simple Lie group G if and only if it is isomorphic to a lattice of G . Even more, the property of W reduces to a property of being isomorphic to a uniform lattice of the isometry group of real hyperbolic space.

Theorem 6.5 (Corollary 10.9.8 of [Dav08]). *Let W be an irreducible large Coxeter group and G a semi-simple Lie group. If W is isomorphic to a uniform lattice of G , then the Lie algebra of G is isomorphic to $\mathfrak{so}_{d,1}(\mathbb{R})$ for some $d \geq 2$.*

Proposition 6.6. *If (W, S) is a Coxeter system with Coxeter diagram in Tables 3, 4, 5, 6, 7, 8, then the group W is not isomorphic to a uniform lattice of $\text{Isom}(\mathbb{H}^e)$ for any integer $e \geq 1$.*

Proof. Let d be the rank of W minus 2. Suppose by contradiction that there is a faithful representation $\tau : W \rightarrow \text{Isom}(\mathbb{H}^e)$ whose image is a uniform lattice. By Corollary 3.3, we have $\partial W \simeq \mathbb{S}^{d-1}$. Fix $x_0 \in \mathbb{H}^e$. Since the orbit map $\varphi : W \rightarrow \mathbb{H}^e$ defined by $\gamma \mapsto \tau(\gamma) \cdot x_0$ is a quasi-isometry, it extends to a homeomorphism $\partial\varphi : \partial W \rightarrow \partial\mathbb{H}^e \simeq \mathbb{S}^{e-1}$, and hence $d = e$.

Since $\tau(W)$ is a uniform lattice of $\text{Isom}(\mathbb{H}^d)$, by Lemma 5.4, the group $\tau(W)$ is a projective Coxeter group generated by reflections $(\tau(s) = \text{Id} - Q(v_s, \cdot) \otimes v_s)_{s \in S}$ for some $d + 2$ vectors v_s of $\mathbb{R}^{d,1}$ with $Q(v_s, v_s) = 2$, where Q is the quadratic form on $\mathbb{R}^{d,1}$ defining $\text{PO}_{d,1}(\mathbb{R}) \simeq \text{Isom}(\mathbb{H}^d)$. Therefore, the determinant of the symmetric Cartan matrix $C_W = (Q(v_s, v_t))_{s, t \in S}$

must be zero. However, it is impossible since we have by Propositions 3.5 and 3.7 that the determinant of the Cosine matrix C_W of W is non-zero. \square

Remark 6.7. Proposition 6.6 (hence Lemma 5.4) is highly inspired by Proposition 3.1 of Benoist [Ben06], Example 12.6.8 of [Dav08] and Examples 2.3.1 and 2.3.2 of Januszkiewicz–Świątkowski [JS03].

7. AN ALTERNATIVE PROOF OF MOUSSONG’S CRITERION

In the paper [DGK17], the authors give an alternative proof of Moussong’s hyperbolicity criterion [Mou88] (see Theorem 3.4) in the case of right-angled Coxeter groups. In this section, we prove the criterion for arbitrary Coxeter groups built on [DGK17].

Let $W_{S,M}$ be a Coxeter group. For any non-negative real number λ , the λ -Cosine matrix C_W^λ of W is a symmetric matrix whose entries are:

$$(C_W^\lambda)_{st} = -2 \cos\left(\frac{\pi}{M_{st}}\right) \quad \text{if } M_{st} < \infty \quad \text{and} \quad (C_W^\lambda)_{st} = -2(1 + \lambda) \quad \text{otherwise}$$

In the case $\lambda = 0$, $C_W^\lambda = C_W$. When $\lambda > 0$, then by Proposition 4.3, we have:

- the matrix C_W^λ satisfies (H_0) if and only if S does not contain any affine subset of rank at least 3;
- Assume that C_W^λ satisfies (H_0) . Then C_W^λ satisfies (H_-) if and only if S does not contain two orthogonal non-spherical subsets.

Proof of Moussong’s criterion. Suppose W satisfies Moussong’s criterion. In other words, S does not contain any affine subset of rank ≥ 3 nor two orthogonal non-spherical subsets. Fix a positive number λ . Then the λ -Cosine matrix C_W^λ of W satisfies the conditions (H_0) and (H_-) . If the signature of C_W^λ is (p, q, r) , then by Theorem 4.6, the subgroup $\sigma_{C_W^\lambda}(W)$ of $O(B_{C_W^\lambda})$ is $\mathbb{H}^{p,q-1}$ -convex cocompact, hence W is Gromov-hyperbolic by Theorem 1.4 of [DGK17]. \square

8. PROOF OF THEOREMS E AND F

Proof of Theorems E and F. Each item of Tables 1 or 2 corresponds to a one parameter family $(W_p)_p$ or a two parameters family $(W_{p,q})_{p,q}$ of Coxeter groups. We often denote W_p or $W_{p,q}$ simply by W or W_S .

Let d be the rank of W minus 3. It is easy to verify that the Coxeter group W is Gromov-hyperbolic using Moussong’s hyperbolicity criterion (see Theorem 3.4). In [Tum07], Tumarkin showed that if $(p, q) = (p_0, q_0)$ (resp. $p = p_0$), then $W_{p,q}$ (resp. W_p) is the geometric reflection group of a compact hyperbolic d -polytope. Note that if W_0 and W_1 are two Coxeter groups such that (i) the underlying graph of G_{W_0} and G_{W_1} are equal; (ii) the Coxeter diagram G_{W_1} is obtained from G_{W_0} by changing from a label $m_0 \geq 7$ on a fixed edge to another label $m_1 \geq 7$, then the nerves of W_0 and W_1 are isomorphic. Thus, the nerve of any Coxeter group $W_{p,q}$ (resp. W_p) is isomorphic to the nerve of W_{p_0,q_0} (resp. W_{p_0}), and so the Coxeter group W is an abstract geometric reflection group of dimension d . By Theorem 2.3, the Davis complex of W and the Gromov boundary of W are homeomorphic to \mathbb{R}^d and \mathbb{S}^{d-1} , respectively.

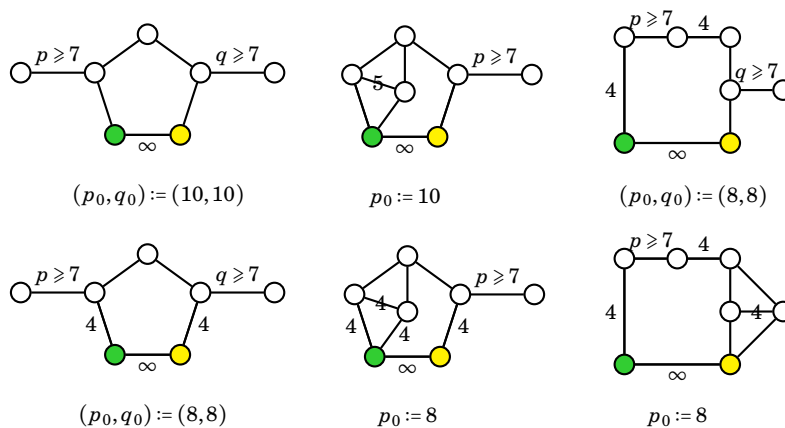

TABLE 1. Abstract geometric reflection groups of dimension $d = 4$

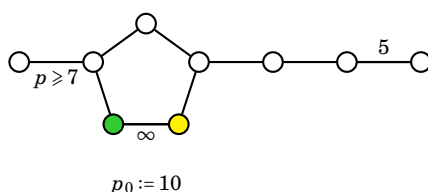

TABLE 2. Abstract geometric reflection groups of dimension $d = 6$

We denote by S_1 (resp. S_2) the complement of the yellow (resp. green) node in S . For example, if W_S corresponds to the top left diagram in Table 1, then W_{S_1} (resp. W_{S_2}) corresponds to the diagram (A) (resp. (B)) in Figure 3.

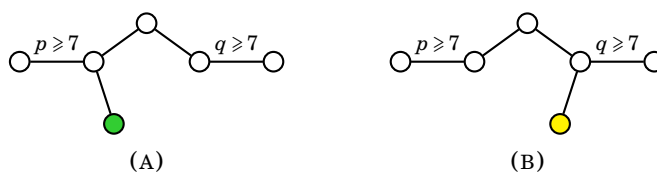

FIGURE 3. Two special subgroups of the Coxeter group W_S

By the same reasoning as in the proof of Proposition 3.5, the signature $s_{W_{S_i}}$ of W_{S_i} , $i = 1, 2$, is determined by the sign of the determinant of $C_{W_{S_i}}$. More precisely, the signature $s_{W_{S_i}}$ is $(d, 2, 0)$, $(d, 1, 1)$ and $(d + 1, 1, 0)$ when $\det(C_{W_{S_i}}) > 0$, $= 0$ and < 0 , respectively.

We set $f(\lambda) = \det(C_W^\lambda)$, which is a quadratic polynomial of λ :

$$f(\lambda) = a_2\lambda^2 + a_1\lambda + a_0$$

It is not difficult (but important) to see that the discriminant δ of $f(\lambda)$ is:

$$\delta = 16 \det(C_{W_{S_1}}) \det(C_{W_{S_2}})$$

Thus, the polynomial $f(\lambda)$ has two distinct positive real roots if and only if

$$(2) \quad \det(C_{W_{S_1}}) \det(C_{W_{S_2}}) > 0, \quad a_1 a_2 < 0 \quad \text{and} \quad a_0 a_2 > 0.$$

Lemma 8.1. *Let W be a Coxeter group with Coxeter diagram in Tables 1 or 2. Then the Coxeter diagram of W lies in Tables 9, 10, 11, 12 if and only if W satisfies the condition (2), i.e. $f(\lambda)$ has two distinct positive roots.*

Proof. We only prove it for the Coxeter group $W_{p,q}$ in the top left item of Table 1; the argument is similar for other Coxeter groups.

We set $c_m := \cos(\frac{2\pi}{m})$, and let $x = c_p$ and $y = c_q$. Note that $x, y > \frac{1}{2}$ because $p, q \geq 7$. By a simple computation, we have that the polynomial $f(\lambda)$ is:

$$\begin{aligned} f(\lambda) &= a_2(x, y)\lambda^2 + a_1(x, y)\lambda + a_0(x, y) \\ a_0(x, y) &= 8(2x + 2y - 3) \\ a_1(x, y) &= -16(2x - 1)(2y - 1) < 0 \\ a_2(x, y) &= 8(1 - (2x - 1)(2y - 1)) > 0 \end{aligned}$$

and the discriminant $\delta(x, y)$ of $f(\lambda)$ is:

$$\begin{aligned} \delta(x, y) &= 16 \det(C_{W_{S_1}}) \det(C_{W_{S_2}}) \\ \det(C_{W_{S_1}}) &= 4(4xy - 2x - 1) \quad \text{and} \quad \det(C_{W_{S_2}}) = 4(4xy - 2y - 1) \end{aligned}$$

In Figure 4, the equations $\det(C_{W_{S_1}}) = 0$, $\det(C_{W_{S_2}}) = 0$ and $a_0(x, y) = 0$ are drawn in red, blue and green, respectively.

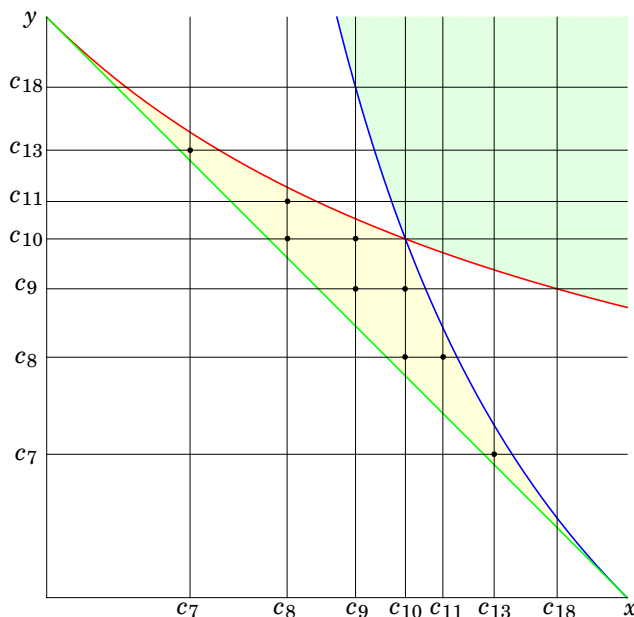

FIGURE 4. Two open regions \mathcal{R}_G and \mathcal{R}_Y

Observe that the Coxeter group $W_{p,q}$ satisfies the condition (2) if and only if $(x, y) = (c_p, c_q)$ lies in the light green region \mathcal{R}_G or the light yellow region \mathcal{R}_Y . Finally, it follows from Figure 4 that:

$$\begin{aligned} (c_p, c_q) \in \mathcal{R}_G &\Leftrightarrow p, q \geq 9 \text{ and } \{p, q\} \neq \{9, 9\}, \{9, 10\}, \dots, \{9, 18\}, \{10, 10\}; \\ (c_p, c_q) \in \mathcal{R}_Y &\Leftrightarrow \{p, q\} = \{7, 13\}, \{8, 10\}, \{8, 11\}, \{9, 9\}, \{9, 10\} \end{aligned}$$

For example, the point (c_p, c_q) lies in \mathcal{R}_Y if and only if it corresponds to one of the black dots in Figure 4. \square

Assume now that the Coxeter diagram of W_S lies in Tables 9, 10, 11, 12. Then the polynomial $f(\lambda)$ has two distinct positive roots, namely λ_1 and λ_2 . Note that the matrices $C_{W_{S_1}}$ and $C_{W_{S_2}}$ have the same signature because their determinants have the same sign. If the Cosine matrix $C_{W_{S_1}}$ (hence $C_{W_{S_2}}$) has the signature $(m, n, 0)$ with $(m, n) = (d, 2)$ or $(d + 1, 1)$, then the signature of $C_i := C_W^{\lambda_i}$, $i = 1, 2$, is $(m, n, 1)$. Thus, Theorem 4.6 provides $\mathbb{H}^{m, n-1}$ -convex cocompact representations $\sigma_{C_i} : W \rightarrow \text{PO}(B_{C_i}) \simeq \text{PO}_{m, n}(\mathbb{R})$ for $i = 1, 2$.

We let $[\rho]$ denote the equivalence class of the representation ρ , i.e. an element of the $\text{PO}_{m, n}(\mathbb{R})$ -character variety of W . Since $C_1 \neq C_2$, the characters $[\sigma_{C_1}]$ and $[\sigma_{C_2}]$ are different. Finally, we claim that for each $i = 1, 2$, the connected component χ_i of the $\text{PO}_{m, n}(\mathbb{R})$ -character variety of W containing $[\sigma_{C_i}]$ is a singleton. Indeed, suppose that $\tau_1 \in \chi_i$. Then there exists a continuous path $\tau_t : [0, 1] \rightarrow \chi_i$ from $\tau_0 = \sigma_{C_i}$ to τ_1 . This implies that for each torsion element $\gamma \in W$, the eigenvalues of $\tau_t(\gamma)$ do not change, i.e. the image $\tau_t(\gamma)$ is conjugate to $\tau_0(\gamma) = \sigma_{C_i}(\gamma)$. In particular, for every $s \in S$, $\tau_t(s)$ is a projective reflection in $\text{PO}_{m, n}(\mathbb{R})$, and there exists a continuous family of symmetric Cartan matrices $(A_t)_{t \in [0, 1]}$ with $\sigma_{A_t} = \tau_t$. Hence we conclude that there is a continuous function $\mu_t : [0, 1] \rightarrow \mathbb{R}$ with $C_W^{\mu_t} = A_t$ because the diagram G_W has only one edge of label ∞ . The matrix A_t must be of rank $\leq m + n = d + 2$. In other words, $\det(C_W^{\mu_t}) = 0$, and so $\mu_t = \lambda_i$, as claimed.

This completes the proof of Theorems E and F. \square

Remark 8.2. As mentioned above, the Coxeter group W with $(p, q) = (p_0, q_0)$ or $p = p_0$ is the geometric reflection group of a compact hyperbolic d -polytope. Thus, by the same reasoning as in Example 2.3.1 of Januszkiewicz–Świątkowski [JS03] (cf. Proposition 6.6), if $(p, q) \neq (p_0, q_0)$ (resp. $p \neq p_0$), then $W_{p, q}$ (resp. W_p) is not quasi-isometric to the hyperbolic space \mathbb{H}^d .

Remark 8.3. Recently, Davis asked the following question (see Question 2.15 of [Dav15]): *Is any abstract geometric reflection group of dimension d isomorphic to a projective Coxeter group in $\text{SL}_{d+1}^{\pm}(\mathbb{R})$?* He also conjectured that almost certainly the answer is *no*.

The counterexamples can be constructed as follows. Let W be a Coxeter group with Coxeter diagram in Tables 3, 5, 7, 8. By Proposition 3.1, W is an abstract geometric reflection group of dimension d . We now claim that if the underlying graph of the diagram G_W is a tree, then W is not isomorphic to a projective Coxeter group in $\text{SL}_{d+1}^{\pm}(\mathbb{R})$. Indeed, suppose by contradiction that W is isomorphic to a projective Coxeter group Γ_P generated by reflections $(\sigma_s = \text{Id} - \alpha_s \otimes b_s)_{s \in S}$ of $\text{SL}_{d+1}^{\pm}(\mathbb{R})$. Then the Cartan matrix $A = (\alpha_s(b_t))_{s, t \in S}$ of P is of rank $\leq d + 1$. Since the underlying graph of G_W is a tree, by Proposition 20 of Vinberg [Vin71], we may assume that the Cartan matrix A is symmetric, i.e. $A = C_W$. However, it is impossible since by Propositions 3.5 and 3.7, the matrix C_W is of rank $d + 2$.

APPENDIX A. THE TABLES OF THE COXETER GROUPS

A.1. **Examples to Theorems B and C.** Each Coxeter group in the Tables 3, 4, 5, 6 and 7 admits a strictly GHC-regular representation.

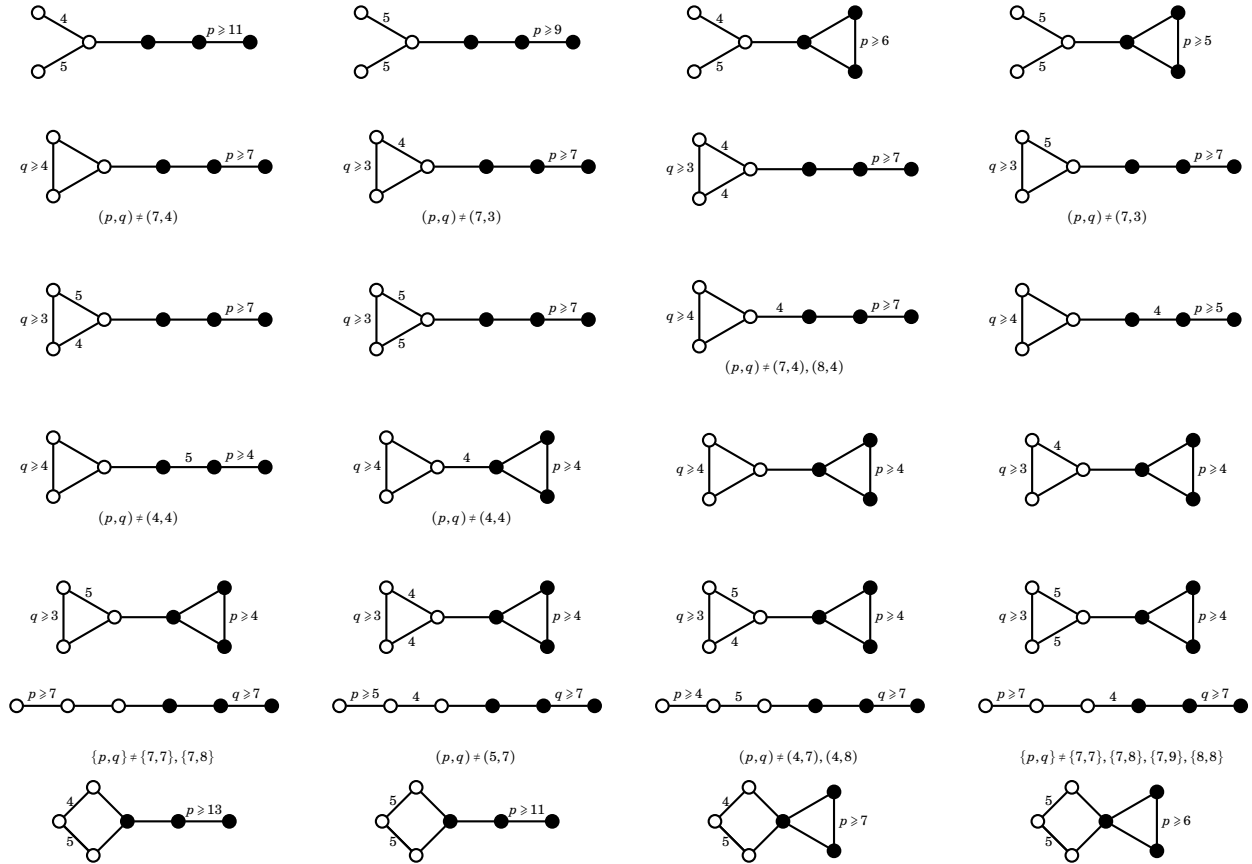

TABLE 3. Abstract geometric reflection groups of dimension $d = 4$ of rank $d + 2$

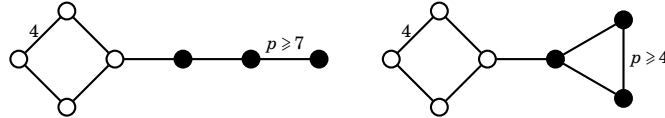

TABLE 4. Abstract geometric reflection groups of dimension $d = 5$ of rank $d + 2$

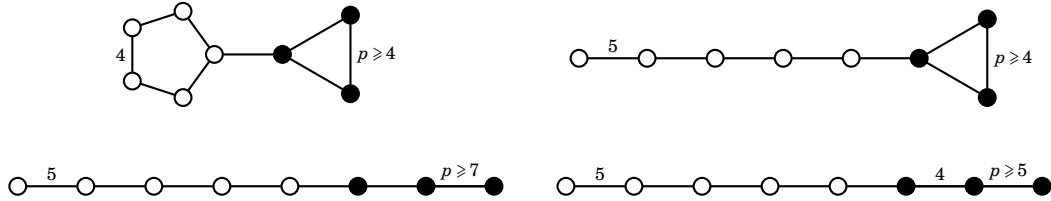

TABLE 5. Abstract geometric reflection groups of dimension $d = 6$ of rank $d + 2$

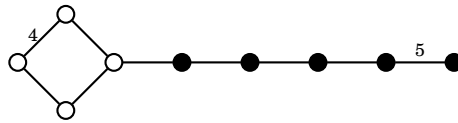

TABLE 6. An abstract geometric reflection group of dimension $d = 7$ of rank $d + 2$

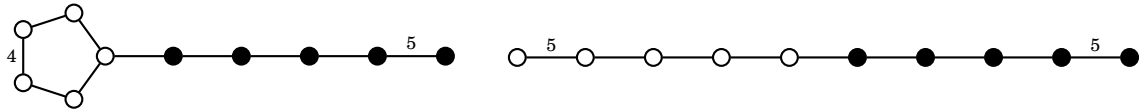

TABLE 7. Abstract geometric reflection groups of dimension $d = 8$ of rank $d + 2$

A.2. Examples to Theorem D. Each Coxeter group in the Table 8 admits a quasi-Fuchsian representation.

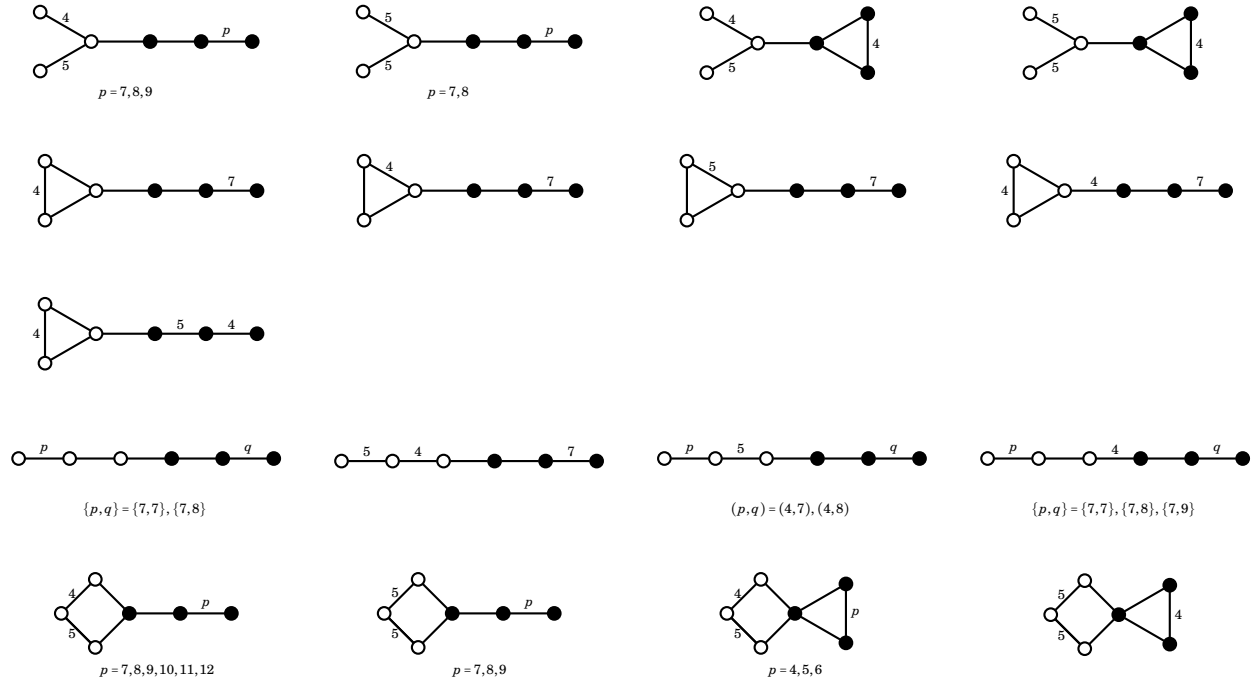

TABLE 8. Abstract geometric reflection groups of dimension 4 of rank $d + 2$

A.3. Examples to Theorem E. The space of strictly GHC-regular characters of each Coxeter group in the Tables 9 and 10 is disconnected.

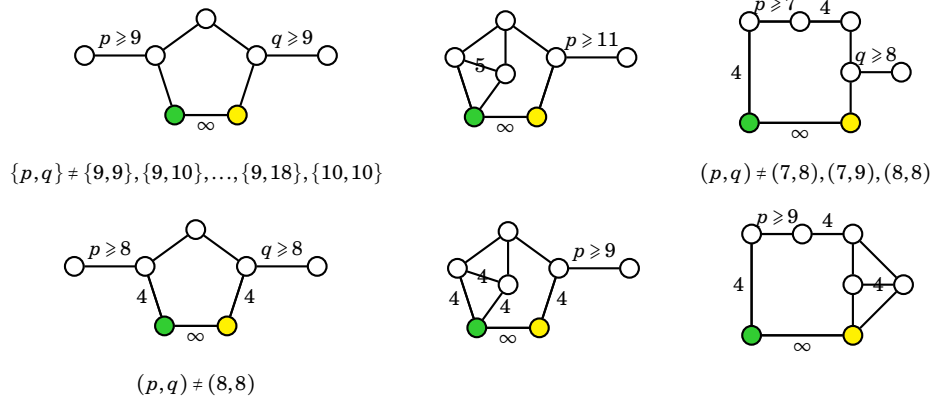

TABLE 9. Abstract geometric reflection groups of dimension $d = 4$ of rank $d + 3$

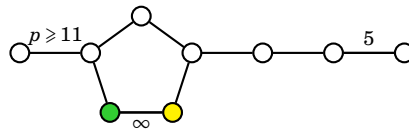

TABLE 10. Abstract geometric reflection groups of dimension $d = 6$ of rank $d + 3$

A.4. Examples to Theorem F. The space of quasi-Fuchsian characters of each Coxeter group in the Tables 11 and 12 is disconnected.

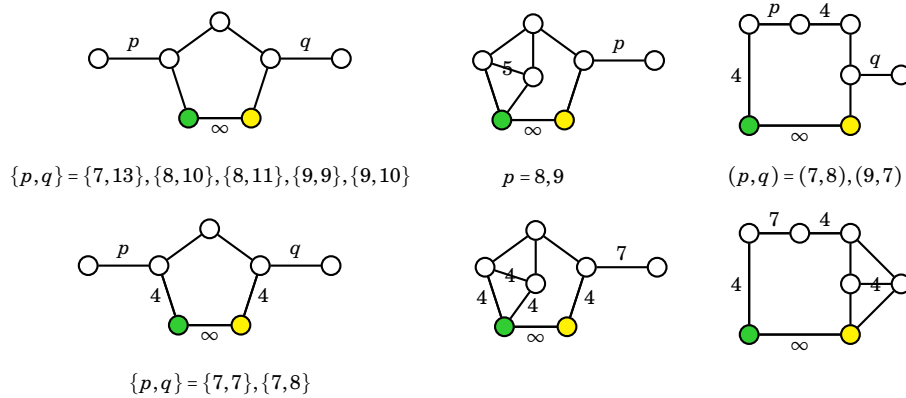
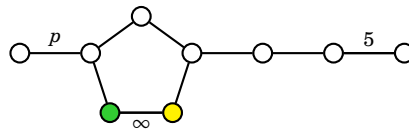

TABLE 11. Abstract geometric reflection groups of dimension $d = 4$ of rank $d + 3$



$p = 8, 9$

TABLE 12. Abstract geometric reflection groups of dimension $d = 6$ of rank $d + 3$

APPENDIX B. THE SPHERICAL, AFFINE AND LANNÉR DIAGRAMS

For the reader's convenience, we reproduce below the list of the irreducible spherical, irreducible affine and Lannér diagrams.

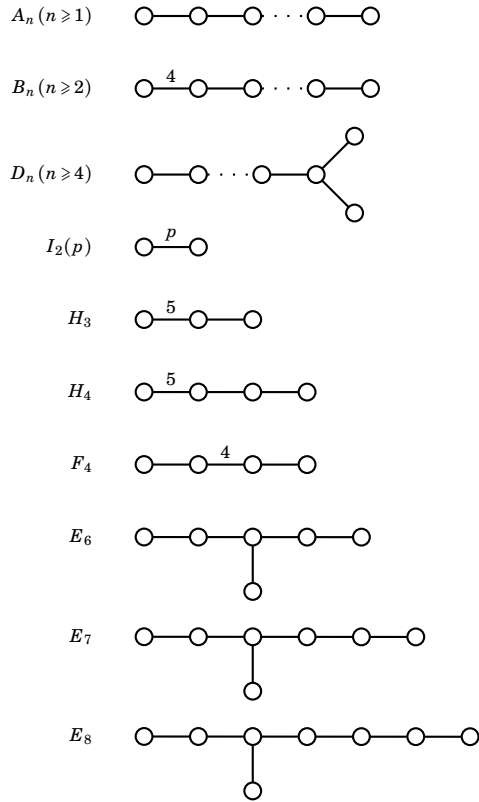

TABLE 13. The irreducible spherical Coxeter diagrams

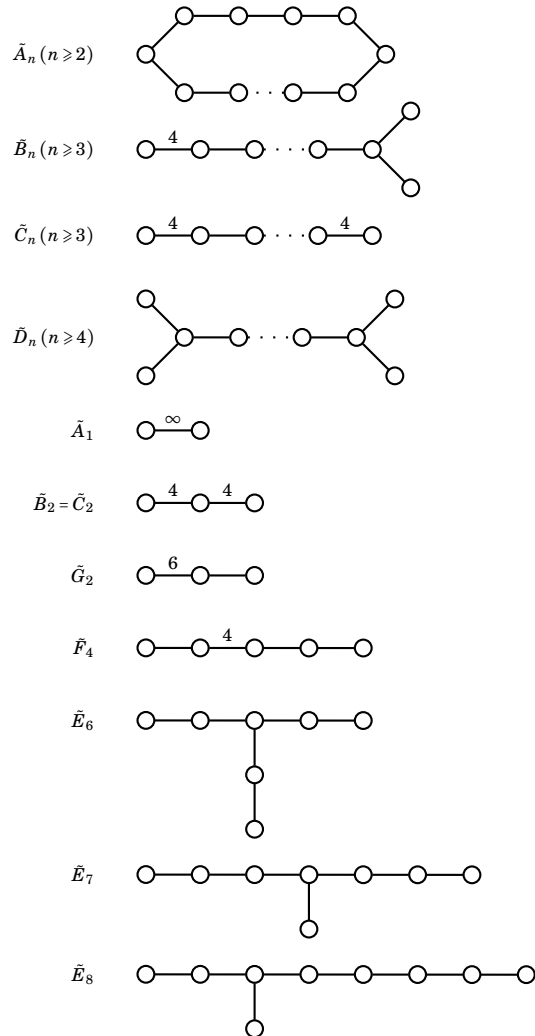

TABLE 14. The irreducible affine Coxeter diagrams

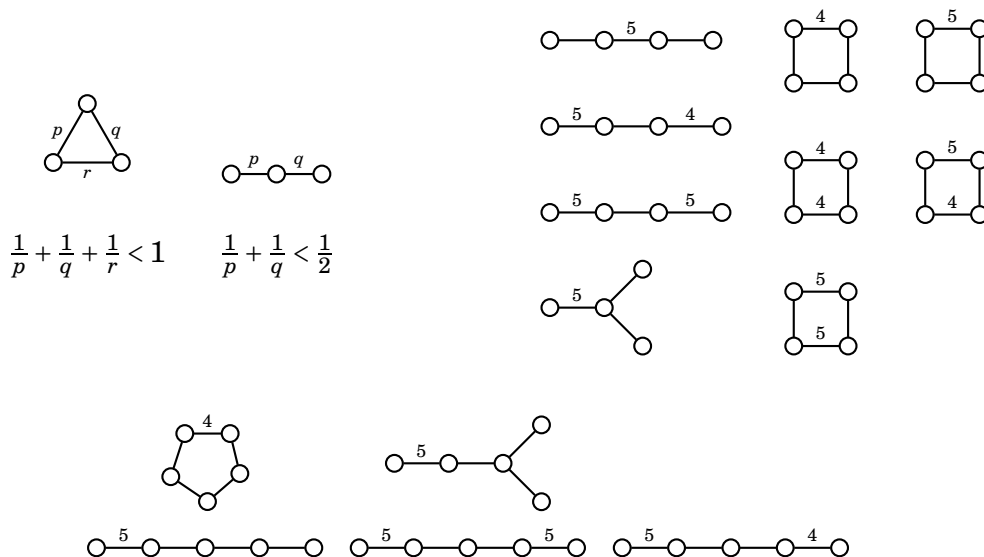

TABLE 15. The Lannér Coxeter diagrams

REFERENCES

[Bar08] Thierry Barbot. Causal properties of AdS-isometry groups. I. Causal actions and limit sets. *Adv. Theor. Math. Phys.*, 12(1):1–66, 2008. **2**

[Bar15] Thierry Barbot. Deformations of Fuchsian AdS representations are quasi-Fuchsian. *J. Differential Geom.*, 101(1):1–46, 2015. **2, 4**

[9A12] T. Barbot, F. Bonsante, J. Danciger, W. M. Goldman, F. Guéritaud, F. Kassel, K. Krasnov, J.-M. Schlenker, and A. Zeghib. Some open questions on anti-de Sitter geometry. *ArXiv:1205.6103*, May 2012. **1, 3, 5**

[Ben06] Yves Benoist. Convexes hyperboliques et quasiisométries. *Geom. Dedicata*, 122:109–134, 2006. **18**

[BK13] Marc Bourdon and Bruce Kleiner. Combinatorial modulus, the combinatorial Loewner property, and Coxeter groups. *Groups Geom. Dyn.*, 7(1):39–107, 2013. **4**

[BM12] Thierry Barbot and Quentin Mérigot. Anosov AdS representations are quasi-Fuchsian. *Groups Geom. Dyn.*, 6(3):441–483, 2012. **1, 2, 3**

[Bou68] Nicolas Bourbaki. *Groupes et algèbres de Lie, Chapitre IV, V, VI*. Hermann, 1968. **12, 13**

[CD00] Ruth Charney and Michael Davis. When is a Coxeter system determined by its Coxeter group? *J. London Math. Soc. (2)*, 61(2):441–461, 2000. **15**

[Cho96] Richard Chow. Groups quasi-isometric to complex hyperbolic space. *Trans. Amer. Math. Soc.*, 348(5):1757–1769, 1996. **17**

[Dav08] Michael W. Davis. *The geometry and topology of Coxeter groups*, volume 32 of *London Mathematical Society Monographs Series*. Princeton University Press, Princeton, NJ, 2008. **6, 7, 15, 17, 18**

[Dav15] Michael W. Davis. The geometry and topology of Coxeter groups. In *Introduction to modern mathematics*, volume 33 of *Adv. Lect. Math.*, pages 129–142. Int. Press, Somerville, MA, 2015. **21**

[DGK17] J. Danciger, F. Guéritaud, and F. Kassel. Convex cocompactness in pseudo-Riemannian hyperbolic spaces. *ArXiv:1701.09136*, January 2017. **1, 3, 5, 13, 18**

[DJ91] Michael W. Davis and Tadeusz Januszkiewicz. Hyperbolization of polyhedra. *J. Differential Geom.*, 34(2):347–388, 1991. **7**

[DK17] Cornelia Druțu and Misha Kapovich. Geometric group theory. *A book to appear in the AMS series "Colloquium Publications"*, 2017. **17**

[EF97] Alex Eskin and Benson Farb. Quasi-flats and rigidity in higher rank symmetric spaces. *J. Amer. Math. Soc.*, 10(3):653–692, 1997. **17**

- [Ess96] Frank Esselmann. The classification of compact hyperbolic Coxeter d -polytopes with $d+2$ facets. *Comment. Math. Helv.*, 71(2):229–242, 1996. [9](#), [10](#)
- [Far97] Benson Farb. The quasi-isometry classification of lattices in semisimple Lie groups. *Math. Res. Lett.*, 4(5):705–717, 1997. [17](#)
- [GW12] Olivier Guichard and Anna Wienhard. Anosov representations: domains of discontinuity and applications. *Invent. Math.*, 190(2):357–438, 2012. [2](#)
- [JŚ03] Tadeusz Januszkiewicz and Jacek Świątkowski. Hyperbolic Coxeter groups of large dimension. *Comment. Math. Helv.*, 78(3):555–583, 2003. [18](#), [21](#)
- [KL97] Bruce Kleiner and Bernhard Leeb. Rigidity of quasi-isometries for symmetric spaces and Euclidean buildings. *Inst. Hautes Études Sci. Publ. Math.*, 86:115–197 (1998), 1997. [17](#)
- [Lab06] François Labourie. Anosov flows, surface groups and curves in projective space. *Invent. Math.*, 165(1):51–114, 2006. [2](#)
- [Mes07] Geoffrey Mess. Lorentz spacetimes of constant curvature. *Geom. Dedicata*, 126:3–45, 2007. [2](#)
- [Mou88] Gabor Moussong. *Hyperbolic Coxeter groups*. ProQuest LLC, Ann Arbor, MI, 1988. Thesis (Ph.D.)—The Ohio State University. [1](#), [7](#), [8](#), [18](#)
- [MV00] Grigori Margulis and Ernest Vinberg. Some linear groups virtually having a free quotient. *J. Lie Theory*, 10(1):171–180, 2000. [5](#)
- [Pan89] Pierre Pansu. Métriques de Carnot-Carathéodory et quasiisométries des espaces symétriques de rang un. *Ann. of Math. (2)*, 129(1):1–60, 1989. [17](#)
- [Par07] Luis Paris. Irreducible Coxeter groups. *Internat. J. Algebra Comput.*, 17(3), 2007. [17](#)
- [Sto76] David A. Stone. Geodesics in piecewise linear manifolds. *Trans. Amer. Math. Soc.*, 215:1–44, 1976. [7](#)
- [Tuk86] Pekka Tukia. On quasiconformal groups. *J. Analyse Math.*, 46:318–346, 1986. [17](#)
- [Tum07] Pavel Tumarkin. Compact hyperbolic Coxeter n -polytopes with $n+3$ facets. *Electron. J. Combin.*, 14(1):Research Paper 69, 36, 2007. [18](#)
- [Vin71] Ernest Vinberg. Discrete linear groups that are generated by reflections. *Izv. Akad. Nauk SSSR Ser. Mat.*, 35:1072–1112, 1971. [10](#), [11](#), [12](#), [14](#), [21](#)
- [Vin84] È. B. Vinberg. Absence of crystallographic groups of reflections in Lobachevskii spaces of large dimension. *Trudy Moskov. Mat. Obshch.*, 47:68–102, 246, 1984. [9](#)

MATHEMATISCHES INSTITUT, RUPRECHT-KARLS-UNIVERSITÄT HEIDELBERG, GERMANY

E-mail address: lee@mathi.uni-heidelberg.de

IRMAR, UNIVERSITÉ DE RENNES 1, FRANCE

E-mail address: ludovic.marquis@univ-rennes1.fr