



HAL
open science

Remote Proxy V2V Messaging Using IPv6 and GeoNetworking

Kitazawa Masahiro, Manabu Tsukada, Morino Kai, Hideya Ochiai, Hiroshi Esaki

► **To cite this version:**

Kitazawa Masahiro, Manabu Tsukada, Morino Kai, Hideya Ochiai, Hiroshi Esaki. Remote Proxy V2V Messaging Using IPv6 and GeoNetworking. 6th International Conference on Advances in Vehicular Systems, Technologies and Applications (VEHICULAR 2017), IARIA, Jul 2017, Nice, France. pp.74–80. hal-01578410

HAL Id: hal-01578410

<https://hal.science/hal-01578410>

Submitted on 1 Sep 2017

HAL is a multi-disciplinary open access archive for the deposit and dissemination of scientific research documents, whether they are published or not. The documents may come from teaching and research institutions in France or abroad, or from public or private research centers.

L'archive ouverte pluridisciplinaire **HAL**, est destinée au dépôt et à la diffusion de documents scientifiques de niveau recherche, publiés ou non, émanant des établissements d'enseignement et de recherche français ou étrangers, des laboratoires publics ou privés.

Remote Proxy V2V Messaging Using IPv6 and GeoNetworking

Masahiro Kitazawa*, Manabu Tsukada*, Kai Morino[†], Hideya Ochiai* and Hiroshi Esaki*

*Graduate School of Information Science and Technology

The University of Tokyo

Email: {ktzw, tsukada, jo2lxq}@hongo.wide.ad.jp, hiroshi@wide.ad.jp

[†]Institute of Industrial Science

The University of Tokyo

Email: morino@sat.t.u-tokyo.ac.jp

Abstract—Vehicle-to-vehicle (V2V) messaging plays an important role in cooperative intelligent transportation systems (CITS), which are advanced applications addressing the problems of road transport management. In this regard, the Cooperative Awareness Message (CAM) protocol is standardized in EU for V2V messaging. However, V2V messages work well only when all vehicles have transmitters and work well in short range and no obstacle. To solve the former problem, the existence of the non-ITS road users, in the early deployment phase, we previously proposed a system called Proxy CAM, wherein roadside sensors detect target vehicles and transmit V2V messages on behalf of the vehicles. However, the V2V transmission range is still limited to the wireless range of IEEE802.11p. Therefore, in this study, we propose a system that delivers CAMs over the Internet using UDP/IPv6 and LTE in addition to the standard specification (i.e., the Basic Transportation Protocol/GeoNetworking and IEEE802.11p). Moreover, we implement the cellular network component of the system and evaluate its performance in terms of the packet delivery ratio and packet delay for various distances and packet frequencies. In our evaluation, we define the average Proxy CAM update delay and calculate this parameter for both IEEE802.11p and LTE. We find that using LTE over long distances is more efficient than using IEEE802.11p.

Keywords—CITS; CAM; LTE; Cellular Network; V2V.

I. INTRODUCTION

The problem of vehicular traffic, particularly traffic jams and accidents, has become one of the most important issues in the world today. In this context, intelligent transport systems (ITSs) have been designed to solve this problem via acquiring and sharing traffic information from vehicle sensors or other devices. Examples of ITS include Vehicle Information and Communication Systems (VICS) [1], which automatically receive information about traffic jams and road construction from roadside beacons via FM multiplex broadcasting and electronic toll collection systems (ETCSs) [2] installed at the entrances and exits of highways by communicating with vehicles via radio waves. In particular, ITSs that communicate traffic information with other ITSs to improve vehicle safety, durability, efficiency, and comfort are called cooperative ITSs (CITSs). A typical CITS consists of an application layer, facilities layer, network&transport layer, access layer, management layer, and security layer [3].

A CITS communicates by means of Cooperative Awareness Messages (CAMs) [4] and Decentralized Environmental Notification Message (DENM) [5] protocols. A CAM contains information on the positions and movements of road users (vehicles, bicycles, pedestrians) along with other dynamic information. According to [4], all ITS-installed devices are

encouraged to create and broadcast messages with the use of CAM, and the desirable frequency range for CAM broadcasting is 1 to 10 Hz. Further, single-hop broadcasting is also desirable. Upon receiving CAM information, a CITS processes the CAM to update the Local Dynamic Map (LDM) [6]. The Cooperative Awareness basic service (CA basic service) in the facilities layer, the Basic Transport Protocol (BTP) [7]/GeoNetworking(GN) [8] in the network&transport layer, and IEEE802.11p [9] in the access layer are used to send and receive CAMs. The CA basic service also manages to encode and decode CAMs and provide CAM information to the LDM and application layer, while BTP provides end-to-end connectionless communication. This protocol is aimed at transmitting multiple messages from different processes in the facilities layer at the same time along one packet path. However, it is to be noted that BTP does not guarantee the order, integrity, and reliability of packets. Meanwhile, the GN protocol provides the packet path while IEEE802.11p specifies the wireless communication system developed for communication between vehicles. This makes communication between fast-moving vehicles possible in the frequency band of 5.85~5.925 GHz. The bandwidth is narrow compared to other IEEE802.11 series, and therefore, the communication speed is less, but resistance to multipath propagation is strong.

A CITS cannot function without communicating with other vehicles; however, there are certain problems with the current communication protocols. First, the communication protocols do not cover non-CITS road users such as vehicles with no CITS and pedestrians. In this regard, it is noteworthy that there are no CITS products commercially available today in Japan. Thus, the commercialization of CITS vehicles requires the system functionality to detect neighboring non-CITS vehicles and pedestrians. While computer vision can be utilized to solve this problem, there is a possibility that computer vision cannot detect vehicles in the case that they are in blind spots. There are always blind spots at intersections, and vehicles may not be able to avoid accidents with other vehicles or pedestrians emerging from such blind spots. Second, IEEE802.11p uses the frequency band, 5.85~5.925 GHz. This range of frequencies is so high that these waves hardly undergo diffraction; thus, they cannot travel around obstacles. Finally, the signal strength of such wireless radio systems also decreases with increasing distance.

In the above context, this study proposes the usage of cellular networks (UDP/IP) and LTE in addition to the original Proxy CAM [10] system's protocol stack, BTP/GN + IEEE802.11p, to solve the abovementioned problems. In our

study, we design a Remote Proxy CAM system that uses computer vision sensors installed along the roadside to generate Proxy CAMs from the acquired images and broadcasts them using BTP/GN + IEEE802.11p (as does the original Proxy CAM system). In addition, the Remote Proxy CAM system uses a server-client model to send request-based Proxy CAMs to the client.

In the study, we also implement a prototype of a part of this system using a cell phone, and we measure the latency and delivery ratio of the packets. We find that packets using UDP/IP + LTE exhibit short delay times and high delivery ratios and function efficiently over long distances.

The contributions of this work are:

- Analysis of problems of Proxy CAM
- Proposal of a communication protocol stack in addition to the original one
- Prototype implementation of a part of the proposed system
- Experimental evaluation of the prototype

The rest of the paper is organized as follows. Section II highlights related works, and Section III analyzes the issues of Proxy CAM and summarizes the requirements of the solution. Section IV presents the design of our system along with its implementation. Section V demonstrates and evaluates the implementation, and finally, Section VI concludes our paper and presents our future studies in this direction.

II. RELATED WORKS

In this section, we introduce and discuss two main related concepts, Proxy CAM and cloud-based pedestrian road-safety. The Proxy CAM approach is used to generate CAMs by proxy while cloud-based pedestrian road-safety involves communication between vehicles and pedestrians using a cellular network.

A. Proxy CAM

In general, when CITS cars broadcast their CAM information in the vicinity of obstacles such as buildings, there is a possibility that the CAMs cannot reach cars on the other side of the buildings, which may lead to accidents. Further, the presence of non-CITS cars (which cannot broadcast their CAM information) cannot be detected by CITS cars without computer vision. To solve this problem, we propose the Proxy CAM [10] system that works with any vehicle-sensing technology. This system consists of a roadside sensor, sensor fusion database, Proxy CAM generator, and Proxy CAM transmitter. In our scheme, first, roadside sensors detect vehicles and acquire their position, speed, acceleration, and other optional information. Next, the sensors tag each vehicle with an ID that is sent to the sensor fusion database along with the other information. Any type of road traffic sensor can be utilized with the system if it can detect vehicles and acquire the relevant information. The sensor fusion database receives the vehicle data and stores it in the sensor fusion local dynamic map (SFLDM). This database also has the functionality to identify a single vehicle from the data from multiple sensors and integrate the data. Next, the Proxy CAM generator uses the SFLDM and composes Proxy CAMs. Some of the CAM fields are labeled as 'unknown'. The Station ID field of the proxy CAM contains 24 bits set to '1' and 8 random bits.

If the sensor or SFLDM identifies the vehicle information as that of a previously detected vehicle, the Station ID field of its Proxy CAM is set to the same value as the one created previously. Finally, the Proxy CAM transmitters broadcast the generated Proxy CAMs using the ETSI standard protocols, BTP/GN in the networking & transport layer, and IEEE802.11p in the access layer. The CAM transmitters should be installed at locations ensuring a clear line-of-sight to the vehicles.

B. Cloud-Based Pedestrian Road-Safety

Pedestrians can be detected only with the use of computer vision by CITS cars because pedestrians cannot create and broadcast CAMs. However, the accuracy of computer vision depends on the weather and daylight conditions (day or night). Thus, to accurately detect the presence of pedestrians, we need another method. In this regard, in a previous study [11], the authors used the cell phones of pedestrians to communicate with CITS cars. However, CITS cars can only communicate using IEEE802.11p while cell phones do not use IEEE802.11p. Thus, the authors of the study installed cell phones in CITS cars, and the phones were connected to the CITS. However, in cellular networks, broadcasting is not allowed. Thus, the authors used a cloud server to communicate with pedestrian and the CITS cell phones. In the scheme, both sets of cell phones (vehicular and pedestrian) always send their positions to the server. The pedestrian's cell phone communicates at low frequencies because the communication consumes electrical power and the capacity of the cell phone battery is limited. The server always verifies the positions of both the pedestrian and CITS phones. If the two parties approach each other, the server sends a request to the pedestrian's cell phone to switch the communication frequency to 'high'. After receiving the request, the pedestrian's cell phone switches to the designated high frequency. If the server estimates the possibility of a collision between the pedestrian and car, it sends an alert message to both of them.

Our approach is also inspired by several other relevant studies, which we briefly present here. In [12], the authors used power lines to communicate between ITS users and the transport management system. In [13], Vehicular Ad-Hoc Networks (VANETs) were utilized for communication, and the authors designed two VANET sampling protocols named SAME and TOME to collect vehicular traffic information and detect incidents in real-time. Further [14] used parked cars to hop? CAMs from cars on the opposite sides of a building.

III. PROBLEM STATEMENT

In this section, we discuss the problems of Proxy CAM in detail. Subsequently, we analyze the design requirements for the solution.

A. Problem

Figure 1 illustrates the operation of Proxy CAM and the problems of the system. The Proxy CAM device 1) detects the target vehicle and 2) delivers the proxy CAM to the receiver over IEEE802.11p. However, the system suffers from two significant problems, as described below.

1) *Limited wireless range*: As indicated by label a) in Figure 1, we observe that a message cannot be delivered beyond the wireless range. According to [15], if a car drives at 60 km/h, IEEE802.11p's packet delivery ratio (PDR) is nearly 100% for a received signal strength indicator (RSSI) value of -85 (about 800 m). However, the authors performed their experiments on level land in the absence of buildings and other electromagnetic interference; on the other hand, urban environments contain buildings and other forms of electromagnetic waves, which can lead to packet delivery failure beyond certain distances. Further, [10] have reported that the packet reach distance is about 60~70 m if there are buildings in the environment. Moreover, a CITS vehicle at 60 km/h cannot stop before an intersection. Thus, it is necessary to widen the coverage of Proxy CAM transmission.

2) *Interference and Obstacles*: Theoretically, Proxy CAMs can be received at roads connected to intersections. However, if a car is in a situation where another obstacle blocks the line of sight to the CAM transmitter, as indicated by label b) of Figure 1, it cannot receive Proxy CAMs. Further, if there is a vehicle such as a truck between a car and Proxy CAM device, the car cannot receive Proxy CAMs. Therefore, it is necessary to ensure that the Proxy CAMs surmount such obstacles.

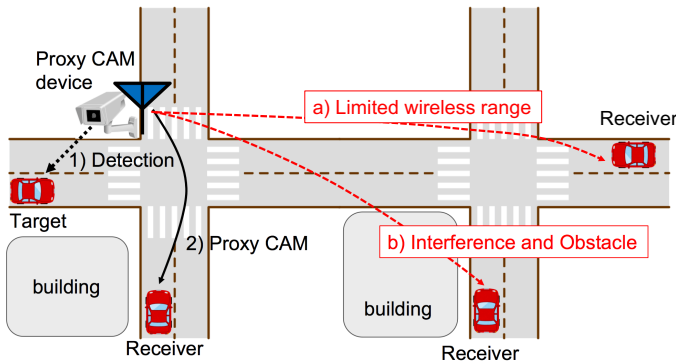

Figure 1. OVERVIEW AND PROBLEMS OF PROXY COOPERATIVE AWARENESS MESSAGE (CAM)

B. Requirements

To solve the abovementioned problems, we designed a system that uses a new protocol stack in addition to the original protocol stack, BTP/GN + IEEE802.11p. The following section lists the requirements of the new system.

1) *Message Transmission Coverage*: In urban environments, CAMs should be able to cover a range of distances. Our system can send CAMs to everyone in the coverage area regardless of the presence of buildings or large vehicles.

2) *Availability*: A CAM contains information regarding neighboring cars. Thus, the unavailability of a CAM for even 5 s can lead to an accident. Consequently, a system should allow CAMs to be sent any given time. Importantly, the communication should be stable (i.e., the PDR should be nearly 100%).

3) *Real-Time Information*: The position of a vehicle is dynamic, and therefore, CITS cars should always obtain updated information reflecting the real-time situation. That is, the time between the creation of a CAM and its reception should be as short as possible. Moreover, delays in sensing and message transmission must be minimized.

4) *Using existing protocol and wireless communication system*: For interoperability among countries, CITSs are developed based on a given architecture, protocols, and technologies. From the perspective of practical application, the system should not use new resources; it should consist of existing protocols and use wireless communication.

IV. REMOTE PROXY CAM

To satisfy the abovementioned requirements, we designed the Remote Proxy CAM.

A. System Design

In our system, we use LTE and the cellular network to satisfy the communication requirements. Since broadcasting is not allowed in cellular networks, we use unicast communication to access the dynamic vehicular information. We use IPv6 for the Remote Proxy CAM because it fulfills the CITS requirements through its extended address space, embedded security, enhanced mobility support, and ease of configuration. It also uses UDP because the delivered message comprises real-time data. By using UDP/IPv6, the packet can be transmitted over the LTE and a cellular network. Figure 2 shows the protocol stack of the proposed method. The vehicle with our proposed system receives Proxy CAMs via BTP/GN + IEEE802.11p as well as UDP/IPv6 + LTE.

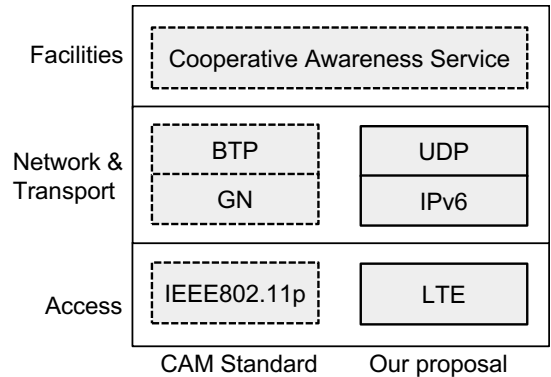

Figure 2. PROTOCOL STACK OF REMOTE PROXY COOPERATIVE AWARENESS MESSAGE (CAM).

Figure 3 shows the overview of the proposed method. First, a roadside computer vision sensor detects vehicles around the intersection and creates the corresponding CAMs. Next, the sensor broadcasts the CAMs. At the same time, the vehicle sends a Remote Proxy CAM request to the Proxy CAM device along the vehicle route as per the demand of the ITS application. When the Proxy CAM device receives a request message from a vehicle via the cellular network, it sends a Proxy CAM reply to the vehicle via the cellular network. If the vehicle receives Proxy CAMs via both IEEE802.11p and LTE, it updates the LDM entry with the newest information.

Here, we remark that the IP address discovery of the Proxy CAM device is out of the scope of the paper. Possible solutions for the IP address discovery include embedding the IP address in the digital map, downloading the static list of IP addresses, or resolving the IPv6 address from the geographical information by means of a DNS-like system.

1) *Vehicle*: A vehicle sends a request message for CAMs to the nearest Proxy CAM device along the vehicle route via the cellular network using UDP/IPv6 and LTE. If the vehicle does not receive a CAM response from the Proxy CAM devices after a given interval, it sends a request again. The vehicle always checks for CAMs using IEEE802.11p or LTE, and if it receives CAMs, it updates its LDM with the newest ones.

2) *Proxy CAM device*: The created CAMs are broadcasted using standard protocols based on ISO and ETSI. Our broadcast uses IEEE802.11p in the access layer and BTP and GN in network&transport layer. At the same time, the created CAMs are transmitted to vehicles that have sent requests for CAMs in the unicast via the cellular network. This communication uses LTE in the access layer and UDP and IPv6 in the network&transport layer. Further, this transmission continues for a specified interval, after which it is terminated. The transmission is resumed if the Proxy CAM device again receives a request.

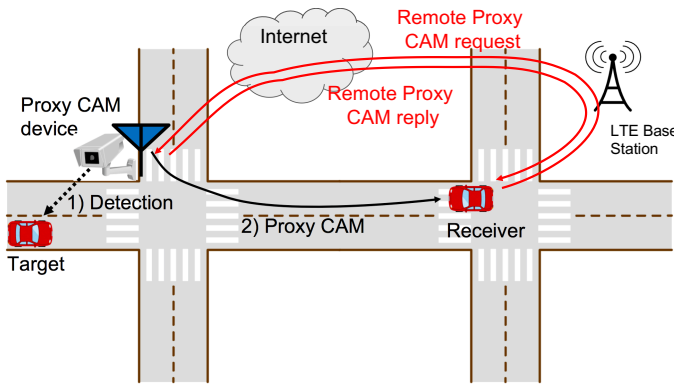

Figure 3. OVERVIEW OF REMOTE PROXY COOPERATIVE AWARENESS MESSAGE (CAM).

B. System Implementation

We implemented the cellular network part of our designed system as shown in Figure 4. We used the cellular device, REI (FTJ161B-REI) manufactured by FREETEL, in our study. We tethered the cellular device and the receiver through a USB cable. Our program was written in C language.

1) *Transmitter*: We used the LGN-20-00 transmitter manufactured by Commsignia Ltd. as the packet transmitter. The transmitter communicated with the router via a 50-m-long Ethernet cable in the access layer (Figure 4(a)). The router and receiver were connected via a 30-m-long Ethernet cable, and the transmitter was configured to send packets through the cable in order to measure the reference value of the delay (Figure 4(b)). These two sets of communications used UDP/IPv6 in the network&transport layer. We used multicast for pathway (a) and unicast for pathway (b) in Figure 4. The transmitter used a single program to send the same packet along the two paths. In order to realize the Pub/Sub model based on which the Proxy CAM device sends CAMs via the cellular network after receiving a request, the transmitter begins to function after receiving a request packet via pathway (a). The IP address of the destination in pathway (a) is the sender IP address in the request packet. As regards pathway (b), we set the global IP address of the receiver interface in advance.

2) *Router*: In our study, we used the PR-400NE manufactured by NTT as the router. The router and receiver were connected by means of a 35-m-long Ethernet cable. The firewall did not filter any kinds of IPv6 packets.

3) *Receiver*: We used the Tier PC Note GTX970M as the packet receiver. The processors in the device include the Intel Core i7-4720HQ CPU @ 2.60 GHz×8, with a memory capacity of 31.3 GB and the OS being Ubuntu 15.04. We tethered the receiver and cellular device through a USB cable. We used two programs: one to receive the packets via pathway (a), and the other to receive the packets via pathway (b). To realize the Pub/Sub model, we ensured that the receiver sent a request packet first.

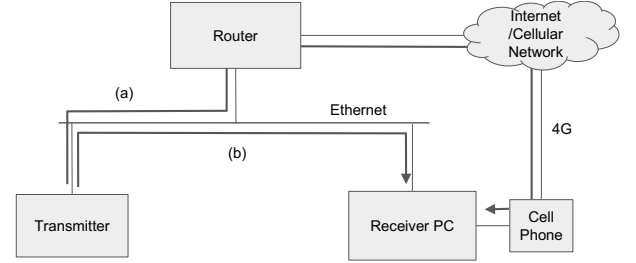

Figure 4. NETWORK CONFIGURATION.

V. EVALUATION

We evaluated the implementation of our proposed method in terms of the PDR and delay. We performed our experiments in a residential area. In the experiment, first, the transmitter is set to create sockets for pathways (a) and (b) in Figure 4 and to wait for the CAM request via pathway (a). When the transmitter receives the request, it sends out a given number of packets at a predetermined frequency. The size of each packet is 300 bytes, and there is a number in a certain packet that identifies it as the first packet. Next, the receiver creates sockets for pathways (a) and (b) and files to record the result. When the receiver receives a packet, it obtains the reception time using the `gettimeofday` function from `sys/time.h` and records the time to the file. After our experiment, we compared the reception time of the same number packets of the two files and measured the delay obtained using pathway (a).

We performed our experiments at frequencies of 1, 5, 10, 50, 100, 500, 1000 Hz and distances of 10, 30, and 50 m. To ensure that the PDR was more than three significant figures and the experiment time more than 60 s, we set the total number of packets as 100 for 1 Hz, 300 for 5 Hz, 600 for 10 Hz, 3000 for 50 Hz, 6000 for 100 Hz, 30000 for 500 Hz, and 60000 for 1000 Hz.

A. Packet Delivery Ratio (PDR)

The following table lists the PDR results of our experiments. From the table, we note that the PDR hardly depends on the frequency and distance. The maximum packet loss rate is 0.08%. In theory, it can also be said that the distance between the transmitter and the receiver does not matter because communication occurs between a cellular device and a base station. This experiment demonstrates that communication between the transmitter and receiver using the cellular network, UDP/IPv6 + LTE, is possible nearly 100% of the time regardless of the frequency and distance.

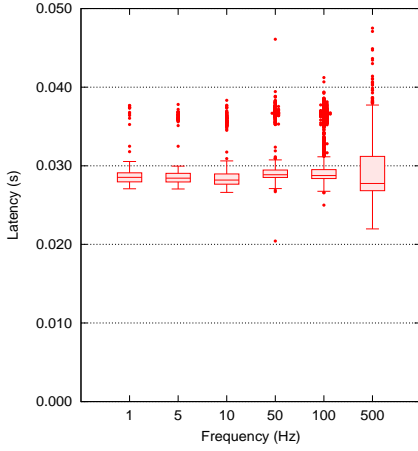

Figure 5. PACKET DELAY (10 m).

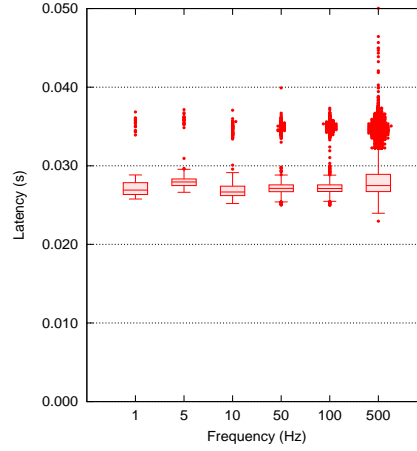

Figure 6. PACKET DELAY (30 m).

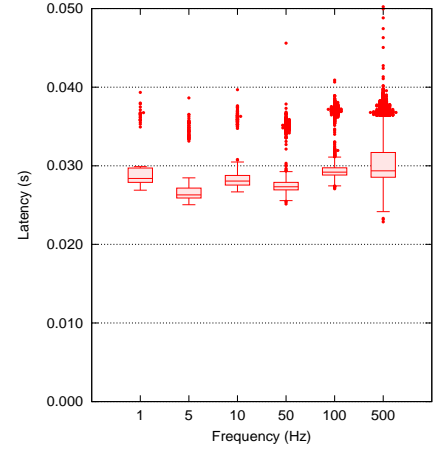

Figure 7. PACKET DELAY (50 m).

TABLE I. NUMBER OF RECEIVED PACKETS FOR VARIOUS DISTANCE WITH USE OF UDP/IPv6 + LTE.

	10 m	30 m	50 m
1 Hz (100 pkts)	100 pkts	100 pkts	100 pkts
5 Hz (300 pkts)	300 pkts	300 pkts	300 pkts
10 Hz (600 pkts)	600 pkts	600 pkts	600 pkts
50 Hz (3000 pkts)	3000 pkts	3000 pkts	3000 pkts
100 Hz (6000 pkts)	6000 pkts	6000 pkts	6000 pkts
500 Hz (30000 pkts)	29987 pkts	29980 pkts	29976 pkts

B. Packet Delay

Figures 5,6, and 7 depict the packet delay for different frequencies and distances. When we performed the experiment at 1000 Hz, the transmitter could not generate packets every 0.001 s. Therefore, we have excluded the result for 1000 Hz. The overall results indicate that the delay does not depend on the distance; it is constant at about 30 ms. As mentioned in the PDR section, the distance between the transmitter and receiver does not matter in theory.

Next, we attempt to further understand the implications of our results. First, to evaluate our results, we defined the misregistration delay as the time from the transmission of a CAM from a Proxy CAM device to the reception of the **next** CAM at the vehicle. This parameter indicates the difference in the position of the vehicle in terms of the CAM and the position of the vehicle in reality. We defined this parameter as the sum of the CAM reception interval and the packet delay. The reception interval can be calculated as the product of the CAM transmission interval and the reciprocal of the PDR. We defined the PDR as p_{PCAM} , frequency of CAM transmission as f_{PCAM} , and packet delay as $t_{PCAM-trans}$. Consequently, the misregistration was calculated using Equation (1).

$$\frac{1}{p_{PCAM}} \times \frac{1}{f_{PCAM}} + t_{PCAM-trans} \quad (1)$$

We calculated the misregistration delay from our results. We assumed the frequency of the CAM transmission as 10 Hz for the maximum desirable CAM broadcast frequency of 10

Hz according to [4]. We set the PDR to 1 because the results indicate that the PDR did not depend on the frequency and distance; further, the PDR was nearly 1. We also set the packet delay to 0.03 seconds. With these values, the misregistration delay was estimated as 0.13 seconds. We did not perform experiments using BTP/GN + IEEE802.11p, since it is not legal for application outside Japan. Therefore, we applied the result of the IEEE802.11b/g protocol as per the field test of [10]. In this case, the PDR was 90%, 80%, and 75% for distances of 10 m, 30 m, and 50 m, respectively. For the packet delay, the distance between the transmitter and receiver was a maximum of 50 m, and the electromagnetic signals were considered to travel instantaneously, i.e., the time of signal travel was 0 s. For these abovementioned values, the misregistration delay was estimated as 0.11 s, 0.126 s, and 0.133 s for distances of 10 m, 30 m, and 50 m, respectively. Upon comparing the misregistration delay of UDP/IPv6 + LTE with that of BTP/GN + IEEE802.11b/g, we concluded that UDP/IPv6 + LTE and BTP/GN + IEEE802.11b/g perform equivalently in terms of the performance speed.

C. Analysis on intersection scenario

Here, we discuss how our proposed method improves pedestrian and vehicular safety at intersections with respect to vehicle distance and approach speed towards an intersection. Let us consider the situation that a vehicle is approaching an intersection with an obstacle close by. To avoid collision with the obstacle, the vehicle must stop before it enters the intersection. In this study, we analyzed the distance required for the vehicle to stop before entering the intersection for the initial speed of the vehicle. We denoted the distance between the initial position of the vehicle and the intersection as d , its deceleration as m , which is assumed constant during the scenario, initial vehicle speed as v_0 , and time interval from the instant of consideration as t . The "safe" distance to avoid collision can be calculated using Equation (2) as follows:

$$d = \int_0^{v_0/m} v(t)dt = \frac{1}{2} \cdot \frac{v_0^2}{m}, \quad (2)$$

where $v(t)$ denotes the speed of the vehicle at time t and $v_0 = v(0)$ the initial speed of the vehicle. Figure 8 depicts

this safe distance d as the black solid curve obtained with m set to 1.0 m/s^2 .

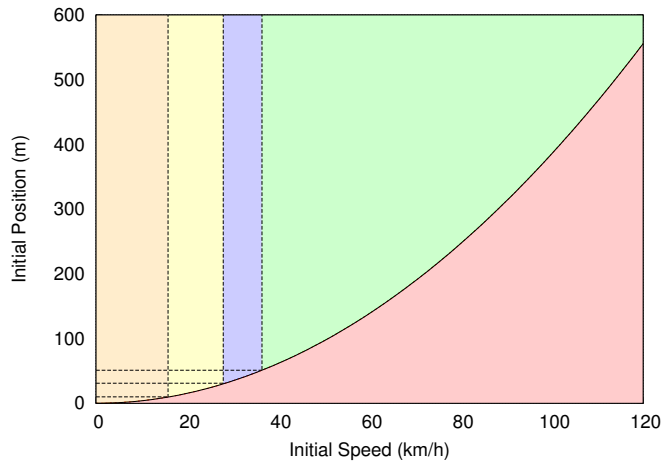

Figure 8. SAFE STOPPING DISTANCES FOR VARIOUS INITIAL DISTANCES TO INTERSECTION AND INITIAL VEHICLE SPEEDS.

In this figure, the region under the black curve (colored in red) indicates the unsafe distance-and-speed range, i.e., the vehicle is moving too fast, and it cannot stop before entering the intersection. The other four regions lying above the curve correspond to speeds and distances over which the vehicle can stop before entering the intersection if it receives a CAM or the driver sights the object/obstacle beforehand. There are four possible collision-prevention solutions corresponding to receiving a CAM or sighting the obstacle. Here, we summarize the effective distance for each solution. The first solution corresponds to sighting of the obstacle by the human eye or computer vision, which works well if the obstacle can be noticed. In the situation that the obstacle is in a blind spot, effective preventive action can only be taken when the vehicle is very close to the obstacle. Therefore, we set the maximum effective (communication) distance for this case as 10 m. The second solution corresponds to the use of the original CAM system. According to Figure 5(b) of [10], the maximum communication distance for such a system is 30 m. The third solution considers our Proxy CAM system, wherein the maximum distance depends on the situation. In the absence of buildings and other obstacles, CAMs can travel over 800 m ([15]). However, the effective braking distance is constrained by the presence of buildings and other large vehicles such as trucks or buses. Thus, we set the maximum distance to 50 m for the Proxy CAM case. The final solution considers the efficacy of our proposed method. This method uses both a cellular network and LTE. Thus, in theory, the system can work anywhere on the road (except in long tunnels). Therefore, its maximum communication distance can be considered as ∞ m.

Each of the abovementioned effective distances determines the safety margins of the intersection with obstacles nearby. Thus, the safety regions can be classified into the four regions shown in Figure 8. Human eyes and computer vision are the poorest solutions; their use can prevent an accident if the vehicle's position and speed lie in the orange region. The original CAM system can prevent an accident if the vehicle's position and speed lie in the orange and yellow regions. Meanwhile,

the Proxy CAM system can prevent collision if the vehicle's position and speed lie in the orange, yellow, and blue regions. The green region is still unsafe for all three solutions. However, the proposed method can still prevent accidents corresponding to the green region because our system can communicate regardless of the distance. Therefore, our proposed method is highly effective over existing technologies.

VI. CONCLUSION AND FUTURE WORK

We proposed a system called the Remote Proxy CAM that uses a cellular network with UDP/IPv6 + LTE in addition to the original Proxy CAM system protocol stack, BTP/GN + IEEE802.11p, in order to widen the coverage of the CAM transmission and improve failure tolerance. To evaluate this system, we implemented the cellular-network component of the system and performed various experiments. In the experiments, the transmitter sent packets to the receiver with various frequencies over different transmitter-receiver distances. Our results indicated that using the cellular network with UDP/IPv6 + LTE afforded a high PDR (nearly 100%) and low average delay of about 30 ms, which indicate that the proposed method is stable and operates in real-time. This method allows CITS vehicles to stably and consistently receive CAMs of faraway vehicles in real-time.

We are planning to focus on three aspects of the system in our future works. Currently, we have assumed that the vehicle knows the position and IP address of the Proxy CAM device; however, our system needs to have a discovery mechanism for discovering the proxy CAM device. Further, we need to examine possible solutions for device discovery, such as IP-address-embedded digital map, download-based solution, or a DNS-like system, as mentioned in section IV-A. Second, we require a system that compares the created time of CAMs across both IEEE802.11p and LTE and then updates LDM with the newest times. Finally, we performed our experiments with one receiver while actual situations would require more receivers. Thus, the proposed method should be tested with multiple receivers and the signal delay must be investigated.

ACKNOWLEDGEMENT

The authors would like to thank Ye TAO and Xin LI for their help with the field tests and various comments on the paper. This work was supported by JSPS KAKENHI Grant Numbers JP17H04678 and JP26730045.

REFERENCES

- [1] Vehicle Information and Communication System, URL: http://www.vics.or.jp/known/about/pdf/vics_pamphlet_j.pdf, Retrieved: Jun, 2017.
- [2] Outline of ETC2.0, URL: <http://www.go-etc.jp/etc2/etc2/index.html>, Retrieved: Jun, 2017.
- [3] Draft ETSI EN 302 636-3 v1.1.2(2014-03), Intelligent Transport Systems (ITS); Vehicular Communications; GeoNetworking; Part 3: Network Architecture, 2014.
- [4] ETSI EN 302 637-2 v1.3.2(2014-11), Intelligent Transport Systems(ITS); Vehicular Communications; Basic Set of Applications; Part 2: Specification of Cooperative Awareness Basic Service, 2014.
- [5] ETSI EN 302 637-3 v1.2.2(2014-11), Intelligent Transport Systems(ITS); Vehicular Communications; Basic Set of Applications; Part 3: Specifications of Decentralized Environmental Notification Basic Service, 2014.
- [6] ETSI EN 302 895 v1.1.1(2014-09), Intelligent Transport Systems(ITS); Vehicular Communications; Basic Set of Applications; Local Dynamic Map(LDM), 2014.

- [7] Intelligent Transport Systems (ITS); Vehicular Communications; GeoNetworking; Part 5: Transport Protocols; Sub-part 1: Basic Transport Protocol, 2011.
- [8] Intelligent Transport Systems (ITS); Vehicular communications; GeoNetworking; Part 4: Geographical addressing and forwarding for point-to-point and point-to-multipoint communications; Sub-part 1: Media-Independent Functionality, 2011.
- [9] IEEE Standard for Information technology-Telecommunications and information exchange between systems-Local and metropolitan area networks-Specific requirements Part 11: Wireless LAN Medium Access Control(MAC) and Physical Layer(PHY) Specifications Amendment 6: Wireless Access in Vehicular Environments, 2010.
- [10] T. Kitazato, M. Tsukada, H. Ochiai, and H. Esaki, "Proxy cooperative awareness message: an infrastructure-assisted v2v messaging," in 2016 Ninth International Conference on Mobile Computing and Ubiquitous Networking (ICMU), Oct 2016, pp. 1–6.
- [11] M. Bagheri, M. Siekkinen, and J. K. Nurminen, Cloud-Based Pedestrian Road-Safety with Situation-Adaptive Energy-Efficient Communication, 2016, URL: <http://ieeexplore.ieee.org/document/7518724/>, Retrieved: Jun, 2017.
- [12] C. A. Sakurai, C. L. Marte, L. R. Yoshioka, and C. F. Fontana, "Integrating intelligent transportation systems devices using power line communication," in Recent Researches in Telecommunications, Informatics, Electronics and Signal Processing, 2014, pp. 36–42.
- [13] A. Baiocchi, F. Cuomo, M. D. Felice, and G. Fusco, "Vehicular ad-hoc networks sampling protocols for traffic monitoring and incident detection in intelligent transportation systems," in Transportation Research Part C: Emerging Technologies Volume:56, Mar 2015, pp. 36–42.
- [14] D. Eckhoff, C. Sommer, R. German, and F. Dressler, "Cooperative awareness at low vehicle densities: How parked cars can help see through buildings," in 2011 IEEE Global Telecommunications Conference - GLOBECOM 2011. IEEE, Dec 2011, pp. 1–6.
- [15] O. Shagdar, M. Tsukada, M. Kakiuchi, T. Toukabri, and T. Ernst, "Experimentation towards ipv6 over ieee 802.11p with its station architecture," in International Workshop on IPv6-based Vehicular Networks, Jun 2012, pp. 1–6, URL: <https://hal.inria.fr/hal-00702923>, Retrieved: Jun, 2017.