



**HAL**  
open science

# Modelling and Control of Wind Farms Integrated with Battery Energy Storage Systems

Mohammad Taghi Zareifard

► **To cite this version:**

Mohammad Taghi Zareifard. Modelling and Control of Wind Farms Integrated with Battery Energy Storage Systems. [Research Report] university of new south wales 2017. hal-01573257

**HAL Id: hal-01573257**

**<https://hal.science/hal-01573257v1>**

Submitted on 9 Aug 2017

**HAL** is a multi-disciplinary open access archive for the deposit and dissemination of scientific research documents, whether they are published or not. The documents may come from teaching and research institutions in France or abroad, or from public or private research centers.

L'archive ouverte pluridisciplinaire **HAL**, est destinée au dépôt et à la diffusion de documents scientifiques de niveau recherche, publiés ou non, émanant des établissements d'enseignement et de recherche français ou étrangers, des laboratoires publics ou privés.

# **Modelling and Control of Wind Farms Integrated with Battery Energy Storage Systems**

by

**Mohammad Taghi Zarei Fard**

2017

# Abstract

The ever expanding of greenhouse gas emission and limitation of fossil energy sources are driving demand for the green energies. Among the variety of the renewable energy sources, the wind power in large scale is known as the best replacement for the conventional source of energies. However, due to the intermittency of wind power, this source without any control is not efficient neither technically nor economically. Technically, fluctuation of wind power should be smoothed while it is dispatched to the grid power to avoid system faults. On the other hand, in competitive deregulated electricity market, the financial issue concerns the economic revenue of wind power plant. It is well understood that applying storage system with proper control mechanism is required to address to technical and economical shortcomings.

In this report, a new control strategy is presented to manage the amount of energy that is generated by wind farm plant and sold to the electricity market. Contributions of this report are three-fold: 1. As the battery plays a fundamental role in our control system, we addressed a novel generic battery model which reflects the effects of chemical reactions as the battery is charging, discharging and storing energy; 2. Our control method reduces the fluctuation of supplied wind power while it empowers the operator to make a balance between energy supply and demand in a profitable way using battery energy storage; 3. Lastly, we employ monotonic charging and discharging strategy in our control system to maximize the profit of WPP operator by significantly reducing the capital cost.

Optimization of the overall system behavior given physical constraints using the Model Predictive Control (MPC) is one of the advantages of the proposed system. Moreover, adaptive updating of a reference signal based on system states, predicted price and wind power data helps improve the controllability of the wind farm power generation with the Battery Energy Storage System BESS into the electricity market while keeping the ramp rate of the power signal within a predefined range. Furthermore, it is depicted that battery capacity has highly affected on profit of the WPP. Therefore, choosing a suitable amount of battery for a specific WPP can improve the efficiency accordingly. The controller managing the Wind and battery energy storage is based on MPC theory and dynamic programming. Wind and price predictions are attached to the system for enhancing its improvement.

# Contents

<b>1</b>	<b>Introduction</b>	<b>2</b>
1.1	Introduction . . . . .	2
1.2	Wind power challenges . . . . .	3
1.2.1	Technical wind power challengers . . . . .	3
1.2.2	Economical wind power challengers . . . . .	3
1.3	Energy storage and wind power . . . . .	4
1.4	Australian energy market . . . . .	4
1.5	Control system design . . . . .	5
1.6	Contributions . . . . .	5
1.7	Report outline . . . . .	6
<b>2</b>	<b>A Nonlinear Battery Model</b>	<b>7</b>
2.1	Introduction . . . . .	7
2.2	Battery Model . . . . .	8
2.2.1	Charging and discharging analysis of the battery . . . . .	9
2.3	Modeling battery energy storage for wind power plant application . . . . .	10
2.4	BESS model for Sodium Sulfur (NAS) battery . . . . .	12
2.5	Conclusion . . . . .	15
<b>3</b>	<b>Model Predictive Control for Wind Power Generation Smoothing with Controlled Battery Storage Based on A Nonlinear Battery Mathematical Model</b>	<b>16</b>
3.1	Introduction . . . . .	16
3.2	Problem Statement . . . . .	17
3.3	Control System Design Description . . . . .	18
3.3.1	Proposed Prediction Model . . . . .	19
3.3.2	Controller Design . . . . .	19
3.4	Simulation . . . . .	21
3.4.1	Database . . . . .	21
3.4.2	Battery Type Selection . . . . .	21
3.4.3	Results and discussion . . . . .	22
3.5	Conclusion . . . . .	23

<b>4</b>	<b>Maximizing Profit of a Wind Battery Energy System Using Model Predictive Control Driven by a Dynamic Reference Policy</b>	<b>26</b>
4.1	Introduction . . . . .	27
4.2	Problem Description . . . . .	29
4.2.1	Dynamic model of the system . . . . .	29
4.2.2	Reference Generator . . . . .	29
4.2.3	Wind Power Prediction Model . . . . .	31
4.2.4	Price Prediction . . . . .	31
4.2.5	Controller Design . . . . .	31
4.3	Simulations . . . . .	33
4.3.1	Dataset . . . . .	33
4.3.2	Battery Type Selection . . . . .	34
4.3.3	Results . . . . .	34
4.3.4	Impact of dynamic storage policy . . . . .	38
4.4	Summary . . . . .	45
<b>5</b>	<b>A Simulation Study on Impact of Monotonic Battery Charging/Discharging on Cost and Revenue of Wind Power Plant</b>	<b>47</b>
5.1	Introduction . . . . .	47
5.2	Problem Statement . . . . .	48
5.3	Monotonic charging/discharging methodology . . . . .	49
5.4	Control System Design Description . . . . .	49
5.4.1	Dynamic Model of the System . . . . .	49
5.4.2	Controller Design . . . . .	50
5.5	Simulation Results . . . . .	53
5.6	Conclusion . . . . .	56
<b>6</b>	<b>Conclusions and Future Works</b>	<b>58</b>
6.1	Conclusions . . . . .	58
6.2	Future works . . . . .	59

# Chapter 1

## Introduction

### 1.1 Introduction

In recent years, energy policies of worldwide are moving toward exploiting Renewable Energy Sources (RES) such as the wind and solar energies. Since greenhouse gas emission is caused by consumption of fossil energies, it persuades governments to motivate electricity plant operators to switch to the renewable sources. Moreover, increasing electricity demand and the crisis in fuel price in the world led us to utilize green resources. Due to the technology improvements among all renewable energy resources, wind power gets the attention of many developed countries as a clean and cheap source of energy for future generation. [1, 2].

Furthermore, Recent impressive technical and economical developments in wind power energy generation led to engage large percentage of electricity generation by this source of energy specially in European countries such as Denmark and Germany [3,4]. However, there are many troubles and challenges ahead when large percentage of energy produce by wind power as its pure power without any control can not satisfy the standards.

There are some technical and financial issues ahead of applying this source of energy which are required to be organized in a way that wind power can be dispatchable to the grid network to be technically reliable and financially profitable.

In this regard, some issues such as fluctuation of wind power plant output that causes by the nature of wind power should be controlled so that the output power to the grid can not destroy the electricity grid [5, 6]. Other trouble that should be managed is the stability of wind power. Furthermore, since Wind Power Plants (WPPs) in large scale are one of the major electricity producers in developed countries [7], they need to contend in the competitive electricity market to sell their energy. Therefore, again fluctuated nature of this source of energy raises another challenge which needs to be deliberated to improve the overall income of the WPP.

## 1.2 Wind power challenges

### 1.2.1 Technical wind power challengers

In order to increase the portion of wind power in network electricity grid in compare with other sources of energies, we need to decrease the issues that raise up in usage of wind power. The intermittency of wind power is called 'Ramp Rate' [8]. This phenomenon should be under control that this power be able to match the standards of electricity network grid. In Fig.1.1 a sample of one day wind power is illustrated. Ramp rate is shown in this typical real sample of wind power for one day. Another challenge is transmission of wind power in large scale. In this situation, in order to avoid congestion in the line that transmit the power, the output power needs to be crossed off [9].

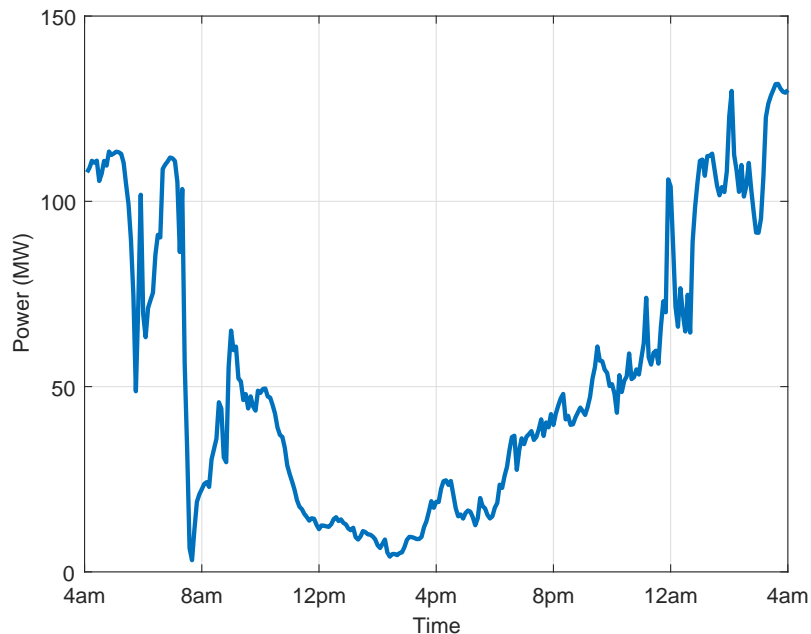

Figure 1.1: One day typical wind power.

### 1.2.2 Economical wind power challengers

In the competitive deregulated electricity market such as in Australia, financial issue concerns the economic revenue of wind power plant. Although wind power is accessible occasionally depends on weather condition, an appropriate control strategy is required to maximize the economic benefits form WPP.

### 1.3 Energy storage and wind power

At first glance, a applicable solution to cope with this challenge is adding an Energy Storage System (ESS) to the wind power plant. This idea not only can save the energy in times of off peak and low demand but also it can reduce all technical challenges which explained above [10]. Currently, the cost of this technology is quiet high [11] but there are such a good improvements have be done in this area to reduce the capital cost of energy storages.

In recent years there are two main subjects that researchers have focused on as interested fields in renewable energy industry.

1- Reducing the ramp rate or in other word smoothing the output power from wind power plant

2- Increasing profit of implementing wind power in the competitive electricity market.

A key objective of both problem statements leads to make the wind power more dispatchable. Since In majority of related works, energy storage system is integrated to the wind, we first review battery energy storage as the main tool in this study and then its application in wind power plant will be discussed. There are several energy storage technologies which are applied in industries to store the energy recent years. Flywheels, batteries, supercapacitors, hydrogen, pneumatic, and pumped storage technologies are some examples which they are currently employed in power industry to accumulate the energy for different purposes. Review studies on energy storage technologies show that batteries are the common devices that apply for power system utilities [12]. Therefore, in this report we focus on battery energy storage as a powerful and reliable devise for storage and control purposes. Using batteries in combine with wind power plant will improve not only the overall performance of the dispatched power but also it will increase the total revenue of WPP. However, there are different strategies in applying BEES with WPP [12] .Hence, one of main scopes of this report is using an appropriate control strategy to raise the performance of battery and at the same time mitigate the explained challenges while using wind power. To increase the performance and also improve accuracy of the controller, we are looking for an appropriate battery model which reflects the characteristics of battery features. In all previous studies, battery models belong to a specific kind of battery and therefore it cannot be applicable to other type of batteries. In this report we propose a new nonlinear battery model which represents most properties of a battery while it is integrate with wind power plant. With the aid of this comprehensive nonlinear model, we can control the system by considering most features of the system and in this regard designing the controller could be more accurate in compare with related works.

### 1.4 Australian energy market

Studying on Electricity market by itself is a research topic which is out of the scope of this report. However, we need to apply the regulations of electricity market



in our design section to improve the revenue of WPP. Therefore, a perspective of Australian National Energy Market (ANEM) as the case study target is required. ANEM is known as one of the powerful and dynamic markets in the world. We proposed our control strategies in price section based on the regulation of ANEM since our data basis in this report gathered from ANEM. The regulations will be explained in chapter 4 of this report.

## 1.5 Control system design

In the last few decades, Model Predictive Control (MPC) has gained the attention of researchers in industry to obtain the benefit of this control method to enhance the performance and capabilities of their systems. One of the most important factors which effect on choosing this control method in industry and is its potential to handle the systems with physical limitations which are difficult to control with other control methods such as PID. Wind power plant as the case study of this report, has variety of practical system constraints such as battery charging and discharging threshold and wind power plant maximum and minimum capacity. Indeed, we choose MPC as a practical solution to mitigate these challenges. Since the nonlinearity of the battery model, dynamic programming as a powerful optimization tool has been selected in this study which will be expanded in chapters 4-6.

## 1.6 Contributions

Nowadays, wind power penetration in worldwide is increasing with a high rate in compare with other types of renewable energy sources; therefore, we highlighted the challenges that turn up as a result of connecting wind power into the electricity market, technically and financially. Batteries provide a feasible solution when they are integrated with wind farms. As one of the main contributions of this report, we proposed a new nonlinear battery model which has a general characteristic rather than type of battery in order to facilitate designing a hybrid battery and wind power. This model considers internal features of battery by defining specific parameters based on battery type. In the next stage, we implemented the new model to smooth out the wind power output using model predictive control. Since the proposed model is nonlinear, the optimization method which we combined with MPC is dynamic programming. As the other novel contribution in this study, we proposed a reference generator in our controller design section to improve the performance of the output plant. The policy of this reference generator is based on wind power and electricity market price prediction. The policy behind applying this mathematical reference generator in the proposed control scenario is increasing overall revenue of the plant. At last, this study provides a solution to choose an appropriate battery capacity for any specific wind power plant while it is connected to battery energy storage by considering maximum revenue of the plant. Since the charging/discharging behavior of battery has a significant impact on both cost and revenue of wind power plant

(WPP), we combine the monotonic charging/discharging methodology to our system design. This causes minor reduction in revenue of wind power plant by decreasing the total battery capacity while we employ optimal size of BESS.

## 1.7 Report outline

In this chapter we explained about the basic motivation for the work and introduced the problem statement. We also highlighted the contributions of the study in brief. The rest of the report is organised as follows:

Chapter 2 presents a new and novel nonlinear battery model. In this chapter firstly we discuss about the reasons of designing a new battery model. In addition, the detail stages of designing a general state space battery model are explained. Since the this model designed for any type of batteries depends on the defined parameters, we choose Nas battery (sodiumsulfur battery) as a case study and we proposed this specific battery model for implementation in later chapters in order to control the wind power.

Chapter 3 provides a control strategy to decrease the ramp rate of the wind power with the aid of new model which defined in chapter 3. We present an MPC approach to smooth wind power fluctuations while the plant integrated with BESS. Next the control objectives and physical constraints of the system are specified. Following that, an overview and a basic formulation of model predictive controller with dynamic programming optimization is described. Then, the efficiency of this control strategy is assessed under different scenarios via simulation of an actual wind farm data.

Chapter 4 covers a market oriented control approach of wind power plant. In this chapter, we model a wind power plant in a close loop system. We implement MPC with dynamic programming approach to increase the overall revenue of WPP. In this chapter we propose a strategy to produce a reference signal which is based on a mathematical model. Then, the simulation results are presented. The wind power data which applied in the simulation are obtained form an actual wind power plant in Australia and also the price data are provided by Australian energy market database. At the end, the battery capacity and its effect on revenue is examined under different scenarios in order to provide a best match capacity with specific wind power plant.

Chapter 6 brings forward the effect of charging/discharging methodology and optimal battery capacity on both the cost and the revenue of wind power plant. In this chapter we apply the monotonic charging/discharging strategy as one of the effective solutions of reducing both overall battery capacity and capital cost of wind power plant on the control system design which has been introduced in chapter 5. Following that, the revenue analysis of WPP in presence of monotonic charging/discharging strategy is discussed.

chapter 7 concludes the report by discussing the achievements of this report and potential future works.

# Chapter 2

## A Nonlinear Battery Model

Due to the recent researches in the renewable energy area, integrating wind power plants to a energy storage systems is a method to enhance the technical efficiency of WPP and also increase the revenue of these systems [13]. Furthermore, some studies are dedicated to the type of ESS in order to determine what kind of ESS technologies are technically more adjustable to WPP. In [12, 14], all types of ESSs technologies are compared and finally the authors in [12] suggested that battery energy energy storage system is a suitable choice for integrating with wind farms in order to reach to a maximum benefit. However, an important issue in this regard is the model of the battery. In the last few years, lots of efforts have been accomplished to generate a model for the batteries. In [15–18] a few models are designed based on the type of batteries and their unique specifications. Most of them use impractical assumptions that lead to some errors when they employ in integration with WPP. [19, 20]. Therefore, a novel nonlinear battery model which reflects most characteristics of battery is presented in this chapter.

### 2.1 Introduction

In recent years, battery becomes one of the most attractive researched elements because of its significant rule in power systems engineering and specifically in renewable energy plants such as wind power [21–23]. Integrating batteries with wind power plant provides an opportunity to develop the technical and financial issues related to wind power nature [19, 20]. In most of the studies, researchers emphasis on battery technology, battery chemistry, battery charging-discharging schedule and some studies concentrate on battery parameter estimation. However, there is not any comprehensive model which reflect all features of batteries and can be expandable to all types of batteries in order to simulate battery model in wind power system.

In order to estimate parameters of the battery, large quantity of data is needed to produce a model based on experimental data and therefore in this type of estimation which is not accurate the model is unique and it can not be expanded to other types of batteries even in the same category [24–27]. Due to lack of a generic model for

batteries in simulation studies, there are variety of softwares which can be applied. In this case, there are some problems that occurs. For instance, they only reflect battery charging or discharging characteristic. In the other words, available models are not capable to reflect the behaviour of battery in all the possible situations such as charging, discharging and storing periods.

In [28] a type of generic battery model has been introduced. In this study, the manufacturers battery discharging characteristic curves is represented with the aid of data sheet of that specific battery model. However, this method as we described earlier in this chapter are not be able to show a comprehensive schematic of batteries. For instance in [28] hysteretic effect is assumed to be zero and therefor in the cases that current of discharging is high this proposed model will not be accurate enough. In order to avoid generating excessive complexity, in [19,20] representative models for the battery is considered as linear for simplicity. They consider the linear relationship between input and output of the energy.

These type of linear models [20] imply that the total energy is entered into the battery can be delivered out with no loss and therefore the battery model roles as an ideal storage with 100 % efficiency. This model is not able to represent some parameters which impact on the battery as some chemical reactions inside the battery [29] that cause nonlinear behavior during charging, storage and discharging. There are also some ambient effects such as temperature and humidity that can influence the performance of the battery.

Each type of battery based on its chemical and physical character has a different mathematical model. Though, a unique model which can be applicable to all types of batteries has not been published yet.

Therefore in this chapter, we introduce a generic model which can be spread out to any type of battery by defining its coefficient depends on the specific type of battery. To achieve a good estimation of the output of wind power plant, we need a battery model that considers the leakage of the energy and the rate of charging/discharging. One of the advantages of this model is that it takes into account the leakage of the energy inside the battery not only during charging and discharging but also when the energy is stored inside it.

## 2.2 Battery Model

In general there are different types of battery model which are applicable in industry and research studies. Some models are based on voltage and current of battery circuits which explained in chapter 2. These types of models are not matched with energy models when the battery is simulated in energy model of wind power plant. Therefore, in our later control design we are looking for a energy model of battery which describes features of this energy storage system. Before we go through the design part of the research we need to have an overview about the battery characteristic.

### 2.2.1 Charging and discharging analysis of the battery

Basically, any changes inside of the battery include charging, discharging and storage processes are based on chemical reactions which varies with the following conditions:

1. State of Charge
2. Battery storage capacity
3. Rate of charge/discharge
4. Environmental temperature

Hence, in order to have a comprehensive model, each of these conditions should be considered.

Since we are going to introduce a generic energy model of the battery, we divide the battery behaviour within three main periods:

- Charging period
- Discharging period
- Storing period

In each of the above durations, battery has different action which is essential to be analysed before designing the model.

#### Charging mood

While the battery is charging, a conversion of energy occurs inside the battery. Based on the parameters such as ambient temperature, rate of charge, battery capacity and state of charge, a specific amount of entering energy absorbed inside the battery. For instance, there are some losses within the internal resistance of battery which results a fraction of energy to be dumped.

#### Discharging mood

During the discharge process, similar to the charging regime, ambient temperature, rate of charge, battery capacity and state of charge of the battery influence on the amount of energy which is extracted from the batter. However, these effects are not the same as charging based on empirical results from any type of batteries. It is observed that the percentage of loss energy in the discharging process is larger than the time of charging with the same conditions.

To have a exact overview about the characteristic of battery during charging and discharging process, manufacturer data is mandatory which is provided in their catalogue. Therefor, we employ these data in our design and it is explained in next section.

The effect of temperature also need be investigated since it can change the rhythm of charging and discharging. In [30] and [31] this phenomena is studied for various temperature for Li-ion batteries and lead acid batteries respectively.

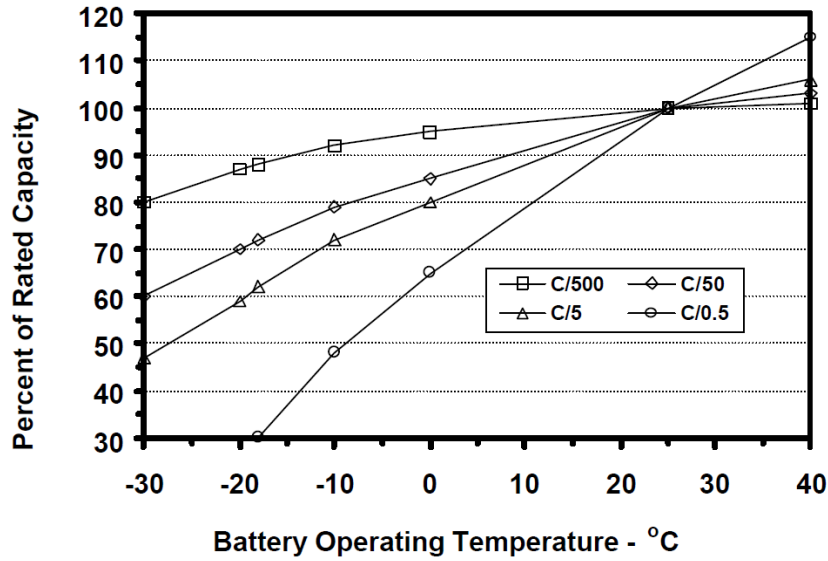

Figure 2.1: Effect of temperature on battery capacity [32].

### Storage mood

In those times that energy stores inside the battery without any charging or discharging, some energy will loss due to the chemical reactions inside the battery. The rate of this deduction is factors which is highly depends on type of battery and the materials which the battery has been made by them [32].

In all of the above mentioned situations, temperature plays a fundamental rule since its has highly effect on the performance of the battery. Fig.2.1 shows the impact of temperature on lead acid battery capacity. In order to achieve maximum efficiency from the battery, normal ambient temperature which is 25° as the experimental test results reveal this idea [32].

The age of battery is another factor which has direct influence on its output. Experiments reveal that self discharge rate of the batteries increase as the its age grow up [32].

## 2.3 Modeling battery energy storage for wind power plant application

On of the important issues in modeling renewable energy plant is providing a simple and applicable model although it is comprehensive. Battery energy storage is a key part of wind power plant, though a practical model help a control designer to control and optimize the performance of real plant easier. As mentioned earlier in introduction and literature review sections, there are variety of battery energy storage models which each of them specifically represent one particular type of battery. In this these we put our effort to propose a new generic model based on all properties of batteries which has been explained earlier in this chapter. This new

model can be applied to any type of batteries by defining some parameters which are required to be identified.

Since the real behaviour of the battery is nonlinear and we are looking for a model which demonstrate this manner, a nonlinear model of BESS is defined in the state space form as follows:

$$x(k+1) = f(x(k)) + g(x(k), u(k)) \quad (2.1)$$

We define functions  $f$  and  $g$  as follow,

$$f(x) = \alpha(x)x \quad (2.2)$$

and,

$$g(x, u) = \begin{cases} \beta(x)Mc & \text{for } u > Mc \\ \beta(x)u & \text{for } 0 \leq u \leq Mc \\ -\gamma(x)u & \text{for } -Md \leq u < 0 \\ -\gamma(x)Md & \text{for } u < -Md \end{cases} \quad (2.3)$$

with following constraints

$$\begin{cases} f(x(k)) \leq x(k) & \forall x(k) \\ g(x(k), 0) = 0 & \forall x(k) \\ g(x(k), u(k)) \leq u(k) & \forall x(k), u(k) \end{cases} \quad (2.4)$$

Table 5.1 defines parameters of battery model.

Table 2.1: Parameters of Battery Model

Parameter	Description	Unit
$\alpha$	Battery self discharge rate	%/day
$\beta$	Charging efficiency	%
$\gamma$	Discharging efficiency	%
$Mc$	Maximum charging threshold	MW
$Md$	Maximum discharging threshold	MW

In (2.5),  $x(k)$  and  $u(k)$  are the energy inside of the battery and energy fed to the battery, respectively. The battery is charged with positive input energy ( $u(k) > 0$ ) and discharged with negative input ( $u(k) < 0$ ).

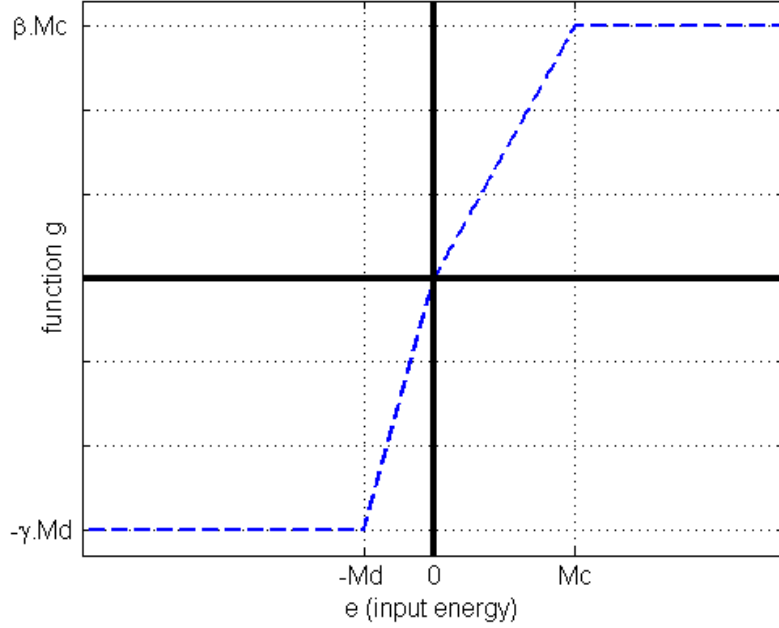

Figure 2.2: Function  $g(x,e)$

According to the experimental results from different type of batteries such as lead acid and sodium sulfur (NaS), and based on the trend of charging, discharging and storage moods, functions  $f$  and  $g$  are designed by the following strategies. In (2.6), function  $f$  captures the state loss while energy is stored in the battery. Rate of loss is defined by battery self-discharge rate ( $0 < \alpha(x) < 1$ ) which varies on  $x$ . The absorbed energy in battery is represented by  $g$  in (2.7) as a function of feeded energy ( $u(k)$ ) and also amount of energy inside the battery ( $x(k)$ ). In Fig. 3.8, atypical the behaviour of function  $g$  is illustrated. For positive input energy, the battery will be charged by the rate of  $\beta(x)$  ( $0 < \beta \leq 1$ ) till it gets saturated at  $M_c$ . The same trend is observed in the discharging process by rate of  $\gamma(x)$  ( $\gamma \geq 1$ ), when input energy is negative. Depends on the amount of state  $x$ ,  $\alpha, \beta$  and  $\gamma$  will be changed. In general case, there is a contrariwise relation between  $x$  and these coefficients. This idea comes from the fact that if battery reaches to its full capacity, a higher percentage of energy will lose inside it. The relationship between  $\alpha, \beta$  and  $\gamma$  and  $x$  can be figure out by experimental examination on a specific type of battery.

## 2.4 BESS model for Sodium Sulfur (NAS) battery

As a case study, we choose NAS (sodium-sulfur) battery because of its compatibility when it is integrated to the wind power plant in compare with other type of battery technologies. The NAS battery was firstly implemented as a device to manage the energy for purpose of 'load leveling' and 'peak shaving' and the first place which this



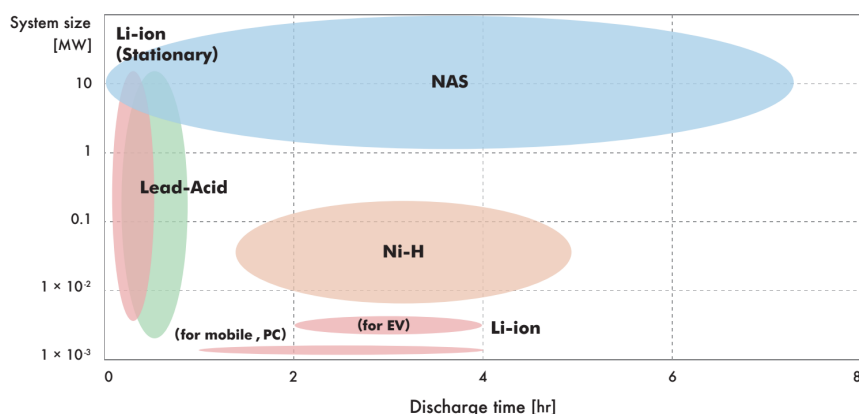

Figure 2.3: 'System size Vs discharge time of NAS battery in compare with other common industrial batteries' [38].

type of battery applied was in Japan [14,33,34]. Due to the technology development in the industry of battery production, NAS was designed in such a way to response in large scale in order to increase the quality of power in demand section [35–37].

There are three main reasons that we choose this type of battery in our study:

1. Long duration
2. High Power
3. Long life expectancy

#### 1- Long duration

It is shown that NaS batteries among other kind of batteries are more suitable for large scale usages such as implementing them in wind power plants [33]. In the other word, NaS batteries are able to produce energy three times more than lead acid batteries as a result of their 'per unit volume' which are higher in compare with the lead acid ones [35]. In Fig.2.3 this feature is illustrated.

#### 2- High power

Nas batteries are compatible with large scale plants such as wind or solar (10 to 100s of MW) [33,35,38]. In order to control wind power plant in large scales, NAS is the best choice in terms of its efficiency and compatibility.

#### 3- Long life expectancy

One of the other features of this specific battery is its high capacity in terms of energy and its 'long life span' as it is counted at 100% depth of discharge (DOD) up to 2500 cycles [39]. Fig.2.4 shows a typical wind power plant which is equipped with NAS battery. Based on the data collection from manufacturer catalogue of NAS battery which includes charging and discharging trends and also other factors such as temperature effects, we extracted our model parameters for this batter. Later in chapter 4,5 and 6 we employ this model in our control designs. In order to simplify the model, in this particular case of study, we assume all  $\alpha, \beta$  and  $\gamma$  as constant for all  $x$ . Battery model parameters are defined in Table.2.2.

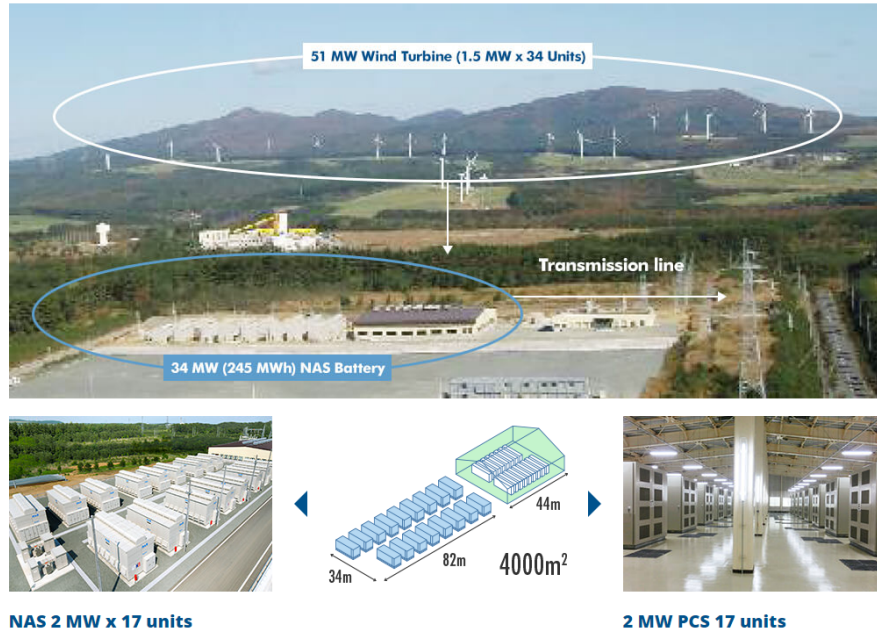

Figure 2.4: A sample wind farm with capacity of 34MW 51 MW and integrated NAS battery with capacity of (245 MWh). [38].

Table 2.2: Battery model parameters for NAS battery

$\alpha$	0.98
$\beta$	0.95
$\gamma$	1.05
$M_d$	-37
$M_c$	54

Therefore, the nonlinear NAS battery model is as follow:

$$x(k+1) = f(x(k)) + g(x(k), u(k)) \quad (2.5)$$

Which based on the battery model parameters in Table.2.2, functions  $f$  and  $g$  are defined as:

$$f(x) = 0.98x \quad (2.6)$$

and,

$$g(x, u) = \begin{cases} 0.95Mc & \text{for } u > Mc \\ 0.95u & \text{for } 0 \leq u \leq Mc \\ -1.05u & \text{for } -Md \leq u < 0 \\ -1.05Md & \text{for } u < -Md \end{cases} \quad (2.7)$$

## 2.5 Conclusion

Battery energy storage system plays a fundamental role in controlling and enhancing the performance of renewable energy sources. There are wide range of batteries in industry and each type has its own unique features. Control designers need to figure out appropriate mode base on the battery that they apply in their system. Therefore, lack of a generic energy model of BESS for all types of batteries is sensed. In this study, based on all features of batteries and a deep literature review on available battery models, we proposed a generic energy model for BESS which can be exploited in renewable energy plant applications. As a case study for later works, we provided model parameters for NAS battery in this chapter.

## Chapter 3

# Model Predictive Control for Wind Power Generation Smoothing with Controlled Battery Storage Based on A Nonlinear Battery Mathematical Model

The aim of this chapter is to design a controller based on model predictive control (MPC) theory along with a nonlinear battery energy storage model to smooth wind power output by controlled storage of the wind energy in battery with respect to use battery plant and battery constraints. The goal of the control is to use BESS maximally smoothing the output power dispatched to the grid while using forecasted wind power. This chapter is organised as follows. A brief introduction is provided in section 4.1. Following that, section 4.2 states the problem. In section 4.3 the proposed control system and the controller design are described. The simulation results are given in Section 4.4 .Finally, the chapter is concluded in Section 4.5.

### 3.1 Introduction

In recent years, due to technology improvements among all other renewable energy resources, wind power gets attention of many developed countries as a clean and cheap source of energy for future generation [1, 2]. However, Stochastic nature is a significant challenge of this source of energy which brings intermittency due to different weather conditions during a year. This kind of behaviour should be managed to prevent some unpredictable conditions that may have impact on the stability of the system. In order to have a reliable electricity grid which connected with a wind power plant, some measures may be required to smooth the output fluctuation [40, 41].

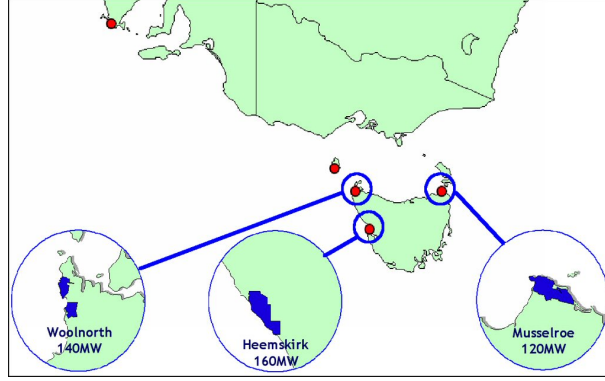

Figure 3.1: Location of Woolnorth on the Australia map.

Recent advances in technology provide a solution to mitigate the challenges in Integrate energy storage system (ESS) with the wind farms is one of the possible options to smooth out the unpredictable intermittent wind power output. Therefore, implementing battery energy storage system (BESS) in wind power plant reduces its fluctuation and hence makes this renewable energy resource more dispatchable. Our objective is to develop a control system based on model predictive control (MPC) combined with BESS, capable of ensuring the optimal operation of battery storage system with intermittent wind power under certain limitations and constraints.

The efficiency of this control strategy has been evaluated via simulation of an actual wind farm data of 5 minute resolution from Woolnorth wind farm site in Tasmania, Australia Fig. 3.1. The wind farm is situated at a coastal site on a cliff which gives the site a very high wind resource with extreme variations [42].

## 3.2 Problem Statement

In order to use wind power energy in the electricity market despite of its fluctuation, that makes it impossible to connect the power directly to the grid, smoothing the wind power output is one of the best possible solutions that can be applied to resolve this problem. Therefore, a storage system which combined with a control system is required. As explained in section 4.1, the basic objective of this chapter is smoothing the wind power generation along with the controlled energy storage in batteries. We consider a nonlinear model of the battery. In Fig.3.2, a schematic diagram of the complete system in a grid is illustrated. As it is shown in this figure, the difference between fluctuated wind power ( $P_w$ ) and smoothed dispatched power ( $P_g$ ) will be compensated by battery energy storage ( $P_c$ ).

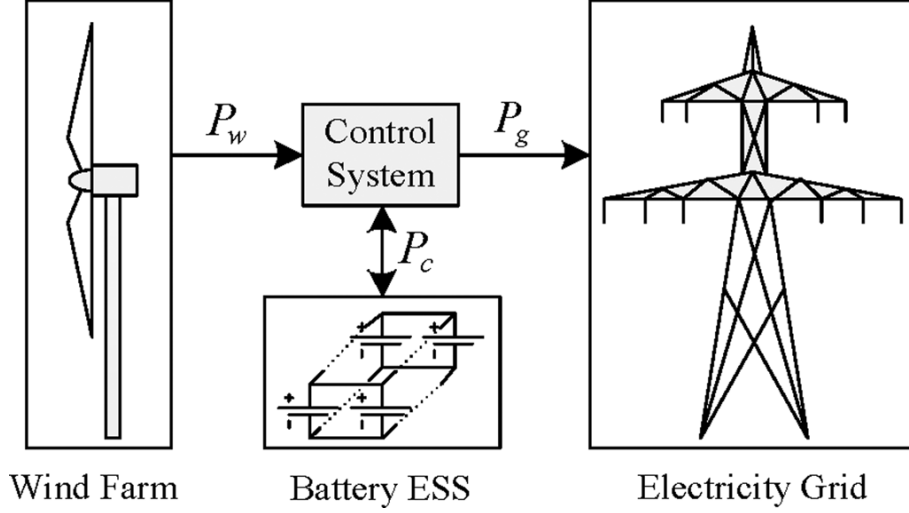

Figure 3.2: Diagram of the grid-connected wind farm integrated with BESS

### 3.3 Control System Design Description

In this study, we propose the following control system model for wind power energy storage system,

$$\begin{cases} x_1(k+1) = r(k) - u(k) \\ x_2(k+1) = f(x_2(k)) + t_d \cdot g(x_1(k), x_2(k)), \end{cases} \quad (3.1)$$

With the following cost function

$$J := \sum_{k=N_0}^{N_0+N} ((r(k) - u(k))^2) \rightarrow \min \quad (3.2)$$

Subject to following constraints,

$$0 \leq u(k) \leq c_3 \quad (3.3)$$

$$-c_4 \leq u(k) - u(k-1) \leq c_4 \quad (3.4)$$

$$0 < c_2 \leq x_2(k) \leq c_1 \quad (3.5)$$

$$-c_5 \leq x_1(k) \leq c_5 \quad (3.6)$$

Physical concepts of constraints of proposed system has been explained in brief in [9], [43], [20] and related references in these studies. In 5.1,  $r(k)$  denotes as the production output of the farm, and let  $u(k)$  represents as the amount of energy sent to the grid,  $x_1(k)$  is the error between the real and smoothed power,  $x_2(k)$  is the battery state of charge. For positive values of  $x_1(k)$  ( $x_1(k) > 0$ ), the battery energy

storage will be charged and it will be discharged for negative ones ( $x_1(k) < 0$ ). Furthermore, the cost function (5.6) penalize the deviations of wind smoothed power from the actual wind power. There are some constraints which imposed by this system that indicated by  $(c_1), (c_2), (c_3), (c_4), (c_5)$ . In order to keep the smoothed output of the system between 0 and rated value of the wind power ( $c_1$ ), constraint (5.8) is introduced. Constraint (5.10) is defined to control the degree of smoothing. It describes the difference between two consecutive amounts of smoothed wind power. The constraint (5.7) is chosen to avoid overloading or under loading of the battery and  $c_5$  in (3.6) is the maximum charging/discharging rated capacity of the battery. In (5.1),  $t_d$  is conversion coefficient (MW to MWh for each 5 min), i.e.,  $t_d = 5min/60min = 1/12$ . This value is chosen based on Australian energy market operator (AEMO) [44] which defines 5min for power dispatch process. Therefore, each  $k$  step is 5 min ( $t = kh, k = 0, 1, 2, \dots$ , and  $h = 5$  is the sampling time in minutes).

### 3.3.1 Proposed Prediction Model

Wind farm prediction system is attached with the energy storage system to improve the overall performance of the control system. In this regard, we get short-term wind power prediction method in [45]. This model consists of two stages, the prediction of wind speed and direction which is achieved in the first stage and in the second stage, the predicted wind speed is converted to predicted output power.

#### Wind speed and direction prediction

Since there is a direct relationship between two parameters if wind speed and its direction [46], there should be an accurate prediction system to represent and efficient operation of wind turbine system. Therefore, the model in [45] which we implement in this study aims to predict wind speed and direction simultaneously. To reach to this aim, the data which gather from a wind farm plant is firstly translated to wind vectors as it is depicted in Fig.3.3.

The Woolnorth wind farm photo is shown in Fig. 3.4. The data has a 5 min resolution and it is for 17th June 2010. The data is properly filtered by removing noise and any outliers.

### 3.3.2 Controller Design

MPC is based on the solution of an on-line optimal control problem where a receding horizon approach is utilized in such a way that for any current state  $x(k)$  at time  $k$ , an open loop optimal control problem is solved over some future interval taking into account the current and future constraints. The algorithm of MPC computes an open loop sequence of the manipulated variables in a manner that the upcoming behaviour of the plant is optimized. Then we insert the first value of the optimization into the plant. This procedure is repeated at time  $(k + 1)$  using the current state

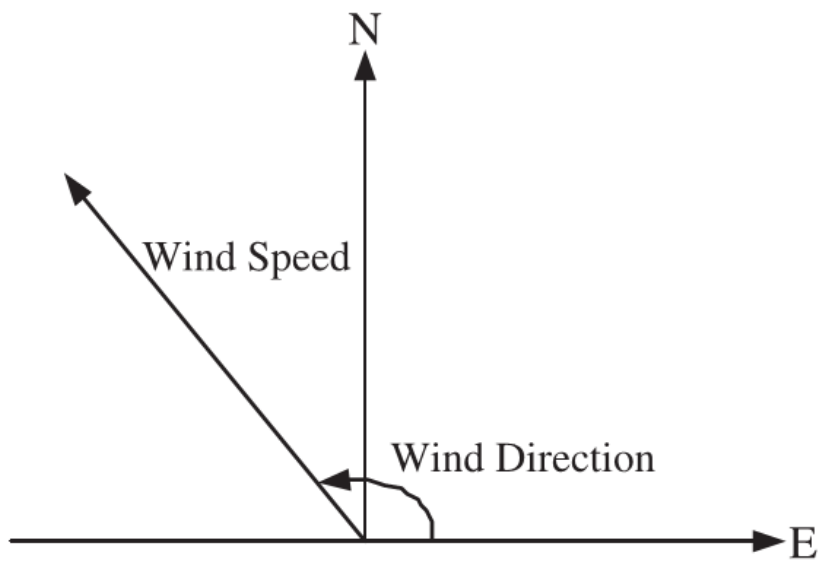

Figure 3.3: Wind vector representation.



Figure 3.4: The Woolnorth wind farm at a cliff.



$x(k+1)$  [47]. Some of the major advantages of the MPC are its capability to handle the constraints, its practical usage, and online optimization. Optimization method in this study for minimizing (5.6) is dynamic programming algorithm subject to the system model (5.1) and constraints (5.7),(5.8),(5.10) with a given initial condition for  $(x_1)$  and  $(x_2)$ .

In order to apply dynamic programming procedure firstly we introduced a function

$$V(x_1, x_2, m) := \min_{u(\cdot)} \sum_{k=N_0}^{N_0+N} ((\hat{r} - u(k))^2) \quad (3.7)$$

In (3.7),  $\hat{r}$  is the predicted wind power.

We calculate this equation by complete search method, since  $-c_5 \leq x_1 \leq c_5$ ,  $c_2 \leq x_2 \leq c_1$ , we can take all  $x_1, x_2$  with some small step  $\varepsilon > 0$  for all  $0 \leq m \leq N$ . The optimization problem at each step is solved using MATLAB.

## 3.4 Simulation

### 3.4.1 Database

In order to simulate the proposed control system in MATLAB software, actual wind farm data is being used. The data that selected as a case study in this simulations gathered from Woolnorth wind farm power generation, which is located in Tasmania, Australia with the maximum capacity of 140 MW. These data are available in 5-minute resolution and is obtained from AEMO database [44].

### 3.4.2 Battery Type Selection

The battery which is used in this simulation is NaS battery (sodium-sulfur), because of its compatibility when it integrated to the wind power farm in comparison with other type of battery technologies. High efficiency (89%), high energy capacity and long life span at 100% depth of discharge (DOD) up to 2500 cycles are some of its remarkable features [12, 20]. Therefore, the data of NaS battery is gathered from NGK insulators company [38].The energy capacity of this studied battery is 480 MWh.

Table 3.1: Simulated Constraints Parameters

$c_1$	Upper bound of battery capacity	72 MW
$c_2$	Lower bound of battery capacity	8 MW
$c_3$	Maximum rated value of wind power	140 MW
$c_4$	Maximum ramp rate of wind power	1.4 MW
$c_5$	Maximum charging/discharging rated capacity	80 MW

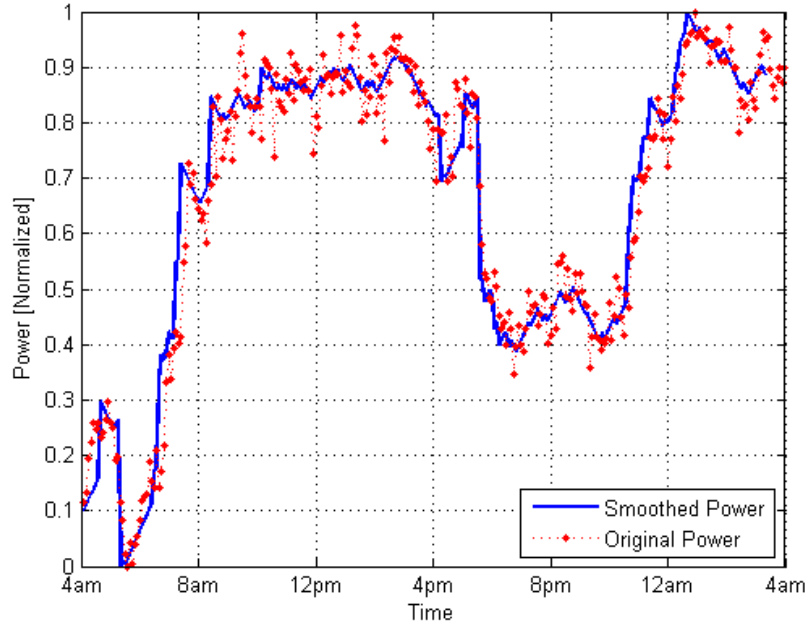

Figure 3.5: Actual and smoothed power

### 3.4.3 Results and discussion

The simulation is carried out for one day (17th July 2010). For simplicity, prediction horizon considered to be the same as control horizon to be 3 in the MPC algorithm ( $N = 3$ ). Therefore, the prediction horizon assumed for this simulation is 15 minutes ahead. Constrains are all chosen based on physical limitation as they are shown in table 5.3. The upper and lower bounds of battery capacity are selected as 90% and 10% of 80 MW total capacity of battery (i.e., 72 MW and 8 MW). The maximum rated value of wind power is chosen as maximum generating capacity of Woolnorth wind farm (140 MW). Maximum Ramp rate is 1% of rated value in this simulation. Due to the battery type, the last constraint parameter is set as 80 MW. Simulation results are shown in Fig. 3.5 - Fig. 3.8. Simulations performed using a predicted wind farm data and a nonlinear BESS model indicate that the performance of this control scheme is quite good; it smoothed the wind power data while keeping energy capacity of battery between its limitation. Due to the limited battery capacity, the output is not perfectly smoothed (Fig. 3.5). For instant, at time 7 am, the battery is full charged (Fig. 3.6), therefore, the controller cannot keep the ramp rate within the desired interval of  $[-c_4, c_4]$  (Fig. 3.7.b). The same phenomena is observed at time 6 pm when battery is discharged. This means that meeting the battery constraints prevents achieving the smoothed output. However, the output ramp rate is mostly limited within the required boundaries (Fig. 3.7) compared to wind power ramp rate (Fig. 3.8). We define a metric to measure the smoothness, that is the fraction of time in which the ramp rate resides in the required boundaries (i.e.,  $[-0.01, 0.01]$ ). The controller achieves a smoother output when the battery capacity constraint is

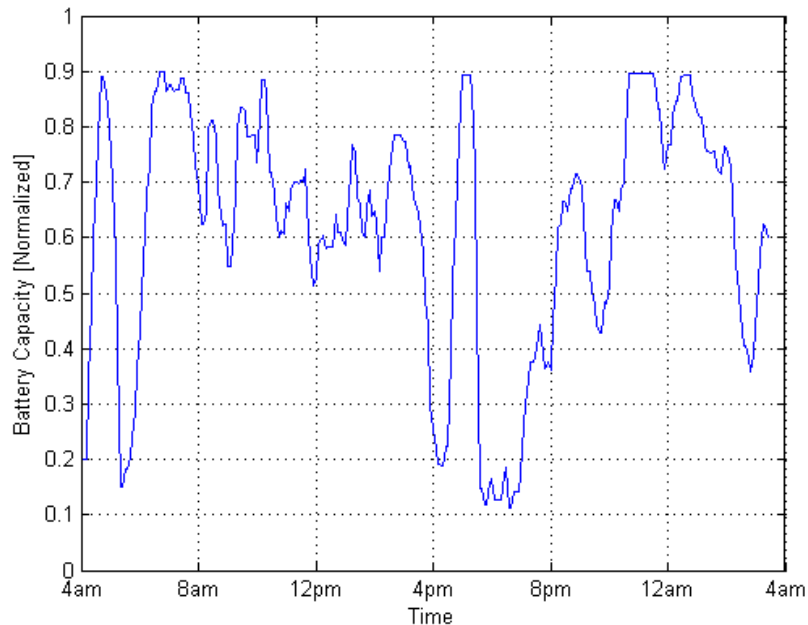

Figure 3.6: Battery energy capacity

Table 3.2: Measurement of Smoothness

Battery Capacity Constrain	[10% 90%]	[20% 80%]	[30% 70%]
Measurement of Smoothness	90%	84%	79%

less tight, for instant if the battery limit is set between 30% and 40% instead of the current setup (i.e., 10% and 90%), we expect result with more fluctuation in ramp rate (less smoothness). In table 3.2 the measurement is shown for different scenarios. The results in this chapter are presented in [48]

### 3.5 Conclusion

This study proposed a nonlinear battery model in order to integrate it with a wind power farm to smooth its output while the battery operates within a safe margin. We simulated our control system using MPC based on dynamic programming. The controller performs well under tight realistic constraints taken from commercial plant ensuring the stability of the system. Wind power predictor with multiple observation point can be improved and made more robust to unmodelled uncertainties using the networked control systems approach of the papers [49–52]. The proposed control scheme is not limited to the wind power. It can also be leveraged for other intermittent energy sources such as large scale photovoltaic solar farms. We plan to involve other important parameters such as energy price to maximize efficiency of the system while we benefit from all kind of available energy resources.

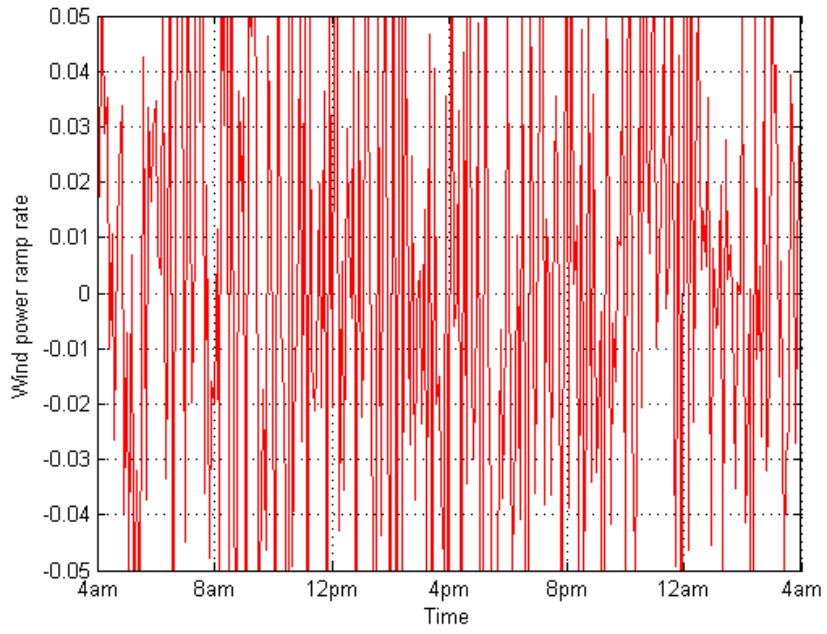

Figure 3.7: Ramp Rate for Wind power

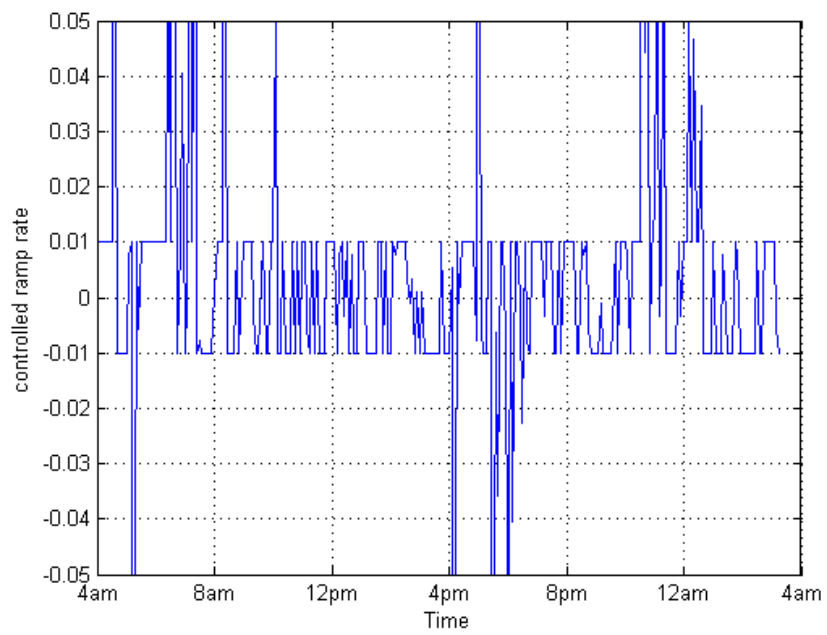

Figure 3.8: Ramp Rate for Controlled Wind Power

## Chapter 4

# Maximizing Profit of a Wind Battery Energy System Using Model Predictive Control Driven by a Dynamic Reference Policy

In this chapter we present a new control approach to manage the income by Wind Power Plant (WPP) while it is intergraded with a Battery Energy Storage System (BESS). With the aid of this control strategy the WPP operator will be enabled to make a balance between energy supply and demand in a profitable way using BESS. Furthermore, we demonstrate that there is a nonlinear relationship between battery capacity and overall revenue and profit of WPP. Therefore, a suitable battery capacity for a WPP should be chosen to achieve maximum revenue. In this study, the Controller is based on Model Predictive Control (MPC) theory using a dynamic programming algorithm along with a nonlinear battery energy storage model. We propose a selling policy model with two parameters by which the selling or saving of wind power can be tuned accordingly to maximize the overall income of the WPP by applying the electricity market pattern of Australia. Since the total profit depends on not only the selling policy but also other factors such as total battery capacity and control techniques. Therefore, we also experiment the effect of battery capacity to maximize the profit of the output power dispatched to the grid while using forecasted dispatch price and wind power. The efficiency of this control strategy is assessed under different scenarios via simulations with actual data of wind farm and price data of NSW Australia. Remainder of the chapter is organized as follows. After a brief introduction in section 5.1, the problem description and control system design is provided in section 5.2. Following that, in section 5.3, the simulation results are given. Finally, the chapter is concluded in Section 5.4.

## 4.1 Introduction

In recent times, energy policies of worldwide are moving toward exploiting Renewable Energy Sources (RES) such as the wind and solar energies. Since greenhouse gas emission is caused by consumption of fossil energies, it persuades governments to motivate electricity plant operators to switch to the renewable sources. Moreover, increasing electricity demand and the crisis in fuel price in the world led us to utilize green resources.

However, due to the nature of these resources, there are some challenges of applying the wind or solar energies when they are planned to connect directly to the network grid. In general, there are two main issues namely technical and financial. Some studies focused on technical difficulties of wind power plants and they figure out effective solutions to mitigate the risk of applying this type of RES [9,53,54]. On the other hand, some researchers emphasize on commercializing wind power output when it is in the competitive electricity market [9,53,54]. In all these studies, battery energy storage system (BESS) is seen a reasonable solution that can be applied in wind farm plant to control the power by charging and discharging energy based on the control signal command.

The works on smoothing the fluctuation of wind power output for its safe and reliable connection to the electricity grid vary from simple schemes of charging and discharging the BESS as the wind power output goes beyond a minimum or maximum threshold [55,56] to much more sophisticated control algorithms [9,53,54]. Specifically, The authors of [53] applied an optimal control method on the linear model of the leadacid battery to smooth the generated wind power and make it dispatchable on an hourly basis. They used one-hour ahead average forecasted wind power as the reference power to be dispatched. Also in [45] a prediction model for short-term wind power forecasting was presented. In [9], an open-loop MPC scheme was proposed to find the optimal wind power output integrated with a BESS. In these studies, the prediction of wind power is based on a new model and the goal is the reduction in the intermittency of wind power.

Some studies have been carried out to make wind power more commercial than before by control the wind power while it is connected to the grid in presence of BESS. Thus, BESSs enables wind energy to be stored during off peak demand times when the price of electricity is relatively low. Such stored energy can be sold simultaneously with the power generated by the wind farm at peak demand times when the price of electricity is higher. such dispatch schedules are highly dependent on firstly, the electricity market rules of the region where the power is sold, and secondly, the constraints of the BESS.

For instance, the authors of [57] presented an economic and technical analysis for hourly energy management of a wind farm with three different BESSs through detecting peak and off-peak electricity consumption periods. In another work, the profitability of a wind power plant plus a BESS was examined from the supply chain perspective considering price volatility in the electricity market [58]. In [59], an iterative optimization technique for scheduling the wind power based on hourly electricity tariff prediction with a dual BESS structure was applied.

However, little attention has been paid to improve the controllability of wind farm dispatching with BESS in the area of control systems considering electricity price and optimal use of BESS with the aim of providing the potential of trading within a competitive electricity market while considering battery capacity effectiveness. In [20], an intelligent control system is implemented to manage the wind power injected to the grid using a BESS in time shifting application. In such previous models which have been studied [9, 20], batteries were used as simple storages that linearly store the energy and did not take into account the losses inside the battery as their chemical reactions. We consider a model based on its inputs and outputs and consider a model which shows some nonlinear behaviors of the battery during charging, discharging and storing period.

In this paper, the main objective is to develop a control system based on model predictive control (MPC) combined with BESS, capable of generating a dynamic reference signal based on predicted price and wind data with any of intermittent energy sources under certain limitations and constraints to increase the revenue of wind power farm. A new control strategy for selling wind power energy to the grid while using non linear model of the battery is introduced in this study. The proposed control system consists of two main components: (a) an active reference generator block and (b) an MPC based controller block. The application of this controller with an real-time reference generator in the design of the proposed control system is a novel insight to the problem of controlling wind farm power which is integrated with BESS.

The advantages of the proposed control system are as follows: real-time optimization of the overall system behavior and physical constraints handling using the MPC, adaptively updating the reference signal based on system states and predicted price and wind power data, and improving the controllability of the wind farm power generation with the BESS into the electricity market while keeping the ramp rate of power signal inside the predefined barriers. Moreover, it is depicted that battery capacity has highly affected on profit of the WPP. Therefore, choosing a suitable amount of battery for a specific WPP can improve the efficiency accordingly.

We test our controller with different scenarios based on the parameters used in the proposed system. Finally we determine a battery capacity and values of parameters to achieve the maximum profit for a given WPP. In order to illustrate the strength of the proposed methodology, we compare the results with other possible situations such as no-control or control with simple on-off policy which are explained in this paper. The control system is simulated with real wind farm data from Woolnorth wind farm site in Tasmania, Australia and the dispatch electricity price data of the New South Wales electricity market for the corresponding dates of the wind power generation. The wind farm is situated at a coastal site on a cliff which gives the site a very high wind resource with extreme variations [42].



## 4.2 Problem Description

The key objective of this chapter is enhancement the benefits of wind power in the electricity market. To archive this goal, a dynamic algorithm is designed to provide a reference power signal which is capable of changing dynamically with the status of the electricity price although satisfy the determined constraints simultaneously. Therefore, a control system which combined with a BESS is required to control the signal that charges and discharges the battery to produce the desired power as close as possible to the reference power signal.

### 4.2.1 Dynamic model of the system

In this study, we propose the following control system model for wind power energy storage system,

$$\begin{cases} x_1(k+1) = r(k) - u(k) \\ x_2(k+1) = f(x_2(k)) + t_d g(x_2(k), u(k)), \end{cases} \quad (4.1)$$

$$y(k) = x_1(k) \quad (4.2)$$

In (5.1),  $r(k)$  denotes as the production output of the farm, and let  $u(k)$  represents as the power control command, i.e., for positive values of  $u(k)$  ( $u(k) > 0$ ), the battery energy storage will be charged and it will be discharged for negative ones ( $u(k) < 0$ ) and  $x_2(k)$  is the current battery energy capacity. In (5.1),  $t_d$  is conversion coefficient (MW to MWh for each 5 min), i.e.,  $t_d = 5min/60min = 1/12$ . This value is chosen based on Australian energy market operator (AEMO) [44] which defines 5min for power dispatch process. Therefore, each  $k$  step is 5 min ( $t = kh, k = 0, 1, 2, \dots$ , and  $h = 5$  is the sampling time in minutes).

### 4.2.2 Reference Generator

For any closed-loop control system, the reference signal or desired output should be defined according to the desired requirements and the control objectives of the system [20]. Thus, we propose a decision-making system to generate the reference signal. Our reference generator is dynamic and it is as a fraction of battery state, predicted wind power and predicted price. The decision-making system is mathematically expressed by,

$$y_{ref}(k) = \begin{cases} r(k) + (2w(P) - 1)x_2(k) & w \geq 0.5 \\ r(k) + (2w(P) - 1)(x_{2max} - x_2(k)) & w < 0.5 \end{cases} \quad (4.3)$$

where  $y_{ref}(k)$  is reference power signal,  $r(k)$  is predicted wind power and  $x_2(k)$  is battery available energy.  $w$  is the decision weight based on price and is expressed by,

$$w(P) = \frac{1}{1 + e^{-\lambda(P-P_0)}} \quad (4.4)$$

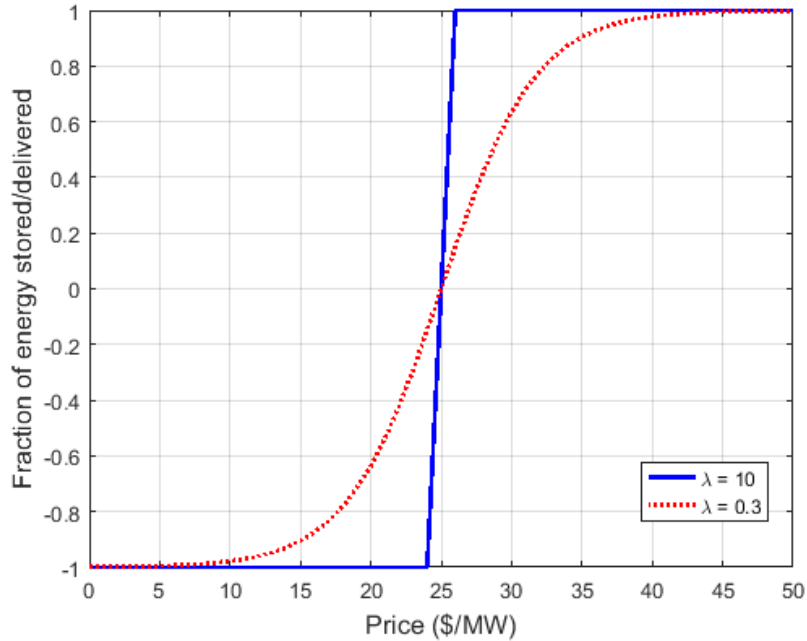

Figure 4.1: Fraction of available energy (Battery + Wind power) to be delivered to the grid ( $2.w - 1$ ) ( $P_0 = 25$ ).

It is the most convenient nonlinear exponential function of parameter  $\lambda$ . The proposed decision system is based on two main concepts, (a) whenever the price is high, we deliver energy as much as possible to the grid (It means less storage and more delivery) and (b) whenever the price is low, we store energy in the battery as much as possible (It means more storage and less delivery to the grid). To implement our decision-making system, we consider a fraction of available energy (Battery + Wind power) to be delivered to the grid and it is expressed by  $(2.w(P) - 1)$ . We call it "Weight Function". As it is shown in Fig. 4.1, it is an increasing function of price.

In (4.4), parameters  $\lambda$  and  $P_0$  are chosen by plant operator, which  $\lambda$  represents the rate of storage/delivery based on our policy.  $P_0$  is called "Hot Price" at which we neither store energy to nor extract from the battery. In other words, we want to deliver all energy generated by wind plant farm to the grid ( $y_{ref}(k)|_{P=P_0}$ ). If  $P = 0$  then we store the wind into the battery till it gets fully charged and we deliver the rest of energy to the grid.  $P$  is the predicted price that is determined by price predictor block which is explained in section 5.2.4. In Fig. 4.1, the behaviour of this function for different  $\lambda$  is illustrated. We plot the weight fraction  $(2w(P) - 1)$  with  $P_0 = 17(\$/MW)$  and two values of  $\lambda$ . Red curve (corresponding to  $\lambda = 10$ ) sharply rises at  $P_0$  resulting an "On-Off Policy" whereas the blue corresponding to  $\lambda = 0.3$  curve slightly increases in price represents a dynamic policy.

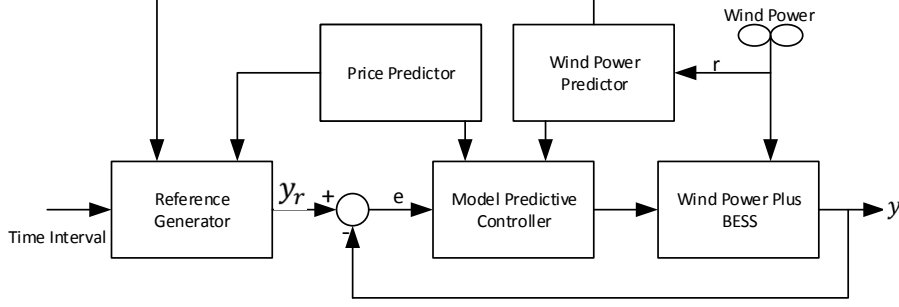

Figure 4.2: Block diagram of the proposed control system.

### 4.2.3 Wind Power Prediction Model

A wind farm prediction system is combined with the energy storage system to improve the overall performance of the control system. In this regard, we get short-term wind power prediction method in [45]. This model consists of two stages, the prediction of wind speed and direction which is achieved in the first stage and in the second stage, the predicted wind speed is converted to predicted output power. The data has a 5 min resolution and it is for 17th June 2010. The data is properly filtered by removing noise and any outliers.

### 4.2.4 Price Prediction

In our proposed control strategy, in order to generate the reference signal, we need a forecasted price for a short term ahead to enhance the benefit of the wind power plant in deregulated market. There are several methods for forecasting the price for a short term period of time [60]. In this study we choose a simple autoregressive (AR) model which is used in [61]. In this stochastic model we use previous price data to forecast the price for future. We use following AR model,

$$p_n(k+1) = \tau_p(k)p_n(k) + \epsilon(k) \quad (4.5)$$

- where,  $p(k)$  Average short price in week ( $k$ )
- $p_n(k)$  Normalized value of  $p(k)$
- $\tau_p(k)$  Autocorrelation coefficient
- $\epsilon(k)$  Normal random variable

### 4.2.5 Controller Design

MPC is based on the solution of an on-line optimal control problem where a receding horizon approach is utilized in such a way that for any current state  $x(k)$  at time  $k$ , an open loop optimal control problem is solved over some future interval taking into account the current and future constraints. The algorithm of MPC computes an open loop sequence of the manipulated variables in a manner that the upcoming behavior of the plant is optimized. Then we insert the first value of the optimization into the plant. This procedure is repeated at time  $(k+1)$  using the current state

$x(k+1)$  [47]. Some of the major advantages of the MPC are its capability to handle the constraints, its practical usage, and online optimization. The structure of the proposed control system is illustrated in Fig. 4.2. Therefore, the proposed control law for the system in (5.1) will be obtained by minimizing the following cost function,

$$J := \sum_{k=N_0}^{N_0+N} ((y(k) - y_{ref}(k))^2 \rightarrow \min \quad (4.6)$$

where  $N$  is prediction horizon. Optimization method in this study for minimizing (5.6) is dynamic programming algorithm subject to the system model (5.1) and following constraints,

$$x_{2min} \leq x_2(k) \leq x_{2max} \quad (4.7)$$

$$-U_{max} \leq u(k) \leq U_{max} \quad (4.8)$$

$$0 \leq x_1(k) \leq c_1 \quad (4.9)$$

for all  $k \in 0, \dots, N-1$  with a given initial condition for  $(x_1)$  and  $(x_2)$  as  $(x_1(N_0))$  and  $x_2(N_0)$  respectively. Physical concepts of constraints of proposed system has been explained in brief in [9], [43], [20] and related references in these studies.

The cost function (5.6) penalize the deviations of the reference power signal  $(y_{ref}(k))$  from the power output  $(y(k))$ . There are some constraints which imposed by this system that indicated by (5.7), (5.8) and (5.10). The constraint (5.7) is chosen to avoid overloading or under loading of the battery i.e., the BESS should not be discharged less than  $x_{2min}$  or charged over  $x_{2max}$ .  $U_{max}$  in (5.8) is the maximum charging/discharging rated capacity of the battery. In order to keep the output of the system between 0 and rated value of the wind power ( $c_1$ ), constraint (5.10) is introduced. In order to apply dynamic programming procedure firstly we introduced a function

$$J(x_1, x_2, M) := \min_{u(\cdot)} \sum_{k=N_0}^{N_0+M} ((y(k) - y_{ref}(k))^2 \quad (4.10)$$

Where  $M$  is control horizon. We calculate this equation by complete search method, since  $0 \leq x_1(k) \leq c_1$ ,  $x_{2min} \leq x_2(k) \leq x_{2max}$ , we can take all  $x_1, x_2$  with some small step  $\varepsilon > 0$  for all  $0 \leq M \leq N$ . For simplicity, wind power prediction in the MPC algorithm is used with control horizon to be the same as prediction horizon and to be equal to three ( $N = M = 3$ ).

First we assume that

$$\begin{aligned} J(x_1, x_2, M) &:= \min_{u(\cdot)} \sum_{k=N_0}^{N_0+M} \{(y(k) - y_{ref}(k))^2\} \\ &= \min_{u(\cdot)} \{(y(N_0) - y_{ref}(N_0))^2 + \dots + (y(N_0 + M) - y_{ref}(N_0 + M))^2\}. \end{aligned} \quad (4.11)$$

We suppose that,

$$\begin{aligned}
J_{N0} &= y(N0) - y_{ref}(N0))^2, \\
J_{N0+1} &= y(N0 + 1) - y_{ref}(N0 + 1))^2, \\
&\vdots \\
J_M &= y(N0 + M) - y_{ref}(N0 + M))^2
\end{aligned} \tag{4.12}$$

As we want to optimise  $J(x_1, x_2, M)$  then we presume that

$$\begin{aligned}
J_{N0,M}^* &= \min\{J_{0,M-1}^* + J_M\}, \\
J_{N0,M-1}^* &= \min\{J_{0,M-2}^* + J_{M-1}\}, \\
&\vdots \\
J_{N0}^* &= \min\{J_{N0}\}
\end{aligned} \tag{4.13}$$

In order to calculate  $J_{N0}^*$ , we do a complete search for all  $x_1, x_2$  by considering their defined constrains to find  $y(N0)$  from our propose model (5.1) for all  $-U_{max} \leq u \leq U_{max}$  with a small step  $\epsilon$ . After finding an optimal value for  $J_{N0}^*$  then we go to next step to find  $J_{N0+1}^*$  and this procedure continues to find  $J_{N0+M}^*$ .

At the end of the optimization the optimal control signal sequence ,  $u^{opt}(k)$ , will be found for  $k = \{N0, \dots, N0 + M\}$  that minimize the whole cost function (5.12).

$$u^{op} = \{u^{op}(N0), u^{op}(N0 + 1), \dots, u^{op}(N0 + M)\} \tag{4.14}$$

Then we choose the first value of this sequence ( $u^{op}(N0)$ ) as the first value of the optimization and apply it into the plant. This procedure is repeated at time  $(k + 1)$  and in the new step  $N0$  will be  $N0 + 1$  and also current states ,according to the model, will be  $x(k + 1)$  . This procedure is repeated for our whole trajectory. The optimization problem at each step is solved using MATLAB.

## 4.3 Simulations

In order to evaluate our control scheme, we apply our proposed model to actual wind and price data taken from the Woolnorth wind farm and AEMO, respectively and simulate in Matlab. Given wind and price at each sample time along with the prediction of these signals for next 3 sample times ( $N = M = 3$ ), we generate our reference signal. Then, we apply reference signal to our closed loop system (Fig. 4.2). We use dynamic programming in our controller to minimize the objective function (5.6).

### 4.3.1 Dataset

The wind power represent 1 day data and the maximum capacity of wind power generation is 140 MW. Also, the dispatch electricity price data of the New South

$x_{2max}$	Upper bound of battery capacity	432 MWh
$x_{2min}$	Lower bound of battery capacity	48 MWh
$c_1$	Maximum rated value of wind power	140 MW
$U_{max}$	Maximum charging/discharging rated capacity	80 MW
$c_2$	Maximum ramp rate of wind power	1.4 MW

Wales electricity market for the corresponding date of the wind power generation is selected. Price data is obtained from AEMO database [44]. Both wind power and price data are available in 5-minute resolution.

### 4.3.2 Battery Type Selection

The battery which is used in this simulation is NaS battery (sodium-sulfur), because of its compatibility when it is integrated to the wind power farm in comparison with other type of battery technologies. High efficiency (89%), high energy capacity and long life span at 100% depth of discharge (DOD) up to 2500 cycles are some of its remarkable features [12, 20]. Therefore, the data of NaS battery is gathered from NGK insulators company [38]. The energy capacity of this studied battery is 480 MWh. We use battery model parameters as follows,

$$\alpha = 0.98, \beta = 0.95, \gamma = 1.05, M_c = 54MW \text{ and } M_d = -37MW$$

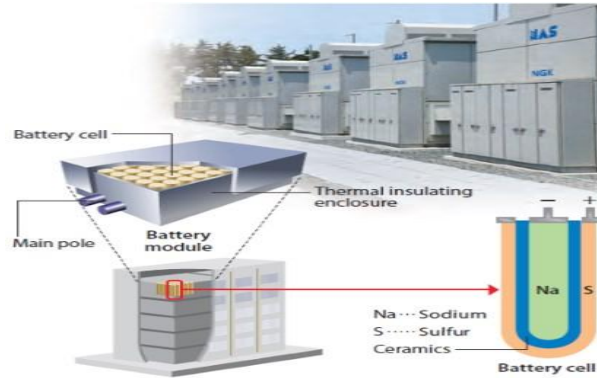

Figure 4.3: Sodium-Sulfur (NaS) Battery Structure

### 4.3.3 Results

For simplicity, prediction horizon is considered to be the same as control horizon in the MPC algorithm (i.e.  $N = M = 3$ ). Therefore, the prediction horizon is assumed for this simulation to be 15 minutes ahead. Constraints are all chosen based on physical limitation as they are shown in table 5.3. The maximum rated value of wind power ( $c_1$ ) is chosen as maximum generating capacity of Woolnorth wind farm (140 MW). Due to the battery type, the constraint parameter ( $U_{max}$ ) is set as 80 MW. Simulation results are shown in Fig. 4.4 - Fig. 4.21. Since our study

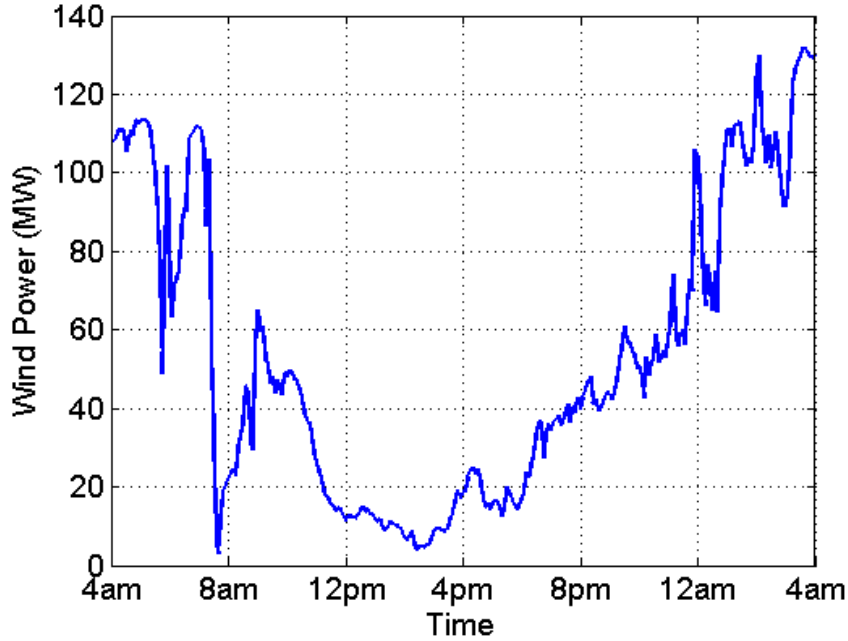

Figure 4.4: Wind power data for one day.

of MPC is more price constrict, therefore our reference generator highly depends on choice of hot price namely (a) low hot price (i.e.  $20\$/MW$ ), (b) moderate hot price ( $25\$/MW$ ) and (c) high hot price ( $30\$/MW$ ). Primary results in this chapter are presented in [62].

### Low hot price

In this case, we expect to dispatch more power to the network since the hot price is chosen low enough to affect the control system releasing the energy more often. As it is shown in Figs. 4.6,4.7,4.8, during 4 am and 7 pm, system stores energy in the battery as much as possible till it reaches to the full capacity and then from 7 am that price goes more than 20\$, controller command the system to release more energy to the grid and use the battery capacity as a back up. The same trend happens during 1 am and 4 am next day.

### Moderate hot price

When the operator choose moderate hot price ( $25\$/MW$ ), controller use the battery to store energy more often than first case scenario (Low hot price) and as it is depicted in Figs.4.9,4.10,4.11, during 4 am and 9 am, most part of the wind power stored in the battery. After fully charge the battery, the rest of the wind power will be sent to the grid. If there was not any concern about battery costs and we could apply unlimited capacity in the proposed system, then all the wind power production had been stored in the battery according to the defined rules between 4

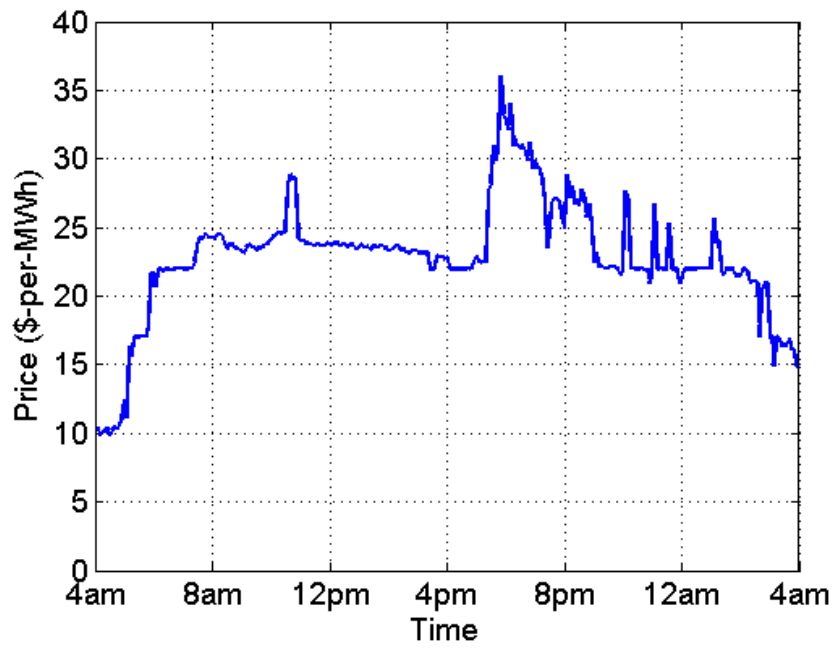

Figure 4.5: Price data for one day

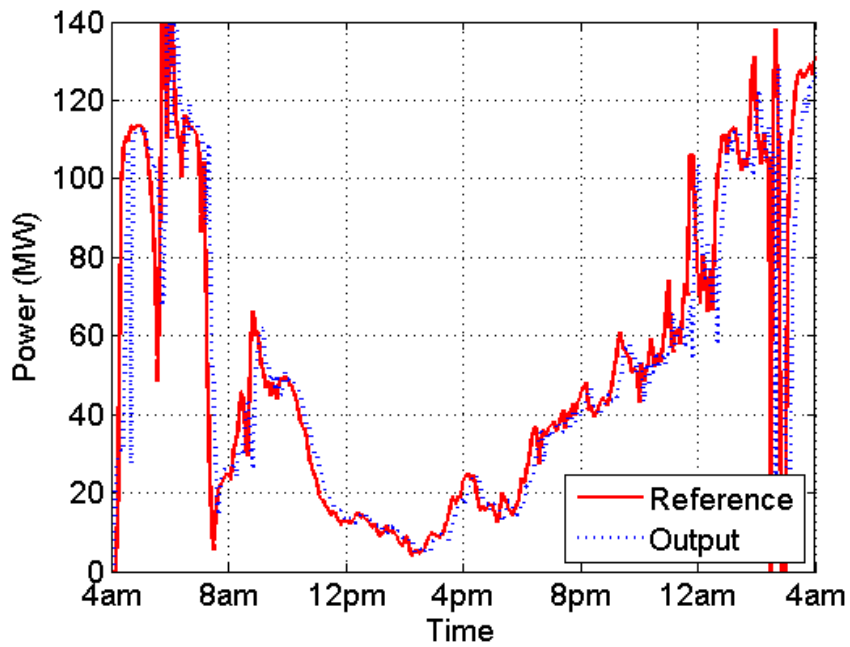

Figure 4.6: Results when Hot price is 20 \$ per MWh: Reference and output power signal.



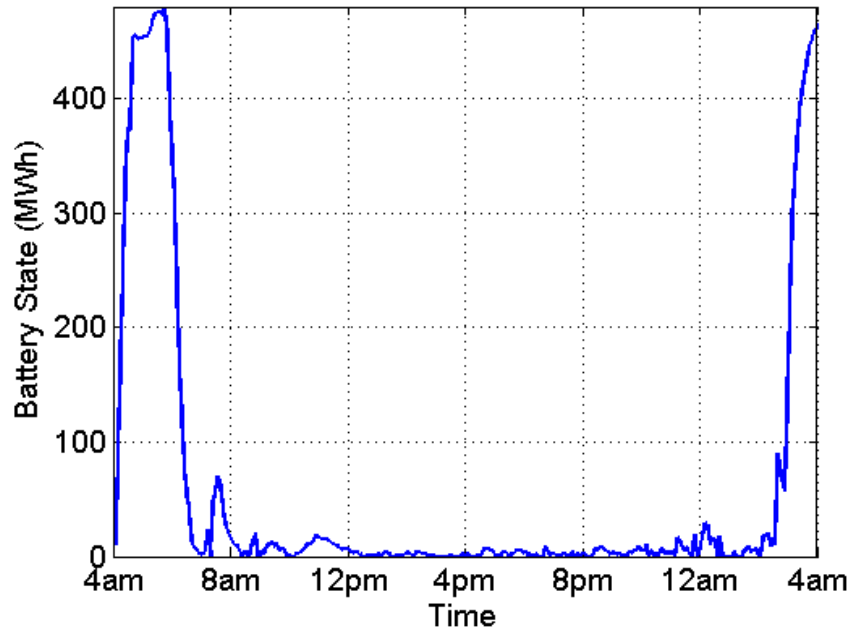

Figure 4.7: Results when Hot price is 20 \$ per MWh: Battery's state.

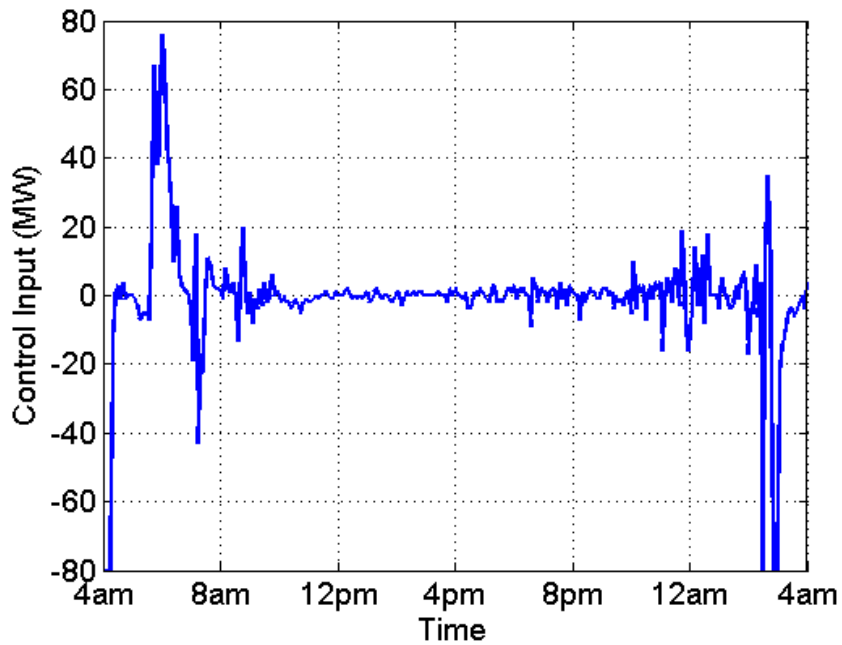

Figure 4.8: Results when Hot price is 20 \$ per MWh: Control input or charging/discharging power of the battery

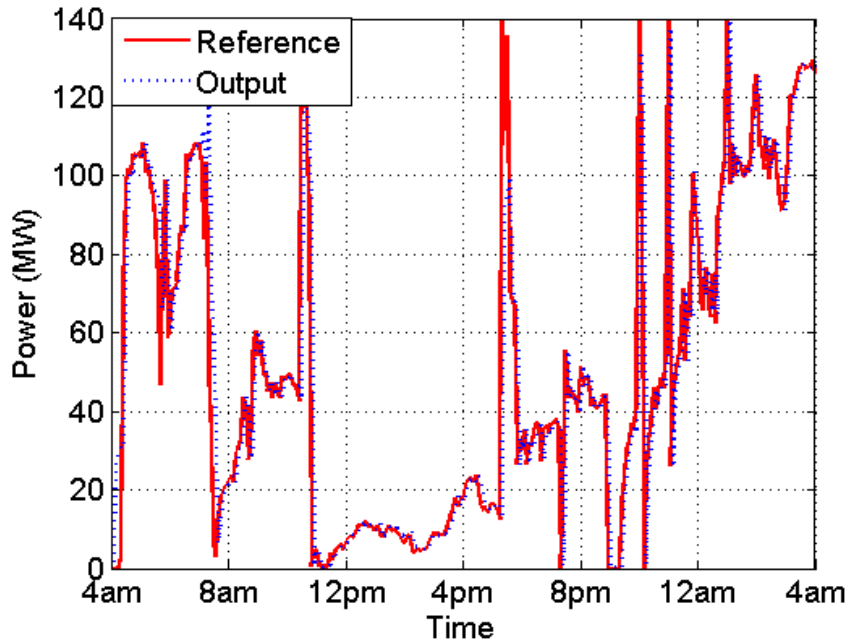

Figure 4.9: Results when Hot price is 25 \$ per MWh: Reference and output power signal.

am and 9 am.

### High hot price

High hot price is defined for specific conditions where there is enough capacity and also the owner of the wind power plant prefer to sell the energy with high price in compare with the other scenarios . In this case study, majority of time the price is lower than high hot price and therefore controller send signal to the system to store the energy as much as the capacity allow to the system. As in this particular study the capacity is same as two above scenarios, it is shown in Figs. 4.12,4.13,4.14 that between 4 am to 7pm, the battery is fully charged and rest of the wind power will be sent to the grid. After a pick during 7pm and 8pm again system come back to its previous status.

### 4.3.4 Impact of dynamic storage policy

#### The Impact of parameter $\lambda$ on revenue

Fig. 4.18 shows plant revenue for two weeks when  $\lambda$  changes from 0.1 to 10 (in the dashed blue curve). The solid red curve represents the total revenue while no battery is presented on the plant which means that the wind power is completely dispatched without any control. As it is depicted, maximum of revenue occurs at  $\lambda = 0.6$  reaching to 715k\$ that results 47% improvement in revenue compared to the baseline (which represents no control scenario). We can see that the revenue falls

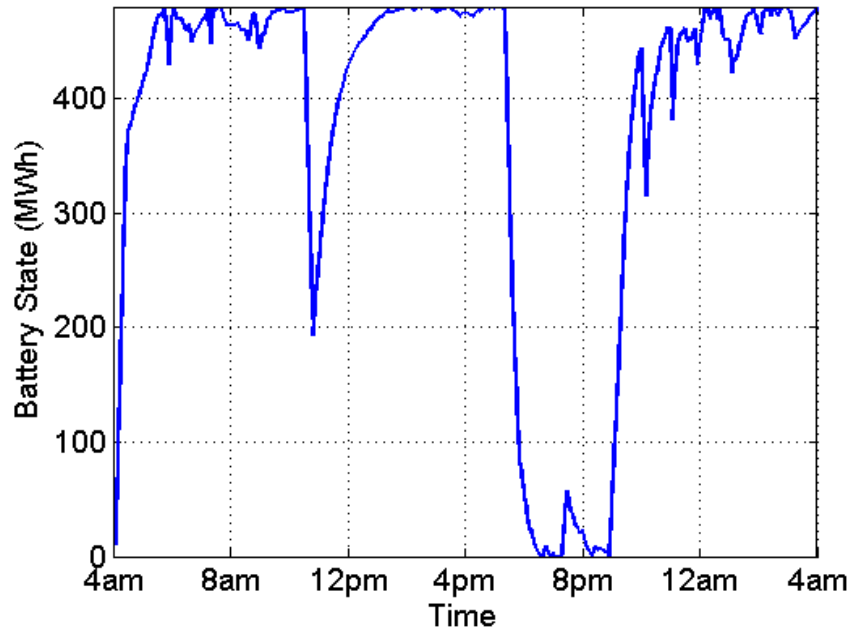

Figure 4.10: Results when Hot price is 25 \$ per MWh: Battery's state.

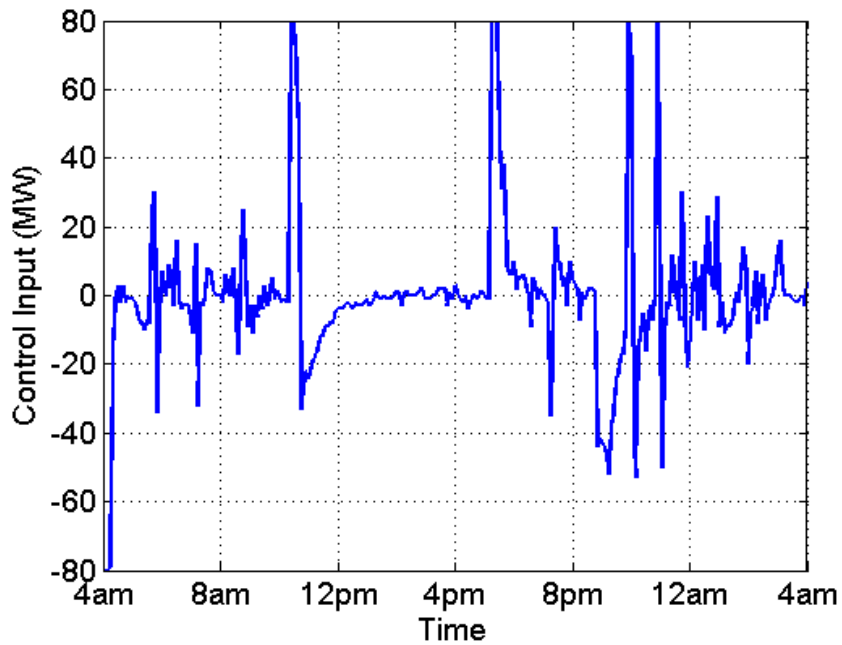

Figure 4.11: Results when Hot price is 25 \$ per MWh: Control input or charging/discharging power of the battery

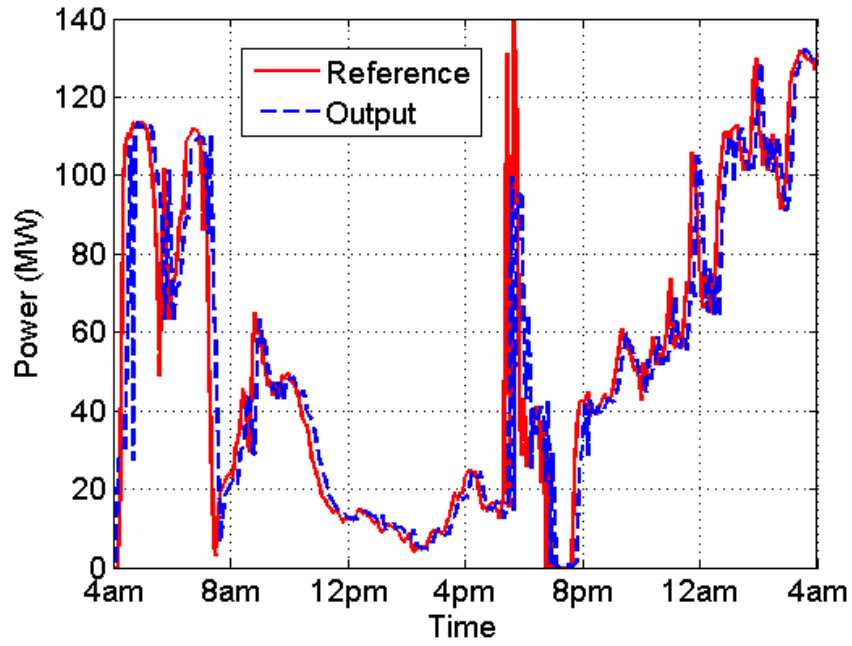

Figure 4.12: Results when Hot price is 30 \$ per MWh: Reference and output power signal.

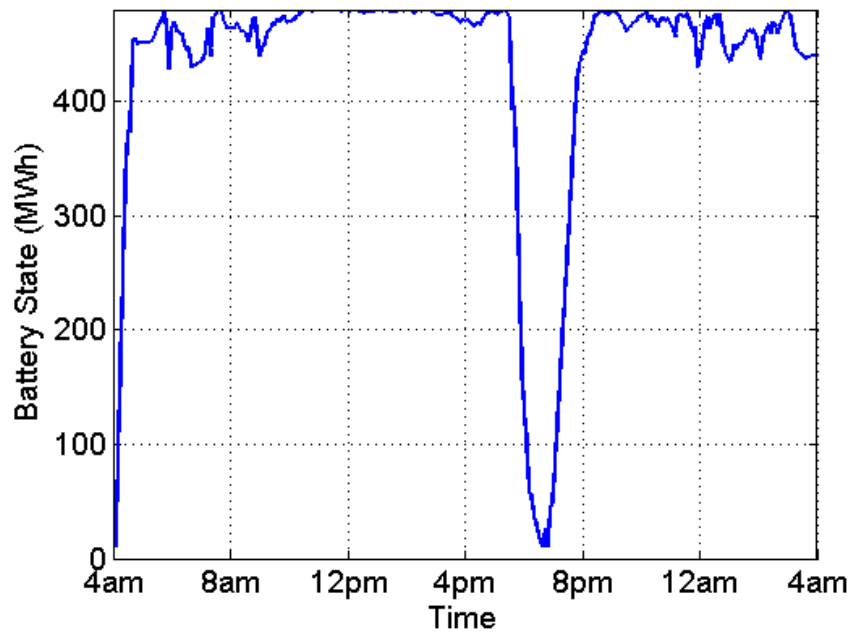

Figure 4.13: Results when Hot price is 30 \$ per MWh: Battery's state.

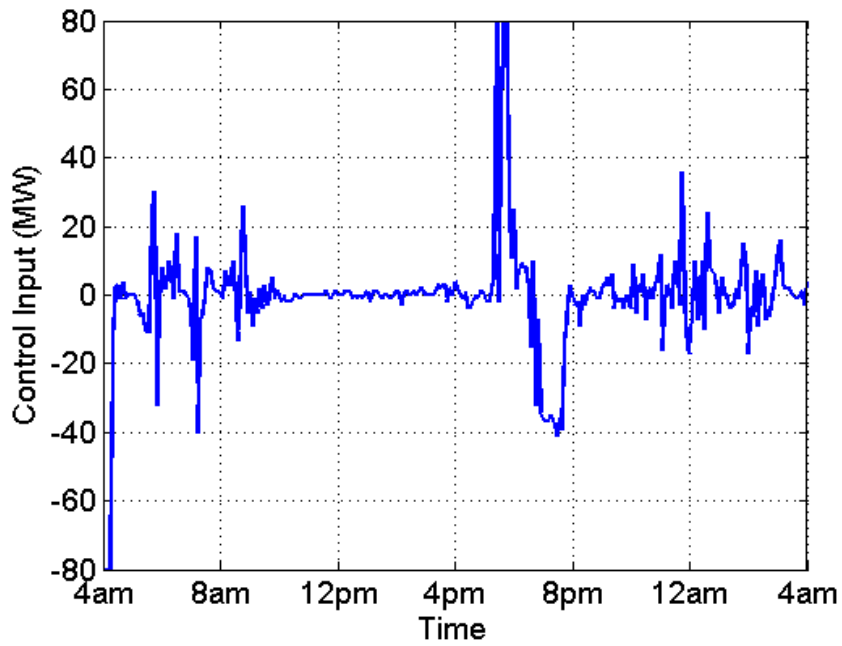

Figure 4.14: Results when Hot price is 30 \$ per MWh: Control input or charging/discharging power of the battery

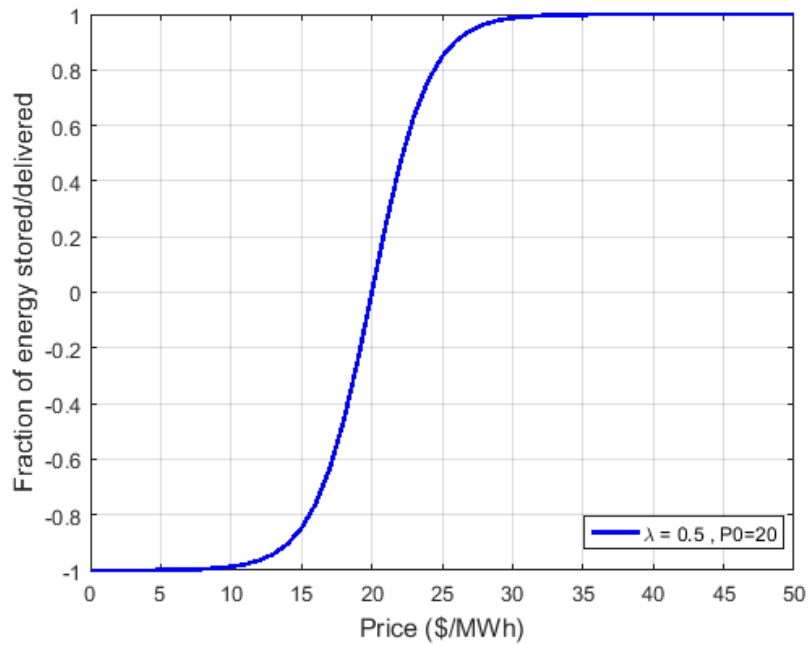

Figure 4.15: Weight fraction for three different Hot Prices: Hot Price =20.

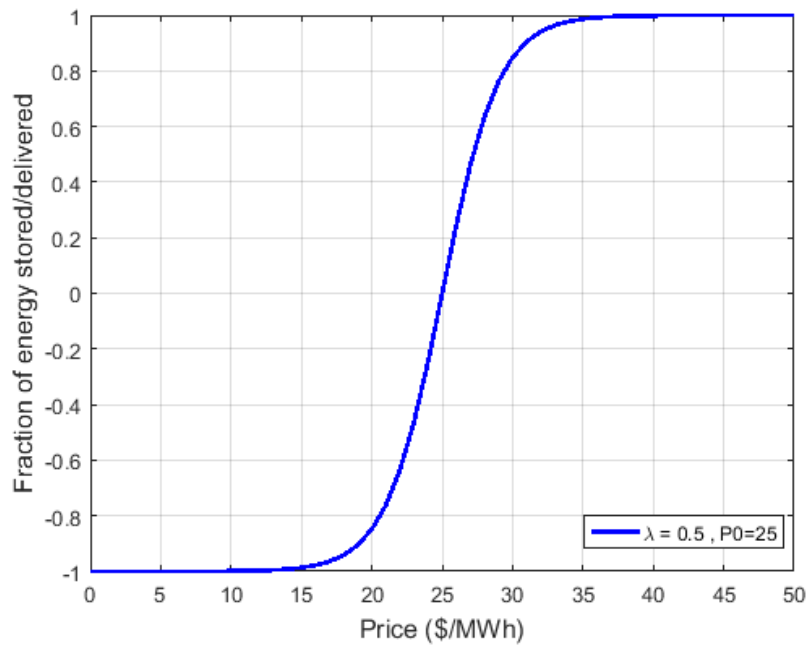

Figure 4.16: Weight fraction for three different Hot Prices: Hot Price =25.

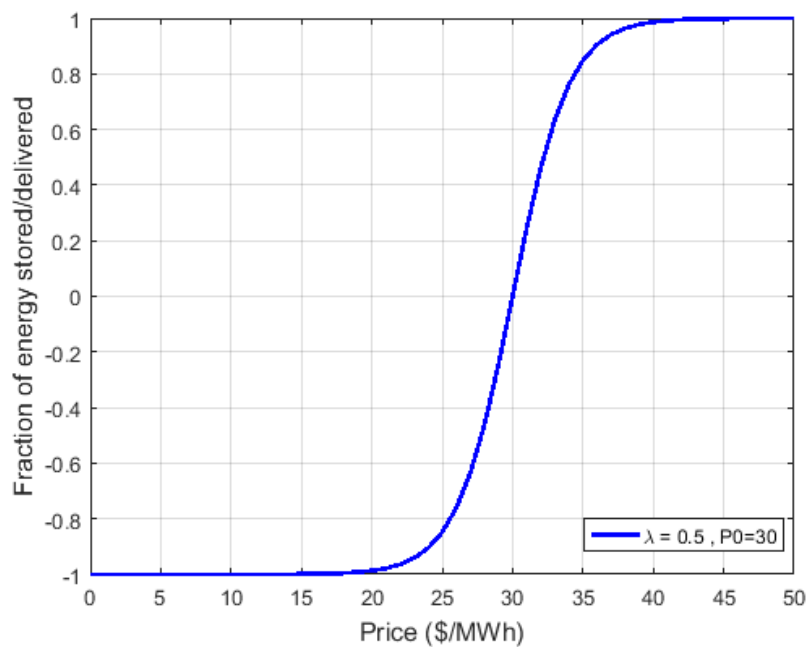

Figure 4.17: Weight fraction for three different Hot Prices: Hot Price =30.

after this point since increasing the  $\lambda$  causes the storage policy to become similar to "on-off" scenario . From  $\lambda = 3$  we can observe that the revenue is stabilized. Note that at large  $\lambda$  (for instance  $\lambda = 10$ ) the revenue is higher than the situation in which no battery is applied on the WPP. In Fig. 4.19 zoomed-in range of  $\lambda$  ( $0.1 \leq \lambda \leq 10$ ) is depicted to specify the main changes of  $\lambda$ .

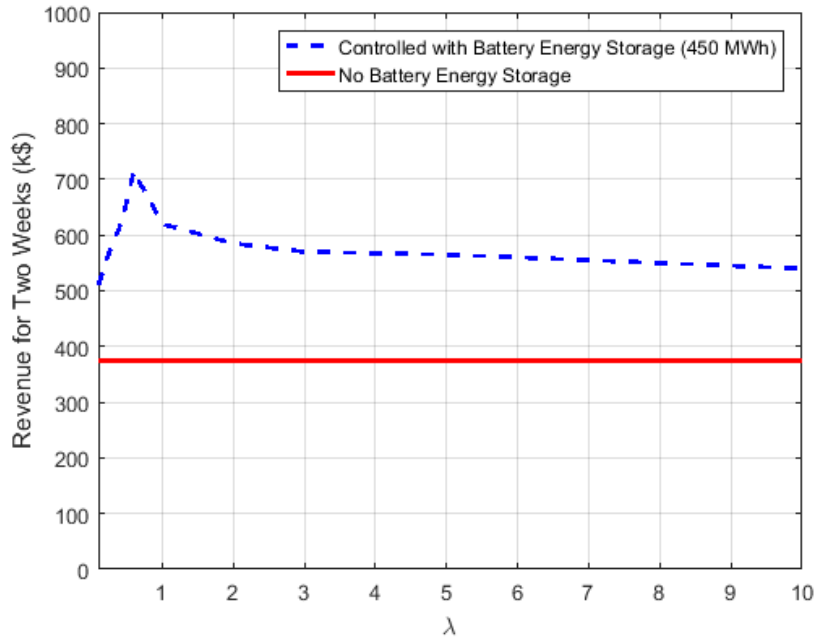

Figure 4.18: The Impact of parameter  $\lambda$  on revenue (Large Range of  $\lambda$  ( $0.1 \leq \lambda \leq 10$ ))

### Impact of Battery Capacity

In order to investigate the impact of battery capacity on the revenue of the system, we simulated a sample data of two weeks for a range of 100 to 750 MWh battery capacities for three different  $\lambda$  ( $\lambda = 0.1, 0.6, 10$ ). It was expected that there should be a linear relationship between battery capacity and revenue of the system. However, simulated results in Fig. 4.20 show that the trend is nonlinear. It was clarified in chapter 3 that battery has some leakages during charging and discharging processes. Therefore, by increasing the capacity, cycle of charging and discharging will grow up and consequently the higher amount of power will be lost. However, since this simulation has been done for a specific WPP, it is experienced that by increasing the battery capacity to  $750MWh$ , not only there is no more rising in the revenue of the WPP, but also some dropping happened in revenue.

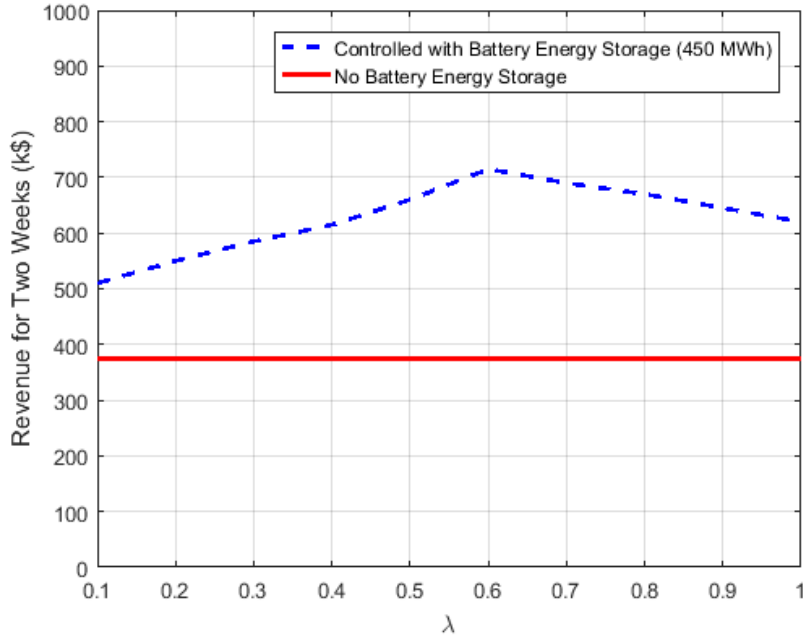

Figure 4.19: The Impact of parameter  $\lambda$  on revenue (Zoomed-in range of  $\lambda$  ( $0.1 \leq \lambda \leq 1$ )).

### Joint Impact of $\lambda$ and capacity

As we have seen, the total revenue is a function of two main variables namely  $\lambda$  and battery capacity. We plot the joint impact of these two drivers on the revenue in a 3-D diagram shown in Fig. 4.21. It can be observed that global maximum of revenue is perceived at  $\lambda = 0.6$  and battery capacity 600 MWh. Note that this graph is quite useful for plant operators to strategize their profitable region of operation. Table 4.2 summarizes the system parameters including two weeks revenue corresponding to different battery energy storage capacities with a fix  $\lambda$ .

Table 4.2: System parameters: variable battery energy storage capacity.

Capacity (MWh)	$\lambda$	Max Ca- capacity	Min Ca- capacity	Initial Capac- ity	Two Weeks Profit (K\$)
100	0.6	90	10	50	61.9
300	0.6	270	30	150	568.2
400	0.6	360	40	200	661.6
600	0.6	540	60	300	932.3



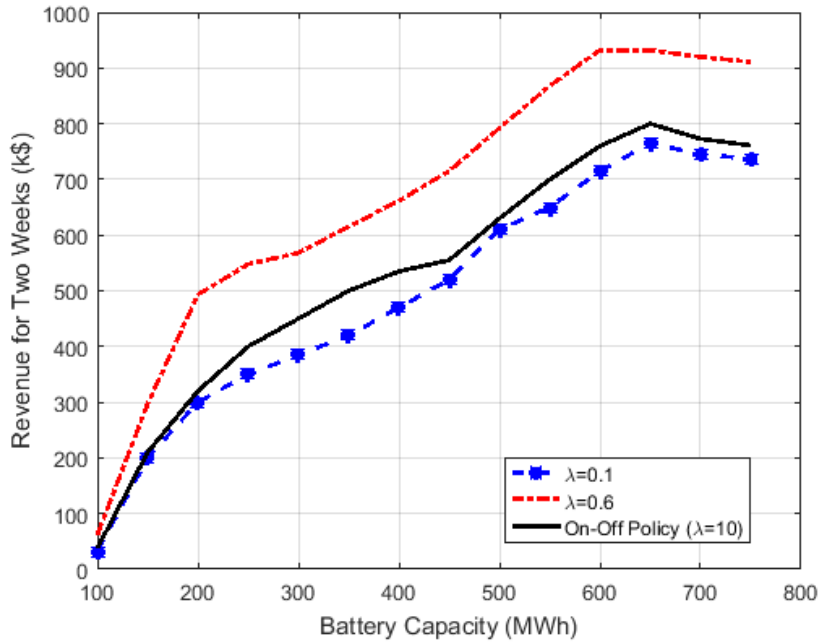

Figure 4.20: Impact of battery capacity on revenue on WPP

## 4.4 Summary

In this study, a novel control scheme has been proposed to manage the amount of energy which is generated and sold to the electricity market with respect to plant and battery constraints. we considered two objectives: (1) empowering the operator to make a balance between energy supply and demand in a profitable way using battery storage; and (2) maximizing the total revenue of the WPP with the aid of choosing appropriate battery capacities in compliance with the capacity of WPP . We simulated our control system using MPC based on dynamic programming. The controller performs well under tight realistic constraints taken from commercial plant ensuring the stability of the system. The proposed control scheme is not limited to the wind power. It can also be leveraged for other intermittent energy sources such as large scale photovoltaic solar farms.

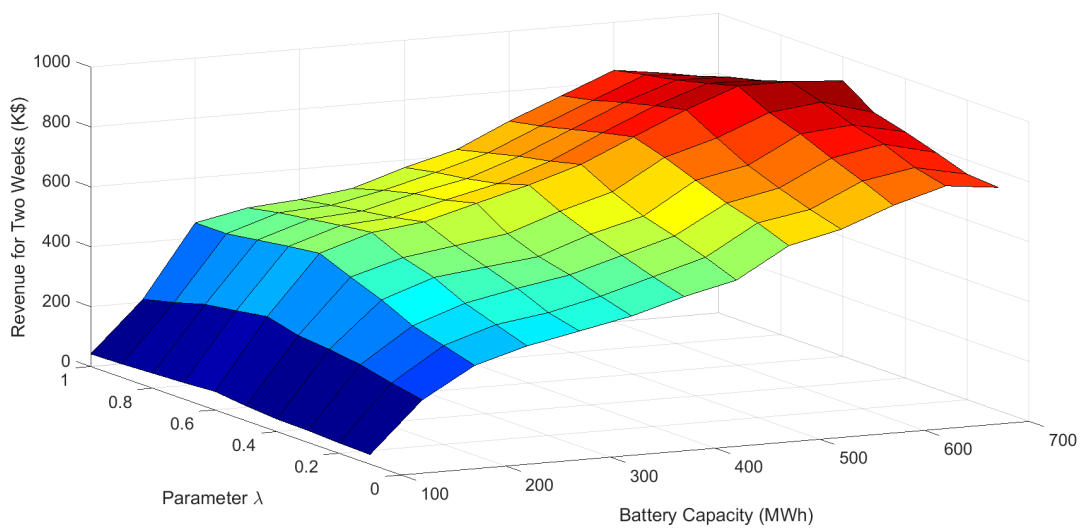

Figure 4.21: Joint impact of  $\lambda$  and capacity

## Chapter 5

# A Simulation Study on Impact of Monotonic Battery Charging/Discharging on Cost and Revenue of Wind Power Plant

The charging/discharging behavior of battery has a significant impact on both cost and revenue of wind power plant (WPP). It has been shown that monotonic charging/discharging strategy has reduced the capital cost of WPP. In this chapter, we present a control approach to manage the income of WPP while we combine the monotonic charging/discharging methodology to our system design. The Controller is based on Model Predictive Control (MPC) theory using a dynamic programming algorithm along with a nonlinear battery energy storage model. We exploit the effect of charging/discharging pattern of the battery to maximize the profit of the output power dispatched to the grid while using forecasted dispatch price and wind power. This chapter is organized as follows. Section 6.1 gives a brief introduction. In section 6.2 problem statement is illustrated. Following that, in section 6.3, the monotonic charging/discharging strategy is expressed, in section 6.4 the proposed control system and the controller design are described. The simulation results are given in Section 6.5. Finally, the chapter is concluded in Section 6.6. The efficiency of this control strategy is assessed under different scenarios via simulations with actual wind farm data and NSW Australia price data.

### 5.1 Introduction

Diverse methods are offered in implementing BESS integrated with wind power plant in order to increase the revenue of WPP. Depends on regulated (fixed tariffs) or deregulated markets (variable tariffs), different techniques are presented. In a basic scenario, energy is stored in the duration of off-peaks and is delivered at peak times in the regulated markets such as Australian electricity market regulations. On the other hand, in the regulated markets for renewable energy productions, simpler

strategies can be proposed to enhance the performance of WPP with the aid of BESS. In this regards, the author of [4] applied a sophisticated control algorithm to manage the hybrid wind power with a constraint optimizer based on the assumption of deregulated market. In [4] a management energy system is designed while storage cost factor is considered. The rule of BESS is essential in all these practical and theoretical studies. Therefore, research on improving the performance of integrating BESS should be considered as the main subject to not only decrease the capital costs of WPP but also increase the total revenue of selling wind power output.

Due to the latest improvement in technology of battery in the market of battery industry, variety of batteries are provided by companies in this area. The cost of battery especially in large scales is one of the main factors for customers. One of the applications of BESSs in large scale is in wind power industry. Charging/discharging strategy highly effects on a lifetime of batteries and consequently affect directly on total costs of the plant which is used. Furthermore, the size of the battery is another parameter which can result in decreasing price of the battery.

Therefore, to improve the lifetime and cost of the battery some studies emphasis on designing strategies to enhance the performance of BESS while it is connected to WPP. For instance, in [63], a constrained monotonic charging/discharging strategy is presented in order to reduce the ramp rate of wind power in respect to the optimal capacity of battery energy storage. In this study, revenue of the plant has not been investigated. Also in [9, 20, 63], batteries assume as simple storages that linearly store the energy and did not take into account the losses inside the battery as their chemical reactions. We consider a model based on its inputs and outputs and consider a model which shows some nonlinear behaviors of the battery during charging, discharging and storing period.

In this chapter, we focus on developing a control strategy to maximize the revenue of WPP while BESS is combined with the system. Meanwhile, we employ the monotonic charging and discharging strategy to not only optimise the capacity of BESS but also enhance the life time of battery simultaneously. We examine the effect of applying the presented strategy in [63] on the revenue of WPP. The proposed controller is examined with real wind farm data from Woolnorth wind farm site in Tasmania, Australia and the dispatch electricity price data of the New South Wales electricity market for the corresponding dates of the wind power generation.

## 5.2 Problem Statement

In this chapter we focus on maximizing wind power plant revenue while WPP is integrated with BESS. Indeed, we employ a strategy that consider the future state of both energy price and wind power by which a reference signal will be dynamically generated. A novel approach in this chapter is emphasising on optimal capacity of BESS by applying monotonic charging and discharging strategy. Therefore, a control system which combined with a BESS is required to control the signal that charges and discharges the battery to produce the desired power as close as possible to the reference power signal.

## 5.3 Monotonic charging/discharging methodology

In [63], a monotonic charging/discharging strategy has been presented to smooth out the fluctuated wind power produced by wind power plant. In this paper we investigate the reflection of applying this method on revenue of the WPP. Since this method plays a fundamental rule in this research, we elaborate it in this section. In this regard we

## 5.4 Control System Design Description

### 5.4.1 Dynamic Model of the System

The following nonlinear dynamic equations are proposed based on the system structure in chapter 3:

$$\begin{cases} x_1(k+1) = r(k) - u(k) \\ x_2(k+1) = f(x_2(k)) + t_d g(x_2(k), u(k)), \end{cases} \quad (5.1)$$

$$y(k) = x_1(k) \quad (5.2)$$

where  $x_1$  or  $p_g(k)$  in Fig.5.2 is the power which is sent to the grid,  $x_2(k)$  is the battery energy capacity at time step  $k$ ,  $r(k)$  is the uncontrolled wind power output,  $u(k)$  or  $p_c$  is power control signal in case of positive values ( $u(k) \geq 0$ ) and for negative values of  $u(k)$  ( $u(k) < 0$ ) the battery is charged and discharged respectively.  $t_d$  is a factor to convert MW to MWh. In (5.1), functions  $f$  and  $g$  are defined to represent the nonlinear behaviour of the battery as below:

$$f(x) = \alpha(x)x \quad (5.3)$$

and,

$$g(x, u) = \begin{cases} \beta(x)Mc & \text{for } u > Mc \\ \beta(x)u & \text{for } 0 \leq u \leq Mc \\ \gamma(x)u & \text{for } Md \leq u < 0 \\ \gamma(x)Md & \text{for } u < Md \end{cases} \quad (5.4)$$

with following constraints

$$\begin{cases} f(x(k)) \leq x(k) & \forall x(k) \\ g(x(k), 0) = 0 & \forall x(k) \\ g(x(k), u(k)) \leq u(k) & \forall x(k), u(k) \end{cases} \quad (5.5)$$

In order to reflect the real behaviour of battery during charging/discharging and storing periods, functions  $f$  and  $g$  are presented. Based on defined function In 5.3,

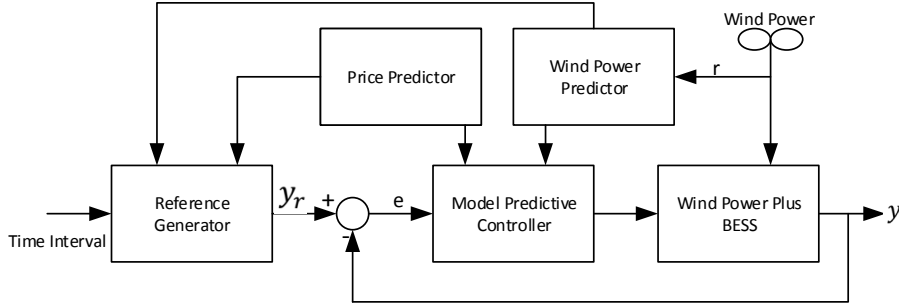

Figure 5.1: Block diagram of the proposed control system.

battery is charged with a coefficient  $\alpha$ . In addition, in 5.4 function  $g$  represents the procedure of charging and discharging when control power signal  $u(k)$  is sent to the battery. Parameters ( $\alpha, \beta$  and  $\gamma$ ) are identified due to extracted experimental data from specific type of battery. In this study, we assume all  $\alpha, \beta$  and  $\gamma$  as constant for all  $x$  for simplicity. As mentioned earlier in this paper, the methodology of charging and discharging of each individual battery is based on the proposed strategy in [63]. The novelty of this work in compare with what it has been presented in [63] is in two folds. First, the problem statement in [63] is smoothing the wind power which is sent to the grid, while in this study we maximize the revenue of WPP and the second contribution is behind the model of the battery. The proposed model in this article is a complementary model of the battery which includes the losses of energy which occurred as explained in this section.

Table 5.1 defines parameters of battery model.

Table 5.1: Parameters of Battery Model

Parameter	Description	Unit
$\alpha$	Battery self discharge rate	%/day
$\beta$	Charging efficiency	%
$\gamma$	Discharging efficiency	%
$Mc$	Maximum charging threshold	MW
$Md$	Maximum discharging threshold	MW

## 5.4.2 Controller Design

MPC is based on the solution of an on-line optimal control problem where a receding horizon approach is utilized in such a way that for any current state  $x(k)$  at time  $k$ , an open loop optimal control problem is solved over some future interval taking into account the current and future constraints. The algorithm of MPC computes an open loop sequence of the manipulated variables in a manner that the upcoming behaviour of the plant is optimized. Then we insert the first value of the optimization into the plant. This procedure is repeated at time  $(k + 1)$  using the current state  $x(k + 1)$  [47]. Some of the major advantages of the MPC are its capability to handle

the constraints, its practical usage, and online optimization. The structure of the proposed control system is illustrated in Fig. 5.1. Therefore, the proposed control law for the system in (5.1) will be obtained by minimizing the following cost function,

$$J := \sum_{k=N_0}^{N_0+N} ((y(k) - y_{ref}(k))^2 \rightarrow \min \quad (5.6)$$

where  $N$  is prediction horizon. Optimization method in this study for minimizing (5.6) is dynamic programming algorithm subject to the system model (5.1) and following constraints,

$$x_{2min} \leq x_2(k) \leq x_{2max} \quad (5.7)$$

$$-U_{max} \leq u(k) \leq U_{max} \quad (5.8)$$

$$0 \leq x_1(k) \leq c_1 \quad (5.9)$$

$$-c_2 \leq x_1(k) - x_1(k-1) \leq c_2 \quad (5.10)$$

for all  $k \in 0, \dots, N-1$  with a given initial condition for  $(x_1)$  and  $(x_2)$  as  $(x_1(N_0))$  and  $x_2(N_0)$  respectively .

The cost function (5.6) penalize the deviations of the reference power signal  $(y_{ref}(k))$  from the power output  $(y(k))$  . There are some constraints which imposed by this system that indicated by (5.7), (5.8) and (5.10). The constraint (5.7) is chosen to avoid overloading or under loading of the battery i.e., the BESS should not be discharged less than  $x_{2min}$  or charged over  $x_{2max}$ .  $U_{max}$  in (5.8) is the maximum charging/discharging rated capacity of the battery. In order to keep the output of the system between 0 and rated value of the wind power ( $c_1$ ), constraint (5.10) is introduced. Constraint (5.10) is defined to control the degree of smoothing. It describes the difference between two consecutive amounts of smoothed wind power.

In order to apply dynamic programming procedure firstly we introduced a function

$$J(x_1, x_2, M) := \min_{u(\cdot)} \sum_{k=N_0}^{N_0+M} ((y(k) - y_{ref}(k))^2 \quad (5.11)$$

Where  $M$  is control horizon. We calculate this equation by complete search method, since  $0 \leq x_1(k) \leq c_1$  ,  $x_{2min} \leq x_2(k) \leq x_{2max}$ , we can take all  $x_1, x_2$  with some small step  $\varepsilon > 0$  for all  $0 \leq M \leq N$ . For simplicity, wind power prediction in the MPC algorithm is used with control horizon to be the same as prediction horizon and to be equal to three ( $N = M = 3$ ).

First we assume that

$$\begin{aligned} J(x_1, x_2, M) &:= \min_{u(\cdot)} \sum_{k=N_0}^{N_0+M} \{(y(k) - y_{ref}(k))^2\} \\ &= \min_{u(\cdot)} \{(y(N_0) - y_{ref}(N_0))^2 + \dots + (y(N_0 + M) - y_{ref}(N_0 + M))^2\}. \end{aligned} \quad (5.12)$$

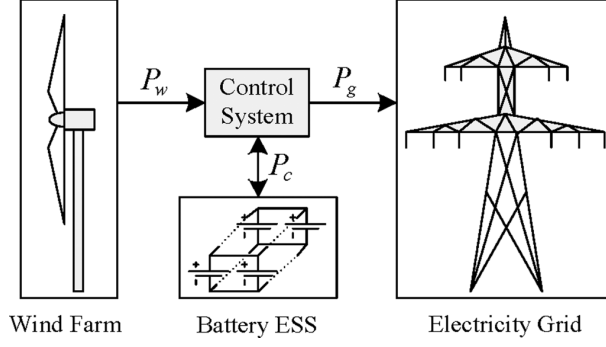

Figure 5.2: Diagram of a sample grid which is connected with a wind farm plus along with BESS

We suppose that,

$$\begin{aligned}
 J_{N_0} &= y(N_0) - y_{ref}(N_0))^2, \\
 J_{N_0+1} &= y(N_0 + 1) - y_{ref}(N_0 + 1))^2, \\
 &\vdots \\
 J_M &= y(N_0 + M) - y_{ref}(N_0 + M))^2
 \end{aligned} \tag{5.13}$$

As we want to optimise  $J(x_1, x_2, M)$  then we presume that

$$\begin{aligned}
 J_{N_0, M}^* &= \min\{J_{0, M-1}^* + J_M\}, \\
 J_{N_0, M-1}^* &= \min\{J_{0, M-2}^* + J_{M-1}\}, \\
 &\vdots \\
 J_{N_0}^* &= \min\{J_{N_0}\}
 \end{aligned} \tag{5.14}$$

In order to calculate  $J_{N_0}^*$ , we do a complete search for all  $x_1, x_2$  by considering their defined constrains to find  $y(N_0)$  from our propose model (5.1) for all  $-U_{max} \leq u \leq U_{max}$  with a small step  $\epsilon$ . After finding an optimal value for  $J_{N_0}^*$  then we go to next step to find  $J_{N_0+1}^*$  and this procedure continues to find  $J_{N_0+M}^*$ .

At the end of the optimization the optimal control signal sequence ,  $u^{opt}(k)$ , will be found for  $k = \{N_0, \dots, N_0 + M\}$  that minimize the whole cost function (5.12).

$$u^{op} = \{u^{op}(N_0), u^{op}(N_0 + 1), \dots, u^{op}(N_0 + M)\} \tag{5.15}$$

Then we choose the first value of this sequence ( $u^{op}(N_0)$ ) as the first value of the optimization and apply it into the plant. This procedure is repeated at time  $(k + 1)$  and in the new step  $N_0$  will be  $N_0 + 1$  and also current states ,according to the model, will be  $x(k + 1)$  . This procedure is repeated for our whole trajectory. The optimization problem at each step is solved using MATLAB.



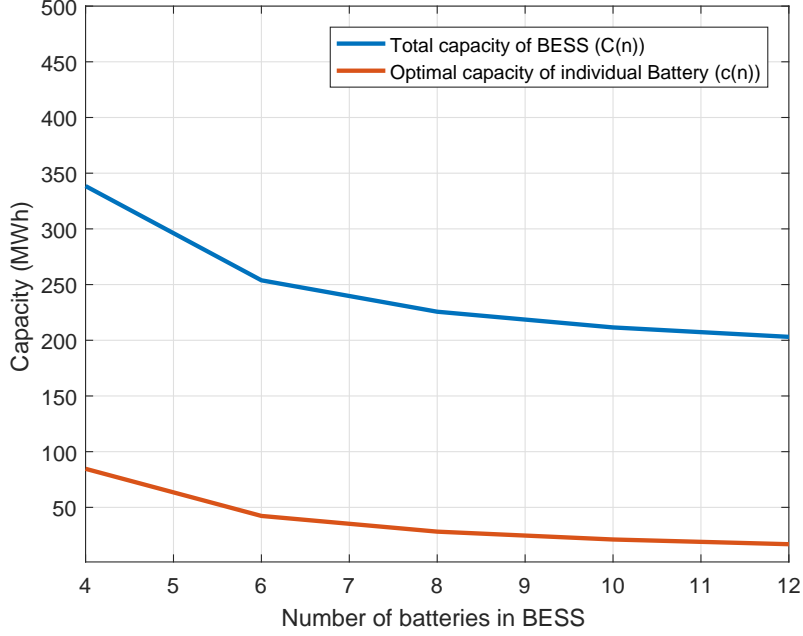

Figure 5.3: BESS numbers vs the optimal BESS capacity

## 5.5 Simulation Results

The proposed control system design has been examined by simulation in MATLAB using actual wind and price data taken from Woolnorth wind farm and AEMO, respectively. In order to implement the monotonic charging/discharging strategy, firstly we need to calculate the parameter  $a$  in (5.16) by Empirical Cumulative Distribution Function (ECDF) [64]. As it is shown in Fig.5.4, we take the absolute values and we chose the higher value against the confident level which assumed 98% as specified in the graph. The calculated value then determine the optimal capacity by the Theorem 1. The minimum capacity of each battery extracts from the formula (5.17) based on the chosen value for  $a$  and it is assigned for 4,6,8,10 batteries which is represented in Fig.5.3. As it is depicted, there is an decreasing trend in amount of capacity by increasing the number of batteries. Moreover, After 10 batteries, there is a negligible diminish. Hence, we simulate the control system for  $n = 2, 3, 4, 5$ .

$$a \leq \int_0^T e(t)dt \leq a \quad \forall T > 0 \quad (5.16)$$

$$c(n) = \frac{a}{(\alpha_M - \alpha_m)(n - 1)} \quad (5.17)$$

Since the objective of this study is maximizing the revenue of WPP, we calculated the revenue for different battery capacities while using 4,6,8 and 10 individual batteries. The comparison has been made between a unique battery with total BESS capacity 400 MWh which we simulated in [65] and the case when we employ

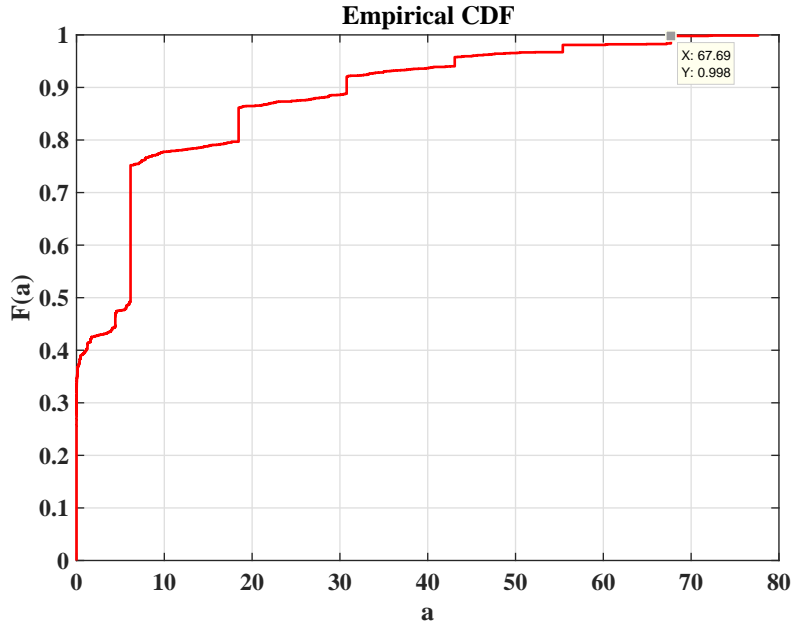

Figure 5.4: The ecdf of absolute values of error signal in (5.16)

Table 5.2: Comparison of Revenue for BEESs

Number of Batteries	1	4	6	8	10
Capacity (MWh)	400	338	253	225	211
Revenue (K\$)	661	615	541	530	516

individual batteries based on the Theorem 1 which specified in section 6.3. It is illustrated in Table.5.2 that in case of using  $2n$  batteries with total capacity of  $C(n)$ , the revenue is slightly lower than using a single battery of capacity  $400MWh$ . In contrast, the capital cost of WPP is decreased dramatically by increasing the number of batteries in BESS. Therefore, although there is a reduction in total revenue of the WPP, a huge saving will be archived in capital cost of WPP by applying the proposed strategy in [63],

Fig.5.6 shows the monotonic behaviour of battery during charging and discharging process for 4 batteries. In this regard, we observe a reduction in number of cycles of each battery in compare with the case of using of one battery with capacity of  $C(n)$ . As a result, the lifetime of battery improves.

To display the performance of the proposed control system design, Fig.5.7 indicates that the output of the closed loop system (Fig. 5.1) follows the reference power which is generated by (4.3) in an acceptable way (with average error of (1.2%)). Battery model parameters which is utilized in this case study are as follows,  $\alpha = 0.98$ ,  $\beta = 0.95$ ,  $\gamma = 1.05$ ,  $M_c = 1.5 * c(n)$  and  $M_d = -2.1 * c(n)$ .

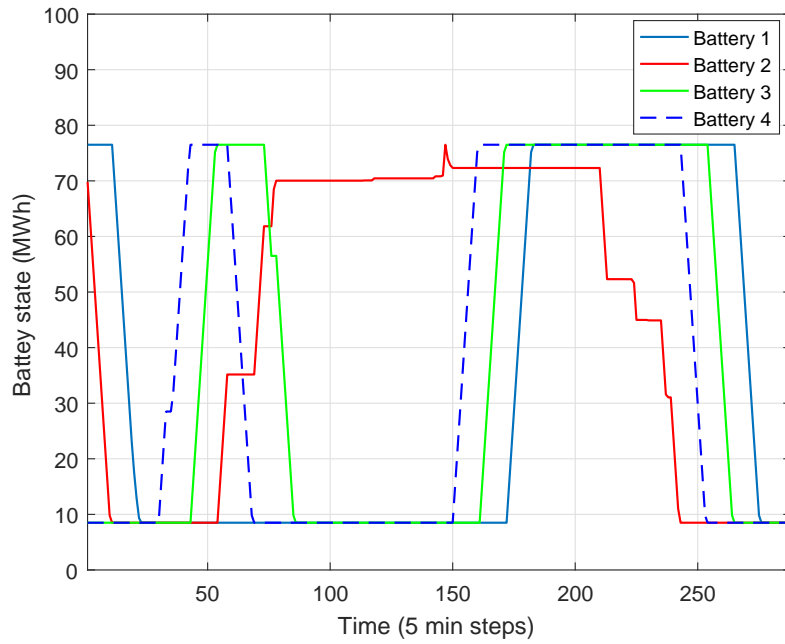

Figure 5.5: Charging and discharging of 4 batteries in a monotonic pattern during 10% and 90% of operation zone for one day sample.

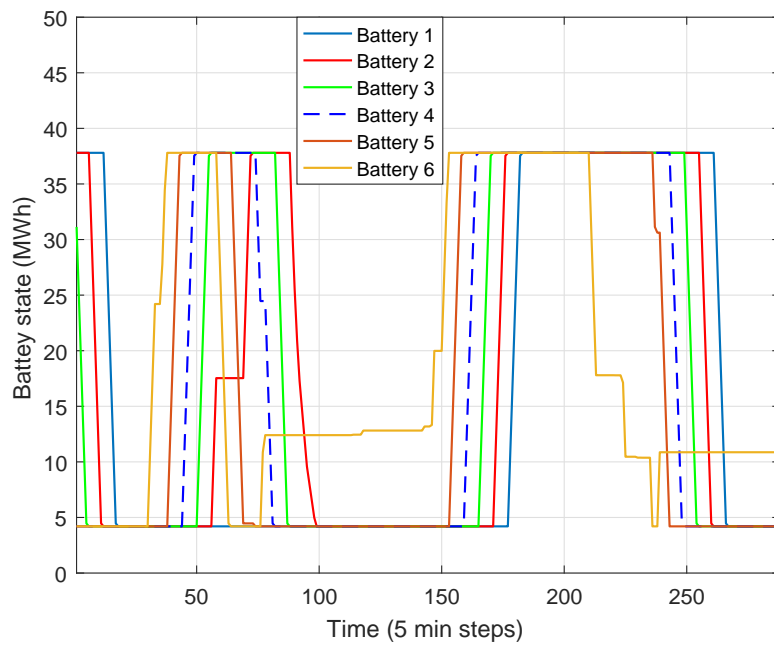

Figure 5.6: Charging and discharging of 6 batteries in a monotonic pattern during 10% and 90% of operation zone for one day sample.

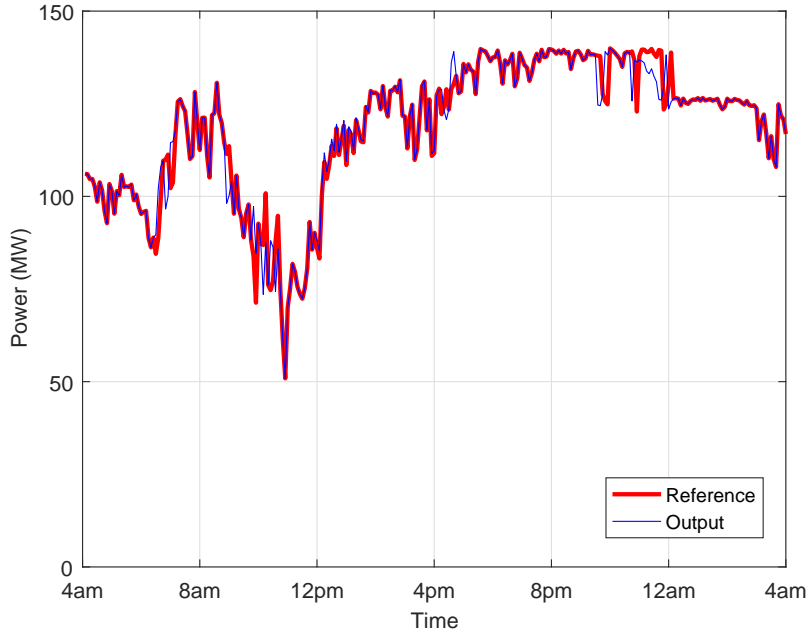

Figure 5.7: Reference and output reference signals for one day in 5-mins times steps. ( $p = 20\$/MWh$  and  $\lambda = 0.6$ .)

Table 5.3: Simulated Constraints Parameters

$x_{2max}$	Upper bound of capacity for each battery	$10\%c(n)$ MWh
$x_{2min}$	Lower bound of capacity for each battery	$90\%c(n)$ MWh
$c_1$	Maximum rated value of wind power	140 MW
$U_{max}$	Maximum charging/discharging capacity	$20\%c(n)$ MW
$c_2$	Maximum ramp rate of wind power	1.4 MW

## 5.6 Conclusion

A control strategy to maximize the revenue of WPP in presence of monotonic charging/discharging strategy has been studied while BESS was integrated with WPP. It has been investigated the effect of monotonic charging/discharging methodology on the cost of the battery as well as revenue of WPP. The simulation results demonstrate a minor reduction in revenue of wind power plant by decreasing the total battery capacity while we employed optimal size of BESS based on the Theorem explained in section 6.3. Furthermore, the outcomes show the improvement in lifetime

of battery by reducing cycle numbers of charging and discharging of each individual battery. The proposed control scheme is not limited to the wind power. It can also be leveraged for other intermittent energy sources such as large-scale photovoltaic solar farms.

# Chapter 6

## Conclusions and Future Works

High penetration of wind power energy in the electricity network grid as a result of reducing the consumption of fossil fuels by governments, encourages researchers and industries to emphasise their effort to not only improve technologies related to the wind power plants but also to enhance the efficiency of its output, technically and financially by employ control theories. Comprehensive literature review on this topic disclosed that energy storage system is the best tool in hand of control theories to change the wind power to a reliable source of energy technically by reducing its fluctuation and financially it helps to raise its total revenue in the competitive electricity market. Background studies also revealed that among a variety of energy storage technologies, batteries are the best match with wind power plants since their size and charging/discharging methodologies. Therefore, in this report, we focused on employing battery energy storage with a new model in wind power plant with a new control strategy to mitigate the challenges related to this attractive green energy.

### 6.1 Conclusions

Since the battery plays a fundamental role in this research, we firstly designed a new generic model in chapter 3 which is applicable to all type of batteries. This new nonlinear battery model captures chemical processes and physical features of a real battery. The model was developed to improve the accuracy of control designing by considering the real property of the battery in the modelling of the system. In previous models, it was needed to investigate equations of chemical reactions inside the battery and there was a complicated procedure to figure out the electrical model of the battery. However, using the proposed model in this report, we can easily change the parameters to obtain a new type of battery based on real data from either experimental result or data from the manufacturer of the battery. Parameters of the proposed model are totally dependent on different factors that are explained in chapter 3 in details. In order to simplify the battery model in some control designs, there should be some assumptions such as no variations in temperature which has been considered in this study.

In chapter 4, we presented a wind power smoothing model. We employed a nonlinear battery model along with a model predictive control technique and applying dynamic programming as an optimization tool to smooth the natural intermittency in the wind power output. The Battery energy storage system (BESS) has been used in many control systems. The purpose of choosing Model Predictive Controller is its capability in handling physical constraints of wind power system (such as battery charging/discharging rate, maximum and minimum rated value of wind power, lower and upper bounds of battery capacity). This controller exploits the inputs from the prediction model which has been embedded in the proposed system in its predictive optimization enhancing the overall performance of the system. The final simulation results showed that the controller worked well under forced practical constraints and it could reduce the ramp rate of output wind power. The data that was used in this case study was obtained from one of real wind farm plants located in Australia. Since this model is flexible compared to other renewable energy sources, the control can be utilized on solar plants as another major source of green energy.

In chapter 5, we emphasize on wind power plant from the financial point of view. We presented a new control approach to increase the overall income of a typical wind power plant. Therefore, we proposed a mathematical formula to create a reference signal for a closed-loop system based on an idea of selling more energy during the time in which the electricity price is higher. The controller is MPC-based and the BESS model implemented in the system is nonlinear. Optimal operation of the system is tested under tight constraints of the real system. Both predicted price and wind power inputs have been inserted into the control system to maximize the income of WPP. The control strategy is based on Australian Electricity Market which is a non-fixed tariff. For other types of electricity markets [66] for renewable energies that exist in the works such as fixed-tariff in Canada, this control strategy can be modified by presenting another methodology in the reference signal. The controller and the model can be applied without any changes for those systems.

Finally, in chapter 6, the optimal capacity of battery energy storage in compliance with the controller design has been investigated. In this regard, a monotonic charging/discharging strategy [63] has been applied to the control system to increase the lifetime of the battery and also decrease the capacity of BESS. The output results of using the optimal capacity methodology revealed that the total capacity of BESS was significantly reduced (much less capital expenditure), though we observed a little reduction in the total revenue of wind power plant. In other words, smaller capacity has a major effect on total cost of wind power plant and it can be good motivation for owners of wind power plants to apply this optimal strategy combined with the control system designed in chapter 5 to improve the total performance of their system technically and financially.

## 6.2 Future works

In the generic nonlinear model of the battery, we put aside the temperature effect on the parameters of the systems. Although in normal situations, we can assume that

the temperature does not have large fluctuation, the variation of ambient temperature can influence the performance of the battery [30, 31, 67]. Therefore, it can be useful to insert the effect of this phenomena in the design of our model. In addition, the charging and discharging efficiency factors which introduced in chapter 3 can be varied based on the rate of charging and discharging. Therefore, to improve the precision of the model, it is more realistic to consider these coefficients as dependent rather than constant. The mathematical equation of these relations should be investigated in future works. The estimation and selection of model parameters may be improved using advanced intelligent techniques instead of intensive empirical studies.

In the smoothing model of wind power plant, the proposed model can be tested for other types of green energies such as solar power. However, some changes should be applied to the model to be matched with that specific renewable energy. Since solar panels recently are being popular especially in small scales such as home usages [68, 69], it may be useful to apply our control strategy to reduce the shortcomings of this source of energy. Batteries in small sizes can be controlled by our proposed strategy for home usages on beside of solar panels. In general, to enhance the overall performance of the control system, further study is essential on the robustness, uncertainty and noise effects in future works. Another direction of future research is to improve the quality of our modelling by using robust model validation and Kalman state estimation techniques such as in [49, 70–73]. For control of BESS modelled as a system with uncertainties, we will need to use more advanced methods of modern robust control such as H-infinity based control design [74–77], robust switched controllers [78–82] and sliding mode control [83–87]. Despite the fact of recent developments of wind power plants in large-scale and increasing its popularity in all countries [3], it has caused various issues of profitability in competitive electricity markets. Hence, complicated price prediction models are needed in compliance with wind power prediction systems to grow the revenue of wind power plant. Each country has its unique electricity market rules [66, 88], thus we suggest a dynamic prediction model to satisfy these differences. Also, large prediction horizon may help to have a better performance on the control outcomes. Combination of lifetime model of battery by considering technical parameters mentioned in [89, 90] with the designed battery model can help in control design to increase the lifetime of batteries. Then it can then incorporated into the cost function of the MPC as one of the parameters for optimal operation of the BESS. One of the approaches to estimate the lifecycle of BESS is known as "Rainflow Cycle Counting" [91]. Therefore, finding a model for the BESS lifecycle and including it in the optimization problem is an interesting future line of research.

BESS expenses always are a big concern for investors in renewable energy plants. We suggest to consider the battery cost for each charging and discharging cycle in the control system design and the cost function ;however, this cost value is nontrivial and can change the overall control strategy [92]. In chapter 6 we studied the effect of optimizing battery capacity on revenue of wind power plant. By considering the cost of battery per  $kw$ , we may reach to a more realistic overview for measuring the net revenue for wind power plant. In future studies, we recommend to calculate the cost



of BESS per  $kw$  in the energy modeling of the system to improve its accuracy [92].

Another direction of future research will be extension of some of the results of this report to the case of decentralized BESS where each battery has its own controller with limited communication to other batteries. In this problem, we will use distributed storage framework of [93,94] that is based on the concept of consensus in multi-agent systems [95–97].

# Bibliography

- [1] S.-P. Breton and G. Moe, “Status, plans and technologies for offshore wind turbines in europe and north america,” *Renewable Energy*, vol. 34, no. 3, pp. 646 – 654, 2009.
- [2] M. Sathyajith, *Wind energy: fundamentals, resource analysis and economics*. Springer, 2006.
- [3] P. Zou, Q. Chen, Y. Yu, Q. Xia, and C. Kang, “Electricity markets evolution with the changing generation mix: An empirical analysis based on china 2050 high renewable energy penetration roadmap,” *Applied Energy*, vol. 185, pp. 56–67, 2017.
- [4] H. H. Abdeltawab and Y. A.-R. I. Mohamed, “Market-oriented energy management of a hybrid wind-battery energy storage system via model predictive control with constraint optimizer,” *IEEE Transactions on Industrial Electronics*, vol. 62, no. 11, pp. 6658–6670, 2015.
- [5] M. Jannati, S. Hosseinian, B. Vahidi, and G.-j. Li, “Adaline (adaptive linear neuron)-based coordinated control for wind power fluctuations smoothing with reduced bess (battery energy storage system) capacity,” *Energy*, vol. 101, pp. 1–8, 2016.
- [6] X. Li, D. Hui, and X. Lai, “Battery energy storage station (bess)-based smoothing control of photovoltaic (pv) and wind power generation fluctuations,” *IEEE Transactions on Sustainable Energy*, vol. 4, no. 2, pp. 464–473, 2013.
- [7] E. Y. Bitar, R. Rajagopal, P. P. Khargonekar, K. Poolla, and P. Varaiya, “Bringing wind energy to market,” *IEEE Transactions on Power Systems*, vol. 27, no. 3, pp. 1225–1235, 2012.
- [8] Y. Gong, Q. Jiang, and R. Baldick, “Ramp event forecast based wind power ramp control with energy storage system,” *IEEE Transactions on Power Systems*, vol. 31, no. 3, pp. 1831–1844, 2016.
- [9] M. Khalid and A. V. Savkin, “A model predictive control approach to the problem of wind power smoothing with controlled battery storage,” *Renewable Energy*, vol. 35, no. 7, pp. 1520–1526, 2010.

- [10] P. Alotto, M. Guarnieri, and F. Moro, “Redox flow batteries for the storage of renewable energy: A review,” *Renewable and Sustainable Energy Reviews*, vol. 29, pp. 325–335, 2014.
- [11] H. Zhao, Q. Wu, S. Hu, H. Xu, and C. N. Rasmussen, “Review of energy storage system for wind power integration support,” *Applied Energy*, vol. 137, pp. 545–553, 2015.
- [12] K. Divya and J. Østergaard, “Battery energy storage technology for power systemsan overview,” *Electric Power Systems Research*, vol. 79, no. 4, pp. 511–520, 2009.
- [13] J. P. Barton and D. G. Infield, “Energy storage and its use with intermittent renewable energy,” *IEEE transactions on energy conversion*, vol. 19, no. 2, pp. 441–448, 2004.
- [14] A. Bito, “Overview of the sodium-sulfur battery for the iee stationary battery committee,” in *Power Engineering Society General Meeting, 2005. IEEE*, 2005, pp. 1232–1235.
- [15] Z. M. Salameh, M. A. Casacca, and W. A. Lynch, “A mathematical model for lead-acid batteries,” *IEEE Transactions on Energy Conversion*, vol. 7, no. 1, pp. 93–98, 1992.
- [16] M. A. Casacca and Z. M. Salameh, “Determination of lead-acid battery capacity via mathematical modeling techniques,” *IEEE Transactions on Energy Conversion*, vol. 7, no. 3, pp. 442–446, 1992.
- [17] M. Dürr, A. Cruden, S. Gair, and J. McDonald, “Dynamic model of a lead acid battery for use in a domestic fuel cell system,” *Journal of power Sources*, vol. 161, no. 2, pp. 1400–1411, 2006.
- [18] H. Chan, “A new battery model for use with battery energy storage systems and electric vehicles power systems,” in *Power Engineering Society Winter Meeting, 2000. IEEE*, vol. 1. IEEE, 2000, pp. 470–475.
- [19] M. Khalid and A. V. Savkin, “Model predictive control for wind power generation smoothing with controlled battery storage,” in *Proceedings of the 48th IEEE Conference on Decision and Control, 2009 held jointly with the 2009 28th Chinese Control Conference. CDC/CCC 2009.*, Dec 2009, pp. 7849–7853.
- [20] A. Khatamianfar, M. Khalid, A. V. Savkin, and V. G. Agelidis, “Improving wind farm dispatch in the australian electricity market with battery energy storage using model predictive control,” *IEEE Transactions on Sustainable Energy*, vol. 4, no. 3, pp. 745–755, July 2013.
- [21] D. Linden and T. B. Reddy, “Handbook of batteries. 3rd,” 2002.
- [22] T. P. Crompton, *Battery reference book*. Newnes, 2000.

- [23] W. van Schalkwijk and B. Scrosati, *Advances in lithium-ion batteries*. Springer Science & Business Media, 2007.
- [24] S. Bangaru, R. Alugonda, and P. Palacharla, “Modeling and simulation of lithium-ion battery with hysteresis for industrial applications,” in *Energy Efficient Technologies for Sustainability (ICEETS), 2013 International Conference on*. IEEE, 2013, pp. 771–775.
- [25] M. Chen and G. A. Rincon-Mora, “Accurate electrical battery model capable of predicting runtime and iv performance,” *IEEE transactions on energy conversion*, vol. 21, no. 2, pp. 504–511, 2006.
- [26] A. Rahmoun, H. Biechl, and A. Rosin, “Soc estimation for li-ion batteries based on equivalent circuit diagrams and the application of a kalman filter,” in *Electric Power Quality and Supply Reliability Conference (PQ), 2012*. IEEE, 2012, pp. 1–4.
- [27] D. Sun and X. Chen, “Adaptive parameter identification method and state of charge estimation of lithium ion battery,” in *Electrical Machines and Systems (ICEMS), 2014 17th International Conference on*. IEEE, 2014, pp. 855–860.
- [28] O. Tremblay, L.-A. Dessaint, and A.-I. Dekkiche, “A generic battery model for the dynamic simulation of hybrid electric vehicles,” in *Vehicle Power and Propulsion Conference, 2007. VPPC 2007. IEEE*. IEEE, 2007, pp. 284–289.
- [29] M. Ceraolo, “New dynamical models of lead-acid batteries,” *IEEE Transactions on Power Systems*, vol. 15, no. 4, pp. 1184–1190, 2000.
- [30] L. Liao, P. Zuo, Y. Ma, X. Chen, Y. An, Y. Gao, and G. Yin, “Effects of temperature on charge/discharge behaviors of lifepo 4 cathode for li-ion batteries,” *Electrochimica Acta*, vol. 60, pp. 269–273, 2012.
- [31] B. Plangklang and P. Pornharuthai, “Mathematical model and experiment of temperature effect on discharge of lead-acid battery for pv systems in tropical area,” *Energy and Power Engineering*, vol. 5, no. 01, p. 43, 2013.
- [32] J. P. Dunlop *et al.*, “Batteries and charge control in stand-alone photovoltaic systems: Fundamentals and application,” *Sandia National Laboratories*, 1997.
- [33] B. Tamyurek, D. K. Nichols, and O. Demirci, “The nas battery: a multifunction energy storage system,” in *Power Engineering Society General Meeting, 2003, IEEE*, vol. 4. IEEE, 2003, pp. 1991–1996.
- [34] T. Oshima and H. Abe, “Development of compact sodium sulfur batteries,” in *6th international Conf. on Batteries for Utility Energy Storage, September 1999, NGK Insulators*, 1999.

- [35] M. Kamibayashi and K. Tanaka, “Recent sodium sulfur battery applications,” in *Transmission and Distribution Conference and Exposition, 2001 IEEE/PES*, vol. 2. IEEE, 2001, pp. 1169–1173.
- [36] D. Nichols and M. Kamibayashi, “Market development for the sodium sulfur battery,” in *Proc. 2002 Electrical Energy Storage Applications and Technologies Conference*, 2002.
- [37] M. Kamibayashi, D. K. Nichols, and T. Oshima, “Development update of the nas battery,” in *Transmission and Distribution Conference and Exhibition 2002: Asia Pacific. IEEE/PES*, vol. 3. IEEE, 2002, pp. 1664–1668.
- [38] N. Mizuho, “Sodium sulfur battery catalog,” NGK Insulators Ltd., Tech. Rep., 2009.
- [39] M. Kamibayashi and K. Furuta, “High charge and discharge cycle durability of the sodium sulfur (nas) battery,” in *Proc. 2002 Electrical Energy Storage Applications and Technologies Conference*, 2002, pp. 15–17.
- [40] S. Teleke, M. Baran, A. Huang, S. Bhattacharya, and L. Anderson, “Control strategies for battery energy storage for wind farm dispatching,” *IEEE Transactions on Energy Conversion*, vol. 24, no. 3, pp. 725–732, Sept 2009.
- [41] X. Wang, D. Mahinda Vilathgamuwa, and S. Choi, “Determination of battery storage capacity in energy buffer for wind farm,” *IEEE Transactions on Energy Conversion*, vol. 23, no. 3, pp. 868–878, Sept 2008.
- [42] N. Cutler, M. Kay, H. Outhred, and I. MacGill, “High-risk scenarios for wind power forecasting in australia,” in *Proceedings of the European Wind Energy Conference*, 2007.
- [43] M. Korpaas, A. T. Holen, and R. Hildrum, “Operation and sizing of energy storage for wind power plants in a market system,” *International Journal of Electrical Power & Energy Systems*, vol. 25, no. 8, pp. 599–606, 2003.
- [44] “Pre-dispatch process description,” AEMO Documents, Tech. Rep., July 2010.
- [45] M. Khalid and A. Savkin, “A method for short-term wind power prediction with multiple observation points,” *IEEE Transactions on Power Systems*, vol. 27, no. 2, pp. 579–586, 2012.
- [46] D. Mandic, S. Javidi, S. Goh, A. Kuh, and K. Aihara, “Complex-valued prediction of wind profile using augmented complex statistics,” *Renewable Energy*, vol. 34, no. 1, pp. 196–201, 2009.
- [47] G. C. Goodwin, S. F. Graebe, and M. E. Salgado, *Control system design*. Prentice Hall New Jersey, 2001, vol. 240.

- [48] M. T. Zareifard and A. V. Savkin, “Model predictive control for wind power generation smoothing with controlled battery storage based on a nonlinear battery mathematical model,” in *Control Conference (ASCC), 2015 10th Asian*. IEEE, 2015, pp. 1–6.
- [49] A. V. Savkin and I. R. Petersen, “Set-valued state estimation via a limited capacity communication channel,” *IEEE Transactions on Automatic Control*, vol. 48, no. 4, pp. 676–680, 2003.
- [50] A. S. Matveev and A. V. Savkin, “Multirate stabilization of linear multiple sensor systems via limited capacity communication channels,” *SIAM journal on control and optimization*, vol. 44, no. 2, pp. 584–617, 2005.
- [51] ———, “An analogue of Shannon information theory for detection and stabilization via noisy discrete communication channels,” *SIAM journal on control and optimization*, vol. 46, no. 4, pp. 1323–1367, 2007.
- [52] ———, “Shannon zero error capacity in the problems of state estimation and stabilization via noisy communication channels,” *International Journal of Control*, vol. 80, no. 2, pp. 241–255, 2007.
- [53] S. Teleke, M. Baran, S. Bhattacharya, and A. Huang, “Optimal control of battery energy storage for wind farm dispatching,” *IEEE Transactions on Energy Conversion*, vol. 25, no. 3, pp. 787–794, Sept 2010.
- [54] M. Khalid and A. V. Savkin, “Minimization and control of battery energy storage for wind power smoothing: Aggregated, distributed and semi-distributed storage,” *Renewable Energy*, vol. 64, pp. 105–112, 2014.
- [55] A. Arulampalam, M. Barnes, N. Jenkins, and J. Ekanayake, “Power quality and stability improvement of a wind farm using statcom supported with hybrid battery energy storage,” *Generation, Transmission and Distribution, IEE Proceedings-*, vol. 153, no. 6, pp. 701–710, November 2006.
- [56] J. Zeng, B. Zhang, C. Mao, and Y. Wang, “Use of battery energy storage system to improve the power quality and stability of wind farms,” in *International Conference on Power System Technology, 2006. PowerCon 2006*, Oct 2006, pp. 1–6.
- [57] R. Dufo-López, J. L. Bernal-Agustín, and J. A. Domínguez-Navarro, “Generation management using batteries in wind farms: Economical and technical analysis for Spain,” *Energy policy*, vol. 37, no. 1, pp. 126–139, 2009.
- [58] P. Saran, J. Goentzel, and C. W. Siegert, “Economic analysis of wind plant and battery storage operation using supply chain management techniques,” in *Power and Energy Society General Meeting, 2010 IEEE*. IEEE, 2010, pp. 1–8.

- [59] D. Yao, S. Choi, K. Tseng, and T. Lie, “Determination of a dispatch strategy to maximize income for a wind turbine-bess power station,” in *IPEC, 2010 Conference Proceedings*. IEEE, 2010, pp. 402–407.
- [60] J. Contreras, R. Espinola, F. J. Nogales, and A. J. Conejo, “Arima models to predict next-day electricity prices,” *Power Systems, IEEE Transactions on*, vol. 18, no. 3, pp. 1014–1020, 2003.
- [61] O. B. Fosso, A. Gjelsvik, A. Haugstad, B. Mo, and I. Wangensteen, “Generation scheduling in a deregulated system. the norwegian case,” *Power Systems, IEEE Transactions on*, vol. 14, no. 1, pp. 75–81, 1999.
- [62] M. T. Zareifard and A. V. Savkin, “Model predictive control for output smoothing and maximizing the income of a wind power plant integrated with a battery energy storage system,” in *Control Conference (CCC), 2016 35th Chinese*. IEEE, 2016, pp. 8732–8737.
- [63] A. V. Savkin, M. Khalid, and V. G. Agelidis, “A constrained monotonic charging/discharging strategy for optimal capacity of battery energy storage supporting wind farms,” *IEEE Transactions on Sustainable Energy*, vol. 7, no. 3, pp. 1224–1231, 2016.
- [64] X. Wang, M. Yue, E. Muljadi, and W. Gao, “Probabilistic approach for power capacity specification of wind energy storage systems,” *IEEE Transactions on Industry Applications*, vol. 50, no. 2, pp. 1215–1224, 2014.
- [65] M. T. Zareifard, “Model predictive control of electricity market oriented wind farm dispatch with a battery energy storage system,” in *Control Applications (CCA), 2015 IEEE Conference on*. IEEE, 2015, pp. 727–732.
- [66] Y. Li and P. C. Flynn, “Deregulated power prices: comparison of volatility,” *Energy Policy*, vol. 32, no. 14, pp. 1591–1601, 2004.
- [67] Z. F. Hussien, L. W. Cheung, F. Siam, and A. B. Ismail, “Modeling of sodium sulfur battery for power system applications,” *Elektrika Journal of Electrical Engineering*, vol. 9, no. 2, pp. 66–72, 2007.
- [68] C. Wang, Y. Zhou, B. Jiao, Y. Wang, W. Liu, and D. Wang, “Robust optimization for load scheduling of a smart home with photovoltaic system,” *Energy Conversion and Management*, vol. 102, pp. 247–257, 2015.
- [69] Y. Iwafune, T. Ikegami, J. G. da Silva Fonseca, T. Oozeki, and K. Ogimoto, “Cooperative home energy management using batteries for a photovoltaic system considering the diversity of households,” *Energy Conversion and Management*, vol. 96, pp. 322–329, 2015.
- [70] A. V. Savkin and I. R. Petersen, “Robust state estimation and model validation for discrete-time uncertain systems with a deterministic description of noise and uncertainty,” *Automatica*, vol. 34, no. 2, pp. 271–274, 1998.

- [71] I. R. Petersen and A. V. Savkin, *Robust Kalman filtering for signals and systems with large uncertainties*. Springer Science & Business Media, 1999.
- [72] P. N. Pathirana, N. Bulusu, A. V. Savkin, and S. Jha, “Node localization using mobile robots in delay-tolerant sensor networks,” *IEEE transactions on Mobile Computing*, vol. 4, no. 3, pp. 285–296, 2005.
- [73] P. N. Pathirana, A. V. Savkin, and S. Jha, “Mobility modelling and trajectory prediction for cellular networks with mobile base stations,” in *Proceedings of the 4th ACM international symposium on Mobile ad hoc networking & computing*. ACM, 2003, pp. 213–221.
- [74] I. R. Petersen, V. A. Ugrinovskii, and A. V. Savkin, *Robust control design using H-infinity methods*. Springer-Verlag London, 2000.
- [75] A. V. Savkin and I. R. Petersen, “Minimax optimal control of uncertain systems with structured uncertainty,” *International Journal of Robust and Nonlinear Control*, vol. 5, no. 2, pp. 119–137, 1995.
- [76] A. S. Matveev and A. V. Savkin, “The problem of LQG optimal control via a limited capacity communication channel,” *Systems & control letters*, vol. 53, no. 1, pp. 51–64, 2004.
- [77] A. V. Savkin and T. M. Cheng, “Detectability and output feedback stabilizability of nonlinear networked control systems,” *IEEE Transactions on Automatic Control*, vol. 52, no. 4, pp. 730–735, 2007.
- [78] A. V. Savkin and R. J. Evans, *Hybrid dynamical systems: controller and sensor switching problems*. Springer Science & Business Media, 2002.
- [79] E. Skafidas, R. J. Evans, A. V. Savkin, and I. R. Petersen, “Stability results for switched controller systems,” *Automatica*, vol. 35, no. 4, pp. 553–564, 1999.
- [80] A. S. Matveev and A. V. Savkin, *Qualitative theory of hybrid dynamical systems*. Springer Science & Business Media, 2012.
- [81] A. V. Savkin, E. Skafidas, and R. J. Evans, “Robust output feedback stabilizability via controller switching,” *Automatica*, vol. 35, no. 1, pp. 69–74, 1999.
- [82] A. V. Savkin and A. S. Matveev, “Cyclic linear differential automata: A simple class of hybrid dynamical systems,” *Automatica*, vol. 36, no. 5, pp. 727–734, 2000.
- [83] V. Utkin, J. Guldner, and J. Shi, *Sliding mode control in electro-mechanical systems*. CRC press, 2009, vol. 34.
- [84] V. I. Utkin, *Sliding modes in control and optimization*. Springer Science & Business Media, 2013.



- [85] ———, *Sliding modes and their application in variable structure systems*. Mir publishers, 1978.
- [86] M. Hoy, A. S. Matveev, and A. V. Savkin, “Algorithms for collision-free navigation of mobile robots in complex cluttered environments: a survey,” *Robotica*, vol. 33, no. 03, pp. 463–497, 2015.
- [87] A. S. Matveev, C. Wang, and A. V. Savkin, “Real-time navigation of mobile robots in problems of border patrolling and avoiding collisions with moving and deforming obstacles,” *Robotics and Autonomous systems*, vol. 60, no. 6, pp. 769–788, 2012.
- [88] A. Mazer, *Electric power planning for regulated and deregulated markets*. John Wiley & Sons, 2007.
- [89] J. Schiffer, D. U. Sauer, H. Bindner, T. Cronin, P. Lundsager, and R. Kaiser, “Model prediction for ranking lead-acid batteries according to expected lifetime in renewable energy systems and autonomous power-supply systems,” *Journal of Power sources*, vol. 168, no. 1, pp. 66–78, 2007.
- [90] B. Zakeri and S. Syri, “Electrical energy storage systems: A comparative life cycle cost analysis,” *Renewable and Sustainable Energy Reviews*, vol. 42, pp. 569–596, 2015.
- [91] H. Bindner, T. Cronin, P. Lundsager, J. F. Manwell, U. Abdulwahid, and I. Baring-Gould, “Lifetime modelling of lead acid batteries,” Tech. Rep., 2005.
- [92] P. Poonpun and W. T. Jewell, “Analysis of the cost per kilowatt hour to store electricity,” *IEEE Transactions on energy conversion*, vol. 23, no. 2, pp. 529–534, 2008.
- [93] T. Morstyn, A. Savkin, B. Hredzak, and V. Agelidis, “Multi-agent sliding mode control for state of charge balancing between battery energy storage systems distributed in a dc microgrid,” *IEEE Transactions on Smart Grid*, 2017.
- [94] T. Morstyn, A. V. Savkin, B. Hredzak, and V. G. Agelidis, “Distributed sliding mode control for multi-module battery energy storage system state of charge balancing,” in *Control Applications (CCA), 2016 IEEE Conference on*. IEEE, 2016, pp. 47–51.
- [95] R. Olfati-Saber, J. A. Fax, and R. M. Murray, “Consensus and cooperation in networked multi-agent systems,” *Proceedings of the IEEE*, vol. 95, no. 1, pp. 215–233, 2007.
- [96] W. Ren and R. W. Beard, *Distributed consensus in multi-vehicle cooperative control*. Springer, 2008.

- [97] A. V. Savkin, “Coordinated collective motion of groups of autonomous mobile robots: Analysis of vicsek’s model,” *IEEE Transactions on Automatic Control*, vol. 49, no. 6, pp. 981–982, 2004.