



HAL
open science

Measuring emissions from livestock farming: greenhouse gases, ammonia and nitrogen oxides

Mélynda Hassouna, Thomas Eglin, Pierre Cellier, Vincent Colomb, Jean-Pierre Cohan, Céline Décuq, Monique Delabuis, Nadège Edouard, Sandrine Espagnol, Maguy Eugène, et al.

► To cite this version:

Mélynda Hassouna, Thomas Eglin, Pierre Cellier, Vincent Colomb, Jean-Pierre Cohan, et al.. Measuring emissions from livestock farming: greenhouse gases, ammonia and nitrogen oxides. INRA-ADEME, 2016, ISBN 2-7380-1392-9. hal-01567208

HAL Id: hal-01567208

<https://hal.science/hal-01567208v1>

Submitted on 21 Jul 2017

HAL is a multi-disciplinary open access archive for the deposit and dissemination of scientific research documents, whether they are published or not. The documents may come from teaching and research institutions in France or abroad, or from public or private research centers.

L'archive ouverte pluridisciplinaire **HAL**, est destinée au dépôt et à la diffusion de documents scientifiques de niveau recherche, publiés ou non, émanant des établissements d'enseignement et de recherche français ou étrangers, des laboratoires publics ou privés.



Measuring emissions from livestock farming



Greenhouse gases,
ammonia and nitrogen oxides

Coordinators : Mélynda HASSOUNA and Thomas EGLIN



Measuring emissions from livestock farming: greenhouse gases, ammonia and nitrogen oxides

Table of Contents

Table of Contents	3
Tables	7
Coordinators	8
Contributors	8
Reviewers	9
Foreword	11
1 Challenges of measuring the emissions from livestock farms	13
1.1 <i>General</i>	13
1.1.1 Emissions increased by the intensification of livestock farming.....	13
1.1.2 Effect on the environment and health.....	13
1.1.3 Nutrient losses and potential savings in inputs	14
1.2 <i>Characteristics, formation processes, health and environmental effects of the target gases</i>	15
1.2.1 Reactive nitrogen gases (NH ₃ , NO _x , N ₂ O)	15
1.2.2 Methane (CH ₄).....	22
1.2.3 Carbon dioxide (CO ₂).....	23
1.3 <i>Characterization of emissions from livestock production using emission factors</i>	25
1.4 <i>Emission regulations</i>	27
1.4.1 Outdoor air quality and exposure limits.....	27
1.4.2 National emission reduction commitments	28
1.4.3 Reducing emissions at source.....	30
1.5 <i>Conclusions</i>	31
1.6 <i>Bibliography</i>	32
2 Measurement methods: type, description, applications and uncertainties	35
2.1 <i>General principles</i>	35
2.2 <i>Measurement methods</i>	36
Application note 1 - Measuring mean nitrogenous gas concentrations with passive diffusion samplers ...	39
Application note 2 - Measuring nitrogen gas concentrations using denuder tubes.....	43
Application note 3 - Measuring NH ₃ concentrations by trapping in an acid solution.....	47
Application note 4 - Continuous sampling methods for real-time analysis	51
Application note 5 - Taking air samples using sample bags and tubes	55
Application note 6 - Point measurement of gas concentrations using colorimetric gas detector tubes	59
Application note 7 - Laboratory assays of ammonium (NH ₄ ⁺) in solution.....	61
Application note 8 - Measuring the concentration of CH ₄ , CO ₂ and N ₂ O by gas chromatography.....	65
Application note 9 - Measuring gas concentrations by chemiluminescence	69
Application note 10 - Fourier transform and photoacoustic infrared absorption spectroscopy.....	75
Application note 11 - Differential optical absorption spectroscopy (DOAS)	79
Application note 12 - Laser absorption spectroscopy.....	83

Application note 13 - Measuring airflow for buildings with forced ventilation using an anemometer	87
Application note 14 - Determining airflow for livestock buildings using a tracer gas.....	91
Application note 15 - Determining airflow for livestock buildings by heat balance	95
Application note 16 - Determining airflow for livestock buildings by CO ₂ concentration.....	99
Application note 17 - Measuring CH ₄ and CO ₂ emissions from ruminants in partially open enclosures ...	103
Application note 18 - Measuring CO ₂ and enteric CH ₄ emissions by ruminants using a tracer gas (SF ₆)...	107
Application note 19 - Estimating individual CH ₄ and CO ₂ emissions from cattle using Greenfeed™	111
Application note 20 - System for measuring emissions from manure under controlled conditions	115
Application note 21 - Estimating emissions by mass balance for livestock buildings or manure storage .	119
Application note 22 - Simplified method for measuring emissions from livestock buildings using concentration ratios and mass balance	123
Application note 23 - Using static flux chambers to measure emissions from litter, manure and soils	127
Application note 24 - Dynamic flux chambers and wind tunnels	131
Application note 25 - Determining N losses when spreading manure using an ¹⁵ N tracer	137
Application note 26 - Measuring distributed sources of emissions using integrated horizontal flux.....	141
Application note 27 - Measuring emissions from diffuse sources using the perimeter profile method ...	145
Application note 28 - Measuring emissions from diffuse sources using the aerodynamic gradient	149
Application note 29 - Measuring emissions from diffuse sources using COTAG	155
Application note 30 - Estimating emissions from source by inverse modeling	159
Application note 31 - Measuring emissions from a diffuse source by eddy covariance	165
Application note 32 - Measuring emissions from a diffuse source using REA, DEC and vDEC	169
2.3 Summary of the advantages and limitations of the methods.....	174
2.3.1 Sampling methods	174
2.3.2 Concentration analysis methods.....	176
2.3.3 Methods for measuring airflows in livestock buildings or covered manure storage	180
2.3.4 Emission measurement methods (livestock buildings, manure storage, fields, pasture)	182
2.4 Selecting the most appropriate method to meet the requirements.....	190
2.4.1 Measuring emissions for scientific purposes.....	190
2.4.2 Producing emission factors	190
2.4.3 Systematic improvement of the production process.....	191
2.4.4 Verifying the performance of a process or equipment before putting it into use.....	191
2.4.5 Verifying compliance with regulations or voluntary commitment	192
2.5 Evaluating the uncertainty for measuring emissions from animal production	193
2.5.1 Definitions	193
2.5.2 Evaluating the measurement uncertainty according to the GUM	194
2.5.3 Need to evaluate the uncertainty for emission measurements	199
2.5.4 Uncertainty of emissions from animal production	200
2.5.5 Case study of the measurement uncertainty for effectiveness of deodorization products	201
2.5.6 Bibliography.....	205
3 Conclusions and outlook.....	207
4 Glossary.....	211
5 Abbreviations and units.....	217
6 Contact	219
7 Abstract	220

Figures

Letter M refers to “Method” application notes (MX.i.: Figure N°i in Method application note N°X).

Figure I. Nitrogen lost in the form of NH ₃ and N ₂ O from pasture, livestock building and slurry handling on a typical dairy farm in France (Gac et al., 2006)	15
Figure II. Simplified diagram of the processes leading to the formation of reactive nitrogen gases (ADEME 2012)	16
Figure III. Deposition of nitrogen as ammonia depending on the distance from the source (Lallemant and Weber, 1996 and ADEME, 2012)	19
Figure IV. Variability of NH ₃ emissions in a dairy cow building in the international literature	26
(Charpiot <i>et al.</i> , 2012)	26
Figure V. Schematic representation of the use of the various emission calculation methods, from sampling to emission flow calculation, illustrated for a livestock building	36
Figure M1.1. Some examples of tube-type and badge-type passive diffusion samplers (Tang <i>et al.</i> , 2001)	39
Figure M1.2. Cross-section of an ALPHA sampler	40
Figure M1.3. ALPHA sampling system used in the field	40
Figure M2.1. Schematic showing the operating principles of active diffusion tubes	43
Figure M2.2. Denuder tube system developed at CEH Edinburg (Tang <i>et al.</i> 2009)	44
Figure M3.1. Schematic of a typical impinger train	48
Figure M4.1. Heated air gas sampling system	52
Figure M5.1. Flexfoil® sample bag used for sampling the air in livestock buildings (source INRA)	56
Figure M5.2. Two glass air sample tubes with septa (source INRA)	57
Figure M6.1. Sampling pump with colorimetric gas detector tube (source: Solène Lagadec, Brittany regional chamber of agriculture)	59
Figure M7.1. Berthelot reaction	61
Figure M7.2. Semi permeable membrane separation and conductivity assay	62
Figure M7.3. Schematic of an ion chromatographic assay method	62
Figure M8.1. Air handling train of a chromatograph with an FID to quantify CH ₄ and CO ₂ and an ECD for N ₂ O (Godbout <i>et al.</i> , 2012)	65
Figure M8.2. Example of a chromatogram for a greenhouse gas reference mixture (CH ₄ , N ₂ O and CO ₂) (Godbout <i>et al.</i> , 2012)	67
Figure M9.1. Schematic of a chemiluminescence NH ₃ -NO ₂ -NO analyzer	70
Figure M10.1. Schematic showing a Fourier transform infrared spectroscopy system for analyzing agricultural emissions	76
Figure M11.1. Intensities I_{λ} , $I_{0,\lambda}$ and $I_{0,\lambda}'$ in an absorption spectrum (EN 16253:2013)	79
Figure M11.2. Bistatic open path active DOAS system	80
In a bistatic system, the source and the detector are fixed at opposite ends of the light path. Monostatic systems have a retro-reflector that reflects the light beam back towards the detector. ...	80
Figure M12.1. Absorption cross-section (cm ² .molecule ⁻¹) of N ₂ O as a function of the wavenumber (cm ⁻¹).	83
Figure M12.2. Off-Axis Integrated Cavity Output Spectroscopy	84
Figure M12.3. Cavity Ring-Down spectroscopy	85
Figure M13.1. Measuring the air speed in an extraction duct using a hot-wire anemometer	87

Figure M14.1. Duct for dispersing the tracer gas within a building (source: INRA)	91
Figure M17.1. A partially open emissions measurement enclosure (source: INRA)	103
Figure M17.2. Schematic of a partially open enclosure (source: INRA)	104
Figure M18.1. Equipment required	108
Figure M18.2. Permeation tube	108
Figure M19.1. Animal feeding from a GreenFeed™ system (source: INRA)	111
Figure M19.2. Main components of the GreenFeed™ system (from C-Lock Inc.)	112
Figure M20.1. Measurement system at IRSTEA, Rennes	116
Figure M21.1. Inputs and outputs for a livestock building (source: Elise Lorinquer, Idele).....	119
Figure M21.1. Inputs and outputs for a livestock building	123
Figure M22.2. Calculating emissions based on gas concentrations and system characteristics.....	124
Figure M23.1. Continuous measurement recirculating chamber (system patented by INERIS – Polkryska and Tauzière, 1999)	127
Figure M23.2. Chamber with sampling system for integrative measurement using traps (Tillman <i>et al.</i> , 2003)	128
Figure M24.1. A set of wind tunnels used for comparing the effect of different treatments in the field	132
Figure M24.2. Cross section of the duct	132
Figure M26.1. Integrated Horizontal Flux method	141
Figure M27.1. The perimeter profile method (Hu <i>et al.</i> , 2014)	145
Figure M28.1. Left: Measuring the gradients of NO, NO ₂ and O ₃ at three heights using a continuous sampling pump, a multiplexer and gas analyzers (Stella <i>et al.</i> , 2012). Right: Photograph of an NH ₃ gradient measurement system using a multi-channel continuous flow system using wet effluent diffusion denuders (ROSAA) (Loubet <i>et al.</i> , 2012).....	151
Figure M29.1. COTAG system (Famulari <i>et al.</i> , 2010)	156
Figure M29.2. - COTAG system developed as part of the NitroEurope program (2008-2010)	156
Figure M30.1. Typical configuration for estimating the emissions S1 from an isolated plot	159
Figure M31.1. Eddy covariance system for measuring CO ₂ fluxes (INRA)	166
Figure M32.1. Illustration of the DEC method taking samples 3 times a second in comparison with a method taking samples at 20Hz (Pers.comm. Benjamin Loubet).....	170
Figure VI. Measurement error	193
Figure VII. Uncertainty evaluation process	195
Figure VIII. Comparison between GUM and GUM S1	199
Figure IX. Application of an Ishikawa diagram for measuring gas concentrations in ambient air in a livestock building	201
Figure X. 5M diagram (Ishikawa) for the measurement of the effectiveness in reducing NH ₃ emissions	203

Tables

Letter M refers to “Method” application notes (MX.i.: Figure N°i in Method application note N°X).

Table I. Emissions in EU-28 in 2013 of the main gases related to livestock farming according to EEA (2015a, 2015b).....	14
Table II. Main physical and chemical characteristics of ammonia	17
Table III. Effect of some ammonia emission determinants.....	17
Table IV. Main physical and chemical characteristics of nitrogen oxides	20
Table V. Impact of certain biological nitrogen oxide emission determinants.....	21
Table VI. Main physical and chemical characteristics of methane	22
Table VII. Impact of various determinants on methane emissions	23
Table VIII. Main physical and chemical characteristics of carbon dioxide	24
Table IX. Concentrations in ambient air recommended by the World Health Organization and exposure limits in European and French regulations for NO ₂ and fine particulates	28
Table X. Emission ceilings for atmospheric pollutants NO _x , NH ₃ , VOC _{NM} , PM _{2.5} and CH ₄ for EU 28 and France.....	29
Table XI. Greenhouse gas emission targets.....	30
Table XII. Thresholds above which French farms must declare emissions under the Order of 31 August 2008 on the declaration of pollutant emissions and waste	31
Table XIII. Methods for sampling, measuring concentrations, airflows and emissions described in this study	37
Table M8.1. Main gas chromatographic detectors used to detect greenhouse gases and reactive nitrogen species (Lagadec <i>et al.</i> 2014).....	66
Table M8.2. Analysis results using a reference gas and a sample of ambient air	67
Table M16.1. Production of CO ₂ for 1000 W heat produced by various categories of animal (Pedersen <i>et al.</i> , 2008)	99
Table XIV. Summary of advantages and limitations of sampling methods.....	174
Table XV. Summary of the advantages and limitations of concentration analysis methods	176
Table XVI. Summary or advantages and limitations of methods for measuring airflows in livestock buildings or covered manure storage	180
Table XVI. Summary of advantages and limitations of emission measurement methods (livestock buildings, manure storage, fields, pasture).....	182
Table XVIII. Examples of content for the various parts of the Ishikawa diagram	196
Table XIX. Uncertainty calculation for SENTOREF	204

Coordinators

Mélynda Hassouna – INRA

Thomas Eglin – ADEME

Contributors

- Pierre Cellier – INRA
- Vincent Colomb – ADEME
- Jean-Pierre Cohan – ARVALIS-Institut du végétal
- Céline Decuq – INRA
- Monique Delabuis – INRA
- Nadège Edouard – INRA
- Thomas Eglin – ADEME
- Sandrine Espagnol – IFIP
- Maguy Eugene – INRA
- Yannick Fauvel – INRA
- Emilie Fernandes – LNE
- Nicolas Fischer – LNE
- Christophe Flécharde – INRA
- Sophie Générmont – INRA
- Stéphane Godbout – IRDA
- Nadine Guingand – IFIP
- Jessie Guyader – INRA
- Mélynda Hassouna – INRA
- Solène Lagadec – CRAB
- Patricia Laville – INRA
- Elise Lorinquer – IDELE
- Benjamin Loubet – INRA
- Laurence Loyon – IRSTEA
- Cécile Martin – INRA
- Bertrand Méda – INRA
- Thierry Morvan – INRA
- Dominique Oster – LNE
- Didier Oudart – INRA
- Erwan Personne – AgroParisTech
- Julien Planchais – INRA
- Paul Ponchant – ITAVI

- Gilles Renand – INRA
- Paul Robin – INRA
- Yvonne Rochette – INRA

Reviewers

- Emmanuel Fiani – ADEME
- Jean-Louis Fiorelli – INRA
- Fabrice Guiziou – IRSTEA
- Paul Landrain – CRAB
- Bernard Longdoz – INRA
- Olivier Marloie – INRA
- Edith Martin – CITEPA
- Etienne Mathias – CITEPA
- Michaël Mathot – CRA-W
- Baudouin Nicks – Liège University, Belgium
- Jean-Marie Paillat – CIRAD
- François-Xavier Philippe – Liège University, Belgique
- Olivier Ravel – Ecotron CNRS
- Philippe Rochette – Laval University , Quebec
- Amélie Vanlierde – CRA-W

Foreword

Air pollutant and greenhouse gas emissions have recently become a major environmental concern for livestock farmers. National emission inventories have identified livestock production as being a major contributor to these emissions, in particular ammonia, methane and nitrous oxide (dinitrogen monoxide). In France, the emission levels of reactive nitrogen species into the atmosphere are similar to the discharges into water. Changes in farming practices (feed, types of livestock buildings, emission treatment processes, manure management practices, etc) must take account of these emissions as part of efforts to mitigate climate change and improve air quality.

Currently, emission measurement is not very common, limiting the number of benchmarks for French livestock production that can be used to guide farmers in the development of their production systems. To learn more about the challenges of improving air quality and raising awareness in the field, the members of the Réseau Mixte Technologique, Elevage et Environnement (RMT - Joint Technology Network, Livestock production and Environment)¹ together with the Agence de l'environnement et de la maîtrise de l'énergie (ADEME - French Environment and Energy Management Agency) have organized projects to harmonize the methods used to measure emissions and develop benchmarks based on experimental sites. This review, drawn up by the ADEME and the RMT, presents the main methods used in France to quantify the emissions of greenhouse gases, ammonia and nitrogen oxides from livestock farming. Most of these methods are recognized and used internationally. The main aim is to provide a guide for potential users by setting out the information that will enable them to select the measurement method or methods most suited to their requirements and the resources available.

The study is divided into two main sections:

Part 1 summarizes the environmental, health, technical and statutory issues concerning emissions from livestock farming. It also describes the emission processes of the gases concerned.

Part 2 presents the various methods that have been developed and implemented by members of the RMT network to measure emissions of greenhouse gases, ammonia and nitrogen oxides. The methods cover all measurement stages, from taking air samples to analyzing pollutant levels, for livestock buildings, manure storage and fields. For each method, an application note describes the principles and implementation of the method, the sources of uncertainty and the main advantages and limitations. These advantages and limitations are then summarized in a table which is followed by a guide to selecting a method depending on whether it is to be used for can be used for research, improving production processes or meeting regulatory requirements. This part ends with a discussion of the uncertainties related to the measurement of emissions and gives an example of evaluating uncertainties for a particular case.

¹ The RMT for livestock production and environment was approved by the Ministry for Agriculture in December 2007. It organizes projects to reduce emissions from animal husbandry within the theme "Reducing emissions from livestock farms". Its partners are research and agricultural development organizations. Its projects range from applied research to the transfer of methods and benchmarks to the field.

Finally, the study looks at the outlook for research in the field and gives a glossary defining certain terms and acronyms used.

The review may be used as an introduction to most of the measurement approaches to quantify emissions of greenhouse gases, ammonia and nitrogen oxides from livestock and arable farming at field / building scale. Readers who would like to implement these methods may obtain detailed protocols and assistance from the appropriate organizations (cited in the application notes) or from the INRA website https://inra.fr/animal_emissions. Some of the methods described can also be used for other gases, in particular volatile organic compounds (VOCs).

1 Challenges of measuring the emissions from livestock farms

1.1 General

1.1.1 Emissions increased by the intensification of livestock farming

Livestock farming involves feeding, breeding and preventing illness and injury. Livestock is raised mainly for food (meat, milk, eggs) but also for other purposes (clothing, cosmetics, leisure). Animal production has increased significantly world-wide over the past decades, mainly for food. In many regions, this increase has led to animal production being centered close to areas of consumption or in areas where fodder is produced. To an increasing extent, production is geared to consumer requirements whereas, in the past, consumption was geared to production cycles that depended on the climate. This increasing demand for animal products has led to a new organization, with fodder being transported from the regions where it is produced to livestock farms. The relocation of nutrient flows and production systems results in an imbalance between the need to recycle livestock production co-products, in particular manure, and the capacity of the immediate environment to absorb the nutrients (eg: nitrogen, phosphorus) from these co-products. Increased animal production and recent changes in practices have considerably increased biochemical fluxes, in particular emissions into the atmosphere. It is currently estimated that nearly half of the mass of food and drinking water consumed is converted to gases during animal production and manure management (Robin et al., 2010).

1.1.2 Effect on the environment and health

Most of these emissions are non-pollutant (water vapor and carbon dioxide from respiration and manure decomposition). The remaining emissions are gases known to have adverse effects on the environment and on health (ADEME, 2013, 2014):

- Direct effects on health and the quality of the environment. Ammonia (NH₃), mono nitrogen oxides (NO_x) and Volatile Organic Compounds (VOCs) are involved in the formation of fine particulates and cause eutrophication. If emissions from grazing and the application of fertilizers to crops are included, European Environment Agency estimates that agriculture is the source of more than 93.3% of NH₃ emissions in EU-28.
- Contribution towards an increase in global warming by the emission of methane (CH₄) and nitrous oxide (N₂O). In 2013, CH₄ and N₂O contributed with 0.2 % and 5.3 % on total EU-28 GHG emissions. They make 53.3% and 44.7% of total agricultural emissions (EEA, 2015 a). N₂O is also produced as a result of atmospheric deposition of emitted NH₃ and NO_x and nitrate (NO₃⁻) leaching.
- Unpleasant odors affecting the area round farms. These are caused by NH₃, VOCs and sulfur compound emissions (Ni et al., 2012).

Table I. Emissions in EU-28 in 2013 of the main gases related to livestock farming according to EEA (2015a, 2015b)

Gas	Main challenges	Emissions in EU-28 in 2013	Emissions from livestock farming in 2013 ⁽¹⁾ (% of emissions in EU-28)
NH ₃	Quality of air, eutrophication and acidification of the environment, management of nitrogen, odors and livestock building conditions	3848 Gg ⁽²⁾	2385 Gg (62%)
N ₂ O	Climate change, nitrogen management, ozone layer depletion	258000 Gg CO ₂ equivalent	22025 Gg CO ₂ equivalent (manure management)
NO _x	Quality of air, nitrogen management	8176 Gg	490 Gg
CH ₄	Climate change and quality of air	468000 Gg CO ₂ equivalent	45458 Gg CO ₂ equivalent (manure management)
VOCnm	Quality of air, odors and livestock building conditions	7005 Gg	ND

ND: not determined

VOCnm: Non-methane volatile organic compounds

¹ The emissions from animal fodder production, in particular mineral fertilizers, are not included in these inventories.

² 93.3% of ammonia emissions come from agriculture.

1.1.3 Nutrient losses and potential savings in inputs

Nitrogen lost in the form of ammonia (NH₃) and nitrogen oxides (NO_x and N₂O) accounts for between 20% and 70% of the nitrogen excreted by animals (Figure I; Gac *et al.*, 2006; ITAVI, 2013; Peyraud *et al.*, 2012). According to Peyraud *et al.*, (2012), more nitrogen is lost in France from livestock farming in the form of emissions to the atmosphere (mainly in the form of NH₃) than in the form of nitrates. Some of these losses could be avoided and limiting the losses would improve the value of manure from livestock farms as fertilizers as well as the efficiency of nitrogen inputs in the production process.

Although new farming techniques have effectively increased livestock yields in recent decades, these have not taken emissions into consideration. Consequently, it is only relatively recently that attempts have been made to characterize emissions and the techniques for controlling these emissions.

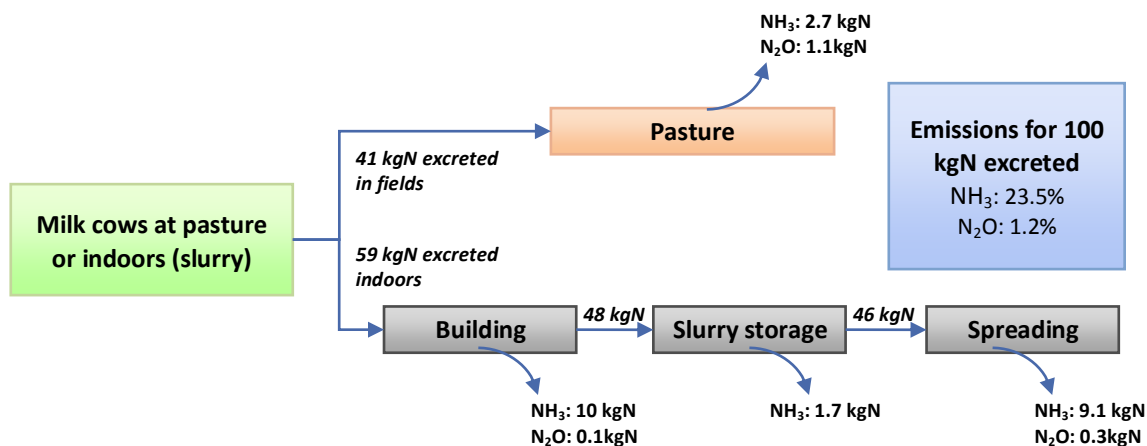

Figure I. Nitrogen lost¹ in the form of NH₃ and N₂O from pasture, livestock building and slurry handling on a typical dairy farm in France (Gac et al., 2006)

¹The losses vary depending on the type of farm, the practices and soil and climatic conditions

1.2 Characteristics, formation processes, health and environmental effects of the target gases

The target gases² are the result of various complex processes. Emissions occur throughout the whole process of managing manure from livestock: in pastures and in buildings, during storage and when spreading manure. They are the result of physical, chemical and biological processes which vary in time and space depending on the ambient conditions (eg: temperature, wind), the surroundings (eg: soil, type of building) and livestock characteristics (eg: physiological stage) and farming practices.

The various emission processes, the physical and chemical characteristics and impacts of each of the main target gases are described below:

- Reactive nitrogen gases: ammonia (NH₃) and nitrogen oxides (NO_x, N₂O)
- Methane (CH₄)
- Carbon dioxide (CO₂): CO₂ emitted from farms from the respiration of the animals and the decomposition of organic matter (excluding consumption of fossil fuels for heating and agricultural machinery) is generally part of a short cycle. An equivalent quantity of CO₂ is considered to be absorbed the same year in agricultural soils, by returning manure to the soil and growing crops. This study will not describe methods for measuring changes in carbon (C) stocks in a field. It will consider the measurement of CO₂ emissions only as part of the measurement of emissions of other gases.

1.2.1 Reactive nitrogen gases (NH₃, NO_x, N₂O)

Managing nitrogen is an essential part of farming activities. The nitrogen transfers that take place during animal production (from feeding to incorporating manure into the soil) are associated with nitrogen gas emissions in various forms. The main forms of nitrogen emissions are ammonia (NH₃), nitrogen oxides (N₂O, NO_x) and nitrogen (N₂, non-polluting). The emissions result from many complex interrelated processes as shown in the nitrogen

² The methods for measuring VOCs and odors are not within the scope of this study. However, some of the methods presented can also be used for VOCs.

cycle diagram in Figure II. Conditions that give low ammonia emissions may produce high nitrous oxide (N_2O) emissions. Ideally, all the processes and forms of emission should be considered as a whole to include any possible pollutant fluxes.

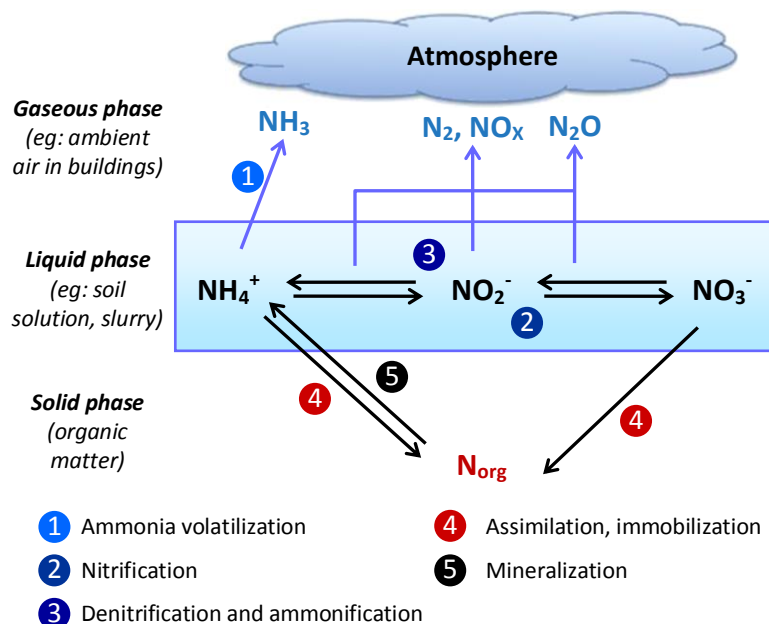

Figure II. Simplified diagram of the processes leading to the formation of reactive nitrogen gases (ADEME 2012)

For animal production, nitrogen is found mainly in the feed, the animals, the manure, the mineral fertilizers and in the soils, either in solution as mineral ions (NH_4^+ , NO_3^- and NO_2^-) or as organic compounds (N_{org}). The emission processes are associated with the activity of micro-organisms (eg: nitrification and denitrification producing N_2O) and physical and chemical equilibria (eg: ammonia volatilization). They are controlled mainly by environmental conditions (eg: temperature, oxygen availability, pH of the environment) and the initial form of the nitrogen (eg: organic or mineral, ammonium or nitrate).

Ammonia (NH_3)

In EU-28, agriculture is the main source of ammonia emissions, producing an estimated of 3578 Gg in 2013, 93% of the total emissions (EEA, 2015 b), of which two thirds is directly attributable to livestock production. Ammonia emissions come from buildings, from storing and processing the manure (manure heap, slurry pit, composting system, heaps of manure in the field), and from spreading organic and mineral nitrogen fertilizers.

Main characteristics

Ammonia is a colorless gas with a pungent smell. It is highly soluble in water and, in moist air, can corrode copper, zinc and many alloys. It is very reactive in air and oxidizes to form water, N_2 and nitrous oxides. It is also an important precursor of secondary respirable and fine particulates (particulates less than 10 μm , PM_{10} and less than 2.5 μm $PM_{2.5}$) (ADEME and MEDDTL, 2012).

Table II. Main physical and chemical characteristics of ammonia

	Ammonia
Chemical formula	NH₃
Molar mass (g.mol⁻¹)	17.03
Melting point (°C)	-77.7
Boiling point (°C)	-33.3
Solubility in water at 20°C (g.l⁻¹)	540
Vapor density (air=1)	0.59
Odor detection threshold (mg.m⁻³)	3.5 to 35

Formation processes and emission determinants

Ammonia is given off by the volatilization of the ammonia ion NH₄⁺ found in the initial matrix (eg: soil solution, slurry) or produced by the mineralization of organic nitrogen (Figure II). Volatilization is a surface process, requiring contact between the solution and the air.

The main determinants for volatilization are:

- The amount of ammonia available.
- The pH of the solution emitting the ammonia. For the conjugate acid-base pair NH₃/NH₄⁺ in equilibrium, NH₃ will be emitted if the pH increases.
- The area and the relative airspeed at the interface with the solution. NH₃ emissions increase with increasing airspeed across the volatilization surface and increasing concentration gradient at the interface between the solution and the air.
- The bonds between the NH₃ and the substrate. Emissions decrease as the Cationic Exchange Capacity (CEC) increases.
- The temperature. The convection and diffusion mechanisms increase with increasing temperature and the equilibrium between NH₃ liquid / NH₃ gaseous shifts towards the gaseous phase.
- The carbon availability which encourages the immobilization of nitrogen by micro-organisms. Manure with a high C:N ratio (eg: well managed manure rather than slurry) will tend to emit less NH₃.

Table III shows the effect of some ammonia emission determinants.

Table III. Effect of some ammonia emission determinants

Determinant	↑ Emissions	↓ Emissions
Amount of NH₄⁺ (eg: type of fertilizer)	Urea (on average, 24% of N amendment is volatilized as NH₃) (EMEP/EEA, 2013)	Calcium ammonium nitrate (on average, 3% of N amendment is volatilized as NH₃) (EMEP/EEA, 2013)
pH (eg: soil type)	Alkaline soils	Acid soils
Temperature	Summer	Winter
Airflow	Open slurry pit	Covered slurry pit
Exchange surface	Surface application of N amendment	N amendment incorporated in the soil

Effects on health

On farms and in their direct surroundings

At farm scale, the challenges are mainly related to long-term exposure. Epidemiological studies have shown that poor air quality on certain farms may have harmful effects on the health of the farmer workers (Donham et al, 2002). As ammonia is very soluble in water, it is absorbed into the nasal and ocular mucous membranes and can cause irritation and burns. However, it is difficult to separate the effects of the various pollutants (gases, dusts, particulates, bacteria, etc.) (Portejoie, 2002). The Institut National de Recherche et Sécurité (INRS - French Research and Safety Institute) recommends an exposure limit³ over 8h in the workplace of 7 mg.m⁻³ (10 ppm) and a short-term exposure limit (15 minutes) of 14 mg.m⁻³ (20 ppm). The pungent smell may also be a major nuisance for the farmer workers and those living in the surrounding area. The odor detection threshold varies considerably between individuals (from 4 to 70 mg.m⁻³). In livestock buildings, the normal NH₃ concentration is between 3 and 20 mg.m⁻³, with higher levels in enclosed pig and poultry buildings (CORPEN, 2006; ITAVI, 2013; Portejoie, 2002). However, increasing the ventilation in the buildings will increase the emissions to the outside.

Ammonia may also affect the health and performance of the livestock. For pigs kept in conditions with a high NH₃ (> 35 mg.m⁻³) concentration, disruption of the reproductive cycle for sows, increased susceptibility to infectious agents and a reduction in weight gain have been reported (Portejoie, 2002).

Regional and transboundary scale

The main health concern for ammonia is its indirect effect as a fine particulate matter precursor. Respirable particulates (<10 µm, PM₁₀) and fine particulates (<2.5µm, PM_{2.5}) are the most hazardous, as they penetrate furthest into the organism, through the respiratory tracts and then into the blood. They are considered to increase the occurrence of many diseases such as asthma, allergies, respiratory and cardiovascular diseases, cancers, etc. The World Health Organization (WHO) estimates that 42,000 people in France will die prematurely each year owing to effects linked to PM_{2.5} (ADEME and MEDDTL, 2012). Ammonium nitrate (NH₄NO₃) has often been shown to make a major contribution to peaks in PM_{2.5} levels in early spring, during spreading of manure and fertilizers (Hamaoui-Laguel et al., 2014).

Effects on the environment

Deposition of volatilized ammonia, mainly as particulate matter, contributes to the acidification and eutrophication of the environment. Ammonia deposited into aquatic environments increases the amount of nitrogen and can lead to excessive nutrients and a reduction in the quantity of available oxygen. In forests, excess nitrogen limits the mycorrhization of trees (symbiosis between the roots and fungi), contributes to the acidification of soils that are already poor and can weaken the trees in the long term (Portejoie, 2002). Most of the ammonia emitted is deposited within a few kilometers of the source, the rest being absorbed into the atmosphere and transported over considerable distances (several hundreds of km, Figure III).

³ In this paragraph, the threshold values are given at 25°C and 1 atmosphere (SATP).

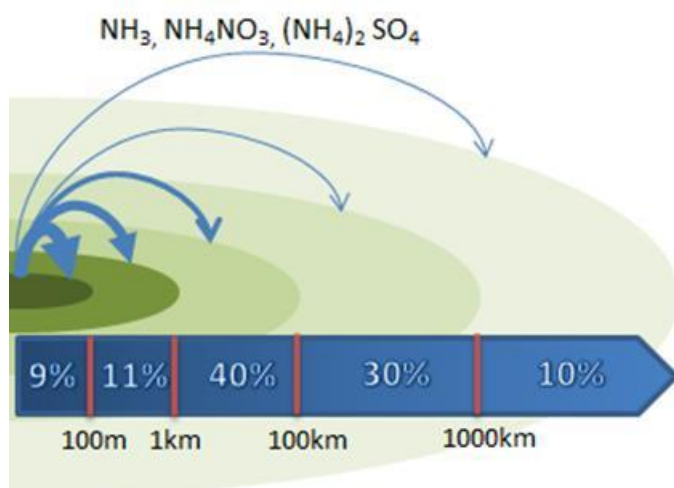

Ammonia is deposited from the air by dry deposition (NH_3), or as aerosols or droplets (dry or wet deposition). These droplets can be transported over long distances, in particular across borders.

Figure III. Deposition of nitrogen as ammonia depending on the distance from the source (Lallemand and Weber, 1996 and ADEME, 2012)

Nitrogen oxides (N_2O , NO_x)

Nitrogen oxides are taken to be all compounds containing nitrogen and oxygen only: NO , N_2O , N_2O_3 , NO_2 , N_2O_4 , N_2O_5 . The main nitrogen oxides emitted from agricultural activities are nitrous oxide (N_2O), nitrogen monoxide (NO) and nitrogen dioxide (NO_2). A distinction is usually drawn between NO_x (NO , NO_2) which are very reactive with air and major contributors to the degradation in the quality of the air, and nitrous oxide N_2O , which is not very reactive in air but is one of the three main greenhouse gases emitted by human activities. Since the reduction in chlorofluorocarbon emissions (CFC, HCFC) under the Montreal protocol, N_2O has become the main source of depletion of the ozone layer in the lower part of the stratosphere (PNUE, 2013).

Although the contribution of livestock farming to French NO_x emissions is low⁴ (<5%) in comparison with that of the industrial sectors and transport, manure management accounts for nearly 6% of French N_2O emissions (Citepa, 2015). If emissions associated with crops grown for animal feed are taken into account, this amounts to more than 70% of French emissions (Peyraud *et al.*, 2012).

Characteristics

Nitrogen monoxide (NO , nitric oxide) is a colorless gas at ambient temperature and pressure, non-flammable in air and not very soluble in water (< 80 mL.L^{-1} at 20°C). It behaves as an oxidizing agent at high temperatures and a reducing agent at low temperatures. It has a noticeable pungent odor above a threshold of 0.36 mg.m^{-3} . It is unstable and combines with oxygen to form nitrogen dioxide (NO_2).

Nitrogen dioxide (NO_2) is highly volatile at ambient temperature and pressure, non-flammable in air and soluble in water. It is a powerful oxidizing agent which can react with many reducing agents and combustible materials.

Nitrous oxide (N_2O , dinitrogen oxide, dinitrogen monoxide) is colorless and odorless with a slightly sweet taste. It is also known as “laughing gas” although the concentrations found in agriculture do not produce this effect. It is very stable in air. However, it can react with alkali

⁴ Not taken into account in the French life cycle category rules.

metals and with many organic compounds and can provide oxygen for combustion. It is used in many fields (automobile, medicine, aerosols, etc).

Table IV. Main physical and chemical characteristics of nitrogen oxides

	Nitrogen monoxide	Nitrogen dioxide	Nitrous oxide
Chemical formula	NO	NO₂	N₂O
Molar mass (g.mol⁻¹)	30.01	46.01	44.01
Melting point (°C)	-163.6	-9.3	-90.8
Boiling point (°C)	-151.8	21.15	-88.5
Solubility in water at 20°C (g.l⁻¹)	0.057	reacts with water to form HNO₂ HNO₃	1.33
Vapor density (air=1)	1.036	1.587	1.53
Odor detection threshold (mg.m⁻³)	0.38	0.38	

Formation processes and emission determinants

Nitrogen oxide emissions from agriculture come mainly from:

- The oxidation of the nitrogen in the air or oxidation of organic nitrogen in organic waste or fuels. Specific methods for measuring these emissions are not considered in this study.
- Biological nitrification and denitrification processes (Figure II).

NO_x and N₂O are generally formed by redox reactions in micro-organisms (Hénault *et al.* 2005). The main production pathways are by nitrification of ammonium (NH₄⁺) into nitrate (NO₃⁻) in aerobic conditions and denitrification in partially anaerobic conditions. Most of these emissions are associated with nitrifying and denitrifying microbial communities in the substrate (soil, manure). Biological nitrification is accepted as the main NO_x production process, producing significant atmospheric emissions (Garrido *et al.*, 2002).

There are many factors that influence these reactions but these have not been clearly identified and their interactions are complex. They include:

- Microbial communities (eg: denitrifiers, nitrifiers) found in the substrate (Hénault *et al.*, 2005).
- The quantity and availability of the mineral forms of nitrogen (ammonium, nitrite and nitrate), the raw material for nitrification.
- The water and oxygen content and the redox potential of the environment. In general, high N₂O emissions are associated with reducing environments, which favor denitrification, whereas NO_x emissions are associated with oxidizing environments, which favor nitrification (CORPEN, 2006). Denitrifiers are inactive in totally anaerobic conditions.
- The availability of labile carbon compounds which can be easily assimilated by micro-organisms. The consumption of oxygen for the decomposition of organic matter can create conditions favorable to denitrification.
- pH. N₂O emissions from acid soils are generally higher than emissions from neutral or alkaline soils. The processes are not yet well understood. Hénault *et al.* (2005)

suggest that there may be an increase in nitrification and/or less reduction of N₂O to N₂ during denitrification.

- Temperature. At normal temperatures, the activity of micro-organisms and the mineralization of organic nitrogen increase as the temperature increases (Hénault *et al.*, 2005). When composting, the nitrification reaction is inhibited by temperatures over 40°C (the optimum temperature for nitrification is 35°C). In this case, the nitrogen remains in the form of ammonium and N₂O emissions are minimal (ADEME, 2012).

The following table shows the impact of certain NO_x and N₂O emission determinants:

Table V. Impact of certain biological nitrogen oxide emission determinants

Determinant	↑Emissions		↓ Emissions	
	NO _x	N ₂ O	NO _x	N ₂ O
Airflow	Solid aerated manure		Slurry	
pH	Acid soils		Alkaline soils	
Water content	Fertilized, well drained soil	Fertilized, waterlogged soil	Fertilized, waterlogged soil	Fertilized, well drained soil

Effects on the environment and health

NO_x emissions have a direct impact on health and the environment. At levels above 200 µg.m⁻³, NO₂ can cause various respiratory, neurological, hematological and renal disorders. The INRS sets the exposure limit for NO at 25 ppm or 30 mg.m⁻³ and for NO₂ at 3 ppm or 6 mg.m⁻³. NO₂ can also be absorbed by plants. Although it may then be used as a source of nitrogen, this input is generally low. However, absorbing NO₂ may have a harmful effect on the functioning of the plants by disrupting the acid-base homeostasis in the leaves and causing physiological changes.

NO_x emissions also contribute to the formation of other pollutant chemical species. As NO_x species are very reactive in the environment, they may interact with other compounds in the air (eg: VOCs, H₂O, NH₃) and produce respirable and fine particulates (PM₁₀ and PM_{2.5}) and acids (eg: HNO₃). Deposits of fine particulates and acid substances contribute towards the acidification and eutrophication of the environment. NO_x species also play a role in the reactions that form and destroy ozone (O₃) in the lower atmosphere (troposphere), causing respiratory disorders and loss of plant productivity.

N₂O is a powerful greenhouse gas whose global warming potential (GWP) over 100 years is ~300 times higher than that of CO₂. Its life-time in the atmosphere is around 150 years. It is the third most important greenhouse gas after carbon dioxide (CO₂) and methane (CH₄), and is covered by the Kyoto Protocol. In high concentrations, it may have a harmful effect on health. However, the concentrations found in livestock production conditions are not hazardous. For example, in pig buildings the average concentrations measured are around 0.5 – 0.6 mg.m⁻³ (Hamon *et al.*, 2012). In France, there is no exposure limit, except where it is used as an anesthetic.

1.2.2 Methane (CH₄)

Methane is a volatile organic compound emitted mainly by livestock farming which accounts for 2/3 of emissions in France (Citepa, 2015). It contributes to the formation of ozone in the lower atmosphere (troposphere) and to the depletion of the ozone layer in the stratosphere.

Characteristics

Methane is odorless and inflammable. It is lighter than air and accumulates at the top of livestock buildings. Its life time in the atmosphere is around 10 years.

Table VI. Main physical and chemical characteristics of methane

IUPAC name	Methane
Chemical formula	CH ₄
Molar mass (g.mol ⁻¹)	16.04
Melting point (°C)	-182.5
Boiling point (°C)	-161.6
Solubility in water at 20°C (g.l ⁻¹)	0.022
Vapor density (air=1)	0.55
Odor detection threshold (mg.m ⁻³)	-

Formation processes and determinants

On livestock farms, methane is produced by anaerobic fermentation of organic compounds by micro-organisms (methanogenic archaea). Emissions are produced:

- during digestion of food by animals, mainly ruminants (enteric fermentation). Ruminant methanogenesis is the process by which ruminants break down cellulose in the rumen.
- during the fermentation of manure, mainly in the livestock buildings and during storage.

The amount of methane emitted during enteric fermentation depends on many factors (Jouany and Vermorel, 2010).

- The amount of food ingested: a larger amount of food ingested increases emissions but it also accelerates transit and reduces the proportion of the gross energy in the feed lost as CH₄.
- The digestibility of the food: indigestible fibrous rations, with a high cellulose content, increase net CH₄ emissions.
- The physiological stage of the animals: animals at a more productive stage emit more CH₄ for a given ration.
- The type of ration: rations with high fatty acid content, in particular omega 3, reduce emissions. Other additives (eg: nitrate) also help to reduce emissions.

The main determinants for emissions from the decomposition of manure (livestock buildings, storage) are:

- Oxygenation. The microbial processes for the formation of CH₄ are anaerobic. Therefore, compacted manure heaps and high water content produce higher CH₄ emissions.
- Temperature. Micro-organism activity increases as the temperature increases.

There may be conflict between strategies to reduce N₂O and CH₄ emissions. Manure management systems for reducing CH₄ by providing partially aerobic conditions (eg: deep bedding) may increase N₂O emissions.

Table VII shows the impact of several determinants on methane emissions.

Table VII. Impact of various determinants on methane emissions

Determinant	↑ Emissions	↓ Emissions	Comments
Animal species	Ruminant	Monogastric	Typically, emissions from enteric fermentation by dairy cattle are close to 100 kg CH ₄ per dairy cow per year and are around 2 kg.an ⁻¹ for an adult pig (Paustian <i>et al.</i> , 2006).
Ration composition	High fiber ration	Ration with fatty acids	Eg: Adding linseed or nitrate to rations is a means of reducing emissions.
Manure management in the livestock building	Manure accumulated under the animals, compacted manure	Aerated manure	There may be conflicts between strategies to reduce N ₂ O and CH ₄ emissions.

Effects on health and the environment

Methane has no direct known effect on health at the concentrations measured in the air or in livestock buildings. However, it is the main greenhouse gas emitted by livestock farms, with a global warming potential (GWP) at 100 years that is 21 times higher than that of carbon dioxide (CO₂). Like NO_x species, methane plays a role in the reactions that create and destroy tropospheric ozone (O₃).

1.2.3 Carbon dioxide (CO₂)

This study covers carbon dioxide because it plays an important role in methods for measuring the other gases described above (eg: mass balance). CO₂ emissions associated with manure management and animal respiration are absorbed rapidly (short cycle) by the crops grown for animal feed. For this reason, the role of CO₂ in increasing the greenhouse effect is not considered. However, on livestock farms, there may be uncompensated emissions from the combustion of fossil fuels and loss of organic matter from agricultural soils. The measurement methods associated with these emissions are not covered in this review.

Characteristics

At ambient temperature and pressure, carbon dioxide is colorless, odorless and heavier than air (Table VIII). It is soluble in water where it reacts to form carbonic acid H₂CO₃.

Formation processes and determinants

Carbon dioxide (CO₂) is produced mainly by:

- animal respiration,
- aerobic digestion by micro-organisms of organic matter in the manure,
- combustion of carbon-based materials: fossil fuels and organic waste.

The main determinants producing emissions are the metabolic activity of animals, the amount of available C, oxygenation and temperature.

Table VIII. Main physical and chemical characteristics of carbon dioxide

	Carbon dioxide
Chemical formula	CO₂
Molar mass (g.mol⁻¹)	44.01
Melting point (°C)	-56.6
Boiling point (°C)	-78.5
Solubility in water at 20°C (g.l⁻¹)	540
Vapor density (air=1)	1.53
Odor detection threshold (mg.m⁻³)	-

1.3 Characterization of emissions from livestock production using emission factors

Currently, the emission factors available in international databases (EFDB⁵) and certain reference documents (CORPEN for France, IPCC reports) are determined on the basis of published emission measurements and have been agreed at national or international level. However, to obtain emissions inventories that are more specific and more representative of the reality in practice, the emission factors used must cover a wider range of livestock production conditions and have lower uncertainty so that livestock production systems can be classified into more clearly defined categories based on their actual emissions.

An analysis of international literature on livestock production emission measurements shows a significant variability in the relationships between emissions, types of production and sources. For example, Figure IV gives ammonia emissions from dairy cattle buildings taken from the literature and summarized by Charpiot *et al.* (2012). This shows the considerable difference in emission measurements within a manure management system category, which is a classification generally used to compare the emissions from different livestock production systems. For the category “slurry - cubicles with concrete floor alley”, the authors found that the emission level measurements varied by a factor of over 100, without being able to identify any reasons explaining such discrepancies. Furthermore, there are measurements that show comparable emission levels for different categories. This analysis clearly shows the importance of being able to ensure that the measurement conditions and systems considered are fully characterized. It also shows the importance of creating an emissions-based livestock production classification that will give a more accurate picture of the variability being measured.

To do this, the emission factors must be based on a sufficient number of measurements in the field (that will distinguish between several types of livestock production and practices) and these measurements must be obtained using reliable, rigorous methods. Furthermore, it is important to include sufficient information in publications more systematically to:

- create homogeneous datasets (there is currently insufficient information on the animal production practices)
- give a better assessment of the representativeness of the results obtained (there is currently a lack of information on the systems studied and livestock production conditions)
- compare the results more easily between publications (there is, in particular, a lack of information on the systems studied, the livestock production conditions, the experimental protocols and the levels of uncertainty associated with the measurements)

⁵ <http://www.ipcc-nggip.iges.or.jp/EFDB/main.php>, accessed on March 11, 2014

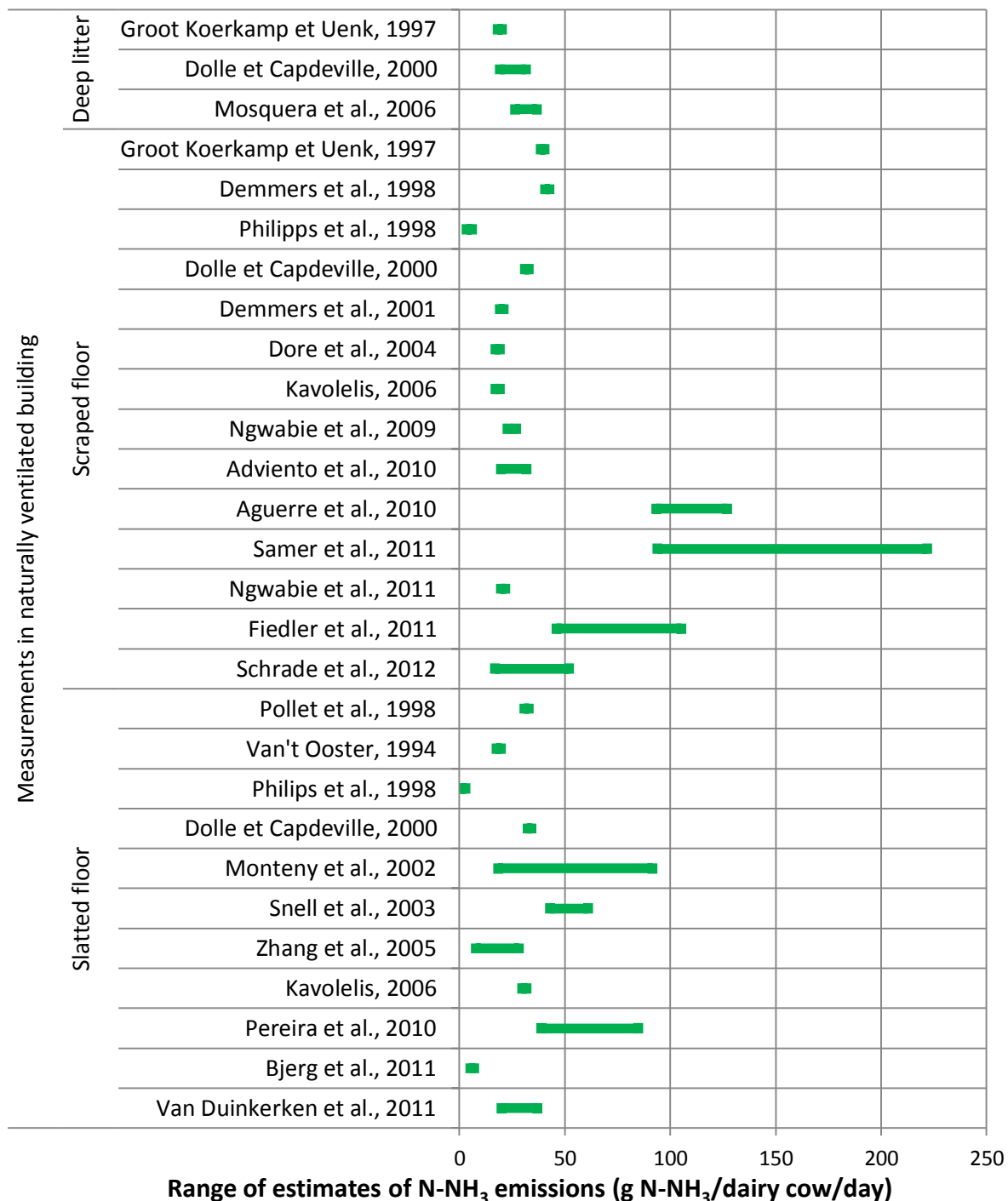

Figure IV. Variability of NH₃ emissions in a dairy cow building in the international literature (Charpiot *et al.*, 2012)

In certain cases, the measurement methods may be at the root of major differences between the emissions measured in two, almost identical livestock production systems (or systems belonging to the same category). For this reason, protocols for various types of measurement method and a methodology for estimating measurement uncertainties must both be made widely available.

1.4 Emission regulations

Europe, as well as other countries in various parts of the world, has adopted a policy of improving the quality of the air and reducing greenhouse gas emissions (GHG). Ammonia and NO_x are now covered by air quality improvement policies and N₂O and methane are covered by policies to reduce GHG emissions.

The legal framework for emission control covers three main approaches:

- regulations on outdoor air quality which define permissible exposure limits for human health
- national commitments to reduce emissions in Europe and internationally
- regulations aiming to reduce emissions at source for animal production activities

This framework is defined at various scales, ranging from international agreements or protocols, through EU legal instruments (regulations, directives, decisions), to national regulations (laws, decrees, orders, action plans).

For example, at regional scale in France, actions are implemented under Schémas Régionaux Climat, Air, Energie (SRCAE - Regional climate, air and energy plans), Plans de Protection de l'Atmosphère (PPA - air protection plans) and Plans Climat Energie Territorial (PCET - Regional Climate and Energy plans). The SRCAE define an integrated approach to air quality and energy under the guidance of the regional Prefets and Presidents of the Regional Councils. For example, the Brittany SRCAE (accessed on September 25, 2013) sets out to identify and promote practices with lower emissions (GHGs, NH₃) and includes indicators for monitoring agricultural emissions causing atmospheric pollution. PPAs must include measures to be taken to reduce emissions within a given coherent area (conurbation, zone exceeding emission limits, etc), (eg: ban on spreading manure when the levels of ammonia-derived secondary particulates are high).

1.4.1 Outdoor air quality and exposure limits

Air quality regulations are drawn up to protect people from toxic effects from prolonged exposure to certain gases. They usually give a maximum annual exposure (annual mean), and a maximum short term exposure limit (for example, mean over 10 min). The main document on which these standards are based is issued by the World Health Organization (WHO) which publishes and updates guidelines on air quality. Exposure thresholds are defined by the European Union in Directive 2008/50/EC on ambient air quality and cleaner air for Europe and, in France, by several decrees (Table IX). These regulations do not apply to greenhouse gases which are not considered to be toxic. The Environment Code (Book II, Article L. 220-2) includes excessive olfactory pollution as well as toxic air pollution. In 2014, France did not meet the thresholds defined by Directive 2008/50/CE⁶ for nitrogen oxides and PM₁₀ (number of days exceeding the daily limit).

⁶ See eur-lex.europa.eu

Table IX. Concentrations in ambient air recommended by the World Health Organization and exposure limits in European and French regulations for NO₂ and fine particulates

	NO ₂	PM ₁₀	PM _{2.5}
International	Limits recommended by the WHO (guidelines)		
	Am ¹ : 40 µg.m ⁻³ Hm ¹ : 200 µg.m ⁻³	Am: 20 µg.m ⁻³ Dm ¹ : 50 µg.m ⁻³	Am: 10 µg.m ⁻³ Dm: 25 µg.m ⁻³
European Union	Directive 2008/50/EC on ambient air quality and cleaner air for Europe		
	Am: 40 µg.m ⁻³ Hm: 200 µg.m ⁻³ , not to be exceeded more than 18 times in one year	Am: 40 µg.m ⁻³ Dm: 50 µg.m ⁻³ not to be exceeded more than 35 days in a year	Am: 25 µg.m ⁻³ in 2015 and 20 µg.m ⁻³ in 2020
France	Air quality decree of October 21, 2010		
	Same limits as for Europe		

¹Am: Mean over 1 calendar year, Dm: Mean over 1 day, Hm: Mean over one hour

The application of these targets in France was set out in the laws following the Grenelle de l'Environnement. A particulate reduction plan was published after the Grenelle de l'Environnement (2008). It targeted the agricultural sector explicitly by setting up research programs and encouraging practices with lower ammonia and particle emissions, for feed, manure management and spreading organic and mineral fertilizers. One of the main aims of the particulate reduction plan was to adopt a target of 15 µg.m⁻³ PM_{2.5} in the ambient air as from 2010, and to convert this target into an enforceable limit in 2015 with the long term aim of reducing concentrations to 10 µg.m⁻³ in accordance with WHO recommendations.

1.4.2 National emission reduction commitments

The first major international agreement was the Geneva Convention on Long-range Transboundary Air Pollution, signed in 1979. This convention was followed by various agreements, including the Gothenburg Protocol which defines national emission ceilings for various atmospheric pollutants such as ammonia, NO_x, non-methane VOCs and fine particulates PM_{2.5}. In the European Union, Directive 2001/81/EC on national emission ceilings for certain atmospheric pollutants (NEC Directive) defined new emission ceilings that were the same as, or stricter than, the Gothenburg Protocol. It required member states to define measures to comply with these ceilings. By 2010, France had met its targets for the various atmospheric pollutants, with the exception of NO_x emissions. The ceilings in the NEC Directive should be revised in the next few years to be significantly lower in 2030 than the levels of emissions in 2005.

Table X. Emission ceilings for atmospheric pollutants NO_x, NH₃, VOC_{NM}, PM_{2.5} and CH₄ for EU 28 and France

	NO _x	NH ₃	VOC _{NM}	PM 2.5	CH ₄
International	Gothenburg Protocol 2012, % reduction in 2020 compared to emissions in 2005 for France				
	-50%	-4%	-43%	-27%	n.d. ¹
European Union	NEC Directive 2001/81/EC, ceilings for 2010 (currently being revised for 2020) in kt per year – EU 27				
	9 003	4 294	8 848	n.d.	n.d.
	Revised NEC Directive proposal of the European Parliament and of the Council from December 16, 2015 : % reduction in 2020 and 2030 compared to emissions in 2005 – EU 28				
	-42% / -62%	-6% / -18%	-43% / -52%	-22% / -45%	n.d.
France	NEC Directive 2001/81/EC, ceilings for 2010 (currently being revised for 2020) in kt per year				
	810 ⁷	780	1,050	n.d.	n.d.
	Revised NEC Directive proposal of the European Parliament and of the Council from December 16, 2015 : % reduction in 2020 and 2030 compared to emissions in 2005				
	-50% / -69%	-4% / -13%	-28% / -39%	-27% / -56%	n.d.

1 n.d.: not defined

The international Kyoto Protocol, which was signed in 1997 and came into force in 2005, is the main international agreement defining GHG emission limits for 38 countries (Annex B), including France. The overall target was to reduce emissions for the period 2008-2012 to 5% below 1990 levels, with separate targets for individual countries. France has reached its target of stabilizing these emissions. The Protocol entered its second phase in 2013 (2013-2020), which should lead to a reduction of emissions to 18% below 1990 levels. The targets for each country are under negotiation and should be adopted in 2015. In Europe, the reduction targets are defined in the climate action and renewable energy package.

⁷ The only ceiling in the NEC directive breached in France.

There is currently no requirement to reduce emissions specifically in the agricultural sector, at international, European or national scale. Agriculture does not come within the scope of the EU Emissions Trading System (EU ETS). However, it is concerned by the Effort Sharing Decision (ESD) for sectors outside the ETS, such as transport, building and agriculture, which sets a global target of a 10% reduction by 2020 compared with 2005 levels. Furthermore, projects to reduce emissions in the agriculture sector can qualify for Kyoto credits that can be exchanged on the carbon markets, in particular voluntary markets. However, this requires the implementation of an accepted methodology, including in particular reliable accounting methods (emission factors) and measures to check the reductions achieved. By 2014, very few agricultural projects had been proposed. These projects mainly concerned the production of biomass, anaerobic digestion of agricultural waste, improvement of energy efficiency and discontinuation of tillage.

Table XI. Greenhouse gas emission targets.

	GHG: fossil CO₂, N₂O, CH₄, HFC, PFC, SF₆
International	Kyoto Protocol, 2005 and Doha amendment, 2012. Emissions reduction “2008-2012” and “2013-2020” compared with 1990 levels
	-8 and -20% for EU
European Union	Climate action and renewable energy package
	-20% in 2020 compared with 1990 emission levels
France	Grenelle Laws 1 and 2 and « Loi relative à la transition énergétique pour la croissance verte »
	-40% in 2030 compared with 1990 emission levels -75% in 2050 compared with 1990 emission levels

1.4.3 Reducing emissions at source

Regulations to reduce emissions at source mainly concern NH₃ emissions, particulates and odors from high emission livestock farming systems, in particular under European Directive 2010/75/EU on Industrial Emissions (IED Directive) which replaced the IPPC Directive in 2010. The IED Directive requires poultry farmers (> 40,000 birds) and pig farmers (> 2000 pigs over 30 kg or > 750 sows) to declare their emissions and to apply the Best Available Techniques (BAT) as defined by the European Commission in the IRPP BREF (Intensive Rearing of Poultry and Pigs BAT reference document). This document is being revised and the version currently proposed by the European Commission defines emission limits associated with the BATs as well as measurement methods to check the reductions achieved on farms (§ 2.4.5).

In France, all the farms subject to the IED Directive and whose emissions exceed the limits given in Table XII must declare their emissions to the French authorities⁸ (order of 31 August 2008 on the pollutant emissions and annual reporting requirements of pollutant emissions and waste). In practice, on farms, only ammonia emissions are regularly below the thresholds.

Table XII. Thresholds above which French farms must declare emissions under the Order of 31 August 2008 on the declaration of pollutant emissions and waste

Atmospheric pollutants	Threshold for declaration (t/year)
Ammonia (NH₃)	10
Methane (CH₄)	100
Nitrous oxide (N₂O)	10
Particulates < 10 microns (PM₁₀)	50
Volatile organic compounds ex CH₄ (VOCnm)	30
Nitrogen oxides (NO_x)	100

Emissions and odors from smaller farms are covered by the Règlement Sanitaire Départemental (RSD - Departmental Health Regulation) and Installations Classées Pour la Protection de l'Environnement (ICPE - Potentially Polluting Sites) regulations. The requirements (eg: rapid incorporation of manure in fields) depend on the size of the farms and their status (RSD or ICPE subject to declaration, registration or authorization).

The main mechanism for reducing GHG emissions at source is currently the EU Emissions Trading System (EU ETS), which was set up to comply with the commitments under the Kyoto Protocol. Under this system, many greenhouse gases (N₂O, VOCs, etc.) emitted from industrial activities are subject to emission limit values (ELVs). However, as the limits are much higher than typical emissions from farms, livestock production does not come into the EU ETS.

It should be noted that other regulations that do not target the reduction of atmospheric emissions will, nevertheless, have a major effect. This applies to regulations to improve and preserve water quality. For example, under Directive 91/676/EEC concerning the protection of water against pollution caused by nitrates from agricultural sources (Nitrates Directive), farms in vulnerable zones are subject to balanced fertilization and limitations on spreading manure in fields. This aims to limit nitrogen leaching into aquatic environments which will help to reduce nitrogen emissions into the air in the form of nitrogen oxides or ammonia.

1.5 Conclusions

This section defines the main gases emitted by farms and highlights the major environmental and health challenges. These are covered by policy objectives and regulations. They also coincide with trends in animal production and agronomy, in particular minimizing nitrogen inputs. More information on emissions is required to continue to develop technologies for controlling agricultural emissions at source effectively that are also appropriate for farming

⁸ Declaration to be made using a dedicated website
<https://www.declarationpollution.ecologie.gouv.fr/gerep/>

operations. The following section presents the main measurement methods that can be used on farms and describes the advantages and limitations on their use.

1.6 Bibliography

- Ademe. 2012. Programme de recherche de l'Ademe sur les émissions atmosphériques de compostage. Connaissances acquises et synthèse bibliographique [ADEME research program on atmospheric emissions from composting. Current state of knowledge and literature review]. Ademe. 243 p. Available from www.ademe.fr
- Ademe. 2013. Des informations pour agir. Techniques de traitement. [What you need to know. Treatment techniques.] Available from www.ademe.fr
- Ademe. 2014. BULDAIR Connaître pour agir. [BULDAIR: What you need to know] Available from www.ademe.fr.
- Ademe et MEDDTL. 2012. Les émissions agricoles de particules dans l'air. Etats des lieux et leviers d'action. [Agricultural particulate emissions. Current status and approaches] Editions Ademe, 36 p.
- Charpiot A., Dollé J.B., Edouard N., Faverdin P., Hassouna M. 2012 "Acquisition de references complementaires en vue d'appliquer une methode simplifiee de mesure des emissions d'ammoniac en batiments d'elevage bovin", [Setting up additional benchmarks to apply a simplified method for measuring ammonia emissions in cattle buildings]
- Citepa. 2015. Inventaire des émissions de polluants atmosphériques et de gaz à effet de serre en France: séries sectorielles et analyses étendues. [Life cycle inventories for atmospheric pollutant and greenhouse gas emissions in France: sectorial series and extended analyses] *Document received directly from CITEPA.*
- Corpen. 2006. Estimation des rejets d'azote - phosphore - potassium - calcium - cuivre - et zinc par les élevages avicoles. [Estimated emissions of nitrogen, phosphorus, potassium, calcium, copper and zinc from poultry farms] 55 p.
- Donham, K.J, Cumro, D., Reynolds, S. "Synergistic effects of dust and ammonia on the occupational health effects of poultry production workers". *J Agromedicine*. 2002 ; 8(2): 57-76.
- EEA. 2015 a. European Environment Agency. Annual European Union greenhouse gas inventory 1990–2013 and inventory report 2015. Submission to the UNFCCC Secretariat: 598.
- EEA. 2015 b. European Environment Agency, 'European Union Emission Inventory Report 1990–2013 under the Unece Convention on Long-Range Transboundary Air Pollution (Lrtap), p. 130.
- EMEP/EEA. 2013. EMEP/EEA air pollutant emission inventory guidebook 2013. Technical guidance to prepare national emission inventories. No 12/2013. <http://www.eea.europa.eu/publications/emep-eea-guidebook-2013> accessed on April 23, 2014
- Gac, A., Béline, F., Bioteau, T. 2006. Flux de gaz à effet de serre (CH₄, N₂O) et d'ammoniac (NH₃) liés à la gestion des déjections animales: Synthèse bibliographique et élaboration d'une base de données. [Greenhouse gas (CH₄, N₂O) and ammonia (NH₃) emissions from manure management: literature review and creation of a database.] 98 p.

- Garrido, F., Henault, C., Gaillard, H., Perez, S., Germon, J.C. 2002. N₂O and NO emissions by agricultural soils with low hydraulic potentials. *Soil Biology & Biochemistry*. 34 (5), 559-575 10.1016/s0038-0717(01)00172-9 <Go to ISI>://WOS:000175658800001
- Hamaoui-Laguel, L., Meleux, F., Beekmann, M., Bessagnet, B., Générmont, S., Cellier, P., Létinois, L. 2014. Improving ammonia emissions in air quality modelling for France. *Atmospheric Environment*. 92, 584-595 10.1016/j.atmosenv.2012.08.002
- Hamon, L., Andrès, Y., Dumont, E. 2012. Aerial Pollutants in Swine Buildings: A Review of Their Characterization and Methods to Reduce Them. *Environmental Science & Technology*. 46 (22), 12287-12301 10.1021/es3025758 <http://dx.doi.org/10.1021/es3025758>
- Hénault, C., Bizouard, F., Laville, P., Gabrielle, B., Nicoulaud, B., et al. 2005. Predicting in situ soil N₂O emission using NOE algorithm and soil database. *Global Change Biology*. 11 (1), 115-127 10.1111/j.1365-2486.2004.00879.x <Go to ISI>://WOS:000225791300010
- ITAVI. 2013. Estimation des rejets d'azote – phosphore - potassium - calcium - cuivre – et zinc par les élevages avicoles. [Estimated emissions of nitrogen, phosphorus, potassium, calcium, copper and zinc from poultry farms] 63 p.
- Jouany, J.P., Vermorel, M. 2010. Les émissions de méthane entérique par les animaux d'élevage en France ; situation actuelle et projections sur les années 2010 et 2020. [Enteric methane emissions by livestock in France; current levels and forecasts for 2010 and 2020] 53 p.
- Lallemant, N., Weber, R. 1996. A computationally efficient procedure for calculating gas radiative properties using the exponential wide band model. *International Journal of Heat and Mass Transfer*. 39 (15), 3273-3286 10.1016/0017-9310(95)00400-9 <Go to ISI>://WOS:A1996UW87500017
- Ni, J.-Q., Robarge, W.P., Xiao, C., Heber, A.J. 2012. Volatile organic compounds at swine facilities: A critical review. *Chemosphere*. 89 (7), 769-788 <http://dx.doi.org/10.1016/j.chemosphere.2012.04.061>
- Paustian, K., Ravindranath, N.H., van Amstel, A., Gytarsky, M., Werner A. Kurz, W.A., et al. 2006. 2006 IPCC guidelines for National Greenhouse Gas Inventories - Agriculture, Forestry and other land use. Vol.4 Institute for Global Environmental Strategies (IGES). http://library.wur.nl/WebQuery/clc?koepel/isn=1885455&wq_inf1=All+available+parts/volumes accessed on April 23, 2014
- Peyraud, J.L., Vertès, F., Delaby, L., Fiorelli, J.L., Durand, P., et al. 2012. Bilans des flux d'azote au niveau des systèmes de production animale. [Nitrogen budgets in animal production systems] Ch. 7. In: Peyraud, J.L., Cellier, P., et al. (Eds.), *Les flux d'azote liés aux élevages. Réduire les pertes, rétablir les équilibres*. Expertise Scientifique Collective. INRA (France) pp. 295-331
- PNUE, 2013. Drawing Down N₂O. To protect Climate and the Ozone layer. A UNEP Synthesis report. United Nations Environment Program (UNEP), Nairobi, Kenya. 57 p.
- Portejoie, S. 2002. Volatilisation ammoniacale lors du stockage et à l'épandage de lisiers de porc: impact des apports protéiques, de l'utilisation de couvertures de fosse et d'additifs. [Ammonia volatilization during pig slurry storage and spreading: the effect of protein supplements, use of slurry pit covers and additives] PhD thesis, University of Perpignan, 137 p.
- Robin, P., Amand, G., Aubert, C., Babela, N., Brachet, A., et al. 2010. Procédures de référence pour la mesure des émissions de polluants gazeux des bâtiments d'élevage

et stockages d'effluents d'élevage. Rapport final. [Standard procedures for measuring pollutant gas emissions from livestock buildings and manure storage. Final report.] (contract 06 74 C0018). 519 p.

2 Measurement methods: type, description, applications and uncertainties

2.1 General principles

In the agricultural sector, three strategies are used for characterizing pollutant emissions into the atmosphere.

1. Strategies based on mass balance of volatile compounds such as carbon (C) and nitrogen (N). These methods do not measure emissions directly but estimate the emissions based on changes in stocks over time. They are generally easier to implement. However, they do not measure emission values for specific gases (N-NH₃, N-N₂O, N₂, C-CH₄ or C-CO₂) nor do they allow differences between two short periods to be associated with particular changes in agronomic or animal management practices or with climate change. The precision of the mass balances depends on available technical and livestock management data and on the characterization of the manure and, in certain cases, the length of the period considered for mass balance calculations.
2. Strategies based on measuring emissions at source. These are generally methods based on quantification of flows and concentrations for confined sources (non-intrusive methods) or methods based on using static or dynamic flux chambers (intrusive methods). As static and dynamic flux chambers can only quantify emissions for a small area of the source, appropriate spatial sampling and extrapolation strategies need to be implemented.
3. Indirect strategies can be used to estimate emissions at a distance from the source without disrupting functioning (non-intrusive methods) and can take account of the lack of uniformity of the site and the sources. The emissions are estimated by measuring concentrations at a distance from the source together with micrometeorological measurements. The flows are then estimated on the basis of these measurements and dispersion models are used to calculate the dispersion coefficients. These methods are fairly difficult to implement and are highly dependent on weather conditions. They can be used to characterize global emissions from heterogeneous, diffuse sources within a given area, without being able to distinguish the emissions from each particular source.

With the exception of mass balance, these strategies are based on measurements of the concentrations of the various gases in the air samples. The sampling strategies and sampling methods are determinant for the quality and spatial and temporal representativeness of the emission measurements. Emissions from agriculture generally vary in time (variations in the parameters for weather, season, physiological stage of crops and animals) and in space (different soils and climatic conditions, movement of the animals).

There are various sampling methods which depend on the strategies adopted and the methods used to determine the concentrations. In general, several concentration measurement methods are compatible with a given strategy. They are characterized by the chemical species which they can detect and the associated limits of detection, the acquisition frequency, their precision, their cost and by the ease of use. There are two families of concentration measurement methods that can be used for any type of gas targeted:

- Physical methods (lasers, absorption spectroscopy, etc). The main characteristics of these methods are their very short response time, their sensitivity and the possibility of monitoring the concentration dynamics in real time (possibly monitoring several gases with different levels of concentration at the same time).
- Chemical methods (chemiluminescence, gas chromatography, trapping in an acid solution, colorimetric gas detection tubes, etc). These methods are suitable for ad hoc measurements or for measurements integrated over periods from a few minutes to a few weeks. They are, therefore, less suitable for monitoring concentration dynamics. Furthermore, most of these methods are selective and cannot be used to measure several gases at the same time using the same equipment.

2.2 Measurement methods

The main methods currently used in France for measuring emissions from animal production systems are described below in the form of application notes. Thirty-two methods have been identified which are used for the various stages involved in determining gas emissions shown in Figure V:

- air sampling methods
- analysis methods for determining the concentration of a pollutant in a sample
- measurement methods for the flows or air fluxes associated with the emissions (eg: in extraction ducts from pig houses)
- complete methods for quantifying emissions which may involve one or more methods in the above three categories

The various methods and techniques presented in this study are divided into the above categories (Table XIII).

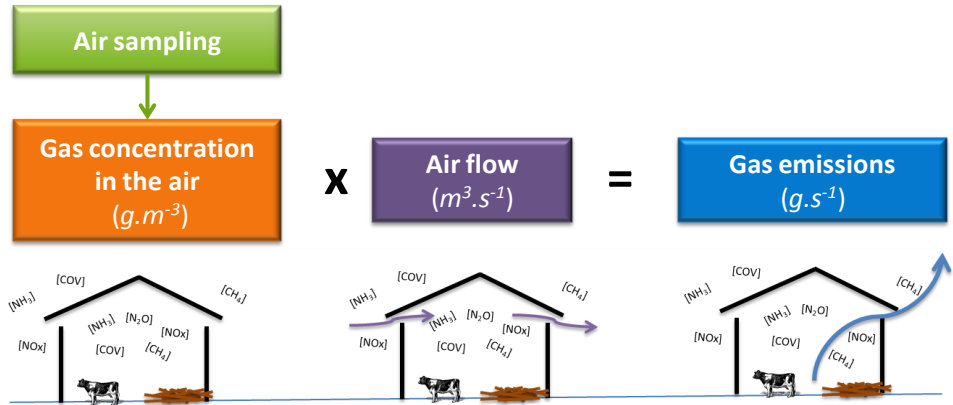

Figure V. Schematic representation of the use of the various emission calculation methods, from sampling to emission flow calculation, illustrated for a livestock building

Table XIII. Methods for sampling, measuring concentrations, airflows and emissions described in this study

	System studied	Target gas	Page
Sampling ambient air			
1 - Passive diffusion samplers	Ambient air	NH ₃ , NO _x , VOCs	39
2 - Denuder tubes	Ambient air	NH ₃ , NO _x , VOCs	43
3 - Trapping in an acid solution	Ambient air	NH ₃	47
4 - Continuous sampling methods for real-time analysis	Ambient air	Any type of gas	51
5 - Sample bags and tubes	Ambient air	Any type of gas	55
Analyzing pollutant concentrations			
6 - Colorimetric gas detector tubes	Ambient air	NH ₃ , NO _x , CO ₂ , VOCs, etc	59
7 - Laboratory assay of ammonium (NH ₄ ⁺) in solution	Solution obtained from sampling using method (1), (2) or (3)	NH ₃	61
8 - Gas chromatography	Air sample	CO ₂ , CH ₄ , N ₂ O, NH ₃	65
9 - Chemiluminescence	Air sample	NH ₃ , NO _x , CO ₂	69
10 - Infrared absorption spectroscopy	Air sample	CO ₂ , CH ₄ , N ₂ O, NH ₃ , NO _x	75
11 – DOAS - Differential Optical Absorption Spectroscopy	Long path in ambient air	NO _x , NH ₃ , N ₂ O, CO ₂	79
12 - Laser absorption spectroscopy	Air sample	CO ₂ , CH ₄ , N ₂ O, NH ₃ , NO _x	83
Airflow in livestock buildings and from manure storage			
13 - Measurement of building airflow using an anemometer	Livestock building with forced ventilation		87
14 - Determining the airflow using a tracer gas	Livestock building Manure storage		91
15 - Determining the airflow by heat balance	Livestock building		95
16 - Determining the airflow by CO ₂ concentration	Livestock building		99
Determination of emissions			
Measurement at source (intrusive or non-intrusive)			
17 - Partially open enclosures	Animal (ruminant) in controlled conditions	CO ₂ , CH ₄	103
18 - Measurement using a tracer gas	Animal (ruminant) in a building or pasture	CO ₂ , CH ₄	107
19 - Greenfeed™ system	Animal (ruminant) at feeding trough (building or pasture)	CO ₂ , CH ₄	111
20 - System for measuring emissions under controlled conditions	Samples of litter or manure (building, storage or spreading)	Any type of gas, depending on the system	115
21 – Estimating emissions using mass balance	Livestock building Outdoor manure storage	gaseous C, gaseous N	119

	System studied	Target gas	Page
22 - Simplified method (concentration ratio and mass balance)	Livestock building	CO₂, CH₄, N₂O, NH₃	123
23 - Static flux chambers	Litter in building Outdoor manure storage Spreading and soil	NO, N₂O, CO₂, CH₄, VOCs	126
24 - Dynamic flux chambers and wind tunnels	Litter in building Outdoor manure storage Spreading and soil	NH₃, NO, N₂O, CO₂, CH₄, VOCs	131
25 - ¹⁵N tracer in the field	Spreading and soil	gaseous N species	137
Micro-meteorological techniques (non-intrusive)			
26 - Integrated horizontal flux (mass balance)	Any distributed source (building, manure storage, spreading, soil, pasture)	Any type of gas, depending on the analyzer	141
27 - Perimeter profile (mass balance)	Any distributed source	Any type of gas, depending on the analyzer	145
28 - Aerodynamic gradient	Any uniform distributed source	Any type of gas, depending on the analyzer	149
29 - COTAG - Conditional Time-Averaged Gradient	Any uniform distributed source	NH₃	155
30 - Inverse modeling	Any uniform distributed source	Any type of gas, depending on the analyzer	159
31 - Eddy covariance	Any uniform distributed source	Any type of gas, depending on the analyzer	165
32 - Modified eddy covariance (REA, DEC, vDEC)	Any uniform distributed source	Any type of gas, depending on the analyzer	169

These methods are classified according to their use, the systems to which they can be applied and the main target gases covered by this review. A sampling method (eg, passive sampler) and a concentration measurement method (eg, laboratory assay of ammonium in solution), can be used for an emission determination method (eg, COTAG).

Application note 1 Measuring mean nitrogenous gas concentrations with passive diffusion samplers

Scope of application

Many different types of passive diffusion samplers have been described in scientific literature and are used by companies that provide analysis services. They all measure the mean concentration of gases over a period of time that depends on the environment, the concentration ranges being measured and the precision required. An overview of these samplers for measuring ammonia and nitrogen dioxide can be found in Tang *et al.* (2001). Passive diffusion samplers can be used in a wide range of environments, inside livestock buildings as well as in natural areas with low pollution levels (Loubet *et al.*, 2009). They are able to measure concentrations of reactive gases such as ammonia and nitrogen dioxide but are not used to measure greenhouse gases. They have been used to measure ammonia emissions by air quality monitoring networks at national and local regional scale.

Operating principles

All passive samplers operate on the principle of diffusion of gases along a sampler of defined dimensions onto an absorbing medium (acid, base, resin compounds) according to Fick's law. During diffusion, the gas passes from a zone with a high concentration of the gas (the ambient air being analyzed) to a zone with a low concentration (the absorbing medium). The absorbing medium maintains a low concentration of the gas in the adjacent air which ensures that there is continuous diffusion. The theoretical uptake rate of a sampler is a function of the cross-sectional area, A (m^2), the length, L (m) (the distance from the mouth of the sampler to the reaction surface) and the diffusion coefficient, D ($m^2.s^{-1}$), of the gas of interest. The effective volume of air sampled, V (m^3), is determined using the following equation:

$$V = D \times \frac{A \times t}{L} \quad (\text{eq. M1.1})$$

where t is the exposure time in seconds. The cross-section and length can be adjusted to obtain the required sampling time.

The air concentration of a pollutant, C ($\mu\text{g}.m^{-3}$), can then be calculated:

$$C = \frac{(m_e - m_b)}{V} \quad (\text{eq. M1.2})$$

where m_e (μg) is the mass of pollutant collected on an exposed sample and m_b (μg) is the mass of pollutant in a control sample.

There are two main types of passive diffusion sampler: tubes and badges (see Figure M1.1). Tube samplers are usually vertical hollow tubes, the absorbing medium being placed at the

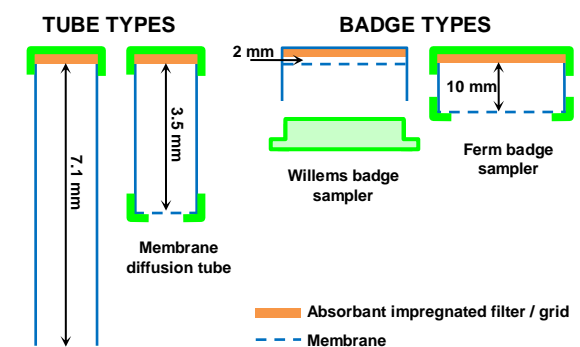

Figure M1.1. Some examples of tube-type and badge-type passive diffusion samplers (Tang *et al.*, 2001)

top. The lower end of both tubes and badges may be open or capped with a permeable membrane that does not react with the gas being measured. For measuring ammonia concentrations, the absorbent is citric, phosphoric; sulfuric or tartaric acid. Triethalonamide (TEA) is commonly used for nitrogen dioxide (NO₂). A wide range of resins can be used to measure volatile organic compounds (VOC).

Equipment required

The unit shown in Figure M1.2 is an ALPHA (Adapted Low-cost Passive High Absorption) sampler for NH₃.

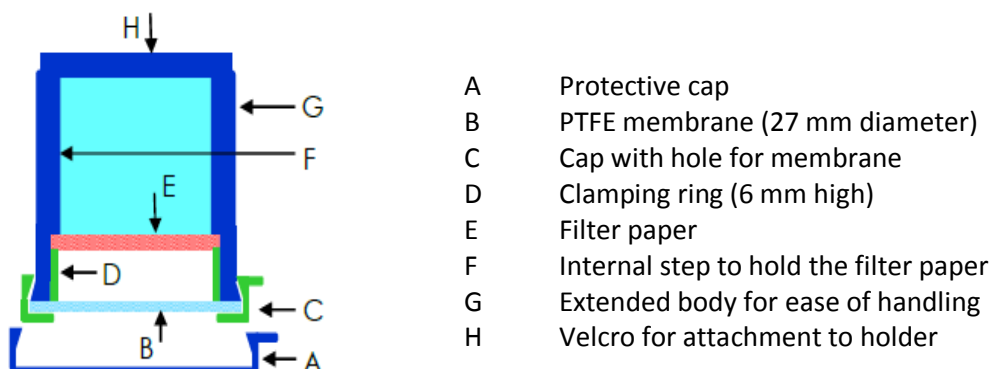
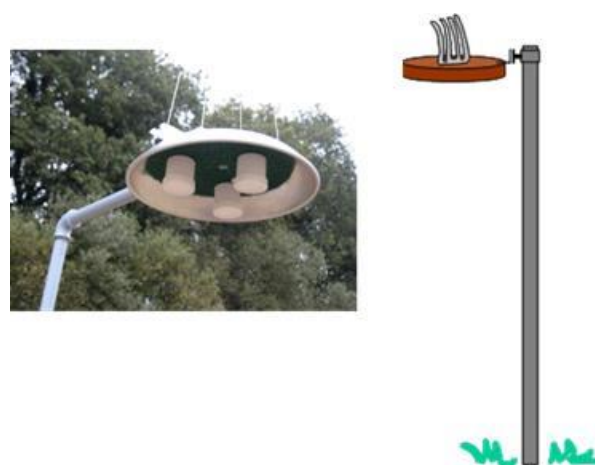

Figure M1.2. Cross-section of an ALPHA sampler

The various parts of the sampler may be re-used many times. However, they must be cleaned thoroughly after use to avoid contamination of the following sample. When a sampler has been prepared, the protective cap is fitted to prevent any contact with the ambient air while being stored temporarily and taken to the place of measurement. The consumables required are the filter paper (E), the acid to trap the ammonia and the PTFE membrane (B) (which can be used several times, after cleaning). To measure the concentration, several samplers are usually exposed in the same conditions. The samplers should be prepared and the medium extracted in conditions where there is no risk of contamination (laminar flow cabinet, gloves, tweezers, etc).

Implementation

The samplers are exposed for a given length of time depending on the situation and the expected concentrations. The time is shorter for high concentrations to prevent the sampling medium becoming saturated. The samplers must be protected from rain and external sources of contamination such as birds or small mammals (Figure M1.3). The samplers must be handled in the field using gloves to prevent contamination by the user. The samplers should be prepared (coating the filter with the absorbent medium, assembly, placing in sealed packaging) in a laboratory which collects them, extracts and



Here, three badges are exposed for one month under a protective cover with anti-bird spikes, at a height of about 2m

Figure M1.3. ALPHA sampling system used in the field

assays the NH_4^+ (Application note 7) from the impregnated filter and calculates the concentrations in the air. After collection, some media used for measuring very volatile compounds must be preserved in dry ice. Less volatile compounds can be refrigerated at 4°C.

Validation and sources of uncertainty

The measurement principle has been tested extensively in a wide range of situations. However, this is not always the case for particular types of equipment, even those that are currently on the market. Very large differences, in particular for low concentration levels, have been found in comparative tests (Puchalski *et al.*, 2011). For ammonia, some samplers such as the Willems badges (Figure M1.1), used in buildings, and ALPHA samplers used outdoors have been widely validated and have proved reliable. The precision obtained is around 10% of the absolute concentration over a range from less than one to several hundred $\mu\text{g}\cdot\text{m}^{-3}$.

Samplers without a membrane filter (Figure M1.1) over the end are highly sensitive to wind speed and the diffusion coefficient needs to be temperature corrected. In livestock buildings, they may be affected by dust. Whatever type of sampler is used, several samplers should be exposed at the same time, as well as a control which is not exposed, particularly for low concentration levels. This makes it possible to detect any sources of contamination. Using passive samplers requires considerable care in positioning and collecting the samplers to prevent any risk of contamination. Great care must be taken when preparing the samplers and analyzing them, including extraction of the compounds absorbed by the medium. The analysis methods must be as specific as possible for the species of interest as the sampler is liable to absorb many other species.

Advantages and limitations

Advantages: Passive diffusion samplers are easy to set up in the field. These samplers are more sensitive than using chemiluminescence methods (Application note 9) for typical concentrations of species such as ammonia, and much more sensitive at low concentrations.

Limitations: As diffusion is a slow process, they can only be used for measuring mean concentrations over long periods, ranging from a few hours to a few weeks.

Cost: The cost of a passive diffusion sampler is low (a few Euros to tens of Euros) but the total cost of measurement at a particular site may be close to that of an automatic analyzer when measurements have to be repeated over a long period.

References

Authors of the application note:

- Pierre Cellier, INRA, UMR EGC - Thiverval-Grignon, France,
- Stéphane Godbout, Johann H. Palacios, Patrick Dubé, Lise Potvin and Matthieu Girard, IRDA - Quebec, Canada

Other organizations: NERC/CEH – Edinburgh, United Kingdom

Bibliography

Loubet, B., Asman, W.A.H., Theobald, M., Hertel, O., Tang, S.Y., et al. 2009. Ammonia deposition near hot spots: processes, models and monitoring methods. In: Sutton,

- M.A., Reis, S., et al. (Eds.), Atmospheric ammonia - detecting emission changes and environmental impacts. Springer pp. 205-267
- Puchalski, M.A., Sather, M.E., Walker, J.T., Lelunann, C.M.B., Gay, D.A., et al. 2011. Passive ammonia monitoring in the United States: Comparing three different sampling devices. *Journal of Environmental Monitoring*. 13 (11), 3156-3167
10.1039/c1em10553a
- Tang, Y., Cape, J., Sutton, M. 2001. Development and types of passive samplers for monitoring atmospheric NO₂ and NH₃ concentrations. *The Scientific World Journal*. 1, 513-529

Application note 2 Measuring nitrogen gas concentrations using denuder tubes

Scope of application

Denuders have been used for a long time to measure reactive gaseous compounds in the air, in particular ammonia and acid compounds such as nitrogen oxides.

Operating principles

Denuders are tubes through which air is circulated. The inside of the tube is coated with an absorbing medium specific to a gas or family of gases (Figure M2.1). The gas of interest diffuses to the internal surface of the tube where it is absorbed and transformed into a stable, non-volatile compound (eg: $\text{NH}_3 \rightarrow \text{NH}_4^+$). The airflow speed through the tube and the length of the tube are adjusted to give a laminar flow and to ensure that all the gas of interest is absorbed by the walls of the tube during the time taken to pass from the mouth to the exit of the tube. Ideally, the gas concentration on exit should be zero. The trapping efficiency *Eff* of the tube, used to dimension the system, can be calculated using the following formula (Ferm, 1979) for a simple tube:

$$Eff = 0.819 e^{-14.6276\mu} + 0.0976 e^{-89.22\mu} + 0.01896 e^{-212\mu} \quad (\text{eq. M2.1})$$

where

$$\mu = \pi \times \frac{D \times L}{4 \times Q},$$

D is the diffusion coefficient ($\text{m}^2 \cdot \text{s}^{-1}$),

L is the tube length (m) and

Q is the airflow ($\text{m}^3 \cdot \text{s}^{-1}$). The value should be as close to 1 as possible for maximum efficiency.

Equipment required

There are several types of denuder tube:

- Simple one or two stage tubes (the second stage checks that all the gas has been absorbed in the first stage) with a solid absorbing medium
- Wet effluent diffusion denuders (WEDD): the gas is absorbed by a fluid flowing in the opposite direction to the airflow
- Dry or wet annular denuders
- Honeycomb denuder

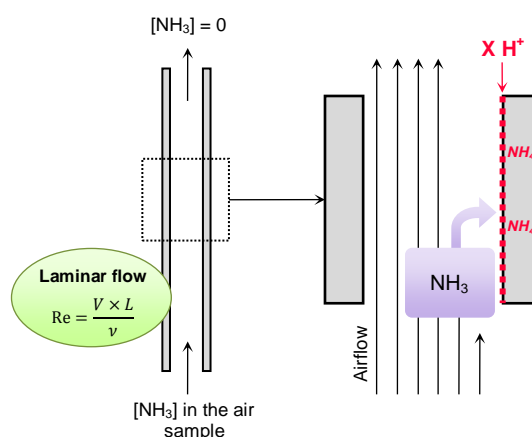

Figure M2.1. Schematic showing the operating principles of active diffusion tubes

The flow is laminar if the Reynolds number *Re* is less than 2000 where *V* is the mean airspeed ($\text{m} \cdot \text{s}^{-1}$), *L* is the length of the tube (m) and ν is the kinematic viscosity ($\text{m}^2 \cdot \text{s}^{-1}$).

The annular and honeycomb denuders are more complex but significantly increase the ratio of the exchange surface to the volume of the sensor.

The system shown in Figure M2.2 was designed by CEH Edinburgh to measure acidic gas species, including NO_x, as well as ammonia (Sutton *et al.*, 2001). The system comprises:

- two sets of denuder tubes: the first is coated with potassium carbonate (K₂CO₃) to capture acidic species (HNO₃, SO₂, HCl) and the second is coated with citric acid (or phosphoric acid in hot climates) to capture ammonia
- a two stage aerosol filter
- a pump to provide an airflow of 0.3-0.4 l.min⁻¹
- a gas meter (Gallus) to measure the volume of air that has passed through the system.

Implementation

The system is built into a box with the pump and gas meter. The air intake is at the bottom and protected against rainwater and flying insects. It may be advisable to provide some form of heating in winter to prevent condensation forming in the tubes. The sets of tubes and filters are coated and assembled in a laboratory in a clean atmosphere to prevent contamination. The tubes are exposed for a given period (typically between one day and one month) and then collected, replaced by a new set of tubes and sent back to the laboratory where the coatings inside the tubes are extracted in a measured volume of distilled water, and then analyzed with an appropriate analyzer for the compounds concerned.

The concentration of the compound of interest in the air (C) is then calculated using the following equation:

$$C = \frac{V_l \times C_l}{V_a} \text{ (eq. M2.2)}$$

where V_a is the volume of air sampled during exposure and V_l and C_l are the volume of and concentration in the fluid extracted from the tube.

After collection, if very volatile compounds are being measured, the tubes must be kept in dry ice. For less volatile compounds, the tubes can be stored at 4°C.

Validation and sources of uncertainty

This method is generally considered to be the standard. The uncertainties are mainly related to the method used for measuring the concentrations.

Advantages and limitations

Advantages: This type of system can be adapted to the concentrations expected, even if they are very low, by adjusting the airflow and duration of exposure. This system is preferable to

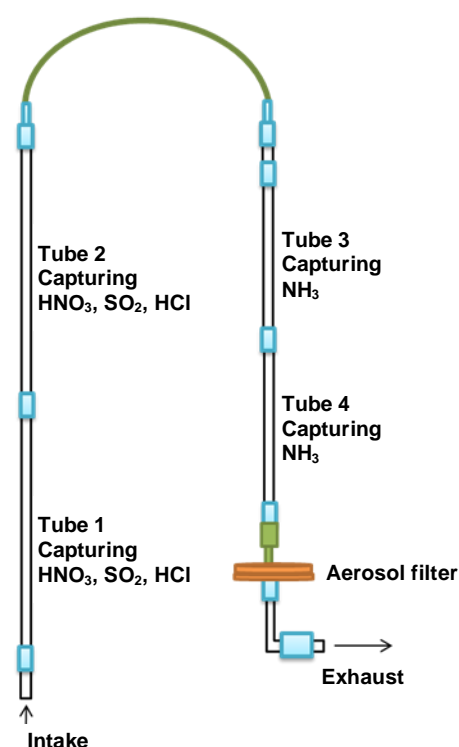

Figure M2.2. Denuder tube system developed at CEH Edinburgh (Tang *et al.* 2009)

Each set of tubes comprises two tubes in series: the second tube checks the capture efficiency for the gas of interest.

passive samplers for short sampling periods (from a few minutes up to about an hour). There may be several layers of different absorbing media and the tubes can be assembled in series. This enables a wide variety of compounds to be collected in a relatively short sampling time. It measures only the gaseous fraction of the compounds of interest, as the particulate fraction does not diffuse onto the surface and cannot, therefore, be captured. However, to avoid capturing the ammonia from particulates in the air, the residence time must be sufficiently short, about a few seconds (Harper, 2005). The particulate and aerosol concentrations can be measured by adding a filter to the end of the tube (Figure M2.2).

Limitations: The disadvantage of the system is that it needs manual intervention for each measurement, except for wet effluent diffusion denuders (WEDD). However, these have microbiological contamination risks.

Costs: The cost of each sample is low (a few Euros to hundreds of Euros), but the total cost of measurement at a particular site may be close to that of an automatic analyzer when measurements have to be repeated over a long period. WEDDs are more expensive.

References

Authors of the application note:

- Pierre CELLIER, INRA, UMR EGC - Thiverval-Grignon, France
- Stéphane Godbout, Johann H. Palacios, Patrick Dubé, Lise Potvin and Matthieu Girard, IRDA - Quebec, Canada

Other organizations: ECN - Petten, Netherlands; NERC/CEH - Edinburgh, United Kingdom

Bibliography

- Ferm, M. 1979. Method for determination of atmospheric ammonia. *Atmospheric Environment*. 13 (10), 1385-1393 10.1016/0004-6981(79)90107-0
- Harper, L.A. 2005. Ammonia: Measurement Issues. In: Hatfield, J.L., Baker, J.M. (Eds.), *Micrometeorology in Agricultural Systems*. Agronomy Monograph. American Society of Agronomy, Crop Science Society of America, and Soil Science Society of America pp. 345-379. <https://dl.sciencesocieties.org/publications/books/abstracts/agronomymonogra/micrometeorolog/345>
- Sutton, M.A., Tang, Y.S., Miners, B., Fowler, D. 2001. A new diffusion denuder system for long-term, regional monitoring of atmospheric ammonia and ammonium. *Water, Air and Soil Pollution: Focus*. 1 (5-6), 145-156 10.1023/A:1013138601753
- Tang, Y.S., Simmons, I., Dijk, N.v., Marco, C.d., Nemitz, E., et al. 2009. European scale application of atmospheric reactive nitrogen measurements in a low-cost approach to infer dry deposition fluxes. *Agriculture, Ecosystems & Environment*. 133 (3/4), 183-195 10.1016/j.agee.2009.04.027

Application note 3 Measuring NH₃ concentrations by trapping in an acid solution

Scope of application

Acid solution ammonia impingers can be used to determine the total amounts of ammonia emitted over a given sampling period from livestock buildings, from manure storage systems and from areas where manure has been spread. Impingers are used to determine the mean concentration over the measurement period (Portejoie *et al.*, 2012; Phillips *et al.*, 2001; Générmont, 1996; Moal, 1994). This measurement method cannot be used to characterize the temporal dynamics of concentrations over short timescales.

Operating principles

This method is based on the affinity between ammonia (a base) and an acid in solution. The ammonia in the air emitted from a source (livestock building, manure storage/treatment system, area where manure has been spread) over a known period (t) and partially sampled at a known airflow (q) is trapped in an acid solution of known concentration (C) in a flask. The solution is then weighed and assayed in the laboratory using various techniques depending on the level of concentration of the initial acid solution and the limits of detection of the analysis equipment used (colorimetry, ionic chromatography coupled to conductivity sensor, etc). The laboratory analysis of the concentration of NH₄⁺ or N-NH₄⁺ in the acid solution is used to calculate the concentration of ammonia (NH₃ or N-NH₃) in the air, taking account of the mass of the acid solution in the impinger and the volume of air that has passed through the impinger.

Equipment required

- Impingers: glass flasks with a tube and bubble diffuser. A constant, predefined airflow from the sampling system for the source to be measured (livestock building, manure storage/treatment system, area where manure has been spread) passes from the tube through the acid solution
- Acid solution: sulfuric acid (H₂SO₄), boric acid (H₃BO₄), ortho-phosphoric acid (H₃PO₄) with a concentration between 0.1N and 2N
- Pump: pump to maintain a constant airflow
- Gas meter: a desiccant such as silica gel is used between the impingers and the gas meter to protect it from acid attack
- Flow meter: the airflow passing through the solution must be between 2 and 4 L.min⁻¹ to prevent loss of the acid solution
- Sampling tube made of PTFE, polyethylene or any other material that will not absorb the ammonia
- Timer to determine the duration for which the air is sampled

Implementation

A schematic of a typical impinger train is given in Figure M3.1.

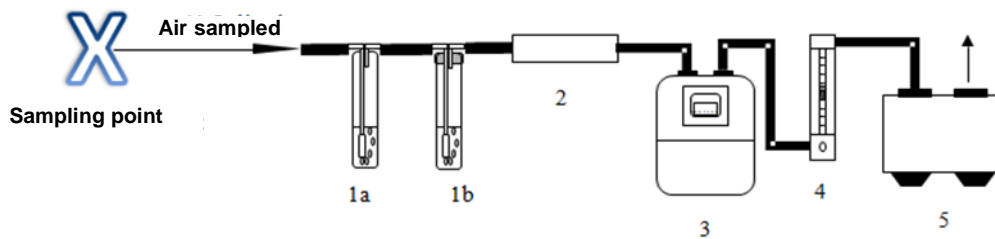

Figure M3.1. Schematic of a typical impinger train

Two impinger tubes (1a and 1b) are connected in series to deal with saturation of the first impinger. 2: desiccant cartridge, 3: gas meter, 4: flow meter, 5: pump.

Part of the air taken from the source of the emissions (livestock building, manure storage/treatment system, area where manure has been spread) is sucked through the impinger train by a pump (5). The air sampled passes through the acid solution (impingers 1a and 1b) at a flow rate (q), usually less than $5 \text{ L}\cdot\text{min}^{-1}$ to give time for the ammonia in the air to be absorbed in the acid solution. The airflow is monitored by the flow meter (4) to prevent excessive loss of the acid solution. The volume of air sampled is determined using a gas meter (3). The amount of ammonia trapped, $N_{trapped}$ (mg), is determined using the following equation:

$$N_{trapped} = [N - NH_4^+]_{acid\ solution} \times m_{acid\ solution} \quad (\text{eq. M3.1})$$

where $[N - NH_4^+]_{acid\ solution}$ ($\text{mg}\cdot\text{g}^{-1}$) is the concentration of ammonium in the acid solution and $m_{acid\ solution}$ (g) is the mass of the acid solution in the impinger.

The concentration of ammonia in the air sample, $C_{N-NH_3,air}$ ($\text{mg N}\cdot\text{m}^{-3}$), is calculated using the following equation:

$$C_{N-NH_3,air} = \frac{N_{trapped}}{V_{sample}} \quad (\text{eq. M3.2})$$

where V_{sample} (m^3) is the volume of air passing through the impinger

The length of time for which the air is sampled depends on the size of the impingers and the volume of acid solution used. The nominal maximum saturation limit can be calculated from the acid concentration and the probable NH_3 concentration. Impingers can be connected in series, as shown in Figure M3.1.

Validation and sources of uncertainty

This method is generally used as a standard. Ammonia is very reactive and very soluble in water. The intake equipment (solenoid valve, pumps, filters, pipes, etc) must be kept to a minimum to maximize the NH_3 trapped for accurate measurements. It is also advisable to prevent water from condensing inside the intake (by heating it, for example).

Advantages and limitations

Advantages: This method is able to trap nearly 100% of the ammonia in the air sampled (Portejoie, 2002; Génermont, 1996; Moal, 1994). The measurement range is unlimited, provided that the sampling time is appropriate for the strength and quantity of the acid solution (Phillips *et al.*, 2001). This is, therefore, a robust, simple and low cost method that can be used for the various sources of emissions from farms and can be adapted to a wide

range of atmospheric ammonia concentrations. It is recommended for measuring concentrations for mass balance (Application note 21).

Limitations: It is a time-consuming process, not suitable for high temporal resolution monitoring and for which the concentration measurement will not be available in real time. It is difficult to automate as it requires a source of power for the pump and a considerable amount of time for the laboratory assays, depending on the number of samples and the analysis method used (distillation for example). There may be interference from other absorbable species containing nitrogen (eg: volatile amines).

Cost: The cost of an ammonia impinger is relatively low (a few hundred Euros investment plus the cost of the analyses).

References

Authors of the application note:

- Laurence Loyon and Fabrice Guiziou, IRSTEA – Rennes, France

Other organizations: INRA, IFIP, ITAVI, IDELE, Brittany Regional Chamber of Agriculture

Bibliography

- Génermont, S. 1996. Modélisation de la volatilisation d'ammoniac après épandage de lisier sur parcelle agricole. (Modeling the volatilization of ammonia after spreading manure on fields) PhD thesis, Paul Sabatier University - Toulouse, 331 p.
- Moal, J.F. 1994. Volatilisation de l'azote ammoniacal des lisiers après épandage: quantification et étude des facteurs d'influence (Volatilization of ammonia from manure: quantification and study of influencing factors). Cemagref, Equipement pour l'eau et l'environnement, Perpignan University, 230 p.
- Phillips, V.R., Lee, D.S., Scholtens, R., Garland, J.A., Sneath, R.W. 2001. A review of methods for measuring emission rates of ammonia from livestock buildings and slurry or manure stores, Part 2: Monitoring flux rates, concentrations and airflow rates. *Journal of Agricultural Engineering Research*. 78 (1), 1-14 10.1006/jaer.2000.0618
- Portejoie, S., Martinez, J., Landmann, G. 2012. L'ammoniac d'origine agricole: impacts sur la santé humaine et animale et sur le milieu naturel. (Ammonia emissions from agriculture: impact on human and animal health and on the natural environment) *INRA Productions Animales*. 15 (3), 151-160
- Portejoie, S. 2002. Volatilisation ammoniacale lors du stockage et à l'épandage de lisiers de porc: impact des apports protéiques, de l'utilisation de couvertures de fosse et d'additifs. (Ammonia volatilization during pig manure storage and spreading: the effect of protein supplements, use of slurry pit covers and additives) PhD thesis, University of Perpignan, 137 p.

Application note 4 Continuous sampling methods for real-time analysis

Scope of application

This method is used for taking and analyzing air samples in real time from various agricultural sources, livestock buildings, manure storage systems, cultivated fields, agricultural product treatment processes, etc.

Operating principles

The air sampled must be transported, unaffected, from the sampling point to the analyzers by using the minimum amount of equipment and ensuring that the equipment is of adequate quality. In particular, the air sampled must be kept above dew point during transfer. This prevents any condensation which might trap the gases to be measured in the water. This is a particular risk if the temperature and pressure at the sampling point are different from the temperature and pressure in the analyzer or the air circuit. This is generally the case in systems where hot, damp air is sampled in a livestock building and transferred to a cooler room for analysis. Furthermore, particulates that might fix the species to be measured and affect the measurements must be removed from the air to be sampled at source or, if this is not possible, as close to the source as possible. Particular care must be paid at the connecting points between the various parts of the equipment to avoid leaks and special attention must be paid to the chemical properties to ensure that there is no reaction with or adsorption of the compounds of interest. The whole of the sampling system should be designed to ensure that the time taken to transport the air samples is compatible with the type and dynamics of the emissions phenomena that are to be studied (Wight, 1994; Jahnke, 1993).

Equipment required

- Inert, non-porous tubes for the air circuit
- Heater cords to keep the tubes above dew point
- Hydrophilic filters to trap aerosols
- Pump, if the analyzer does not have an integral pump
- Valves and connectors (with seals that do not react with the gases being measured)
- Multiplexer to monitor several sampling points in succession

Implementation

Figure M4.1 shows an example of a heated air gas measurement system.

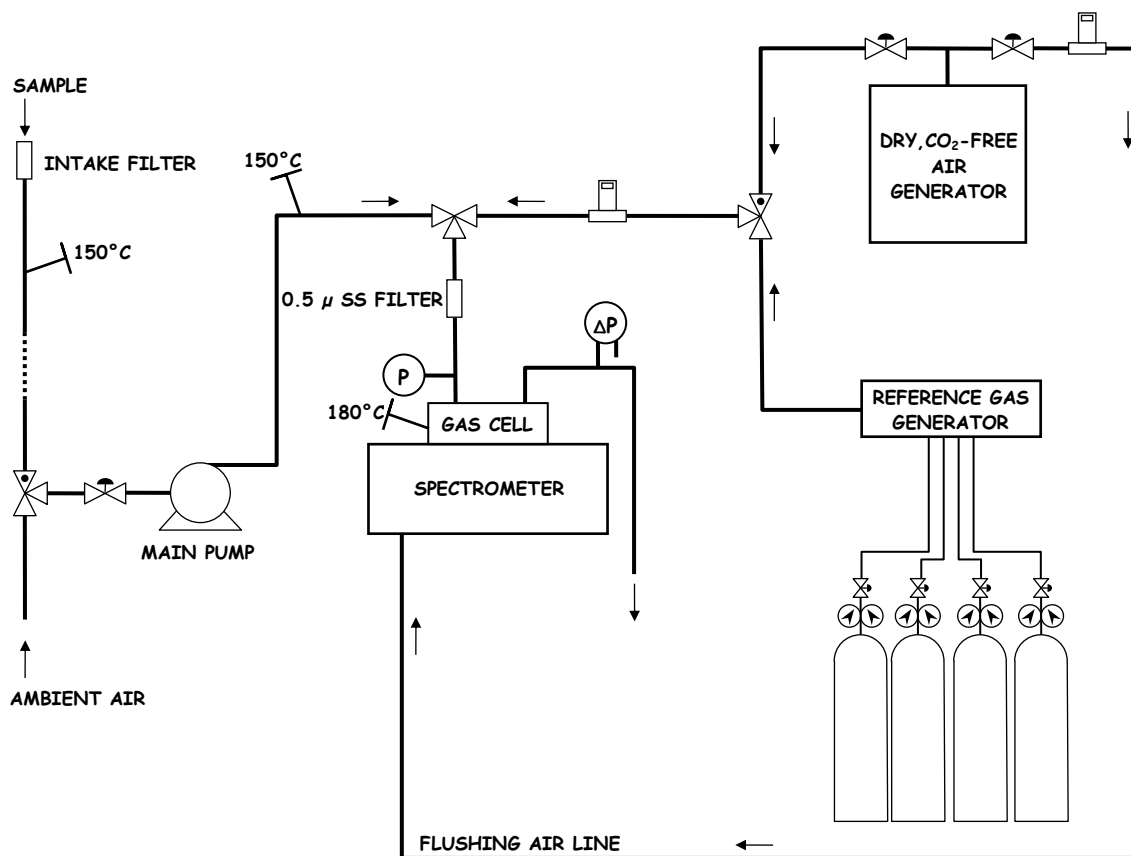

Figure M4.1. Heated air gas sampling system

Validation and sources of uncertainty

An *in situ* (upstream of the sampling point) measurement method, such as colorimetric tubes (Application note 6) can be used in parallel to check that the concentrations measured are realistic and to determine whether there are any leaks or condensation in the sampling system. The air circuit pipes may become porous with time and/or adsorb reactive gases such as ammonia. If a multiplexer is used, the response time of the analyzer and the time taken to flush through the air circuit should be taken into account when analyzing successive sampling points with very different gas concentrations. Using an external pump may help to prevent cross-contamination between samples.

Advantages and limitations

Advantages: The air samples can be analyzed *in situ*, in real time and continuously over long periods of time. Multiplexers also make it possible to take samples, in succession, from several points that are representative of different sources on the same site. Using a single analyzer makes it easier to compare measurements.

Limitations: It may take some time to set up or move the sampling system, depending on the length of the air circuits.

Costs: An investment of several thousand Euros may be required, excluding operating costs.

References

Authors of the application note:

- Stéphane Godbout, Jean-Pierre Larouche and Lise Potvin, IRDA – Quebec, Canada

- Mélynda Hassouna, INRA UMR SAS – Rennes, France

Other organizations: IFIP, ITAVI, IDELE, Brittany regional chamber of agriculture

Bibliography

- Godbout, S., Pelletier, F., Larouche, J.P., Belzile, M., Feddes, J.J.R., et al. 2012. Greenhouse gas emissions from non-cattle confinement buildings: monitoring, emission factors and mitigation. 5. In: Liu, G. (Ed.), Greenhouse Gases - Emission, Measurement and Management. InTech pp. 101-126
- Jahnke, J.A. 1993. Continuous emission monitoring. Van Nostrand Reinhold 302 p.
- Wight, G. 1994. Fundamentals of air sampling. Lewis Publishers 272 p.

Application note 5 Taking air samples using sample bags and tubes

Scope of application

It may not be possible to measure gas concentrations in the ambient air directly on site because the measurement equipment is not suitable for use in the field conditions or, for example, it may not be recommended for emission estimating methods based on point measurements (Application notes 22 and 23). In such cases, glass sample tubes or polymer film sample bags can be used. These are made from materials that do not react with the gases to be measured.

Glass sample tubes are used mainly when the volume of air sampled must be small to avoid disturbing the emission process. The technique used for measuring the concentration must, therefore, not require a large volume of air (for example, gas chromatography, Application note 8). They are used with static flux chambers (de Klein and Harvey, 2012; Application note 23) to measure greenhouse gas concentrations (GHG) emitted from manure storage or spreading.

Various sizes of bag are available for sampling larger volumes of air over longer periods. They are more suitable for sampling ambient air in livestock buildings to measure NH₃, CO₂, N₂O, CH₄ and H₂O concentrations.

Operating principles

For delayed analysis of air samples, the samples must be kept in containers that ensure that they remain stable and representative (each sample should be representative of the air sampled in a given place at a given time). Sample bags (if they are made of a material that is compatible with the gases to be measured and the analysis method) and glass sample tubes are both suitable containers. Sample bags are filled using a pump or by placing them in a vacuum chamber. Glass sample tubes are evacuated and then filled using a syringe and needle.

Equipment required

For sample tubes:

- Vacuum pump / vacuum line + manometer (for evacuating the tubes before sampling)
- Glass sample tubes
- Injection needle
- Syringe
- Labels

For sample bags

- Bags (foil, for example Flexfoil SKC®)
- Sampling pump (inert materials, designed for direct sampling, low flow rate and adjustable)
- Dust filter
- Vacuum chamber (used in place of a sampling pump)

Implementation

Sample bags

Sample bags (Figure M5.1) are used to sample the ambient air in livestock buildings and outdoors. These bags are made in various materials and in various sizes. Some materials suffer from considerable diffusion through the walls or adsorption on the walls of the bags which degrades the air sample. Furthermore, some materials may emit compounds which, depending on the method used to measure the gas concentrations, could interfere with the species to be measured. The materials must, therefore, be selected specifically for the species targeted and the time for which the sample must be preserved and new types of bag must be tested before they are used in the field.



Figure M5.1. Flexfoil® sample bag used for sampling the air in livestock buildings (source INRA)

Tests carried out by INRA, Rennes, showed that this type of bag had very low permeability for water, CH₄, N₂O, NH₃ and CO₂.

The bags can be filled with air samples using a pump or vacuum chamber.

If a pump is used, the sampling train (pump + hose) must be in inert materials to prevent any interaction with the air sampled or carry over from one sample to the next. The pump flow rate must be adjusted so that the time taken to fill the bag corresponds to the required sampling duration to complete the operation being studied in the building defined by the operator (to give a representative mean sample, Application note 22). The sampling train should have a filter to protect the bags and the pump from dust.

If a vacuum chamber is used, the bag is first placed in the chamber (a sealed case or drum) and connected to the outside by an inert tube. A pump is used to evacuate the vacuum chamber, which will cause the bag to fill. In this case, the filling time depends on the rate at which air is pumped out of the vacuum chamber. This means that the air sample does not pass through a pump, which simplifies the choice of pump and prevents contamination of the samples.

The bags can be re-used several times if they are flushed (preferably using an inert gas such as N₂) and they have been tested for carry over by a laboratory.

Glass sample tubes

Glass is an inert material that does not affect the sample. The sample tubes are closed with a rubber septum (Figure M5.2) and evacuated. The air sample is taken using a syringe and needle. The contents of the syringe are then injected into the evacuated tube through the rubber plug. As the tube has been evacuated, the air in the syringe will be sucked into the tube. The plunger must be pushed to complete filling the tube.

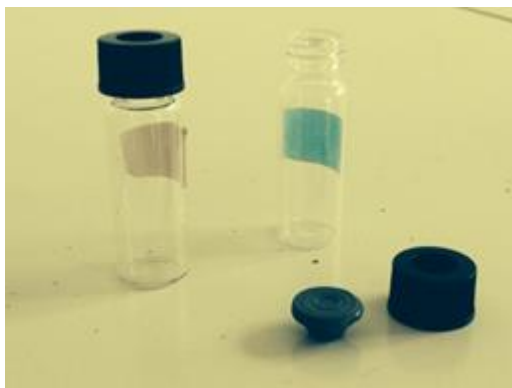

Figure M5.2. Two glass air sample tubes with septa (source INRA)

Validation and sources of uncertainty

There are many types of sample bag on the market. However, not all are suitable for detecting the gases targeted on farms. If there are no published tests, preliminary tests should be carried out in the laboratory using reference gases to evaluate possible incompatibility and also permeability.

Advantages and limitations

Advantages: Both types of sampling container can be used for keeping samples of nonreactive compounds for several days before analysis. Tubes are able to conserve samples without risk of bias for a longer period than bags.

Limitations: Care must be taken when filling sample tubes and bags, to prevent contaminating the sample, and during transport, as they are both fragile.

Cost: From a few Euros to tens of Euros per bag or set of tubes. The cost of the filling equipment ranges from tens of Euros to hundreds of Euros.

References

Authors of the application note:

- Mélynda Hassouna, INRA, UMR SAS – Rennes, France
- Patricia Laville, INRA, UMR EGC – Thiverval-Grignon, France

Other organizations: IFIP, ITAVI, IDELE, INRA, IRDA, Brittany regional chamber of agriculture

Bibliography

de Klein, C., Harvey, M.J. 2012. Nitrous oxide chamber methodology guidelines. Version 1. Ministry for Primary Industries: 146 p.

<http://www.globalresearchalliance.org/research/livestock/activities/nitrous-oxide-chamber-methodology-guidelines/> (site accessed on October 22, 2014)

Application note 6 Point measurement of gas concentrations using colorimetric gas detector tubes

Scope of application

Colorimetric gas detector tubes indicate the concentrations directly by color change and can be used to measure more than 500 substances including ammonia (NH₃), nitrogen oxides (NO_x), volatile organic compounds (VOCs) and carbon dioxide (CO₂). This ad hoc measurement method for gas concentrations can be used in livestock buildings, for manure storage systems and in open fields and is used for cattle, poultry and pig farming.

Detector tubes are reliable and easy to use and can be used for estimating the levels of concentrations to be measured using more complex, more precise methods such as absorption spectroscopy (Application notes 10 to 12). They can also be used for measuring the efficiency of air treatment processes (Hamon *et al.*, 2012).

Operating principles

A hand pump is used with detector tubes that are specific to the target gases. The target gas reacts with the reagents in the tube. The strength of the reaction is proportional to the concentration of the gas in the air. A graduated scale is used to read the length of the color change which indicates the concentration of the target gas. Many of the reactions used are based on pH indicators, such as bromophenol blue to measure NH₃ concentrations. There is a range of tubes for different target gases, the expected concentration range and the level of precision required. The gas concentration is expressed v/v as ppm or mL.m⁻³. The v/v concentration can be converted w/v concentration (mg.m⁻³) for given temperatures and pressures.

Equipment required

- Colorimetric gas detector tube
- Precision sampling pump which draws a defined volume of air through the tube to give a direct reading of the concentration from the color change.

Implementation

The pump should be checked before use to ensure that it is not leaking. A new detector tube with both ends sealed should be inserted into the pump after the air has been pushed out. If the pump does not refill with air, it is not leaking. The ends of the tube are then snapped off and the tube is fitted to the pump and pushed fully home. A pre-defined quantity of air is drawn in by the pump and as it passes through the tube the gas reacts with the reagent to cause a color change. The amount of reagent that changes color depends directly on the concentration (Dräger, 2009). The concentration is read from the graduated scale printed on the tube. It takes less than 15 minutes for a measurement.



Figure M6.1. Sampling pump with colorimetric gas detector tube (source: Solène Lagadec, Brittany regional chamber of agriculture)

Validation and sources of uncertainty

This measurement method is simple, reliable and reproducible. It is principally an indicative method used to check the orders of magnitude for verifying the results from more complex methods. The precision and validity ranges for each type of gas and each type of tube are given in the manufacturers' specifications. For example, this method has a precision of about 10% to 15% for ammonia within the range from 5 ppm to 100 ppm, and has a limit of detection of the order of 1 ppm. For greater precision, the concentration expected is used to select the most appropriate type of tube.

Advantages and limitations

Advantages: Colorimetric gas detector tubes are particularly useful for ad hoc measurements to determine the order of magnitude of concentrations. This method is quick and easy to implement. It is reproducible and not very intrusive. This method can be used for a wide range of concentrations depending on the tube selected and the amount of air sampled.

Limitations: This method is not suitable for precise quantification or for determining concentration dynamics at high frequencies. Allowance should be made for interference with other gases in the atmosphere.

Cost: The cost of a colorimetric gas detector tube varies from less than €1 to a few Euros. A sampling pump may cost hundreds of Euros.

References

Author of the application note:

- Solène LAGADEC, CRAB – Rennes, France

Other organizations: IFIP, ITAVI, IDELE, INRA

Bibliography

Dräger. 2009. Contrôles de l'air, du sol et de l'eau et analyses techniques de gaz. [Sampling the air, soil and water and analyzing gases] Dräger Safety France sas. Livre de poche Tubes Réactifs & CMS 15th edition, 460 p.

Hamon, L., Lagadec, S., Dumont, E., Landrain, B., Landrain, P., et al. 2012. Mise au point d'un biofiltre pour l'amélioration de l'ambiance et des émissions des porcheries. [Developing a biofilter to improve the conditions in and reduce emissions from pighouses] C0974C0229, ADEME, 63 p.

Application note 7 Laboratory assays of ammonium (NH₄⁺) in solution

Scope of application

Quantitative laboratory assays of ammonium in solutions extracted from ammonia traps such as ALPHA badges, denuders (DELTA or COTAG) and impingers (Application notes 1, 2 and 3). Before the assay, the solution may be distilled as for the Kjeldhal method for determining total nitrogen (ISO 11261:1995).

Operating principles

This note covers three methods for determining the concentration of ammonium in solution.

Continuous flow analyzers (CFA)

The ammonium ion (NH₄⁺) is assayed by continuous flow absorption spectroscopy using Berthelot's reaction (Krom, 1980; Figure M7.1). The ammonium in an alkaline solution (1) reacts with hypochlorite (ClO⁻) that has been released by dichloroisocyanurate (2) to form chloramine (NH₂Cl) which then reacts with salicylate on a nitroprusside catalyst (3) at a temperature of between 37°C and 50°C to form a blue-green indophenol which is measured quantitatively by continuous flow spectrometry. The absorbance is measured at a wavelength of between 640 nm and 660 nm. This chemical reaction and the absorbance measurement are managed automatically by the continuous flow analyzer.

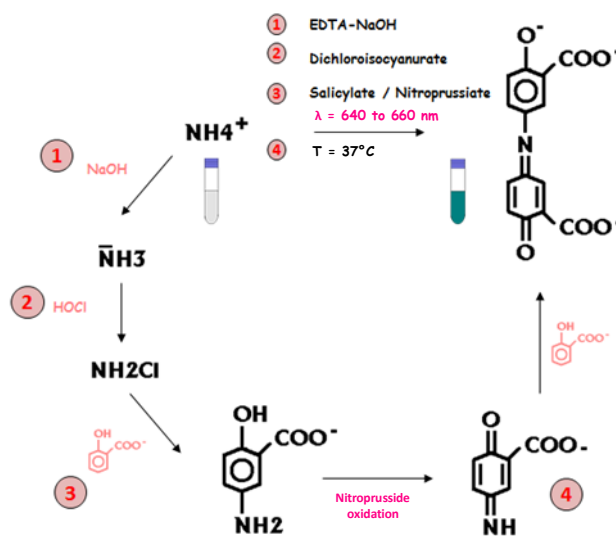

Figure M7.1. Berthelot reaction

The absorbance measurement are managed automatically by the continuous flow analyzer. The intensity of the coloration is proportional to the ammonium concentration (ISO 11732:2005).

Conductivity assay after separation using a semi-permeable membrane

The NH₄⁺ is assayed by measuring the conductivity of deionized water which has absorbed the NH₃ passing through a semi permeable membrane as shown in Figure M7.2.

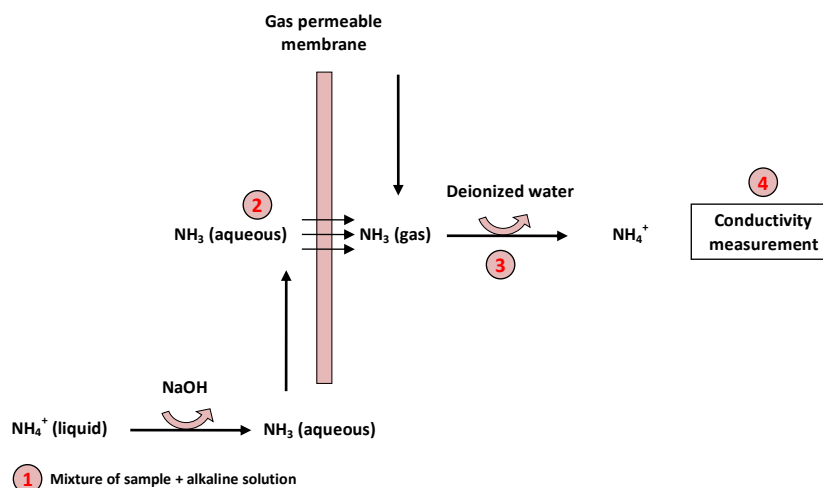

Figure M7.2. Semi permeable membrane separation and conductivity assay

The sample is first mixed with NaOH (1) which converts the acid ammonium ion (NH_4^+) into its conjugate base, ammonia (NH_3). The NH_3 solution then flows across a semi-permeable membrane (impermeable to the fluid but permeable to the gas). As NH_3 can exist in both aqueous and gaseous form at the same time, it diffuses across this membrane (2) and the rest of the sample is eliminated. Deionized water flows across the membrane in the opposite direction, trapping the gaseous NH_3 and reacting with it to re-form the NH_4^+ ions (3). The conductivity of the sample is then measured and compared with that of the deionized water (4). The conductivity is proportional to the concentration of ammonium ions. The samples are taken and measured automatically.

Liquid chromatography

Liquid chromatography is used to separate the various cations of a sample using a stationary and a mobile phase. The stationary phase is a low capacity cation exchange column. Aqueous solutions of mono- or di-acids are usually used as eluents for the mobile phase (ISO 14911:1999). Methanesulfonic acid (MSA) can be used as an eluent, for example. The anions in the sample are eliminated by an anion suppressor before the cation concentration is assayed by measuring the conductivity.

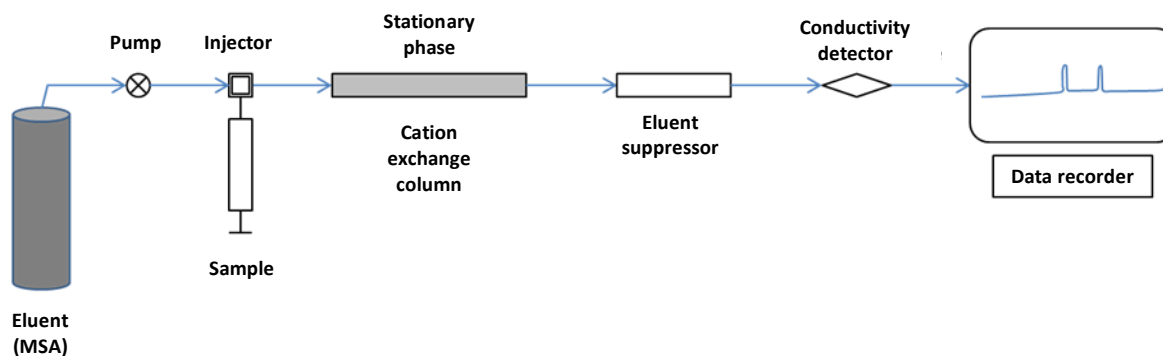

Figure M7.3. Schematic of an ion chromatographic assay method

Implementation

Each of the three methods requires appropriate chemical analysis laboratories with no source of ammonia contamination (first source of uncertainty). The equipment is complex and must be operated by qualified personnel. The analyzer must be calibrated before ammonium can be quantified using the methods described above.

Validation and sources of uncertainty

The performance of the measurement methods must be evaluated by an intra-laboratory validation method (eg: accuracy profile method (NF V 03-110, 2010)). The performance of the methods depends on the conditions in which the methods are implemented. Factors such as the environment, the equipment, the protocols used and the operator have a direct effect on the results obtained. The following comments are taken from the manufacturers' information.

Continuous flow analyzers (CFA)

The precision of this method depends on the type of equipment available on the market and its configuration. However, it should be possible to achieve the following performance:

- Limit of detection: 0.05 mg/L NH_4^+
- Measurement range: 0.05 mg/L to 5 mg/L
- Reproducibility: better than 5%

The results may be unreliable if the reaction mixture does not reach a pH of at least 12.6 after the addition of all the reagents. This happens mainly with very acidic, buffered samples which should be approximately neutralized before analysis.

When the solutions for assay are extracted from ALPHA badges or denuders coated with citric acid (Application notes 2 and 3), the pH of the solution should not cause any problem. However, for impingers (Application note 4), it may be impossible to reach a pH of 12.6. In this case, it is preferable to use one of the other two methods.

Conductivity assay after separation using a semi-permeable membrane

- Limit of detection: 0.005 mg/L NH_4^+
- Measurement range: 0.005 mg/L to 30 mg/L
- Reproducibility: better than 5%

This method is used mainly for measurement in aqueous solution. It is compatible with passive and active diffusion methods and with impingers. There must, however, always be excess NaOH for the first measurement stage to convert the ammonium ion NH_4^+ into ammonia NH_3 .

Liquid chromatography

The following data may vary depending on the configuration (type of eluent and concentration, flow, temperature, and volume injected):

- Limit of detection: 0.1 mg/L NH_4^+
- Measurement range: 0.1 mg/L to 5 mg/L
- Reproducibility: better than 5%

This measurement method may be used for any of the three NH_3 trapping methods. However, the results may be unreliable if the absorbing medium has excessively high concentration of cations.

Advantages and limitations

Continuous flow analyzers (CFA)

The advantage of this method is its sensitivity and the measurement speed (between 40 and 60 samples per hour depending on the type of equipment). It is robust but there may be problems of selectivity. There may be significant measurement bias if no precautions are taken to ensure the purification of the sample before measurement (eg: by dialysis). When the ammonia traps are exposed, they may trap other compounds that may interfere with the Berthelot reaction and bias the measurements.

Conductivity assay after separation using a semi-permeable membrane

This is a very specific method which is relatively easy and cheap to implement. However, it requires qualified chemical analysis personnel. Its sensitivity makes it less robust than colorimetry and the temperature is the factor that has the greatest effect on the measurement. There are automatic corrections for this. Another advantage of this measurement method is that only small samples are required (less than 1 mL). The time taken to assay a sample depends on the concentration and is relatively long. Only 5 to 12 samples can be assayed per hour using this method.

Liquid chromatography

This method may be an alternative to colorimetry if this proves to be unsuitable. Although it is more costly to use and takes much longer (4 samples per hour), it can be used to assay all the major cations at the same time as ammonium.

Cost: The equipment is fairly expensive and the price depends on the supplier. The price is around €20,000 to €30,000 for the minimum configurations. The cost of an analysis varies from a few Euros to ten to twenty Euros depending on the laboratory.

References

Authors of the application note:

- Céline DECUQ, INRA, UMR EGC – Thiverval-Grignon, France
- Yannick FAUVEL, INRA, UMR SAS – Rennes, France

Other organizations:

- Center for Ecology and Hydrology (CEH), Edinburgh, United Kingdom; Sim Tang,
- The Energy Research Centre the Netherlands (ECN), The Netherlands; Renee Otjes

Bibliography

- Krom, M.D. 1980. Spectrophotometric determination of ammonia - a study of a modified berthelot reaction using salicylate and dichloroisocyanurate. *Analyst*. 105 (1249), 305-316 10.1039/an9800500305
- ISO 11732:2005. Water quality -- Determination of ammonium nitrogen -- Method by flow analysis (CFA and FIA) and spectrometric detection.
- ISO 14911:1999. Water quality - Determination of dissolved Li⁺, Na⁺, NH₄⁺, K⁺, Mn²⁺, Ca²⁺, Mg²⁺, Sr²⁺ and Ba²⁺ using ion chromatography. Method for water and waste water.
- ISO 11261:1995. Soil quality - Determination of total nitrogen - Modified Kjeldahl method.
- NF V 03-110:2010. Analysis of agri-foodstuffs - Protocol of characterization for the validation of a quantitative method of analysis by construction of an accuracy profile.

Application note 8 Measuring the concentration of CH₄, CO₂ and N₂O by gas chromatography

Scope of application

Gas chromatography can be used to determine the concentrations of certain greenhouse gases (GHG) - methane (CH₄), carbon dioxide (CO₂) and nitrous oxide (N₂O) - in air samples from livestock buildings, manure storage systems, land where manure has been spread, fields with crops, treatment processes, etc. However, it must be used with an appropriate sampling method to give representative measurements. The detection thresholds are measured in ppm for CO₂ and ppb for CH₄ and N₂O.

Operating principles

Gas chromatography is used for gaseous compounds or compounds that may be vaporized. A gas chromatograph separates the components in the sample and measures the concentrations of the compounds separated. There are 4 basic items of equipment: an injector, the column, the oven surrounding the column and the detector (Figure M8.1). The sample is vaporized in the injector and swept by the carrier gas through the heated column. The column separates the various compounds depending on their polarity and their boiling point. The compounds that have been separated are identified and quantified by the detector. In the configuration shown in Figure M8.1, a flame ionization detector (FID) is used to quantify methane and carbon dioxide and an electron capture detector (ECD) is used for nitrous oxide. Other detectors such as thermal conductivity detectors (TCD) and mass spectrometers (MS) are also often used (Table M8.1 and Arnold *et al.*, 2001; Hu *et al.*, 2014; Lofffield *et al.*, 1997).

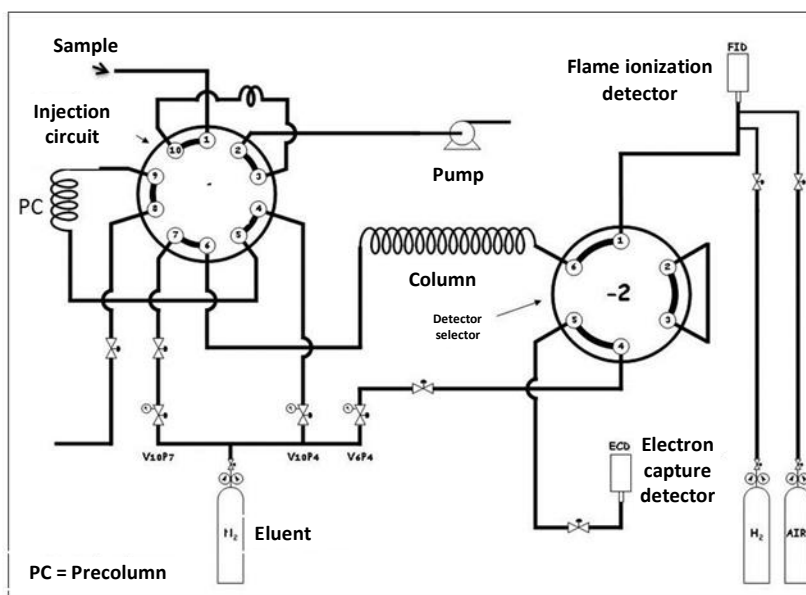

Figure M8.1. Air handling train of a chromatograph with an FID to quantify CH₄ and CO₂ and an ECD for N₂O (Godbout *et al.*, 2012)

Table M8.1. Main gas chromatographic detectors used to detect greenhouse gases and reactive nitrogen species (Lagadec *et al.* 2014)

Detector	Operating principle	Gases detected, limitations
Thermal conductivity detector (TCD)	Differential measurement of the resistivity of two filaments in contact with the gas to be assayed and the carrier gas	Any type of gas, simple and robust
Flame ionization detector (FID)	A hydrogen flame ionizes the molecules in the gas to be assayed; the ions are collected in an electric field	Suitable for organic compounds. Cannot be used to assay permanent gases
Electron capture detector (ECD)	The carrier gas is ionized by beta particles. When electronegative molecules pass through the detector, they absorb the free electrons, reducing the ionization current	Electronegative molecules such as halogen compounds and N₂O
Mass spectrometer (MS)	The molecules of the gas to be assayed are ionized and separated according to their mass-to-charge ratio (m/z). The ion streams are converted into an electrical signal	All types of compound

Equipment required

- Injection system: the air sample to be assayed can be injected manually using a syringe or using an automated injection system
- Precolumn for injecting a large volume and for protecting the assay column from compounds that would affect it
- Column within which the various compounds in the injected sample will be separated
- Chromatograph with one or more detectors
- Carrier gas: usually N₂ (<100 ppb impurities)
- Hydrogen generator
- Gas valve
- Compressed air

Implementation

The assays are carried out in operating conditions (oven temperature, carrier gas flow, detector temperature) defined by the operator. These vary from laboratory to laboratory and depend on the analyses and reference gases that may or may not be defined by standard procedures (see Bibliography). The carrier gas is supplied at constant flow (ml.min⁻¹). Software supplied with the equipment is usually used to operate the chromatograph and analyze the results.

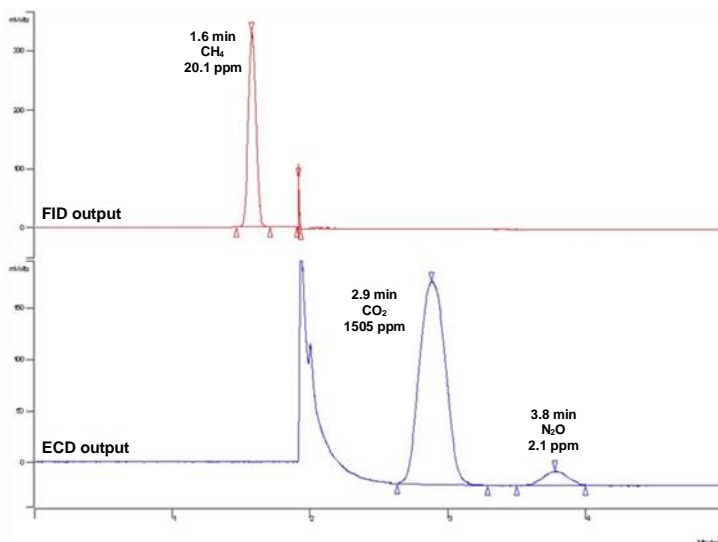

Figure M8.2. Example of a chromatogram for a greenhouse gas reference mixture (CH₄, N₂O and CO₂) (Godbout *et al.*, 2012)

The area below the peaks is proportional to the concentration of the corresponding gas, in the calibration range considered (L. Loyon, personal communication).

The area below the peaks is proportional to the concentration of the corresponding gas, in the calibration range considered (L. Loyon, personal communication). The area below the peaks is proportional to the concentration of the corresponding gas, in the calibration range considered (L. Loyon, personal communication).

The gas chromatograph is usually calibrated at the start of each analysis run by injecting samples of a reference gas (cylinder/bottle of gas certified by the manufacturer or diluted samples of a certified solution). The system must be calibrated using reference gases that cover the expected concentration range for the samples to be analyzed. The calibration curves of the chromatograph are defined with at least one calibration point for each gas analyzed as the detectors used have a linear response within the ranges of concentrations usually encountered. Calibration is carried out automatically and regularly with

Validation and sources of uncertainty

The calibration analyses allow the long term performance of the chromatograph to be documented and check the quality of the data obtained. Statistical analysis of the results can estimate the overall precision of the analyses. The following table gives typical examples of the results obtained for the calibration analyses.

Table M8.2. Analysis results using a reference gas and a sample of ambient air

	Reference gas			Ambient air		
	CH ₄	CO ₂	N ₂ O	CH ₄	CO ₂	N ₂ O
Mean value (ppmv)	20.5	1510	2.1	2.0	595	0.32
Relative precision¹ (%)	1.0	3.8	5.8	5.8	4.6	16
Maximum value (ppmv)	20.7	1589	2.3	2.4	638	0.41
Minimum value (ppmv)	20.1	1403	1.9	1.9	541	0.21

The reference gas analyses show the long term stability and high precision that can be obtained. In the case shown, the electron capture detector for nitrous oxide (N₂O) is less precise for determining low concentrations in the ambient air as the calibration is based on higher concentrations. The measurement precision for CH₄ and CO₂ using a flame ionization detector is more stable.

¹ standard deviation for a series of data, divided by the mean of the series of data multiplied by 100

Advantages and limitations

Advantages: Gas chromatography is probably one of the most commonly used methods for quantifying components in the air. The technique is well known and the applications are well understood by manufacturers of analytical equipment. Depending on the chromatographic system and the conditions of use, the limits of detection are of the order of 50 ppb for CH₄, 50 ppm for CO₂ and 30 ppb for N₂O and the maximum concentrations that can be measured are about 100 ppm for N₂O and over 5000 ppm for CH₄ and CO₂.

Limitations: This system may be used in the field for continuous measurements but has logistical limitations and high operating costs (bottles of carrier gas, reference gases, daily intervention by operators and maintenance of ambient conditions). Each instrument has its own limits of detection which should be assessed before purchase.

Costs: Equipment is readily available on the market for the analyses described in this application note at a cost of less than €30,000. The technique is simple and proven and can be used to quantify the three greenhouse gases at the same time.

References

Authors of the application note:

- Stéphane Godbout, Jean-Pierre Larouche and Lise Potvin, IRDA – Quebec, Canada
- Laurence Loyon, IRSTEA – Rennes, France

Other organizations: LNE

Bibliography

- Arnold, S.L., Parkin, T.B., Doran, J.W., Eghball, B., Mosier, A.R. 2001. Automated gas sampling system for laboratory analysis of CH₄ and N₂O. *Communications in Soil Science and Plant Analysis*. 32 (17-18), 2795-2807 10.1081/css-120000962
- Godbout, S., Pelletier, F., Larouche, J.P., Belzile, M., Feddes, J.J.R., et al. 2012. Greenhouse gas emissions from non-cattle confinement buildings: monitoring, emission factors and mitigation. 5. In: Liu, G. (Ed.), *Greenhouse Gases - Emission, Measurement and Management*. InTech pp. 101-126
- Hu, E., Babcock, E.L., Bialkowski, S.E., Jones, S.B., Tuller, M. 2014. Methods and Techniques for Measuring Gas Emissions from Agricultural and Animal Feeding Operations. *Critical Reviews in Analytical Chemistry*. 44 (3), 200-219 10.1080/10408347.2013.843055
- Lagadec S. et al. 2014. Mise au point d'un biofiltre pour l'amélioration de l'ambiance et des émissions des porcheries (Developing a biofilter to improve the conditions and reduce emissions from pig houses). Final report Ademe 84p.
- Lofffield, N., Flessa, H., Augustin, J., Beese, F. 1997. Automated gas chromatographic system for rapid analysis of the atmospheric trace gases methane, carbon dioxide, and nitrous oxide. *Journal of Environmental Quality*. 26 (2), 560-564

Application note 9 Measuring gas concentrations by chemiluminescence

Scope of application

Routine analysis of atmospheric gas compounds by chemiluminescence began in the 1970s, with the measurement of NO, NO₂ and terpenes. The measurement of NO by chemiluminescence is the basis for the measurement of many nitrogen compounds after capture in gaseous or liquid form and catalytic transformation (Navas *et al.*, 1997): gaseous ammonia (NH₃), nitric acid (HNO₃) and nitrous acid (HNO₂), nitrates, peroxyacetyl nitrate (PAN) and total nitrogen. By extension, organic compounds can also be measured by chemiluminescence (Marley and Gaffney, 1998; Motyka *et al.*, 2007; Varcoe, 1977), as can CO₂ (Lan and Mottola, 1996). Two relatively recent articles have reviewed the state of the art (Toda and Dasgupta, 2008; Zhang *et al.*, 2005).

Certain chemiluminescence measurement methods are particularly useful when coupled with eddy-covariance flow measurements (Application note 31) as they allow high speed data acquisition. This is the case for measurements based on chemiluminescence of NO with ozone or ozone on a solid substrate (Ammann *et al.*, 2012; Bruemmer *et al.*, 2013; Eugster and Hesterberg, 1996; Loubet *et al.*, 2011). There are also NO₂ analyzers based on chemiluminescence with luminol (Gaffney *et al.*, 1998; Marley *et al.*, 2004).

Operating principles

Chemiluminescence is the emission of light as a result of a chemical reaction. The light is emitted when electrons fall from an excited state, releasing energy. The effect has been known since the end of the 19th century, in particular for ozone (since 1896), and most analysis methods use chemiluminescence with ozone. This can be used to detect NO and any nitrogen compound that can be degraded to NO. There are some other oxidants (eg: H₂O₂) which are also strongly chemiluminescent. Any chemical reaction which emits light can be used. For NO and O₃:

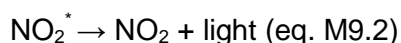
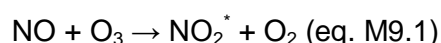

The light is emitted at a particular wavelength that depends on the compound (in this case NO₂^{*}). A sensitive photomultiplier is used to count the number of photons emitted which is proportional to the number of NO molecules that have reacted with the ozone.

A well-established process uses a molybdenum catalyst heated to 350°C to measure NO₂ concentrations by converting NO₂ to NO but this is not specific to NO₂ and other nitrogen compounds (PAN, HONO, HNO₃ and organic compounds containing nitrogen) can be converted in the same way (Dari-Salisburgo *et al.*, 2009; Parrish and Fehsenfeld, 2000). Photolytic converters are now available and the cost has plummeted with the arrival of powerful light-emitting diodes (Pollack *et al.*, 2010).

For measuring ammonia, a stainless steel catalyst heated to 800°C is used in standard analyzers (Mennen *et al.*, 1996). Recently a catalyst has been developed that can convert any nitrogen compound into NO (Ammann *et al.*, 2012; Bruemmer *et al.*, 2013; Marx *et al.*, 2012).

Equipment required

Chemiluminescence is a standard method for measuring NO, NO₂ and NH₃. There are many analyzers on the market for the range of concentrations found in the atmosphere. A schematic of an analyzer is given in Figure M9.1. To take measurements, a shelter and a stable power supply (a simple rectifier could be used but a regulated supply would be better) are required. It is recommended that the sampling trains should be heated to a few degrees above ambient temperature and should be as short as possible (if more than a few meters long, a secondary pump should be used). Only PFA should be used. Cylinders of reference gases for testing (pure, with NO₂ and with NH₃), an NO reference gas and a large stable source of ozone are also required. In addition, a data acquisition system is required with the analyzer itself or as a remote unit.

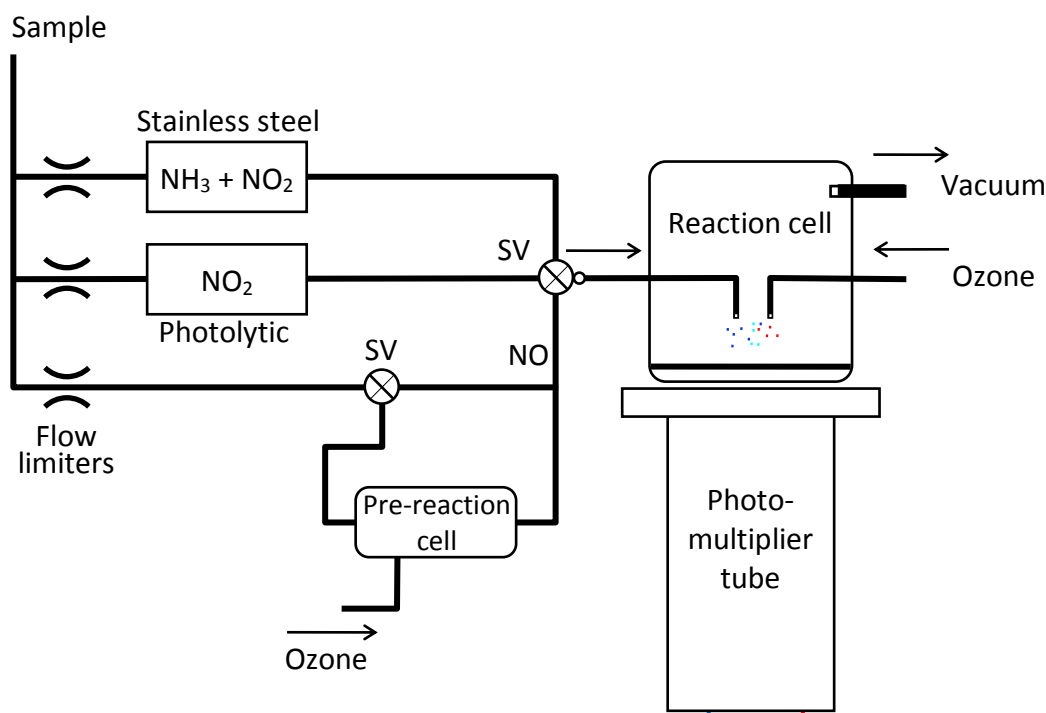

Figure M9.1. Schematic of a chemiluminescence NH₃-NO₂-NO analyzer.

The air being sampled passes in turn (1) through the stainless steel converter which converts a fraction of the ammonia and NO₂ into NO, or (2) through the photolytic converter which converts a fraction of the NO₂ or (3) directly into the NO input line without converter. The air sample then passes into the reaction chamber where the NO reacts with the ozone and emits light (eqs. M9.1 and M9.2) which is captured by the photomultiplier tube (PMT). The PMT converts the light signal into current. The NO₂, and NH₃ concentrations are estimated by the increased concentration over the direct input taking account of the converter yields. The prechamber is used to measure residual interference at regular intervals by reacting the NO with the ozone before they pass into the reaction chamber. The solenoid valves (SV) are used to control the airflow. The flow limiters ensure that the flow in each channel is identical.

Implementation

Although the operating principle is simple, many precautions have to be taken when using the system:

- the photomultiplier tube must be cooled to minimize noise and increase sensitivity
- the pressure, flow and temperature in the measuring chamber must be regulated as they affect the reaction rate (eq. M9.1)

- the relative humidity must be monitored as water vapor absorbs the radiation emitted (eq. M9.2). The detector cell should be at low pressure to limit absorption as well as quenching which limits the luminescence.

To ensure that the operating conditions are suitable, the analyzer usually needs to be set up and run for about one day in the place where the measurements will be taken so that it can stabilize. The system should be calibrated about once a month for NO, NO₂ and ammonia and the zero offset may need to be verified more frequently (once a week), especially if the ambient temperature is not controlled. Reference gases at a few hundred ppb can be used to measure NO₂. The data is acquired by the analyzer, by a data acquisition unit or by a computer.

Validation and sources of uncertainty

For measuring NO₂, Chemiluminescence with molybdenum converters suffers from far stronger interference from peroxyacetyl nitrate (PAN) and ozone than laser absorption spectroscopy (Dunlea *et al.*, 2007) (Application note 12). For measuring ammonia, chemiluminescence measurements were shown to be well correlated with laser absorption spectroscopy, except during certain very wet periods (Ellis *et al.*, 2010).

The sources of uncertainty of the method are related essentially to interference with other gases and to quenching. To overcome this problem, most of the analyzers have a prechamber to estimate interference. Another major source of uncertainty is the zero drift which may be caused by changes in the temperature of the photomultiplier tube and gain drift which is often due to a problem with the measurement pressure (pump malfunction, leaks, etc). These problems can be detected by checking the zero and a point on the slope once a week.

Advantages and limitations

Advantages: The main advantages of this method are its sensitivity (a few ppt for NO and 1 ppb for NH₃) and its response time (down to 0.1 s).

Limitations: These analyzers need to be calibrated relatively regularly, in particular to determine the yield of the converters. The method is subject to interference, which may be problematic for low concentrations in rural areas.

Costs: As the technology is well established, analyzers are fairly low cost (of the order of €15,000 to €20,000). However, the most precise analyzers are expensive (€60,000). A calibration system is also required (€5,000 to €10,000) or else the analyzer must be calibrated by a certified organism. In use, these analyzers require reference gases and consumables (filters, pump kits), and they need to be serviced once a year (around €500 per year).

References

Authors of the application note:

- Benjamin LOUBET, INRA, UMR EGC - Thiverval-Grignon, France

Other organizations: INERIS, Certified air quality monitoring organizations

Bibliography

- Ammann, C., Wolff, V., Marx, O., Bruemmer, C., Neftel, A. 2012. Measuring the biosphere-atmosphere exchange of total reactive nitrogen by eddy covariance. *Biogeosciences*. 9 (11), 4247-4261 10.5194/bg-9-4247-2012
- Bruemmer, C., Marx, O., Kutsch, W., Ammann, C., Wolff, V., et al. 2013. Fluxes of total reactive atmospheric nitrogen (Sigma N-r) using eddy covariance above arable land. *Tellus Series B-Chemical and Physical Meteorology*. 65 10.3402/tellusb.v65i0.19770
- Dari-Salisburgo, C., Di Carlo, P., Giammaria, F., Kajii, Y., D'Altorio, A. 2009. Laser induced fluorescence instrument for NO₂ measurements: Observations at a central Italy background site. *Atmospheric Environment*. 43 (4), 970-977 10.1016/j.atmosenv.2008.10.037
- Dunlea, E.J., Herndon, S.C., Nelson, D.D., Volkamer, R.M., San Martini, F., et al. 2007. Evaluation of nitrogen dioxide chemiluminescence monitors in a polluted urban environment. *Atmospheric Chemistry and Physics*. 7 (10), 2691-2704
- Ellis, R.A., Murphy, J.G., Pattey, E., van Haarlem, R., O'Brien, J.M., et al. 2010. Characterizing a Quantum Cascade Tunable Infrared Laser Differential Absorption Spectrometer (QC-TILDAS) for measurements of atmospheric ammonia. *Atmospheric Measurement Techniques*. 3 (2), 397-406
- Eugster, W., Hesterberg, R. 1996. Transfer resistances of NO₂ determined from eddy correlation flux measurements over a litter meadow at a rural site on the Swiss plateau. *Atmospheric Environment*. 30 (8), 1247-1254 10.1016/1352-2310(95)00418-1
- Gaffney, J.S., Bornick, R.M., Chen, Y.H., Marley, N.A. 1998. Capillary gas chromatographic analysis of nitrogen dioxide and PANs with luminol chemiluminescent detection. *Atmospheric Environment*. 32 (8), 1445-1454 10.1016/s1352-2310(97)00098-8
- Lan, Z.H., Mottola, H.A. 1996. Determination of CO₂(g) by enhancement of luminol-cobalt(II) phthalocyanine chemiluminescence: Analysis of atmospheric air and human breath. *Analytica Chimica Acta*. 329 (3), 305-310 10.1016/0003-2670(96)00113-4
- Loubet, B., Stella, P., Fanucci, O., N., M. 2011. Evaluation of a modified disjunct eddy covariance method for estimating the fluxes divergence of nitrogen oxides and ozone. Nitrogen & Global Change: Key findings – future challenges. Edinburgh (GBR) 11-15/04/2011. 2 p.
- Marley, N.A., Gaffney, J.S. 1998. A comparison of flame ionization and ozone chemiluminescence for the determination of atmospheric hydrocarbons. *Atmospheric Environment*. 32 (8), 1435-1444 10.1016/s1352-2310(97)00142-8
- Marley, N.A., Gaffney, J.S., White, R.V., Rodriguez-Cuadra, L., Herndon, S.E., et al. 2004. Fast gas chromatography with luminol chemiluminescence detection for the simultaneous determination of nitrogen dioxide and peroxyacetyl nitrate in the atmosphere. *Review of Scientific Instruments*. 75 (11), 4595-4605 10.1063/1.1805271
- Marx, O., Bruemmer, C., Ammann, C., Wolff, V., Freibauer, A. 2012. TRANC - a novel fast-response converter to measure total reactive atmospheric nitrogen. *Atmospheric Measurement Techniques*. 5 (5), 1045-1057 10.5194/amt-5-1045-2012
- Mennen, M.G., VanElzakker, B.G., VanPutten, E.M., Uiterwijk, J.W., Regts, T.A., et al. 1996. Evaluation of automatic ammonia monitors for application in an air quality monitoring network. *Atmospheric Environment*. 30 (19), 3239-3256 10.1016/1352-2310(96)00079-9

- Motyka, K., Onjia, A., Mikuska, P., Vecera, Z. 2007. Flow-injection chemiluminescence determination of formaldehyde in water. *Talanta*. 71 (2), 900-905
10.1016/j.talanta.2006.05.078
- Navas, M.J., Jimenez, A.M., Galan, G. 1997. Air analysis: Determination of nitrogen compounds by chemiluminescence. *Atmospheric Environment*. 31 (21), 3603-3608
10.1016/s1352-2310(97)00153-2
- Parrish, D.D., Fehsenfeld, F.C. 2000. Methods for gas-phase measurements of ozone, ozone precursors and aerosol precursors. *Atmospheric Environment*. 34 (12-14), 1921-1957
10.1016/s1352-2310(99)00454-9
- Pollack, I.B., Lerner, B.M., Ryerson, T.B. 2010. Evaluation of ultraviolet light-emitting diodes for detection of atmospheric NO₂ by photolysis - chemiluminescence. *Journal of Atmospheric Chemistry*. 65 (2-3), 111-125
10.1007/s10874-011-9184-3
- Toda, K., Dasgupta, P.K. 2008. New applications of chemiluminescence for selective gas analysis. *Chemical Engineering Communications*. 195 (2), 82-97
10.1080/00986440701569150
- Varcoe, F.T. 1977. Atmospheric Terpene Analysis Using a Gas-Chromatographic Chemiluminescence Technique. *Abstracts of Papers of the American Chemical Society*. 173 (Mar20), 14-14
- Zhang, Z.Y., Zhang, S.C., Zhang, X.R. 2005. Recent developments and applications of chemiluminescence sensors. *Analytica Chimica Acta*. 541 (1-2), 37-47
10.1016/j.aca.2004.11.069

Application note 10 Fourier transform and photoacoustic infrared absorption spectroscopy

Scope of application

Infrared absorption spectroscopy is used to analyze gas samples from various agricultural sources including livestock buildings, manure storage systems, cultivated fields, agricultural product treatment processes, etc. The main gases that can be measured are methane (CH₄), carbon monoxide (CO), carbon dioxide (CO₂), ammonia (NH₃), nitrous oxide (N₂O), nitrogen monoxide (NO), nitrogen dioxide (NO₂), sulfur dioxide (SO₂), hydrogen chloride (HCl) and water (H₂O). This method can be used to analyze the concentrations of several gases simultaneously.

Operating principle

Infrared (IR) absorption spectroscopy measures the absorption of infrared radiation by a gaseous mixture. It detects the characteristic resonances of the chemical functions present in the gas, each type of chemical bond having its own set of IR absorption bands resulting from these resonances. Two main techniques are used for measuring emissions from farms using absorption spectroscopy: Fourier transform infrared spectroscopy (FT-IR) and photoacoustic infrared spectroscopy (IR-PAS).

FT-IR spectroscopy is based on the use of an interferometer which uses interference between two beams to produce a modulated beam. The modulated beam passes through the chamber with the sample to be measured where selective absorption takes place. The beam then passes into a detector which transforms the amplitude into an electric signal which is processed by Fourier transform to generate the spectrum characteristic of the sample.

Photoacoustic infrared spectroscopy excites a sample with a pulsed monochromatic light beam. The wavelengths characteristic of the target gases are selected using optical filters. Some molecules in the sample absorb part of the light energy and enter an excited state and this energy is released, when they relax, as an acoustic signal which is captured by a microphone.

Equipment required

For FT-IR spectroscopy:

A schematic of the operating principle of a Fourier transform infrared spectroscopy analysis system is given in Figure M10.1 which shows the equipment required for this method.

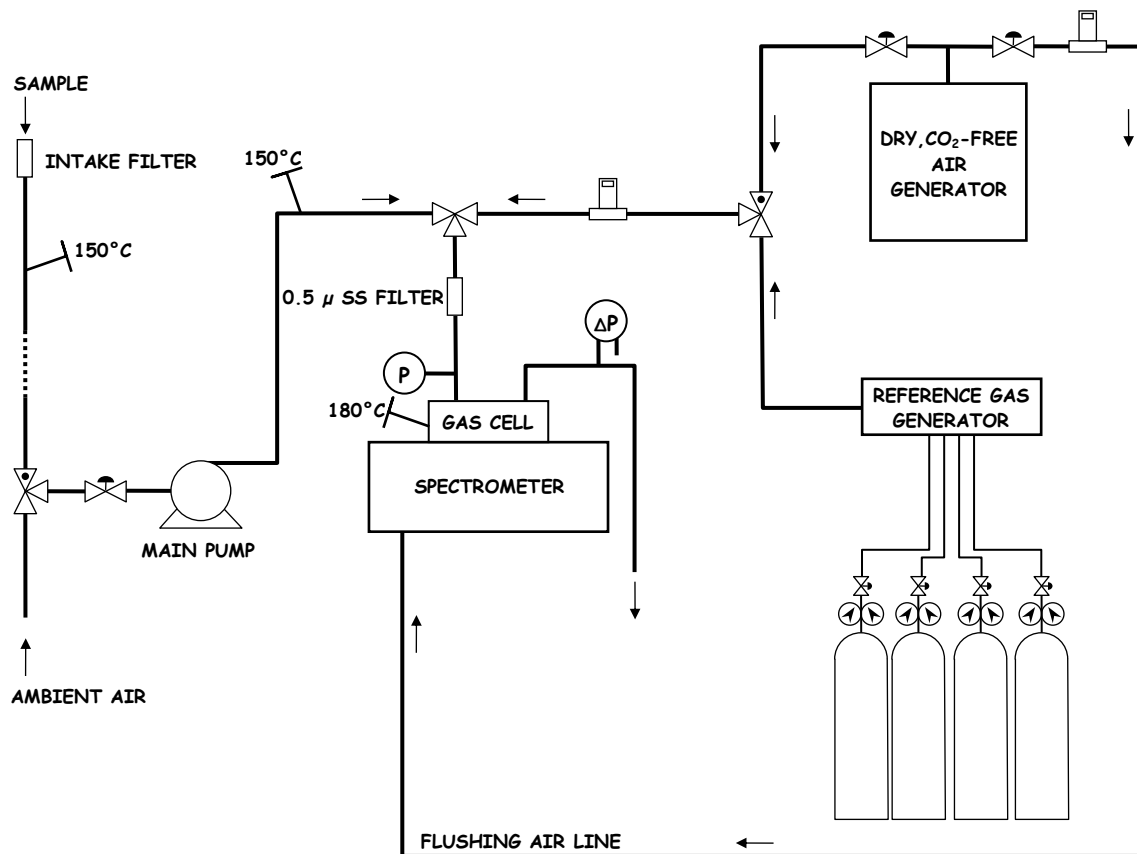

Figure M10.1. Schematic showing a Fourier transform infrared spectroscopy system for analyzing agricultural emissions

For photoacoustic IR spectroscopy:

- A photoacoustic IR analyzer
- Reference gas bottles (for checking the calibration, the mixtures to be used depend on the gases targeted by the system and the expected concentration ranges)
- Sampling train heating system
- A computer for recording data if samples are to be taken over several days

Implementation

Setup for an FT-IR spectroscopy system

- There should be a flow of about 5 liters per minute for taking the samples and transporting the air sampled to the analyzers
- An intake strainer, for example a sintered stainless steel filter, 0.5 μm pore size
- Adequate purging of the various components in the analysis chain, for example using dry, CO₂ free air
- Rigorous, regular calibration of the analyzers using a reference gas
- Continuous monitoring of the temperature close to the instruments and the speed of the air through the circuit

Multiple gas infrared analyzers suitable for detecting several target gases from livestock production are available. These analyzers can be calibrated to cover the ranges of emission concentrations from livestock buildings and manure storage. They are portable and are suitable for use in difficult conditions (ammonia, damp, dust). When setting up this

equipment, it is important to site it in a place where the temperature variations are limited, especially if the concentrations to be measured are low. It is also essential to heat the sampling trains to prevent the formation of condensation which might damage the equipment.

Validation and sources of uncertainty

Test gases with known concentrations are used to check the response of the spectrometer and the whole of the sampling train. The test gases may include ambient air, dry, CO₂ free air, zero nitrogen gases and reference gases with certified concentrations of the target gases. The reference gases are usually blended to order by the suppliers at concentrations close to those that will be measured in the samples to be analyzed. The reference gases may contain one or more target gases as required or depending on the compatibility of the gases with each other. INRA also has a unit for generating test gases (NH₃, CO₂, CH₄, N₂O) with various concentrations (Hassouna et al, 2013).

Calibration analyses can also be used to check the quality of the measurements obtained and to record the long term drift of the spectrometer, the sampling system and sampling processing system. Statistical analyses of the results are used to estimate the overall precision of the measurements.

Advantages and limitations

Advantages

With current improvements to the spectrum analysis software, Fourier transform infrared spectroscopy has become a very effective gas analysis technique. Furthermore, as the basic technology is well established and fairly simple, the equipment is robust, relatively easy to use and, by selecting the various items of equipment carefully, the concentrations over a range from 1 ppm to several percent can be measured easily.

Photoacoustic infrared spectroscopy is a method that is both very stable (very little drift) and easy to use. This method is commonly used in livestock buildings, as the equipment available is able to detect several target gases at the same time and has a relatively short response time (about one minute).

Limitations: The greatest limitation for infrared spectroscopy is the overlap between the absorption spectra of different molecular species. Emissions from farms may contain substantial quantities of compounds that are not targeted in the air samples, in particular from livestock buildings, and these parasitic compounds may interfere with the measurement of the target gases (Hassouna *et al.*, 2013; Zhao *et al.*, 2012). Spectrum analysis software has been developed to reduce the effect of parasitic absorption bands. This new software has become the most important part of an infrared spectrometry gas analysis system. However, it is not possible to compensate accurately for parasitics, which may lead to the concentrations of target gases being over or underestimated. The optical filters in the equipment must be selected to limit these parasitics and correct for the most harmful.

Costs: a photoacoustic infrared analyzer costs between €30,000 and €50,000 (depending on the number of gases to be measured). An FTIR analyzer will also cost tens of thousands of Euros.

References

Authors of the application note:

- Stéphane Godbout, Jean-Pierre Larouche and Lise Potvin, IRDA – Quebec, Canada
- Mélynda Hassouna, INRA, UMR SAS – Rennes, France

Bibliography

- Godbout, S., Pelletier, F., Larouche, J.P., Belzile, M., Feddes, J.J.R., et al. 2012. Greenhouse gas emissions from non-cattle confinement buildings: monitoring, emission factors and mitigation. 5. In: Liu, G. (Ed.), *Greenhouse Gases - Emission, Measurement and Management*. InTech pp. 101-126
- Hassouna, M., Robin, P., Charpiot, A., Edouard, N., Méda, B. 2013. Infrared photoacoustic spectroscopy in animal houses: Effect of non-compensated interferences on ammonia, nitrous oxide and methane air concentrations. *Biosystems Engineering*. 114 (3), 318-326 10.1016/j.biosystemseng.2012.12.011
- Hassouna, M., B. Grandpierre, P. Robin, and N. Guingand. "A Test-Bench for Infrared Photoacoustic Analyzers Used to Measure Gas Emissions from Animal Houses and Manure Storage. *ISAH Conference*, Nanjing, China, 2013.
- Zhao, Y.J., Pan, Y.E., Rutherford, J., Mitloehner, F.M. 2012. Estimation of the Interference in Multi-Gas Measurements Using Infrared Photoacoustic Analyzers. *Atmosphere*. 3 (2), 246-265 10.3390/atmos3020246

Application note 11 Differential optical absorption spectroscopy (DOAS)

Scope of application

Differential optical absorption spectroscopy (DOAS) is used to measure gaseous concentrations over an optical path in the atmosphere. Used together with airflow characterization methods (eg: tracer gas, inverse modeling, aerodynamic gradients), it can estimate emissions from livestock buildings, manure storage and fields (Hu *et al.*, 2014; Volten *et al.*, 2012). It can be used for greenhouse gases (CO₂, N₂O, H₂O) as well as reactive species such as NH₃, NO, SO₂, NO₂ and O₃.

Operating principles

Measurement by DOAS is based on the absorption of light at wavelengths that are characteristic of the target gases. Extending the Beer-Lambert law, the intensity of the light detected at a particular wavelength depends on the concentration of the target gas:

$$I_{\lambda} = I_{0,\lambda} \times e^{-(\alpha_{i,\lambda} \times C_i + \epsilon_M + \epsilon_R) \times L} + S(\lambda) \quad (\text{eq. M11.1})$$

where I_{λ} and $I_{0,\lambda}$ (W.sr⁻¹) are the intensity of radiation of the wavelength λ incident on the receiver and emitted by the radiation source respectively,

$\alpha_{i,\lambda}$ (m².μg⁻¹) is the absorption cross-section of gas i at wavelength λ ,

C_i (μg.m⁻³) is the concentration of the gas in the gaseous compound,

L (m) is the length of the optical path and

ϵ_M and ϵ_R are the extinction coefficients per unit of the optical path for particles comparable to the wavelength of the light (Mie scattering) and for air molecules and smaller particles (Rayleigh scattering).

Account should also be taken of Rayleigh scattering of solar radiation $S(\lambda)$ which causes a slight increase in the radiation measured by the detector.

More particularly, the method is based on the analysis of the rapidly varying structure of the absorption spectrum. Differentiation of equation M11.1 with respect to the absorption cross-section $\alpha_{i,\lambda}$ defines the initial differential intensity $I_{0,\lambda}'$ corresponding to the initial intensity $I_{0,\lambda}$ after attenuation by Rayleigh scattering, Mie scattering and the low frequency component of the absorption coefficient (Figure M11.1). Account is also taken of the Rayleigh scattering of solar radiation and the attenuation in the optical system. The spectrum is usually analyzed by

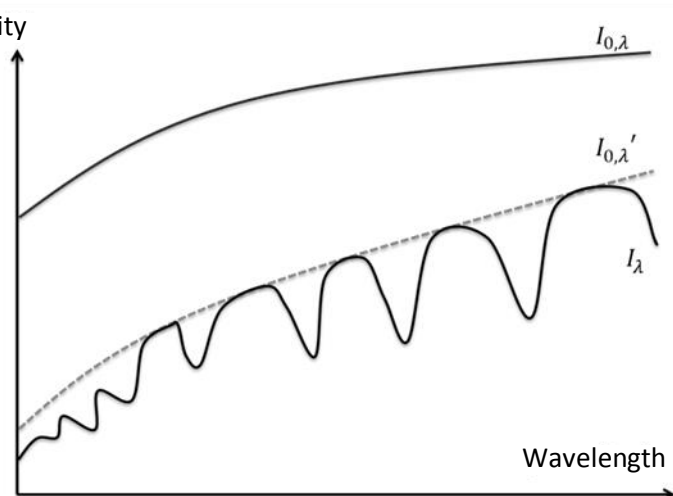

Figure M11.1. Intensities I_{λ} , $I_{0,\lambda}$ and $I_{0,\lambda}'$ in an absorption spectrum (EN 16253:2013)

mathematical modeling of I_λ , using the equation:

$$I_\lambda = P(\lambda) \times e^{-\sum -\alpha'_{i,\lambda} \times C_i \times L} \text{ (eq. M11.2)}$$

where

$P(\lambda)$ is an polynomial describing $I'_{0,\lambda}$ and

$\alpha'_{i,\lambda}$ is the differential (the rapidly varying component of the absorption) cross-section of gas i .

The mean concentration of gas C_i in the optical path is obtained by adjusting the model to the measured spectrum. DOAS can, therefore, be used to overcome the impossibility of determining the initial radiation intensity $I'_{0,\lambda}$ and take account of differential light densities of the gases studied for the whole of the spectral domain selected for analysis.

The radiation spectrum studied may vary from near ultraviolet radiation to near infrared radiation (from about 200 nm to 2500 nm). DOAS is often used in the ultra-violet and visible light ranges as the gas absorption properties in these ranges are not very sensitive to temperature and atmospheric pressure conditions. For example, ammonia can be detected within a band from 200 nm to 230 nm.

Equipment and implementation

Measurements require a DOAS spectrometer with a light source and a telescope to collect light. For passive DOAS the light source is the sun, for active DOAS an artificial light source is used (Figure M11.2).

When taking a measurement, the length of the optical path, the atmospheric conditions (temperature, pressure, and wind) and data relating to the status of the instrument must be recorded. The raw atmospheric spectrum must be corrected for the thermal radiation, electronic bias and background due to solar radiation (for measurements at wavelengths greater than 290 nm). The spectra for the reference gases must also be known for calibration.

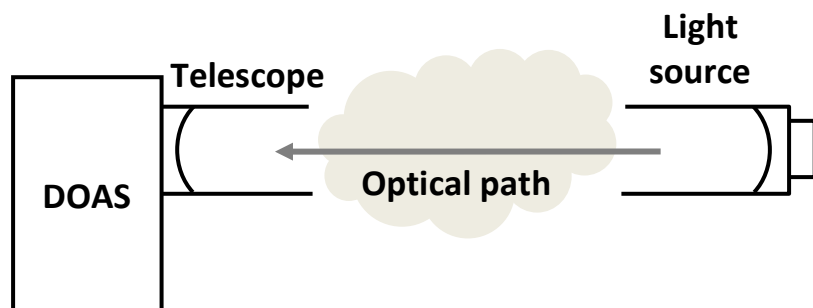

Figure M11.2. Bistatic open path active DOAS system

In a bistatic system, the source and the detector are fixed at opposite ends of the light path. Monostatic systems have a retro-reflector that reflects the light beam back towards the detector.

Validation and sources of uncertainty

The calibration procedures are described in EN.16253:2013. There are two approaches: using gas cells and reference gases linked to international standards or modeling the behavior of the system using reference spectra. The equipment should be checked periodically (once or twice a year). The absorption spectrum of any parasitic compounds must be subtracted from the spectrum analyzed.

Advantages and limitations

Advantages: DOAS is highly selective and very sensitive (<ppb) with a low limit of detection. It can take measurements rapidly (within a second) and it is non-intrusive. DOAS measurement systems are available on the market.

Limitations: The main limitations are the cost and skills required to use the equipment. Measurements are affected by poor visibility (eg: fog, snow) and clouds if the light source is the sun.

Costs: several tens of thousands of Euros.

References

Author of the application note:

- Thomas Eglin, ADEME – Angers, France

Bibliography

- Hu, E., Babcock, E.L., Bialkowski, S.E., Jones, S.B., Tuller, M. 2014. Methods and Techniques for Measuring Gas Emissions from Agricultural and Animal Feeding Operations. *Critical Reviews in Analytical Chemistry*. 44 (3), 200-219
10.1080/10408347.2013.843055 <Go to ISI>://WOS:000334065600002
- EN 16253:2013. Air quality. Atmospheric measurements near ground with active Differential Optical Absorption Spectroscopy (DOAS). Ambient air and diffuse emission measurements.
- Volten, H., Bergwerff, J.B., Haaima, M., Lolkema, D.E., Berkhout, A.J.C., et al. 2012. Two instruments based on differential optical absorption spectroscopy (DOAS) to measure accurate ammonia concentrations in the atmosphere. *Atmospheric Measurement Techniques*. 5 (2), 413-427 10.5194/amt-5-413-2012 <Go to ISI>://WOS:000300876700011

Application note 12 Laser absorption spectroscopy

Scope of application

Laser absorption spectroscopy covers the use of lasers to measure the concentration or quantity of a gas species by absorption spectroscopy. The target gases are greenhouse gases (CO₂, N₂O, CH₄, H₂O) and reactive gases such as NO, HCL, HNO₂, NH₃ and CO. It can also be used to make precision measurements of the concentrations of various stable isotopes of the target gases when measuring emissions from farms (¹³CO₂, ¹⁵N₂O, H₂¹⁸O, etc), identify the origin of natural sources or mark and then monitor the transformation or transport of a compound in the soil, plant or atmosphere.

Operating principles

Laser absorption spectroscopy is one of the oldest methods used for non-intrusive measurement of the concentrations of certain gas species. It measures the absorption of light from a light source with well defined spectrum along the optical path to the detector. The intensity of the light detected at a wavelength characteristic of the target gas depends on the concentration of that gas. The more molecules in the optical path, the greater the amount of light that is absorbed (Beer-Lambert law).

$$\ln\left(\frac{I_0}{I}\right) = \sigma NL \text{ (eq. M12.1)}$$

where

I_0 is the intensity of the incident light,

I is the intensity of the light on exit,

σ is the absorption cross-section (cm².molecule⁻¹),

N is the concentration of the gas (molecule.cm⁻³) and

L is the length of the optical path (cm).

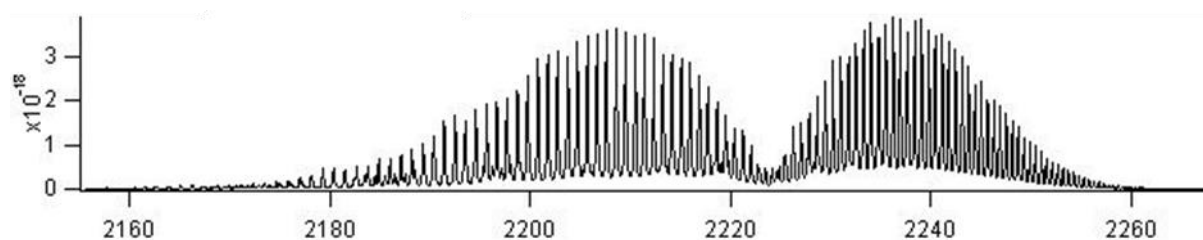

Figure M12.1. Absorption cross-section (cm².molecule⁻¹) of N₂O as a function of the wavenumber (cm⁻¹).

The equivalent range in wavelength is from 4.46 μm to 4.59 μm.

The absorption cross-section depends on both the target molecule and the wavelength (see example for N₂O in Figure M12.1). The choice of wavelength determines the type of molecule detected. In the near and mid infrared (IR) regions, the signature of the gas molecules is the result of the rotation-vibration resonances (Figure M12.1). It is usually used more with wavelengths from 1 to 12 μm. The fundamental bands are the most intense and are found in the mid infrared region (3-12 μm) and the less intense harmonic bands are

found in the near infrared region (0.78 to 3 μm). The spectroscopic absorption parameters of these bands are given in the HITRAN (Rothman *et al.*, 2009) or GEISA databases which include the line positions (wavenumber, cm^{-1}) and the broadening parameters for the pressure and temperature of the gas. To determine the concentration of the absorbing medium with precision, the absorption for a line must be measured for pressures between 10 and 100 mmHg over an extended band covering a Voigt profile corresponding to the convolution between a Gaussian profile and a Lorentzian profile.

Equipment and implementation

The most common systems available on the market are Tunable Diode Laser Absorption Spectroscopy (TDLAS), Off Axis Integrated Cavity Output Spectroscopy (OA-ICOS) and Cavity Ring-Down Spectroscopy (CRDS). Most of these use photon detectors. The performance (response time, measurement sensitivity) of these technologies now makes it possible to measure emission fluxes using micrometeorological flux gradient (Application note 30) and eddy covariance (Application note 31) methods. However, they can also be used for real-time measurements using static flux chambers (Application note 23).

Tunable Diode Laser Absorption Spectroscopy (TDLAS) (McManus *et al.*, 2005) is very sensitive and highly selective with a low limit of detection for small molecules such as H_2O , N_2O , CH_4 and CO_2 . A tunable monochromatic source is used in the form of a solid-state laser that emits light in the near and mid infrared regions and can be tuned by varying the temperature and current. The near infrared region can be covered by fiber optic lasers operating at ambient temperature. For a long time, the mid infrared region could only be used with rather unreliable lead salt lasers that had to be operated at very low temperatures ($\sim -100^\circ\text{C}$). Recently, a new generation of quantum-cascade lasers (QCL) has been developed for use in the mid infrared region. These lasers can be tuned by adjusting the temperature or by changing the current. Although temperature changes allow tuning over 100 cm^{-1} , this method is limited by slow tuning rates owing to the thermal inertia of the system. On the other hand, adjusting the current can provide tuning at rates up to about 10 GHz, but it is restricted to a smaller tuning range of 1 to 2 cm^{-1} . The typical laser line width is of the order of 10^{-3} cm^{-1} or smaller. The sensitivity of direct absorption techniques is often limited to minimum absorption I/I_0 of about 10^{-3} . The absorption can be increased by lengthening the optical path using multi-pass cells.

Off-Axis Integrated Cavity Output Spectroscopes (OA-ICOS) use quantum-cascade-lasers (QCL) with a high finesse optical cavity (the mirrors are highly reflective $\sim 99.99\%$) as the absorption cell (Figure M12.2). In comparison to standard multi-pass cells which are generally limited to path lengths of less than two hundred meters, the combination of an off-axis trajectory and high finesse cavity increases the number of reflections to give an effective optical path length of several kilometers (2.5 km for a 25 cm cavity). The optical path length depends only on the optical losses in the cavity and not on the length of a single path. The alignment of the lens is highly robust for high reliability. The effective length of the optical

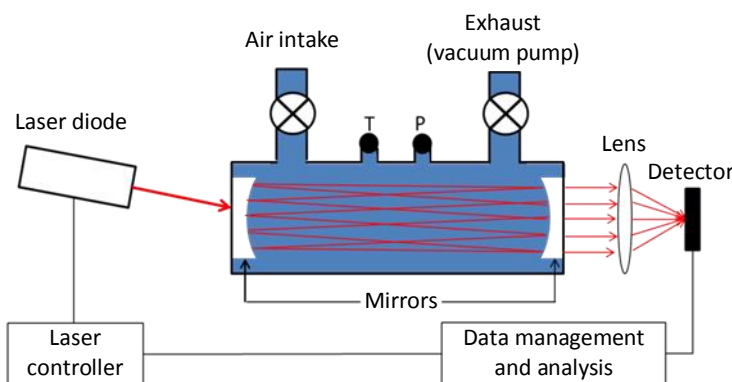

Figure M12.2. Off-Axis Integrated Cavity Output Spectroscopy

path length depends only on the optical losses in the cavity and not on the length of a single path. The alignment of the lens is highly robust for high reliability. The effective length of the optical

path is determined by stopping the laser output and measuring the decay time of the light leaving the cavity (tens of microseconds).

Cavity Ring-Down Spectroscopy (CRDS) (Baer *et al.*, 2002; O'Keefe *et al.*, 1999) uses a laser to illuminate a cavity with highly reflective mirrors (Figure M12.3). When the laser is in resonance with a cavity mode, intensity builds up in the cavity due to constructive interference. When this intensity reaches a predefined level, the laser is turned off and the decay time (*ring-down time*) of the light intensity is measured using a photodiode. The ring-down time depends directly on the absorption coefficient (which depends on the gas in the cavity) at the wavelength emitted by the laser. The high reflectance of the mirrors ($R \sim 1 \times 10^{-5}$) provides a

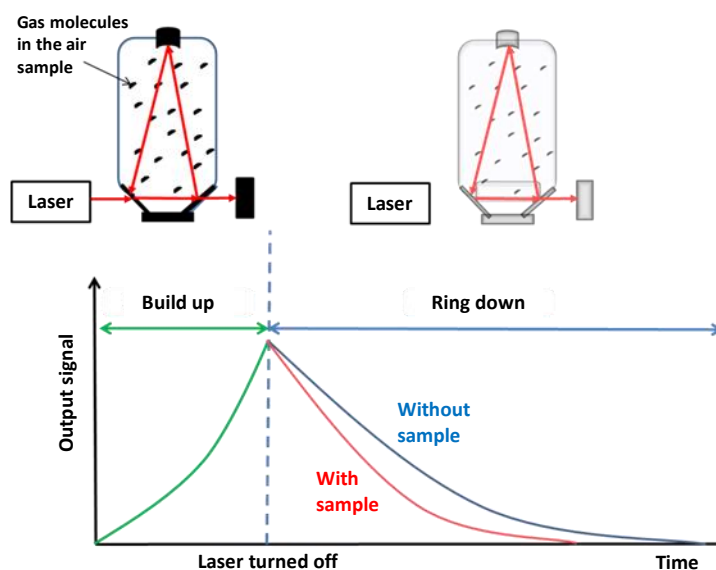

Figure M12.3. Cavity Ring-Down spectroscopy

The concentration of the target gas C is calculated from the equation $\tau_0/\tau = 1 + \sigma Cl / (1 - R)$ where σ is the absorption cross section, l is the length of the cavity, R is the mirror reflectivity and τ_0 and τ are decay times without and with the gas sample.

sensitivity equivalent to an absorption path of several thousand kilometers. The light source used is a diode laser that is tuned to one of the absorption bands of the target gas species. The performance is slightly lower than the two technologies described above but there is a model which can measure NH_3 , CH_4 , CO_2 , N_2O at the same time.

Validation and sources of uncertainty

Laser absorption spectroscopy is highly specific and very sensitive and has become the standard method for quantitative measurement of trace gases. For example, QCL-TDLAS is sensitive to a few hundred ppb for N_2O , around ppb for CH_4 , and a few ppb for NH_3 . The sensitivity varies depending on the make of spectroscope. CRDS spectroscopes now on the market have the same order of magnitude of precision for N_2O with a measurement frequency of 1 s.

Advantages and limitations

These spectroscopes have great potential, as they are both highly sensitive and very selective and are non-intrusive. Diode laser spectroscopes are now the most robust gas analyzers and the easiest to use for someone who is not an expert in spectrometry. However, they require considerable care when used in very dusty environments such as livestock buildings.

Costs: This type of analyzer is still high, around €100,000.

References

Author of the application note:

- Patricia Laville, INRA, UMR EGC – Thiverval Grignon, France

Bibliography

- Baer, D.S., Paul, J.B., Gupta, J.B., O'Keefe, A. 2002. Sensitive absorption measurements in the near-infrared region using off-axis integrated-cavity-output spectroscopy. *Applied Physics B-Lasers and Optics*. 75 (2-3), 261-265 10.1007/s00340-002-0971-z
- McManus, J., Nelson, D., Shorter, J., Jimenez, R., Herndon, S., et al. 2005. A high precision pulsed quantum cascade laser spectrometer for measurements of stable isotopes of carbon dioxide. *Journal of Modern Optics*. 52 (16), 2309-2321
- O'Keefe, A., Scherer, J.J., Paul, J.B. 1999. cw Integrated cavity output spectroscopy. *Chemical Physics Letters*. 307 (5-6), 343-349 10.1016/s0009-2614(99)00547-3
- Rothman, L.S., Gordon, I.E., Barbe, A., Benner, D.C., Bernath, P.E., et al. 2009. The HITRAN 2008 molecular spectroscopic database. *Journal of Quantitative Spectroscopy & Radiative Transfer*. 110 (9-10), 533-572 10.1016/j.jqsrt.2009.02.013

Application note 13 Measuring airflow for buildings with forced ventilation using an anemometer

Scope of application

This method measures the airflow in the ducts used for continuous ventilation in livestock buildings, such as pig houses, at any physiological stage (Robin *et al.*, 2010). There are no limitations on its use apart from having access to the ducts where the measurements are to be taken.

Operating principle

The airflow is calculated using the following equation:

$$q = v \times A \times \frac{T_{operating}}{T_{total}} \quad (\text{eq. M13.1})$$

where

q is the airflow (m^3 damp air. h^{-1}),

v is the average airspeed ($\text{m}.\text{h}^{-1}$),

A is the cross-section of the ventilation duct or conduit (m^2) and

$\frac{T_{operating}}{T_{total}}$ is the duty factor over the period considered.

To determine the average airflow speed, the cross-section of the ventilation duct opening is divided into equal segments. The speed is measured at the center of each segment using an anemometer. The measurements for all the segments are averaged to give the average airflow speed using the above equation.

Equipment required

- Hot wire or helical anemometer
- Thermometer/hygrometer
- Drill and bit
- Marker pen and adhesive tape
- Tape measure

Implementation

To calculate the airflow in a livestock building, the cross-section of ventilation ducts must be measured and the airflow speed through the ducts must be determined. A 1 cm hole should be drilled in the duct so that the anemometer can be inserted, if possible at a distance of at least three times the diameter of the duct from the fan. If this is not possible, the anemometer should be inserted 50 cm before the fan. The probe should be inserted as horizontally

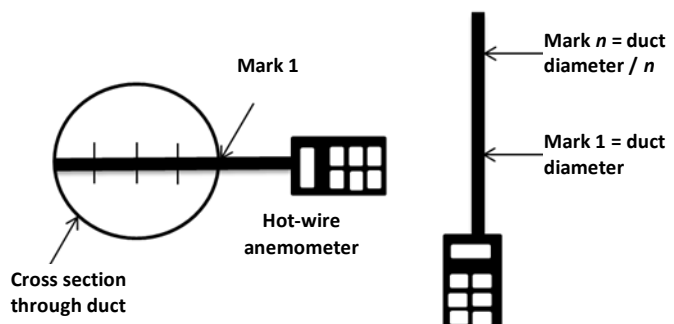

Figure M13.1. Measuring the air speed in an extraction duct using a hot-wire anemometer

as possible across the duct until it reaches the opposite side of the duct. The marker pen is used to mark the duct diameter on the probe (Figure M13.1) to confirm the diameter of the duct.

The diameter of the duct is divided into a number of equal segments and marked on the anemometer probe. These marks are used to position the probe in the duct. Average measurements are taken for each of the n positions (Recknagel, 1995). Some anemometers give an average measurement over a given period, based on instantaneous measurements. A period of 20 to 40 seconds should be adequate to obtain representative measurements of the airspeed. Measurements must be carried out in each of the positions until at least five consistent measurements have been taken. For example, for a 45 cm diameter duct, five or six positions with five consistent measurements for each position can give a representative average flow. The duty factor should be measured over 3 or 4 cycles.

Validation and sources of uncertainty

To check the estimated airflow, the temperature and humidity of the air entering and leaving the system are also measured. These are combined with the airflow measurements to estimate the water vapor emissions and sensible heat dissipation within the building. These estimates should then be compared with the estimates of water vapor emissions from animal respiration and estimates of the sensible heat produced by the animals in the building (Pedersen and Sällvik, 2002). When the animals are kept on deep litter which is at least three weeks old, the sensible heat and water vapor from the litter must be included.

The accuracy of the measurements is strongly dependent on the anemometer and the conditions while the measurements are being taken. The following recommendations will help to minimize the measurement uncertainty.

- Measurements should be taken before the fan rather than after the fan as the air movement is less turbulent
- Measurements should be taken in the first third of the air extraction duct, in a straight section at least 10 times longer than the diameter
- Measurements should be taken when the outdoor wind is light and constant. Strong, blustery conditions may cause static pressure fluctuations at the ends of the extraction duct leading to variations in the average airspeed during the measurement period
- It is advisable to avoid changes in temperature while taking the measurements as these can cause changes in the airflow

Advantages and limitations

Advantages: This method is easy to use. There are no limitations on its use, apart from having access to the ducts where the measurements must be taken. Airspeed measurements may be taken at intervals or continuously (at a high acquisition frequency) using a data logger to record the measurements (which costs several thousands of Euros).

Limitations: The sensor may become dusty during continuous measurements and account must be taken of this. If the ventilation system does not operate continuously (ventilation controlled by sequential operation of the fans), the fan operating and idle periods must be taken into account as well as the overall duty factor. Alternatively, as the pressure in the building is smoothed the airflow can be measured at the intake to the system, where the airflow is continuous, provided that the cross-section of the air intake does not change while

the airflow is being measured. If a data logger is used, it is not possible to move the sensor across the duct and it will be necessary to assess the effect of the position of the sensor on the measurement.

Costs: a few hundred to a few thousand Euros.

References

Authors of the application note:

- Nadine Guingand, IFIP Institut du Porc – Le Rheu, France
- Paul Robin and Mélynda Hassouna, INRA, UMR SAS – Rennes, France.

Bibliography

Pedersen, S., Sällvik, K. 2002. 4th Report of Working Group on Climatization of Animal Houses Heat and moisture production at animal and house levels. Research Centre Bygholm, Danish Institute of Agricultural Sciences 46 p. http://www.cigr.org/documents/CIGR_4TH_WORK_GR.pdf (site accessed on October 26, 2014)

Recknagel, H. 1995. Le Recknagel - données fondamentales - manuel pratique de génie climatique [Recknagel's Practical heating engineering manual]. 3rd edition. Editions PYC Livres 784 p.

Robin, P., Amand, G., Aubert, C., Babela, N., Brachet, A., et al. 2010. Procédures de référence pour la mesure des émissions de polluants gazeux des bâtiments d'élevage et stockages d'effluents d'élevage. Rapport final. [Standard procedures for measuring pollutant gas emissions from livestock buildings and manure storage. Final report.] (contract 06 74 C0018).519 p.

Application note 14 Determining airflow for livestock buildings using a tracer gas

Scope of application

The airflow is determined using a tracer gas in enclosed or partially enclosed livestock buildings (closed on three sides or with windbreak netting). Tracer gases other than sulfur hexafluoride (SF_6) can be used if they are not transformed or absorbed during the measurement period.

Operating principles

This tracer gas method is based on the release of a known quantity of a gas which diffuses in the same way as the target gases. SF_6 is frequently used as a tracer because it is easy to detect and is chemically very inert and also because it is not produced in the building.

There are two basic methods for determining the flow of a tracer gas in an enclosed environment:

- a constant injection method where the tracer gas concentration is measured directly over a period of time
- a concentration decay method where a large amount of tracer gas is injected into the area to be measured: when the concentration stabilizes, the injection is stopped and the decay in concentration is used to calculate the airflow in that area

Both approaches are based on measuring the SF_6 concentration gradient between the inside of the building and the outside, which should be more or less stable over time (Robin *et al.*, 2004). This is the case for any building with climate control, whether they have with natural or forced ventilation, controlled manually or automatically.

Equipment required

- A bottle of pure SF_6 tracer gas
- Equipment for injecting and measuring the gas concentration. The equipment for measuring the SF_6 concentrations must be selected for the levels of concentrations to be detected and the changes in SF_6 concentrations in the building which depend on the airflow rate and the injection method used. The sampling tubes should be in PTFE and may need to be insulated or heated, depending on the conditions, to prevent condensation forming on the inside.



Figure M14.1. Duct for dispersing the tracer gas within a building (source: INRA)

The equipment should be protected against heat, dust and animals.

- A dispersion system (Figure M14.1) that will ensure a uniform concentration without disturbing the animals, which implies an airspeed of less than $0.2 \text{ m}\cdot\text{s}^{-1}$
- Temperature and humidity sensors inside and outside the building

Implementation

The input data are the temperature and humidity of the air, the SF₆ concentrations inside and outside the building, the number and weight of the animals and the building dimensions.

The following equation is used to calculate the airflow from the concentration of the tracer gas at a given time step and the concentration of the tracer gas at the previous time step:

$$q_{air, trac}(t_n) = \left(\frac{F(t_n)}{Cv_{SF_6,i}(t_n) - Cv_{SF_6,e}(t_n)} \right) - \left(\frac{V_{build} \times \frac{Cv_{SF_6,i}(t_n) - Cv_{SF_6,e}(t_{n-1})}{t_n - t_{n-1}}}{Cv_{SF_6,i}(t_n) - Cv_{SF_6,e}(t_n)} \right) \text{ (eq. M14.1)}$$

where

$q_{air, trac}(t_n)$ is the calculated airflow at time t_n ($m^3 \cdot h^{-1}$),

$F(t_n)$ is the tracer gas injection rate ($ml \cdot s^{-1}$),

$Cv_{SF_6,i}(t_n)$ and $Cv_{SF_6,e}(t_n)$ are the interior and exterior concentrations of tracer gas at time t_n (ppmv, ml of SF₆ per m³ of air),

$Cv_{SF_6,i ou e}(t_{n-1})$ is the gas concentration at the previous time step,

V_{build} is the volume of air inside the building (m^3).

The first term corresponds to the injection phase and it is clear that this term is zero during the decay phase $F(t_n)=0$. The second term corresponds to the decay phase, it becomes negligible when the tracer gas concentration is stable (the second term is less than 5% of the first term when the injection and airflow are constant). It is useful to calculate the flow using both terms and take account of tracer gas concentrations outside the building as livestock buildings are large and have high ventilation rates which will increase the concentration of the tracer gas in the air entering the building. It is also useful to carry out the assessment after testing the concentrations of tracer gas, estimate missing data and aggregate the results over a period of time.

The two terms of the equation are calculated separately and then added together to highlight any measurement incoherences. The flow calculations are carried out separately for each phase ("injection" or "decay").

Validation and sources of uncertainty

This method is based on two main assumptions which need to be checked:

- uniform distribution: the airflow must be calculated using tracer gas concentration measurements at several sampling points
- constant flow: the airflow calculated using tracer gas concentrations must either be compared with the estimated airflow from the production of heat or CO₂ by the animals or be used to recalculate the production of heat and water vapor by the animals to ensure that the order of magnitude is correct.

During and at the end of measurement, the total tracer gas injected may be checked against the change in weight of the tracer gas bottle.

Advantages and limitations

Advantages: Measurement using a tracer gas is often considered to be a standard method. It has been well established as a means of quantifying emissions from livestock buildings

(Phillips *et al.*, 2000). Integrated systems are available for injecting the tracer gas, taking air samples, measuring the concentration of the tracer gas and the gases whose emissions are being estimated and calculating the airflow. This method can be used for all types of building that are partially enclosed and also for new livestock production systems for which other methods based on assumptions regarding the production of heat, water vapor and CO₂ cannot be applied (Application notes 15 and 16). In addition to quantifying the airflow, the SF₆ tracer gas method can identify any interference between adjacent livestock buildings which have different levels of emission (some of the intake air coming from a building with high emissions) and thus avoid overestimating the emissions by underestimating their concentrations in the intake air.

Limitations: There are two major disadvantages to the use of SF₆ which mean that it must be used with great circumspection:

- it is a greenhouse gas with a global warming potential approximately 22,200 greater than CO₂ over 100 years (Houghton *et al.*, 2001),
- its density is high and care should be taken to ensure that it is distributed uniformly and at about the same concentration as the gases whose emissions are being estimated.

If the difference in concentration between the inside and the outside of the building cannot be determined at each time step (as for a partially open building, for example), other methods with more frequent measurements and a higher sensitivity for measuring the concentration difference should be used (methods based on eddy covariance or using a large number of passive samplers).

Costs The purchase price varies from a few thousand to a few tens of thousands of Euros.

References

Authors of the application note:

- Paul Robin and Mélynda Hassouna, INRA, UMR SAS – Rennes, France

Bibliography

- Houghton, J.T., Ding, Y., Griggs, D.J., Noguer, M., van der Linden, P.J., et al. 2001. Climate Change 2001: The Scientific Basis. Cambridge University Press - the Intergovernmental Panel on Climate Change. http://www.ipcc.ch/ipccreports/tar/wg1/pdf/WG1_TAR-FRONT.PDF
- Phillips, V.R., Scholtens, R., Lee, D.S., Garland, J.A., Sneath, R.W. 2000. A review of methods for measuring emission rates of ammonia from livestock buildings and slurry or manure stores, part 1: Assessment of basic approaches. *Journal of Agricultural Engineering Research*. 77 (4), 355-364 10.1006/jaer.2000.0613 <Go to ISI>://WOS:000166485500001
- Robin, P., Hassouna, M., Ramonet, Y., Texier, C. 2004. Maîtrise des émissions gazeuses en bâtiments sur litière (validation en élevages des résultats acquis en conditions climatiques contrôlées). Programme Porcherie Verte Action de recherche AC-41B Rapport final. [Controlling emissions from livestock buildings with deep litter (validation on farms of measurements taken in climate controlled conditions). Green pig house program, research project AC-41-B Final Report.] INRA; CRAB; IFIP. 104p.

Application note 15 Determining airflow for livestock buildings by heat balance

Scope of application

It is not feasible to measure the airflow directly (Application note 13) in buildings with natural ventilation and, in certain conditions (fast air change), it is difficult to quantify the difference in CO₂ concentrations between the inside and the outside of the building (Application note 16). In this case, the airflow can be estimated from the heat balance in the livestock building. However, care should be taken to ensure that the heat production models used are appropriate for the animals and that the other sources of heat transfer (heating, losses through the envelope, litter, etc) are known or negligible.

Operating principles

This method is based on the fact that the ventilation explains the relation between the production of heat and the temperature (or enthalpy, or moisture) difference. The “total” heat produced by the animals (produced by their metabolism) and the heat from the heating in the building are produced in two forms:

- the sensible heat which can be measured by the increase in the temperature. This comes from the convected and radiated heat from the animals, the litter and the heating in the building.
- the latent heat carried by water vapor which can be measured by the increase in relative humidity. The water vapor comes from the respiration of the animals and the evaporation from the litter.

The heat balance is between the heat gain (G) and the heat loss (L) both as sensible and latent heat, as given in the following equation.

$$GA + GH + GL + CO = LE + LV \text{ (eq. M15.1)}$$

where

GA is the heat gained from the animals (sensible+latent),

GH is the heat gained from the heating system and other external sources (sensible+latent),

GL is the heat gained from the litter (sensible+latent),

CO is the evaporative cooling (conversion of sensible heat into latent heat),

LE is the heat loss through the envelope (sensible) and

LV is the heat loss by ventilation (sensible + latent).

The airflow q_{air} (m³.h⁻¹) can be calculated from the heat balance using the following formula:

$$q_{air} = \frac{(G-LE)}{Q_i-Q_e} \text{ (eq. M15.2)}$$

where

G (J.h⁻¹) is the total heat gain,

LE (J.h⁻¹) is the heat loss through the envelope,

Q_i (J.m⁻³) and *Q_e* (J.m⁻³) are the energy densities of the indoor and outdoor air.

This approach is applied at the same time to the balances of sensible, latent and total heat. Models are available to estimate the heat produced by animals (GA) in documents produced by the International Commission of Agricultural Engineering (Pedersen and Sällvik, 2002). The heating (GH) is calculated from the air renewal rate estimated on the basis of the moisture produced by the animals, the difference in relative humidity between the indoor and outdoor air and the calculated sensible heat gains and heat loss through the envelope. The heat loss through the envelope is estimated from the thermal insulation coefficient of the building. The building thermal insulation can be estimated from the specifications for the walls and roof.

Equipment and data required

- Several thermometers/hygrometers
- The building usage (number of animals, density, weight of the animals, age (number of days), fuel consumption, etc.)
- Building characteristics

Implementation

Using temperature and relative humidity measurements, and the data provided by the farmer (number of animals, age (number of days), average weight of the animals (real, if available or estimated by interpolation, if not known), the latent heat (H_{lat} , $J.h^{-1}$), sensible heat (H_{sens} , $J.h^{-1}$), and total heat (H_{tot} , $J.h^{-1}$) balances are calculated in turn to determine the heat gain and thus the airflow. If an evaporative cooling system is used, the amount of water consumed must be taken into account.

Calculating the airflow from latent heat: $q_{air,lat}$

The airflow leaving the building can be deduced from the total latent heat flow (animals, evaporation from the litter and cooling, if appropriate) and the difference between the relative humidity of the indoor and outside air using the following equation:

$$q_{air,lat} = \frac{H_{lat}}{\rho_i \times (h_{s_i} - h_{s_e}) \times Lat} \quad (\text{eq. M15.3})$$

Where

ρ_i is the amount of airflow the building ($kg.m^{-3}$),

h_{s_i} and h_{s_e} are the relative humidity of the indoor and outdoor air ($kg \text{ water} \cdot kg \text{ dry air}^{-1}$) and

Lat is the latent heat of evaporation (or enthalpy of vaporization = $2.45 \cdot 10^6 J.kg^{-1}$).

Calculating the heat gain from the sensible heat balance

The heat gain is calculated from the sensible heat losses and the sensible heat produced by the animals.

$$H_{sens_{gain}} = q_{air,lat} * \rho_i \times C_p \times (T_i - T_e) + GE + \frac{COOL}{Lat} - (H_{sens_{animals}} + H_{sens_{litter}}) \quad (\text{eq. M15.4})$$

Where

C_p is the heat capacity at constant pressure ($1010 J.kg \text{ dry air}^{-1} \cdot K^{-1}$),

T_i and T_e are the indoor and outdoor temperatures (K),

$COOL$ is the amount of water consumed by the cooling system ($kg.h^{-1}$),

Lat is the latent heat of evaporation (or enthalpy of vaporization = $2.45 \cdot 10^6 \text{ J.kg}^{-1}$) and GE is the heat lost through the envelope (J.h^{-1}).

Calculating the airflow from the total heat: $q_{air,tot}$

The airflow from the building can be deduced from the total heat production (latent and sensible heat produced by the animals, the litter and the heating system), the losses through the envelope (GE) and the difference in enthalpy between the indoor and outdoor air using the following equation:

$$q_{air,tot} = \frac{(H_{tot} - GE)}{\rho_i \times (E_i - E_e)} \text{ (eq. M15.5)}$$

Where

E_i and E_e are the enthalpy in the indoor and outdoor air (J.kg^{-1} dry air). The enthalpies can be determined from the temperature T ($^{\circ}\text{C}$) and humidity ratio hs (kg.kg^{-1}) of the air using the equation:

$$E = (0.24 \times T + hs \times (0.47 \times T + 595)) \times 4.184 \times 1000 \text{ (eq. M15.6)}$$

Validation and sources of uncertainty

Airflow calculations based on heat balance are partly based on the heat produced by the animals. The models available have been built on measurements in respiration chambers with no accumulation of manure (Pedersen *et al.*, 2008). When the manure has accumulated in the building for several weeks, the specific heat produced by the manure should be added (Robin *et al.*, 2004). Some values are given for pig farming by de Oliveira (1999). There are no precise figures for heat produced by manure, which is a source of uncertainty (sometimes a major source) that should be taken into account. The same applies to the models for heat produced by animals which are based on observations of particular breeds and not for all animals. Account should, therefore, be taken of the increased amount of heat produced as animals grow or are more active or the decrease in heat production for slow growing breeds. The amount of fodder consumed can also be used to correct heat production or net energy quantities digested (if these can be determined). Part of the uncertainty can also be attributed to the changes in heat production by animals depending on their activity.

This method may be more robust than the method based on the CO_2 differences (Application note 16) when the heat produced by the animals is a dominant factor in the heat balance (the other sources of heat or heat lost through the envelope being negligible). In this case, it could be considered that when the three evaluations based on sensible, latent and total heat converge, the median is close to the “real” ventilation rate. Estimates using total, latent and sensible heat should be within a 30% of the median. If this is not the case, it may be that certain assumptions are incorrect (various heat flows estimated incorrectly, drift in thermometer/hygrometers, unrepresentative temperature and humidity measurement points).

Advantages and limitations

Advantages: This method is simple to use, low cost and reproducible. It should be used to give a reasonable assessment of the average airflow over a day or half day.

Limitations: This method does not give precise measurements over short time scales (eg: hourly) because of variations in the activity of the animals during the day. These variations

occur in most livestock buildings (Pedersen and Sällvik, 2002). The method cannot be used if there is little difference between the indoor and outdoor temperature.

Costs: The cost of this method varies between a few tens of Euros to a few thousand Euros, depending on the type and number of thermometer/hygrometers used.

References

Authors of the application note:

- Paul Ponchant, ITAVI – Ploufragan, France,
- Mélynda Hassouna, INRA, UMR SAS – Rennes, France

Other organizations: Chambers of agriculture, IFIP, Idele

Bibliography

- de Oliveira, P.A.V. 1999. Comparaison des systèmes d'élevage des porcs sur litière de sciure ou caillebotis intégral. [Comparison of pig production systems on sawdust litter or slats] UMR SAS, ENSA de Rennes, 264 p.
- Pedersen, S., Blanes-Vidal, V., Jørgensen, H., Chwalibog, A., Haeussermann, A., et al. 2008. Carbon dioxide production in animal houses: A literature review. *Agricultural Engineering International: CIGR Journal*. X, 19 p.
- Pedersen, S., Sällvik, K. 2002. 4th Report of Working Group on Climatization of Animal Houses Heat and moisture production at animal and house levels. Research Centre Bygholm, Danish Institute of Agricultural Sciences 46 p. http://www.cigr.org/documents/CIGR_4TH_WORK_GR.pdf (site accessed on October 26 2014)
- Robin, P., Hassouna, M., Ramonet, Y., Texier, C. 2004. Maîtrise des émissions gazeuses en bâtiments sur litière (validation en élevages des résultats acquis en conditions climatiques contrôlées). Programme Porcherie Verte Action de recherche AC-41B Rapport final. [Controlling emissions from livestock buildings with deep litter (validation on farms of measurements taken in climate controlled conditions). Green pig house program, research project AC-41-B Final Report.] INRA; CRAB; IFIP.104p.

Application note 16 Determining airflow for livestock buildings by CO₂ concentration

Scope of application

This method is used when the airflow cannot be measured directly for buildings with natural ventilation or buildings with a forced ventilation system where it is difficult to access the extraction duct (Application note 13). It can be used in any livestock buildings where there is a reasonable model of CO₂ production. This is the case for buildings without any accumulation of manure (Pedersen *et al.*, 2008). When manure has accumulated in the building for some weeks, for example with manure, the emission of CO₂ by the manure should be added.

Operating principles

This method is based on the hypothesis that ventilation determines the relationship between the production of CO₂ in the building and the difference in CO₂ concentrations between the inside and the outside of the building. The total production of CO₂ in the building can be estimated from the number and type of animals, the presence of litter and the production of CO₂ by the heating if appropriate. The airflow of the ventilation system q_{CO_2} (m³.h⁻¹) can be expressed using the following equation:

$$q_{CO_2} = \frac{(CO_{2_{animals}} + CO_{2_{heating}})}{(C_{int} - \frac{C_{ext} \times \rho_{int}}{\rho_{ext}})} \times 10^{-6} \text{ (eq. M16.1)}$$

where

$CO_{2_{animals}}$ (m³ CO₂.h⁻¹) is the CO₂ produced by the animals and the litter,

$CO_{2_{heating}}$ (m³ CO₂.h⁻¹) is the CO₂ produced by the heating system,

C_{int} and C_{ext} (ppmv) are the CO₂ concentrations inside and outside the building, and

ρ_{int} and ρ_{ext} (kg dry air.m⁻³ moist air) are the densities of the inside and outside air.

$CO_{2_{animals}}$ is estimated from the heat produced by the animals and the litter, $H_{animals+litter}$ (W) using the following equation:

$$CO_{2_{animals}} = CO_{2_{hpu}} \times H_{animals+litter} \text{ (eq. M16.2)}$$

where $CO_{2_{hpu}}$ is the production of CO₂ for 1000 W heat produced in the building (m³ CO₂.h⁻¹) which can be calculated using the values from the literature in Table M16.1 (Pedersen *et al.*, 2008):

Table M16.1. Production of CO₂ for 1000 W heat produced by various categories of animal (Pedersen *et al.*, 2008)

Type of animal	$CO_{2_{hpu}}$ (m ³ CO ₂ .h ⁻¹)
Calf	0.170
Dairy cow	0.200
Piglet	0.185
Pig for meat	0.200
Sow	0.180
Broiler < 0.5 kg	0.180
Broiler > 0.5 kg	0.185
Layer	0.180

$CO_{2,heating}$ is calculated from the fuel consumption and the associated emission factors.

Equipment and data required

- Thermometers/hygrometers to measure the temperature (°C) and relative humidity (%) inside and outside the building
- Gas analyzer to measure the CO₂ concentrations inside and outside the building
- Data on the farming operation (type of animals, number of animals, feed, animal production)

Implementation

For manual measurements (point measurements), the temperature, relative humidity and CO₂ concentrations should be measured throughout the building without going too close to the walls or the animals. It is important to avoid any sudden movement that might cause the animals to panic.

When recording CO₂ concentrations, temperature and humidity (continuous measurements), at least 2 sensors should be used, one close to the air outlet and the other in the animal enclosure. It is also useful to measure the airspeed at the air intakes and outlets, if possible (Application note 13).

In addition to the air measurements, details should be recorded about the animals, such as their weight and production (growth, milk, eggs, etc.). Details of the feed (quantities, digestible energy, etc.) may be useful as input for the CO₂ production models.

Validation and sources of uncertainty

The various animal heat production models used as basic data do not have estimates of the uncertainty, but these uncertainties must be taken into account when evaluating the global uncertainty on the airflow estimated using this method. There is also uncertainty on the CO₂ production values for each type of animal as the variations depending on the physiological phase, the farming methods, the feed and genetic strains are not fully known.

Advantages and limitations

Advantages: This method is easy to implement. It can be used when the aim of the measurements is to have a reasonable evaluation of the average ventilation airflow over a timescale of one day or one half day or when fluctuations in CO₂ production are negligible.

Limitations: This method does not give precise estimates (uncertainty of over 30% according to the experts), in particular over short timescales because of the variations in CO₂ emissions associated with animal activity. These variations occur in most livestock buildings.

Costs: The cost ranges from one to several thousand Euros, depending on the system used to take the air samples and measure the CO₂ concentrations.

References

Authors of the application note:

- Solène Lagadec, CRAB – Rennes, France,
- Paul Robin and Mélynda Hassouna, INRA, UMR SAS – Rennes, France

Other organizations: IFIP, ITAVI, IDELE

Bibliography

Pedersen, S., Blanes-Vidal, V., Jørgensen, H., Chwalibog, A., Haeussermann, A., et al. 2008. Carbon dioxide production in animal houses: A literature review. *Agricultural Engineering International: CIGR Journal*. X, 19 p. <http://www.cigrjournal.org/index.php/Ejournal> (téléchargeable sur le site le 26/10/2014)

Application note 17 Measuring CH₄ and CO₂ emissions from ruminants in partially open enclosures

Scope of application

This method is used for small or large ruminants. The animals are fed and housed in a partially open enclosure in a livestock building (Figure M17.1). The target gases are the CH₄ and CO₂ emitted by the ruminants during enteric fermentation and respiration. This method is used in particular to compare various parameters that affect the emissions (eg: different feed rations, frequency of distribution).

Operating principles

This method measures the gases emitted by an animal and its manure directly. The animal is placed in a partially open enclosure with forced ventilation with known air intake and outflow. The emissions are quantified by analyzing the air entering and leaving the enclosure and by quantifying the airflow.

This method has been developed recently and is usually used for several days to ensure that the measurements are reproducible. It can be compared with calorimetric chambers that are also used to study the metabolism of the animals and quantify the heat produced in a controlled environment.



Figure M17.1. A partially open emissions measurement enclosure (source: INRA)

Equipment required

The equipment required is shown in Figure M17.2.

Implementation

The enclosures are usually made of steel and surrounded by PMMA panels. This makes it easier to monitor the test and the animal can see the other animals and does not find itself in an excessively artificial environment. The enclosures are partially open (at the bottom) to ensure that the air is not confined in a sealed space. The airflow through the enclosure is a function of the size of the enclosure and the airflow rate required to avoid concentrations that are toxic for the animal (100 to 800 m³.h⁻¹, for cattle, for example). The size of the enclosures has been designed to allow adequate space for the animal. There are two doors at the front (for feed) and two doors at the back (to allow the animals to enter and leave the enclosure) (Pinares and Waghom, 2012).

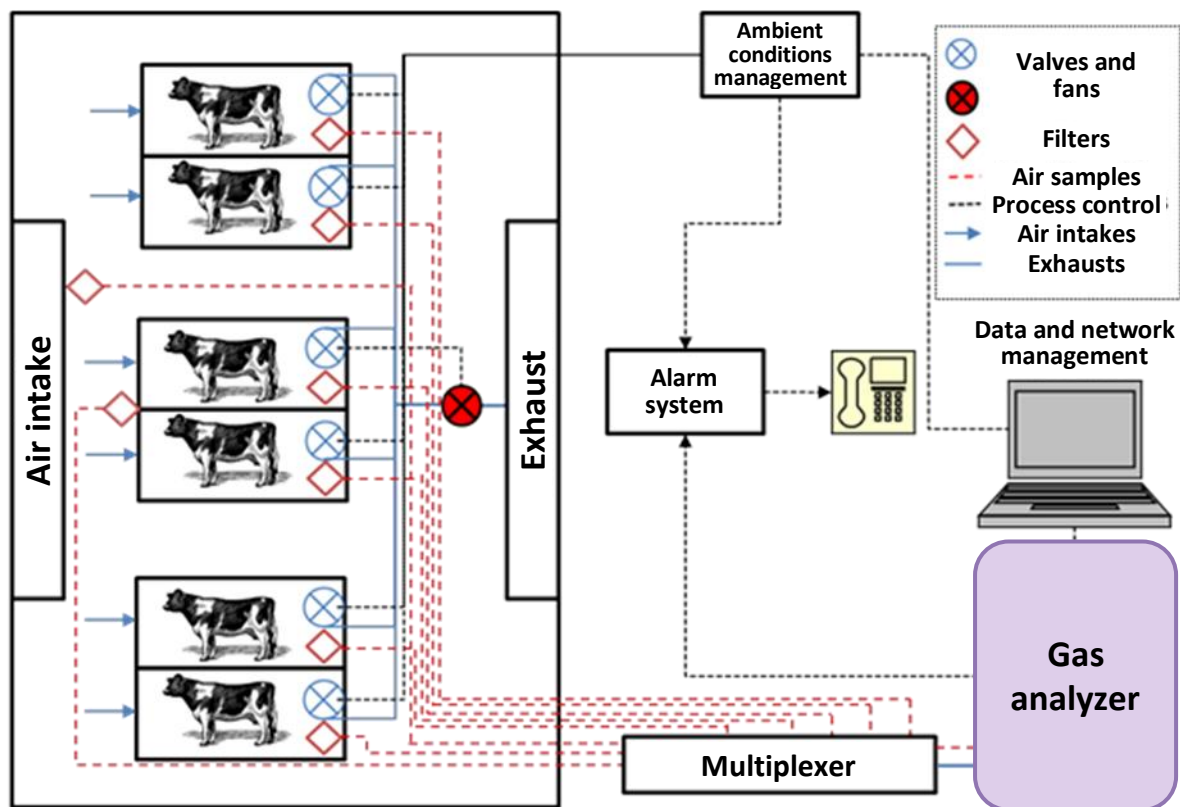

Figure M17.2. Schematic of a partially open enclosure (source: INRA)

The emissions are measured continuously (concentrations inside and outside the enclosure and airflow). The precision of the results will depend on the measurement equipment used (anemometers, gas analyzers, temperature sensors). Any extrapolation of the measurements taken in these chambers to real farm conditions should take account of other factors such as the production level, the ambient conditions and the physiological phase.

Validation and sources of uncertainty

The system should be inspected regularly to check that there are no leaks, the gas collection rate in the enclosure and the calibration of the infrared gas analyzer and the anemometers.

The method is precise and reproducible and gives emission values with a day-to-day coefficient of variation of the order of 5% to 10% (Storm *et al.*, 2012).

Factors that may cause uncertainty are:

- ambient air that has too high a concentration of gases coming from external sources (animals, slurry pits)
- leaks in the enclosure that may cause the concentrations to be underestimated and an unrepresentative gas collection rate (<80% or >120%)
- drift in the analyzer and anemometers over time
- the discomfort of the animal in the partially open enclosure which may cause a reduction in the ingestion of dry fodder and bias the measurements.

Advantages and limitations

Advantages: This measurement method in controlled conditions is often cited as a reference measurement method. It is highly reproducible and can quantify emissions at animal scale. It is sufficiently sensitive to compare the effects of particular regimes such as different food rations or different types of animal (production level, physiological phase) and display daily variations.

Limitations: This method requires considerable investment in equipment and personnel. It cannot be used directly on farms. The number of animals that can be tested is limited to the number of enclosures available.

References

Authors of the application note:

- Maguy Eugène and Jessie Guyader, INRA, UMRH - Theix, France

Other organizations: Global Research Alliance (Ministry of Agriculture and Forestry Pastoral House, 25 The Terrace PO Box 2526, Wellington 6140, New Zealand)

Bibliography

Pinares, C., Waghom, G. House, M.o.A.a.F.P. 2012. Technical manual on respiration chamber designs. 106 p.

Storm, I.M.L.D., Hellwing, A.L.F., Nielsen, N.I., Madsen, J. 2012. Methods for measuring and estimating methane emission from ruminants. *Animals*. 2 (2), 160-183
10.3390/ani2020160 <Go to ISI>://CABI:20123245793

Application note 18 Measuring CO₂ and enteric CH₄ emissions by ruminants using a tracer gas (SF₆)

Scope of application

This method is currently used for measuring emissions from individual ruminants in the field or in livestock buildings. It measures CH₄ and CO₂ emissions.

Operating principles

This method is used for direct measurements of the gases emitted by animals when breathing or belching in the field or in livestock buildings. It is based on the principle of an inert tracer gas (sulfur hexafluoride, SF₆) that is released in the rumen and mixes with the other gases produced by enteric fermentation (CH₄, CO₂, etc). The tracer gas is contained in a permeation tube in the rumen. The release rate of the tracer gas is determined in vitro before introducing the permeation tube.

A representative sample of the gases released by the animal when belching and breathing is taken continuously through a capillary tube above the animal's nostrils which is connected to a pre-evacuated container which collects the gases over a 24 hour period. Air samples are sent to the laboratory to determine the concentrations of CH₄ and CO₂ by gas chromatography. The concentrations of CH₄ and CO₂ produced by the animal can be determined by subtracting the concentrations in the ambient air from the concentrations in the containers. As the tracer gas is released at a known constant rate the gas flow through the animal's mouth and nose can be estimated to determine the daily gas production by the animal.

This method was developed in the 1990s (Johnson *et al.*, 1994) and was used by INRA de Theix in 2003 for several days to check the reproducibility of the measurements. Guidelines have recently been issued by a group of international scientists as part of the Global Research Alliance (Berndt *et al.* 2014).

Equipment required

The equipment required is shown in Figures M18.1 and M18.2:

- Brass tube, custom made
- Brass nut
- Pure SF₆ gas
- Liquid nitrogen
- Teflon membrane ~0.4 mm
- 2 μ sintered filter
- Head collar
- Pre-evacuated container
- Capillary tube
- Gas chromatography system
- Nitrogen gas

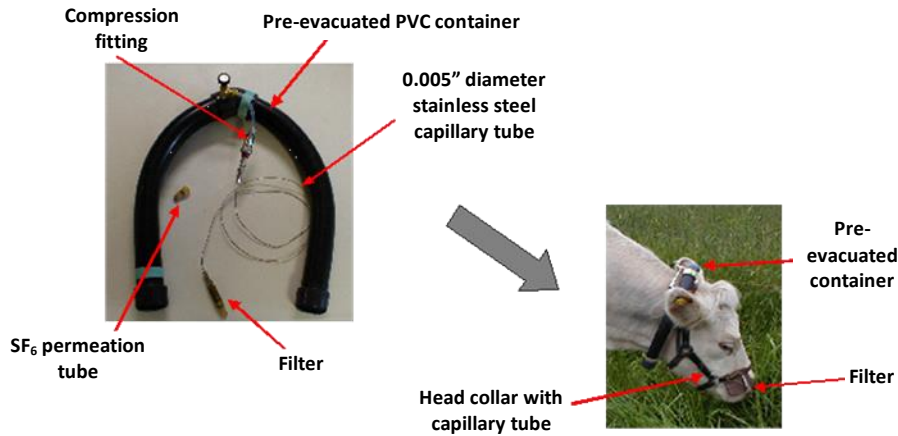

Figure M18.1. Equipment required

Implementation

The first step is to prepare the permeation tubes containing the SF₆ in the laboratory. This preliminary step requires expert knowledge and rigorous compliance with protocols. A precise quantity of SF₆ gas is introduced into a brass tube (Figure M18.2) and the release rate is measured (flow of SF₆ in ng.min⁻¹) through a Teflon membrane, whose thickness controls the gas release rate.

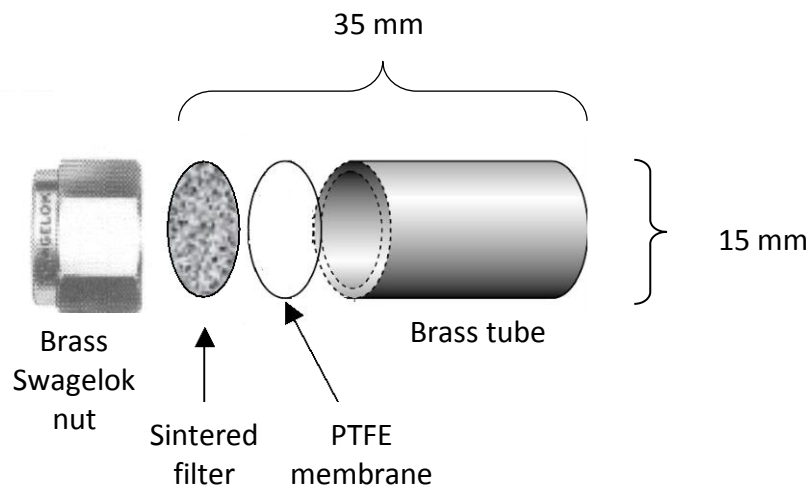

Figure M18.2. Permeation tube

The SF₆ gas is introduced by immersing the body of the tube in liquid nitrogen. When the capsule reaches a temperature of -196°C, it is removed from the liquid nitrogen and filled using syringes containing pure SF₆. The SF₆ freezes on contact with the tube and the amount of SF₆ in the tube can be seen. The tube is capped and placed in an Erlenmeyer flask swept by nitrogen gas at the temperature required for future use (eg: 39°C for insertion in the rumen).

The permeation rate of the SF₆ through the membrane must be determined to calculate the CH₄ and CO₂ produced. This is done by weighing the tubes (accurate to 0.1 mg). Measurements are usually taken over six to eight weeks to obtain a gas permeation measurement that is correct and stable (variation < 8%). The lifetime of the tube is also estimated based on the permeation rate and quantity of SF₆ in the tube.

The second step has the advantage that it can be carried out in controlled experimental conditions as well as in the field. At least ten days before the start of the measurements, each animal swallows a permeation tube of SF₆ tracer gas which stays in the rumen. Each animal is then fitted with a head collar and capillary tube and a pre-evacuated container is fitted to the animal each day, for 5 days.

The final step takes place in the laboratory. The gas samples collected are analyzed each day by gas chromatography (Application note 8) and the background concentrations of the gases in the ambient air are also measured.

CH₄ emissions (F_{CH_4} g.j⁻¹) are then calculated on the basis of the SF₆ flow (F_{SF_6} g.j⁻¹) using the following equation (Storm *et al.*, 2012):

$$F_{CH_4} = F_{SF_6} * \frac{C_{CH_4,animal} - C_{CH_4,atm}}{C_{SF_6,animal} - C_{SF_6,atm}} \text{ (eq. M18.1)}$$

where

$C_{CH_4,animal}$ and $C_{SF_6,animal}$ (ppm) are the gas concentrations measured for the gas in the containers and

$C_{CH_4,atm}$ and $C_{SF_6,atm}$ are the background concentrations in ambient air of the two gases also measured by gas chromatography.

Validation and sources of uncertainty

The measurement system must be calibrated regularly. The drift in the gas concentration measurements is checked using a reference gas (known, certified concentration). The gas chromatograph is very sensitive and the concentrations are determined with a very low coefficient of variation (CV).

Various factors may cause uncertainty:

- a high background gas concentration in the ambient air (particularly in a poorly ventilated building).
- damage to or poor handling of the gas collection device placed directly on the animal causing the loss of the sample and reducing the reproducibility of the method.
- the length of time for which the system can be used and the uniformity of the SF₆ permeation rate from the tube are limited.
- the preparation of the permeation tube.

Advantages and limitations

Advantages: This method measures the main emissions at animal scale in controlled experimental conditions and on farms, in particular while grazing. The samples do not have to be analyzed immediately which means that samples can be taken some distance away from the laboratory where they will be assayed. This method can be used for several animals and for several days to determine the variability between animals and from day to day.

Limitations: It is difficult to implement this measurement technique which is time-consuming and requires great attention to detail. Using SF₆ is also a drawback given its high global warming potential, even though only small quantities are used.

Costs: This method is costly as the gas collection system requires a lot of expensive equipment, as well as expensive laboratory assays.

References

Authors of the application note:

- Maguy EUGENE in collaboration with Yvonne Rochette and Cécile Martin, INRA, UMRH – Theix, France

Other organizations: Global Research Alliance (Ministry of Agriculture and Forestry Pastoral House, 25 The Terrace PO Box 2526, Wellington 6140, New Zealand).

Bibliography

- Berndt, A., Boland, T.M., Deighton, M.H., Gere, J.I., et al. 2014. Guidelines for use of sulphur hexafluoride (SF6) tracer technique to measure enteric methane emissions from ruminants. New Zealand Agricultural Greenhouse Gas Research Centre, New Zealand 166 p.
- Johnson, K., Huyler, M., Westberg, H., Lamb, B., Zimmerman, P. 1994. Measurement of methane emissions from ruminant livestock using a sf6 tracer technique. *Environmental Science & Technology*. 28 (2), 359-362 10.1021/es00051a025
- Storm, I.M.L.D., Hellwing, A.L.F., Nielsen, N.I., Madsen, J. 2012. Methods for measuring and estimating methane emission from ruminants. *Animals*. 2 (2), 160-183 10.3390/ani2020160

Application note 19 Estimating individual CH₄ and CO₂ emissions from cattle using Greenfeed™

Scope of application

The Greenfeed™ system was developed in 2011 (U.S. Patent 7966971) by C-Lock inc. (South Dakota, USA) to measure methane emissions from cattle in livestock buildings and out at pasture by limiting human intervention that might change the animal's behavior (Zimmerman *et al.*, 2013a; Zimmerman *et al.*, 2013b; Zimmerman *et al.*, 2011). This system was developed as an alternative to the indirect method using SF₆ tracer gas (Application note 18) which was more difficult to implement (Hammond *et al.*, 2013). More recently, C-Lock has also adapted the system to measure methane emissions from sheep. There are currently nearly a hundred GreenFeed™ systems in use in about twelve countries.

Operating principles

CH₄ and CO₂ are measured on an ad hoc basis each time the animal feeds from the GreenFeed™ system. The integral Greenfeed™ trough is used as bait to attract the animal and also collects the eructed and expired gases (Figure M19.1). Each animal is identified by an electronic tag which triggers the distribution of a portion of feed when the animal puts its head in the trough and records the frequency and number of times the animals comes to feed.

The ration is calibrated to ensure that the animal's head stays for at least five minutes inside the trough. While the animal is feeding, air is extracted at a controlled rate to sample the emissions from the nostrils and transport them to an NDIR analyzer which measures the CH₄ and CO₂ concentrations. As the collection system is open, a known quantity of a CO₂ tracer is released in the system to determine the gas collection rate (Figure M19.2). The CH₄ (CH_{4_volume}) emissions for example can be calculated by measuring the CH₄ and CO₂ concentrations (corrected for the ambient concentrations), the airflow and collection rate:



Figure M19.1. Animal feeding from a GreenFeed™ system (source: INRA)

$$CH_{4_volume} = F_c * C_R * \sum_{tp} [\Delta_t * (CH_{4_avg} - CH_{4_bkgnd}) * Q_{air}] \text{ (eq. M19.1)}$$

where

C_R is the gas collection rate, determined using a CO₂ tracer (%)

Δ_t is the time for measuring the emissions (1 second)

CH_{4_avg} is the mean CH₄ concentration during the measurement time (%)

CH_{4_bkgnd} is the background concentration of CH₄ (%)

Q_{air} is the airflow from the fan during the measurement time (flow per unit of time)

F_c is the conversion factor

Equipment required

The measurement system is shown in Figure M19.2 below.

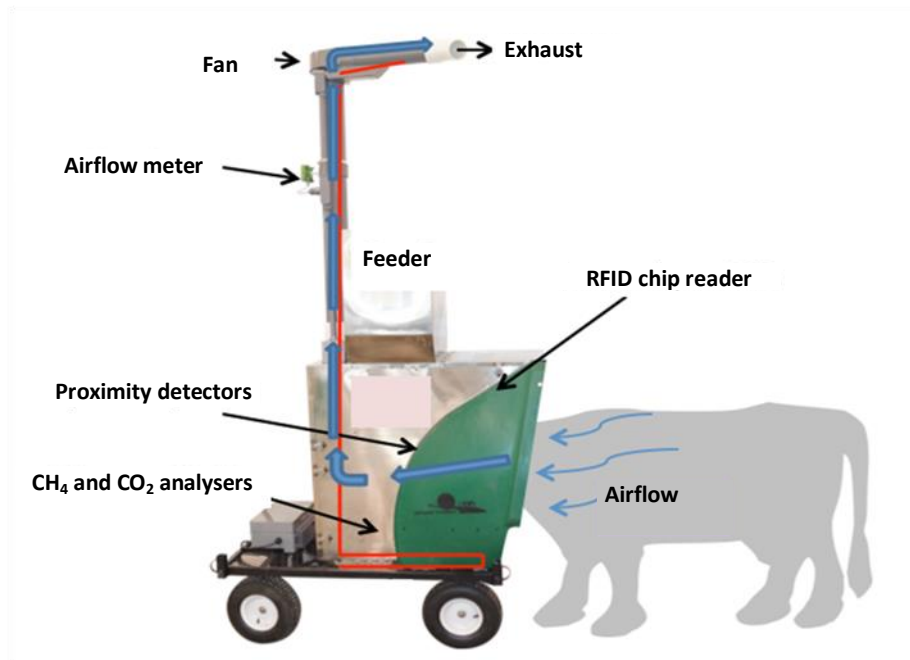

Figure M19.2. Main components of the GreenFeed™ system (from C-Lock Inc.)

Implementation

The instructions for use are still being drawn up and checked but more information about using Greenfeed™ systems can be found on the C-Lock-inc website: <http://c-lockinc.com/introduction.php>.

Validation and sources of uncertainty

The NDIR analyzer should be calibrated every day by injecting a mixture of reference gas with a certified concentration of CH₄ and CO₂. To determine the gas collection rate, a known quantity of CO₂ is released in the system and then analyzed by the NDIR analyzer. The gas concentrations and airflows are measured once a second. The following specifications are taken from the manufacturers application notes:

Flow measurement

- Precision at 20°C, 45% relative humidity, 1013 hPa: 0.2 m.s⁻¹ ±3%.
- Measurement range: 0.2-10 m.s⁻¹

CO₂ concentration measurement

- Linearity error: less than 1% full scale
- Precision: 0.5% full scale
- Measurement range: 0 to 1%
- Warm up: 5 minutes

CH₄ concentration measurement

- Precision: 3% of the reading + 1.5% of the measurement range. Account is not taken of the temperature and pressure, which may increase the error.
- Measurement range: 0 to 2,500 ppm
- Warm up: 30 minutes

Hydrocarbon concentration measurement

- Linearity error: less than 1% FS
- Precision: 0.5% FS
- Measurement range: 0 to 1%
- Warm up: 5 minutes

Temperature measurement

- Precision: $\pm 0.75^{\circ}\text{C}$
- Measurement range: -30°C to 80°C

Relative humidity measurement

- Precision: $\pm 2\%$ at 55% relative humidity (decreases at higher relative humidity)
- Measurement range: -30°C to 80°C

Advantages and limitations

Advantages: the Greenfeed™ system gives frequent ad hoc measurements of a large number of animals (20 animals per system) over a long period. As the equipment is mobile, measurements can be taken on experimental and commercial farms or out at pasture (Waghorn *et al.*, 2013). It is relatively easy to use the system and to carry out daily maintenance. This measurement system does not require laboratory services and can be calibrated and set up online.

Limitations: A minimum period of two weeks should be allowed for the animals to get used to the system and exclude animals that do not take food, or do not take food regularly, from the Greenfeed™ system. As the measurements taken by the system are ad hoc measurements, they must be carried out over a sufficiently long period so that there are enough measurements to be able to calculate a representative average value for the emissions from each animal. For a total of fifty visits (3 to 4 visits per day over 2 weeks), the repeatability for the average emissions measured was better than 70% (Renand *et al.*, 2013). This is better than the repeatability for the daily consumption of dry matter from a general feed distributed *ad libitum* averaged over the same period (Renand G., personal communication).

Cost: about €45,000

References

Authors of the application note:

- Y. Rochette, C. Martin, INRA, UMR H - St Genès Champanelle, France

- G.Renand, INRA, UMR GABI - Jouy-en-Josas, France.

Other organizations: C-Lock Inc. 2025 Samco Road Rapid City, SD 57702 - e-mail: contact@c-lockinc.com

Bibliography

- Hammond, K., Humphries, D.J., Crompton, L.A., Kirton, P., Green, C., et al. 2013. Methane (GreenFeed) compared emissions from growing dairy heifers estimated using an automated head chamber to respiration chambers or SF6 techniques. 5th Greenhouse Gases and Animal Agriculture Conference (GGAA 2013). Cambridge University Press. Dublin, Ireland, 23-26 juin 2013, *Advances in Animal Biosciences*, 4, (2), Page 391
- Renand, G., Ricard, E., Maupetit, D., Thouly, J.C. 2013. Variability among individual young beef bulls and heifers in methane emissions. 64. Annual Meeting of the European Federation of Animal Science (EAAP). Wageningen Academic Publisher. Nantes, 19, (1ère Ed.), 195-195. www.eaap2013.org
- Waghorn, G.C., Garnet, E.J., Pinares, C., Zimmerman, S. 2013. Implementation of GreenFeed for estimating methane in a dairy herd grazing pasture. 5th Greenhouse Gases and Animal Agriculture Conference (GGAA 2013). Dublin, Ireland, 23-26 juin 2013,
- Zimmerman, S., Brito, A., Huhtanen, P., Johnson, K., Michal, J.J., et al. 2013a. Measurement and evaluation of enteric CH4 emissions and variability in production systems. 5th Greenhouse Gases and Animal Agriculture Conference (GGAA 2013). Dublin, Ireland, 23-26 juin 2013,
- Zimmerman, S., Michal, J.J., White, R., Johnson, K.A., Guerouali, A., et al. 2013b. Evaluation of a novel system to measure enteric methane emissions from beef cattle on pasture. 2013 ADSA, AMPA, ASAS, CSAS, and WSASAS Joint Annual Meeting. Indianapolis, Indiana, USA, 8-12 July 2013,
- Zimmerman, P., Zimmerman, S., Utsumi, S., Beede, D. 2011. Development of a user-friendly online system to quantitatively measure metabolic gas fluxes from ruminants. Abstract 856. 2011 ADSA, AMPA, ASAS, CSAS, and WSASAS Joint Annual Meeting. New Orleans, Louisiane, USA, 10-14 July 2011

Application note 20 - System for measuring emissions from manure under controlled conditions

Scope of application

This system is used to determine, in identical, controlled conditions, the volatilization of ammonia (NH₃) and the emission of other gases (CH₄, N₂O, NO, CO₂, VOCs, etc) from manure stored outside or spread on fields. It can be used to examine the effect of various factors (composition of manure, temperature, airspeed) on the emissions, to define formulae for the emissions as a function of the factors and to evaluate the effectiveness of emission reduction techniques (eg: covering slurry pits, using additives, incorporating the manure in the soil).

Operating principles

The system uses the same principles as dynamic flux chambers (Application note 24) applied under laboratory conditions. The emissions are measured by mass balance. The emissions flux F (g.s⁻¹.m⁻²) is the product of the airflow q (m³.s⁻¹) and the difference in concentration between the concentration in the air leaving the flux chamber C_o (g.m⁻³) and in the air entering the flux chamber C_i (g.m⁻³) divided by the area emitting the emissions A (m²) (eq. M20.1).

$$F = \frac{q \times (C_o - C_i)}{A} \text{ (eq. M20.1)}$$

The main characteristic of this type of system is the use of identical chambers monitored simultaneously in controlled conditions (eg: temperature, humidity of the incoming air). This makes it possible to increase the number of directly comparable measurements and isolate the various factors which may affect the emissions. The gases may be collected for analysis elsewhere (eg: acid solution impingers) or measured online using an analyzer (eg: infrared spectroscopy, gas chromatography, laser spectroscopy).

Equipment required

- Sealable glass or stainless steel chambers containing the materials to be studied
- Clean air delivery system including:
 - pumps (for pressurization or evacuation) or compressed air (for pressurization)
 - flow regulators or a flow measurement system (eg: mass airflow meter, gas meter),
 - air conditioning unit to deliver air with known gas concentrations, humidity, etc for reproducing specific conditions or preventing the emitting materials from drying out,
 - pipework in appropriate materials (that do not react with ammonia, for example) that is identical for all chambers (eg: same pressure drop)
- Apparatus for measuring gas concentrations: acid solution impingers (Application note 3), infrared analyzer (Application note 10), gas chromatograph (Application note 1), etc
- A thermostatically controlled enclosure if the ambient temperature is to be controlled

Implementation

A known quantity of manure is placed in an empty chamber or a chamber containing a substrate (natural or modified soil, inert sand, etc). The chamber is sealed with a cap that has two openings to allow air to pass into the chamber. Air is introduced into the cell at a constant controlled flow to renew the headspace in the chamber continuously. The air leaving the chambers is analyzed later or in quasi-real time, depending on the technique selected. The emissions are then correlated with the experimental parameters or characteristics of the stored manure and the dimensions and shape of the storage unit.



This system has 12 emission chambers. Several different tests and replicates using different products can be undertaken at the same time. The system can be moved and used either in a laboratory or outdoors if it is protected from the weather. Each chamber operates by suction created by a pump at the exhaust end of the circuit so that the air is renewed taking in ambient air and not air that has passed through the pump. The incoming air is moistened by passing over water to minimize the evaporation of water from the samples. The air sweeps the surface of the samples and becomes loaded with gas. The ammonia in the air is then trapped in an impinger or assayed directly using an infrared spectrometer.

Figure M20.1. Measurement system at IRSTEA, Rennes

Validation and sources of uncertainty

The two main sources of error are:

- uncertainties in the flow control and/or flow measurement
- leaks from the system

For ammonia, the system can be calibrated by replacing the manure by a known quantity of a solution of ammonium salt and the volatilization measured by the system can be compared to the loss of ammonium from solution (Le Cadre *et al.*, 2005; Portejoie *et al.*, 2003).

When monitoring the various nitrogen gases and volatile organic compounds, if the incubation period is sufficiently long so that the change in mass and elemental concentrations can be measured, the N and C emissions from the manure and be calculated by mass balance and compared with the total emissions.

Advantages and limitations

Advantages: This method can be used to compare potential emissions from several substrates in identical controlled conditions for storage (LNE and MEDDTL, 2010; LNE and MEDDTL, 2012; Portejoie *et al.*, 2003) and/or spreading (Génermont *et al.*, 2013; Le Cadre *et al.*, 2005; Moal, 1994) conditions. Many parameters (eg: type of manure, environmental conditions, type of soil) can be tested separately with a number of replicates.

Limitations: Given the lack of a standard design and standard protocols, the measurements by different laboratories will have different, controlled or uncontrolled, ambient and experimental conditions: sampling airflow, air temperature and humidity, volume of substrate, volume of headspace, etc. As these have complex effects on the emissions, it is difficult to

compare the measurements produced by different laboratories. Furthermore, the shape and size of the chambers vary from one system to another, which implies differences in the flow and mass transfer within the chambers which directly affects the measurement, making it difficult to interpret results with respect to conditions in the field (storage on the farm or spreading on a field). This method is, therefore, only indicative. INRA is currently carrying out research to provide chambers with known, controlled flow properties and extend the system for characterizing ammonia emissions in controlled conditions using a model (Volt'Air) for extrapolating the measurements to field scale (Génermont *et al.*, 2013).

References

Authors of the application note:

- Laurence Loyon and Fabrice Guiziou, IRSTEA - Rennes, France

Other organizations: INRA, LNE

Bibliography

- Génermont, S., Flura, D., Autret, H., Masson, S., Decuq, C., et al. 2013. Prédiction de la volatilisation d'ammoniac au champ après épandage de produits résiduels organiques et d'engrais minéraux: résolution des questions scientifiques et techniques. (Predicting ammonia volatilization from fields after spreading residual organic products and mineral fertilizers: answering scientific and technical questions) ADEME-INRA conference 1081C0030. 70 p.
- Le Cadre, E., Génermont, S., Decuq, C., Recous, S., Cellier, P. 2005. A laboratory system to estimate ammonia volatilization. *Agronomy for Sustainable Development*. 25 (1), 101-107 10.1051/agro:2004060
- LNE; MEDDTL. 2010. Mise au point d'une méthode standardisée d'évaluation des produits visant à lutter contre les odeurs et les émissions gazeuses en élevage. (Developing a standardized method for evaluating products to eliminate odors and emissions from farms) 82 p.
- LNE; MEDDTL. 2012. Mise au point d'une méthode standardisée d'évaluation des produits visant à lutter contre les odeurs et les émissions gazeuses en élevage. (Developing a standardized method for evaluating products to eliminate odors and emissions from farms) Phase 2. 50 p.
- Moal, J.F.1994. Volatilisation de l'azote ammoniacal des lisiers après épandage: quantification et étude des facteurs d'influence. (Volatilization of ammonia from manure: quantification and study of influencing factors). Cemagref, Equipement pour l'eau et l'environnement, University of Perpignan, 230 p.
- Portejoie, S., Martinez, J., Guiziou, F., Coste, C.M. 2003. Effect of covering pig slurry stores on the ammonia emission processes. *Bioresource Technology*. 87 (3), 199-207 10.1016/s0960-8524(02)00260-2

Application note 21 Estimating emissions by mass balance for livestock buildings or manure storage

Scope of application

This method uses the mass balance approach for measuring emissions in terms of losses of carbon, nitrogen and water from livestock buildings or outdoor manure storage. The elemental inputs and outputs must be quantified by direct measurement or estimated by modeling. The losses must be measured for at least several weeks to ensure that the magnitude of the negative mass balance is greater than the uncertainties on the total inputs and total outputs (Robin *et al.*, 2010). Using this method in combination with concentration measurements is a simple, low cost means of measuring the main emissions from livestock buildings (CO₂, CH₄, N₂O and NH₃). This combination is detailed in the “simplified method of measuring emissions from livestock buildings” (Application note 22). Mass balance can also be used with emission measurements to determine the relevance and reliability of the emission measurements. Comparing these emission measurements to the mass balance for N, C, P, K and water ensures that the measurements are reasonable. The mass balance for water (H₂O) checks that the air sample is representative and that the mass balance input data is valid. The mass balances for P and K check the quality of the manure sampling and the input data to the mass balance. The mass balances for N and C check the order of magnitude of the emissions for N₂O and NH₃.

Operating principles

Mass balance compares the initial and final content of various elements (eg: N and C) and water in a system, taking account of inputs into and outputs from the system. Any imbalance represents the losses of elements in volatile compounds.

In livestock buildings, the elemental inputs are in the litter and animal feed. Elements can be exported or fixed through the manure, animal growth and products (milk, eggs and gestation). For each element there is a mass balance:

$$\text{Mass balance} = \text{Inputs} - \text{Outputs} = \\ \text{Feed} + \text{litter (or manure)} + \text{animals at start of period} - \text{slurry} - \\ \text{animals at end of period} - \text{products} \quad (\text{eq. M21.1})$$

For storage of manure, the inputs and outputs are the manure. For composting manure on straw, the straw is also considered to be an input.

- For volatile compounds, the mass balance is positive and corresponds to the emissions. The carbon balance is used to determine the total carbon emissions (mainly in the form of CO₂ and CH₄). the nitrogen balance is used to determine the total nitrogen emissions (mainly in the form of NH₃, N₂O and N₂)
- For non-volatile compounds, the mass balance is approximately zero, allowing for sampling and analysis errors.

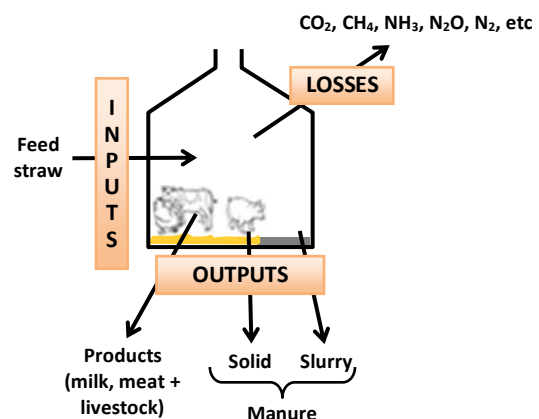

Figure M21.1. Inputs and outputs for a livestock building (source: Elise Lorinquer, Idele)

Equipment required

- Equipment for taking and packaging feed, litter and manure samples. If the samples cannot be transported directly to the laboratory, they should be frozen.
- Elemental analyzers. The samples can be analyzed by certified laboratories.

Implementation

The following data about the farming system studied are required before undertaking the measurements (only certain data are required for the storage stage: these are marked with an *):

- number of animals at the start and end of the measurement period and mortality
- quantity of feed consumed during the measurement period (broken down by type of feed for multiphase feeding) and quantity of water drunk
- quantity of litter at start and quantity added*
- quantity of manure at start and quantity exported during and remaining at the end of the measurement period*
- weight of the animals at the start and end of the measurement period
- lean meat percentage for pig production
- elemental content of the feed, products (eggs, milk, etc), manure* and litter*

These data are obtained by measurement on the farm (for example, weighing the samples at the end of a batch). If some data are not available, published values could be used but this may significantly affect the precision of the results as data may vary considerably from farm to farm.

Procedure:

- Sampling the manure and litter for elemental analyses. To be representative, sampling should take account of the non-uniform distribution of the manure throughout the floor area of the building and depth (multiple samples should be taken at different locations) as well as sedimentation of certain elements in the manure, in particular phosphorus and dry matter (slurry should be stirred before sampling).
- Elemental analysis of the feed, litter and manure. For pig and poultry farms, the feed composition given by the manufacturer can be used, although it is advisable to repeat the analyses. For cattle feed, the fodder should be analyzed.

As the calculation principles are the same for all elements, only the nitrogen balance is given below.

Nitrogen balance

The nitrogen balance is broken down into the change in the content in the manure, litter and growth of the animals. The following formula is used:

$$EmissionsN_{gas} = (N_{manure,start} + N_{litter,start} + N_{litter,added} + N_{feed} + N_{animals,start}) - (N_{manure,end} + N_{litter,end} + N_{animals,end} + N_{products,end}) \text{ (eq. M21.2)}$$

Where N is the nitrogen,

start is the start of the measurement period

end is the end of the measurement period.

The quantities of nitrogen in the litter, manure and feed are obtained by multiplying their mass by their nitrogen concentration. The mass can be obtained by weighing (manure, feed and litter) or by estimating the volume (measuring the depth of slurry) together with measuring the density and concentrations by elemental analysis.

The N fixed during the growth of the animals is obtained from the weight gain and the N concentration in the animals. The N concentration in the animals (N_{animals}) can be obtained from the standard equations issued by the Comité d'Orientation pour des pratiques agricoles respectueuses de l'environnement (CORPEN). For dairy cows during lactation, account is not taken of the change in quantity of body nitrogen but of the nitrogen exported in the milk. Similarly, for laying hens, account should be taken of the nitrogen exported in the eggs.

Validation and sources of uncertainty

The main sources of uncertainty are:

- taking and preparing the manure and the litter samples
- the composition of the feed (difference between the true concentrations and the concentrations given by the manufacturer)
- the concentration of the elements in the animals (equation and weight of animals)
- mortality

If there are major differences (> 20%) for the test elemental mass balances (P, K), the concentrations of the elements in the feed, litter and manure should be compared against national averages. For manure storage, major discrepancies in the P balance and small discrepancies for the K balance suggest that the sampling for dissolved elements (about 75% of the nitrogen in slurry) was correct but that the sampling of the sediment (most of the carbon) was less representative.

Advantages and limitations

Advantages: This method is relatively simple to implement and does not require any complex or expensive equipment. The orders of magnitude are generally reliable and can be checked against the mass balances for elements not found in the volatile compounds. Applying this method to storage, however, is less satisfactory when the losses are small by comparison with the inputs. The error estimated using mass balance for elements not found in the volatile compounds may be close to the estimated losses of the elements in the volatile compounds. However, for livestock buildings and manure storage, the method is strongly recommended as an adjunct to direct measurement of emissions to check the orders of magnitude.

Limitations: The mass balance method cannot determine which gases are emitted and the uncertainty may be high for large-scale animal production, where national averages (elemental concentrations in manure and feed and the quantity of manure produced) are used. However, it can be combined with other measurement methods (for example, concentration ratios, see Application note 22) to evaluate the emissions of each compound and check the measurements. It cannot be used for periods less than a week as the errors in the terms in the equation will be too large in comparison to the emissions being estimated.

References

Authors of the application note:

- Mélynda Hassouna and Paul Robin, INRA, UMR SAS – Rennes, France

Other organizations: IFIP, Itavi, Idele, Chambers of agriculture

Bibliography

Robin, P., Amand, G., Aubert, C., Babela, N., Brachet, A., et al. 2010. Procédures de référence pour la mesure des émissions de polluants gazeux des bâtiments d'élevage et stockages d'effluents d'élevage. Rapport final. [Standard procedures for measuring pollutant gas emissions from livestock buildings and manure storage. Final report.] (contract 06 74 C0018). 519 p.

Application note 22 - Simplified method for measuring emissions from livestock buildings using concentration ratios and mass balance

Scope of application

This is a simplified method for non-intrusive measurement of emissions locally in livestock buildings (feed + buildings). It can be used for ad hoc measurements of emissions of CO₂, CH₄, N₂O, water vapor and NH₃ in poultry, cattle and pig buildings with natural or forced ventilation on condition that the inputs (feed, litter, etc) and outputs (manure, meat, milk, etc) can be clearly quantified and characterized chemically. For poultry and pig buildings, this method can be used to measure the emissions of a batch of animals.

Operating principles

This method is based on coupling the mass balance method for calculating carbon loss from the building (Figure M22.1 and Application note 21) with the difference in concentrations between the inside and outside of the building for each gas of interest (NH₃, N₂O, CH₄, CO₂, H₂O).

This method is based on two assumptions:

- most of the carbon volatilized is in the form of CO₂
- ammonia and greenhouse gas emissions are proportional to the CO₂ emissions when the livestock production and manure storage conditions are stable.

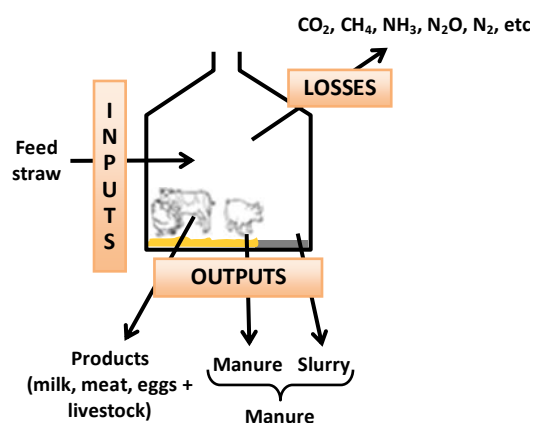

Figure M21.1. Inputs and outputs for a livestock building

The mass balance for N, C, P, K and water can be used to ensure that the results are reasonable. The water balance is used to check that the air samples are representative and that the mass balance data are valid. The mass balances for P and K are used to check the overall quality of the mass balances. The mass balances for N and C are used to check the orders of magnitude of the emissions calculated for nitrogen compounds N₂O and NH₃ and carbon compounds (CH₄ and CO₂).

Figure M22.2 shows the general flow of the method.

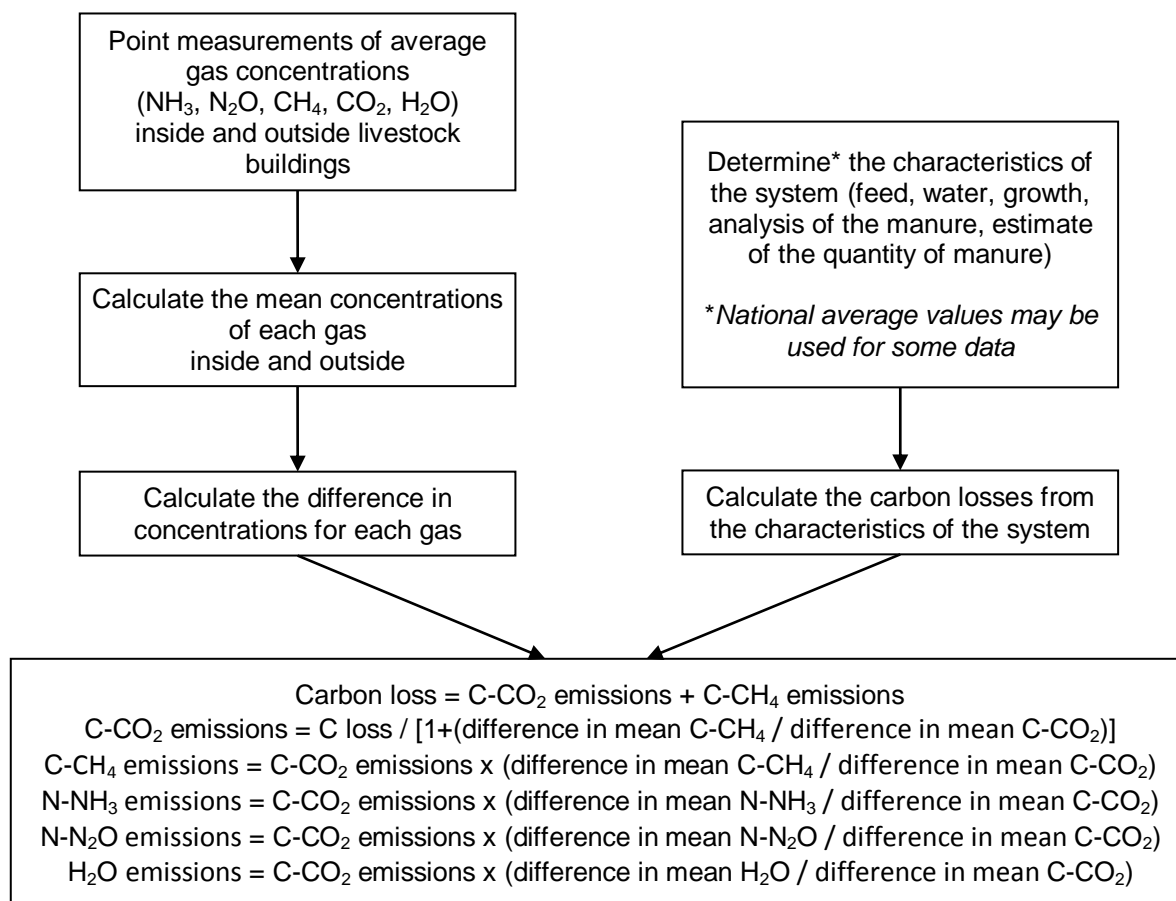

Figure M22.2. Calculating emissions based on gas concentrations and system characteristics

Equipment required

- Measuring concentrations:
 - Gas analyzer for CO₂, N₂O, CH₄, NH₃ and H₂O (eg: infrared spectroscope)
- Taking air samples on cattle and poultry farms:
 - Sample bags in a material that limits the adsorption of NH₃ on the walls (eg: FlexFoil sample bags)
 - Air pump
 - Filters at the input to the sampling system (eg: 0.45 μm)
 - PTFE (polytetrafluorethylene) tube to connect the sampling system and the analyzer
- Taking air samples in pig houses:
 - PTFE (polytetrafluorethylene) tube for taking air samples with the analyzer
- Thermometer-hygrometer to measure the temperature and humidity inside and outside the building

Implementation

For cattle and poultry, ad hoc measurements of emissions from buildings are made by taking several air samples in sample bags. Two sets of measurements are taken to provide uniform, representative samples of indoor and outdoor air, one inside the building and the other outside (Hassouna *et al.*, 2010; Ponchant *et al.*, 2009). Samples of the ambient air are taken using an air pump or a sample bag in a vacuum chamber with pump (Application note 5). The samples are then analyzed on site or in a laboratory using a gas analyzer.

In pig houses with forced ventilation, the air is sampled and analyzed directly using a gas analyzer every 2 minutes in the exhaust ducts over a period of 4 hours (Guingand *et al.*, 2010) and an average concentration is then calculated using the concentrations recorded.

As this method uses point measurements, the outdoor samples must be taken in places where there will be no interference from temporary point sources of emissions such as vehicle engines and fires. When taking samples inside the building, particular attention must be paid to the activity of the animals. For example, for cattle buildings, samples must be taken indoors when the animals have been fed and are no longer lying on the litter, otherwise the aeration of the litter when the animals stand up and move around may temporarily increase the level of gas concentrations and dust in the building.

Several ad hoc measurements are required to characterize the emissions for a batch or over a period, as the relative proportions of gas concentrations may change with time. The number of samples required and the sampling times depend on the type of animal production studied and have been determined during experiments undertaken to define the methodology. For example, for pregnant sows, research carried out by the French Pork and Pig Institute (IFIP) showed that three sampling days (after 6-9 days, 18-22 days and 30-34 days presence in the building) were adequate to give the best representation of the changes in concentrations while the animals were in the building.

Validation and sources of uncertainty

The measurements taken are checked by comparing the water loss with the water balance and comparing nitrogen emissions with the nitrogen balance. Previous experiments showed that there was a difference of less than 30% between the direct calculation of emissions and the mass balance (C, N, H₂O) which was considered to be acceptable for the purposes for which the data were acquired. If there is a difference of more than 30%, the quality of the air samples is considered to be unrepresentative and the measurements are not considered to be valid.

Sources of uncertainty are:

- the gas analyzer used
- the mass balances
- the operator and representativeness of the air samples
- the sampling methods and the packaging of the samples
- the climatic conditions while measurements were being taken (humidity in particular)
- interpolation of the emissions

Advantages and limitations

Advantages: this method can be adapted to any type of farming (any type of building, farming practice, etc) and is easy to implement. The method is still being improved for cattle buildings (C balance, type of feed, taking account of different physiological phases, etc). This method produces rapid measurements of emission levels but the uncertainty must be evaluated to assess the quality of the measurements.

Limitations: from a qualitative point of view, as this method is based on point measurements, it could be considered that the measurements obtained are associated with a higher level of uncertainty than continuous measurements. The method is very sensitive to the quality of the mass balance. National averages can be used for standardized animal production (pigs and

poultry) for which reliable data are available, in particular for the quantities and composition of manure. For non standard production conditions, *in situ* analyses of manure and estimates of the quantities of manure produced are required.

Costs: This method is inexpensive and costs around €100 to €200 for the equipment and analyses for a farm (excluding the cost of the gas analyzer).

References

- Melynda Hassouna and Paul Robin, INRA, UMR SAS – Rennes, France
- Paul Ponchant, ITAVI – Ploufragan, France
- Elise Lorinquer, IDELE– Le Rheu, France
- Nadine Guingand, IFIP– Le Rheu, France

Bibliography

- Guingand, N., Lagadec, S., Robin, P., Hassouna, M.2010. A simplified method to assess greenhouse gas and ammonia emission factors of fattening pigs reared on fully slatted floor. ASABE Conference. Dallas (USA), 13-16th September, 2010, p. 10 p.
- Hassouna, M., Robin, P., Brachet, A., Paillat, J.M., Dollé, J.B., et al. 2010. Development and validation of a simplified method to quantify gaseous emissions from cattle buildings. XVIIth World Congress of the International Commission of Agricultural Engineering. Québec City, Canada, June 13-17, 2010, p. 1-10
- Ponchant, P., Hassouna, M., Aubert, C., Robin, P., Amand, G.2009. Application et validation d'une méthode de mesures simplifiées des gaz à effet de serre en bâtiment d'élevage avicoles. 8èmes Journées de la Recherche Avicole. St-Malo, France, 25-26 mars 2009, p. 100-104 (Application and validation of a simplified method for measuring greenhouse gas emissions from poultry buildings. 8th Poultry Research Conference. St-Malo, France, 25-26 March 2009, p. 100-104)

Application note 23 Using static flux chambers to measure emissions from litter, manure and soils

Scope of application

This method is used for measuring gas emissions at local scale usually for areas less than a square meter. On farms, in particular for animal production, nitrogen oxides (NO, N₂O), carbon dioxide (CO₂), methane (CH₄) and certain volatile organic compounds (VOCs) may be measured using static flux chambers. Given the great affinity of ammonia for water, this method is not usually used to measure ammonia and measurement using dynamic flux chambers (Application note 24) or micrometeorological methods (Application notes 26 to 31) is preferred. Static flux chambers are used mainly to characterize the gaseous fluxes after spreading manure on fields but they can be adapted for emissions from manure storage (slurry pits, lagoons, manure heaps) and from pasture land.

Operating principles

This method estimates the fluxes from a source based on the accumulation dynamics (dC/dt) of the gases inside a sealed chamber placed on the surface of the source. The limit of detection depends on the ratio between the volume (V) and the area (A) of the chamber, the gas analyzer and the integration time. The time taken for the measurement may vary from a few minutes to a few hours. For a system that is perfectly closed with no outside influences, the accumulation is linear while the chamber is being used and the gas fluxes (F) are, therefore, proportional to the accumulation slope (dC/dt or a) as shown in the following equation:

$$F = \frac{V}{A} \frac{dC}{dt} = \frac{V}{A} a \quad (\text{eq. M23.1})$$

This method can measure both positive and negative fluxes. Depending on the type of source studied, fairly large flux chambers should be used (ground area of a significant fraction of a square meter) to take account of the spatial variability of the fluxes and a number of measurements should be taken to obtain representative values for fluxes at the scale of the source of emissions considered. Although the static flux chamber method is one of the most common flux measurement methods for which there are many methodological references (Hutchinson and Livingston, 2002; Livingston and Hutchinson, 1995; Mosier *et al.*, 1990), it is not standardized. The implementation protocols still depend largely on the gas, the source and analysis equipment used (Rochette and Eriksen-Hamel, 2008).

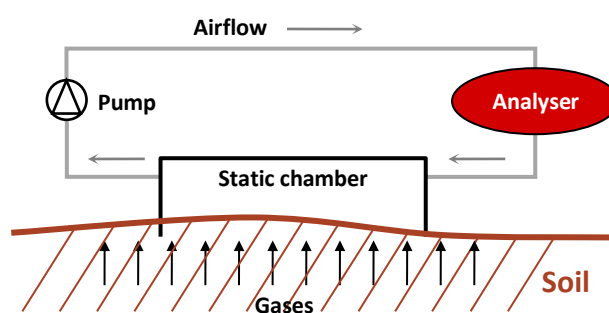

Figure M23.1. Continuous measurement recirculating chamber (system patented by INERIS – Polkryska and Tauzière, 1999)

Equipment required

Figures M23.1 and M23.2 show two types of static flux chamber: the first uses an inline gas analyzer and the second uses traps for instantaneous or integrative sampling. The method selected will depend on the type of gas analyzer used. For real-time analysis (Figure M23.1), the greenhouse gas concentrations (CH_4 , N_2O , CO_2) and certain hydrocarbons can be detected using infrared spectroscopy (Application note 10). NO concentrations are usually determined by chemiluminescence (Application note 9) but infrared spectroscopy can also be used.

For systems with traps (Figure M23.2), the gases can also be assayed by gas chromatography (Application note 8). If samples are taken from the chamber for subsequent analysis, they can be stored in small pre-evacuated tubes (a few mL) (Application note 5).

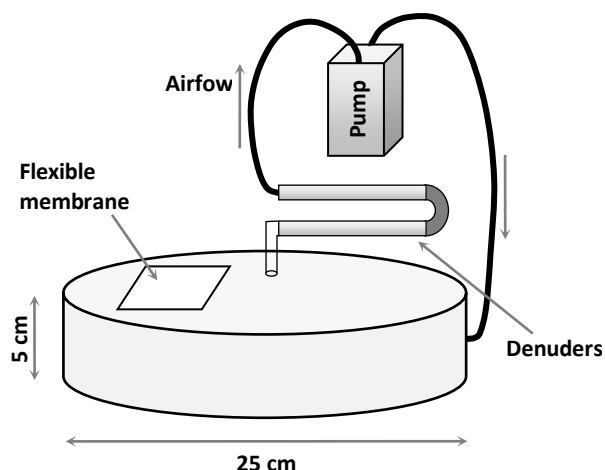

Figure M23.2. Chamber with sampling system for integrative measurement using traps (Tillman *et al.*, 2003)

The air circulates through a cartridge with various traps for a few minutes or a few hours. When the sampling is complete, the compounds are extracted and assayed.

Validation and sources of uncertainty

Static flux chambers are an intrusive method which changes the emission conditions at the surface of the soil, in particular by changing the turbulence, the pressure fluctuations and the differences in concentration between the soil and the atmosphere (Matthias *et al.*, 1978). Gas diffusion theory would predict that the increase inside the chamber during deployment would not be linear and some non-linear models have been proposed (Healy *et al.*, 1996). To minimize these effects and be able to use a linear approximation, it is important to limit the measurement time, ensure that the gas is thoroughly mixed inside the chamber (eg: fan, mixing using a sampling syringe), sink the chambers into the ground or substrate to prevent lateral diffusion so far as possible and provide a vent that will balance the pressure inside the chamber with the pressure outside.

The measurements can be checked visually or statistically. Plotting the concentration with time enables the linearity to be checked: the coefficient of determination R^2 is widely used as an estimator and the maximum slope can also be taken into account. The level of precision of the flux measurement depends directly on the precision of the analyzer and the measurement conditions (leaks, duration) and also on the estimate of the V/A ratio. The detection threshold of the method can be evaluated from the calculated error on the determination of the slope. It is inversely proportional to the square root of the number of measurements ($1/\sqrt{n}$) and depends on both the sensitivity of the analyzer and the V/A ratio. The detection threshold can be minimized by finding a good compromise between the length for which the flux chamber is deployed, the sensitivity of the analyzer and the height of the chamber. This requires a certain experience.

Advantages and limitations

Advantages: Static flux chambers are relatively easy to use depending on the concentration analysis method used. Unlike dynamic flux chambers where the differences in concentration are small, the gases accumulate in the chamber during the measurement period and highly sensitive gas analyzers are not required. They are, therefore, frequently used.

Limitations: Unlike micrometeorological methods, static flux chambers are intrusive and cannot be used for direct estimates at field or manure storage scale. For spatial extrapolation, a sampling strategy using several chambers is required to reflect the variations in emissions over the area. A fairly complex infrastructure is required for inline measurements: 220 V supply, temperature controlled enclosure, etc. Time-sampled monitoring would be possible using a PLC and multiplexer, with actuators to open and close the chambers. The PLC would store a series of gas samples in bags or tubes for subsequent assay (Application note 5).

Costs: The costs and complexity of the implementation depend on the materials used for the chamber and automated sampling system.

References

Authors:

- Patricia Laville, INRA, UMR EGC – Thiverval-Grignon, France

Other organizations: ITAVI, IDELE, CETIOM, Arvalis – Institut du Végétal

Bibliography

- Healy, R.W., Striegl, R.G., Russell, T.F., Hutchinson, G.L., Livingston, G.P. 1996. Numerical evaluation of static-chamber measurements of soil-atmosphere gas exchange: Identification of physical processes. *Soil Science Society of America Journal*. 60 (3), 740-747
- Hutchinson, G.L., Livingston, G.P. 2002. 4.5 Soil-Atmosphere Gas Exchange. *Methods of Soil Analysis: Part 4 Physical Methods*.(methodsofsoilan4), 1159-1182
- Livingston, G., Hutchinson, G. 1995. Enclosure-based measurement of trace gas exchange: applications and sources of error. In: Matson, P.A., Harris, R.C. (Eds.), *Biogenic trace gases: measuring emissions from soil and water*. Blackwell Science pp. 14-51
- Matthias, A.D., Yarger, D.N., Weinbeck, R.S. 1978. A numerical evaluation of chamber methods for determining gas fluxes. *Geophysical Research Letters*. 5 (9), 765-768
- Mosier, A.R., Mohanty, S.K., Bhadrachalam, A., Chakravorti, S.P. 1990. Evolution of dinitrogen and nitrous-oxide from the soil to the atmosphere through rice plants. *Biology and Fertility of Soils*. 9 (1), 61-67 10.1007/bf00335863
- Rochette, P., Eriksen-Hamel, N.S. 2008. Chamber measurements of soil nitrous oxide flux: Are absolute values reliable? *Soil Science Society of America Journal*. 72 (2), 331-342 10.2136/sssaj2007.0215
- Tillman, F.D., Choi, J.W., Smith, J.A. 2003. A comparison of direct measurement and model simulation of total flux of volatile organic compounds from the subsurface to the atmosphere under natural field conditions. *Water Resources Research*. 39 (10), 1284 doi:10.1029/2003wr002098

Application note 24 Dynamic flux chambers and wind tunnels

Scope of application

Dynamic flux chambers with controlled air circulation are generally used to characterize the emissions of reactive compounds such as ammonia, nitrogen oxides and volatile organic compounds. They are also used, to a lesser extent, for other gaseous compounds. They can be used to measure emissions in a laboratory, often in closely controlled conditions (Application note 20), as well as *in situ*, to characterize emissions from manure storage systems or from manure spreading.

Wind tunnels (Lockyer, 1984) are sometimes considered as “highly dynamic” chambers. They are a good compromise between static flux chambers (Application note 23) and the integrated horizontal flux (IHF) method (Application note 26). Relatively small, portable equipment can be used for *in situ* measurements of small areas (of the order of 1 square meter), causing less disruption to the local environmental conditions than static flux chambers, in particular because the conditions are controlled (for example, the wind speed is imposed). It is, therefore, possible to carry out replicate measurements and compare several treatments by installing several tunnels at the same time (Misselbrook *et al.*, 2005; Moal *et al.*, 1995; Parnaudeau *et al.*, 2009; Sommer *et al.*, 1991; Sommer and Olesen, 1991).

Operating principles (wind tunnel)

A small area is swept with a controlled airflow in a tunnel enclosing the area. The airflow is imposed, it is strong and can simulate wind, one of the major factors controlling volatilization. The volatilization flow F_s ($\mu\text{g}\cdot\text{m}^{-2}\cdot\text{s}^{-1}$) for a compound is determined from the difference in concentrations between the input and output of the tunnel:

$$F_s = q \times \frac{(C_o - C_i)}{A} \text{ (eq. M24.1)}$$

where

C_o and C_i ($\mu\text{g}\cdot\text{m}^{-3}$) are the concentrations of the compound of interest at the output and input of the tunnel respectively,

q ($\text{m}^3\cdot\text{s}^{-1}$) is the airflow in the tunnel and

A (m^2) is the area covered by the tunnel.

In this approach, the turbulent component of the airflow is ignored.

Equipment required (wind tunnels for ammonia)

- The experimental area, which varies from several square meters for manure storage to several hectares for spreading. Different spreading methods may also be assessed at small scales over an area of about 2 m by 0.5 m delimited by aluminum bars at right angles to give a measurement area of 1 m^2 . For assessing spreading methods in such a small area, the manure must be spread as evenly as possible while reproducing the possible variations caused by the application doses or methods.
- The tunnel (Figure M24.1): covers the measurement area with either:
 - a flexible sheet of polycarbonate which transmits most of the solar radiation and does not react with the ammonia, in an inverted U on the rectangular base, giving an effective tunnel height of about 0.45 m or
 - a rectangular metal duct

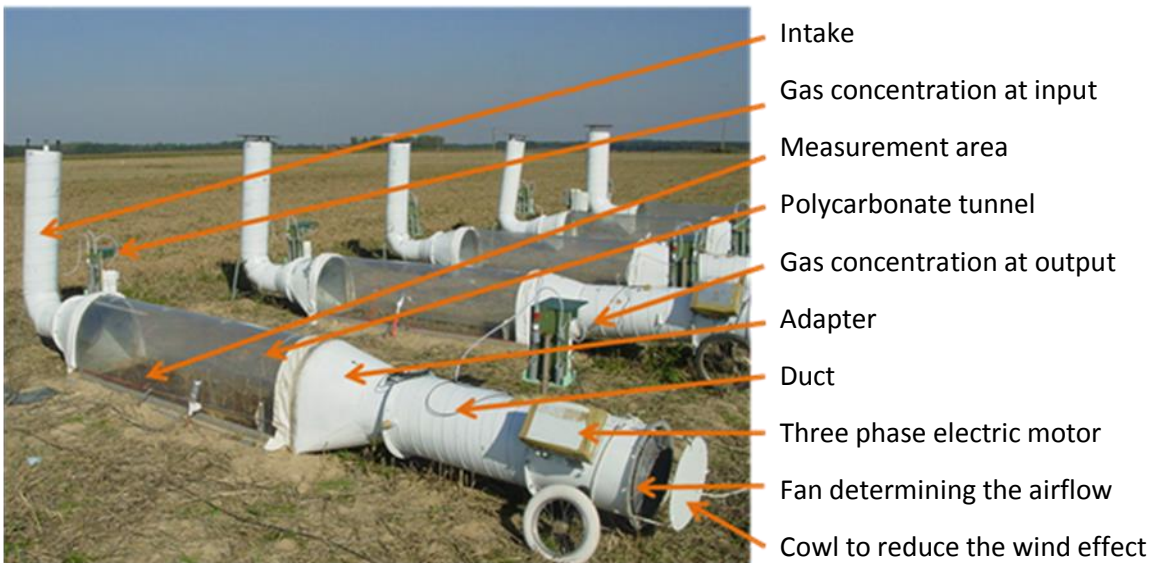

Figure M24.1. A set of wind tunnels used for comparing the effect of different treatments in the field

- The duct (Figure M24.2): is connected to the tunnel by an adapter between the inverted U or rectangular cross section of the tunnel and the circular duct. The duct is made of galvanized steel to prevent ammonia being adsorbed. The instruments for measuring the airspeed (to calculate the airflow) and ammonia concentration are fitted to the duct. As Loubet *et al.* (1999a and 1999b) showed that the position of the sensors can affect the accuracy of the airflow measurements, an open stream should be arranged with a diameter less than the duct. The airspeed will, therefore, be uniform across the whole cross section of the open stream, providing a reliable measurement of the airspeed. Alternative, less frequently used, methods include a mixing chamber (Reitz *et al.*, 1998) and a honeycomb diffuser (Moal, 1994).
- The airspeed sensor in the duct: for continuous measurement with (i) hot wire anemometer or a more robust hot column mass flow sensor, (ii) a cup anemometer, either of which can be used to measure the speed at one point in the duct, or (iii) a vane with several Pitot tubes for an integrative measurement of the airspeed at several points across the diameter of the duct.
- The air sampling system for measuring the gas concentration: Loubet *et al.* (1999a; 1999b) also showed that determining the ammonia concentration by taking samples from a single point in the center of the duct could underestimate the fluxes. It is, therefore, recommended using a sampling system that has several branches (3 or 4) in several directions across the duct, with sampling points distributed to be representative of the concentration across the whole of the cross section of the duct (Figure M24.2).

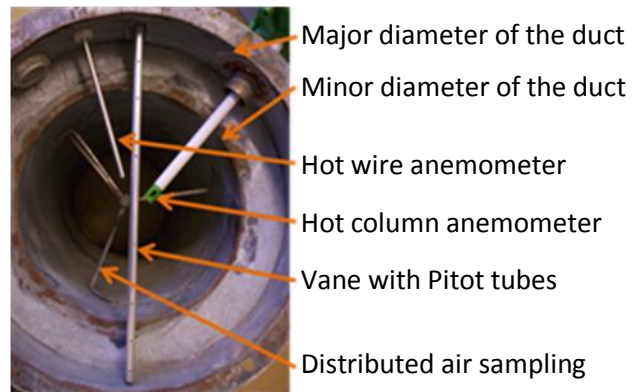

Figure M24.2. Cross section of the duct

This cross section shows the open stream with 3 airspeed sensors, and at the back, the distributed air sampling system at the output from the tunnel.

- The fan: the fan is driven by a three phase electric motor that is sufficiently powerful so that it is not affected by the wind outside the tunnel. The fan characteristics, combined with those of the duct, should give an airflow of around $0.5\text{-}1\text{ m}^3\cdot\text{s}^{-1}$ at zero pressure drop, depending on the motor speed, to create average airspeeds through the tunnel of around one meter per second, which are realistic of average conditions close to the surface of the soil. In certain cases, flat cowls are also fitted about ten centimeters from the ends of the tunnels to prevent the airflow being affected by the outside wind.
- The intake pipe: in an environment with high ammonia emissions from manure spreading, it is recommended that the air sweeping the soil should be sampled from about 1.50 m above ground using a pipe at the input to the tunnels. This ensures that the air entering the tunnel is not unduly affected by the outside surface, has low ammonia concentrations and is uniform between tunnels. The pipe, like the duct, is made of galvanized steel, preferably the same diameter to minimize any additional pressure drop. It is also connected to the tunnel by an adapter.

The tunnels can be fitted with floats to measure emissions from slurry storage.

Implementation

Although the tunnels are portable, this method may be relatively difficult to implement: a 220 V supply is required for use in a field. It is easier to find an electrical supply close to a manure store. To include the effects of rain or cultivation on the land, these must either be simulated manually inside the tunnels, with the risk of not reproducing them correctly, or the tunnels must be moved regularly across the surface being measured. Furthermore, it is generally accepted that additional measurements are required when monitoring fluxes to interpret the results with respect to the conditions (surface temperature and humidity, incident radiation, etc).

The concentrations can be assayed using inline analyzers such as infrared spectrometers (Application note 10) or impingers (Application note 3), to measure several points at the same time over integrative periods ranging from a few hours (just after spreading, for example), a few days (for periods after spreading during which the fluxes are expected to be lower), to a few weeks or months (for monitoring manure storage).

Validation and sources of uncertainty

Positioning the tunnels directly on the emitting surface may require account to be taken of the unevenness of the distribution of the manure which may have a major effect: it is recommended that several tunnels should be used to evaluate the fluxes. Misselbrook *et al.*, (2005) assessed the repeatability of measuring ammonia emissions from manure spreading by using 3 wind tunnels per treatment. In their study, the coefficient of variation ranged from 29% to 74% depending on the type of manure spread, the variability being lower the more liquid the manure. Several experimental studies have assessed the performance (correspondence between measured losses and measured emissions) of various types of wind tunnel (Christensen and Sommer, 1989; D uthmann, 2002; Reitz and Kutzbach, 1998; van der Weerden *et al.*, 1996): the ratio varied from 70% to 100% but it does not seem possible to define a generic correction factor.

The major source of uncertainty for determining fluxes using wind tunnels is the measurement of the airflow, as was shown by Loubet *et al.*, (1999a; 1999b). Particular care

should be taken to measure the airflow accurately, as the airflow not only has a significant direct effect on the measurement but also affects the emissions themselves as NH_3 volatilization depends on the wind speed.

Advantages and limitations

Advantages: Dynamic flux chambers can be used to detect very low emission fluxes and they are easy to install in the form of wind tunnels. They can be used to carry out multiple experiments to determine the influence of various factors on the emissions from slurry or manure spreading. Furthermore, the environmental conditions can be controlled reasonably accurately.

Limitations: The main limitation on using wind tunnels is that they modify the experimental conditions. In general, the temperatures of the air inside the tunnel, and the slurry or manure covered by the tunnel, and the soil inside the tunnel, are higher than areas that are not covered (in the field, about 1.5°C difference for the soil and 1°C for the air due to a greenhouse effect which is reduced by the airflow). Furthermore, for use in the field, rain is not included in the water balance of the surfaces within the wind tunnel, unless the tunnel is moved. For manure storage, rainwater is not excluded from the manure. Finally, the wind speed in the tunnel is not the same as the wind speeds found over the surface of liquid manure, over piles of solid manure or across the whole of the field. Genermont and Cellier (1997) showed an “oasis”⁹ effect with higher fluxes obtained for small fields. Similarly, wind tunnels give results closer to those of the entire surface when the wind speed in the tunnels is the same as those measured outside (Ryden and Lockyer, 1985), but wind tunnels are never used in this way. In conclusion, using a wind tunnel is a method suitable for experiments comparing different treatments. For establishing emission factors for gases, it is essential to measure the environmental conditions in the tunnel and in the open (temperature, wind speed) to determine whether the measured emissions are representative. The measured emissions can also be compared to the N and C losses estimated by mass balance in the manure, particularly when using wind tunnels for assessing emissions from storage. If there are major differences, extrapolating wind tunnel measurements to a complete field is unsatisfactory.

References

Authors:

- Sophie Générmont, INRA, UMR EGC – Thiverval Grignon, France

Other organizations: INRA, IFIP, IRSTEA

Bibliography

Christensen, B.T., Sommer, S.G. 1989. Volatilization of ammonia from fertilizers and manure: Methodology and loss of ammonia from urea and urea-ammonium-nitrate. Tidsskrift for Planteavl. 93, 177-190

⁹ The oasis effect arises from the local environment of the field being studied. The emissions from a particular field will be depend on whether it is in an environment with a high level of emissions or a low level of emissions because the difference in concentrations between the air and the soil will not be the same. The larger the area of the source, the smaller the effect.

- Düthmann, D. 2002. Determination of the recovery rate of the wind-tunnels used at INRA for ammonia volatilization measurements. INRA - UMR EGC Centre Versailles-Grignon. 25 p.
- Genermont, S., Cellier, P. 1997. A mechanistic model for estimating ammonia volatilization from slurry applied to bare soil. *Agricultural and Forest Meteorology*. 88 (1-4), 145-167
10.1016/s0168-1923(97)00044-0
- Lockyer, D.R. 1984. A system for the measurement in the field of losses of ammonia through volatilization. *Journal of the Science of Food and Agriculture*. 35 (8), 837-848
10.1002/jsfa.2740350805
- Loubet, B., Cellier, P., Flura, D., Genermont, S. 1999a. An evaluation of the wind-tunnel technique for estimating ammonia volatilization from land: Part 1. Analysis and improvement of accuracy. *Journal of Agricultural Engineering Research*. 72 (1), 71-81
10.1006/jaer.1998.0348
- Loubet, B., Cellier, P., Genermont, S., Flura, D. 1999b. An evaluation of the wind-tunnel technique for estimating ammonia volatilization from land: Part 2. Influence of the tunnel on transfer processes. *Journal of Agricultural Engineering Research*. 72 (1), 83-92
10.1006/jaer.1998.0349
- Misselbrook, T.H., Nicholson, F.A., Chambers, B.J., Johnson, R.A. 2005. Measuring ammonia emissions from land applied manure: an intercomparison of commonly used samplers and techniques. *Environmental Pollution*. 135 (3), 389-397
10.1016/j.envpol.2004.11.012
- Moal, J.F. 1994. Volatilisation de l'azote ammoniacal des lisiers après épandage: quantification et étude des facteurs d'influence. (Volatilization of ammonia nitrogen from manure: quantification and study of influencing factors). Cemagref, Equipement pour l'eau et l'environnement, Université de Perpignan, p. 230 p.
- Moal, J.F., Martinez, J., Guiziou, F., Coste, C.M. 1995. Ammonia volatilization following surface-applied pig and cattle slurry in France. *Journal of Agricultural Science*. 125, 245-252
- Parnaudeau, V., Genermont, S., Henault, C., Farrugia, A., Robert, P., et al. 2009. Measured and Simulated Nitrogen Fluxes after Field Application of Food-Processing and Municipal Organic Wastes. *Journal of Environmental Quality*. 38 (1), 268-280
10.2134/jeq2007.0486
- Reitz, P., Kutzbach, H.D., Martinez, J., Maudet, M.N. 1998. Influence of slurry pretreatments and application techniques on ammonia emissions after landspreading of slurry on grassland. In: Martinez, J., Maudet, M.N. (Eds.). RAMIRAN 98 Actes de la 8ème Conférence du Réseau FAO, Cemagref éditions. Rennes, France, 26-29 May 1998, p. 247-255
- Ryden, J.C., Lockyer, D.R. 1985. Evaluation of a system of wind tunnels for field studies of ammonia loss from grassland through volatilization. *Journal of the Science of Food and Agriculture*. 36 (9), 781-788
10.1002/jsfa.2740360904
- Sommer, S.G., Olesen, J.E., Christensen, B.T. 1991. Effects of temperature, wind-speed and air humidity on ammonia volatilization from surface applied cattle slurry. *Journal of Agricultural Science*. 117, 91-100
- Sommer, S.G., Olesen, J.E. 1991. Effects of dry-matter content and temperature on ammonia loss from surface-applied cattle slurry. *Journal of Environmental Quality*. 20 (3), 679-683

van der Weerden, T.J., Moal, J.F., Martinez, J., Pain, B.F., Guiziou, F. 1996. Evaluation of the wind-tunnel method for measurement of ammonia volatilization from land. *Journal of Agricultural Engineering Research*. 64 (1), 11-13 10.1006/jaer.1996.0041

Application note 25 Determining N losses when spreading manure using an ^{15}N tracer

Scope of application

An ^{15}N tracer¹⁰ may be used to determine the nitrogen losses from organic matter after it has been spread on the ground. It is relatively easy to mark the ammonium fraction of manure by incorporating an ^{15}N enriched mineral nitrogen solution. The total losses of N, either as emissions or by leaching, can be estimated by measuring the remaining quantities of the ^{15}N tracer in the soil and plants.

This approach can also be used to monitor fluxes from the various soil compartments (Mary *et al.*, 1998) and to mark the organic fraction of the manure by giving the animals ^{15}N enriched feed (Chantigny *et al.*, 2004). This application note only considers ^{15}N tracer marking of the ammonium fraction of manure and quantification of the losses by the ^{15}N balance.

Operating principles

The ammonium fraction of the manure is enriched with ^{15}N by adding a mineral nitrogen solution (ammonium sulfate for example) that has been strongly enriched with ^{15}N . The quantity of mineral nitrogen added must be as small as possible to avoid significant changes to the ammonium concentration in the manure.

The ammonium fraction of the manure is involved in various stages of the nitrogen cycle (nitrification, denitrification, immobilization by micro-organisms, adsorption on minerals, ammonia volatilization and absorption by plants). ^{15}N tracers can be used to quantify the fate of the nitrogen in the ammonium fraction in various soil and plant compartments:

- soil mineral nitrogen in the form of ammonium and nitrate
- nitrogen immobilized in the soil, either adsorbed on minerals or in micro-organisms
- nitrogen immobilized in the roots and aerial compartments of plants

The ^{15}N balance for the tracer (in mass per unit area) carried out in these compartments is used to calculate the ratio of the quantity of tracer remaining to the quantity of tracer added initially. The difference corresponds to the losses of N and ^{15}N from the soil-plant system in the form of gases, provided that there were no losses from the system studied due to leaching.

Equipment required

- ^{15}N enriched solution
- Auger for taking soil samples
- Potassium chloride solution (KCl)
- Stove for drying plant samples
- Colorimetric analyzer for ammonium and nitrate concentrations
- Elemental analyzer for carbon and nitrogen
- Isotope-ratio mass spectrometer

¹⁰ ^{15}N is an isotope of nitrogen with 7 protons and 8 neutrons.

Implementation

As ^{15}N marking is expensive, this method can only be used on small experimental plots or of the order of tens of square meters (Morvan, 1999).

Marking

The highest dilution of the tracer is in the soil organic nitrogen compartment. The initial enrichment of the manure is, therefore, calculated to obtain a reasonable precision for the ^{15}N excess in this compartment. An initial enrichment of 2% to 3% is generally adequate to meet this requirement.

Soil sampling

The soil should be sampled using an auger at a sufficiently high density to allow for the spatial variations in the manure and the ^{15}N tracer as it is impossible to spread the manure uniformly on the surface of the soil. No equipment can spread perfectly and, when slurry is spread on the surface, local micro-reliefs will cause uneven concentrations of the liquid. To take account of these variations, the soil sampling should be based on: i) creating composite samples by combining 7 to 10 individual samples and ii) taking several composite samples for each plot. A sampling density of 20 to 30 cores per plot covering about 20 square meters is, therefore, required for an accurate assessment of the ^{15}N balance.

Preparing the samples

Preparing the soil samples is long and complex:

- The mineral nitrogen in the form of ammonium and nitrate is extracted by agitation in a 1 N solution of potassium chloride (KCl). The ammonium and nitrate concentrations are measured by continuous flow colorimetry. For determination of the ^{15}N excess the nitrogen is been extracted from the sample by microdiffusion, as described by Fillery and Recous (2001). The nitrogen is extracted sequentially with a first extraction stage for the ammonium by conversion to ammonia which is trapped on an acid-soaked filter paper. The nitrate is extracted by reduction to ammonium using Devarda's alloy and then converted to ammonia and trapped on filter paper as above.
- The ^{15}N excess of the organic nitrogen in the soil must be measured on a sample of soil from which all trace of mineral nitrogen has been removed by 3 successive extractions using KCl. The soil sample is then dried at 70°C and finely ground for C and N elemental analysis and isotope-ratio mass spectrometry.
- The ^{15}N excess of the aerial and root compartments of the plants is measured using dried and finely ground samples.

^{15}N excess measurements

The ^{15}N excess is measured using an isotope-ratio mass spectrometer coupled to an elemental analyzer. This measures the abundance of ^{15}N in the sample. The ^{15}N excess is the difference between the ^{15}N abundance in the sample and the ^{15}N abundance in a control sample. The ^{15}N excess is measured for all the soil-plant compartments to calculate the ^{15}N balance.

Validation and sources of uncertainty

The relative standard error on the ^{15}N balance measured by Morvan (1999) on 6 trials ranged from 1.8% to 6.2%, with a mean value of 3%, which gives a 95% confidence interval of

12.9% for trials with 3 replicates. This implies that, when the emissions are moderate or when comparing differences in emissions between two treatments, the error in the ^{15}N balance can be of the same order of magnitude as the fluxes being measured. For trials taking account of plant compartments, the quantities of N and ^{15}N absorbed by the roots are difficult to estimate as it is difficult to collect the roots and fine roots are lost when sieving under water to separate the roots from the soil.

Advantages and limitations

Advantages: The main advantage of ^{15}N tracer measurements is that it allows the N fluxes associated with nitrification, immobilization by micro-organisms, adsorption on soil colloids and absorption of N by the plants to be quantified for analyzing the competition between these processes and emissions.

Limitations: This method only allows the aggregate emissions to be quantified and does not provide any information either on the compounds concerned (NH_3 , NO_x , N_2O , N_2) or on their source: volatilization, denitrification, etc. The cost and effort required to use this method, in terms of both sampling and analysis, restrict the number of points that can be measured. Unlike methods based on direct measurement of emissions, it does not provide a fine characterization of the emission dynamics.

References

Authors:

- Thierry Morvan, INRA, UMR SAS – Quimper, France

Bibliography

- Chantigny, M.H., Angers, D.A., Morvan, T., Pomar, C. 2004. Dynamics of pig slurry nitrogen in soil and plant as determined with (^{15}N). *Soil Science Society of America Journal*. 68 (2), 637-643
- Fillery, I.R.P., Recous, S. 2001. Use of enriched (^{15}N) sources to study soil N transformations. In: Unkovich, M., Pate, J., et al. (Eds.), *Stable Isotope Techniques in the Study of Biological Processes and Functioning of Ecosystems*. Current Plant Science and Biotechnology in Agriculture, Vol.40 pp. 167-194.<Go to ISI>://WOS:000173542900009
- Mary, B., Recous, S., Robin, D. 1998. A model for calculating nitrogen fluxes in soil using N-15 tracing. *Soil Biology & Biochemistry*. 30 (14), 1963-1979 10.1016/s0038-0717(98)00068-6
- Morvan, T. 1999. Quantification et modélisation des flux d'azote résultant de l'épandage de lisier (Quantifying and modeling nitrogen fluxes from slurry spreading). INRA Rennes - UMR Sol Agro et hydrosystème Spatialisation. PhD thesis, Paris VI, p. 146 p.

Application note 26 Measuring distributed sources of emissions using integrated horizontal flux

Scope of application

The Integrated Horizontal Flux (IHF) is a particular application of the mass balance approach. It is suitable for measuring the emissions from circular sources with a diameter from about 20 m to about 40 m. IHF has been used mainly for measuring ammonia volatilization from fields after spreading manure or slurry (Yague and Bosch-Serra, 2013) or from manure or slurry storage (Sommer *et al.*, 2004), as well as from fields after amendment with urea (Pacholski *et al.*, 2008). It has also been used for measuring enteric methane emissions by cattle (McGinn, 2013), as well as methane and N₂O emissions from slurry pits (Sommer *et al.*, 2004) and landfill sites (McBain *et al.*, 2005). However, it can also be used to study the emissions of pesticides (Yates *et al.*, 2008). It has been widely used for comparing different nitrogen amendment practices to limit ammonia losses (Yague and Bosch-Serra, 2013).

Operating principles

The method is based on mass balance by measuring the flux of compounds entering and leaving a volume of air above the surface being studied (Figure M26.1). The difference between the input flux (F_i) and the output flux (F_o) from the test volume is equal to the flux emitted from the surface (S). The lost flux leaving the top of the test volume F_l is ignored.

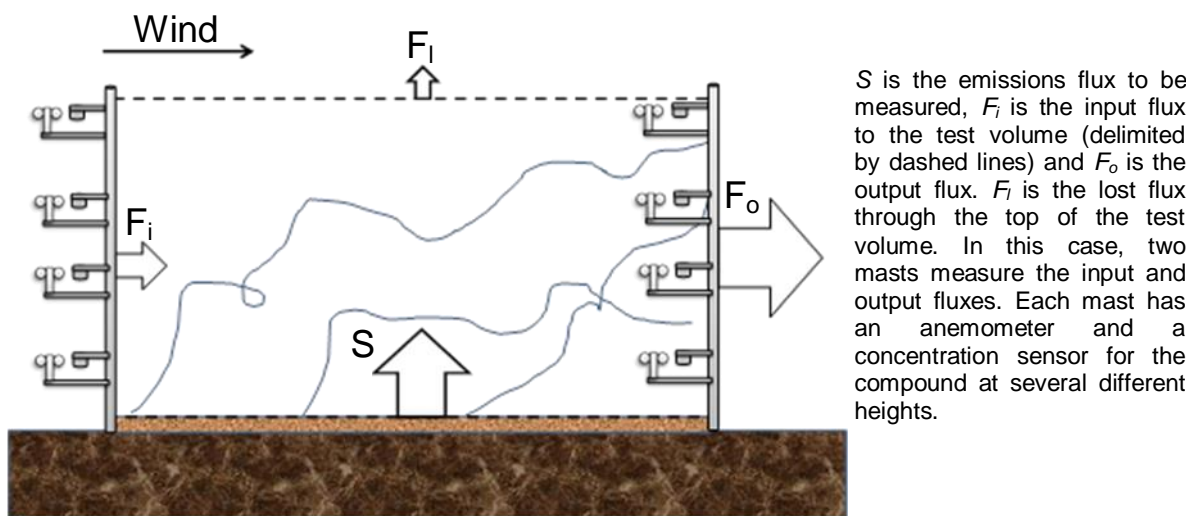

Figure M26.1. Integrated Horizontal Flux method

The horizontal flux $F_c^H(z)$ of a compound at a concentration $C(z)$ at a given height z is equal to the concentration multiplied by the wind velocity at this height $U(z)$, which, taking the means, gives:

$$F_c^H(z) = \overline{C(z) \cdot U(z)} = \bar{C}(z) \cdot \bar{U}(z) + \overline{u'c'}(z) \quad (\text{eq. M26.1})$$

where the mean of the product is decomposed into the product of the means $\bar{C}(z)$ and $\bar{U}(z)$ plus a term $\overline{u'c'}(z)$ which represents the horizontal turbulent flux. The bars represent means over the period and the apostrophes represent the instantaneous difference from the mean.

Assuming that the term representing the turbulence is negligible, the horizontal flux can be measured with an averaging concentration sensor and an anemometer. The IHF is estimated by measuring the horizontal flux at several heights.

$$F_c^{0 \rightarrow \infty} = \overline{\int_0^{\infty} \bar{C}(z) \cdot \bar{U}(z) dz} \sim \overline{\int_0^{z_{max}} \bar{C}(z) \cdot \bar{U}(z) dz} \text{ (eq. M26.2)}$$

As taking measurements at great heights is neither easy nor useful, a maximum height z_{max} is set, above which the horizontal flux is considered to be negligible (height of the boundary layer within the circle which is approximately one hundredth of the radius). There are several ways of estimating the integral, either directly by summing the values or by fitting curves to the flux or concentration profiles (splines, logarithm, exponential, etc).

Several variants of the IHF method have been developed. In general, circular plots are used for practical purposes as they measure the IHF at the center, regardless of the wind direction. The input flux can be estimated from the background concentration for fields at some distance from the field that has been treated and a uniform vertical concentration profile is assumed for equation M26.2. Wilson and Shum (1992) showed that a circular plot with radius R is equivalent to an infinite strip with width R for R greater than 20 m and sufficiently windy conditions. Passive sensors measuring the horizontal flux directly have also been developed for ammonia (Sommer *et al.*, 1996).

Equipment required

The IHF method as adapted by Wilson and Shum requires a circular plot about 20 m diameter and at least 4 concentration sensors and 3 anemometers: 1 background concentration sensor at a distance of over 100m (upwind of the plot if possible) and three sensors with anemometers in the center of the plot at three different heights with geometric intervals. It may be useful to have three background concentration sensors in case the wind direction changes. The concentration can be measured using impingers (Application note 3), denuders (Application note 2) or passive diffusion samplers (Application note 1). It is also possible to use real-time, spatially integrating methods such as differential optical absorption spectroscopy (Application note 11), or a system similar to that used for aerodynamic gradient measurements (Application note 28). A data logger is required for data acquisition.

Implementation

When implementing the method, the main work involved is preparing the concentration sensors if denuders or passive diffusion samplers are used. The source area must be well delimited and the background measurement masts must be positioned correctly. Wilson and Shum (1992) give more information on implementation.

Validation and sources of uncertainty

Wilson and Shum (1992) tested this method using a lagrangian stochastic model and considered that it was accurate to about 20%. IHF has been shown to overestimate ammonia emissions in comparison with the new standard method of inverse modeling (Application note 30), whether for volatilization from manure storage (Sommer *et al.*, 2004) or after spreading manure or slurry on a field (Sintermann *et al.*, 2012). This overestimate comes

from ignoring horizontal turbulent airflow (omitted in equation M26.2) and the oasis¹¹ effect which increases emissions (Sintermann *et al.*, 2012).

Advantages and limitations

Advantages:

- Relatively simple implementation depending on the sensors used
- The fluxes are representative of real conditions (unlike wind tunnels)
- Can be used for small plots (10 m to 20 m diameter) to compare several different treatments. This is why it was popular in the 1990s.

Limitations: There are currently doubts about the IHF method because it is suspected of overestimating emissions by ignoring the horizontal turbulent airflow, and because of the oasis effect that it creates (Sintermann *et al.*, 2012). Furthermore, there are often too few measurement points on the mast for an accurate estimate of the vertical integral. IHF is being replaced by inverse modeling which is now well established and requires fewer measurement points (Application note 30).

Costs: The costs of this method depend on the concentration sensor that is used (impingers, passive diffusion samplers, fairly expensive analyzers). The fixed costs are a micrometeorological measurement station with three 2D anemometers, plus a data logger (price €1,000 to €3,000, low maintenance). At least 4 concentration measurement points are required and, if traps (impingers or passive diffusion samplers) are used, at least 6 measurement periods are required. If a gas analyzer is used, a 4-way multiplexer is required (price €1,000 to €2,000).

References

Authors:

- Benjamin Loubet, INRA, UMR EGC – Thiverval-Grignon, France

Bibliography

- McBain, M.C., Warland, J.S., McBride, R.A., Wagner-Riddle, C. 2005. Micrometeorological measurements of N₂O and CH₄ emissions from a municipal solid waste landfill. *Waste Management & Research*. 23 (5), 409-419 10.1177/0734242x050507253
- McGinn, S.M. 2013. Developments in micrometeorological methods for methane measurements. *Animal*. 7, 386-393 10.1017/s1751731113000657
- Pacholski, A., Cai, G.-X., Fan, X.-H., Ding, H., Chen, D., et al. 2008. Comparison of different methods for the measurement of ammonia volatilization after urea application in Henan Province, China. *Journal of Plant Nutrition and Soil Science*. 171 (3), 361-369 10.1002/jpln.200625195
- Sintermann, J., Neftel, A., Ammann, C., Haeni, C., Hensen, A., et al. 2012. Are ammonia emissions from field-applied slurry substantially over-estimated in European emission inventories? *Biogeosciences*. 9 (5), 1611-1632 10.5194/bg-9-1611-2012

¹¹ The oasis effect arises from the local environment of the field being studied. The emissions from a particular field will depend on whether it is in an environment with a high level of emissions or a low level of emissions because the difference in concentrations between the air and the soil will not be the same. The larger the area of the source, the smaller the effect

- Sommer, S.G., McGinn, S.M., Hao, X., Larney, F.J. 2004. Techniques for measuring gas emissions from a composting stockpile of cattle manure. *Atmospheric Environment*. 38 (28), 4643-4652 10.1016/j.atmosenv.2004.05.014
- Sommer, S.G., Sibbesen, E., Nielsen, T., Schjorring, J.K., Olesen, J.E. 1996. A passive flux sampler for measuring ammonia volatilization from manure storage facilities. *Journal of Environmental Quality*. 25 (2), 241-247
- Wilson, J.D., Shum, W.K.N. 1992. A reexamination of the integrated horizontal flux method for estimating volatilization from circular plots. *Agricultural and Forest Meteorology*. 57 (4), 281-295 10.1016/0168-1923(92)90124-m
- Yague, M.R., Bosch-Serra, A.D. 2013. Slurry field management and ammonia emissions under Mediterranean conditions. *Soil Use and Management*. 29 (3), 397-400 10.1111/sum.12061
- Yates, S.R., Knuteson, J., Ernst, F.F., Zheng, W., Wang, Q. 2008. Effect of Sequential Surface Irrigations on Field-Scale Emissions of 1,3-Dichloropropene. *Environmental Science & Technology*. 42 (23), 8753-8758 10.1021/es800675t

Application note 27 Measuring emissions from diffuse sources using the perimeter profile method

Scope of application

The perimeter profile method is similar to IHF (Application note 26) and is based on mass balance (Application note 21). It is applied to plots by taking measurements round the outside of the plot. It makes few assumptions about the uniformity of the airflow and can, therefore, be applied in a wide range of conditions. It can be applied for fields with a simple geometrical shape (rectangle) or to buildings.

Operating principles

The perimeter profile method is based on determining the mass balance, i.e. measuring the quantity of the compound that enters and the quantity that leaves in the airflow above the source studied: the difference between the input flux (F_i) and the output flux (F_o) from the test volume is equal to the flux emitted from the surface (S). This method usually uses four masts on the edge of a diffuse source (Denmead *et al.*, 1998). Measurements may be taken continuously (inline analyzer) or at long intervals using sensors that integrate the concentrations over time, such as impingers and Ferm tubes. The horizontal flux is estimated in the same way as for the IHF method as the wind velocity multiplied by the concentration, at the height of the boundary layer that develops over the surface (typically 10% of the length of the plot).

Schojoerring *et al.*, (1992) proposed a simpler method using passive sensors that gave direct measurements of the product of the wind speed and the concentration. Flow samplers based on Ferm diffusion tubes (Ferm, 1991) are mounted in pairs on masts around a circular experimental plot. The differences in horizontal fluxes between each pair of tubes, one of which is oriented towards the inside and the other towards the outside, are determined separately for each measurement height on each mast. The vertical flux is then determined by summing these differences in horizontal fluxes step by step.

Equipment required

Perimeter profile measurements require 4 masts supporting sampling points or sampling lines which measure the concentrations of the gas of interest at the same time as the horizontal wind speed. For point measurements, it is possible to use real-time, spatially integrating methods such as differential optical absorption spectroscopy (Application note 11), or a system similar to that used for aerodynamic gradient measurements (Application

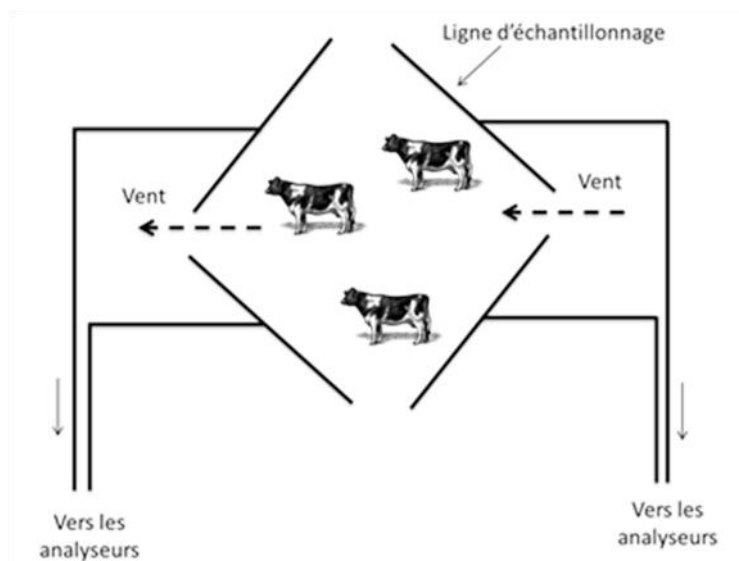

Figure M27.1. The perimeter profile method (Hu *et al.*, 2014)

note 28). A data logger is required for data acquisition. For measurements integrated over time, concentrations can be measured using impingers (Application note 3), denuders (Application note 2) or passive diffusion samplers (Application note 1, Tang *et al.*, 2001).

Implementation

Measurements using automatic analyzers require considerable skill. For measurements integrated over time, the main work involved is preparing the concentration sensors if denuders or passive diffusion samplers are used. The source area must be well delimited and the measurement masts must be positioned correctly.

Advantages and limitations

Advantages:

- Relatively simple implementation for taking emission measurements integrated over time (Schojoerring *et al.*, 1992)
- The method does not require a uniform environment around or within the test area
- The fluxes are representative of real conditions
- Can be used for small plots to compare several different treatments

Limitations:

- This method can only be used to measure emissions from plots in an environment with low concentrations
- It is not suitable for small fluxes as, in this case, the method will be measuring horizontal differences in small concentrations.

Costs: The costs of this method depend on the concentration sensor that is used (impingers, passive diffusion samplers, fairly expensive analyzers). At least 8 concentration measurement points are required (4 masts and 2 measurement heights or more) and, if traps (impingers or passive diffusion samplers) are used, at least 8 measurement periods are required. If a gas analyzer is used, a multiplexer is required (€1,000 to €2,000) to sample the various measurement points sequentially.

References

Authors:

- Thomas Eglin, Ademe – Angers, France
- Pierre Cellier, INRA, UMR EGC – Thiverval-Grignon, France,

Bibliography

- Denmead, O.T., Harper, L.A., Freney, J.R., Griffith, D.W.T., Leuning, R., et al. 1998. A mass balance method for non-intrusive measurements of surface-air trace gas exchange. *Atmospheric Environment*. 32 (21), 3679-3688 10.1016/s1352-2310(98)00091-0
- Ferm, M. 1991. A sensitive diffusional sampler. Report B-1020.
- Hu, E., Babcock, E.L., Bialkowski, S.E., Jones, S.B., Tuller, M. 2014. Methods and Techniques for Measuring Gas Emissions from Agricultural and Animal Feeding Operations. *Critical Reviews in Analytical Chemistry*. 44 (3), 200-219 10.1080/10408347.2013.843055
- Schojoerring, J.K., Sommer, S.G., Ferm, M. 1992. A simple passive sampler for measuring ammonia emission in the field. *Water, Air, and Soil Pollution*. 62 (1-2), 13-24

Tang, Y.S., Cape, J.N., Sutton, M.A. 2001. Development and types of passive samplers for monitoring atmospheric NO₂ and NH₃ concentrations. *ScientificWorldJournal*. 1, 513-29 10.1100/tsw.2001.82

Application note 28 Measuring emissions from diffuse sources using the aerodynamic gradient

Scope of application

The aerodynamic gradient method was very popular in the second half of the 20th century for estimating the momentum, sensible heat and water vapor fluxes between the surface of the Earth and the atmosphere. It is based on a simple principle which made it a standard method for many years for measuring many other surface fluxes: CO₂, SO₂, O₃, NH₃, mercury, volatile organic compounds, nitric acid (HNO₃), pesticides, etc.

It is still used for compounds which are difficult to measure by eddy covariance (Application note 31), such as reactive compounds that need to be converted before analysis or for which real-time analyzers are not sufficiently sensitive (NH₃, metals, pesticides, HONO, bacteria) (Honrath *et al.*, 2002; Kruit *et al.*, 2007; Milford *et al.*, 2009; Loubet *et al.* 2011). The aerodynamic gradient method is also used for measuring chemical systems such as the NO-NO₂-O₃ system. The gradient method is able to estimate both the flux and the conversion rate of one chemical species to another (De Arellano and Duynkerke, 1992; Duyzer *et al.*, 1995; Stella *et al.*, 2012).

Operating principles

The aerodynamic gradient method measures the vertical flux above a uniform surface. It is based on Fick's first law of diffusion whereby the flux F (g.s⁻¹) of a quantity depends on the gradient of its concentration C (g.m⁻³) and its diffusion coefficient D (m².s⁻¹). For example, in the vertical direction (z) the diffusion flux is $F = -D \partial C / \partial z$.

This law applies to any molecular diffusion phenomenon and has been extended to the case of turbulent diffusion in a surface boundary layer. By analogy with the molecular diffusion which depends on the thermal agitation of molecules in a gas or a liquid, a turbulent flux ($\overline{w'c'}$, where w is the vertical component of the wind (m.s⁻¹), c is the concentration and the bar represents the mean over the period and the apostrophes represent a difference from the mean) can be represented by a relationship between the flux and the concentration gradient when turbulence is small for the characteristic distance of the gradient. This can be expressed as:

$$\overline{w'c'} = -D_t \frac{\partial c}{\partial z} \quad (\text{eq. M28.1})$$

The turbulent diffusivity D_t (m².s⁻¹) is well defined for the atmospheric boundary layer by Monin and Obukhov's similarity theory (Foken, 2006; Kaimal and Finnigan, 1994). It depends on the friction velocity u^* (m.s⁻¹), characterizing the intensity of the turbulence in the boundary layer and the thermal stratification of the boundary layer, expressed in terms of the Richardson number (Ri without dimension) or the Obukhov length (L in m). Replacing D_t by a function of u^* in equation M28.1 and replacing z by $\ln(z-d) - \psi_H \left(\frac{z-d}{L} \right)$ (where Ψ_H is the effect of thermal stratification on the temperature gradient, and d is the zero plane displacement¹² in m), gives the commonly used flux-gradient equation (Sutton *et al.*, 1993).

¹² The term zero plane displacement is used when the ground is covered by dense vegetation of height H . The ground height is then considered to be raised by $\sim 0.7 H$, the zero plane displacement.

$$F = -k \times u^* \frac{\partial c}{\partial (\ln(z-d) - \psi_H(\frac{z-d}{L}))} \quad (\text{eq. M28.2})$$

$$\psi_H(\zeta) = \begin{cases} -5.2 \zeta & \zeta > 0 \\ 2 \ln \left(1 + \frac{1}{2} (1 - 16 \zeta)^{1/2} \right) & \zeta \leq 0 \end{cases} \quad (\text{eq. M28.3})$$

where

F is the flux,

k is the von Karman constant ($k = 0.41$)

ζ is the stability parameter ($\zeta = (z - d) / L$)

d is the zero plane displacement and

Ψ_H is the empirical stability correction function.

Equipment required

Measurement using the aerodynamic gradient method requires at least one thermometer and a 3D sonic anemometer to measure the friction velocity u^* and estimate the Obukhov length L , as well as equipment for measuring the gas concentration for at least three heights. It is preferable to use just one analyzer to take samples at the various heights to avoid any bias that might be introduced by differences in calibration between analyzers. The simplest solution is to use a multiplexer to take samples from the various channels in succession. It is often preferable to use a continuous sampling pump to minimize the response time when changing channel (Figure M28.1).

The zero plane displacement d (eq. M28.2 and M28.3) must also be estimated. It can be estimated from the height of the ground cover and the leaf area index (LAI) (Graefe, 2004), or from the wind speed gradient measured at 4 or 5 heights as described by Loubet *et al.* (2013).

Implementation

As well as the equipment, the method requires a suitable site to minimize the limitations of the method: a flat uniform surface that is as large as possible, no nearby major emission sources and no nearby obstacles. The sampling heights should have geometrical spacing from the lowest just above the turbulent layer (twice the ground cover height + 10 cm) to the highest which should be within the boundary layer for the plot (one hundredth of the fetch, the size of the plot). The analyzers should be calibrated regularly. All the channels should be checked at the same height regularly to ensure that there is no drift or bias in the analysis.

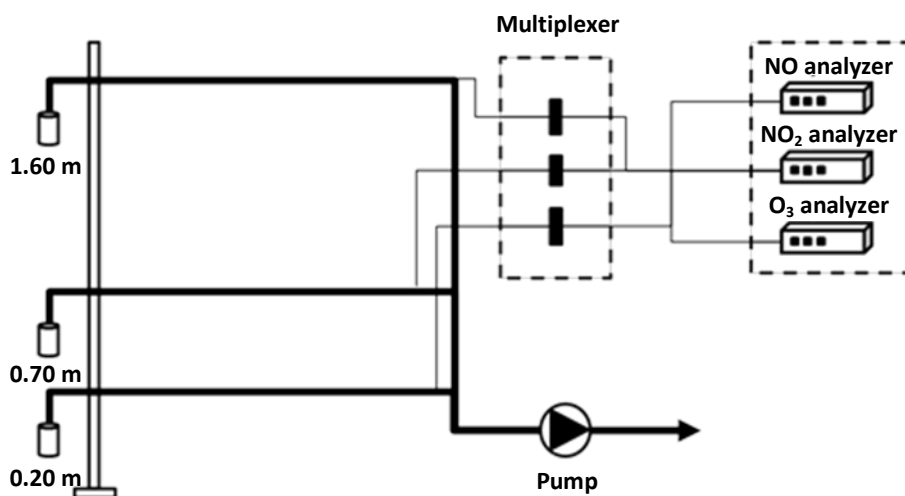

Figure M28.1. Left: Measuring the gradients of NO, NO₂ and O₃ at three heights using a continuous sampling pump, a multiplexer and gas analyzers (Stella *et al.*, 2012).

Right: Photograph of an NH₃ gradient measurement system using a multi-channel continuous flow system using wet effluent diffusion denuders (ROSAA) (Loubet *et al.*, 2012)

Validation and sources of uncertainty

The aerodynamic gradient method has been validated for heat, water and CO₂ fluxes by comparison with standard methods such as eddy covariance (Application note 31). For ammonia, inter-comparison tests gave a relative standard error of 20% for high fluxes and 33% for lower fluxes (Milford *et al.*, 2009). The method has also been compared against relaxed eddy accumulation (Application note 32) giving differences from 3% to 40% and the inverse modeling method (Application note 30) giving differences less than 2% (Loubet *et al.*, 2009; Loubet *et al.*, 2010).

Advantages and limitations

Advantages: The aerodynamic gradient method can be used to measure emission fluxes using slow analyzers, that is with a measurement period of a few seconds or measurements integrated over 5 minutes to 2 hours (Honrath *et al.*, 2002). The method is easy to understand and implement (although the air sampling system requires some care). A major advantage of the method is that it provides a direct indication of the direction of the flow (the opposite direction of the gradient). By measuring the gradient of several compounds at the same time, it is possible to apply the Bowen ratio technique (Walker *et al.*, 2006) or modified Bowen technique (Mayer *et al.*, 2011) both of which make the assumption that the flux-gradient relationship is analogous for all compounds. The temperature profile, or better still, the humidity profile should be measured at the same heights.

Limitations: The aerodynamic gradient method has several limitations:

- The relaxed eddy accumulation method (Application note 32) sets out to replace the aerodynamic gradient method by providing a self-check by comparing the sampling channels.
- Another limitation of the aerodynamic gradient method is that the lowest measurement point must be above the roughness sub-layer, about twice the height of

the canopy, to ensure that the turbulence is acceptably low. However, the highest measurement point must be within the boundary layer, which implies an upper limit of about one hundredth of the fetch¹³. This means that the bottom and top measurement points may be very close together requiring the analyzers to have a very high resolution. To overcome this, a modified aerodynamic gradient method has been developed for taking measurements within the roughness sub-layer (Rotach, 1993). Another way of overcoming this problem is to use the Bowen ratio technique which is based on the similarity between the diffusion of a compound and the diffusion of water vapor or sensible heat (Mayer *et al.*, 2011).

- As for eddy covariance, disjunct eddy covariance, virtual disjunct eddy covariance and relaxed eddy accumulation, the aerodynamic gradient method determines the flux at a height above the surface. It is assumed that the flux does not depend on the height. This implies that the wind is constant and that the surface is horizontally uniform without sources or sinks for the compound (Loubet *et al.*, 2013).

Costs: The cost of this method depends on the type of concentration sensor that is used. The fixed costs are the micrometeorological measurement station which has a 3D sonic anemometer (price €2,000 to €3,000, no maintenance) and data logger (price €1,000 to €3,000, low maintenance). A 4-way multiplexer is required (price €1,000 to €2,000).

References

Authors of the application note:

- Benjamin Loubet and Erwan Personne, INRA, UMR EGC – Thiverval-Grignon, France

Other organizations: Chris Flechard, INRA, UMR SAS – Rennes, France; Patrick Stella

Bibliography

- De Arellano, J.V., Duynkerke, P.G. 1992. Influence of chemistry on the flux-gradient relationships for the NO-O₃-NO₂ system. *Boundary-Layer Meteorology*. 61 (4), 375-387
- Duyzer, J.H., Deinum, G., Baak, J. 1995. The interpretation of measurements of surface exchange of nitrogen-oxides - correction for chemical-reactions. *Philosophical Transactions of the Royal Society a-Mathematical Physical and Engineering Sciences*. 351 (1696), 231-248 10.1098/rsta.1995.0031
- Foken, T. 2006. 50 years of the Monin-Obukhov similarity theory. *Boundary-Layer Meteorology*. 119 (3), 431-447
- Graefe, J. 2004. Roughness layer corrections with emphasis on SVAT model applications. *Agricultural and Forest Meteorology*. 124 (3-4), 237-251 10.1016/j.agrformet.2004.01.003
- Honrath, R.E., Lu, Y., Peterson, M.C., Dibb, J.E., Arsenault, M.A., et al. 2002. Vertical fluxes of NO_x, HONO, and HNO₃ above the snowpack at Summit, Greenland. *Atmospheric Environment*. 36 (15-16), 2629-2640 10.1016/s1352-2310(02)00132-2
- Kaimal, J.C., Finnigan, J.J. 1994. *Atmospheric Boundary Layer Flows, Their structure and measurement*. Oxford University Press., New York 289

¹³ The fetch is the distance between the measurement mast and the upwind edge of the field.

- Kruit, R.J.W., van Pul, W.A.J., Otjes, R.P., Hofschreuder, P., Jacobs, A.F.G., et al. 2007. Ammonia fluxes and derived canopy compensation points over non-fertilized agricultural grassland in The Netherlands using the new gradient ammonia - high accuracy - monitor (GRAHAM). *Atmospheric Environment*. 41 (6), 1275-1287 10.1016/j.atmosenv.2006.09.039
- Loubet, B., Milford, C., Hensen, A., Daemmgen, U., Erisman, J.W., et al. 2009. Advection of NH₃ over a pasture field and its effect on gradient flux measurements. *Biogeosciences*. 6 (7), 1295-1309 10.5194/bg-6-1295-2009
- Loubet, B., Genermont, S., Ferrara, R., Bedos, G., Decuq, G., et al. 2010. An inverse model to estimate ammonia emissions from fields. *European Journal of Soil Science*. 61 (5), 793-805 10.1111/j.1365-2389.2010.01268.x
- Loubet, B., Stella, P., Fanucci, O., N., M. 2011. Evaluation of a modified disjunct eddy covariance method for estimating the fluxes divergence of nitrogen oxides and ozone. *Nitrogen & Global Change: Key findings – future challenges*. Edinburgh (GBR) 11-15/04/2011, p. 2 p.
- Loubet, B., Decuq, C., Personne, E., Massad, R.S., Flechard, C., et al. 2012. Investigating the stomatal, cuticular and soil ammonia fluxes over a growing tritical crop under high acidic loads. *Biogeosciences*. 9 (4), 1537-1552 10.5194/bg-9-1537-2012
- Loubet, B., Générmont, S., Cohan, J.P., Charpiot, A., Morvan, T., et al. 2013. A new method for estimating ammonia volatilization from slurry in small fields using diffusion samplers. *Measuring methods. Emissions of gas and dust from livestock. International symposium on emission of gas and dust from livestock (EMILI 2012)*. Edition IFIP-Institut du Porc pp. 325-328
- Mayer, J.C., Bargsten, A., Rummel, U., Meixner, F.X., Foken, T. 2011. Distributed Modified Bowen Ratio method for surface layer fluxes of reactive and non-reactive trace gases. *Agricultural and Forest Meteorology*. 151 (6), 655-668 10.1016/j.agrformet.2010.10.001
- Milford, C., Theobald, M.R., Nemitz, E., Hargreaves, K.J., Horvath, L., et al. 2009. Ammonia fluxes in relation to cutting and fertilization of an intensively managed grassland derived from an inter-comparison of gradient measurements. *Biogeosciences*. 6 (5), 819-834 10.5194/bg-6-819-2009
- Rotach, M.W. 1993. Turbulence close to a rough urban surface .2. Variances and gradients. *Boundary-Layer Meteorology*. 66 (1-2), 75-92 10.1007/bf00705460
- Stella, P., Loubet, B., Laville, P., Lamaud, E., Cazaunau, M., et al. 2012. Comparison of methods for the determination of NO-O₃-NO₂ fluxes and chemical interactions over a bare soil. *Atmos. Meas. Tech*. 5 (6), 1241-1257 10.5194/amt-5-1241-2012
- Sutton, M.A., Fowler, D., Moncrieff, J.B. 1993. The exchange of atmospheric ammonia with vegetated surfaces.I: unfertilized vegetation. *Quarterly Journal of the Royal Meteorological Society*. 119, 1023-1045
- Walker, J.T., Robarge, W.P., Wu, Y., Meyers, T.P. 2006. Measurement of bi-directional ammonia fluxes over soybean using the modified Bowen-ratio technique. *Agricultural and Forest Meteorology*. 138 (1-4), 54-68 10.1016/j.agrformet.2006.03.011

Application note 29 Measuring emissions from diffuse sources using COTAG

Scope of application

The COTAG (COnditional Time Average Gradient) method is used for measuring emission and deposition fluxes, for individual plots. It can be used for reactive gases such as ammonia (NH₃) and sulfur dioxide (SO₂), for which the method has been tested, and possibly for nitric acid (HNO₃) and hydrochloric acid (HCl). It cannot be used for more stable gases such as N₂O, CH₄ and CO₂. The method is robust and reliable with low maintenance, making it a simple method suitable for long-term monitoring over one or more years and for estimating average emissions over long periods. Although this method has been used for a number of ecosystems in some north European countries (Famulari *et al.*, 2010), it is still at the development stage and requires more work for validation.

Operating principles

This method is derived from the aerodynamic gradient method (Monteith and Unsworth, 1990) (Application note 28). The flux F of the emission from a surface to the atmosphere or the deposition from the atmosphere onto a surface of a trace is proportional to the vertical gradient of the concentration C in the surface layer above the vegetation or the ground ($\frac{dC}{dz}$), and the turbulent exchange coefficient K_x :

$$F = -K_x \frac{dC}{dz} \text{ (eq. M29.1)}$$

where

z is the height above the ground.

For the standard aerodynamic gradient method, $\frac{dC}{dz}$ and K_x are determined over periods of 0.5 to 1 hour, which assumes that there is continuous air sampling and analyses. The COTAG method, however, applies equation M29.1 over a timescale of a week or a month to estimate the mean net flux over the period. This requires average values of K_x and $\frac{dC}{dz}$ to be determined for two atmospheric stability classes based on the stability parameter ($\zeta = (z-d)/L$, where d is the zero plane displacement and L is the Obukov length): (i) slightly unstable: ζ between -0.05 and -0.5, and (ii) close to neutral: ζ between -0.05 and +0.05¹⁴. Outside these two stability ranges, the vertical concentration gradients are either very strong in periods of high stability ($\zeta > +0.05$) because there is very little vertical mixing, or very weak in periods of high instability ($\zeta < -0.5$) because of the intense turbulent mixing. Very stable or very unstable periods are not sampled to avoid biasing the monthly mean gradient. The air sampling is carried out using a system of pumps and multiplexers, separating the samples according to the stability class (i or ii) into two separate sets of denuders. The denuders are lined with a chemical solution to trap the gas being measured (eg: citric acid for NH₃). The denuders (Application note 2) are exposed in the COTAG unit in the field and then removed at the end of the measurement period for laboratory analysis. When the atmosphere is too unstable or too stable, the air samples pass through a third channel ("OFF") which is not used for

¹⁴ The atmosphere is considered to be stable when the vertical temperature gradient is less than the adiabatic lapse rate, neutral if the two gradients are similar or otherwise it is considered to be unstable.

calculating fluxes but is used for gap-filling using models based on the measured concentrations, the weather conditions and various assumptions concerning the sources, sinks and transfer rates in the plants and the soil) (Flechard *et al.*, 2011).

Equipment required

Figure M29.1 below shows the operating principles and equipment for a simplified low cost COTAG system operating from solar cells and a wind turbine with battery back-up. The atmospheric stability classes are determined from the wind and temperature profiles, recorded by a data logger. The airflows are recorded by gas meters and the concentration profiles are measured by denuders at three different heights.

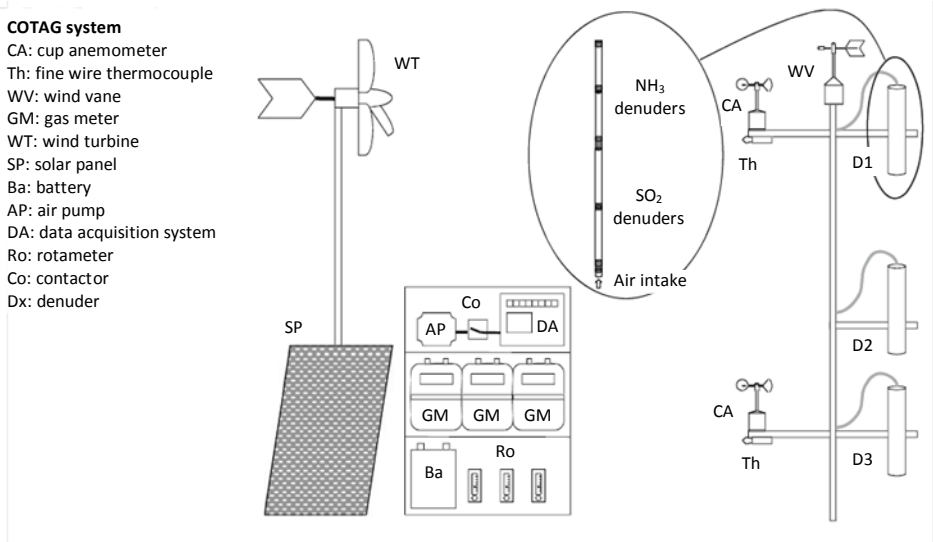

Figure M29.1. COTAG system (Famulari *et al.*, 2010)

Reproduced and modified with kind permission from Daniela Famulari (CEH, Edinburgh)

Figure M29.2 shows another COTAG system, developed as part of the NitroEurope program (2006-2011). In this system, the atmospheric turbulence is determined using a sonic anemometer, the concentrations are measured at two heights using sets of denuders and the airflow is measured using rotameters. This system has a relatively high power consumption and is only suitable for deployment on sites with mains electricity.

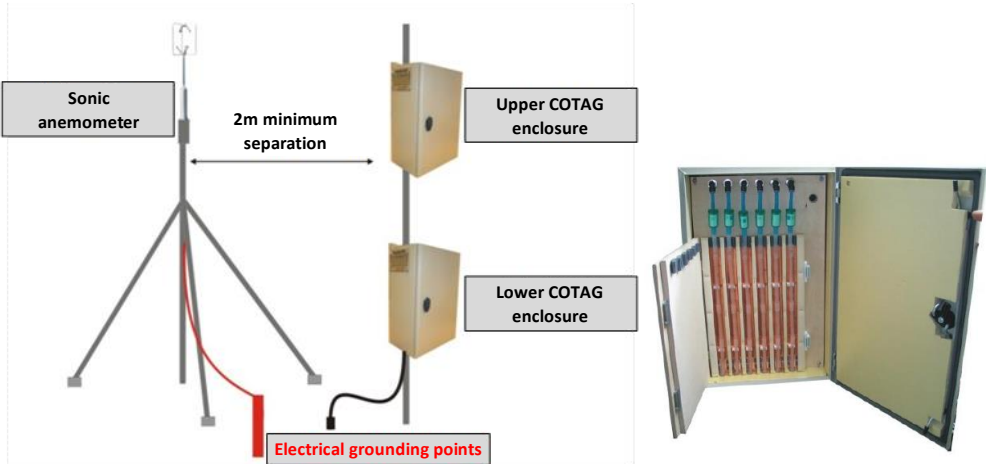

Figure M29.2. - COTAG system developed as part of the NitroEurope program (2008-2010)

Reproduced and modified from (Chojnicki *et al.*, 2009) with kind permission from Bogdan Chojnicki and his colleagues at Poznan University, Poland.

Implementation

The implementation in the field is the same as for the standard aerodynamic gradient method: a relatively flat field with a ground cover of uniform roughness and a fetch of about 100 m for every meter of mast height (rule of thumb for neutral atmospheric stability). This fetch should ensure that the flux is representative of the field being measured and not the neighboring fields. There should be no nearby major emission sources upwind.

Validation and sources of uncertainty

The reproducibility of COTAG measurements has not yet been tested as there are very few prototypes in existence. Comparisons with standard methods are also required for assessing the quality of the measurements. The sources of uncertainty include the effect of the empirical corrections to the vertical gradients as a function of the atmospheric stability (Application note 28), and their extrapolation from an hourly timescale to a weekly or monthly timescale. This could be tested using hourly data for the gradients, fluxes and turbulence measured using more intensive methods (Loubet *et al.*, 2012; Flechard and Fowler, 1998), and aggregating these data to calculate the mean gradients and fluxes over the longer periods to simulate COTAG datasets. The uncertainties in the corrections for atmospheric stability indicate that COTAG is, in principle, more accurate where the atmospheric stability is nearly neutral and, therefore, better suited to maritime climates than continental climates.

Advantages and limitations

Advantages: COTAG is, in principle, easy to implement and requires little maintenance. Its main advantage is that it allows the integration of flux measurements over a long period (more than a season or more than a year) with low frequency concentration measurements (typically once a week to once a month) and, therefore, low analytical and maintenance costs. The lightweight simplified COTAG (Figure M28.1) is interesting as it can be used in remote sites with solar panels and batteries and does not require access to mains electricity.

Limitations: COTAG flux measurements are, however, not very precise and only have a low temporal resolution (one measurement per week or per month) and so cannot be used for detailed studies of processes, unlike standard more intensive methods with temporal resolutions down to an hour, such as eddy covariance (Application note 32) or the aerodynamic gradient method (Application note 28) with inline concentration analysis.

Costs: Compared to higher sampling frequency methods, COTAG is a relatively economical in terms of running costs, requiring only the preparation, exposure, extraction and laboratory analysis of about 15 denuders (2 heights x 2 atmospheric stability classes x 3 replicates, + 1 “OFF” denuder + 2 controls) for each measurement period. The total cost for a COTAG system (including data logger and sonic anemometer) is around €15,000 to €20,000.

References

Authors:

- Chris Flechard, INRA, UMR SAS – Rennes, France

Other organizations:

- Center for Ecology and Hydrology (CEH), Edinburgh, United Kingdom; Daniela Famulari, danf@ceh.ac.uk;

- Poznan University of Life Sciences (PULS), Agrometeorology Department, Poznan, Poland; Bogdan Chojnicki, Radosław Juszcak, Marek Urbaniak and Janusz Olejnik. Contact: chojnick@up.poznan.pl.

Bibliography

- Chojnicki, B., Juszcak, R., M., U., Olejnik, J. 2009. Conditional Time Averaged Gradient (COTAG) System User Manual., Agrometeorology Department, Poznan University of Life Sciences, Poland,
- Famulari, D., Fowler, D., Nemitz, E., Hargreaves, K.J., Storeton-West, R.L., et al. 2010. Development of a low-cost system for measuring conditional time-averaged gradients of SO₂ and NH₃. *Environmental Monitoring and Assessment*. 161 (1-4), 11-27 10.1007/s10661-008-0723-6
- Flechard, C.R., Fowler, D. 1998. Atmospheric ammonia at a moorland site. II: Long-term surface-atmosphere micrometeorological flux measurements. *Quarterly Journal of the Royal Meteorological Society*. 124 (547), 759-791 10.1002/qj.49712454706
- Flechard, C.R., Nemitz, E., Smith, R.I., Fowler, D., Vermeulen, A.T., et al. 2011. Dry deposition of reactive nitrogen to European ecosystems: a comparison of inferential models across the NitroEurope network. *Atmospheric Chemistry and Physics*. 11 (6), 2703-2728 10.5194/acp-11-2703-2011
- Loubet, B., Decuq, C., Personne, E., Massad, R.S., Flechard, C., et al. 2012. Investigating the stomatal, cuticular and soil ammonia fluxes over a growing tritical crop under high acidic loads. *Biogeosciences*. 9 (4), 1537-1552 10.5194/bg-9-1537-2012
- Monteith, J.L., Unsworth, H. 1990. *Principles of Environmental Physics*. 2nd Edition. Edward Arnold 291 p. <http://books.google.fr/books?id=WWbloBL9SmgC>

Application note 30 Estimating emissions from source by inverse modeling

Scope of application

This method is used to estimate the fluxes of gaseous or particulate compounds emitted from a reasonably well isolated source of known geometry. It has been used in particular to estimate emissions of methane (CH₄) from manure storage systems (Flesch *et al.*, 2004), in the field after spreading slurry, manure or mineral fertilizers (Carozzi *et al.*, 2013a; Carozzi *et al.*, 2013b; Loubet *et al.*, 2010) as well as emissions from livestock buildings (Hensen *et al.*, 2009). This method can be used with real-time analyzers such as QCL - Tunable Infrared Laser Differential Absorption Spectrometers (Application note 12) or integrative passive diffusion samplers (Application note 1). Although this method is mainly suitable for isolated sources, it can be used to estimate emissions from a number of plots on condition that the sensors are well positioned (Denmead, 2008; Flesch *et al.*, 2009). This method has been used to determine NH₃ emissions from groups of agricultural fields (Cohan *et al.*, 2013; Loubet *et al.*, 2013). In principle this method can also be used to estimate other emissions such as particulates (Prank *et al.*, 2010), greenhouse gases (Leytem *et al.*, 2013) and volatile organic compounds (Hirst *et al.*, 2004).

Operating principles

The method measures concentrations in and around the plot studied and then adjusts the source terms S_j to minimize the difference between the measured concentrations (C_{mes}^i) and the predicted concentrations (C_{mod}^i). The concentrations are predicted by:

$$C_{mod}^i = \sum_{j=1}^N D_{ij} S_j + C_{background} \quad (\text{eq.M30.1})$$

where

N is the number of sources,

D_{ij} is the transfer coefficient which is the concentration C_{mod}^i that would be produced by the source S_j if were the sole source equal to 1 and the background concentration $C_{background}$ were zero.

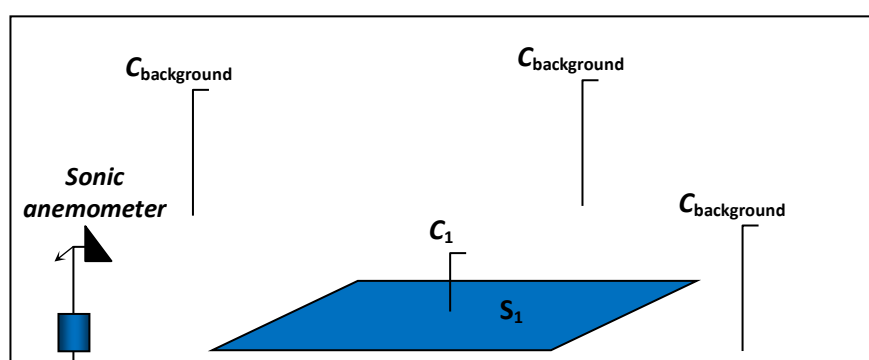

Figure M30.1. Typical configuration for estimating the emissions S₁ from an isolated plot

A concentration sensor C₁ is placed in the middle of the plot and three concentration sensors in the surrounding area to estimate the background concentration. A sonic anemometer is also used to characterize the turbulence in the boundary layer.

In practice, D is estimated using an atmospheric dispersion model. There are various models with calculation software:

- Stochastic lagrangian models describe the trajectory of a large number of fluid parcels emitted by the sources, moving in a random walk, the concentration at a particular point being equal to the probability of the presence of these parcels at that point. Windtrax software is based on this principle (Flesch *et al.*, 2004). These models are suitable for dispersion over short distances and allow the statistics of the emissions from the sources to be estimated. The turbulence in the boundary layer is represented using the Monin-Obukhov similarity theory or based on direct measurements of the Reynolds tensor ($u_i u_j$) and heat fluxes. Windtrax is described on the Thunderbird Scientific website (<http://www.thunderbeachscientific.com/>) (Flesch *et al.*, 2004).
- Gaussian and pseudo-Gaussian models are based on solving Euler's equations for fluid dynamics based on the conservation of mass (or based on the advection-diffusion equation). Gaussian models are based on the assumption that the wind and the diffusion coefficient are constant, whereas pseudo-Gaussian models such as FIDES are based on vertical profiles for the wind and diffusion coefficient that follow a power law ($U(z) = a z^p$, $K(z) = b z^n$). For a complete description see Loubet *et al.* (2010).

These models for the concentrations at the measurement points require, a *minima*, the following parameters: friction velocity (u^*), Obukhov length (L), aerodynamic roughness length (z_0), zero plane displacement (d), wind vector (U, V, W) and standard deviations ($\sigma_u, \sigma_v, \sigma_w$). There are various optimization methods for fitting the predictions to the measurements. Linear regression is suitable.

Equipment required

- A 3D sonic anemometer to measure the flow characteristics: friction velocity (u^*), Obukhov length (L), wind vector (U, V, W) and standard deviations ($\sigma_u, \sigma_v, \sigma_w$) and sensible heat flux (H). The anemometer is also used to estimate the aerodynamic roughness length of the surface (z_0) (Loubet *et al.*, 2013). There are various suppliers of sonic anemometers at reasonable prices. A computer or data logger is required to store the data.
- An analyzer or sampler for the compound being studied (NH_3 , CH_4 , N_2O , VOCs, aerosols) which is placed at the center of the plot or downwind of the farm whose emissions are to be estimated. Another analyzer or samplers are positioned upwind or at the cardinal points.
- Precise details of the geometry of the source and the position of the sensors (targets). The geometry of the source must be measured precisely using a GPS or theodolite. The position and height of the samplers must also be determined precisely. For sources with strong dynamics (manure spreading), the exact trajectory of the tractor must be recorded to define the source zone dynamically. The height of the ground cover h_c should also be measured precisely, if appropriate, and the zero plane displacement, equal to about $0.7 h_c$, taken into account.

Implementation

- Concentration measurement points:

- For measuring emissions on a plot, the measurement point should be at a height of less than one tenth of the fetch¹⁵ to maximize the effect of the source on the sensor. It must not be too close to the ground to avoid excessive uncertainty on the height of the sensor. Typically, it should be more than 30 cm above the ground.
- For measuring emissions from a livestock building, the measurement point should be at a distance of more than 100 m so that it is not in an area where the airflow is more turbulent than in the boundary layer to ensure that the turbulence is spatially uniform. The sensor must be sufficiently high so that it is not affected by the surface (typically 1.5 m).
- The background measurement points must be positioned far away from the source being measured and other local sources, typically at least 400 m away. However, if the geographical situation does not allow this, they should be more than 100 m away. 3 to 4 measurement points should be used. The measurement frequency can be lower than for the measurement point on the plot or downwind of the building.
- Position of the 3D sonic anemometer. The anemometer is used to measure the mean airflow over the source and in the environment. Measurements should preferably be at about 1.5 m close to the main measurement point.
- Frequency of concentration measurements. Ideally, measurements should be taken every half hour on the plot or downwind of the building and daily or weekly for background concentrations. However, it might be useful to characterize the background concentration dynamics first to give a more accurate assessment. For emissions with strong dynamics, such as after manure spreading, background measurements can be taken at increasing intervals (2h, 6h, 12h, 24h, 7 days, 1 month).
- Calculating the turbulence parameters. Free software is available for acquisition and processing of the anemometer data (e.g. Edisol, Edire, Edipro, etc).
- Estimating the source terms using a dispersion model. Windtrax requires a map of the source and the sensors using a special graphics interface and links to the input and output data files. For FIDES, the map is generated using a coordinates file and the output is sent to a csv file. Scripts are available for FIDES.

Standard meteorological measurements, such as solar radiation, air temperature and humidity, wind speed and direction, are useful as explicative and control variables.

Validation and sources of uncertainty

The inverse modeling method has been validated in several situations. Lagrangean models (Flesch *et al.*, 2004) have been validated using controlled methane sources and have shown a bias generally less than 20%. The FIDES model was validated for ammonia fluxes in comparison with the aerodynamic gradient method (Application note 28) after amendment with calcium ammonium nitrate and with manure (Loubet *et al.*, 2009; Loubet *et al.*, 2013) with a bias less than 10%.

The main source of uncertainty is the precision of the concentration measurement and of the difference between the background concentration and the concentration in the plot. Loubet *et*

¹⁵ The fetch is the distance between the measurement mast and the upwind edge of the field.

al. (2010) showed that the inverse modeling method requires a resolution for the concentration difference $(C - C_{\text{background}}) = a S / u^*$ where a varies between 1.2 and 4.1. A central assumption for the method is that the source and the surface are uniform, which is not often the case in practice. Other sources of uncertainty are the geometry of the source which is not easy to determine, in particular during manure spreading as the source moves with the tractor, and the estimation of the turbulence parameters, z_0 , u^* and L .

Advantages and limitations

Advantages: The main advantage of the method is that it is easy to use and does not require a real-time analyzer as does the eddy covariance method (Application note 31). Another practical advantage is that modeling software is already available (Windtrax and FIDES).

Limitations: The main limitation is that the source must be isolated. It is difficult if not impossible to use this method for sources and sinks of similar intensity distributed around the landscape. This method is preferable for high level sources in areas with fairly constant, low background concentrations. The second limitation is the assumption in the dispersion models that the ground surfaces are uniform. This method is, therefore, not suitable for an area with hedges or isolated trees or sudden changes in roughness. However, small obstacles do not significantly affect the method.

Costs: The cost of this method depends on the type of sampling that is used (impingers, passive diffusion samplers, analyzers which are fairly expensive). The fixed costs are the micrometeorological measurement station which has a 3D sonic anemometer (price €2,000 to €3,000, no maintenance) and data logger (price €1,000 to €3,000, low maintenance). The method requires at least 2 concentration measurement points for each source plot (one in the center of the plot and one for the background concentration). If integrative sensors (impingers or passive diffusion samplers) are used, at least 6 measurement periods are required. The sampling systems need not all be the same: an analyzer may be used in the middle of the plot and several passive samplers used for measuring the background concentrations. The operational costs of these samplers are detailed in Application notes 1, for passive diffusion samplers, 3 for impingers, 9 for chemiluminescence analyzers, 12 for laser absorption spectroscopy, etc.

References

Authors:

- Benjamin Loubet, INRA, UMR EGC - Thiverval-Grignon, France

Other organizations: Joerg Sintermann, FAL, ARVALIS – Institut du Végétal

Bibliography

Carozzi, M., Loubet, B., Acutis, M., Rana, G., Ferrara, R.M. 2013a. Inverse dispersion modelling highlights the efficiency of slurry injection to reduce ammonia losses by agriculture in the Po Valley (Italy). *Agricultural and Forest Meteorology*. 171, 306-318
10.1016/j.agrformet.2012.12.012

Carozzi, M., Ferrara, R.M., Rana, G., Acutis, M. 2013b. Evaluation of mitigation strategies to reduce ammonia losses from slurry fertilisation on arable lands. *Science of the Total Environment*. 449, 126-133
10.1016/j.scitotenv.2012.12.082

- Cohan, J.P., Charpiot, A., Morvan, T., Eveillard, P., Trochard, R., et al. 2013. Quantification des émissions d'ammoniac suite à l'épandage de produits résiduaux organiques et d'engrais minéraux au champ – 1ère synthèse des résultats acquis dans le cadre du projet CASDAR VOLAT'NH3 (Quantification of ammonia emissions after spreading organic residues and mineral fertilizers on a field - 1st report on the results from the CASDAR VOLAT'NH3 project). 11èmes Rencontres de la fertilisation raisonnée et de l'analyse/COMIFER-GEMAS (11th conference on rational amendment and analysis / COMIFER-GEMAS). Poitiers, November 20 and 21, 2013, 8 p.
- Denmead, O.T. 2008. Approaches to measuring fluxes of methane and nitrous oxide between landscapes and the atmosphere. *Plant and Soil*. 309 (1-2), 5-24 10.1007/s11104-008-9599-z
- Flesch, T.K., Wilson, J.D., Harper, L.A., Crenna, B.P., Sharpe, R.R. 2004. Deducing ground-to-air emissions from observed trace gas concentrations: A field trial. *Journal of Applied Meteorology*. 43 (3), 487-502 10.1175/1520-0450(2004)043<0487:dgefot>2.0.co;2
- Flesch, T.K., Harper, L.A., Desjardins, R.L., Gao, Z., Crenna, B.P. 2009. Multi-Source Emission Determination Using an Inverse-Dispersion Technique. *Boundary-Layer Meteorology*. 132 (1), 11-30 10.1007/s10546-009-9387-1
- Hensen, A., Loubet, B., Mosquera, J., van den Bulk, W.C.M., Erisman, J.W., et al. 2009. Estimation of NH₃ emissions from a naturally ventilated livestock farm using local-scale atmospheric dispersion modelling. *Biogeosciences*. 6 (12), 2847-2860 10.5194/bg-6-2847-2009
- Hirst, B., Gibson, G., Gillespie, S., Archibald, I., Podlaha, O., et al. 2004. Oil and gas prospecting by ultra-sensitive optical gas detection with inverse gas dispersion modelling. *Geophysical Research Letters*. 31 (12) 10.1029/2004gl019678
- Leytem, A.B., Dungan, R.S., Bjorneberg, D.L., Koehn, A.C. 2013. Greenhouse Gas and Ammonia Emissions from an Open-Freestall Dairy in Southern Idaho. *Journal of Environmental Quality*. 42 (1), 10-20 10.2134/jeq2012.0106
- Loubet, B., Milford, C., Hensen, A., Daemmgen, U., Erisman, J.W., et al. 2009. Advection of NH₃ over a pasture field and its effect on gradient flux measurements. *Biogeosciences*. 6 (7), 1295-1309 10.5194/bg-6-1295-2009
- Loubet, B., Genermont, S., Ferrara, R., Bedos, G., Decuq, G., et al. 2010. An inverse model to estimate ammonia emissions from fields. *European Journal of Soil Science*. 61 (5), 793-805 10.1111/j.1365-2389.2010.01268.x
- Loubet, B., Cellier, P., Flechard, C.R., Zurfluh, O., Irvine, M., et al. 2013. Investigating discrepancies in heat, CO₂ fluxes and O₃ deposition velocity over maize as measured by the eddy-covariance and the aerodynamic gradient methods. *Agricultural and Forest Meteorology*. 169, 35-50 10.1016/j.agrformet.2012.09.010
- Prank, M., Sofiev, M., van der Gon, H.A.C.D., Kaasik, M., Ruuskanen, T.M., et al. 2010. A refinement of the emission data for Kola Peninsula based on inverse dispersion modelling. *Atmospheric Chemistry and Physics*. 10 (22), 10849-10865 10.5194/acp-10-10849-2010

Application note 31 Measuring emissions from a diffuse source by eddy covariance

Scope of application

Eddy covariance is a standard method for measuring fluxes emitted by a sufficiently large and relatively uniform source (typically around 10 hectares and at least 1 hectare). This method can be used to measure any gaseous compounds and particulates assuming that an analyzer able to take high speed real-time measurements is used (5Hz minimum, ideally 10 to 20 Hz). This method is used routinely for time series spanning several years for measuring CO₂, water and sensible heat fluxes as well as ozone. It is being extended to cover gaseous nitrogen compounds and greenhouse gases with the advent of quantum cascade laser spectrometers (QCL, Application note 12) that are sufficiently sensitive for N₂O and methane and, more recently, ammonia. The development of chemiluminescent analyzers (Application note 9) with sensitive photometric detectors, high vacuum systems and photochemical NO₂->NO converters make it suitable for measuring nitrogen oxides (NO and NO₂). The recent development of proton transfer reaction mass spectrometers (PTR-MS) now makes it possible to use eddy covariance to measure fluxes of volatile organic compounds (VOC) and NH₃, as well as aerosol fluxes.

Operating principles

Eddy covariance is used to measure the fluxes of compounds through a horizontal plane through the measurement point. The molar flux crossing this plane at each moment is equal to the product of the concentration of compound C (mol.m⁻³) around this plane and the wind component w (m.s⁻¹) normal to the plane. Averaging this instantaneous flux over a period gives the mean flux for the period: $F = \overline{w \cdot C}$ (mol m².s⁻¹) Although the theory is simple, the application is more complex. To avoid errors due to lack of precision and zero drift of the sensors, the above equation is modified to include only fluctuations in wind speed and concentration around the means (w' and C' , which are not affected by drift). However, several fundamental assumptions are required to define the new equation and determining C' requires high frequency concentration measurements which are rarely unbiased. Two fundamental assumptions in particular limit the application of this method:

- The airflow must be horizontally uniform and constant over a period of between 15 minutes and 2 hours, i.e. there must be no sudden changes in climate or airflow during this period. This condition is sometimes not met at night when gravity waves¹⁶ may occur. It is also not met when downwind of a nearby major emissions source, such as a main road for NO_x. Further information on these aspects may be found in Mahrt (2007; 2010).
- Measurements must be taken at a frequency significantly greater than the frequency of the eddies responsible for the mass transfer and for a sufficiently long time to include the lowest frequency eddies.

¹⁶ Gravity waves occur essentially above forests in boreal conditions. They are associated with thermally stratified atmospheres (Lee et al. 1997)

A further assumption is not directly associated with the method but with the interpretation of the fluxes measured at a given height above the surface. It is assumed that the flux measured at the height of the measurement point is equal to the surface flux. This is based on two assumptions. The first is that there is no net advection below the measurement system, i.e. that the volume of air whose composition has been modified by the source or sink in the plot studied does not leave by lateral airflow without being replaced by a volume with equivalent properties (which is the case when turbulence is low and the ecosystem is not uniform over the whole of the surface and surrounding area). The second assumption is that there is no storage effect, i.e. the mass of air below the measurement mast does not act as a reservoir (which is the case during periods with very little wind). Reviews of the eddy turbulence method are available (Aubinet *et al.*, 2000; Lee *et al.*, 1997; Massman and Lee, 2002).

Equipment required

Eddy covariance measurements require the following equipment:

- A 3D sonic anemometer to measure the three components of the wind at a frequency greater than 20 Hz.
- A high speed real-time gas analyzer with an acquisition rate at least 2 to 5 Hz and ideally 20 Hz.
- If the analyzer is not open path, a sampling system with a pump is required to transfer the air samples to the analyzer. The pump should be selected to transfer the air sample sufficiently quickly to minimize chemical interactions between the compounds to be measured and the surfaces, and in particular the possible attenuation of the high frequency variations in concentration caused by drag on the walls creating artificial mixing. To achieve this, the flow should be turbulent (Reynolds number greater than 2,000-3,000) and the transfer time less than a few seconds. The air should be sampled below the sonic anemometer with a sampling head that should be unobtrusive to avoid affecting the wind speed measurements.
- A mast for positioning the system at a given height without affecting the wind speed measurements
- A 20 Hz or 50 Hz data logger.



Figure M31.1. Eddy covariance system for measuring CO₂ fluxes (INRA)

Implementation

As well as the equipment, the method requires a suitable site to minimize the limitations of the method: a flat uniform surface that is as large as possible, no nearby major emission sources and no nearby obstacles. Analyzers able to take the measurements at a high frequency often require very high power vacuum pumps and so it is usually necessary to have a connection to an electricity supply. It should be possible to access the system remotely to check the analyzers (by satellite for example). The data acquired must be

archived regularly and processed by software such as EdiRe, EddyMeas and EddyPro. The analyzers must also be regularly calibrated automatically or manually.

Validation and sources of uncertainty

This is now a standard method used for CO₂, water and sensible heat. It has been evaluated many times using both theoretical and experimental methods (Ueyama *et al.*, 2012). However, there are very few studies comparing this method to others and there are major doubts about possible biases in the method, in particular concerning the loss of high frequency information for reactive compounds such as ammonia (Ferrara *et al.*, 2012; Sintermann *et al.*, 2011; Whitehead *et al.*, 2008). In particular, it appears that there are residuals in the energy balance at a number of measurement sites, which calls into question the various measurements of energy flows (radiation, conduction, storage in biomass and convection by eddy covariance) (Foken, 2008; Leuning *et al.*, 2012).

The main source of uncertainty is the loss of high frequency information as a result of using an analyzer that is not fast enough (Massman, 2000). Variations in the wind and errors in the estimate of the area of the source of the flux being measured are both major sources of uncertainty but the uncertainty can be estimated using standard tests (Aubinet *et al.*, 2000) and footprint models (Kljun *et al.*, 2004). Finally, low frequency variations in the fluxes due to the site's topography (rolling, flat) and the way the topography is accounted for in the data processing also introduce uncertainties.

Advantages and limitations

Advantages: The main advantage of this method is that it provides almost continuous direct measurement of the flux from the surface, it is conceptually simple and relatively easy to implement provided that there is a source of electrical power if required.

Limitations: The limitations of this method come from the requirement for a high speed real-time analyzer that is sufficiently sensitive that the flux detection limit is acceptable. This is reasonably easy for H₂O, CO₂, O₃, feasible for N₂O and CH₄ but is still difficult for NH₃, NO, NO₂ and VOCs. Sampling is also difficult for reactive compounds because of chemical reactions and carry over in the sampling pipe. Two further limitations come from the requirement to have the necessary skills for processing the raw data and the cost of the high speed analyzers.

Costs: One of the main costs is the 3D sonic anemometer (price €2,000 to €3,000, no maintenance) and the data logger (price €1,000 to €3,000, low maintenance). It also requires a high speed QCL or chemiluminescence analyzer for NH₃, N₂O and CH₄ (currently the price is very high €60,000 to €120,000). For CO₂ the price is much lower (€5,000 to €10,000).

References

Authors:

- Benjamin LOUBET, INRA – Thiverval-Grignon, France

Other organizations: Lylian Joly, University of Reims – Reims, France

Bibliography

- Aubinet, M., Grelle, A., Ibrom, A., Rannik, U., Moncrieff, J., et al. 2000. Estimates of the annual net carbon and water exchange of forests: The EUROFLUX methodology. *Advances in Ecological Research*, Vol 30. 30, 113-175
- Ferrara, R.M., Loubet, B., Di Tommasi, P., Bertolini, T., Magliulo, V., et al. 2012. Eddy covariance measurement of ammonia fluxes: Comparison of high frequency correction methodologies. *Agricultural and Forest Meteorology*. 158, 30-42 10.1016/j.agrformet.2012.02.001
- Foken, T. 2008. The energy balance closure problem: An overview. *Ecological Applications*. 18 (6), 1351-1367 10.1890/06-0922.1
- Kljun, N., P. Calanca, M. W. Rotach, and H. P. Schmid. 2004. A simple parameterisation for flux footprint predictions. *Boundary-Layer Meteorology*, 112: 503-523.
- Lee, X., Neumann, H.H., DenHartog, G., Fuentes, J.D., Black, T.A., et al. 1997. Observation of gravity waves in a boreal forest. *Boundary-Layer Meteorology*. 84 (3), 383-398 10.1023/a:1000454030493
- Leuning, R., van Gorsel, E., Massman, W.J., Isaac, P.R. 2012. Reflections on the surface energy imbalance problem. *Agricultural and Forest Meteorology*. 156, 65-74 10.1016/j.agrformet.2011.12.002
- Mahrt, L. 2007. The influence of nonstationarity on the turbulent flux-gradient relationship for stable stratification. *Boundary-Layer Meteorology*. 125 (2), 245-264 10.1007/s10546-007-9154-0
- Mahrt, L. 2010. Computing turbulent fluxes near the surface: Needed improvements. *Agricultural and Forest Meteorology*. 150 (4), 501-509 10.1016/j.agrformet.2010.01.015
- Massman, W.J. 2000. A simple method for estimating frequency response corrections for eddy covariance systems. *Agricultural and Forest Meteorology*. 104 (3), 185-198 10.1016/s0168-1923(00)00164-7
- Massman, W.J., Lee, X. 2002. Eddy covariance flux corrections and uncertainties in long-term studies of carbon and energy exchanges. *Agricultural and Forest Meteorology*. 113 (1-4), 121-144 10.1016/s0168-1923(02)00105-3
- Sintermann, J., Spirig, C., Jordan, A., Kuhn, U., Ammann, C., et al. 2011. Eddy covariance flux measurements of ammonia by high temperature chemical ionisation mass spectrometry. *Atmospheric Measurement Techniques*. 4 (3), 599-616 10.5194/amt-4-599-2011
- Whitehead, J.D., Twigg, M., Famulari, D., Nemitz, E., Sutton, M.A., et al. 2008. Evaluation of laser absorption spectroscopic techniques for eddy covariance flux measurements of ammonia. *Environmental Science & Technology*. 42 (6), 2041-2046 10.1021/es071596u

Application note 32 Measuring emissions from a diffuse source using REA, DEC and vDEC

Scope of application

The various methods derived from eddy covariance (Relaxed Eddy Accumulation (REA), Disjunct Eddy Covariance (DEC), and Virtual Disjunct Eddy Covariance (vDEC, sometimes called DEC-MS) have the same scope of application as eddy covariance itself (Application note 31). They are suitable for measuring fluxes emitted by a sufficiently large and relatively uniform source (typically around 10 hectares and at least 1 hectare). These methods can, in principle, be used to measure any gaseous compounds and particulates but, unlike eddy covariance, do not require a 10 to 20 Hz, real-time analyzer. These methods are, therefore, used for measuring fluxes of compounds for which there are no high speed analyzers. However, they are rarely used as a routine method as they require more equipment (high speed solenoid valves, bags) and more human effort. Some of these methods based on simple samplers can be used for long-term measurements.

- The REA method described by Businger and Oncley (1990) requires an analyzer response of 30 minutes to 1 hour. It has been used satisfactorily for volatile organic compounds (VOCs), particulates down to ultrafine, ammonia, nitric acid, sulfate, sulfur dioxide, methane, N₂O and pesticides.
- The DEC (Haugen, 1978) and vDEC methods require analyzers with a response time of a few tens of seconds per channel. These methods have been used mostly for VOCs (where 10 compounds can be scanned successively) as well as for aerosols, N₂O and NO_x.

Operating principles

Disjunct eddy covariance (DEC, vDEC) and eddy accumulation (EA, REA) methods are based on the same principle as eddy covariance and measure the fluxes of compounds through a horizontal plane through the measurement point (Application note 31). They differ from the eddy covariance method in that the sampling is conditional for the accumulation methods and at intervals greater than the system response time for disjunct methods.

- The Relaxed Eddy Accumulation (REA) method is based on two fundamental assumptions: (i) the “flux-variance similarity” for a compound (Obukhov, 1960; Wyngaard and Coté, 1971; Wyngaard *et al.*, 1971) and (ii) the “scalar similarity” between the transport of different scalars (such as the temperature and the compound of interest). The compound is sampled conditionally depending on the vertical wind component. When the wind is upwards, the air is stored in the “up” bag and when the wind is downwards, the air is stored in the “down” bag (Ruppert *et al.*, 2006). The flux is expressed as $F = b\sigma_w(\bar{C}_\uparrow - \bar{C}_\downarrow)$ (g.m⁻².s⁻¹) where b is a proportionality coefficient, σ_w is the standard deviation of the vertical wind component (m.s⁻¹) and \bar{C}_\uparrow and \bar{C}_\downarrow and the concentrations in the “up” and “down” bags (g.m⁻³). For ideal turbulence, b is 0.627. In practice, b is estimated for each measurement period by assuming that the same equation applies to the flux of the compound and to the temperature. It is calculated from the covariance between the temperature and the vertical wind component $\overline{w'T'}$ and the difference between the “up” temperatures \bar{T}_\uparrow and the “down” temperatures \bar{T}_\downarrow : $b = \overline{w'T'}/\sigma_w(\bar{T}_\uparrow - \bar{T}_\downarrow)$.

- The Disjunct Eddy Covariance (DEC) method is based on the same principle as eddy covariance. The flux is taken to be equal to the covariance of the concentration (C) and the vertical wind component w : $F = \overline{w' \cdot C'}$. The difference is that, instead of measuring the concentration fluctuations at high speed (typically 10 to 20 Hz), the concentration fluctuations are estimated by sampling air every 10 to 30 s over a very short sampling period (0.1 to 0.2 s). This means that the concentration of the compound can be measured using analyzers with a response time of around ten seconds. As the air is sampled for a very short period, the covariance with the vertical wind component is not attenuated. Because the measurements are not continuous, subsequent processing is carried out as if it were a conventional series of covariance data which was only being analyzed for 1 point in every 10 or 20 points (Figure M32.1). The covariance, however, is unaffected. There is, however, attenuation of frequencies greater than 10 Hz which should be evaluated.

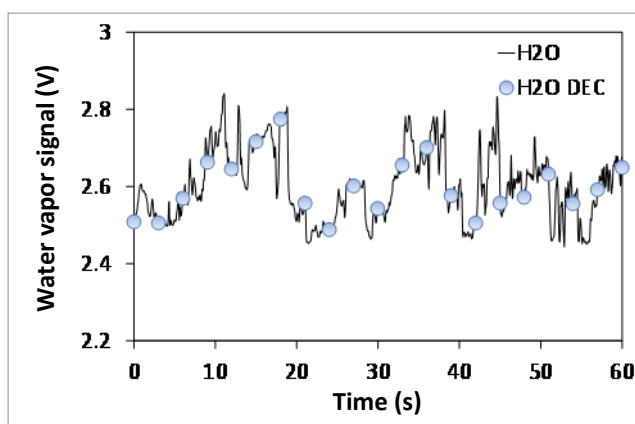

Figure M32.1. Illustration of the DEC method taking samples 3 times a second in comparison with a method taking samples at 20Hz (Pers.comm. Benjamin Loubet)

- The vDEC method is based on the same principle as the DEC method which takes samples over a short time interval with a shorter sampling frequency than the eddy covariance method. The difference is that there is no storage system and a high frequency analyzer can be used for sequential measurements of the concentration of several different compounds such as VOCs. The vDEC method can also be used to measure the fluxes of a compound at several different heights.

Equipment required

The DEC or REA methods for measuring fluxes require a 3D sonic anemometer which measures the three wind components at a frequency greater than 10 Hz. There are several models on the market.

- The REA method required a concentration analyzer able to analyze at least three samples in each measurement period (30 minutes to 2 hours). The samples may be assayed in a laboratory (storage in bags, denuders or WEDD reservoirs).
- The DEC method requires a concentration analyzer with an acquisition time of at least 10 to 20 seconds, ideally a few seconds. It also requires a multiplexer and a complex sample storage system which can store one sample while assaying another.

- The vDEC method requires a concentration analyzer with the same basic acquisition frequency as the eddy covariance method (10 – 20 Hz).
- The sampling systems and pump should be dimensioned to ensure that the samples are transferred rapidly to avoid attenuating the high frequency variations in the concentrations which would reduce the apparent flux.
- A mast for positioning the system at a given height without affecting the wind speed measurements.
- A 20 Hz or 50 Hz data logger.

Implementation

As well as the equipment, the method requires a suitable site to minimize the limitations of the method: a flat uniform surface that is as large as possible, no nearby major emission sources and no nearby obstacles. Analyzers able to take the measurements at a high frequency often require very high power vacuum pumps and so it is usually necessary to have a connection to an electricity supply. It should be possible to connect to the Internet for the acquisition system to monitor the analyzers and storage systems for vDEC and REA. The data acquired must be archived regularly and processed by the same type of software as used for standard eddy covariance. The analyzers must also be regularly calibrated automatically or manually.

Validation and sources of uncertainty

The REA method has been validated using theoretical methods and by direct comparison for CO₂, for example, by Brut *et al.* (2004). One of the main limitations for the REA method is in the assumptions of flux-variance similarity and scalar similarity (Ruppert *et al.*, 2006). In particular, the determination of the constant *b* depends on conditional sampling which is strongly affected by variations in both the wind and the concentration (Gronholm *et al.*, 2008).

The DEC method has been validated, both by sub-sampling eddy covariance measurements, and by comparing DEC and EC measurements for “inert” compounds such as CO₂ (Hoertnagl *et al.*, 2010). One limitation of the method is the maximum time between each sample: this is limited in practice by the number of data points that can be acquired during the integration period (30 min to 2 h). For flux measurements with an uncertainty of less than 10%, studies have shown that, typically, at least 2 to 15 measurements per minute are required (Rinne *et al.*, 2008; Turnipseed *et al.*, 2009). Another limitation of this method is the difficulty of evaluating the effect of high frequency attenuation on the fluxes (Hoertnagl *et al.*, 2010). As the vDEC method has the same basis as the DEC method, it must be validated in the same way and has the same sources of uncertainty. However, there is an additional uncertainty in the assessment of the time lag (phase lag) between the concentration measurement and the wind measurement. This time lag must be determined (Hoertnagl *et al.*, 2010).

Advantages and limitations

Advantages: The main advantage of the DEC and vDEC methods is that they can be used for direct measurement of the flux, similar to the eddy covariance method but using analyzers with a response time of around ten seconds for a given channel rather than a tenth of a second. However the REA has an advantage over the vDEC methods in that the volume

sampled for each sample is much larger and generally provides higher sensitivity and therefore a lower limit of detection for the fluxes.

Limitations: The DEC, vDEC and REA need a concentration analyzer that is sufficiently sensitive to provide an acceptable limit of detection for the fluxes. Although it is similar to EC, the REA method introduces additional assumptions about the scalar similarity between the transports of heat and the compound of interest. The main drawback with the DEC method is the need to store a sample in one reservoir while another reservoir contains the sample being analyzed. The main drawback of the REA method is the requirement to store the sample to be analyzed in three reservoirs. Such systems are difficult to implement and there are no complete systems on the market. This method is not very suitable for reactive compounds such as NH₃, NO_x, VOCs and aerosols which may react in the reservoirs. The vDEC method does not use reservoirs and so avoids this problem but it requires analyzers with response times for “each compound” similar to those used for the eddy covariance method (Karl *et al.*, 2002).

Costs: The vDEC and REA methods require a high frequency 3D anemometer (price €5,000 to €15,000) and data logger (price €3,000 to €6,000). These methods usually require high speed, high throughflow, inert multiplexers (€1,000). For REA, the analyzers may be slow while for vDEC and DEC they must be relatively fast and, therefore, expensive (€60,000 to €200,000).

References

Authors:

- Benjamin Loubet, INRA, UMR EGC – Thiverval-Grignon, France

Other organizations: Laboratoire des Sciences du Climat et de l'Environnement – Saclay, France

Bibliography

- Brut, A., Legain, D., Durand, P., Laville, P. 2004. A relaxed eddy accumulator for surface flux measurements on ground-based platforms and aboard research vessels. *Journal of Atmospheric and Oceanic Technology*. 21 (3), 411-427 10.1175/1520-0426(2004)021<0411:areafs>2.0.co;2
- Businger, J.A., Oncley, S.P. 1990. Flux measurement with conditional sampling. *Journal of Atmospheric and Oceanic Technology*. 7 (2), 349-352 10.1175/1520-0426
- Gronholm, T., Haapanala, S., Launiainen, S., Rinne, J., Vesala, T., et al. 2008. The dependence of the beta coefficient of REA system with dynamic deadband on atmospheric conditions. *Environmental Pollution*. 152 (3), 597-603 10.1016/j.envpol.2007.06.071
- Haugen, D. 1978. Effects of sampling rates and averaging periods on meteorological measurements. In: Society, A.M. (Ed.). Fourth Symposium on Meteorological Observations and Instrumentation, American Meteorological Society. Denver, Colorado, US, April 10-14, 1978, p. 15-18
- Hoertnagl, L., Clement, R., Graus, M., Hammerle, A., Hansel, A., et al. 2010. Dealing with disjunct concentration measurements in eddy covariance applications: A comparison of available approaches. *Atmospheric Environment*. 44 (16), 2024-2032 10.1016/j.atmosenv.2010.02.042

- Karl, T.G., Spirig, C., Rinne, J., Stroud, C., Prevost, P., et al. 2002. Virtual disjunct eddy covariance measurements of organic compound fluxes from a subalpine forest using proton transfer reaction mass spectrometry. *Atmospheric Chemistry and Physics*. 2, 279-291
- Obukhov, A.M. 1960. Structure of the temperature and velocity fields under conditions of free convection. *Izv. Akad Nauk SSSR, Ser. Geofiz.* 9, 1392-1396
- Rinne, J., Douffet, T., Prigent, Y., Durand, P. 2008. Field comparison of disjunct and conventional eddy covariance techniques for trace gas flux measurements. *Environmental Pollution*. 152 (3), 630-635 10.1016/j.envpol.2007.06.063
- Ruppert, J., Thomas, C., Foken, T. 2006. Scalar similarity for relaxed eddy accumulation methods. *Boundary-Layer Meteorology*. 120 (1), 39-63 10.1007/s10546-005-9043-3
- Turnipseed, A.A., Pressley, S.N., Karl, T., Lamb, B., Nemitz, E., et al. 2009. The use of disjunct eddy sampling methods for the determination of ecosystem level fluxes of trace gases. *Atmospheric Chemistry and Physics*. 9 (3), 981-994
- Wyngaard, J.C., Coté, O.R. 1971. The Budgets of Turbulent Kinetic Energy and Temperature Variance in the Atmospheric Surface Layer. *Journal of the Atmospheric Sciences*. 28 (2), 190-201 10.1175/1520-0469(1971)028<0190:TBOTKE>2.0.CO;2
- Wyngaard, J.C., Coté, O.R., Izumi, Y. 1971. Local Free Convection, Similarity, and the Budgets of Shear Stress and Heat Flux. *Journal of the Atmospheric Sciences*. 28 (7), 1171-1182 10.1175/1520-0469(1971)028<1171:LFCST>2.0.CO;2

2.3 Summary of the advantages and limitations of the methods

General: Many of the methods, in particular those for measuring fluxes and emissions, require in-depth experience in operating, and processing and analyzing data.

2.3.1 Sampling methods

Table XIV. Summary of advantages and limitations of sampling methods

Method	Target gases	Most common applications	Other methods used in combination	Advantages	Limitations
1 - Passive diffusion samplers	NH ₃ , NO _x , VOCs	Livestock building Plot	Analysis: 7 Airflow: 13, 14, 15, 16 Emissions: 26, 27, 28, 32	<ul style="list-style-type: none"> • Easy to implement • High sensitivity for NH₃ in particular in low concentrations • Low unit cost 	<ul style="list-style-type: none"> • Gives an average concentration over the exposure time • Can only be used over long periods from a few hours to a few weeks • Some samplers may be affected by dust • Total cost of measurement may be close to that of an automatic analyzer when measurements have to be repeated over a long period
2 - Denuder tubes	NH ₃ , NO _x , VOCs	Plot	Analysis: 7 Emissions: 26, 27, 28, 32	<ul style="list-style-type: none"> • Easy to implement • High sensitivity, can be adapted to the concentrations expected • Preferable to passive samplers for short sampling periods (from a few minutes up to about an hour) • Enables a wide variety of compounds to be collected in a relatively short sampling time • Low unit cost 	<ul style="list-style-type: none"> • Requires manual intervention for each measurement, except for wet effluent diffusion denuders • For wet effluent diffusion denuders, the method is more expensive and there is a risk that measurements may be affected by microbiological contamination

Method	Target gases	Most common applications	Other methods used in combination	Advantages	Limitations
3 - Trapping in an acid solution	NH ₃	Livestock building, Manure storage, Fields, Pasture	Analysis: 7 Airflow: 13, 14, 15, 16 Emissions: 20, 26, 27, 28	<ul style="list-style-type: none"> • Robust • High sensitivity • Can be adapted to the concentrations expected, and to the sampling period • Low unit cost 	<ul style="list-style-type: none"> • The process is time-consuming and difficult to automate • Not suitable for high temporal resolution monitoring • There may be interference from other absorbable species containing nitrogen (eg: volatile amines).
4 - Continuous sampling methods for real-time analysis	Any gas	Livestock building, Manure storage, Fields, Pasture	Analysis: 8, 9, 10, 11, 12 Airflow: 13, 14, 15, 16 Emissions: 17, 20, 22, 24, 26 to 32	<ul style="list-style-type: none"> • The air samples can be analyzed <i>in situ</i>, in real time and continuously over long periods of time (high temporal resolution) • Samples can be taken from several different sampling points in succession at the same site 	<ul style="list-style-type: none"> • It may take some time to set up or move the sampling system • An investment of several thousand Euros may be required, excluding data processing • The pipework needs to be protected against dust and condensation • For suction systems, there must be no leaks between the sampling point and the analyzer that might dilute or contaminate the gas samples
5- Sample bags and tubes	Any gas	Livestock building, Fields, Pasture	Analysis: 8, 10, Airflow: 13, 14, 15, 16 Emissions: 17, 22, 23, 24,	<ul style="list-style-type: none"> • Good preservation of samples of nonreactive compounds for several days before analysis. • Easy to implement 	<ul style="list-style-type: none"> • Care must be taken when filling sample tubes and bags • Both containers should be protected during transportation

2.3.2 Concentration analysis methods

Table XV. Summary of the advantages and limitations of concentration analysis methods

Method	Target gases	Other methods used in combination	Advantages	Limitation	Precision (for use on farms)
6 - Colorimetric gas detection tubes	NH ₃ , N ₂ O, NO _x , CO ₂	Airflow: 13, 14, 15, 16	<ul style="list-style-type: none"> • Easy to implement • Almost instantaneous results • Can be used for a wide range of concentrations (eg: 5 to 100 ppm for ammonia) • Inexpensive for point measurements • Can be used for a large number of compounds 	<ul style="list-style-type: none"> • Low precision (eg: 10 to 15% for ammonia) • The tubes need to be selected for the concentration levels expected • The target compounds need to be selected <i>a priori</i>, not suitable for high frequency dynamics • Allowance should be made for interference with other gases (for example between acidic and alkaline compounds if the colorimetric reaction is based on pH change) • Expensive when measurements have to be repeated 	Low (identification of major differences)
7 - Laboratory assay of ammonium (NH ₄ ⁺) in solution	NH ₃	Sampling: 1, 2, 3	Continuous flow analyzers (CFA)		
			<ul style="list-style-type: none"> • High speed analyses (40 to 60 samples per hour) • Robust • Good reproducibility 	<ul style="list-style-type: none"> • Allowance should be made for interference with other gases if the samples are very acidic (eg: having been trapped in an acid solution) 	Depends on the concentration of NH ₄ ⁺ in the solution

Method	Target gases	Other methods used in combination	Advantages	Limitation	Precision (for use on farms)
			Conductivity		
			<ul style="list-style-type: none"> • Easy to implement • Low cost • Small samples • Wide measurement range and low limit of detection • Good reproducibility 	<ul style="list-style-type: none"> • Long analysis time (5 to 12 samples per hour) 	Depends on the concentration of NH_4^+ in the solution
			Liquid chromatography		
			<ul style="list-style-type: none"> • Can be used to assay all the major cations at the same time as ammonium • Reproducible 	<ul style="list-style-type: none"> • Long analysis time (4 samples per hour) • Interference with other gases if the sample contains a large number of cations • Expensive 	Depends on the concentration of NH_4^+ in the solution
8 - Gas chromatography	N_2O , CO_2 , CH_4 , NO_x , NH_3	Sampling: 4, 5	<ul style="list-style-type: none"> • Technique is well understood, commercial equipment is available • Cost less than €30,000 • High sensitivity and low limit of detection (of the order of ppm for CO_2 and ppb for NO_x, N_2O, NH_3 and CH_4) • Can be used to quantify several chemical species at the same time • Can be used where there are high concentration fluctuations 	<ul style="list-style-type: none"> • Difficult to use in the field (regular calibration, use of reference gases) • High operating costs • Each instrument has its own limits of detection and performance • Difficult to measure reactive gases such as NH_3 continuously owing to carryover (adsorption in the pipework) 	High

Method	Target gases	Other methods used in combination	Advantages	Limitation	Precision (for use on farms)
9 - Chemi-luminescence	NH ₃ , NO _x , CO ₂	Sampling: 4	<ul style="list-style-type: none"> • High sensitivity of a few ppt for NO and 1 ppb for NH₃ • Fast response time (down to 0.1s) with rapid data acquisition • Particularly suitable for use with eddy covariance methods 	<ul style="list-style-type: none"> • Frequent calibration • Interference may be problematic for low concentrations in rural areas • Price from €15,000 or up to €60,000 for the most accurate instruments 	High
10- Infrared absorption spectroscopy	CO ₂ , CH ₄ , N ₂ O, NH ₃ , NO _x	Sampling: 4, 5	<ul style="list-style-type: none"> • High sensitivity (1 ppb) • Can measure several compounds at the same time • Fast response time and rapid data acquisition • Standard equipment for greenhouse gases • Can be used where there are high concentration fluctuations 	<ul style="list-style-type: none"> • Risk of interference • Sensitive to ambient conditions • Frequent calibration for some analyzers but low annual drift for others • Expensive 	High
11- DOAS - Differential Optical Absorption Spectroscopy	NO _x , NH ₃	Sampling: 4	<ul style="list-style-type: none"> • Very high sensitivity (<1 ppb) • Low limit of detection • Fast response time and rapid data acquisition 	<ul style="list-style-type: none"> • Several tens of thousands of Euros • Only a limited number of chemical species can be detected • Difficult to implement in very dusty environments such as livestock buildings 	Very high

Method	Target gases	Other methods used in combination	Advantages	Limitation	Precision (for use on farms)
12 - Laser absorption spectroscopy	CO ₂ , CH ₄ , N ₂ O, NH ₃ , NO _x	Sampling: 4	<ul style="list-style-type: none"> • Standard method for quantitative evaluation of trace gases • Fast response time (down to 0.1s) with rapid data acquisition • Very high sensitivity (<1 ppb) • High selectivity and low risk of interference • Analyzers are becoming more and more robust and easier for non-specialists to use 	<ul style="list-style-type: none"> • Several tens of thousands of Euros • Not suitable for large fluctuations • Difficult to implement in very dusty environments such as livestock buildings 	Very high

2.3.3 Methods for measuring airflows in livestock buildings or covered manure storage

Table XVI. Summary or advantages and limitations of methods for measuring airflows in livestock buildings or covered manure storage

Method	Direct and/or indirect measurement	Source (general application)	Other methods used in combination	Advantages	Limitations
13 - Direct measurement of airflow using an anemometer	Direct	Livestock buildings	Sampling: 1, 3, 4, 5 Analysis: any method compatible with the samples	<ul style="list-style-type: none"> • High speed measurements • Easy to implement 	<ul style="list-style-type: none"> • Only suitable for enclosed livestock buildings with forced ventilation
14 - Determining the airflow using a tracer gas	Indirect	Livestock buildings, manure storage	Sampling: 4, 5 Analysis: any method compatible with the samples	<ul style="list-style-type: none"> • Suitable for any type of livestock building and for covered manure storage • Integrated systems are available for analyzing the target gases and measuring the tracer gas concentration • Can be used to measure emissions in a particular area of a large building 	<ul style="list-style-type: none"> • Discontinuous measurements, averaged over a period of time, usually about an hour • Environmental impact of certain tracer gases (eg SF₆) to be minimized • Difficult and expensive to implement • Assumes uniform mixing of the tracer gas which requires verification
15 - Determining the airflow by heat balance	Indirect	Livestock buildings	Sampling: 1, 3, 4, 5 Analysis: any method compatible with the samples	<ul style="list-style-type: none"> • Easy to implement • Low cost • Robust for measuring the average airflow over a day or half day • Cross-checking using the airflow estimates by sensible heat, latent heat and total heat balance obtained from the same measurements of temperature and humidity 	<ul style="list-style-type: none"> • Hourly calculations are not very reliable because of the variations in the production of heat by the animals owing in particular to their activity • Poor estimates of certain terms in the heat balance (heat losses through the envelope, thermal inertia of the flow, gas heating, evaporative cooling, heat from the litter) may cause large errors • Not suitable if there is little difference in temperature or humidity between the inside and the outside

Method	Direct and/or indirect measurement	Source (general application)	Other methods used in combination	Advantages	Limitations
<i>16 - Determining the airflow by CO₂ concentration</i>	Indirect	Livestock buildings	Sampling: 1, 3, 4, 5 Analysis: any method compatible with the samples	<ul style="list-style-type: none"> Fairly easy to implement Robust for measuring the average airflow over a day or half day Low cost 	<ul style="list-style-type: none"> Hourly calculations are not very reliable because of the variations in the production of CO₂ by the animals, owing in particular to their activity, and by the litter and manure Not suitable if there is little difference in CO₂ concentration between the inside and the outside

2.3.4 Emission measurement methods (livestock buildings, manure storage, fields, pasture)

Table XVI. Summary of advantages and limitations of emission measurement methods (livestock buildings, manure storage, fields, pasture)

Method	Target gases	Source (general application)	Other methods used in combination	Advantages	Limitations
17 - Partially open enclosures for measuring gases emitted by ruminants	CO ₂ , CH ₄	Animal (ruminant)	Sampling: 4	<ul style="list-style-type: none"> • Good reproducibility • Controlled conditions • Comparison of treatments (eg: feed rations or different breeds) 	<ul style="list-style-type: none"> • Intrusive method that could affect the emission conditions • Difficult to extrapolate to field conditions (not representative) • Cost of equipment and operation • Limited number of animals (variability)
18 - Measurement of gases emitted by ruminants using a tracer gas (SF ₆)	CO ₂ , CH ₄	Animal (ruminant)	Sampling: 4 Analysis: 8, 10, 12	<ul style="list-style-type: none"> • The emissions flux is representative of real conditions (non intrusive method) • Can be used in controlled conditions and normal conditions (in livestock buildings or at pasture) • The samples can be analyzed later 	<ul style="list-style-type: none"> • Skill required for implementation • Expensive • Environmental impact of tracer gas (SF₆)
19 – Greenfeed™ system	CH ₄ , CO ₂	Animal (Ruminant)	Analysis: 10	<ul style="list-style-type: none"> • Commercial system, easy to implement • Mobile and usable in field conditions • Measurements for about twenty animals during one measurement period 	<ul style="list-style-type: none"> • Animals take time to accept the system • Measurements must be made over at least a few weeks for robust results

Method	Target gases	Source (general application)	Other methods used in combination	Advantages	Limitations
20 - Systems for potential emissions in controlled conditions	Any gas depending on the system	Manure samples	Sampling: 3, 4 Analysis: 7, 8, 9, 10, 12	<ul style="list-style-type: none"> • Can be used to study a large number of samples and carry out replicates • Good reproducibility • Can use standardized slurry • Controlled conditions • Comparing treatments • Low cost per sample studied 	<ul style="list-style-type: none"> • Intrusive method modifying the emission conditions • Difficult to extrapolate to field conditions • Equipment available mainly as non-standardized prototypes and currently difficult to make comparisons between the results from different units
21 – Mass balance	Gaseous C and N compounds	Livestock buildings, Manure storage		<ul style="list-style-type: none"> • Fairly easy to implement for any system being studied • The orders of magnitude are reliable provided that they are cross-checked against mass balances for non-volatile elements (P, K) • Global estimate of emissions from the source • Non intrusive method • Low cost 	<ul style="list-style-type: none"> • Does not distinguish between different chemical species • Very high uncertainty for periods less than a week • Very sensitive to the representativeness of the samples of manure and feed • If the mass balance for the manure is estimated using non-volatile elements (eg: P, K), the inputs of these must be known • Also requires a precise knowledge of the animals' ingestion (analysis of the feed, quantities consumed) which is not always available on site

Method	Target gases	Source (general application)	Other methods used in combination	Advantages	Limitations
22 – <i>Simplified method (Concentration ratio and mass balance)</i>	NH ₃ , N ₂ O, CO ₂ , CH ₄	Livestock buildings	Sampling: 4, 5 Analysis: 8, 9, 10, 12	<ul style="list-style-type: none"> • Can be adapted to any type of animal and any time of building, • Easy to implement • The order of magnitude of the results can be cross-checked using water and N balance (Application note 21) • Low cost 	<ul style="list-style-type: none"> • No emissions dynamics for periods less than a week • High uncertainty if the samples are not very representative over the period • Very sensitive to the quality of the mass balance and, therefore, the animal production data and the models used • Needs to be adapted to the site conditions (if the animals are at different physiological stages or if there are different categories of animal in the same building; if animals move in and out of the building where there is access to the outside)

Method	Target gases	Source (general application)	Other methods used in combination	Advantages	Limitations
23 - <i>Static flux chambers</i>	Any gas depending on the system	Litter, Manure storage, Soils	Sampling: 4, 5 Analysis: 7, 8, 9, 10, 12	<ul style="list-style-type: none"> • Easy to implement • High sensitivity (low fluxes) • Comparison of treatments • Spatial distribution of emissions from an emitting surface • Widely used by scientists for soil emissions (following international guidelines) 	<ul style="list-style-type: none"> • Intrusive method modifying the emission conditions (for example effect of air speed on NH₃ emissions from the emitting surface) • Not suitable for monitoring dynamics over short periods; however, automated systems can be used • Spatial extrapolation of measurements requires a sampling strategy using several chambers with spatial and temporal extrapolation models • If used on a porous surface, there is uncertainty on the effect of diffusion of the gases through this surface
24 - <i>Dynamic flux chambers and wind tunnels</i>	Any gas depending on the system	Litter, Manure storage, Soils	Sampling: 4, 5 Analysis: 7, 8, 9, 10, 12	<ul style="list-style-type: none"> • Easy to implement • Comparison of treatments • Can be used to detect very low fluxes and to carry out replicates (assuming that a suitable analyzer is available) • Can be used to control certain environmental parameters • Preferred over static chambers for reactive gases (eg: NH₃) 	<ul style="list-style-type: none"> • Intrusive method modifying the emission conditions • Difficult to extrapolate the results to a field or manure storage unit as this required modeling • The oasis effect can increase or decrease the apparent flux

Method	Target gases	Source (general application)	Other methods used in combination	Advantages	Limitations
25 - ¹⁵ N tracer in the field	Gaseous N compounds	Soils		<ul style="list-style-type: none"> Can be used to quantify the flux from various nitrogen cycle processes in soils 	<ul style="list-style-type: none"> Aggregate approach to measuring emissions of N compounds which does not distinguish between the different chemical species Cannot be used for detailed characterization of the emission dynamics High unit cost and expensive to implement
26 - Integrated horizontal flux	Any gas depending on the system	Livestock buildings, Manure storage, Fields, Pasture	Sampling: 1, 2, 3, 4 Analysis: 7, 8, 9, 10, 11, 12	<ul style="list-style-type: none"> Fairly easy to implement The measured fluxes are representative of real conditions (non intrusive method) Can be used for small areas, especially for comparing treatments Not very expensive 	<ul style="list-style-type: none"> Overestimates emissions Large number of measurement points are required for a reliable estimate Requires a uniform source and air concentration levels that are significantly different from the background concentrations (for example after spreading manure on the surface) The background concentrations must be measured accurately Tending to be replaced by inverse modeling (Application note 30)

Method	Target gases	Source (general application)	Other methods used in combination	Advantages	Limitations
27 - <i>Perimeter profile</i>	Any gas depending on the system	Livestock buildings, Manure storage Fields, Pasture	Sampling: 1, 2, 3, 4 Analysis: 7, 8, 9, 10, 11, 12	<ul style="list-style-type: none"> Fairly easy to implement The measured fluxes are representative of real conditions (non intrusive method) Can be used for small areas, especially for comparing treatments Does not requires the emissions source to be uniform Not very expensive 	<ul style="list-style-type: none"> Large number of measurement points required for reliable estimates The background concentration must be measured accurately Requires air concentration levels that are significantly different from the background concentrations (for example after spreading manure on the surface)
28 – <i>Aerodynamic gradient</i>	Any gas depending on the system	Fields, Pasture	Sampling: 4 Analysis: 8, 9, 10, 11, 12	<ul style="list-style-type: none"> Fairly easy to implement Measures the flux from the surface directly The measured fluxes are representative of real conditions (non intrusive method) Unlike eddy covariance (Application note 31), does not require high speed analyzers Not very expensive 	<ul style="list-style-type: none"> Difficult to position the sensors above the roughness sub-layer while staying within the boundary layer Assumes that the wind is constant and that the surface is horizontally uniform without sources or sinks for the compound being measured (not suitable for mixed or undulating landscapes) Tending to be replaced by the Relaxed Eddy Accumulation (REA) method (Application note 32)

Method	Target gases	Source (general application)	Other methods used in combination	Advantages	Limitations
29 - COTAG - Conditional Time-Averaged Gradient	NH ₃	Fields, Pasture	Sampling: 2 Analysis: 7	<ul style="list-style-type: none"> • Easy to implement low maintenance • The measured fluxes are representative of real conditions (non intrusive method) • Integration of flux measurements over a long period (more than a season or more than a year) with low frequency concentration measurements (typically once a week to once a month) • Low cost, in particular in terms of analyses and maintenance 	<ul style="list-style-type: none"> • Not very precise with low temporal resolution by comparison with other micro-meteorological methods such as the aerodynamic gradient (Application note 28) • Requires a flat, uniform emitting surface with low, almost constant background concentrations • In development
30 - Inverse modeling	Any gas depending on the system	Livestock buildings, Manure storage, Fields, Pasture	Sampling: 1, 2, 3, 4 Analysis: 7, 8, 9, 10, 11, 12	<ul style="list-style-type: none"> • Easy to implement • The measured fluxes are representative of real conditions (non intrusive method) • Unlike eddy covariance (Application note 31), does not require high speed analyzers • Dispersion models are available • Small number of measurement points • Low to moderate cost 	<ul style="list-style-type: none"> • Only suitable for uniform, major emissions sources with low and fairly constant background concentrations. • Not suitable for areas with hedges or scattered trees or with significant changes in surface roughness • Difficult to apply over long periods with changes in wind direction

Method	Target gases	Source (general application)	Other methods used in combination	Advantages	Limitations
31 – Eddy covariance	Any gas depending on the system	Fields, Pasture	Sampling: 4 Analysis: 8, 9, 10, 11, 12	<ul style="list-style-type: none"> Fairly easy to implement The measured fluxes are representative of real conditions (non intrusive method) Measures the flux from the surface directly almost continuously Can be used for large areas (> 1 ha) Standard method for CO₂, water and heat 	<ul style="list-style-type: none"> Requires one or more high speed analyzers Not suitable for measuring NH₃ and NO_x Assumes a uniform emitting surface Measurements often less reliable at night (less atmospheric turbulence) Expensive
32 – Modified eddy covariance (REC, DEC, vDEC)	Any gas depending on the system	Fields, Pasture	Sampling: 4 Analysis: 8, 9, 10, 11, 12	<ul style="list-style-type: none"> The measured fluxes are representative of real conditions (non intrusive method) Measures the flux from the surface directly Can be used for large areas (> 1 ha) Uses analyzers with slower response times than for the eddy covariance method (Application note 31) (with the exception of the vDEC method) 	<ul style="list-style-type: none"> Difficult to implement Samples need to be stored. Assumes a uniform emitting surface No standardized instruments available on the market Not suitable for measuring NH₃ and NO_x Expensive

2.4 Selecting the most appropriate method to meet the requirements

Being able to quantify emissions makes it possible to compare probable emissions from various processes or products, estimate representative emission factors, monitor and check compliance with emission limits, etc. The method used depends on the purpose for which the emission measurements will be used, the operators' qualifications and the financial resources available.

2.4.1 *Measuring emissions for scientific purposes*

Purpose: study and understand emission processes. Most scientific studies on emissions consist in attempting to model the emissions or to find ways to reduce emissions based on a better understanding of the emission processes.

Scientific studies are undertaken to understand various processes at appropriate temporal and spatial scales. As different emission measurement methods have different characteristics, an appropriate method must be selected, depending on the limit of detection, sensitivity, etc. required. Emissions can be measured for scientific purposes on working farms or in controlled conditions. The main constraint on measuring emissions on working farms is to ensure that measurements are reproducible. The description of the measurement method must, therefore, be as complete as possible and be combined with a detailed description of the system studied (characteristics of the animals, the feed, the livestock building, the climate, the weather, the equipment, the farming operations, etc). The main drawback of measuring emissions in controlled conditions is that it is difficult to ensure that the measurements are representative of farming conditions. Measurements must, therefore be taken in field and laboratory conditions and repeated in order to expand our knowledge of emission processes. Measurements taken in scientific studies assume a high level of traceability of the measurement conditions and the system studied, which are generally specific to the study. This is all the more important as the results of these studies are published in the literature and may serve as reference values for drawing up national air pollutant emission inventories, using emission factors as described in the following paragraph.

2.4.2 *Producing emission factors*

Purpose: producing annual air pollutant and greenhouse gas emission factors that can be used to assess actions taken as a result of government policies to reduce atmospheric emissions.

Many countries are committed to reduce air pollutant emissions, in particular agricultural emissions. They need to produce national emission inventories based on source categories for farming activities, technologies and emission factors that are representative of these source categories. In principle, these emission factors should be based on a sufficiently large number of emission measurements to be able to calculate a mean annual value that is representative of the category considered. If the categories are well defined, adding new measurements to a category should not modify either the mean value or the standard deviation.

To set up their national emission inventories, many countries use existing statistics and farming classifications that were drawn up for surveys undertaken for purposes other than the quantification of emissions (eg: determining the number of livestock buildings). Given the

diversity of farms, it is to be expected that the farming classifications currently used will be progressively transformed as more knowledge is gained about emissions. At the moment, emissions are expressed for a particular category of animal (for example, fattening pigs on deep litter) in kg per animal per year, and aggregated at national level. This approach is sometimes unsuitable for taking account of actions to reduce emissions already undertaken for a particular production system. For example, the improvement in the performance of a farm by synergy between different animal production systems is not covered in the existing farming classifications for reducing emissions. These limitations, combined with the small number of measurements taken on farms, introduce high uncertainties in the national inventories.

To reduce these uncertainties, more measurements should be taken in the field and the farming classifications should be reviewed. Given the diversity of animal production conditions, low cost methods should be implemented for an intensive measurement program which will enable more appropriate classifications to be defined. Traceability of conditions and measurement protocols is also important.

2.4.3 Systematic improvement of the production process

Purpose: using quantitative indicators for the systematic improvement of production systems to reduce emissions.

One of the major challenges for animal production in recent years is to increase production levels without increasing the environmental impact (including emissions). More effort should, therefore, be made to develop techniques that reduce pollutant emissions without transferring the emissions outside the system boundary. This could be done by adding an indicator for emissions in addition to those already well understood by farmers (eg: manure management, animal feed and health, ambient conditions). This new indicator could be validated by appropriate measurements. The measurement methods should be low cost, simple and quick to implement. Low cost, simple methods are essential so that most farming technicians and consultants, whose job it is to improve farming techniques, may use such methods for repeated measurements. Speed is important so that the effect of changes made to a production process can be evaluated rapidly. Research still needs to be carried out to improve existing methods to reduce costs and improve speed while being sufficiently precise to provide aid for decision-making. Additionally, an emissions guide, based on these measurement methods and characterizing the types of farm and existing emission reduction methods, could be drawn up to make it easier to analyze the results.

2.4.4 Verifying the performance of a process or equipment before putting it into use

Purpose: verifying and/or certifying the performance of emission reduction technologies before they are put into use.

There are two main criteria for assessing the performance of an emissions reduction technology: (i) the extent to which emissions are reduced must be determined as accurately as possible, including the variability over time and (ii) the observed reduction in emissions must be determined for all animal production categories for which the technology will be used. The measurement methods that best meet these criteria are techniques which:

- can be applied continuously over one or more periods including fluctuations due to the changes in the weather, the animals and the farming activities.

- have an uncertainty less than the expected reduction in emissions.
- can be implemented at a range of different sites that are representative of the animal production categories concerned.

Ideally, the reduction in emissions from implementing a technology should be evaluated in all parts of the farm affected to assess the risk of transfer of emissions (eg: from the livestock building to the manure storage unit or to other pollutants).

France is now taking part in the European Environmental Technology Verification (ETV) program (<http://www.verification-etv.fr/> accessed on January 5, 2015). This enables a company to have the performance of a new environmental technology verified, particularly if it can reduce emissions into the atmosphere. Processes that can be used in animal production have already been evaluated under this scheme by Danish companies (http://www.etv-denmark.com/agriculture/emissions_from_livestock_houses.html). In France, verification is undertaken by the Laboratoire National de Métrologie et d'Essais (LNE) which is able to call on qualified organizations to carry out the tests required.

2.4.5 Verifying compliance with regulations or voluntary commitment

Purpose: verifying and/or certifying the reduction in emissions from a specific farm.

There are three main criteria for routine checking that measures taken by a farm to reduce emissions have been successful: (i) the cost must be sufficiently low for routine measurements, (ii) the emissions must be measured specifically for that particular farm, not for a farm in the same category, (iii) the uncertainty for the emission measurement must be less than the target reduction. The uncertainty must be quantified to ensure that the emissions are within specified limits.

The measurement methods that can best meet these criteria are techniques that:

- are low cost and can be implemented rapidly (eg: within a day)
- can be used for any category of animal production
- have an uncertainty less than the expected reduction in emissions
- if necessary, use equipment that can be easily disinfected (eg: for intensive indoor animal production)

Under Directive 2010/75/EU on Industrial Emissions (IED), the Best available techniques Reference Document (BREF) for Intensive Rearing of Poultry and Pigs (see <http://eippcb.jrc.ec.europa.eu/reference/irpp.html> accessed on November 6, 2015) defines the Best Available Techniques (BAT) for reducing emissions from pig and poultry production installations covered by the directive. In the revised version, the BREF will probably include limits on ammonia (NH₃) emissions and measurement methods to check these emissions. The methods proposed are mass balance for any animal production installations and any source of emissions (Application note 21), direct measurement using a standardized protocol for buildings with forced ventilation (Application note 13) or indirect measurement based on concentrations for buildings with natural ventilation (Application note 14, Application note 15, Application note 16 and Application note 22).

2.5 Evaluating the uncertainty for measuring emissions from animal production

2.5.1 Definitions

Before going into the details of the evaluation of uncertainties, the basic concepts are set out in this chapter. It starts by giving a few terms defined in the International Vocabulary of Metrology - Basic and general concepts and associated terms (VIM) (JCGM, 2012).

First of all, it is important to distinguish between the measurand, the quantity intended to be measured, and the measurement, the set of operations used to determine a value for this measurand. This is the first distinction to be made before considering the notion of measurement uncertainties. The measurement requires a complete definition of the measurand, the method and the measurement process.

There is often confusion between the measurement error and the measurement uncertainty.

The measurement error is the difference between the measured quantity value and the true quantity value. It is expressed in absolute and/or relative (percentage) terms: as the true quantity value cannot be determined exactly, it is, therefore, not possible to know the measurement error precisely. The error has two components, the random component and the systematic component (Figure VI).

A random error results from unpredictable temporal and spatial variations in the measurand and from the effect of other possible sources of error in the measurement process caused by the measurement instrument, the method, the operator or the surroundings. The inherent effects of such random variations generate variations in the measurement results (even if

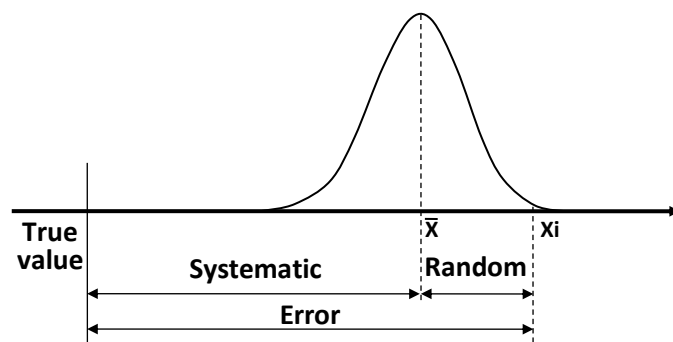

Figure VI. Measurement error

measurements are taken in conditions that are as constant as possible). The random error component can be minimized by taking replicate measurements (X_i) and taking the mean (\bar{X}). However, this approach is only valid for inert systems. For living systems (*i.e.* animal production), taking repeated measurements may increase the random error (increase in variability factors such the age, climatic conditions, animal production conditions, etc).

A systematic error remains constant or varies in a predictable manner and affects each of the measurements for a given measurand. There are many sources of systematic error such as the measurement bias in the instruments (calibration, zero offset) or intrusion by the measurement sensors. To detect and evaluate these systematic errors, the same quantities can be measured using different instruments or different methods, by measuring a calibration standard (to check the measurement trueness) or by measuring the same measurand in different laboratories. The systematic error cannot be reduced by increasing the number of measurements: a correction must be applied and a rigorous, validated experimental protocol must be used.

Systematic and random errors contribute to the measurement uncertainty.

The measurement uncertainty reflects the impossibility of knowing the value of the measurand precisely and is associated with a notion of probability. According to the VIM, it is a parameter characterizing the dispersion of the quantity values being attributed to a measurand based on the information used. It is characterized either as the standard deviation and is then termed standard measurement uncertainty or as an interval containing most of the measurement results, termed the expanded measurement uncertainty. According to the Evaluation of measurement data - Guide to the expression of uncertainty in measurement (GUM, JCGM, 2008a) many factors / effects contribute to the uncertainty of measurements, such as:

- incomplete definition of the measurand (definitional uncertainty)
- unrepresentative sampling
- inadequate knowledge of environmental conditions
- personal bias in reading analog instruments
- finite instrument resolution
- inexact values of measurement standards and reference materials
- approximations and assumptions incorporated in the measurement method and procedure
- inexact values of constants and other parameters obtained from external sources and used in the data-reduction algorithm
- drift, incorrect calibration, precision of the instruments, sensitivity of the instruments to environmental conditions

The GUM defines two types of evaluation, type A and type B which are used depending on the information available on the quantity to be measured. For type A evaluation, the standard uncertainty (uncertainty expressed as the standard deviation) is determined statistically from a series of observations. It assumes that all the quantities on which the measurement result depends have been varied for the observations. In certain circumstances, it is impossible to take one or more series of measurements, and in this case an analytical method is used (type B evaluation) which consists in estimating the standard uncertainty from information, tests, expert opinion, calibration certificates, manufacturers' documentation on the instruments, etc. It entails analyzing the measurement process and identifying all the information that may help to understand and explain the measurement variability. In most cases, the two uncertainty evaluation methods need to be combined.

In many cases, the measurand is not measured directly and depends on the determination of several input quantities (quantities that must be measured or quantities whose value can be obtained by other means to calculate the value of the measurand). The standard uncertainty for the value of the measurand is then obtained from the standard uncertainties of the measurements of the input quantities. This is termed the combined standard uncertainty.

2.5.2 Evaluating the measurement uncertainty according to the GUM

To evaluate the uncertainties for emissions, it is preferable to refer to the Guide to the Expression of Uncertainty in Measurement (GUM, JCGM, 2008a). This guide describes how to evaluate the combined standard uncertainty of a measurement result. Ideally, an evaluation procedure should be drawn up for each measurement process, which can then be repeated for subsequent measurements.

The GUM defines the following steps for drawing up a evaluation procedure.

- define the measurand,
- model the measurand, i.e. express the relationship between the measurand and the input quantities mathematically,
- evaluate the standard uncertainty for each quantity: type A evaluation (statistical) or type B evaluation (probabilistic) may be used, depending on the quantities,
- determine the combined standard uncertainty for the measurement by applying a formula for the propagation of uncertainty taking account of covariance between the best estimates of pairs of input quantities,
- calculate the result of the measurement from the mathematical model of the measurand and best estimates of the input quantities,
- determine the value of the coverage factor which depends on the assumed probability density function for the measurand,
- give the expanded uncertainty for the measurement with its characteristics (units, measurement method and measurement conditions).

The GUM approach can be summarized in 4 distinct steps (Figure VII). An uncertainty evaluation using the GUM approach is based on a combination of expertise in the measurement process studied and a basic knowledge of statistics.

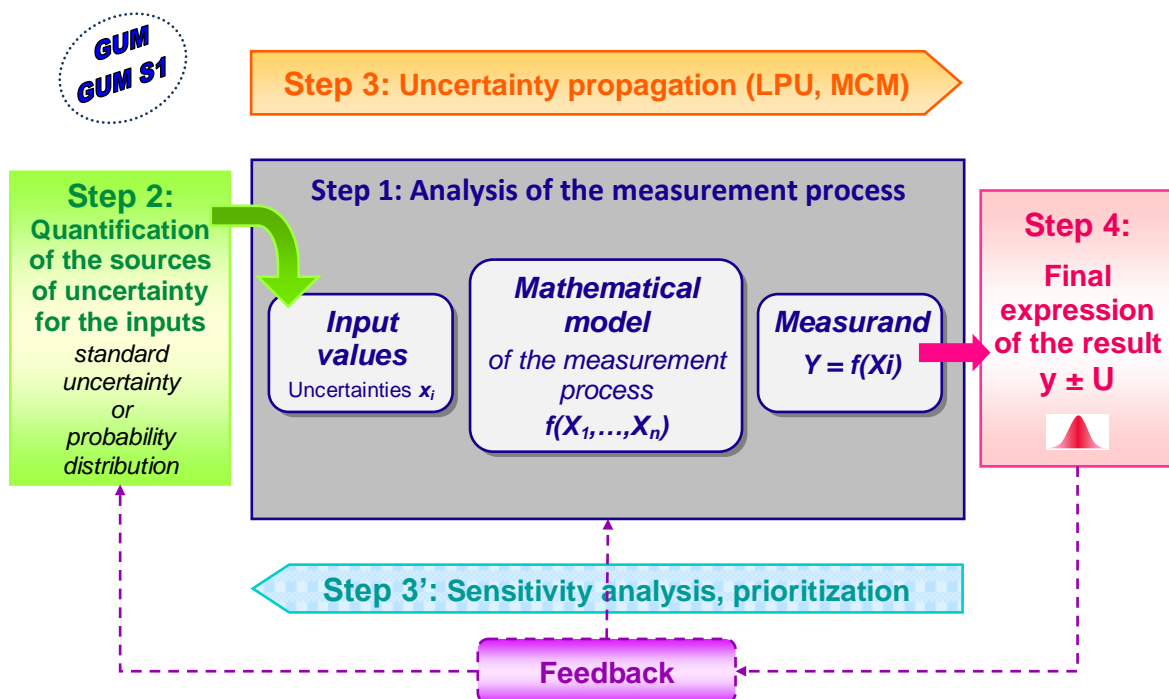

Figure VII. Uncertainty evaluation process

Defining the measurand

Defining the measurand is an essential step in the uncertainty evaluation process. The more detailed the definition in the measurand, the smaller the definitional uncertainty. However the definitional uncertainty will never be zero given its nature but it may be negligible with respect to the other contributions to the uncertainty if the measurand is defined sufficiently precisely. Furthermore, any modification of the description generates another definitional uncertainty. For measurements taken for animal production systems, the variability of these systems

makes it impossible to define the measurand with any great precision for generic measurement protocols. In this case, the definitional uncertainty cannot be ignored and must be evaluated case by case.

Analyzing the measurement process

To evaluate the measurement uncertainty, it is necessary to start by defining the measurand precisely, for example, the weight of the animals. Then the measurement process used must be described and analyzed to identify all possible causes of uncertainty and the quantities affecting the measurand. This analysis can be undertaken using the 5M method or Ishikawa or cause-and-effect diagram. The 5M method asks 5 questions: what are the factors related to the method, manpower, means, milieu and materials involved with the process which affect the measurement result (Eduscol, 2012).

Table XVIII gives some examples of possible responses to each question.

Table XVIII. Examples of content for the various parts of the Ishikawa diagram

Method	Number of measurements Duration of measurements Method selected Standard selected Equipment selected Number of operators Corrections Interpolation between two measurement dates etc
Manpower (operators)	Measurement effort Experience Training Parallax Interpolation between divisions Eyesight etc
Means (machines)	Trueness Precision Geometry Response time Resolution Calibration uncertainty Influence quantities: for example, Temperature (effect on electronic components) Corrections etc
Milieu (environment)	Temperature (ambient at the measurement site) Humidity Pressure Vibration Dust Magnetic fields Radiation etc

Materials (milieu/object on which measurements are made)	Temperature of the material on which the measurements are made Surface condition Deformability Position Geometry Appearance Magnetic fields etc
---	--

The sources of uncertainty should be identified as comprehensively as possible. The measurand Y is determined from the input quantities X_i by a functional relationship f (JCGM, 2008b):

$$Y = f(X_1, X_2, \dots, X_N) \text{ (eq. I)}$$

This functional relationship determines the rest of the measurement uncertainty evaluation process. It should, therefore, be formulated with the greatest of care and include all the input quantities identified either individually or combined into a single variable.

Quantifying sources of uncertainty

When all the sources of uncertainty have been listed, each source should be quantified. The standard uncertainty, $u(x_i)$, must be calculated for the estimate x_i of each quantity X_i . This characterizes the expected dispersion of the quantities as a standard deviation.

The GUM distinguishes two methods for evaluating the standard uncertainty depending on the information available for the quantity considered. A type A evaluation is used if repeated observations of the quantity are available and the standard uncertainty is estimated as the experimental standard deviation of the observed values. A type B evaluation is used if the standard uncertainty for a quantity is evaluated by scientific judgment based on expert opinion, calibration certificates, manufacturer's specifications, previous measurement data or anything other than a series of observations. In practice, this means, for each quantity concerned, defining the probability distribution that best represents the information available. The standard deviation of this distribution is then the standard uncertainty.

Both methods are based on associating each quantity with an independent random distribution which represents the uncertainty about that quantity.

In some cases, the random distributions of the input quantities are not independent. For example, two different temperatures measured using the same instrument would potentially be associated with the same instrumental bias. This creates covariance between the two quantities which must be taken into account in the uncertainty budget. The covariance must, therefore, be estimated. The estimated covariance associated with x_i and x_j is expressed as $u(x_i, x_j)$. It can be calculated from the standard uncertainties of these quantities and their linear correlation coefficient, $r(x_i, x_j)$. This is between -1 and 1 and represents the strength of the linear correlation between x_i and x_j :

$$u(x_i, x_j) = r(x_i, x_j) \times u(x_i) \times u(x_j) \text{ (eq. II)}$$

Expanding the uncertainty

When the standard uncertainties of the input quantities and any covariance have been determined, the combined uncertainty $u(y)$ of the measurand is calculated based on the GUM “law of the propagation of uncertainty”:

$$u^2(y) = \sum_{i=1}^n \left(\frac{\partial y}{\partial x_i}\right)^2 u^2(x_i) + 2 \sum_{i=1}^{n-1} \sum_{j=i+1}^n \left[\left(\frac{\partial y}{\partial x_i}\right)\left(\frac{\partial y}{\partial x_j}\right) u(x_i; x_j)\right] \quad (\text{eq. III})$$

This formula is used to estimate the propagation of variance in practice. The variance terms (square of the standard uncertainty) and covariance terms are summed to obtain the variance associated with the measurand. This formula for the propagation of uncertainty is no more than a first-order Taylor series expansion valid for values close to the nominal. It requires the first order derivatives of the measurement model to be determined before it can be applied.

Final expression of the measurement result

In the final step, the measurement result is expressed together with its expanded uncertainty, U , in the form of an interval: $Y \pm U$

The GUM defines the expanded uncertainty as the interval that encompasses a large fraction of the distribution of values that could reasonably be attributed to the measurand. The half-width U of this interval is obtained by multiplying the combined standard uncertainty of the measurand $u(y)$ by a coverage factor k .

k is not necessarily an integer.

$$U = k \times u(y) \quad (\text{eq. IV})$$

In practice, to give more meaning to this expanded uncertainty, the coverage factor k is selected to obtain an interval U for the level of confidence required. The usual level of confidence selected is 95% which requires a coverage factor of 2. The implicit assumption is then made that the distribution of probabilities for the measurand is approximately Gaussian.

The coverage factor is 1.96 for a 95% level of confidence for a Gaussian distribution. Other values can be selected for k depending on the level of confidence required and the closeness to a Gaussian distribution.

When the expanded uncertainty has been estimated, the measurement result and its uncertainty should be rounded to retain only a small number of significant figures. It is rarely useful to keep more than two significant figures for the uncertainty. As the uncertainty is itself associated with uncertainty (model approximations, quantification selected, incomplete knowledge of the variability of the input quantities, etc), the trailing digits are certainly not significant.

However, it is advisable not to round the values before the final uncertainty of the measurand has been calculated to avoid propagating truncation errors, which in certain situations may be significant.

Although this approach is presented here as linear, it must be applied iteratively. When the first estimate of the uncertainty of the measurand has been calculated, a sensitivity analysis of the model should be carried out to identify which input quantities make the greatest contribution to the variability of the measurand. Knowledge of the measurement process may

thus be improved and lead to the revision of certain choices and assumptions made about the model itself or the quantification of certain sources of uncertainty.

Although the method for evaluating the measurement uncertainty described in the GUM appears to be robust, it is, however, based on several assumptions, the validity of which needs to be verified. The formula for the propagation of uncertainty is obtained by linear approximation of the mathematical model around the point considered. If this approximation is not valid (high non linearity, high variability around the measurement point), the formula is no longer valid. Second-order terms (or higher) must then be added.

An alternative in this case is to follow the recommendations in Supplement 1 to the GUM (JCGM, 2008b). This defines the scope of application of the GUM and, if the assumptions are not valid, suggests using a Monte Carlo method to evaluate the measurement uncertainty by propagating the probability distributions of the quantities. This uses numerical simulation and, rather than propagating the variances, propagates the probability distributions through the measurement model (Figure VIII).

Steps 1 and 2 above remain generally unchanged and still require skills in the measurement process and the calculation of probabilities but in this case the distribution of the values of the measurand is obtained using Monte Carlo simulation software. This distribution is then used to calculate the mean, \tilde{y} , the standard deviation, $u(\tilde{y})$ and the interval for the level of confidence required $[y_{low}; y_{high}]$. The 4-step global iterative approach given in Figure VII remains unchanged. Only the mathematical processes within these steps differ.

Propagation of uncertainty (GUM)

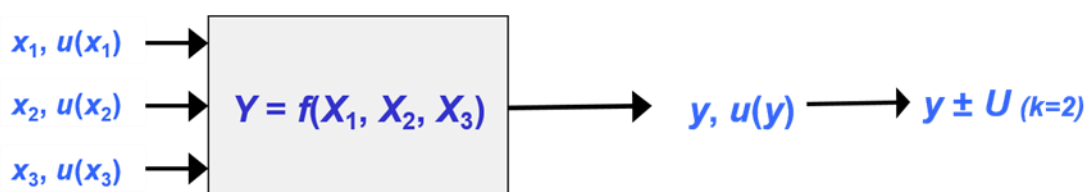

Propagation of distributions (GUM-S1)

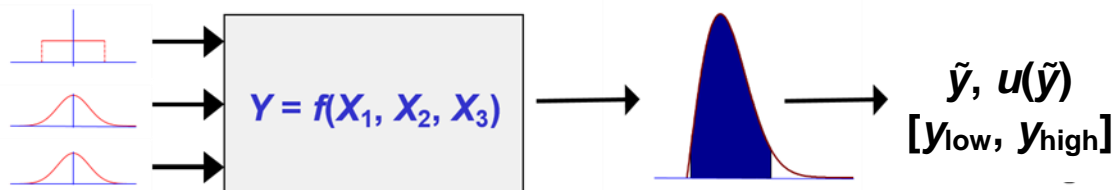

Figure VIII. Comparison between GUM and GUM S1

2.5.3 Need to evaluate the uncertainty for emission measurements

According to the GUM, “When reporting the result of a measurement of a physical quantity, it is obligatory that some quantitative indication of the quality of the result be given so that

those who use it can assess its reliability. Without such an indication, measurement results cannot be compared, either among themselves or with reference values given in a specification or standard...”.

Emission measurements are currently used to evaluate the effectiveness of emission reduction technologies, to determine emission factors, gain a better understanding of the processes, identify systems with low emissions, etc. Measurements can only be compared if the uncertainty associated with each measurement is known. Knowing the measurement uncertainty makes it possible to take account, for a precisely defined measurand, of the variability that could be attributed to the measurement method and environmental conditions, the operators and the parameters that have a major effect on the measurement results.

For the certification of emission reduction techniques, the uncertainty of the emission measurement must be sufficiently low to be sure that the emissions have effectively been reduced. The uncertainty analysis must lead to minimizing this uncertainty, identifying and limiting so far as possible the systematic errors for the measurement methods used if these are to be considered correct and used for the harmonization of the methods and procedures at international level.

2.5.4 Uncertainty of emissions from animal production

Depending on the purpose, emission measurements can be taken at various scales and in reasonably controlled environments (ranging from a laboratory to an intensive livestock production building). The larger the scale, the less the environmental conditions and measurement procedure are controlled and the more difficult it is to evaluate the measurement uncertainty. Data on emissions associated with uncertainty can now be found in the literature (see for example the SENTOREF study in this chapter) in particular for laboratory measurements taken on manure. Information can also be found on concentration analysis methods (Phillips *et al.*, 2001) with details of the measurement ranges and the associated uncertainties. However, these publications do not give the measurement uncertainties when implementing sampling and analysis techniques in real conditions. The precision of sampling and concentration analysis methods depends on the operating conditions and in some cases on climatic conditions.

Moreover, emission concentrations are determined by indirect measurement and, depending on the method used, on data about the animals, physical and chemical measurements taken on biological systems that do not remain constant. Consequently, the uncertainty is a combined standard uncertainty which can be evaluated using the above formula for the propagation of uncertainty. For measurements taken on farms (with animals), the measurements are taken in a non-constant environment where conditions change rapidly and affect not only the quantities being measured but also cause drift in the sensors. Depending on the measurement method selected, a large number of input quantities may need to be taken into account and, for each one, it will be necessary to identify the sources of error (Ishikawa diagram) and evaluate their contribution to the uncertainty of this quantity.

The following diagram (Figure IX) gives an example of an Ishikawa diagram for measuring the concentration of a gas in the ambient air in a livestock building. Analyzing this diagram shows the number of components to be evaluated and the problems encountered in finalizing these evaluations. When it is very difficult, or even impossible, to determine the uncertainty

associated with a cause of error, technical solutions must be used to minimize these sources or error (for example, for a measurement instrument, use the instrument in conditions as close as possible to those in which it was calibrated or change the filters regularly to ensure that the filtration quality remains constant, etc).

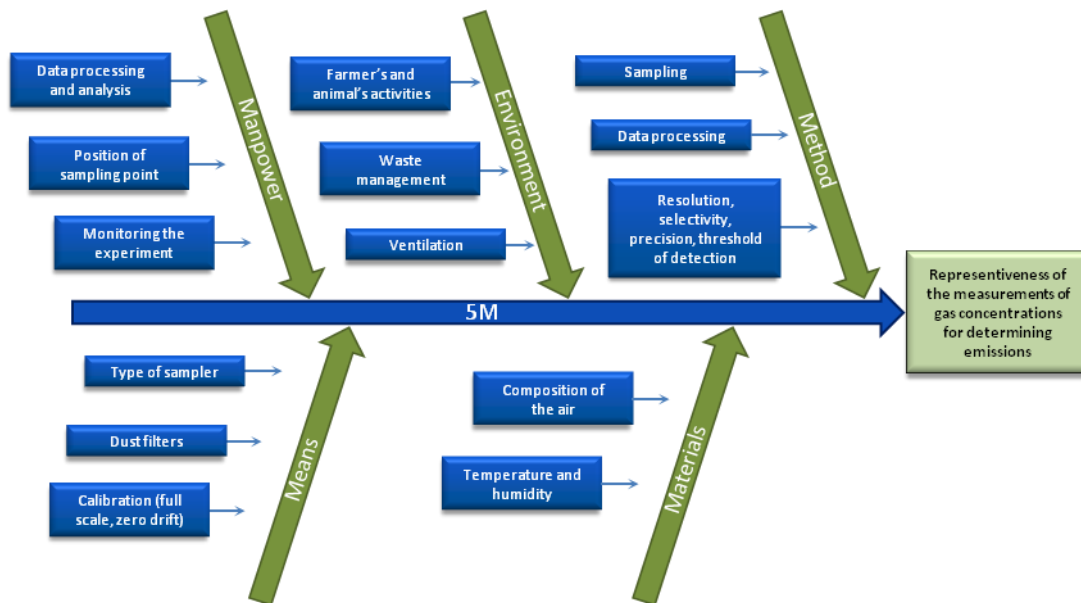

Figure IX. Application of an Ishikawa diagram for measuring gas concentrations in ambient air in a livestock building

Finally, in real conditions and in certain situations, part of the uncertainty will be difficult to quantify. This is the definitional uncertainty which is due partly to the fact that the measurand may vary depending on farming practices and spurious modifications (of which the operator is unaware) to the system being studied.

2.5.5 Case study of the measurement uncertainty for effectiveness of deodorization products

Purpose of the test

The SENTOREF project developed a test to determine the effectiveness of commercial deodorization products. The product under test was diluted in accordance with the manufacturer's instructions using demineralized water. The mixture was agitated to form a homogenous solution. The solution was applied by atomizing in NH_3 loaded air in a chamber. The test was carried out in an air-conditioned room but the temperatures of the solution and the test gas were not defined. The NH_3 concentration in the test gas mixture ($\text{NH}_3 + \text{air}$) was measured dynamically before passing into the test chamber and after 30 minutes of sequential atomization (cycles of 10 s misting followed by a 20 s pause).

The NH_3 was generated by permeation (diffusion at a constant rate across a membrane kept at a given temperature in an oven). The input concentration of the NH_3 was 24000 ppbv, and the output concentration (depending on the treatment) was as low as 1000 ppbv.

The effectiveness of misting using the product is the relative change in the concentration calculated on the basis of the mean of 3 measurements.

Measurand

The measurand is the effectiveness (*Eff*) of a commercial odor reduction product measured by misting in a test gas in defined operating conditions (fixed nozzle, liquid flow rate $Q_L = 2.75 \pm 0.25 \text{ l.h}^{-1}$, compressed airflow in the nozzle $Q_{\text{air-nozzle}} = 1300 \text{ l.h}^{-1}$, airflow used to generate the test gas $Q_{\text{air}} = 5 \text{ l.min}^{-1}$, duration of misting = 30 minutes). This is expressed by the relative change in the NH_3 concentration in the test gas measured 3 times and averaged. The measurand is, therefore:

$$Eff = \frac{C_{i,\text{NH}_3} - C_{o,\text{NH}_3}}{C_{i,\text{NH}_3}} \text{ (eq. V)}$$

where

C_{i,NH_3} is the concentration before misting (ppb) and

C_{o,NH_3} is the concentration after misting (ppb).

Analyzing the sources of error and uncertainty

This analysis is summarized in Figure X. As the most of the test parameters were well defined, the main uncertainty factor was the instrument used for measuring the concentrations.

However, the fluid flow in the chamber may cause significant dispersion between the 3 measurements. To take account of any dispersion between the 3 measurements, a global term for this dispersion (H_{Eff}) was added to the measurement model:

$$Eff = 1 - \frac{C_{o,\text{NH}_3}}{C_{i,\text{NH}_3}} + H_{Eff} \text{ (eq. VI)}$$

Quantifying the sources of uncertainty

Input concentration (before misting)

The concentration was measured by Cavity Ring Down Spectroscopy (CRDS). It was about 26,000 ppb. The measurement instrument was selected for its high accuracy.

The trueness of the ratio between the input and output concentrations ($C_{o,\text{NH}_3}/C_{i,\text{NH}_3}$) was negligible (it was assumed that the relative values of these errors were very close).

The precision error was estimated by continuous measurement for 4,000 seconds of a concentration close to the input concentration of 26,000 ppb. The maximum variation in the measurements was about $\pm 1.6\%$, i.e. a standard deviation of 0.9% assuming a uniform probability distribution. The resolution of the CRDS was 1 ppb and, being much lower, was ignored.

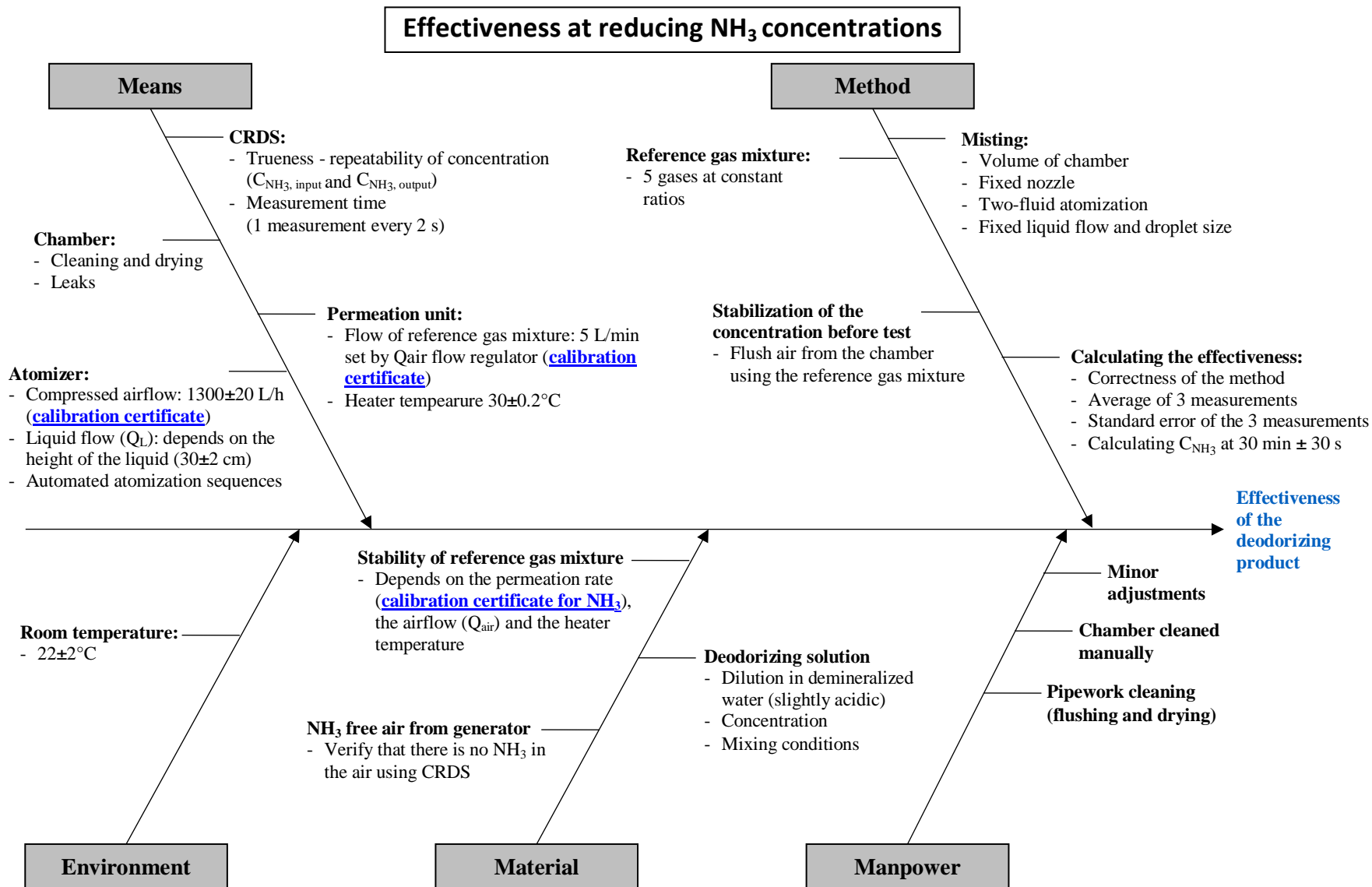

Figure X. 5M diagram (Ishikawa) for the measurement of the effectiveness in reducing NH₃ emissions

Output concentration (after misting)

The output concentration was also measured using CRDS as for the input concentration. The output concentration was between 260 ppb (effectiveness 99%) and 5,200 ppb (effectiveness 80%), with a precision of 1.6%.

Uncertainty in the concentration ratio

The uncertainty for the input and output concentrations is propagated to the concentration ratio. If the output quantity is obtained from the input quantity ratio, the uncertainties are propagated in relative value.

As the measurements for the 2 concentrations are independent, the relative standard deviation for the concentration ratio R is :

$$\frac{u(R)}{R} = \sqrt{\frac{u^2(Ce)}{Ce^2} + \frac{u^2(Cs)}{Cs^2}} = \sqrt{2} * \frac{u(C)}{C} = \sqrt{2}_{precision} = 1.3 \% \quad (\text{eq. VII})$$

Using a standard coverage factor $k=2$, the expanded uncertainty for the measurement is 2.6%.

Repeatability of the effectiveness measurement

The repeatability is estimated using the standard deviation for the experiment, s_{exp} , calculated from the 3 measurements. However, this standard deviation s_{exp} already includes the precision of the measurement.

To avoid including the precision twice, s_{exp} is expressed as a relative value and compared with the standard deviation for the precision $s_{precision}$:

- Case 1: $s_{exp} > s_{precision}$, only s_{exp} is considered
- Case 2: $s_{exp} < s_{precision}$, only $s_{precision}$ is considered

The uncertainty for the final result is expressed as the standard deviation used divided by $\sqrt{3}$, as the result is the mean of 3 measurements. Using the normal coverage factor $k=2$, the expanded uncertainty for the final result is multiplied by 2.

Table XIX. Uncertainty calculation for SENTOREF

	Ci, NH₃	Co, NH₃	Co / Ci	Effectiveness (Eff)	
Mean value of 3 measurements	26000 ppb	230 ppb	0.00885	99.1%	
Relative uncertainty	0.90%	0.90%	1.3%	1.3%	S_{precision} = 1.3%
Standard deviation s_{exp} (for 3 measurements)				1.40%	Case 1: S_{exp} > S_{precision}
Mean standard deviation				0.808%	
Expanded uncertainty (k=2)				1.61%	

The final result is expressed as: $Eff = 99.1 \pm 1.6\%$

2.5.6 Bibliography

- Eduscol. 2012. Mesure et incertitudes (Measurement and uncertainty). Ministry of National Education, Youth and Associations) 38 p. Download from http://www.udppc.asso.fr/national/attachments/article/537/ressources_MathPC_Mesure_et_incertainces_eduscol_214070.pdf accessed on November 15, 2015
- JCGM. 2012. International vocabulary of metrology – Basic and general concepts and associated terms (VIM) - 3rd Edition. Vol.200 JCGM 108 p. Download from <http://www.bipm.org/en/publications/guides/vim.html> accessed on November 15, 2015
- JCGM. 2008a. Evaluation of measurement data – Guide to uncertainty in measurement. Vol.100 JCGM 132 p. Download from <http://www.bipm.org/en/publications/guides/gum.html> accessed on November 15, 2015
- JCGM. 2008b. Evaluation of measurement data — Supplement 1 to the “Guide to the expression of uncertainty in measurement” — Propagation of distributions using a Monte Carlo method. Vol.101 JCGM 90 p. Download from <http://www.bipm.org/en/publications/guides/gum.html> accessed on November 15, 2015
- Phillips, V.R., Lee, D.S., Scholtens, R., Garland, J.A., Sneath, R.W. 2001. A review of methods for measuring emission rates of ammonia from livestock buildings and slurry or manure stores, Part 2: Monitoring flux rates, concentrations and airflow rates. *Journal of Agricultural Engineering Research*. 78 (1), 1-14 10.1006/jaer.2000.0618

3 Conclusions and outlook

Improving air quality and reducing greenhouse gas emissions are environmental concerns that are becoming of increasing importance for governments and professionals in the sectors concerned. Livestock farming plays a major contribution to air pollutant emissions, amounting to over 70% of national ammonia (NH₃) emissions and 75% of methane (CH₄) emissions. There are already various national regulations and international agreements to reduce these emissions to improve air quality and protect the environment and there may be further restrictions on agriculture in the near future¹⁷. For certain gases, such as ammonia, a reduction in emissions can also be associated with an improvement in the effectiveness of inputs used in the production process (eg: protein supplements) and better use of manure produced from the activity (eg: organic fertilizers) and/or reduction in odors (eg: incorporation of manure, covering slurry pits, air purification).

Methods for measuring these emissions for practical purposes, rather than research, are currently being developed. Very little data on emissions is available that could be used to characterize the diversity of livestock farms (eg: type of production, type of livestock buildings, practices, soil and climatic conditions) and take account of emissions in national evaluations (eg: emissions inventories). This lack of data means on the one hand that emissions have little influence on decisions made by farmers and on the other hand that the effects of changes in production systems are not reflected in the inventories. This may be explained by the lack of attention hitherto paid to emissions, by the diversity of livestock farms in France and by the diffuse nature of emissions from the agricultural sector. On a farm, all sources of emissions from livestock buildings as well as from spreading or storing manure must be measured, particularly as a reduction in the emissions from one source may increase emissions from another source (eg: nitrogen in the form of volatile ammonia transferred from a livestock building to manure storage or spreading). There is now a wide range of measurement methods associated with the various sources. Most of these are experimental, difficult to use routinely, and their applicability and reliability need to be tested before they can be used on commercial farms. Moreover, the lack of standardized protocols makes it difficult for these methods to be used in the agricultural sector.

It should, however, be noted that:

- Methods are available for measuring each source of emission depending on the purpose (eg: direct measurement of emissions, comparison of practices or organic products, characterization of the effectiveness of a process), as is clear from the number of methods and case studies presented in this review. Laboratory methods can be used to compare different types of manure or fertilizer but they are unsuitable for working farms, although efforts are being made to make them suitable for use in the field. Some of the methods that can be used for pilot or production systems are relatively simple to implement and can measure orders of magnitude of gaseous flows (eg: mass, heat or CO₂ balance for a livestock building associated with

¹⁷ The BREF IRPP document that defines the Best Available Techniques (BAT) to be applied under the IED Directive is being revised and the emission limit values (ELV) and measurement methods could be associated with each BAT. The emission thresholds set by member states under the IED Directive are being revised. The European Commission is considering reducing the target for ammonia emissions by 2030 as well as including a limit for methane.

concentration measurements) but others require more instrumentation, longer measurement times and more experience but generally produce results that are more precise with a finer temporal resolution, provided that the method is suitable for the purpose.

- The various emission measurement methods are associated with concentration analysis technologies that are continually being improved (eg: response time, gas analysis selectivity, measurement of several gases in parallel) and the cost of this equipment is dropping (eg: laser spectrometry).
- Simplified emission measurement methods have been or are being developed, in particular for pig and poultry buildings (Application note 22), manure storage and in the field (Application notes 29 and 30). These methods are designed to enable farmers to use the equipment while ensuring that the uncertainty is sufficiently low to discriminate between different production systems and different practices. For example, the uncertainty of the methods developed for livestock buildings by INRA and the technical institutes is less than 30% for greenhouse gas, H₂O and NH₃ emissions. This uncertainty still needs to be evaluated in greater detail and minimized.

The development of measurement methods and its coordination have now begun and will continue, in particular in response to changes in regulations. Several actions have been set up and should be supported.

- Comparison of methods and protocols. In particular, better evaluation of uncertainties will improve the comparison of emission measurements from a given source and between different sources.
- The definition and application of standard protocols that have been generally approved and can be adapted for different conditions (eg: types of livestock production, buildings, storage facilities) and for various measurement requirements (regulatory, technical or scientific). In the long term, some of these protocols could be incorporated into standards. Working groups in the Global Research Alliance (<http://globalresearchalliance.org/>) have already initiated this step by producing guidelines for N₂O static chambers and for use of sulphur hexafluoride (SF₆) tracer technique to measure enteric methane emissions from ruminants. It is also important that the literature and databases used as sources of emissions data should provide more information on the protocols and measurement conditions to improve the interpretation of the results and, in particular, their conversion into emission factors. If a standard protocol has been used, this should be stated with the data.
- Measurement networks should be set up using reference farms with standard protocols and interlaboratory calibration of measurement instruments. Existing experimental networks could also be required to take standard measurements (concentration, mass balance, temperature, humidity) systematically for calculating emissions.

The RMT Elevage et Environnement (In France) and GRA (at international level) are a driving force for emission measurements in the agricultural sector.

Action by the RMT Elevage et Environnement

In France, the RMT Elevage et Environnement (RMT - Joint Technology Network, Livestock production and Environment) is a center for discussion and partnership between scientists, engineers and technicians on the measurement of gaseous emissions. It plays a role in several initiatives aimed at achieving better coordination of gaseous emissions measurement and the transfer of technology to the farming industry:

- It has set up the ANGAEL (Analysis of gaseous emissions from livestock production) network of developers and users of measurement methods, providing a channel for discussions on the various methods used by members of the network and outside partners. This review is one of the deliverables of this network. It aims to achieve a consensus on the protocols with a view to standardization and to transfer the methods developed in France to an international level.
- In 2013 INRA set up an interlaboratory calibration bench for infrared gas analyzers. An experimental platform for measuring gas and energy exchanges between livestock and the environment (MEGEVE) will soon become operational.
- Protocols have already been produced for methods for measuring gaseous emissions from livestock buildings and manure storage systems (Ademe, 2011). They can be downloaded from https://www6.inra.fr/animal_emissions (accessed on August 7, 2014).
- The RMT has a database of livestock emission factors (ELFE) holding national emissions data and international literature. This database is intended to provide data for national emissions inventories and technical references.

4 Glossary

CEC	Cation exchange capacity
CFC	Chlorofluorocarbon
CH ₄	Methane.
CO	Carbon monoxide
CO ₂	Carbon dioxide
VOCnm	Non methane volatil organic compounds
GhGs	Greenhouse gases
HCFC	Hydrochlorofluorocarbon
N ₂	Dinitrogen
N ₂ O	Nitrous oxide
NH ₃	Ammonia
NH ₄ ⁺	(Ion) ammonium
NO ₂ ⁻	(Ion) nitrite
NO ₃ ⁻	(Ion) nitrate
N _{org}	Organic nitrogen
NO _x	Nitrogen monoxide (NO), dioxide (NO ₂), ...
O ₃	Ozone
Fine particulates or Aerosols	Solid or liquid particulate matter suspended in the atmosphere. Particulate matter is directly emitted in the air or result from chemical reactions. Particulate matter smaller than about 10 micrometers is referred to as <i>PM₁₀</i> . Particulate matter smaller than about 2.5 micrometers is referred to as <i>PM_{2.5}</i> .
SF ₆	Sulfur hexafluoride
ADEME	French Agency for Environment and Energy Management
AFNOR	French national organization for standardization
Arvalis – Plant Institute	French agricultural research institute at the disposal of farmers, companies of the cereal industry and development organizations in order to enhance the competitiveness and productivity of the farms.
Chamber of Agriculture	French network of agricultural advisers and representatives

CIGR	International Commission of Agricultural and Biosystems Engineering
Citepa	Interprofessional Technical Centre for Studies on Air Pollution. State operator of the French Environment Ministry (MEDDE) for conducting emission inventories of atmospheric pollutants and greenhouse gases.
EFDB	Emission factor database
IPCC	Intergovernmental Panel on Climate Change
Idele – French livestock institute	IDELE is a non-profit, non-governmental R&D organization appointed by the French ministry of agriculture as technical center for agriculture. It is the national reference and normative body in livestock farming systems.
Ifip- the pig research institute	IFIP is a non-profit, non-governmental R&D organization appointed by the French ministry of agriculture as technical center for agriculture. It is the national reference and normative body in pig farming systems.
INRA	French National Institute for Agricultural Research.
IRDA	Institut de Recherche et de Développement en Agro-environnement (Québec – Canada). IRDA is a non-profit research corporation whose mission is to engage in agri-environmental research, development and transfer activities that foster agricultural innovation from a sustainable development perspective.
IRSTEA	French Research Institute of Science and Technology for Environment and Agriculture
ITAVI	IFIP is a non-profit, non-governmental R&D organization appointed by the French ministry of agriculture as technical center for agriculture. It is the national reference and normative body in poultry and rabbit farming systems..
LNE	Laboratoire National de métrologie et d'Essai (France)
WHO	World Health Organization
PCET	Regional Climate and Energy plans (France)
PPA	Air protection plans (France)
RMT Elevage et Environnement / Joint Technology Network for livestock production and environment	The Joint Technology Network for livestock production and environment was approved by the Ministry for Agriculture in December 2007. It organizes projects to reduce emissions from animal husbandry within the theme “Reducing emissions from livestock farms”. Its partners are research and agricultural development organizations. Its projects range from applied research to the transfer of methods and benchmarks to the field.
SRCAE	Regional climate, air and energy plans (France).
UNIFA	National Association of the French furniture industry

GUM	Guide to the Expression of Uncertainty in Measurement (GUM), , published by BIPM (Bureau International des poids et des mesures)
VIM	International Vocabulary of Metrology, published by BIPM (Bureau International des poids et des mesures)
Acidification	Soil acidification is the buildup of hydrogen cations, also called protons, reducing the soil ph. This happens when a proton donor gets added to the soil. Many nitrogen compounds, which are added as fertilizer acidify soil over the long term because they produce nitrous and nitric acid when oxidized in the process of nitrification. Acidification also occurs when base cations such as calcium, magnesium, potassium and sodium are leached from the soil. This leaching increases with increasing precipitation. Acid rain accelerates the leaching of bases.
Mechanically ventilated building	Livestock building with mechanical ventilation. Mechanical ventilation of building is made through the use of electrically powered fans in the walls or roof that are normally controlled by the temperature in the building.
Naturally ventilated building	Livestock building with natural ventilation. Natural ventilation of a building, e.g. For cattle, by openings or gaps designed into the roof and/or sides of the building. It can be controlled by the use of curtains. Ventilation is caused by wind pressure, or differences in temperature (i.e. In air density) between indoor and outdoor air
Mass balance	Mass balance applies the law of conservation of mass to a facility or a process. It can be applied to validate the order of magnitude of emissions measurement or can be a step of a method (ie Application note 21 ,Application note 22).
Bolus	Permeation tube inserted into the rumen of animal. This tube releases its charge of tracer gas (usually sf ₆) through a permeable 'window' at a rate governed by the window size, membrane thickness, and temperature. The rate of sf ₆ release is determined through a calibration process prior to the experiment.
Atmospheric deposition	The transfer of substances in air to surfaces, including soil, vegetation, surface water, or indoor surfaces, by dry or wet processes.
Denitrification	Denitrification is a microbially facilitated process of nitrate reduction that may ultimately produce molecular nitrogen (N ₂) through a series of intermediate gaseous nitrogen oxide products like n ₂ o.
Oasis effect	Effect that may be observed with methods concerning measurement of field emissions (application note 26). The oasis effect arises from the local environment of the field being studied. The emissions from a particular field will be depend on whether it is in an environment with a high level of emissions or a low level of emissions because the difference in concentrations between the air and the soil will not be the same. The larger the area of the source, the smaller the effect.
Eutrophication	Excessive enrichment of waters with nutrients, and the associated

	adverse biological effects.
Gas standard	Single gas or gas mixture with known concentrations (certified values with known associated measurement uncertainty) that can be used as reference.
Tracer gas	A tracer gas is used for marking of air. It should be non-toxic, inert and naturally not occurring in the studied environment.
Gradient	The rate at which a physical quantity, such as temperature or pressure, changes in response to changes in a given variable.
Emission factor	Is defined as the average emission rate of a given gas emission for a given source, relative to units of activity.
Solid manure	Manure from housed livestock that does not flow under gravity, cannot be pumped but can be stacked in a heap. There are several different types of solid manure arising from different types of livestock housing, manure storage and treatment.
Measurement uncertainty	Non-negative parameter characterizing the dispersion of the quantity values being attributed to a measurand, based on the information used.
Interferences	Physical phenomena that can be observed when using traditional transmission spectrometers. Some gases absorb light at similar wavelengths and this can result in not knowing if the concentration displayed is from one gas, another gas or both. This is called interference.
Detection limit	Measured quantity value, obtained by a given measurement procedure, for which the probability of falsely claiming the absence of a component in a material is β , given a probability α of falsely claiming its presence.
Slurry	Faeces and urine produced by housed livestock, usually mixed with some bedding material and some water during management to give a liquid manure with a dry matter content in the range from about 1 – 10%.
Best available techniques (BAT)	Best available techniques means the most effective and advanced stage in the development of activities and their methods of operation which indicates the practical suitability of particular techniques for providing the basis for emission limit values and other permit conditions designed to prevent and, where that is not practicable, to reduce emissions and the impact on the environment.
Measurement	Process of experimentally obtaining one or more quantity values that can reasonably be attributed to a quantity.
Measurand	Quantity intended to be measured
Measurement method	Method of measurement generic description of a logical organization of operations used in a measurement.

Micrometeorological techniques	Micrometeorological techniques use analyses of the atmospheric concentration of the gas and meteorological measurements such as wind speed, wet- and dry-bulb air temperatures, net radiation, and heat fluxes do not disturb the environmental conditions. These techniques are used for determining field-scale fluxes, and include eddy correlation, energy balance, aerodynamic and mass balance techniques.
Intrusive method	Measuring method that can influence the emitting processes.
Dispersion modeling	Dispersion modeling is the mathematical simulation of how air pollutants disperse in the ambient atmosphere. It is a means of estimating downwind air pollution concentrations given information about the pollutant emissions and nature of atmosphere.
Immobilization	Immobilization in soil science is the conversion of inorganic compounds to organic compounds by micro-organisms or plants, by which it is prevented from being accessible to plants. Immobilization is the opposite of mineralization.
Nitrification	The oxidation of the ammonium compounds into nitrites and nitrates.
Diffuse emissions	Diffuse emissions to air and water occur from various scattered sources. Pollution from diffuse sources occurs over large areas and individually may not be of concern but in combination with other diffuse sources can cause environmental impact.
Measurement precision	Closeness of agreement between indications or measured quantity values obtained by replicate measurements on the same or similar objects under specified conditions.
PTFE	Polytetrafluoroethylene. PTFE is an inert thermoplastic polymer that is highly recommended for reactive gas sampling.
Measurement repeatability	Measurement precision under a set of repeatability
Measurement reproducibility	Measurement precision under reproducibility conditions of measurement.
Result of measurement	Set of quantity values being attributed to a measurand together with any other available relevant information.
Resolution	Smallest change in a quantity being measured that causes a perceptible change in the corresponding indication.
Selectivity	Property of a measuring system, used with a specified measurement procedure, whereby it provides measured quantity values for one or more measurands such that the values of each measurand are independent of other measurands or other quantities in the phenomenon, body, or substance being investigated
Sensitivity	Quotient of the change in an indication of a measuring system and the corresponding change in a value of a quantity being measured.

Spectrometer and spectrophotometer	Spectrometer is any instrument used to view and analyze a range (or a <i>spectrum</i>) of a given characteristic for a substance, or a range of wavelengths as in absorption spectrometry like infrared spectroscopy). A spectrophotometer is a spectrometer that only measures the intensity of electromagnetic radiation (light) and is distinct from other spectrometers such as mass spectrometers.
Atmospheric stability	A stable atmosphere restricts the vertical dispersion of the emitted aerosols. The atmosphere is said "stable" when the temperature lapse rate is less than the dry adiabatic rate. The atmosphere is neutral if the temperature lapse rate is the same as the dry adiabatic rate and unstable if it is higher.
Physiological stage	Stage of an animal's development associated with specific livestock practices and physiological needs.
Sampling strategy	Plan that defines the different steps for sampling to have representative samples and to ensure the conservation of the samples before analysis.
Step response time	Duration between the instant when an input quantity value of a measuring instrument or measuring system is subjected to an abrupt change between two specified constant quantity values and the instant when a corresponding indication settles within specified limits around its final steady value.
Turbidity	Turbidity is the cloudiness or haziness of a fluid caused by large numbers of individual particles that are generally invisible to the naked eye.
Turbulence	Turbulence or turbulent flow is a flow regime characterized by chaotic property changes. This includes low momentum diffusion, high momentum convection, and rapid variation of pressure and flow velocity in space and time. In turbulent flow, unsteady vortices appear on many scales and interact with each other.
Volatilization	The transition of either a liquid or a solid directly into vapor state.

5 Abbreviations and units

Symbol	Definition	Units
$\alpha_{i,\lambda}$	Absorption coefficient of gas i at wavelength = lambda	$\text{m}^2 \cdot \mu\text{g}^{-1}$
A	Area	m^2
C	Mass concentration	$\mu\text{g} \cdot \text{m}^{-3}$ or $\text{mg} \cdot \text{m}^{-3}$ or $\text{g} \cdot \text{m}^{-3}$
C_v	Volume concentration	$\text{ml} \cdot \text{m}^{-3}$ or $\text{l} \cdot \text{m}^{-3}$ or ppm or ppb
$\text{CO}_{2,x}$	CO_2 production due to x (animals, heating, ...)	$\text{m}^3 \text{CO}_2 \text{h}^{-1}$
D	Diffusion coefficient	$\text{m}^2 \cdot \text{s}^{-1}$
D_t et K_x	Turbulent diffusion coefficient	$\text{m}^2 \cdot \text{s}^{-1}$
ϵ_m	Extinction coefficient d'extinction related to Mie diffusion	
ϵ_r	Extinction coefficient related to Rayleigh diffusion	
Eff	Collection efficiency	without dimension
E	Enthalpy	$\text{J} \cdot \text{kg of air}^{-1}$
F	Flux or emission	$\text{g} \cdot \text{s}^{-1}$ or $\text{g} \cdot \text{h}^{-1}$ or $\text{g} \cdot \text{day}^{-1}$ or $\text{kg} \cdot \text{day}^{-1}$
F_s	Flux or emission per area	$\text{g} \cdot \text{m}^{-2} \cdot \text{s}^{-1}$ or $\text{ng} \cdot \text{m}^{-2} \cdot \text{s}^{-1}$
F_t	Flux or emission per animal	$\text{mg} \cdot \text{min}^{-1} \cdot \text{animal}^{-1}$ or $\text{g} \cdot \text{day}^{-1} \cdot \text{animal}^{-1}$ or $\text{g} \cdot \text{an}^{-1} \cdot \text{animal}^{-1}$
Hs	Specific humidity of air	$\text{kg of water} \cdot \text{kg of dry air}^{-1}$
H_i	Heat balance	$\text{J} \cdot \text{s}^{-1}$ or $\text{J} \cdot \text{h}^{-1}$
I_λ	Radiation intensity	$\text{W} \cdot \text{sr}^{-1}$
Λ	Wavelength	nm to m
L	Length	cm or m
Lat	Latent heat of vaporization of water	$2,45 \cdot 10^6 \text{ J} \cdot \text{kg}^{-1}$
m	Mass	en μg or mg or g or kg

M	Molar mass	g.mol^{-1}
N	Number of molecules per volume unit	molecule.m^{-3}
N_i	Nitrogen quantity in compartment i (e.g litter)	Kg
q	Flow rate	$\text{m}^3.\text{s}^{-1}$ or $\text{m}^3.\text{h}^{-1}$
Q	Heat quantity	J.m^{-3}
ρ	Air density	kg.m^{-3} or g.m^{-3}
P	Pressure	Pa
Σ	Cross section	$\text{cm}^2.\text{molecule}^{-1}$
$S(\lambda)$	Rayleigh diffusion of solar radiation	W.sr^{-1}
t	Time	S
T	Temperature	$^{\circ}\text{C}$ or K
U ou u	Wind velocity	m.s^{-1}
u^*	Friction velocity	m.s^{-1}
v	Velocity	m.s^{-1} or m.h^{-1}
V	Volume	m^3
w	Vertical wind velocity	m.s^{-1}
z	Height	M

6 Contact

Coordinators	Organisation	Email
HASSOUNA Mélynda	INRA	melynda.hassouna@rennes.inra.fr
EGLIN Thomas	ADEME	thomas.eglin@ademe.fr

Contributors	Organisation	Email
CELLIER Pierre	INRA	pierre.cellier@grignon.inra.fr
COHAN Jean-Pierre	ARVALIS Institut du Végétal	jp.cohan@arvalisinstitutduvegetal.fr
COLOMB Vincent	ADEME	vincent.colomb@ademe.fr
DECUQ Céline	INRA	celine.decuq@grignon.inra.fr
DUBE Patrick	IRDA	patrick.dube@irda.qc.ca
EDOUARD Nadège	INRA	nadege.edouard@rennes.inra.fr
ESPAGNOL Sandrine	IFIP	sandrine.espagnol@ifip.asso.fr
EUGENE Maguy	INRA	maguy.eugene@clermont.inra.fr
FAUVEL Yannick	INRA	yannick.fauvel@rennes.inra.fr
FERNANDES Emilie	LNE	emilie.fernandes@lne.fr
FISCHER Nicolas	LNE	nicolas.fischer@lne.fr
FLECHARD Chris	INRA	chris.flechard@rennes.inra.fr
GENERMONT Sophie	INRA	sophie.genermont@grignon.inra.fr
GIRARD Matthieu	IRDA	matthieu.girard@irda.qc.ca
GODBOUT Stéphane	IRDA	stephane.godbout@irda.qc.ca
GUINGAND Nadine	IFIP	nadine.guingand@ifip.asso.fr
GUIZIOU Fabrice	IRSTEA	fabrice.guiziou@irstea.fr
GUYADER Jessie	INRA	jessie.guyader@clermont.inra.fr
LAGADEC Solène	CRAB	solene.lagadec@bretagne.chambagri.fr
LAROUCHE Jean-Pierre	IRDA	jean-pierre.larouche@irda.qc.ca
LAVILLE Patricia	INRA	patricia.laville@grignon.inra.fr
LORINQUER Elise	IDELE	elise.lorinquer@idele.fr
LOUBET Benjamin	INRA	benjamin.loubet@grignon.inra.fr
LOYON Laurence	IRSTEA	laurence.loyon@irstea.fr
MARTIN Cécile	INRA	cecile.martin@clermont.inra.fr
MEDA Bertrand	INRA	bertrand.meda@tours.inra.fr
MORVAN Thierry	INRA	thierry.morvan@rennes.inra.fr
OSTER Dominique	LNE	dominique.oster@lne.fr
OTJES Renee	ECN	otjes@ecn.nl
PERSONNE Erwan	AgroParisTech	erwan.personne@agroparistech.fr
PONCHANT Paul	ITAVI	ponchant@itavi.asso.fr
POTVIN Lise	IRDA	lise.potvin@irda.qc.ca
ROBIN Paul	INRA	paul.robin@rennes.inra.fr
ROCHETTE Yvonne	INRA	yvonne.rochette@clermont.inra.fr
TANG Sim	CEH	yst@ceh.ac.uk
TROCHARD Robert	ARVALIS Institut du Végétal	r.trochard@arvalisinstitutduvegetal.fr

7 Abstract

Air pollutant and greenhouse gas emissions have recently become an environmental concern for livestock farmers. In France, livestock farming plays a major contribution to air pollutant emissions, amounting to over 70% of national ammonia (NH₃) emissions and 75% of methane (CH₄) emissions. Currently, the measurement of emissions from livestock is still not very widespread, limiting the number of references available for national livestock production that can be used to guide farmers on how to modify their production systems to reduce emissions. This review was drawn up by the ADEME and the RMT "Livestock and Environment" to set out the main measurement methods used to quantify greenhouse gas, ammonia and nitrous oxide (dinitrogen monoxide) emissions from livestock production systems. The main aim is to provide the information required to help potential users determine which quantification methods are most suitable for their requirements and how much the equipment is likely to cost.

Printer: A4 Editions 1, rue de la Barre - 49000 ANGERS

Photos: INRA and IFIP photo libraries

Download site: https://www.inra.fr/animal_emissions

ISBN: 2-7380-1392-9

EAN code: 978 273 801 3927

How to cite:

Hassouna Mélynda, Eglin Thomas et al. Measuring emissions from livestock farming: greenhouse gases, ammonia and nitrogen oxides. Published by Ademe and INRA. 314p. ISBN 2-7380-1392-9



Measuring emissions from livestock farming



Greenhouse gases, ammonia and nitrogen oxides

Air pollutant and greenhouse gas emissions have recently become an environmental concern for livestock farmers. In France, livestock farming plays a major contribution to air pollutant emissions, amounting to over 70% of national ammonia (NH₃) emissions and 75% of methane (CH₄) emissions. Currently, the measurement of emissions from livestock is still not very widespread, limiting the number of references available for national livestock production that can be used to guide farmers on how to modify their production systems to reduce emissions. This review was drawn up by the ADEME and the RMT "Livestock and Environment" to set out the main measurement methods used to quantify greenhouse gas, ammonia and nitrous oxide (dinitrogen monoxide) emissions from livestock production systems. The main aim is to provide the information required to help potential users determine which quantification methods are most suitable for their requirements and how much the equipment is likely to cost.

