



HAL
open science

Sensors for Health Recording and Physical Activity Monitoring

Guy Carrault, Frédéric Guidec, Jacques Prioux, Di Ge, Juliette Boulanger

► **To cite this version:**

Guy Carrault, Frédéric Guidec, Jacques Prioux, Di Ge, Juliette Boulanger. Sensors for Health Recording and Physical Activity Monitoring. Journées d'Etude sur la TélésANTé, 6ème edition, May 2017, Bourges, France. 2017. hal-01565010

HAL Id: hal-01565010

<https://hal.science/hal-01565010>

Submitted on 19 Jul 2017

HAL is a multi-disciplinary open access archive for the deposit and dissemination of scientific research documents, whether they are published or not. The documents may come from teaching and research institutions in France or abroad, or from public or private research centers.

L'archive ouverte pluridisciplinaire **HAL**, est destinée au dépôt et à la diffusion de documents scientifiques de niveau recherche, publiés ou non, émanant des établissements d'enseignement et de recherche français ou étrangers, des laboratoires publics ou privés.

SHERPAM

Sensors for Health Recording and Physical Activity Monitoring



- LTSI - INSERM 1090
- CASA - IRISA UMR 6074
- M2S - CACHAN UR2
- LAUREPS - CRPCC, EA 1285
- CIC 1414

OBJECTIVES

Conceive, implement, and validate experimentally devices allowing biophysical data of mobile subjects to be gathered and exploited in a continuous flow.

Focused application domains:

- Heart failure patient's monitoring (HF).
- Outdoor assessment of functional limitations and community-based walking programs for rehabilitation in patients with peripheral artery disease.
- Physical activity recognition and energy expenditure estimation,

GENERAL ARCHITECTURE OF THE PROJECT

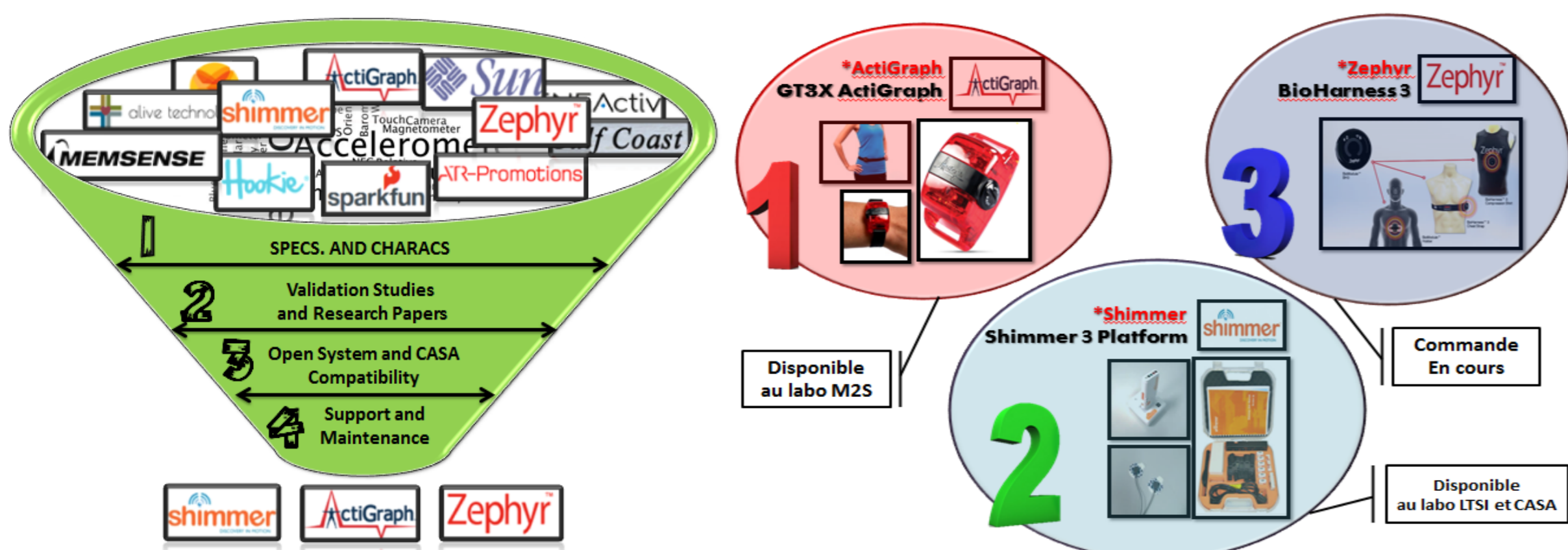
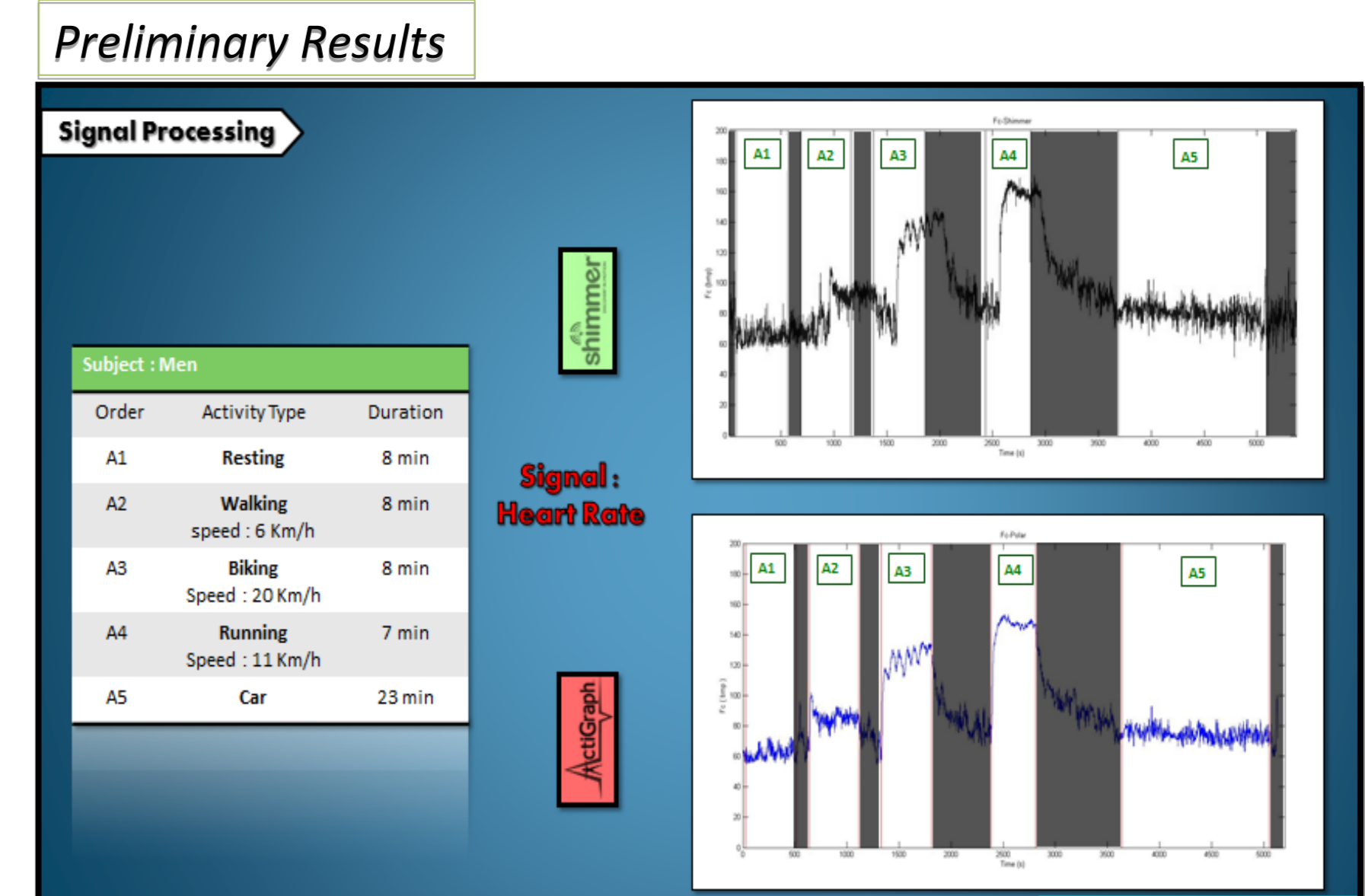
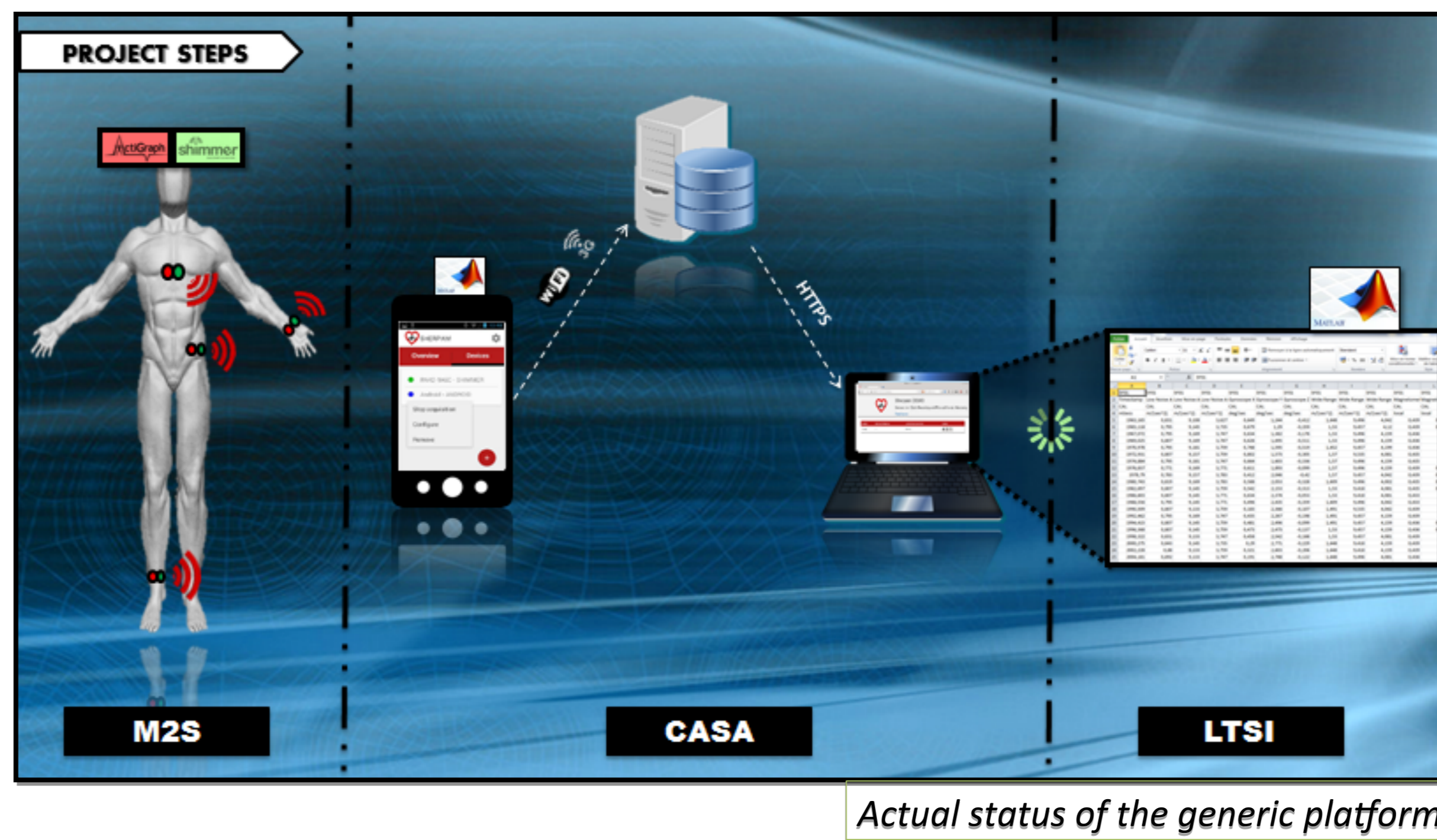
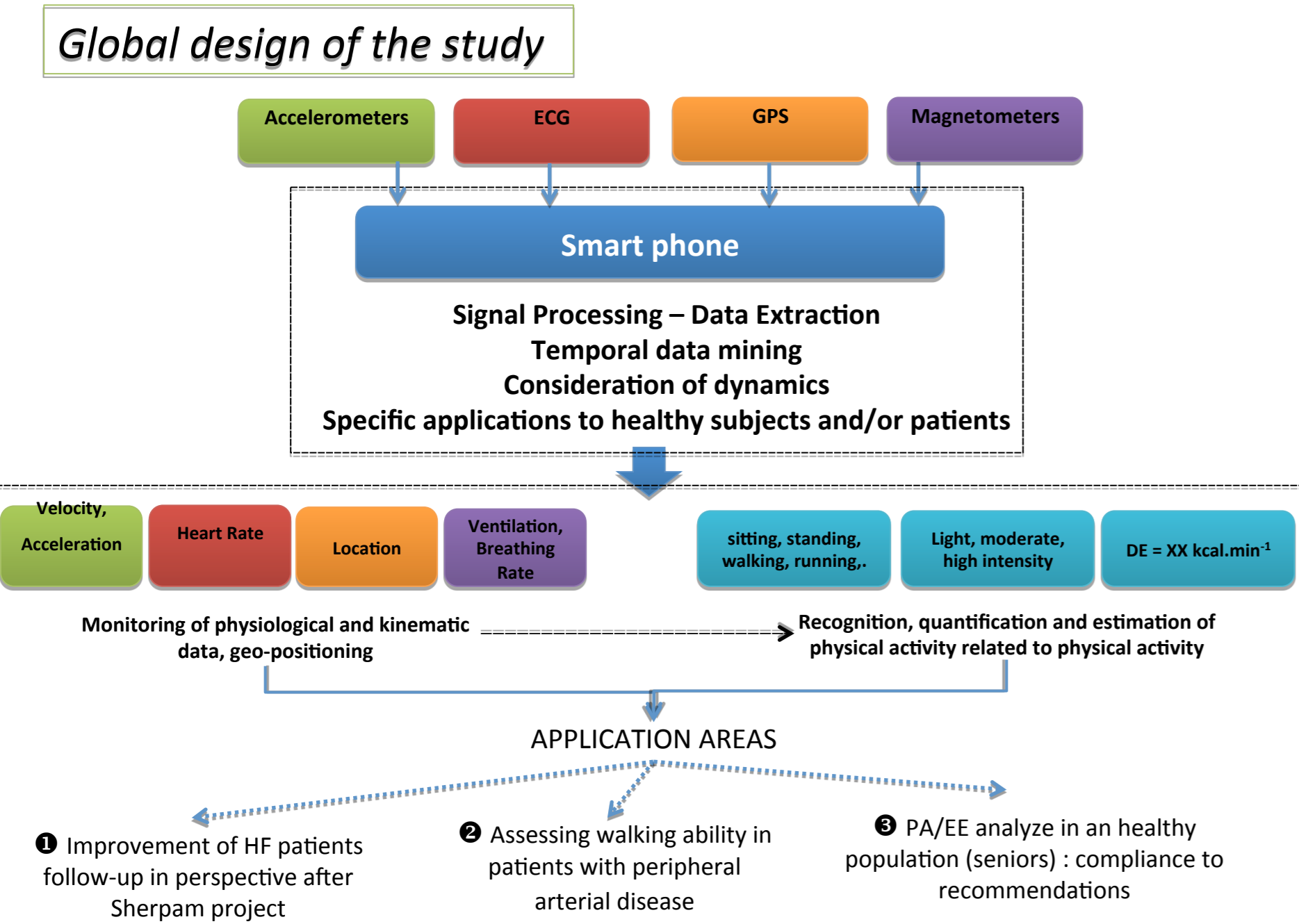

MAIN RESULTS

IRISA-CASA

- 1) An open platform dedicated to mobile monitoring built around four criteria :
 - Versatility : to accommodate to a large variety of off-the-shelf sensors
 - Extensibility : to add new sensors and embedded processing easily
 - Confidentiality : to ensure the privacy and the non-disclosure of the data
 - Dependability : to work everywhere by limiting the energy consumption (EC) and by providing a resilience to network disruption
- 1) A plugin approach for both sensors and embedded algorithms to personalize the platform for each patient and his/her condition
- 2) Evaluation of EC of various transmission technologies

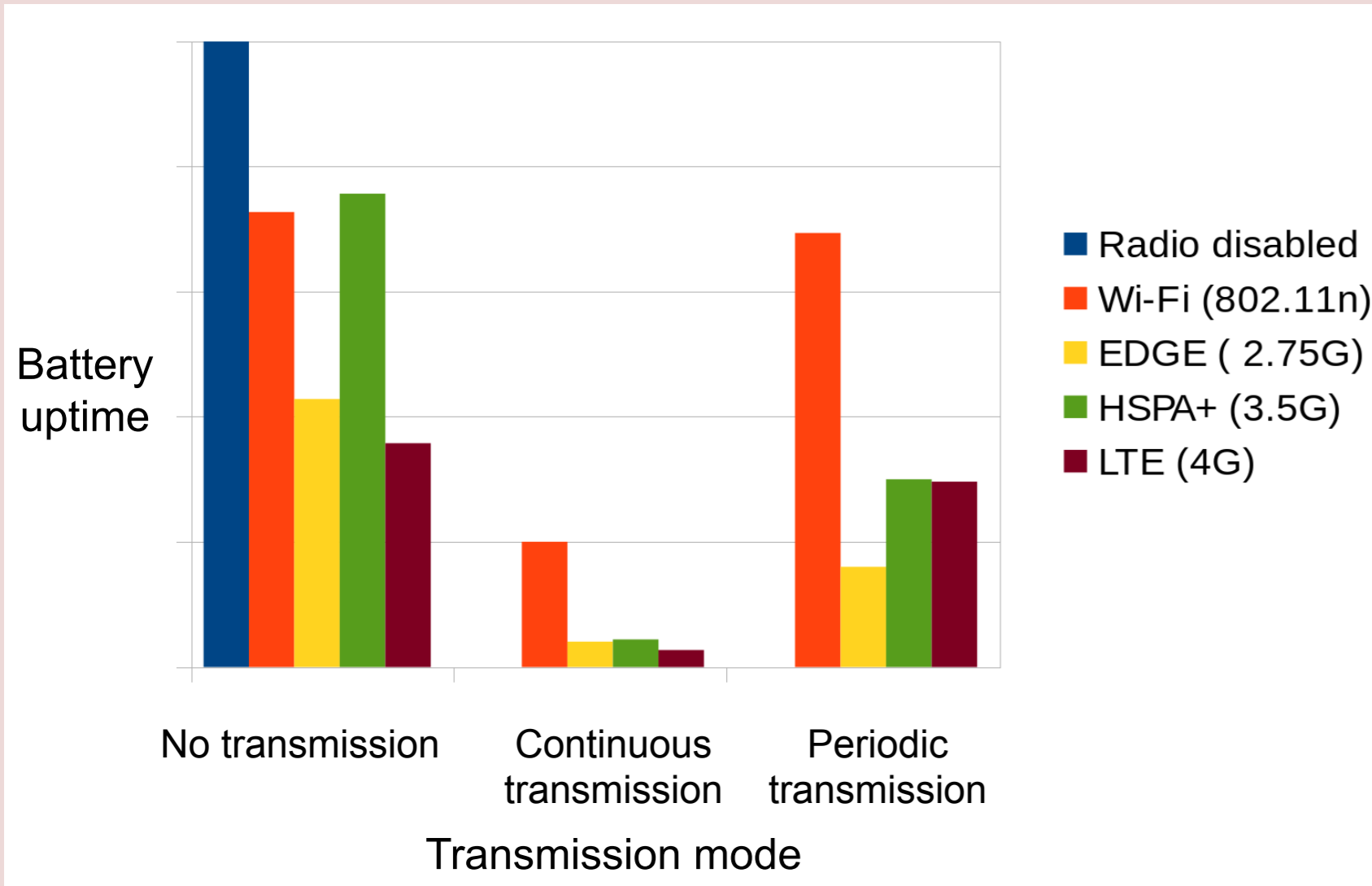

LTSI/M2S

- 1) Develop signal processing tools to : Recognize and classify five ambulatory and sedentary activities (cycling, walking, running, sitting, car-riding) using heart rate and acceleration data fusion.

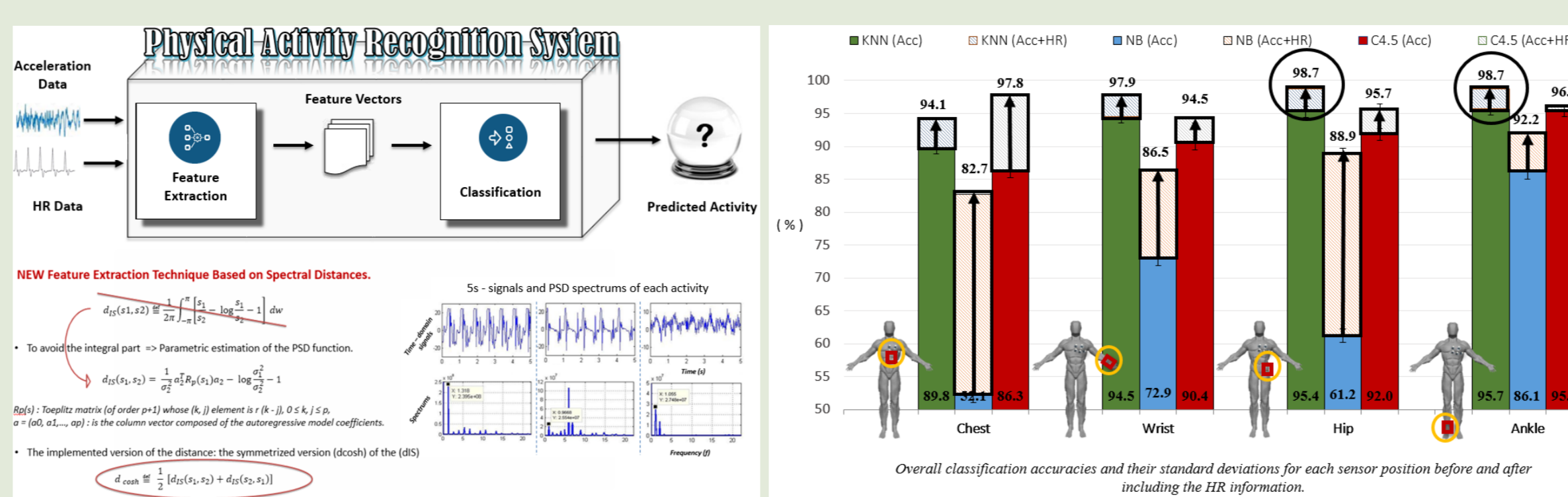

- 2) Develop a new experimental protocol for daily-life activities recognition and energy expenditure estimation:

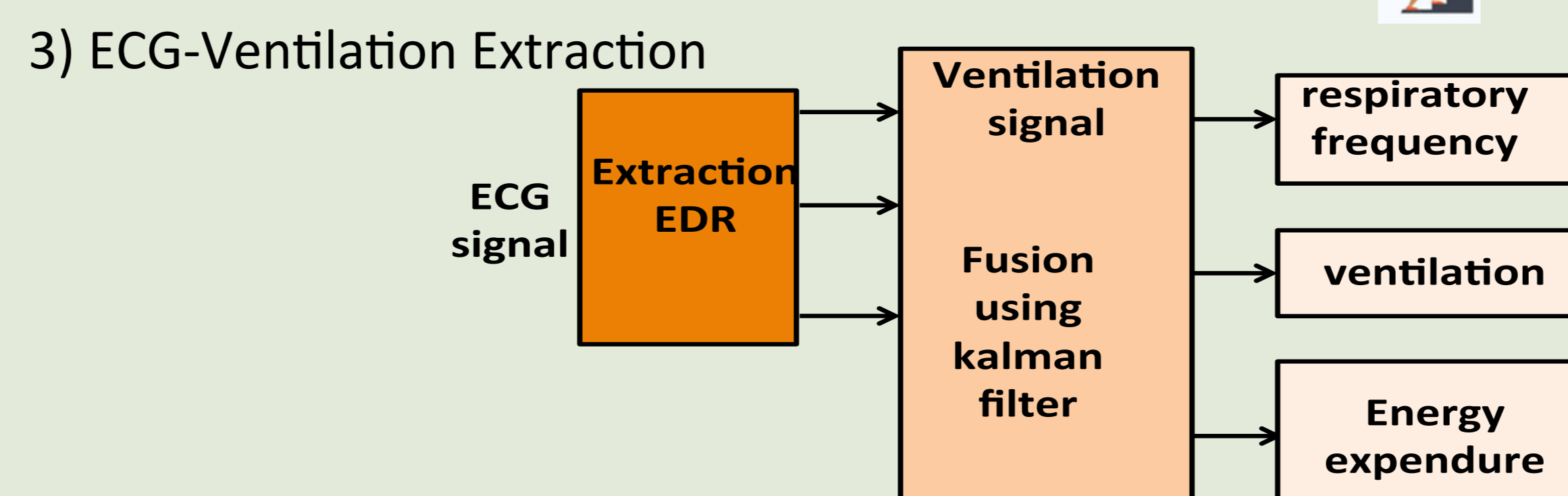
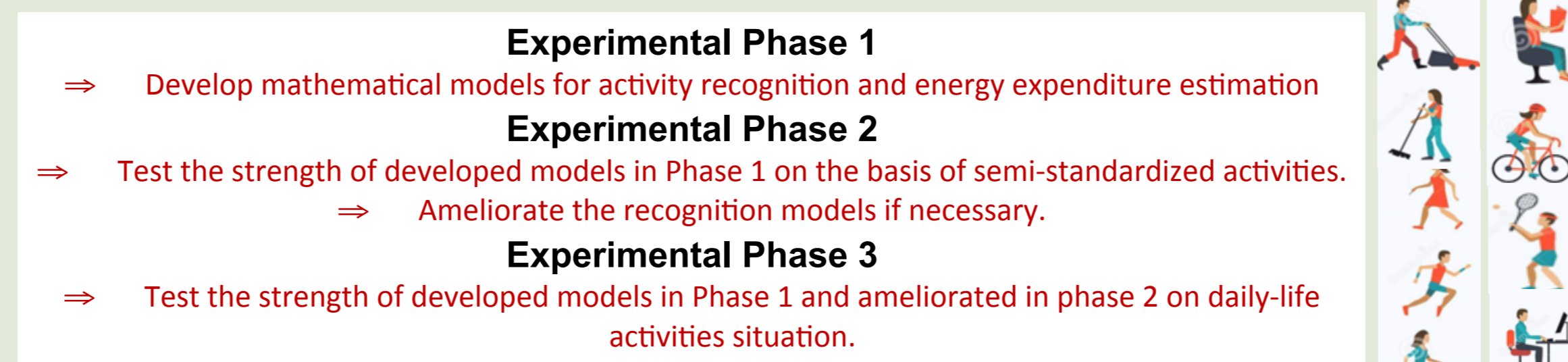

LAUREPS-CIC-IT

- 1) Context of Sherpam use understanding
- 2) User's profiles and requirements
- 3) Authentication of primary functions and risks of sensors/gateway/mobile app. /web site use
- 4) Review wearable sensor acceptance and usability

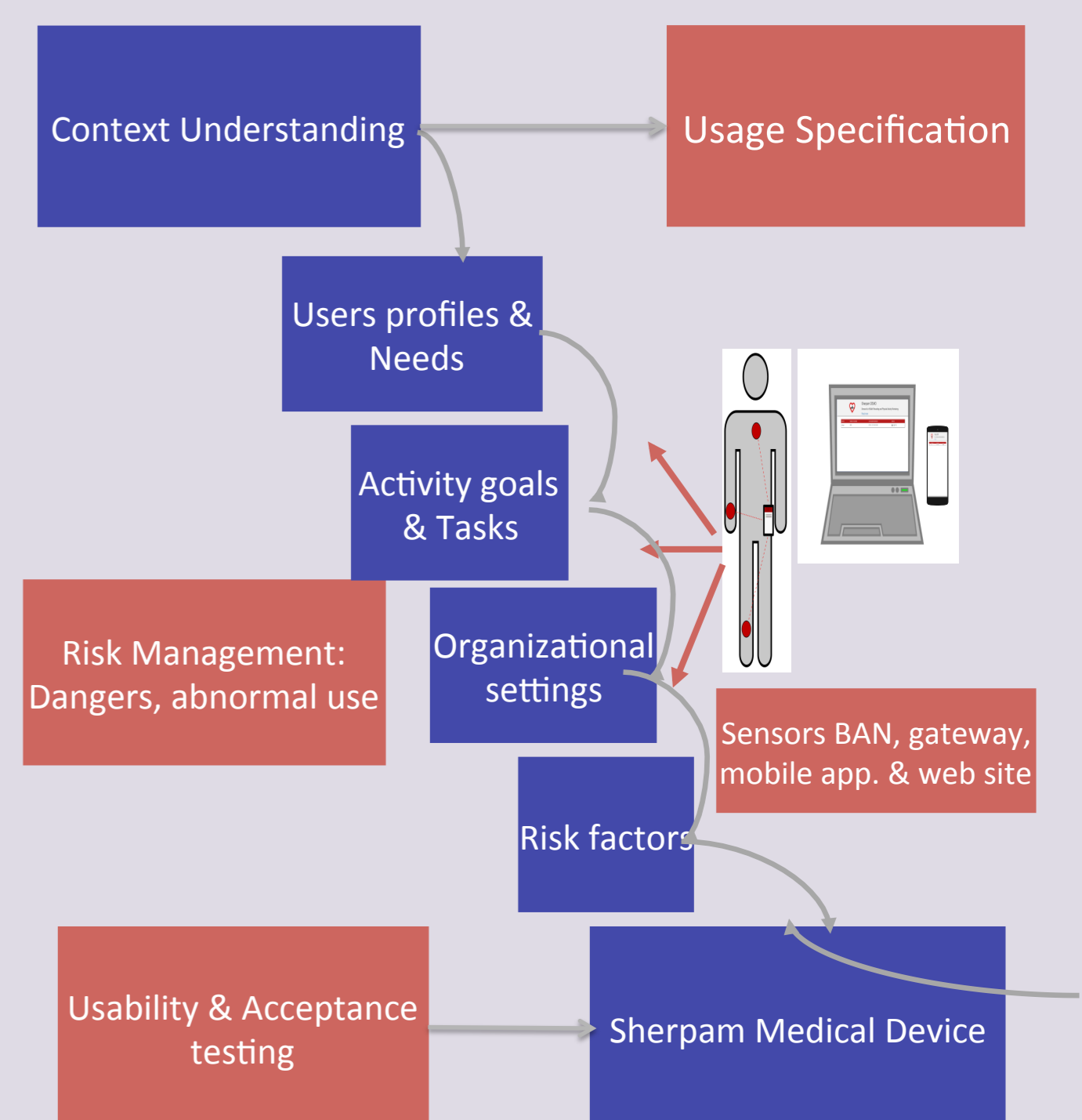

Publications

Biomedical Signal Processing and Control (Journal, 2016) - Mobihealth'16 - 6th EAI International Conference on Wireless Mobile Communication and Healthcare (November 2016) - Healthcom'16 - 18th International Conference on e-Health Networking, Applications and Services (September 2016) - ECSS'16 Conference - Advances in Biomedical Engineering (ICABME'15) International Conference and then published in IEEE Conference proceedings.

