



**HAL**  
open science

# SiC power devices packaging with a short-circuit failure mode capability

Ilyas Dchar, Cyril Buttay, Hervé Morel

► **To cite this version:**

Ilyas Dchar, Cyril Buttay, Hervé Morel. SiC power devices packaging with a short-circuit failure mode capability. *Microelectronics Reliability*, 2017, 10.1016/j.microrel.2017.07.003 . hal-01562547

**HAL Id: hal-01562547**

**<https://hal.science/hal-01562547>**

Submitted on 15 Jul 2017

**HAL** is a multi-disciplinary open access archive for the deposit and dissemination of scientific research documents, whether they are published or not. The documents may come from teaching and research institutions in France or abroad, or from public or private research centers.

L'archive ouverte pluridisciplinaire **HAL**, est destinée au dépôt et à la diffusion de documents scientifiques de niveau recherche, publiés ou non, émanant des établissements d'enseignement et de recherche français ou étrangers, des laboratoires publics ou privés.

# SiC power devices packaging with a short-circuit failure mode capability

Ilyas DCHAR<sup>a</sup>, Cyril BUTTAY<sup>b,\*</sup>, Hervé MOREL<sup>b</sup>.

<sup>a</sup> Power Electronics, SuperGrid Institute, Villeurbanne, France.

<sup>b</sup> Université de Lyon, CNRS, INSA-Lyon, Laboratoire AMPÈRE, UMR 5005, F-69621, Villeurbanne, France

---

## Abstract

*The failure mode of press-pack-type packages dedicated to SiC devices is experimentally analyzed in order to investigate their use for HVDC applications. Single SiC Schottky diode samples have been submitted to short-circuit conditions and continuous current flow test. The samples have been then characterized with optical and scanning electronic microscopy. Results from the experiments reveal that the press-pack structure offers a short-circuit failure mode with SiC devices, as it does for Si devices. The metallurgy involved is, however, quite different. Cu, Ni, Ag or Al foils are found to be suitable interface material between the package and the die to achieve a stable short-circuit failure mode, providing the die is properly attached to a substrate.*

---

## 1. Introduction

Generally, the failure mode of a power electronic component can be classified as open-circuit failure or short-circuit failure. Components which fail to an open circuit are considered unsuitable for applications requiring series connection. Especially, in some high-voltage direct current (HVDC) applications, the modules must be designed such that when a failure occurs, the failed module keeps carrying the load current by the formation of a stable short circuit [1], while the remaining modules share the blocking voltage. Such operation is referred to as short circuit failure mode (SCFM). One of the existing packaging technologies which has the ability to achieve SCFM is called press-pack. This technology was first developed for thyristors and GTOs, and, later, for IGCTs and IGBTs [2]. Press-pack modules are very different compared to the more conventional wire-bond modules. In press-pack, the die is in direct contact with metal parts which serve both as heat sinks and electrical terminals. The semiconductor is consequently cooled from both sides, which is a considerable advantage because the cooling area is doubled. Additionally, the housing is hermetic, which means that pollutants cannot enter and cause subsequent damage [2].

Moreover, this package type does not explode in the majority of failure cases [3]. Press-pack packages offer high reliability because they have no soldering layers that can delaminate and no bond-wires that can lift-off or melt in case of very high surge currents. Thanks to the massive metal contacts, the faulty semiconductor enters into a safe SCFM: metals like silver (Ag) and aluminum (Al) are used in contact with the die to form low melting point eutectic alloys with silicon [4]. The alloy thus formed has to carry the electrical current instead of the failed device. In HVDC application, this state has to be maintained until the next scheduled maintenance, which may be performed yearly [2]. Currently, the available press-pack components use silicon semiconductors. SiC power devices are very attractive from an electrical point of view and will probably replace silicon for high voltage applications in the future. SiC, however, require a complete redefinition of the SCFM mechanism, as it has very different physical properties compared to silicon. The challenge of this work is to investigate experimentally if it is possible to achieve SCFM capability with SiC semiconductors by using press-pack technology.

## 2. Experimental procedure

### 2.1. Sample preparation

To evaluate the behavior of SiC press-pack modules under extreme operating conditions, a simplified package has been implemented. A clamping fixture (Fig.1) is used

---

\* Corresponding author: [cyril.buttay@insa-lyon.fr](mailto:cyril.buttay@insa-lyon.fr)  
Tel: 00.33.(0)6.88.03.02.52

to perform destructive tests on bare SiC dies (here some 1200V SiC Schottky diodes, part ref. CPW4-1200S020B from Wolfspeed). The characteristics of the SiC dies are shown in Table 1. They have  $\sim 4 \mu\text{m}$  Al metallization on the top anode pad and  $\sim 1.4 \mu\text{m}$  Ni/Ag metallization on the cathode side.

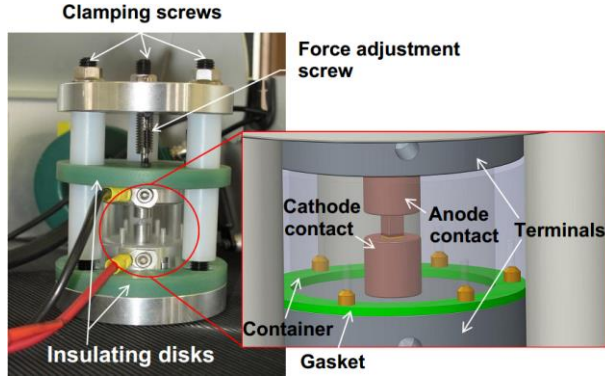

Fig. 1. Picture of single chip press-pack clamp.

Chip diode (Part Ref.)	$V_{RRM}$ (V)	$I_F$ (A)	Die size ( $\text{mm}^2$ )	Thickness (mm)
CPW41200S020B	1200	20	3.08x3.08	0.377

Table 1. Characteristics of the SiC dies used in this article.

Figure 2 shows a simplified drawing of the two tested structures. In the first one (Fig.2a), a die is placed in a shallow pocket machined in the cathode contact part (Fig.3a). A thin ( $200 \mu\text{m}$ ) metal foil is then placed on top of the SiC die. This foil is  $2.5 \times 2.5 \text{ mm}^2$ , and is made of Al, Ag, Cu or Ni (Goodfellows, 99.9% purity). These materials were selected because they may react with SiC when failure occurs [5], [6]. Once the die and the foil are in contact, the container (Fig.3b) is filled with some dielectric fluid (MIDEL 7131) to prevent arcing. Finally, the anode contact is applied, and pressed by tightening the force adjustment screw (Fig.3c). As shown in Fig.2a, the die and the metallization are pressed between two molybdenum pieces. This material was chosen because of its high melting point ( $2623 \text{ }^\circ\text{C}$ ).

In the second structure (Fig.2b), the SiC die is attached to a DBC substrate using the Ag joint (Fig.4). Then, we have used different metal foils for the top side of the dies.

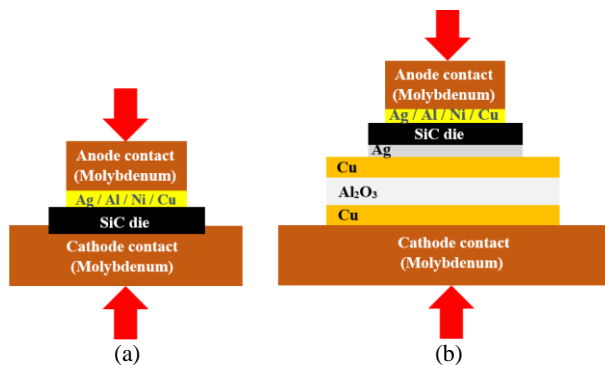

Fig. 2. Tested samples. (a) The die and the metal foil are pressed between two contacts; (b) Sample constructed with DBC substrate.

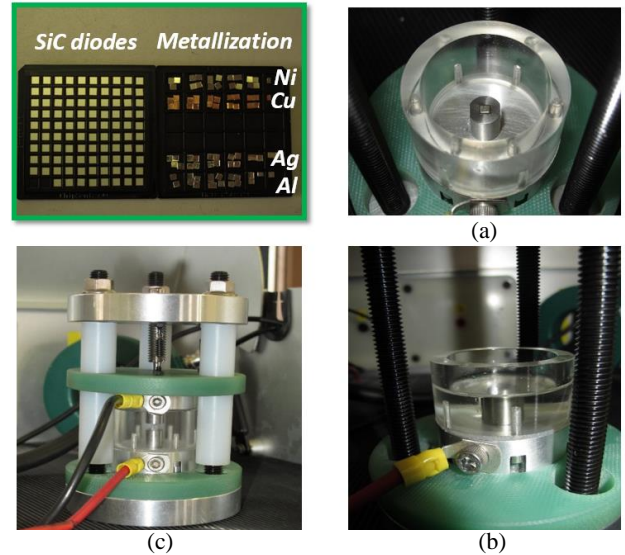

Fig. 3. Assembly of the structure of Fig.2a. (a) The die is placed in a pocket of the bottom contact. A metal foil (Ag, Cu, Ni or Al) is placed on the top of the die; (b) the container is filled with Midel 7131 insulating oil; (c) the top contact is lowered and the pressure is adjusted using the force adjustment screw.

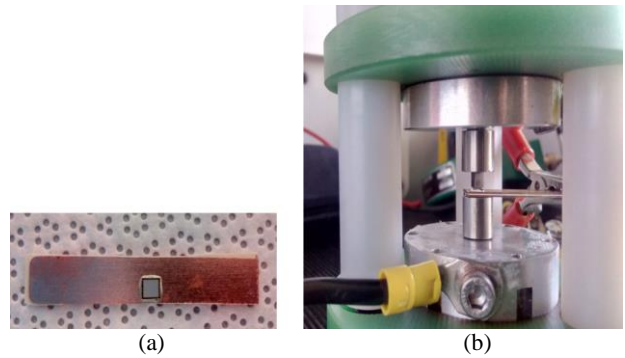

Fig. 4. Assembly of the structure of Fig.2b. (a) The die is attached to a DBC substrate using silver sintering; (b) The DBC is then placed in the clamping fixture (again, with a metal foil on the top of the die). Because of the size of the DBC, the container is not used.

## 2.2. Description of the bench for destructive tests

Short circuit tests are carried out using the test bench presented in Fig. 5 and 6. A High voltage power supply ( $3 \text{ kV}_{DC}$ ) charges a film capacitor  $C$  ( $1250 \mu\text{F}$ ,  $3000 \text{ V}$ ). The “auxiliary” IGBT is used in series with the diode to deliver the current pulse to the sample [7]. In order to estimate the energy leading to device’s failure, the capacitor voltage has been increased from a low value where the device is able to sustain the short circuit conditions up to the failure. The energy leading to the device failure is determined by measuring the current through and the voltage across the device using a Pearson current monitor model 4997 and a high voltage probe (PHV 662-L) from PMK.

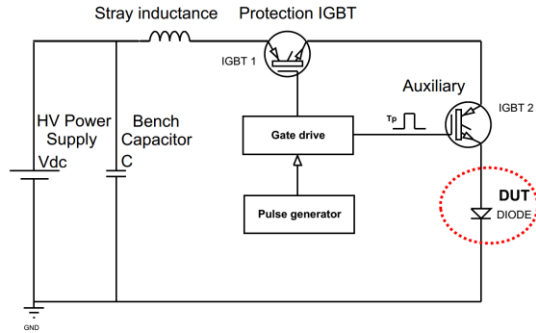

Fig. 5. Circuit diagram of the short-circuit test system.

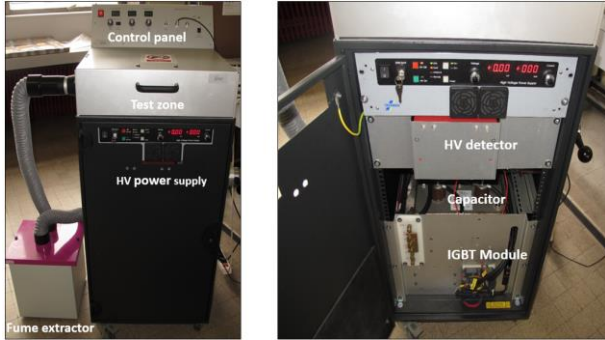

Fig. 6. Picture of the experimental setup using the power circuit in Fig. 3. [7]

### 2.3. Continuous current flow test

After destructive testing, samples showing fail-to-short-circuit behavior are subjected to a continuous current flow (10 A) for 2 hours. The aim of this test is to evaluate the quality and stability of the SCFM. The electrical resistance between anode and cathode contacts is measured over time. If the resistance of the faulty device does not change over time (or if it decreases), then the short circuit is considered as stable. On the contrary, if the resistance increases significantly (more than 10% compared to the value immediately after failure) over time, then the short-circuit failure mode is considered as unstable. The measurement of the resistance ( $R_{CC}$ ) is carried out by 4-point method (Fig. 7).

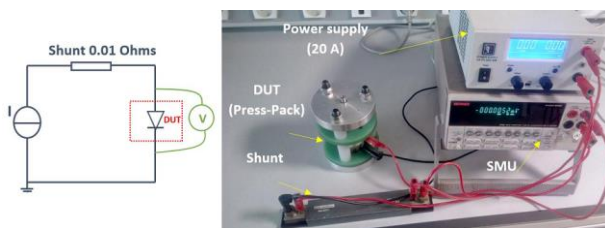

Fig. 7. Picture of the current passage test using 4-point probes method.

### 2.4. Failure analysis

After the continuous current flow test, the samples are removed from the clamping system. A first observation is made with an optical microscope (Zeiss Axio-Scope 1). When the metal foil separates naturally from the chip, the contact surfaces are observed. When the metal foil remains attached to the SiC die, a microsection is performed. In both cases, a scanning electron microscope (SEM) with elemental analysis capability (EDS) is used

for further analysis (Tescan Vega 3 with Bruker Quantax EDS probe).

## 3. Experimental Results

### 3.1. Press-Pack samples

Fig. 8 shows an example of the current and voltage recorded across one of the samples during the short-circuit operation. The tested sample are based on the structure in Fig.2a (the SiC die was in contact with a silver foil). Since diodes have a good surge current capability, large current values are required to trigger failure (here 1100 A for a 20 A-rated device). For the example below, the dissipated energy leading to the failure of the sample is estimated at 6.9 J (corresponding to an energy density of 76 J / cm<sup>2</sup>).

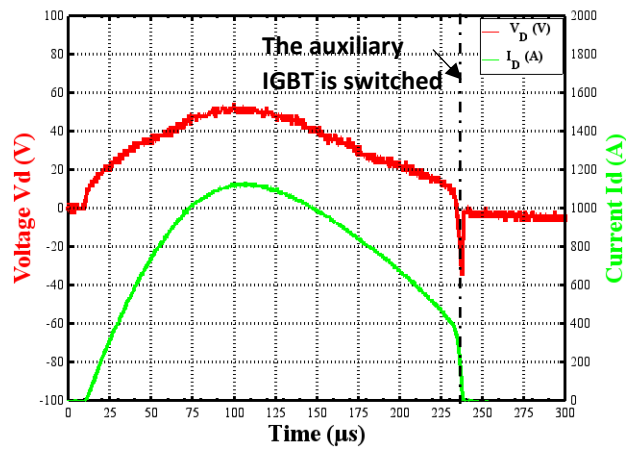

Fig. 8. Voltage and currents waveforms of sample (silver) recorded during the short circuit test @  $T_c=25^\circ\text{C}$ .

After this destructive test, the sample (still mounted in the clamping fixture) was biased with a 10 A current (continuous current flow test, as described in section 2.3). As shown in Fig.9, the short circuit failure mode is found to be stable with a constant  $R_{CC}$  value (139 m $\Omega$ ).

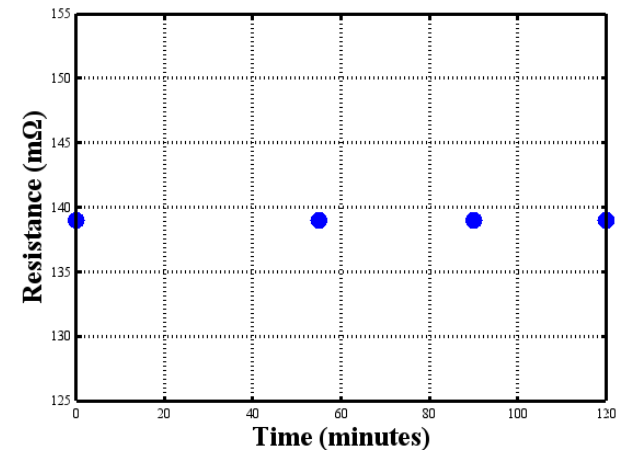

Fig. 9. Contact resistance of Ag based test sample.

Figure 10 shows an image of the sample after short-circuit destructive test and current flow test. After tests, the silver metallization remains attached to the SiC die. As shown

in Fig. 10a, the backside of the sample indicates the formation of long cracks within the SiC die.

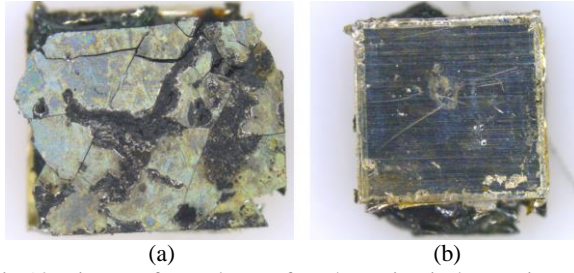

Fig.10. Picture of sample #6 after short-circuit destructive test @6.9 J and current flow test (10 A). (a) Picture of the backside of SiC die (cathode side); (b) Picture of the top side of silver foil.

Table 2 summarizes the experimental results for the different samples. 5 different configurations are tested: 4 different foil compositions (Cu, Al, Ag and Ni). In addition, one test is performed without foil, with a direct contact between the die and the molybdenum parts. Some tests are duplicated to assess their reproducibility.

#	Metal foil	$E_{sc}$ (J)	$R_i$ (mΩ)	$R_f$ (mΩ)	$t$ (min)	SCFM (Quality)
1	Mo	7.8	457	3000	45	Unstable
2	Cu	7.6	124	124	120	Stable
3	Cu	7.7	163	195	67	Unstable
4	Al	7.8	91	93	120	Stable
5	Al	7.6	418	333	67	Unstable
6	Ag	6.9	139	130	120	Stable
7	Ag	7.7	228	524	120	Unstable
8	Ni	7	134	131	120	Stable
9	Ni	7.3	179	365	73	Unstable

Table 2. Summary of the results of the short-circuit testing from all the tested samples using structure of Fig.2a.  $E_{sc}$  is the dissipated energy leading to failure,  $R_i$  refers to the initial electrical resistance after SC test, and  $R_f$  refers to the final electrical resistance measured after current flow test.  $t$  is the duration of current flow test.

### 3.2. Press-Pack samples mounted on DBC substrate

In this section, the dies are attached to a DBC substrate (using silver sintering) instead of being clamped between the molybdenum contacts. Fig. 2b shows the tested stack. Table 3 shows the results. Except for Mo (i.e. no metal foil), the electrical resistance of all the test samples after the current passage test are very close to each other and are in the range of 72 mΩ to 167 mΩ. The SCFM is found to be stable.

#	Metal foil	$E_{sc}$ (J)	$R_i$ (mΩ)	$R_f$ (mΩ)	$t$ (min)	SCFM (Quality)
10	Mo	8	433	722	40	Unstable
11	Cu	8.6	139	142	120	Stable
12	Al	7.96	179	167	120	Stable
13	Al	7.9	139	153	120	Stable
14	Ag	8	129	72	120	Stable
15	Ag	8.52	122	117	120	Stable
16	Ni	7.3	134	131	120	Stable

Table 3. Summary of the results of the short-circuit tests from

all the tested samples using structure of Fig. 2b.

The samples were then microscopically observed to analyze the location and extend of the failure. As an example, Figure 11 shows some images of sample #11. As it can be seen, a clear defect is located in the active area of the diode. A corresponding mark is also visible on the copper foil (which did not adhere to the die, as it is sometimes the case). SEM observations (Fig.12) show that a crater formed in the SiC die. Only a few, thin conductive paths were found on this crater. There is no evidence that the metal from the foil reacted with SiC of flowed to create a strong conductive path.

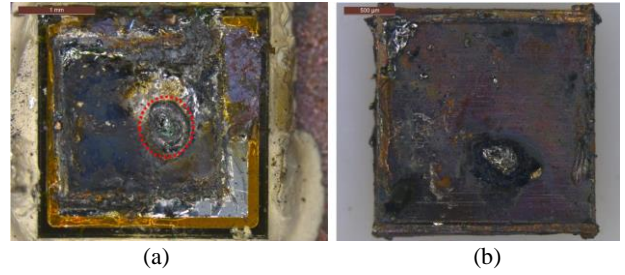

Fig. 11. Picture of sample #11 after short-circuit destructive test @8.6 J and current flow test (10 A). (a) SiC die; (b) Copper foil.

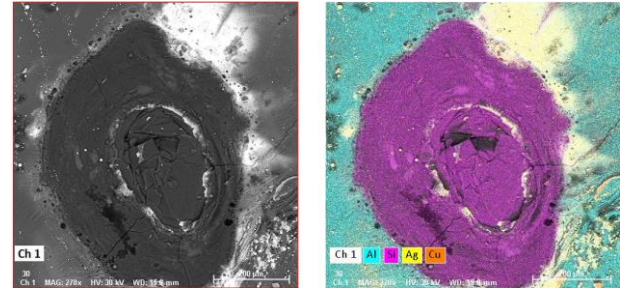

Fig. 12. SEM image of the crater formed in the SiC die.

## 4. Discussion

As shown in Table 2 and 3, the samples tested without any metal foil, and thus in a direct contact with the molybdenum blocks, do not offer a stable SCFM. The contact resistance, initially high, increased further after a few minutes of the current flow test. All the samples tested with a metal foil offer a lower initial resistance. Some of them (samples #3, #5, #7 and #9), however, do not achieve stable SCFM.

The “clamped” samples (Table 2) are found to offer unsatisfying reproducibility, as their SCFM is sometimes stable, sometimes unstable. This is not observed with the DBC-mounted dies which are always found to offer a stable SCFM (albeit on a slightly smaller sample set). The difference in reproducibility between clamped and DBC-mounted samples may be due to the condition of the die after the short-circuit test: Most of the clamped dies were found to be shattered, with many fragments missing when dismantled from the molybdenum contacts (Fig. 13).

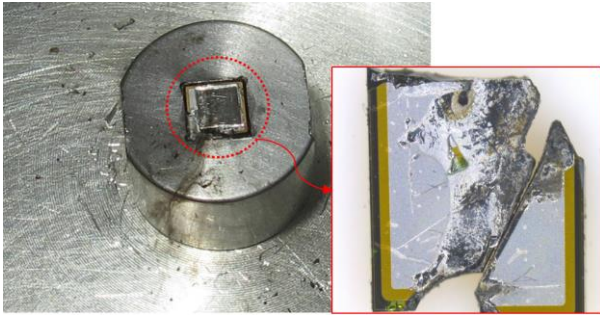

Fig. 13. Test resulting in the shattering of the SiC die. During the continuous current flow test through the sample (#7), the area of contact was further reduced. This resulted in heating of the sample and unstable short circuit ( $R_f=524\text{ m}\Omega$ ).

For the DBC-mounted samples, on the contrary, all fragments were held in place thanks to the silver die attach (Fig. 11a). Another explanation is that for the DBC-mounted samples, low-melting point metal was available from both sides of the die (metal foil on the top, silver die attach on the bottom) to help forming a conductive path.

Moreover, it should be noted that, contrary to the results presented in the literature for Si press-pack devices, we didn't observe a metallurgical reaction between the SiC and the metal foils. The conductivity after failure appears to be related to the presence of thin metal filaments through the failed die. Fig. 14 gives an example of destructive test on a sample (using silver foil) which achieved a stable short-circuit. Fig. 14 (a) shows the crater which was formed during the test. The EDX element map is shown in Fig. 14 (b). In Fig. 14 (c), the dark phase represents Si while the bright phase refers to Ag and Al. The material composition at point A is Si 11.8 at%, Ag 60.8 at%, Al 7.8 at% And C 4 at%. The composition of the materials at point B is Si 73 to%, Ag 0.85 at%, C 22 to% and Al 3.78 at%. From Fig. 14 (d), it can be clearly seen that the walls of the crater are covered with silver and aluminum (bright phase). These filaments are probably responsible for the low contact resistance of the sample after failure.

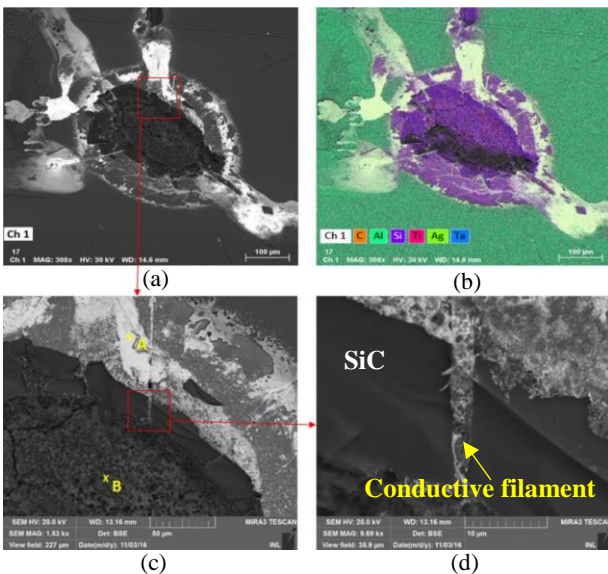

Fig. 14. SEM images of sample (using silver foil) which achieved a stable short-circuit. (a) Image of the crater formed during the destructive test, (b) EDX element map (c) Material composition of points, (d) The conductive channel.

From the experiments of Table 2 and 3, it was learned that the failure is always localized in a small area of the die, resulting in very high temperature, sufficient to create a crater in the SiC die. This crater seems to be the origin of the physical short circuit between the anode-cathode observed during the device failure (Fig. 15). In order to get a stable short-circuit, the crater walls have to be covered with with some conducting material. The use of sintered Ag joint for the SiC die attachment in combination with Ag, Ni, Cu and Al foils for the insert material has found to be sufficient to produce stable SCFM.



Fig. 15. Picture showing the location of the contact responsible for current conduction (10 A) after failure. Despite the low contact resistance ( $\sim 100\text{ m}\Omega$ ), the small size of the contact area ( $\sim 0.1\text{ mm}^2$ ) results in a very high power density, hence the light emission.

## 5. Conclusion

This paper investigates the possibility of using SiC semiconductors in press-pack package. Samples based on single diodes were tested to evaluate their SCFM capability. The tests have been followed by microscopic observations for failure analysis. The results obtained revealed that press-pack structure was able to offer a SCFM with a low initial electrical resistance (around a hundred milliohms). The challenge was to evaluate the stability of the short circuit after the failure of the chip. For that, we have performed aging tests by injecting a current into the faulty chips to observe the change in resistance over time. These tests showed that the Ag joint for the die attachment and Cu, Ni, Ag and Al foils for the top side insert material give a stable short-circuit.

## Acknowledgement

This work was supported by a grant overseen by the French National Research Agency (ANR) as part of the "Investissements d'Avenir" program (ANE-ITE-002-01)

## Reference

- [1] Gunturi, S.; Schneider, D., "On the operation of a press pack IGBT module under short circuit conditions", *Advanced Packaging, IEEE Transactions on*, vol.29, no.3, pp.433, 440, Aug. 2006.
- [2] K. Sharifabadi et Al., "Design, Control, and Application of

- MMC for HVDC Transmissions Systems”, *IEEE Press*, 2016.
- [3] F. Wakeman and G. Lockwood, “Electromechanical evaluation of a bondless pressure contact IGBT,” *IEEE Proceedings Circuits, Devices and Systems*, vol. 148, no. 2, pp. 89–93, Apr. 2001.
- [4] T. Lang and H. Zeller, “Short-circuit resistant IGBT module,” *U.S. Patent 6 426 561 B1*.
- [5] J.S Park et Al., “Kinetic control of silicon carbide/metal reactions,” *Materials science & Engineering*, 1999.
- [6] M.Backhaus-Ricoult, “Interfaces between SiC and Metals,” *Journal de Physique Colloques*, 1990.
- [7] I.Dchar, C.Buttay, H.Morel, “Avalanche Robustness of SiC Schottky diode”, *Microelectronics Reliability*, 2016.