



HAL
open science

Effect of a static magnetic field on *Escherichia coli* adhesion and orientation

Lotfi Mhamdi, Nejib Mhamdi, Naceur Mhamdi, Philippe Lejeune, Nicole Jaffrezic-Renault, Noël Burais, Riccardo Scorretti, Jiry Pokorny, Laurence Ponsonnet

► To cite this version:

Lotfi Mhamdi, Nejib Mhamdi, Naceur Mhamdi, Philippe Lejeune, Nicole Jaffrezic-Renault, et al.. Effect of a static magnetic field on *Escherichia coli* adhesion and orientation. *Canadian Journal of Microbiology*, 2016, 62 (11), pp.944-952. 10.1139/cjm-2015-0839 . hal-01546555

HAL Id: hal-01546555

<https://hal.science/hal-01546555>

Submitted on 16 Nov 2022

HAL is a multi-disciplinary open access archive for the deposit and dissemination of scientific research documents, whether they are published or not. The documents may come from teaching and research institutions in France or abroad, or from public or private research centers.

L'archive ouverte pluridisciplinaire **HAL**, est destinée au dépôt et à la diffusion de documents scientifiques de niveau recherche, publiés ou non, émanant des établissements d'enseignement et de recherche français ou étrangers, des laboratoires publics ou privés.



Distributed under a Creative Commons Attribution - NonCommercial 4.0 International License

Effect of a static magnetic field on *Escherichia coli* adhesion and orientation

Lotfi Mhamdi, Nejib Mhamdi, Naceur Mhamdi, Philippe Lejeune, Nicole Jaffrezic, Noël Burais, Riccardo Scorretti, Jiry Pokorny, and Laurence Ponsonnet

Abstract: This preliminary study focused on the effect of exposure to 0.5 T static magnetic fields on *Escherichia coli* adhesion and orientation. We investigated the difference in bacterial adhesion on the surface of glass and indium tin oxide-coated glass when exposed to a magnetic field either perpendicular or parallel to the adhesion surface (vectors of magnetic induction are perpendicular or parallel to the adhesion surface, respectively). Control cultures were simultaneously grown under identical conditions but without exposure to the magnetic field. We observed a decrease in cell adhesion after exposure to the magnetic field. Orientation of bacteria cells was affected after exposure to a parallel magnetic field. On the other hand, no effect on the orientation of bacteria cells was observed after exposure to a perpendicular magnetic field.

Key words: static magnetic field, cell adhesion and orientation, *Escherichia coli*, fluorescence microscopy.

Résumé : Cette étude préliminaire a abordé l'impact de l'exposition des champs magnétiques statiques de 0,5 T sur l'adhérence d'*Escherichia coli*. Nous avons examiné la différence d'adhérence bactérienne sur une surface de verre et de verre recouvert d'oxyde d'indium-étain lors d'une exposition à un champ magnétique perpendiculaire ou parallèle à la surface d'adhésion (les vecteurs d'induction magnétique étant perpendiculaires ou parallèles à la surface d'adhérence, respectivement). Les cultures témoins ont été cultivées en simultanément dans des conditions identiques, mais sans exposition à un champ magnétique. Nous avons observé une baisse de l'adhérence cellulaire après une exposition au champ magnétique. L'orientation des cellules bactériennes a été affectée par l'exposition à un champ magnétique parallèle. En contrepartie, on n'a observé aucune incidence sur l'orientation des cellules bactériennes des suites d'une exposition à un champ magnétique perpendiculaire. [Traduit par la Rédaction]

Mots-clés : champ magnétique statique, adhérence et orientation cellulaires, *Escherichia coli*, microscopie à fluorescence.

Introduction

The problem of bacteria attachment to abiotic surfaces has been investigated by many authors to well understand the physical and biological changes that can occur in the bacteria-surface interface when adhering. The main purpose of our study was to investigate the effects of a 0.5 T static magnetic field (SMF) on adhesion of a mutant *Escherichia coli* on 2 different abiotic surfaces. For this purpose, we used glass slides coated with thin semiconductor indium tin oxide (ITO) and a genetically modified hyperadherent and fluorescent *E. coli* K-12 strain PHL969.

We used *E. coli* because it is easy to manipulate. For an adhesion surface, we chose a semiconductor surface —

ITO-coated glass — in view of the fact that we planned to study the electrochemical kinetics of bacterial adhesion by means of impedance spectroscopy and we wanted to ensure fast cover of surface with bacteria cells.

According to recommendations from the European Union, SMFs below 0.5 T are commonly considered quite safe for humans (Potenza et al. 2004) and no authorization is required for installation and use of machinery with fields below 0.5 T. Therefore, we have taken this recommendation into account in choosing the applied magnetic field induction of 0.5 T.

Since wild-type *E. coli* K-12 strains are not able to attach to surfaces (Vidal et al. 1998), they were previously genet-

L. Mhamdi. Institut de Biotechnologie de Monastir, B.P. 74, Avenue Tahar Haddad, 5000 Monastir, Tunisie.

Nejib Mhamdi. Ecole polytechnique de Montréal, Montréal, QC, Canada.

Naceur Mhamdi. INAT, Tunis, Tunisie.

P. Lejeune. Unité de Microbiologie et Génétique, UMR CNRS 5122, Villeurbanne, France.

N. Jaffrezic, N. Burais, and R. Scorretti. Laboratoire Ampère, Université Lyon 1, 69622 Villeurbanne CEDEX, Lyon, France.

J. Pokorny. Institute of Photonics and Electronics, Academy of Sciences of Czech Republic, Chaberska 57, 18251 Prague 8, Czech Republic.

L. Ponsonnet. Laboratoire des Polymères, Biopolymères et Membranes, UMR CNRS, 6522, Rouen, France.

Corresponding author: Lotfi Mhamdi (email: lotfi.mhamdi@gmail.com).

ically modified to acquire the ability to colonize inert surfaces. This modification consists of an overproduction of curli, a particular class of pili resulting from a single-point mutation obtained after the replacement of a leucine by an arginine residue at position 43 in the regulatory protein OmpR. The *ompR234* allele increases the expression of *csgA*, the curlin-encoding gene, and the resulting overproduction of curli confers the adherence properties (Vidal et al. 1998). These results showed that curli are morphological structures of major importance for cell adhesion to inert surfaces and surface colonization and biofilm formation. This work also indicated that curli synthesis is under the control of the EnvZ–OmpR 2-component regulatory system.

According to Marshall (1992), it seems that the first contact between bacteria and a surface implicates weak chemical bonds, and therefore, the bacteria can be removed from the surface after washing. This is called reversible adhesion. The efficiency of the “collision” between a bacterium and the surface depends on the culture conditions in the liquid phase (some parameters of the used broth can affect the envelope structure which can interact with that surface). It also depends on the substrate surface physicochemical state (Lejeune 2003). Particular structures of the bacterial envelope-like fimbriae (i.e., curli) and adhesins have been described as essential for the reversible adhesion accomplishment (Vidal et al. 1998).

Once the first stage of adhesion is established, the “surface-sensing” process takes place and bacteria start to acquire information about the surface characteristics via their regulating and perceptive mechanisms. In the case of *E. coli*, curli synthesis is being reinforced and colanic acid exopolysaccharide secretion starts (Prigent-Combaret et al. 2000). This adhesion step represents the irreversible adhesion, and colanic acid production is a fundamental parameter involved in this process. The end of the irreversible adhesion is characterized by the formation of a slimy layer on the colonized surface, called biofilm, as a result of bacterial multiplication and production of extracellular polymers (Marshall et al. 1971).

According to Zobell (1943), immersion of a clean substratum in a natural fluid is immediately followed by fast and efficient adsorption of organic molecules to the surface, forming the so-called “conditioning film”. Two types of bacterial interaction are then possible: (i) weak chemical bonding between the bacterial envelope and the solid surface (or the conditioning film) and (ii) bridging mediated by specialized bacterial structures of adhesion.

Increasing attention is being paid to the effect of magnetic field (MF) on the biological system, and changes have been proved at different levels. Indeed, many studies have demonstrated an effect on cell adherence, metabolism, and genetic activity. Some investigations have been performed under low MF using prokaryotic cells by

studying their viability (Strašák et al. 2002), their growth (Ramon et al. 1981; Unal et al. 2002; Aronsson et al. 2001; Dutreux et al. 2000; Matronchik et al. 1996), their orientation (Ignatov et al. 2002; Seelig et al. (1985), protein synthesis (Nakasono and Saki 2000), protein activity (Dutta et al. 1994), ATP (adenosine triphosphate) synthesis (Zrimec et al. 2002), and a possible mutation at the genetic level (Nakasono et al. 2000).

In this preliminary study, we investigate the effect of a static 0.5 T magnetic field on the adhesion and orientation of a genetically transformed *E. coli* strain. The adhesion surfaces used are ITO-coated glass and glass plates. The results of this study point to a new pathway to *E. coli* adhesion inhibition and, therefore, biofilm formation restriction.

Materials and methods

Bacterial strain and growth conditions

The hyperadherent and fluorescent *E. coli* K-12 strain PHL969, a mutant derived from MG1655 *E. coli* K-12 strain and containing the pGFP plasmid bought from Clontech, was used according to a previous study of Lejeune (2003). This is a bacterium with an important adherence property thanks to the fusion of curli (adhesion fimbriae) and a plasmid referred to as pGFP (contains a gene of resistance to ampicillin and a gene coding for the “Green Fluorescent Protein” of *Aequorea victoria* medusa). This strain was cultivated overnight at 29 °C in Luria–Bertani (LB) medium. Then, 0.1 mL of the culture was inoculated into 1:2 diluted LB (½ LB) medium (0.1 mL strain PHL969 + 2.5 mL ½ LB + 2.5 mL sterile water) in a 18-mm-diameter test tube and incubated, with the ITO-coated glass, at 29 °C at 45 strokes per minute for 24 h before exposure to a 0.5 T MF for 30 min. Therefore, the bacteria used are in the stationary growth phase.

The LB medium used contains (per litre of distilled water, pH 7) 10 g of tryptone, 10 g of yeast extract, and 5 g of NaCl, and cells reached a concentration of 10^9 /mm. The conductivity of this medium is $\sigma = 19.2$ mS/cm. Three test tubes containing cells, medium, and the substrate were prepared, as cited above, and used as follows: 1 test tube for the application of a parallel MF (whose direction of the induction (**B**) is parallel to the surface where bacteria are adhered), 1 test tube for exposure to a perpendicular MF (with direction of the induction **B** perpendicular to the adhesion surface), and 1 test tube for control (no MF applied). Note that the direction of the lines of magnetic flux is always parallel to the laboratory ground, only the plate positions within the test tubes were changed so that the lines of magnetic flux are perpendicular or parallel to the adhesion surface.

Abiotic surface preparation for *E. coli* colonization

Glass substrates (1 cm²) coated with 110-nm-thick semiconductor ITO films (resistance <20 Ω/cm²) were used in this study (purchased from Merck Display Technologies). Before bacterial culture, the plates were previously

Fig. 1. Schematic view of the apparatus for magnetic field exposure. Horizontal arrows show the direction of the induction (B) of the applied magnetic field. The colonized substrate position in the test tube is chosen in such a way that lines of magnetic flux arrive parallel (a) or perpendicular (b) to the sample surface.

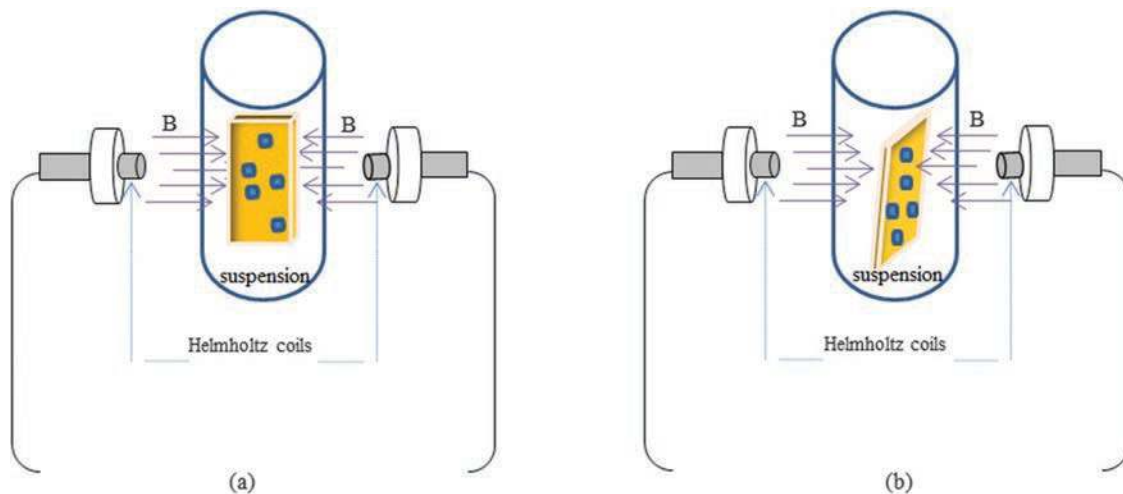

cleaned by ultrasonication — twice in 2% Fluka cleaning (ref 61257) solution for 30 min and then twice in ultrapure water (Millipore-Q-Systems: $R > 18 \text{ M}\Omega/\text{cm}$) for 30 min. Each sonication step was followed by 10 rinsing cycles in ultrapure water (Tlili et al. 2003). The probes were dried under a nitrogen flow, UV sterilized (UV lamp 254 nm, 60 W, Bioblock, France) for 10 min, and finally plunged into the test tube with the *E. coli* suspension cultivated under the conditions described above.

MF application

Cells were exposed to a SMF for 30 min as specified, at laboratory temperature (about 25 °C). A continuous magnetic induction of 0.5 T in the horizontal direction with the ground was applied using Helmholtz coils powered by a regulated DC power supply, and the magnetic induction was measured using a Hall Effect probe Gauss meter (Lakeshore 410 Gauss meter). The test tube containing the colonized surface was placed between the air gap and oriented in such a way that the surface will be exposed to a parallel or perpendicular MF (Figs. 1a and 1b, respectively). At the end of exposure, a thermometer was plunged into the *E. coli* suspension to control change in temperature near the sample during the exposure to the MF.

To verify the homogeneity of the applied MF, the electromagnetic system has been simulated using Flux 3D (Finite Element electromagnetic software, CEDRAT) (Fig. 2).

Indeed, to check whether the colonized surface has been exposed to a homogeneous MF, the experimental system (magnetic core, coils, and air gap) has been simulated for an arbitrary value of the excitation current. The simulation has been performed with the only purpose being to check that the exposure field is homogeneous (i.e., to obtain the spatial distribution of the field) and not to compute the precise value of the intensity of the MF, which has been experimentally measured by a

Fig. 2. Geometry of the exposure device modelled by Finite Elements using the commercial software Flux 3D (only a quarter of the geometry is represented). This system is composed of a steel core, an adjustable air gap, and 2 excitation coils, which have been supplied by a continuous current.

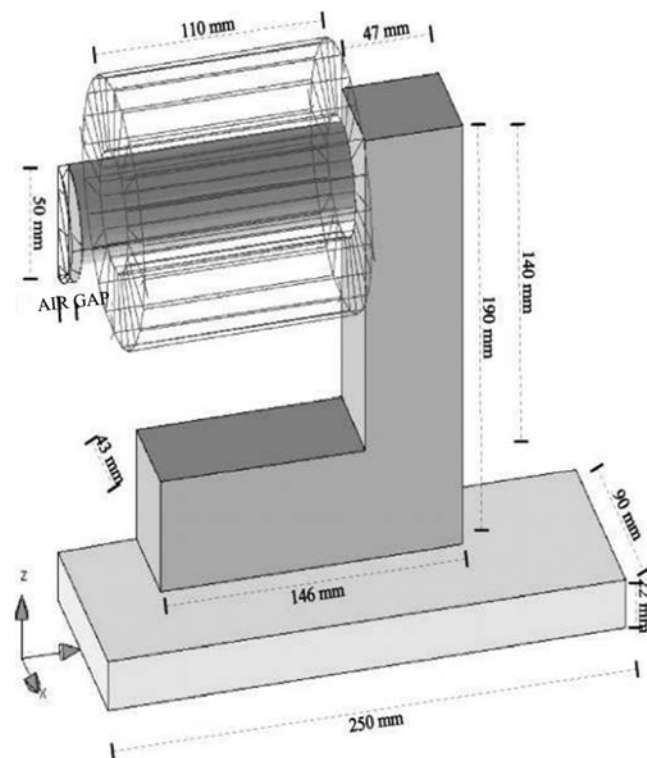

Gauss meter. A constant value of the exposure field has been observed in the area where the colonized surface was exposed to the MF, which means that the applied MF is homogeneous (Fig. 3). For this type of exposure, variations of the earth's MF were not taken into account because they are negligible compared with the applied MF.

Fig. 3. Simulation of the magnetic flux density B (in Tesla) in the air gap of the magnetic field exposure system by Flux 3D software (air gap = 18 mm represents the test tube diameter containing the cell medium and the sample). The spatial distribution of the magnetic flux density B in the middle of the air gap is plotted (only half of the geometry is plotted). One observes a constant value of B in the area corresponding to the tube section, which confirms that the colonized surface has been exposed to a homogeneous field. The axis units are normalized to 1.

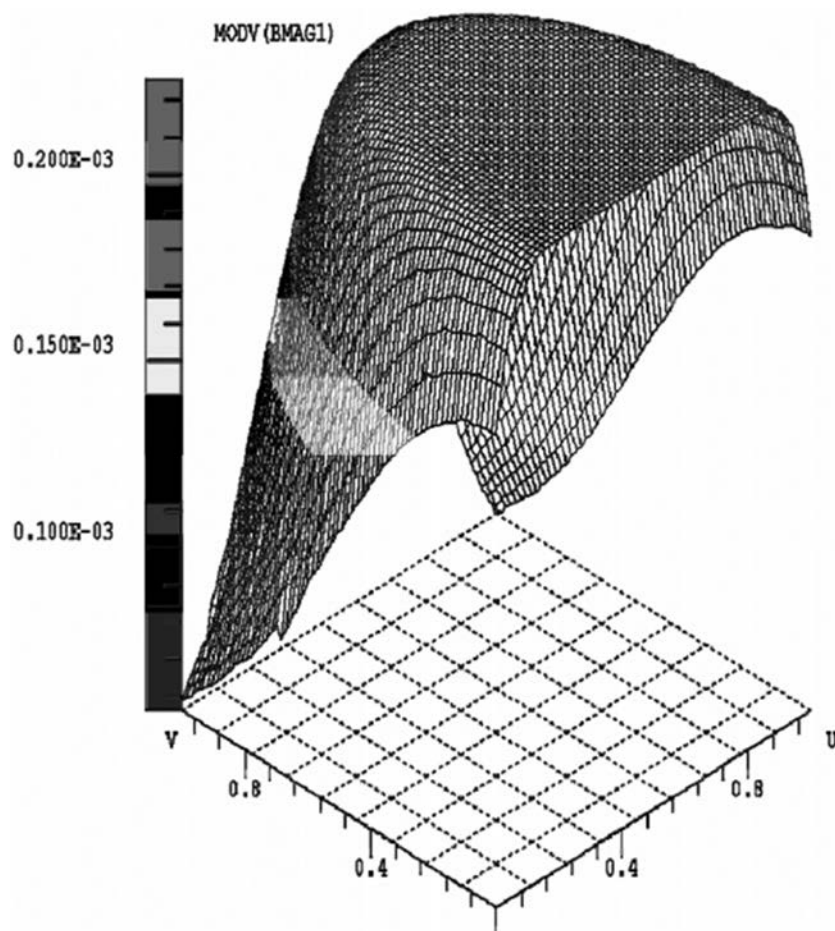

Bacterial observation and quantification

Exposed and control (nonexposed to the MF) *E. coli* K-12 strain PHL969 were observed using a fluorescence microscopy (Axiovert 40 CFL, Zeiss) and photographs were stored for an eye counting of the adhered bacteria. The colonized probe was removed from the test tube after 30 min of exposure to the MF, then placed on a microscope coverslip and aired for 10–15 min before observation under microscope.

Escherichia coli K-12 strain PHL969 is a derivative of *E. coli* K-12 strain MG1655, which contains the pGFP plasmid. The green fluorescent protein plasmid pGFP is involved in the fluorescence character of the *E. coli* strain used in this study. pGFP is a 3.3 kb plasmid with a gene of resistance to ampicillin and a gene coding for the “Green Fluorescent Protein” of *Aequorea victoria* medusa. This last gene is inserted into the plasmid under the control of a conductive promoter (P_{lac}) but the basic expression level is so high that fluorescence is visible under fluorescent microscopy in every culture condition in absence of induction.

GFP is an autofluorescent protein characterized by 2 absorption frequency bands: 397 and 475 nm. Its excitation at these wavelengths generates a typical green fluorescence emission with a peak of 508 nm.

Bacterial adhesion and orientation were analyzed by means of the counting method presented in Fig. 4. Bacteria orientation was classified according to 3 angle values: 45°, 90°, and 180° toward the dashed arrow in Fig. 4. This fictitious line was drawn with respect to the probe’s position into the test tube while exposed to the MF to have photographs representative of the colonized surfaces exposed to MF.

Statistical analyses

Data was statistically analyzed using the SAS statistical package, version 9.1 for Windows (SAS Institute Inc. 2004). Differences in mean values for surface were examined with a t test. Analysis of variance (ANOVA) using the General Linear Models procedure with Duncan’s test and least significant difference (LSD). Differences of $p < 0.05$

Fig. 4. *Escherichia coli* bacteria (in green fluorescent) photography showing the counting method for the orientation study. Bacteria having an angle of 45°, 90°, and 180° towards the fictitious line (dashed arrow) were counted. Note that for the scale, the bar (2 cm) represents 10 μm. [Colour online.]

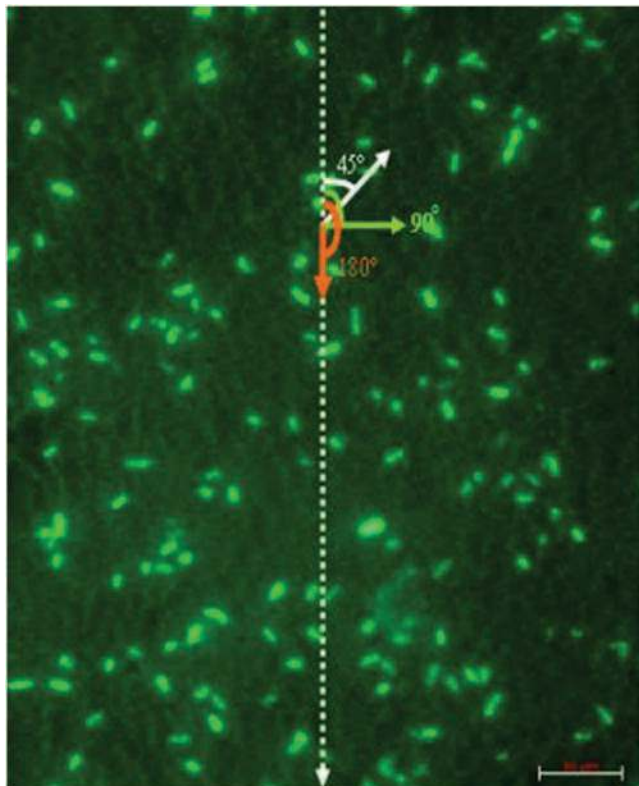

were considered statistically significant. All of the results are expressed as the means \pm standard deviation.

The equation of the model is

$$Y_{ijk} = \mu + S_i + F_j + S * F_{ij} + e_{ijk}$$

where Y_{ijk} = measured variables, μ = means value of measured variables, S_i = fixed effect of surface ($i = 1$ and 2), F_j = fixed effect of magnetic field ($j = 1, 2,$ and 3), $S * F_{ij}$ = fixed effect of the surface inside magnetic field ($ij = 1, 2,$ and 3), and e_{ijk} = residuals.

Results

We exposed *E. coli* bacteria, previously adhering to ITO semiconducting surface and glass plates, to a 0.5 T SMF. Data show a significant decrease ($p < 0.0241$) in cell adhesion after exposure to MF compared with the control. Cell adhesion is dependent on the surface type (glass or ITO) and on the direction of magnetic induction toward the colonized surface (parallel or perpendicular). No significant change was observed in temperature near the sample during the exposure to the MF.

Each experiment was repeated 4 times, and reproducibility was confirmed.

As can be seen in Fig. 5, before exposure to the MF, we noticed more adhered cells on glass than on ITO-coated glass plates. However, after exposure we observed a decrease in the number of adhered bacteria on both surfaces, with an evident dependence on the direction of the magnetic induction towards the surface colonized by the cell (Fig. 5).

Indeed, our results revealed more adhered cells after exposure to a perpendicular MF, with a tendency to adhere more to the ITO surface. On the other hand, we found nearly the same number of adhered cells for both surfaces under parallel MF.

To quantify the relative effect of MF on surface decolonization, the rate of decolonized bacteria D (%) = $100 \times (N_0 - N)/N_0$, where N_0 represents the number of adhered bacteria before exposure to MF, and N represents the number of adhered bacteria after exposure.

A summary of the surface decolonization rate, representing a decrease in the number of adhered bacteria, is reported in Fig. 6.

Cell detachment depends on surface and MF types for the same bacteria strain (*E. coli*). Data show a positive decolonization rate, on both glass and ITO substrates, after exposure to a parallel MF (ITO-parallel MF and glass-parallel MF).

Indeed, one can observe more detached cells (decrease in the number of adhered bacteria) on both surfaces after exposure to a parallel MF (ITO-parallel MF and glass-parallel MF) and a small effect after exposure to a perpendicular MF in the case of indium tin oxide (ITO-perpendicular MF). Thus, according to these results we can conclude that exposure to a parallel MF has a better effect on *E. coli* decolonization from ITO and glass than does exposure to a perpendicular MF.

Results on cell orientation analysis indicate that there was a significant decrease in the number of bacteria adhering to ITO and oriented perpendicularly (90°) to the lines of magnetic flux, and after exposure to parallel MF compared with the control (Fig. 7). However, no effect has been reported ($p < 0.0812$) and no difference ($p < 0.0785$) with nonexposed cells has been found for glass. Surprisingly, no significant effect was observed after exposure to a perpendicular MF, and we observed practically the same orientation attitude and number of oriented cells as in the control assay.

Discussion

These results show a clear effect of a 0.5 T homogeneous MF on adhesion of *E. coli* to glass slides coated with the semi-conductor ITO and glass surfaces. Indeed, our data provided evidence that *E. coli* adhesion depends on the surface type and on the direction of the magnetic induction B . Exposure to MF decreased the number of adhered cells compared with the control samples (before exposure). Moreover, there were more adhered cells af-

Fig. 5. Dependence of *Escherichia coli* adhesion on the surface type and on the direction of the magnetic induction **B**. Exposure to a magnetic field (MF) decreased the number of adhered cells. We note more adhered cells after exposure to the perpendicular MF than to parallel MF compared with the control samples. ITO, indium tin oxide.

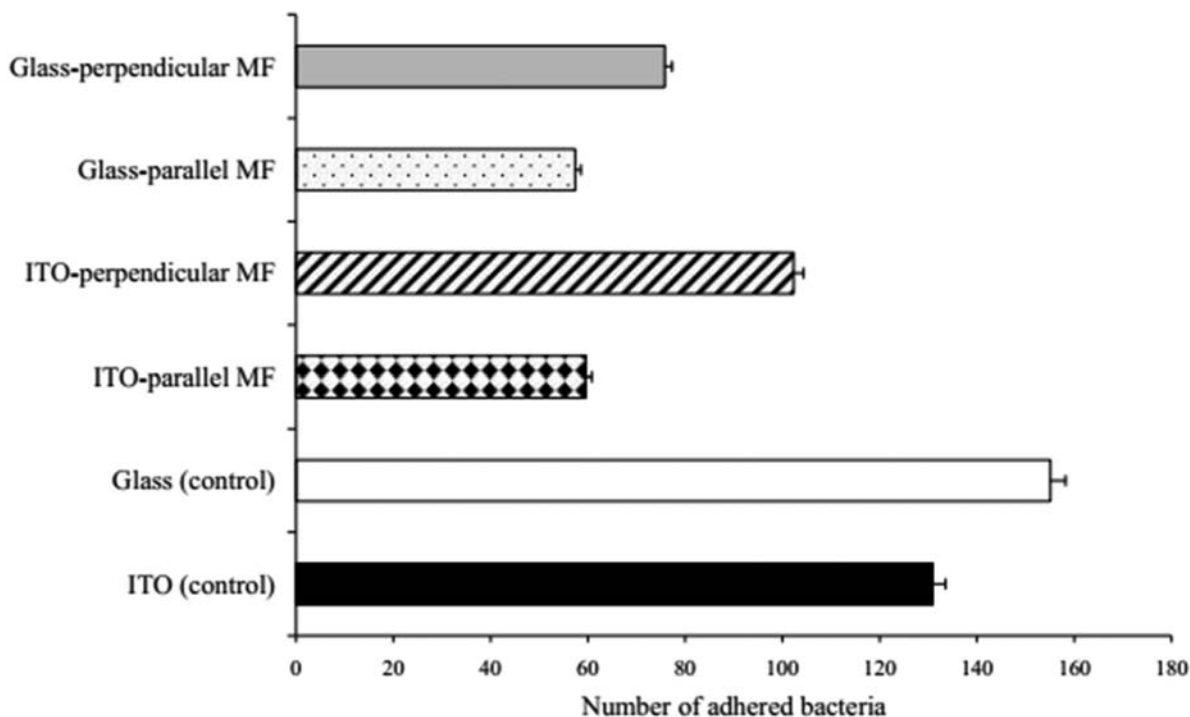
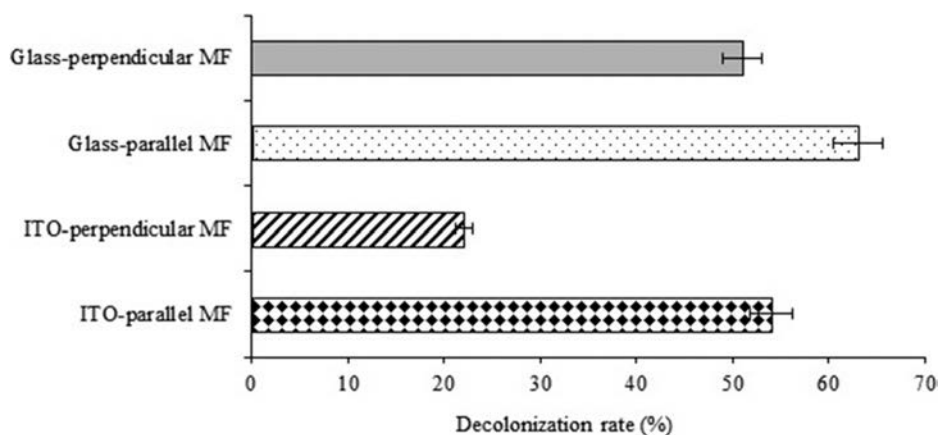

Fig. 6. Surface *Escherichia coli* decolonization rate after exposure to a magnetic field (MF). ITO-parallel MF, Glass-parallel MF, and ITO-perpendicular MF, Glass-perpendicular MF represent the indium tin oxide (ITO) and glass colonized surfaces exposed to parallel and perpendicular magnetic fields, respectively. Cell detachment depends on surface and magnetic field types for the same bacteria strain (*E. coli*). Data show a positive decolonization rate, on both glass and ITO substrates, after exposure to parallel MF (ITO-parallel MF and glass-parallel MF). However, one can observe the small decolonization effect of perpendicular MF on *E. coli* adhering to ITO (ITO-perpendicular MF).



ter exposure to a perpendicular MF than to a parallel MF (see Fig. 5).

Furthermore, we evaluated *E. coli* decolonization rate after exposure to MF and found that cell detachment depends on surface and MF types for the same bacteria strain (*E. coli*). In fact, we observed a positive decolonization rate on both glass and ITO substrates after exposure to a parallel MF (see Fig. 6). However, one can observe the small decolonization effect of a perpendicular MF on *E. coli* adhering to ITO.

MF did not affect cells oriented parallel (180°) to the magnetic induction at both surfaces (see Fig. 7). There was no significant difference in comparison with control samples. Furthermore, no MF effect was shown on cells oriented 45° with the direction of the magnetic induction, which seems to be the preferential orientation for *E. coli* on solid surfaces. However, the number of cells oriented perpendicularly (90°) to the direction of the magnetic induction has decreased up to the half after exposure to a parallel MF in the case of ITO.

Fig. 7. *Escherichia coli* orientation toward the vector of the magnetic induction \mathbf{B} . Magnetic field did not affect cells oriented parallel (180°) to the magnetic induction at both surfaces (no significant difference in comparison with control samples). The same result can be shown with cells having an angle equal to 45° with the direction of the magnetic induction, which seems to be the preferential orientation for *E. coli* on solid surfaces. However, the number of cells oriented perpendicularly (90°) to the direction of the magnetic induction has decreased up to the half after exposure to parallel magnetic field in the case of indium tin oxide (ITO, \diamond).

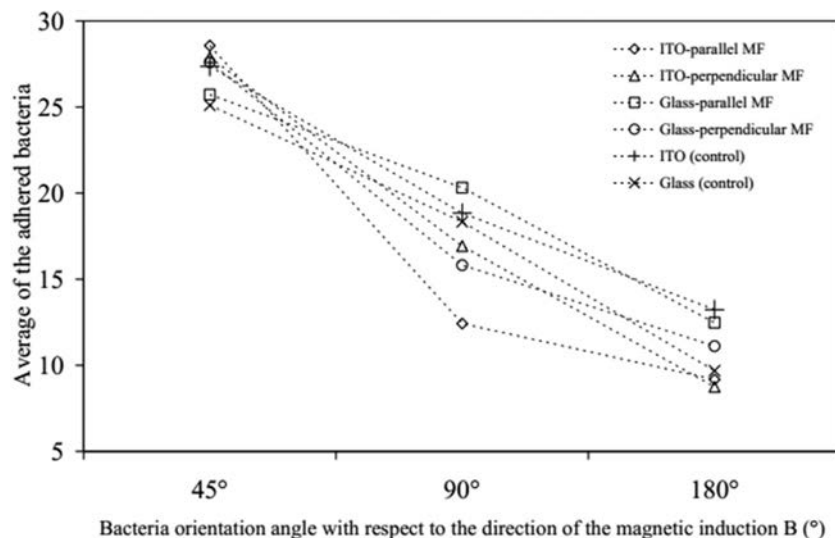

As ITO and glass plates have different chemical compositions and physical properties, we can conclude that these observations are in agreement with the prediction of [Andrade et al. \(1983\)](#), who suggested the dependence of cell adhesion on the physicochemical properties of the surface. One can see that there probably were stronger physicochemical interactions (electrostatic, Van Der Waals, hydrogen bonds...) that took place between *E. coli* and ITO surface after application of a perpendicular MF. Hydrodynamic interactions cause the extended interaction of cells and with surfaces ([Ramia et al. 1993](#)).

It is known that a magnetic force, F , acting on a moving charge has a magnitude given by [Crowell \(2002\)](#):

$$|F| = q|\mathbf{v}||\mathbf{B}|\sin \theta$$

where \mathbf{v} is the particle velocity vector, q represents its charge, \mathbf{B} is magnetic induction, and θ is the angle between the \mathbf{v} and \mathbf{B} vectors. The force is always perpendicular to both \mathbf{v} and \mathbf{B} . Given 2 vectors, there is only 1 line perpendicular to both of them, so the force vector points in 1 of the 2 possible directions along this line. Therefore, this theory may explain the differences in *E. coli* adhesion and orientation found after exposure to perpendicular and parallel MFs.

The homogeneity or inhomogeneity of a MF has been shown to play a role in bacterial adhesion on surfaces. Indeed, many studies have mentioned different effects for 5.2–6.1 T inhomogeneous high MFs ([Horiuchi et al. 2002](#)), 3.2–6.7 T inhomogeneous MFs, and 7 T homogeneous MFs on *E. coli* viability ([Tsuchiya et al. 1996](#)). In this study, the colonized surfaces were exposed to a homogeneous MF.

[Tsuchiya et al. \(1996\)](#) presumed that a 7 T MF affects the cells of the bacterium differently, depending on the growth phases. Indeed, it is known that cells contain many components and factors that are oversensitive to high MFs, such as ion solutions, water ([Ueno and Iwasaka 1994](#)), macromolecules (e.g., proteins), lipids in membrane ([Speyer et al. 1987](#)), and nucleic acids ([Maret et al. 1975](#)). Since the extracellular substances and chemical conditions in the culture broth are constantly changing and thus giving rise to metabolic differences between logarithmic- and stationary-phase cells, it is believable that the effects of high MFs on bacteria differ, depending on the bacterium growth phase. In this study, bacteria were used at the stationary phase.

The aim of the present research was to study a 0.5 T homogeneous MF on *E. coli* adhesion and orientation. Other studies were performed to see possible effects on gene expression and DNA. For this purpose, [Potenza et al. \(2004\)](#) concluded that a 300 mT SMF can influence cell growth and gene expression. They speculated that it can perturb DNA stability interacting with DNA directly or can potentiate the activity of oxidant radicals. [Ikehata et al. \(1999\)](#) examined possible mutagenic and comutagenic effects of strong SMFs using the bacterial mutagenicity test. No mutagenic effect of SMFs up to 5 T was detected.

In our study, the existence of an important number of adhered cells under a perpendicular MF (compared with the number under a parallel MF) may be due to the exposure duration. Probably, 30 min of exposure were not sufficient for bacterial desorption in these experimental conditions, whereas it should be a sufficient period of

time to enable a parallel MF to modify the physicochemical properties of the cell-surface interface.

In the literature, it has been shown that an applied magnetic field at a well-defined strength needs certainly precise exposure duration to have an effective effect (Ishizaki et al. 2001; Belyaev et al. 1998). In other words, each MF strength has its own effective exposure duration. Thereby, the MF strength and the exposure time are significant parameters in cell response to magnetic stress. Strašák et al. (2002) think that the effect of 2.7–10 mT MFs on cells may be due to a change in the ion transport into the cells and a possible formation of free radicals after the exposure to MF.

Binhi et al. (2001) suggested that DNA transcription and conformation state greatly influence the effect of MF on *E. coli*. They concluded that MF could affect the dissociation probability of some ions and the ion–protein complex attachment to the DNA strands, which are rotating at a low speed.

According to Harshey (2003), the motion of bacteria close to surfaces is relevant to understanding the early stages of biofilm formation and of pathogenic infection. For this purpose, we studied the orientation of bacteria adhering on ITO and glass surfaces after exposure to MF.

Frymier et al. (1995) presume that individual *E. coli* cells swim in clockwise, circular trajectories near planar glass surfaces. Moreover, according to Vigeant and Ford (1997), bacteria swim in circles at surfaces for seconds to minutes, although one can expect them to drift from the surface quickly because of the effects of the rotational Brownian motion and bundle fluctuation on their trajectories. Lowe et al. (1987) studied the element responsible for *E. coli* movement. Indeed, they assume that the classical example of rotation in *E. coli* is a rotary flagellar motor. According to these authors, several filaments come together to form a bundle that rotates at a speed around 300 rev/s and drives the cell body forward at speeds of a few tens of microns per second. The cell body counter-rotates at several revolutions per second. Therefore, when a cell swims close to a planar surface, the flagellar bundle and the cell body rotations as well as surface resistance (roughness, heterogeneity) affect the direction of movement (DiLuzio et al. 2005).

Prigent-Combaret et al. (1999) suggested that cell-to-cell signals may be involved in regulation of gene expression. Hence, cell density seems to be an important parameter for bacterial adhesion on solid surfaces and thus for their orientation under external stress agent.

One can conclude that MF effects on the behaviour of bacteria depend also on the bacterial strain, the induction values, and the exposure time.

Conclusion

Regarding the results reported in the present study, one can conclude that 0.5 T MF have an effect on *E. coli* adhesion and orientation. Indeed, our data revealed dif-

ferent effects depending on the surface and on the direction of the magnetic induction toward that surface. Moreover, there were more adhered cells under perpendicular MF than under parallel MF. Cell orientation was affected especially under parallel MF. Summarizing, 0.5 mT MF can be used to stimulate *E. coli* desorption while adhering on indium tin oxide and glass surfaces, and therefore may constitute an important and useful pathway for *E. coli* adhesion inhibition and therefore biofilm formation restriction.

Acknowledgements

The authors thank the Rhône-Alpes Region for financial support. Naceur Mhamdi from INAT, Tunisia, was responsible for statistical studies. The authors declare no conflicts of interest.

References

- Andrade, J.D., Gregonis, D.E., and Smith, L.M. 1983. Polymer surface dynamics. In Surface and interfacial aspects of biomedical polymers. Vol. 1. Edited by J.D. Andrade. Plenum Press, New York. pp. 15–41. doi:10.1007/978-1-4684-8610-0_2.
- Aronsson, K., Lindegren, M., Johansson, B.R., and Rönner, U. 2001. Inactivation of micro-organisms using pulsed electric fields: the influence of process parameters on *Escherichia coli*, *Listeria innocua*, *Leuconostoc mesenteroides* and *Saccharomyces cerevisiae*. Innovative Food Sci. Emerging Technol. 2(1): 41–54. doi:10.1016/S1466-8564(01)00021-2.
- Belyaev, I.Y., Alipov, Y.D., and Matrncnik, A.Y. 1998. Cell density dependent response of *E. coli* cells to weak ELF magnetic fields. Bioelectromagnetics, 19: 300–309. doi:10.1002/(SICI)1521-186X(1998)19:5<300::AID-BEM4>3.0.CO;2-5.
- Binhi, V.N., Alipov, Y.D., and Belyaev, I.Y. 2001. Effects of static magnetic field on *E. coli* cells and individual rotations of ion–protein complexes. Bioelectromagnetics, 22(2): 79–86. doi:10.1002/1521-186X(200102)22:2<79::AID-BEM1009>3.0.CO;2-7.
- Crowell, B. 2002. Electricity and magnetism. Ed. 2.1. Light and Matter, Fullerton, Calif., USA.
- DiLuzio, W.R., Turner, L., Mayer, M., Garstecki, P., Weibel, D.B., Berg, H.C., and Whitesides, G.M. 2005. *Escherichia coli* swim on the right-hand side. Nature, 435: 1271–1274. doi:10.1038/nature03660. PMID:15988531.
- Dutreux, N., Notermans, S., Wijtzes, T., Góngora-Nieto, M.M., Barbosa-Cánovas, G.V., and Swanson, B.G. 2000. Pulsed electric fields inactivation of attached and free-living *Escherichia coli* and *Listeria innocua* under several conditions. Int. J. Food Microbiol. 54(1–2): 91–98. doi:10.1016/S0168-1605(99)00175-0. PMID:10746578.
- Dutta, S.K., Verma, M., and Blackman, C.F. 1994. Frequency-dependent alterations in enolase activity in *Escherichia coli* caused by exposure to electric and magnetic fields. Bioelectromagnetics, 15(5): 377–383. doi:10.1002/bem.2250150502. PMID:7802706.
- Frymier, P.D., Ford, R.M., Berg, H.C., and Cummings, P.T. 1995. Three-dimensional tracking of motile bacteria near a solid planar surface. Proc. Natl. Acad. Sci. U.S.A. 92: 6195–6199. doi:10.1073/pnas.92.13.6195. PMID:7597100.
- Harshey, R.M. 2003. Bacterial motility on a surface: many ways to a common goal. Annu. Rev. Microbiol. 57: 249–273. doi:10.1146/annurev.micro.57.030502.091014. PMID:14527279.
- Horiuchi, S., Ishizaki, Y., Okuno, K., Ano, T., and Shoda, M. 2002. Change in broth culture is associated with significant suppression of *Escherichia coli* death under high magnetic field. Bioelectrochemistry, 57: 139–144. doi:10.1016/S1567-5394(02)00111-1. PMID:12160610.

- Ignatov, O.V., Griбанова, Y.S., Shchegolev, S.Y., Benin, V.D., and Ignatov, V.V. 2002. The electro-optical investigation of suspensions of *Escherichia coli* K-12 cells metabolizing glucose, lactose, and galactose. *Microbiology*, **71**(3): 302–306. doi:10.1023/A:1015854611552.
- Ikehata, M., Koana, T., Suzuki, Y., Shimizu, H., and Nakagawa, M. 1999. Mutagenicity and co-mutagenicity of static magnetic fields detected by bacterial mutation assay. *Mutat. Res.* **427**(2): 147–156.
- Ishizaki, Y., Horiuchi, S., Okuno, K., Ano, T., and Shoda, M. 2001. Twelve hours exposure to inhomogeneous high magnetic field after logarithmic growth phase is sufficient for drastic suppression of *Escherichia coli* death. *Bioelectrochemistry*, **54**: 101–105. doi:10.1016/S1567-5394(01)00108-6. PMID:11694389.
- Lejeune, P. 2003. Contamination of abiotic surfaces: what a colonizing bacterium sees and how to blur it. *Trends Microbiol.* **11**: 179–184. doi:10.1016/S0966-842X(03)00047-7. PMID:12706996.
- Lowe, G., Meister, M., and Berg, H.C. 1987. Rapid rotation of flagellar bundles in swimming bacteria. *Nature*, **325**: 637–640. doi:10.1038/325637a0.
- Marshall, K.C. 1992. Biofilms: an overview of bacterial adhesion, activity, and control at surfaces. *American Society for Microbiology News*, **58**: 202–207.
- Marshall, K.C., Stout, R., and Mitchell, R. 1971. Mechanism of the initial events in the sorption of marine bacteria to surfaces. *J. Gen. Microbiol.* **68**: 337–348. doi:10.1099/00221287-68-3-337.
- Maret, G., Schickfus, M.v., Mayer, A., and Dransfeld, K. 1975. Orientation of nucleic acids in high magnetic fields. *Phys. Rev. Lett.* **35**: 397–400. doi:10.1103/PhysRevLett.35.397.
- Matronchik, A., Alipov, E.D., and Belyaev, I. 1996. A model of phase modulation of high frequency nucleoid oscillations in reactions of *E. coli* cells to weak static and low-frequency magnetic fields. *Biofizika*, **41**(3): 642–649. [In Russian.] PMID: 8924464.
- Nakasono, S., and Saiki, H. 2000. Effect of ELF magnetic fields on protein synthesis in *Escherichia coli* K12. *Radiat. Res.* **154**(2): 208–216. doi:10.1667/0033-7587(2000)154[0208:EOEMFO]2.0.CO;2. PMID:10931694.
- Nakasono, S., Ikehata, M., Koana, T., and Saiki, H. 2000. A 50 Hz, 14 mT magnetic field is no mutagenic or co-mutagenic in bacterial mutation assays. *Mutat. Res.* **471**(1–2): 127–134. doi: 10.1016/S1383-5718(00)00118-2. PMID:11080668.
- Potenza, L., Ubaldi, L., De Sanctis, R., De Bellis, R., Cucchiari, L., and Dachà, M. 2004. Effects of a static magnetic field on cell growth and gene expression in *Escherichia coli*. *Mutat. Res.* **561**(1–2): 53–62. doi:10.1016/j.mrgentox.2004.03.009. PMID:15238230.
- Prigent-Combaret, C., Vidal, O., Dorel, C., and Lejeune, P. 1999. Abiotic surface sensing and biofilm-dependent regulation of gene expression in *Escherichia coli*. *J. Bacteriol.* **181**: 5993–6002. PMID:10498711.
- Prigent-Combaret, C., Prensier, G., Le Thi, T.T., Vidal, O., Lejeune, P., and Dorel, C. 2000. Developmental pathway for biofilm formation in curli-producing *Escherichia coli* strains: role of flagella, curli and colanic acid. *Environ. Microbiol.* **2**: 450–464. doi:10.1046/j.1462-2920.2000.00128.x. PMID:11234933.
- Ramìa, M., Tullock, D.L., and Phan-Thien, N. 1993. The role of hydrodynamic interaction in the locomotion of microorganisms. *Biophys. J.* **65**: 755–778. doi:10.1016/S0006-3495(93)81129-9. PMID:8218901.
- Ramon, C., Ayaz, M., and Streeter, D.D., Jr. 1981. Inhibition of growth rate of *Escherichia coli* induced by extremely low-frequency weak magnetic fields. *Bioelectromagnetics*, **2**: 285–289. doi:10.1002/bem.2250020310. PMID:7030350.
- SAS Institute Inc. SAS/STAT user's guide. Version 9.1 [computer program]. SAS Institute Inc., Cary, N.C., USA.
- Seelig, J., Borle, F., and Cross, T.A. 1985. Magnetic ordering of phospholipid membranes. *Biochim. Biophys. Acta, Biomembr.* **814**(1): 195–198. doi:10.1016/0005-2736(85)90437-7.
- Speyer, J.B., Sripada, P.K., Das Gupta, S.K., Shipley, G.G., and Griffin, R.G. 1987. Magnetic orientation of sphingomyelin-lecithin bilayers. *Biophys. J.* **51**: 687–691. doi:10.1016/S0006-3495(87)83394-5.
- Strašák, L., Vetterl, V., and Šmarda, J. 2002. Effects of low-frequency magnetic fields on bacteria *Escherichia coli*. *Bioelectrochemistry*, **55**: 161–164. doi:10.1016/S1567-5394(01)00152-9. PMID:11786365.
- Tlili, C., Reybier, K., Géoën, A., Ponsonnet, L., Martelet, C., Ben Ouada, H., et al. 2003. Fibroblast cells: a sensing bioelement for glucose detection by impedance spectroscopy. *Anal. Chem.* **75**: 3340–3344. doi:10.1021/ac0340861. PMID:14570182.
- Tsuchiya, K., Nakamura, K., Okuno, K., Ano, T., and Shoda, M. 1996. Effect of homogeneous and inhomogeneous high magnetic fields on the growth of *Escherichia coli*. *J. Ferment. Bioeng.* **81**(4): 343–346. doi:10.1016/0922-338X(96)80588-5.
- Ueno, S., and Iwasaka, M. 1994. Properties of diamagnetic fluid in high gradient magnetic fields. *J. Appl. Phys.* **75**: 7177–7179. doi:10.1063/1.356686.
- Unal, R., Yousef, A.E., and Dunne, C.P. 2002. Spectrofluorimetric assessment of bacterial cell membrane damage by pulsed electric field. *Innovative Food Sci. Emerging Technol.* **3**(3): 247–254. doi:10.1016/S1466-8564(02)00033-4.
- Vidal, O., Longin, R., Prigent-Combaret, C., Dorel, C., Hooreman, M., and Lejeune, P. 1998. Isolation of an *Escherichia coli* K-12 mutant strain able to form biofilms on inert surfaces: involvement of a new *ompR* allele that increases curli expression. *J. Bacteriol.* **180**(9): 2442–2449. PMID:9573197.
- Vigeant, M.A., and Ford, R.M. 1997. Interactions between motile *Escherichia coli* and glass in media with various ionic strengths, as observed with three-dimensional-tracking microscope. *Appl. Environ. Microbiol.* **63**(9): 3474–3479. PMID:9292997.
- Zobell, C. 1943. The effects of solid surfaces upon bacterial activity. *J. Bacteriol.* **46**: 39–56. PMID:16560677.
- Zrimec, A., Jerman, I., and Lahajnar, G. 2002. Alternating electric fields stimulate ATP synthesis in *Escherichia coli*. *Cell. Mol. Biol. Lett.* **7**(1): 172–174. PMID:11944082.