



PEM single fuel cell as a dedicated power source for superconducting coils

Rafael Linares, Stéphane Raël, Kévin Berger, Melika Hinaje*, Jean Lévêque

GREEN lab, Faculté des Sciences et Technologies, B.P. 70 239, 54506 Vandoeuvre-lès-Nancy

* melika.hinaje@univ-lorraine.fr

1

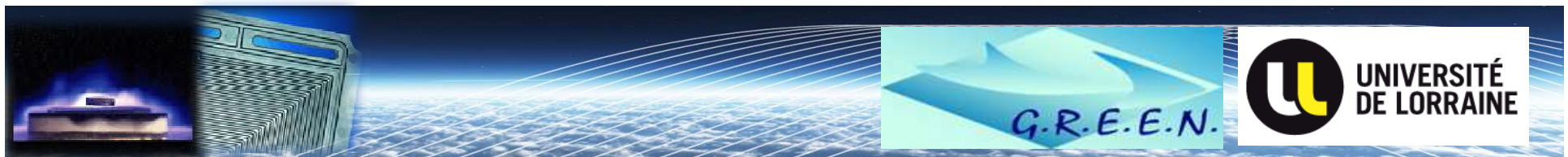

PEM single Fuel Cell

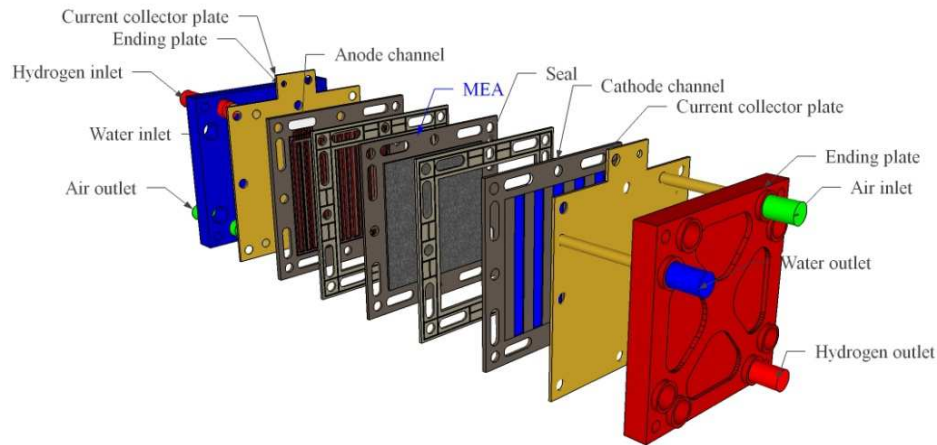

$$\begin{cases} N_{H_2, \text{cons}} = \frac{J_{FC}}{2F} & \text{et} & N_{O_2, \text{cons}} = \frac{J_{FC}}{4F} \\ N_{H_2O, \text{prod}} = \frac{J_{FC}}{2F} \end{cases}$$

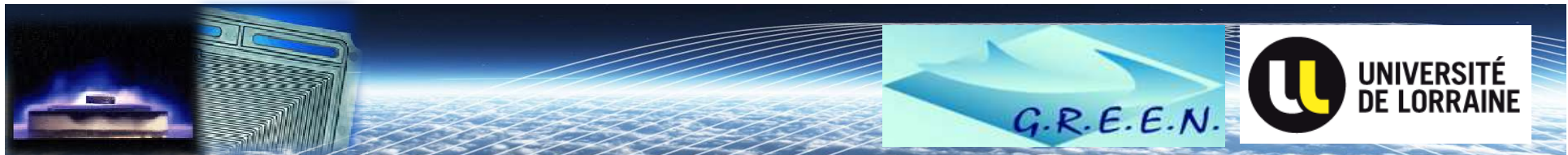
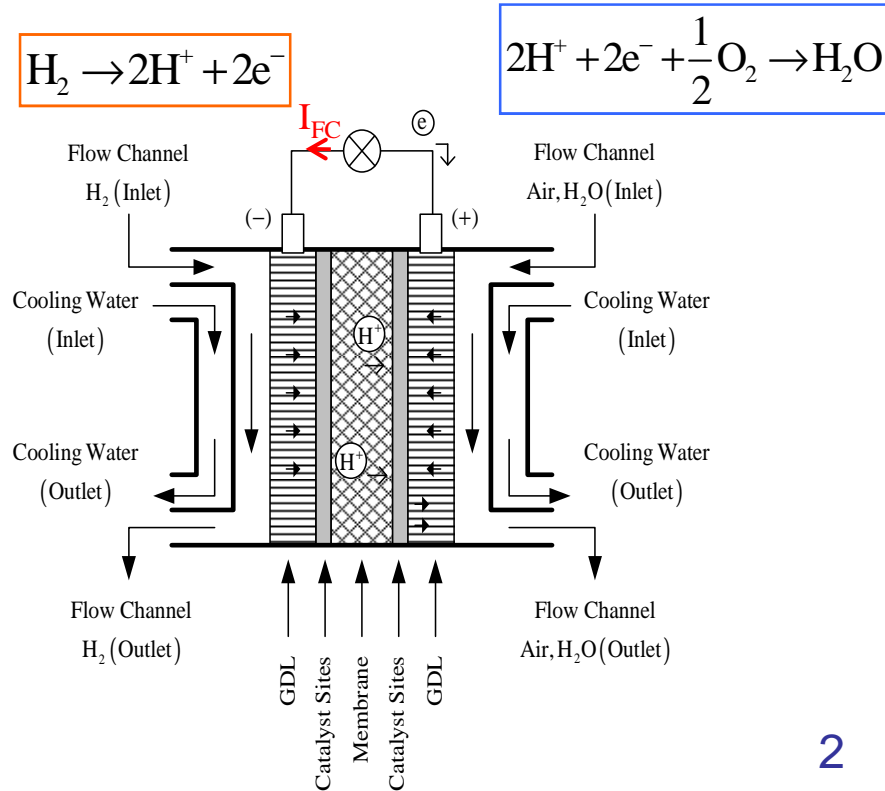
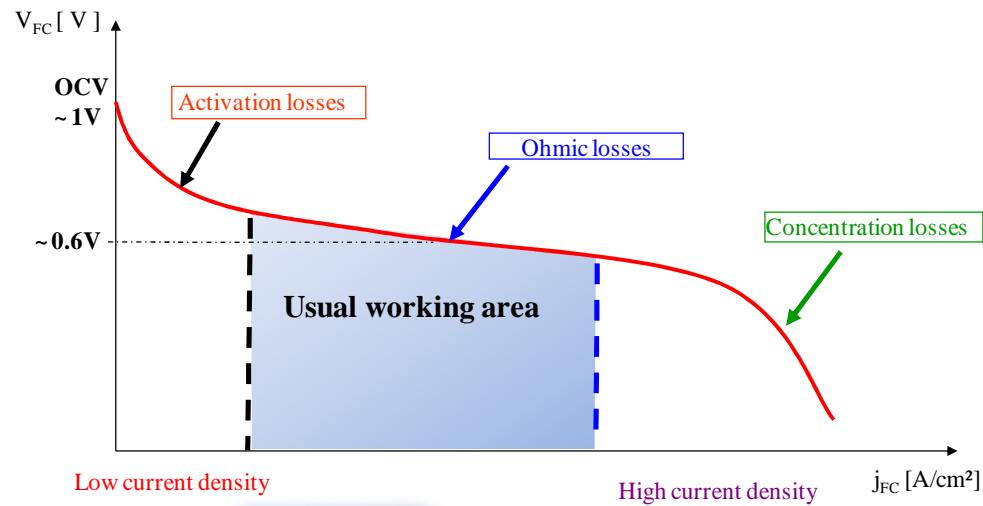

Use of a PEMFC as a current source

➤ Operating point : $V_{FC} \rightarrow 0 \text{ V}$

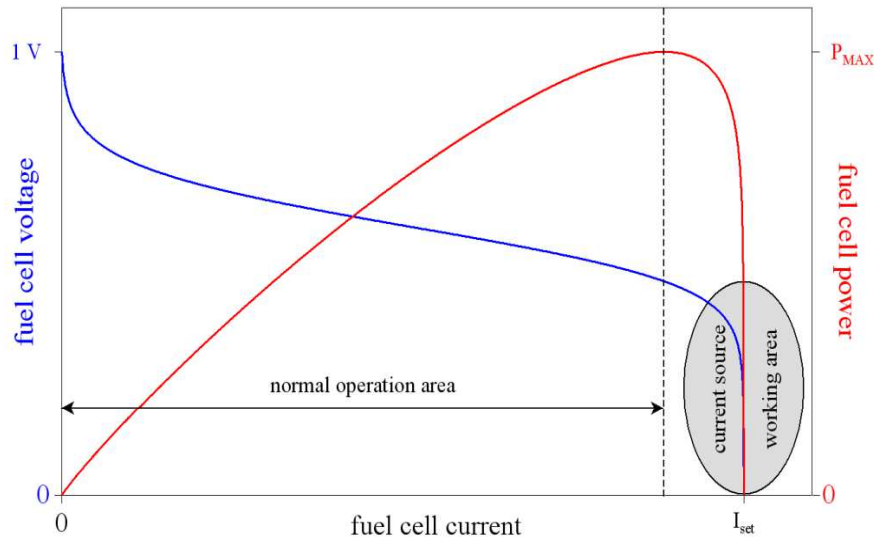

$$\begin{cases} d_{H_2} = 1 \cdot \frac{I_{set}}{2F} \cdot \frac{RT_0}{P_0} \cdot 1000 \cdot 60 \\ d_{air} = 4 \cdot \frac{I_{set}}{4F} \cdot \frac{RT_0}{P_0} \cdot \frac{1}{0.21} \cdot 1000 \cdot 60 \end{cases}$$

➤ 4 mH superconducting coil supplies

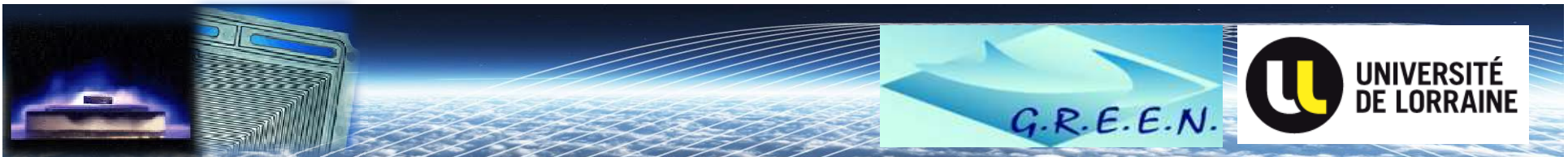
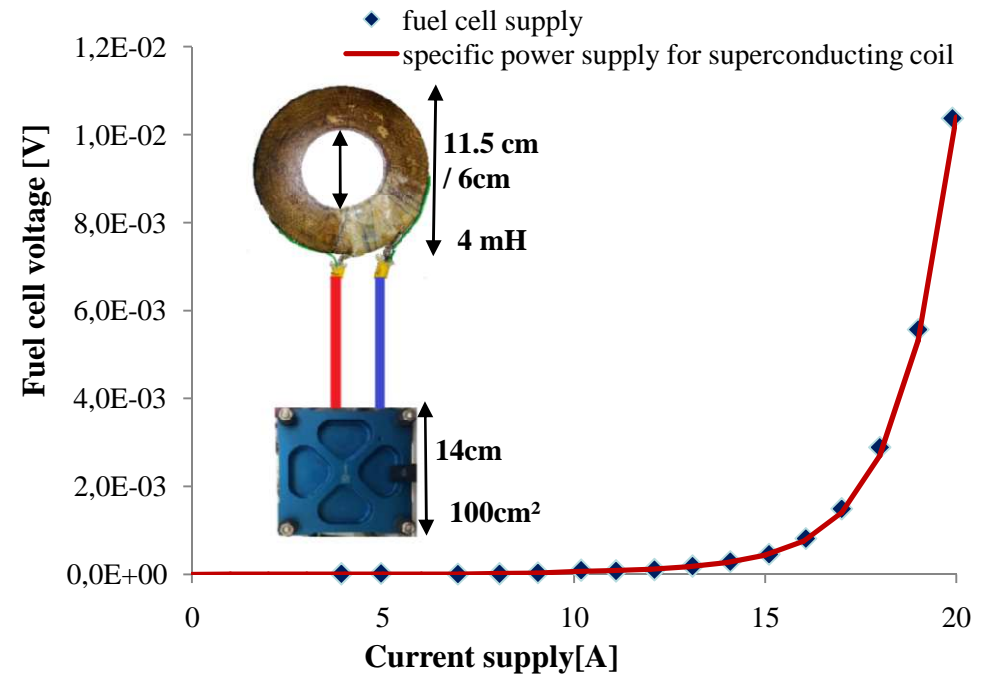

PEMFC as a current source modelling

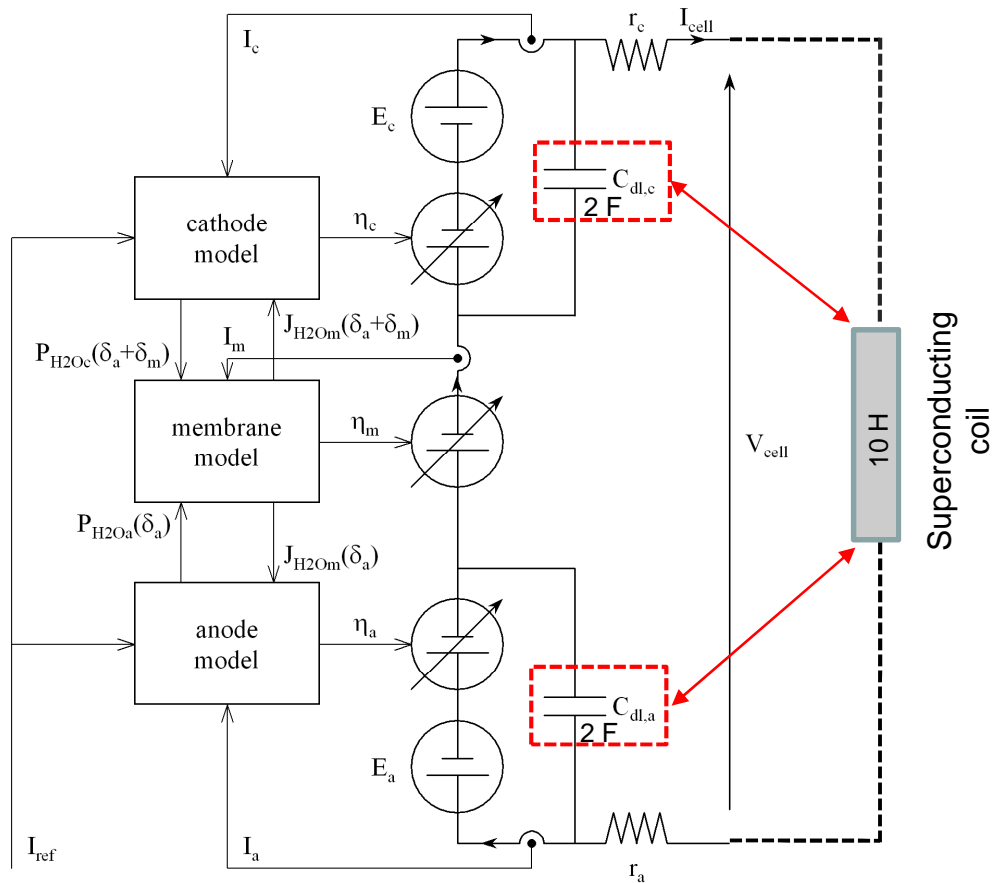

➤ Model validation

➤ Short-circuit case

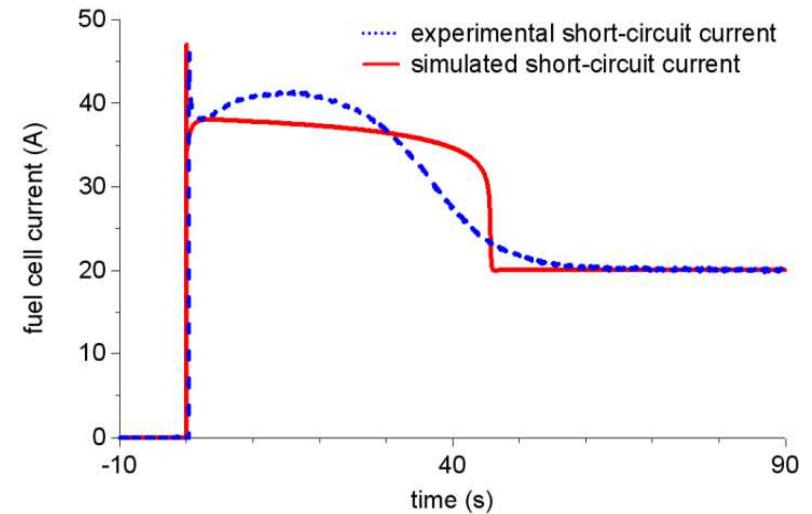

Short-circuit of a single PEMFC. Gas flow setting:
 $I_{set} = 20 \text{ A}$

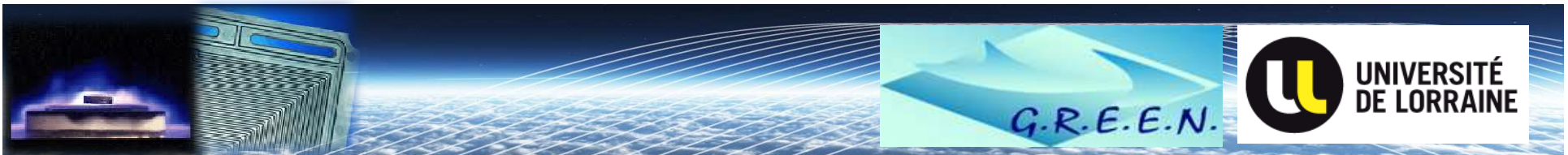

10H superconducting coil fed by a PEMFC

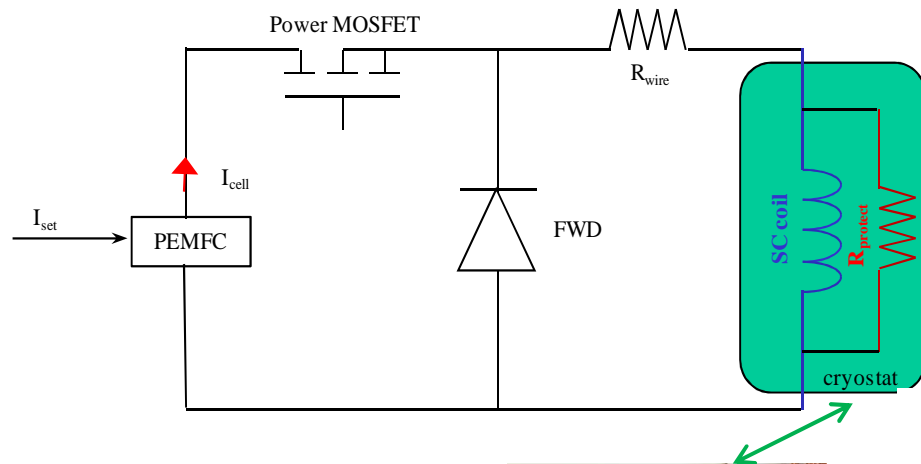

➤ Experimental test bench



superconducting coil



water cooling system

heat sink with power MOSFET and FWD



bubbling humidifier

single fuel cell

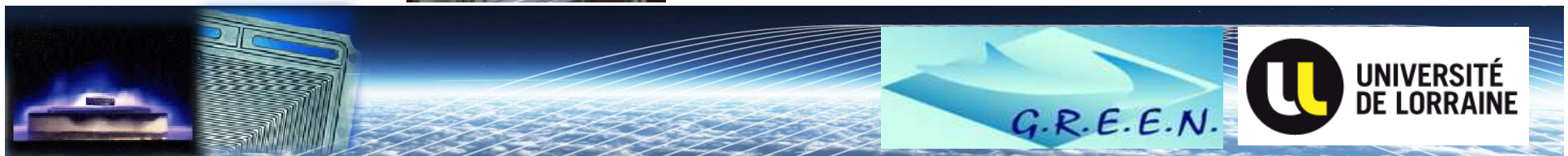

PEMFC supplies 10H SC

➤ Start feeding the SC at 20A

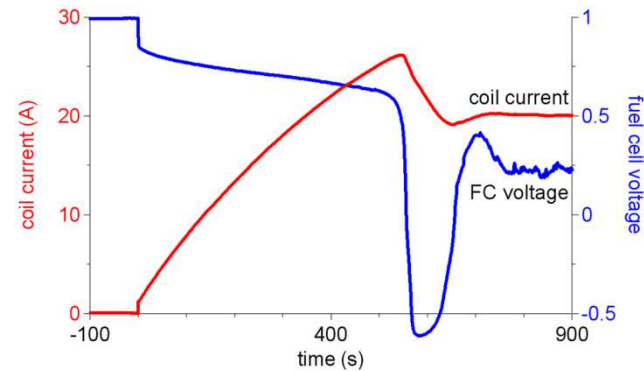
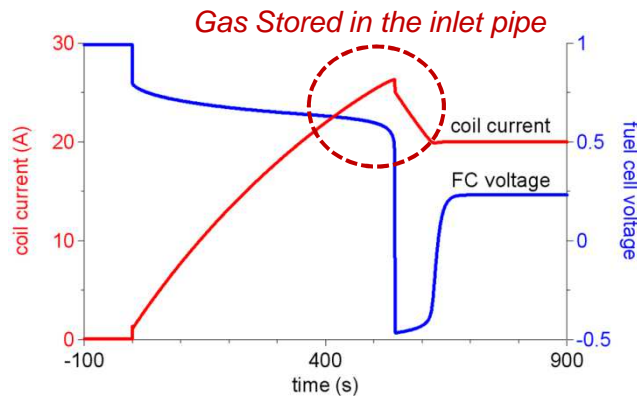

Simulated (left figure) and experimental (right figure) coil current and FC voltage at switch turn-on.
Gas flow setting: $I_{set} = 20$ A. FC supplied with gases before turn-on"



superconducting coil have to be connected together before feeding the fuel cell with reactant gases

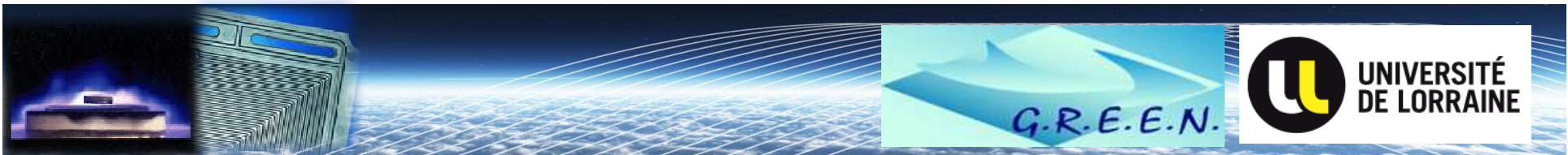

PEMFC supplies 10H SC

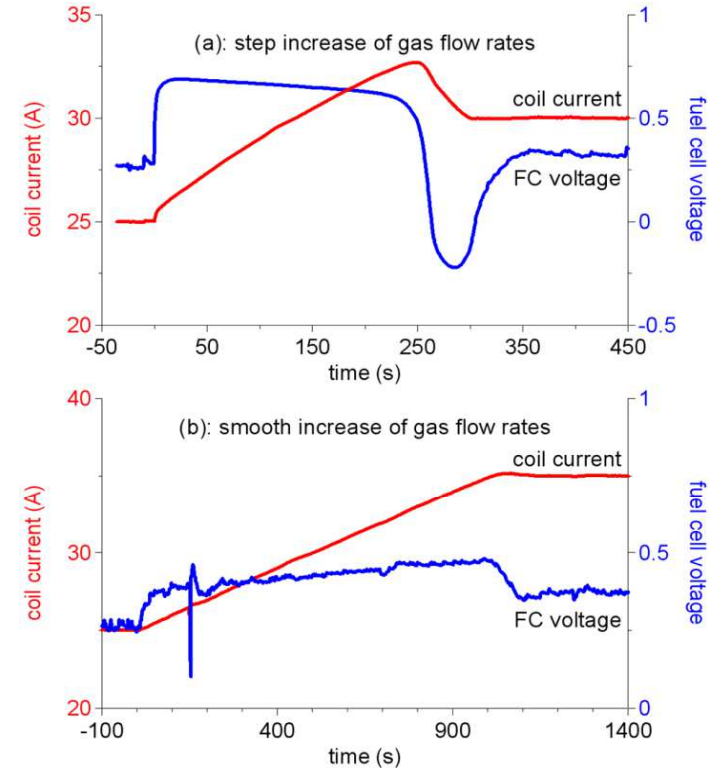
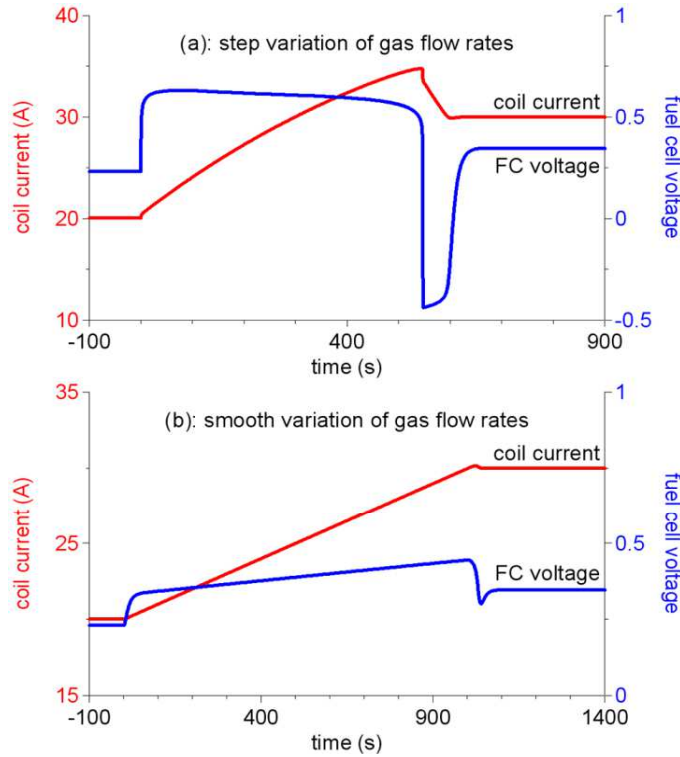

Simulation and Experimental coil current and FC voltage for a step increase of gas flow rates from $I_{set} = 25$ A up to 10 A
 $\Delta I_{set} =, dI_{set}/dt = 10 \text{ mA}\cdot\text{s}^{-1}$

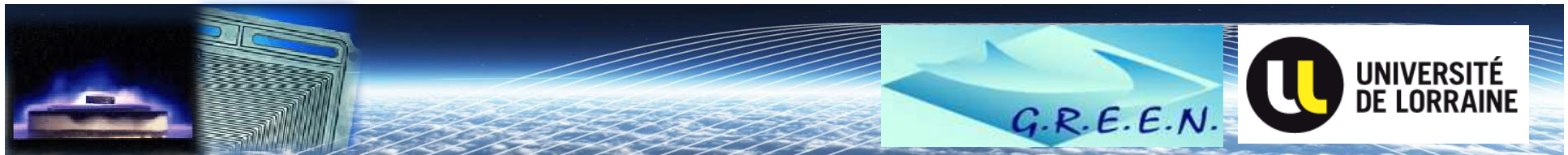

Conclusions

➤ FC current source controlled by H₂ flow rate

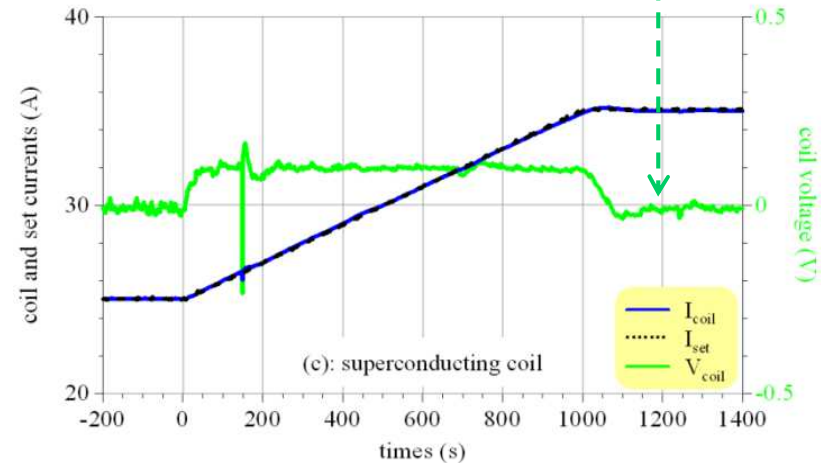
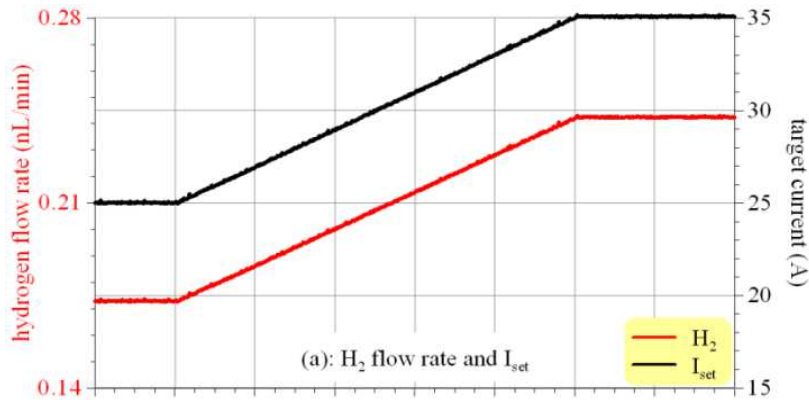

- Simulation help to define requirements for an efficient current control by H₂ flow rate, as well as for FC safe operation
- Interest of such an application is to provide an electric current responding to superconducting device constraints:
 - low voltage DC current,
 - free of harmonics or oscillations,
 - independant from the grid, then not subject to grid power failures

