



**HAL**  
open science

## **Class-A Operation of InAs Quantum Dash-based Vertical-External-Cavity Surface-Emitting Laser**

Salvatore Pes, Kevin Audo, Cyril Paranthoen, Christophe Levallois, Nicolas Chevalier, Goulc'Hen Loas, Steve Bouhier, Cyril Hamel, Carmen Gomez, Jean-Christophe Harmand, et al.

► **To cite this version:**

Salvatore Pes, Kevin Audo, Cyril Paranthoen, Christophe Levallois, Nicolas Chevalier, et al.. Class-A Operation of InAs Quantum Dash-based Vertical-External-Cavity Surface-Emitting Laser. Conference on Lasers and Electro-Optics (CLEO 2017), May 2017, San Jose, United States. OSA (ISBN: 978-1-943580-27-9), OSA Publishing, Tuesday Posters Session (JTU5A), pp. JTU5A.109, 2017, CLEO: Applications and Technology 2017. 10.1364/CLEO\_AT.2017.JTU5A.109 . hal-01532491

**HAL Id: hal-01532491**

**<https://hal.science/hal-01532491>**

Submitted on 2 Jun 2017

**HAL** is a multi-disciplinary open access archive for the deposit and dissemination of scientific research documents, whether they are published or not. The documents may come from teaching and research institutions in France or abroad, or from public or private research centers.

L'archive ouverte pluridisciplinaire **HAL**, est destinée au dépôt et à la diffusion de documents scientifiques de niveau recherche, publiés ou non, émanant des établissements d'enseignement et de recherche français ou étrangers, des laboratoires publics ou privés.

# Class-A Operation of InAs Quantum Dash-based Vertical-External-Cavity Surface-Emitting Laser

S. Pes<sup>1,\*</sup>, K. Audo<sup>1</sup>, C. Paranthoën<sup>1</sup>, C. Levallois<sup>1</sup>, N. Chevalier<sup>1</sup>, G. Loas<sup>1</sup>, S. Bouhier<sup>1</sup>, C. Hamel<sup>1</sup>, C. Gomez<sup>2</sup>, J.-C. Harmand<sup>2</sup>, S. Bouchoule<sup>2</sup>, H. Folliot<sup>1</sup> and M. Alouini<sup>1</sup>

<sup>1</sup> FOTON, UMR CNRS, INSA Rennes, Université de Rennes 1, 35708 Rennes, FRANCE

<sup>2</sup> Centre de Nanosciences et de Nanotechnologies, CNRS, Université Paris-Sud, 91360 Marcoussis, FRANCE

\* salvatore.pes@insa-rennes.fr

## Motivations

Realization of an optical laser source with high spectral purity, low intensity noise and highly tunability for microwave photonics and coherent communication systems

## Applications

### MICROWAVES:

- RADAR/LIDAR systems
- Ultra low-noise sources
- Dual-frequency lasers
- THz generation

### METROLOGY:

- High resolution spectroscopy
- High pure optical reference signal distribution
- Time/frequency metrology

## Experimental setup

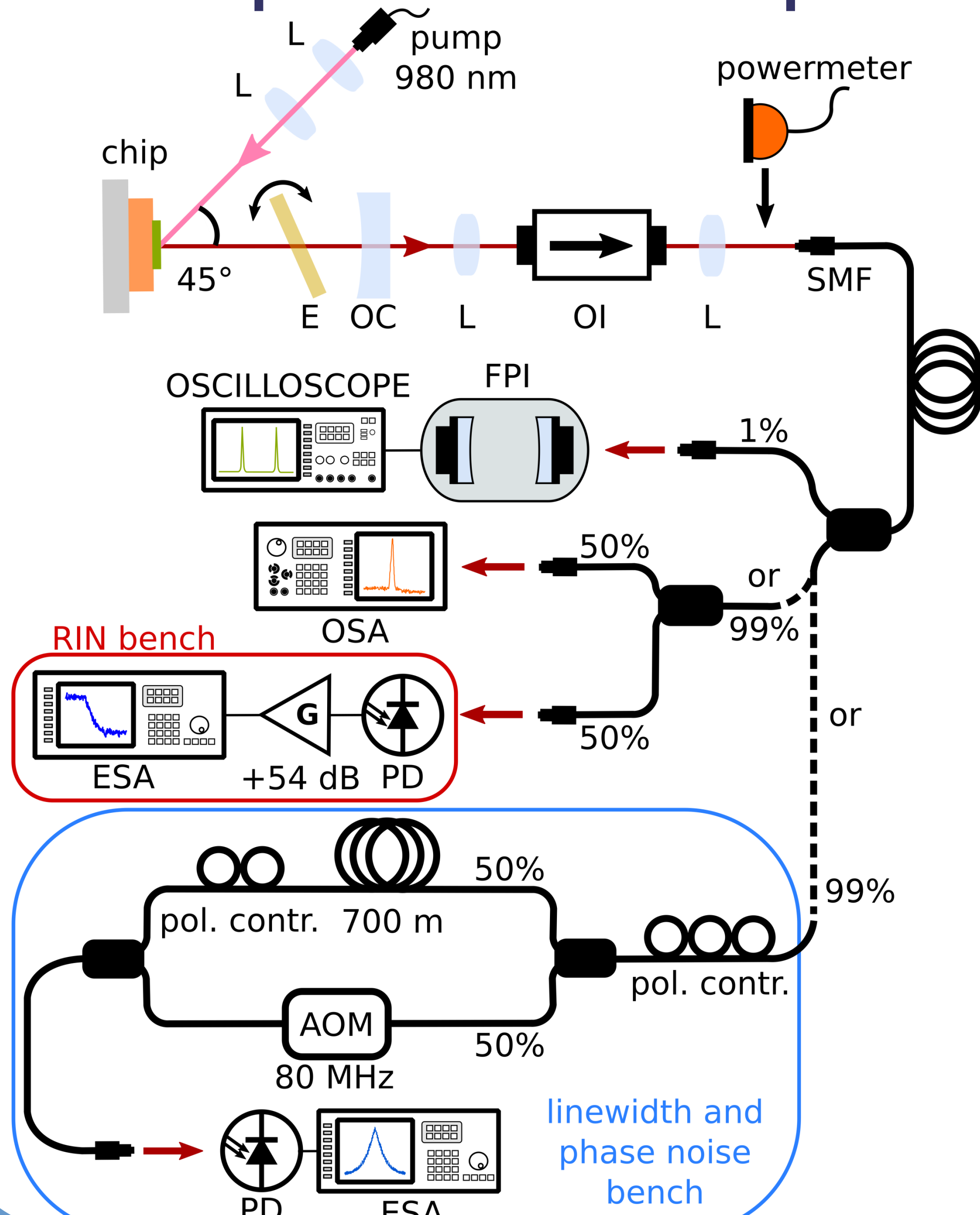

## OP-QDH-VECSEL design and process

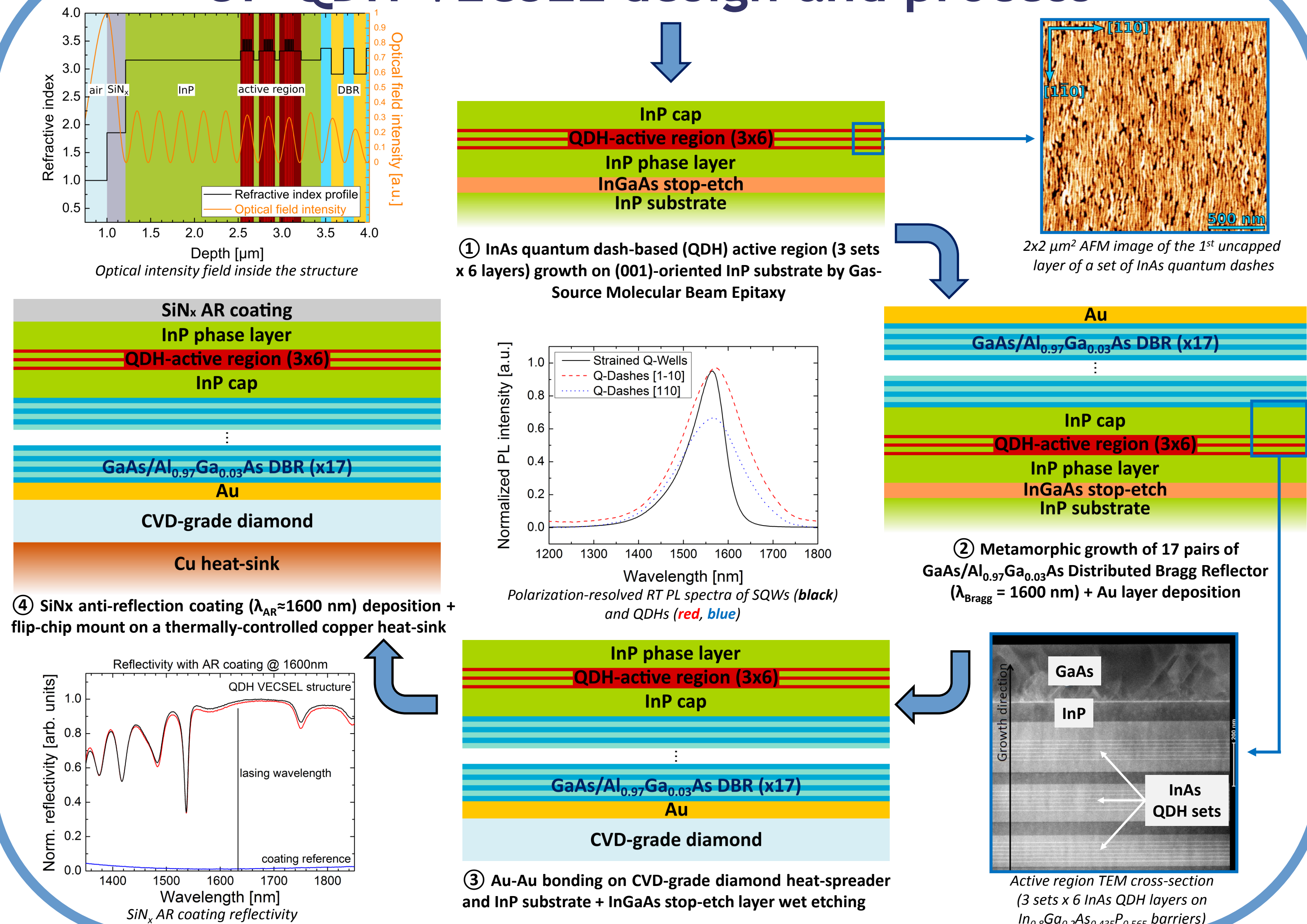

## Laser characterization

### Output characteristics and emission spectra

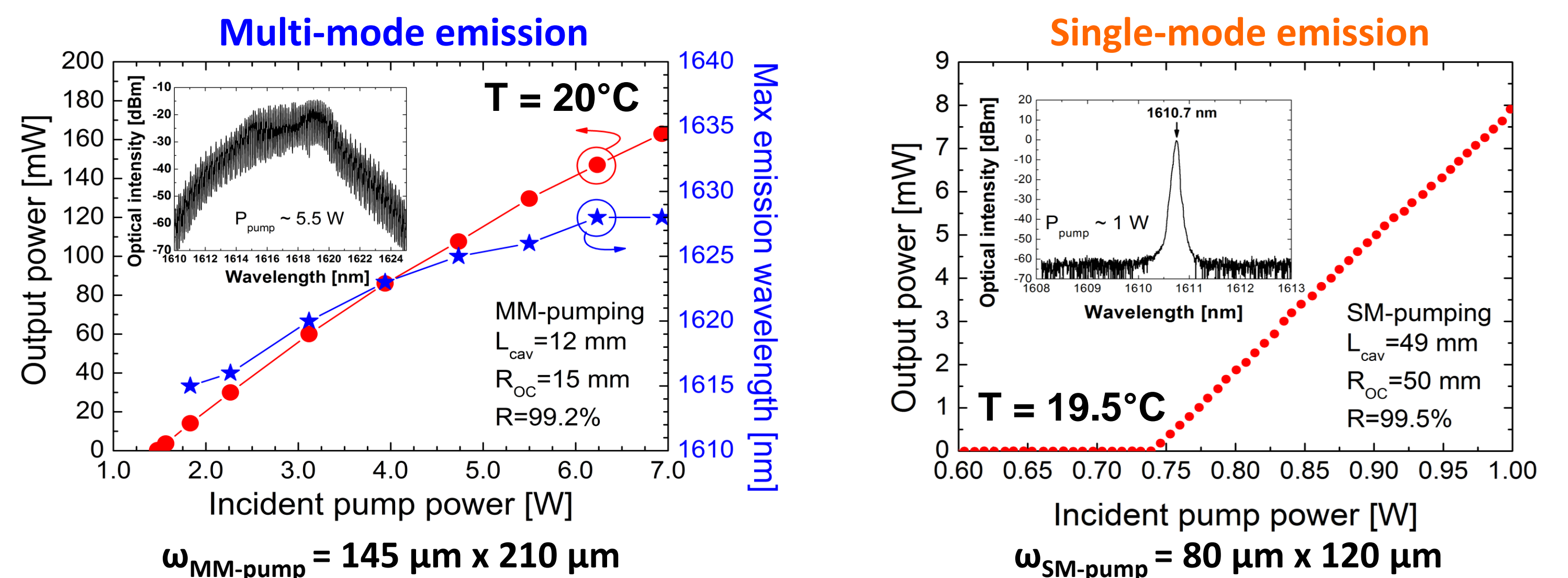

### Single-frequency wavelength tuning

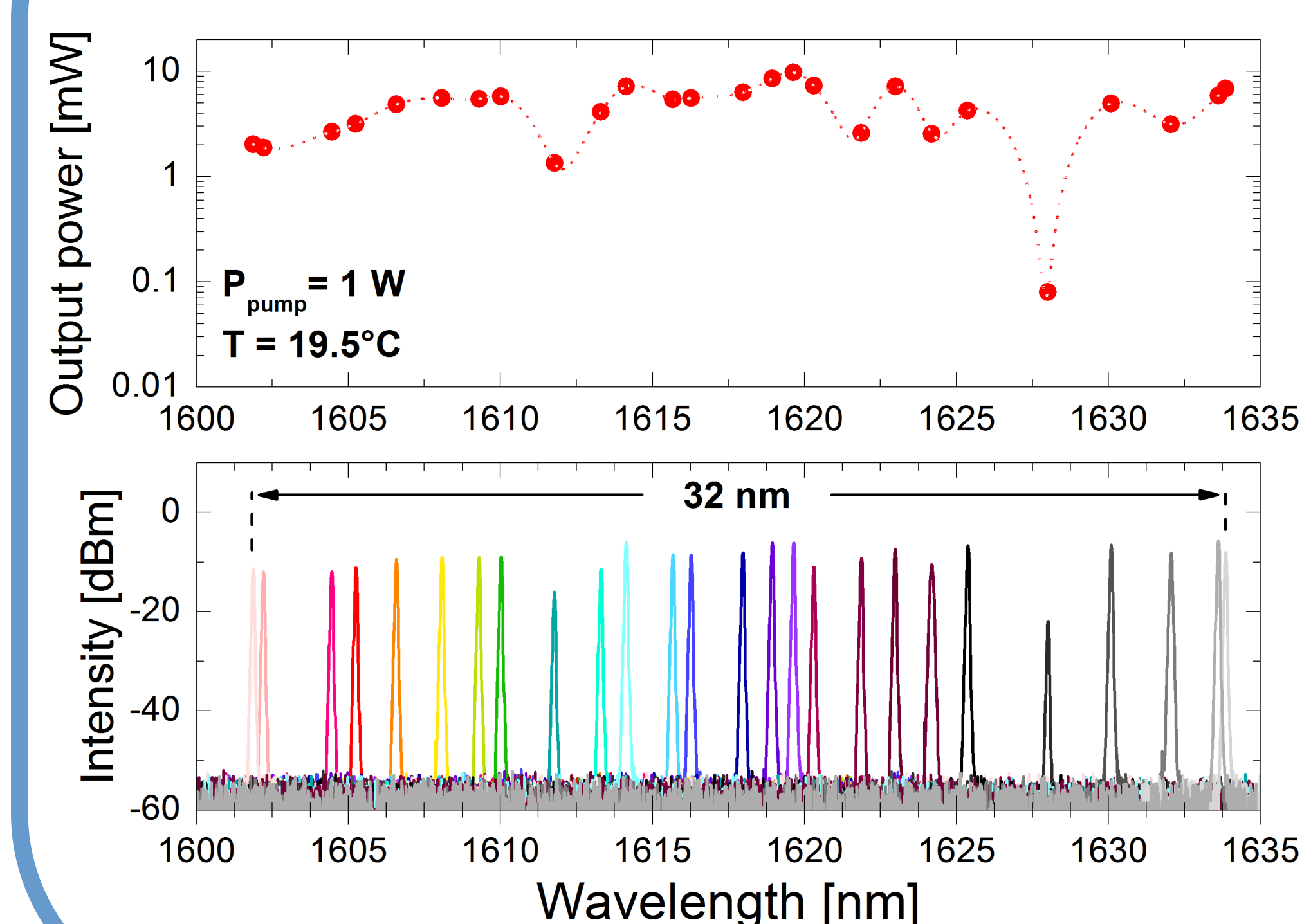

### Polarization-resolved SM-emission

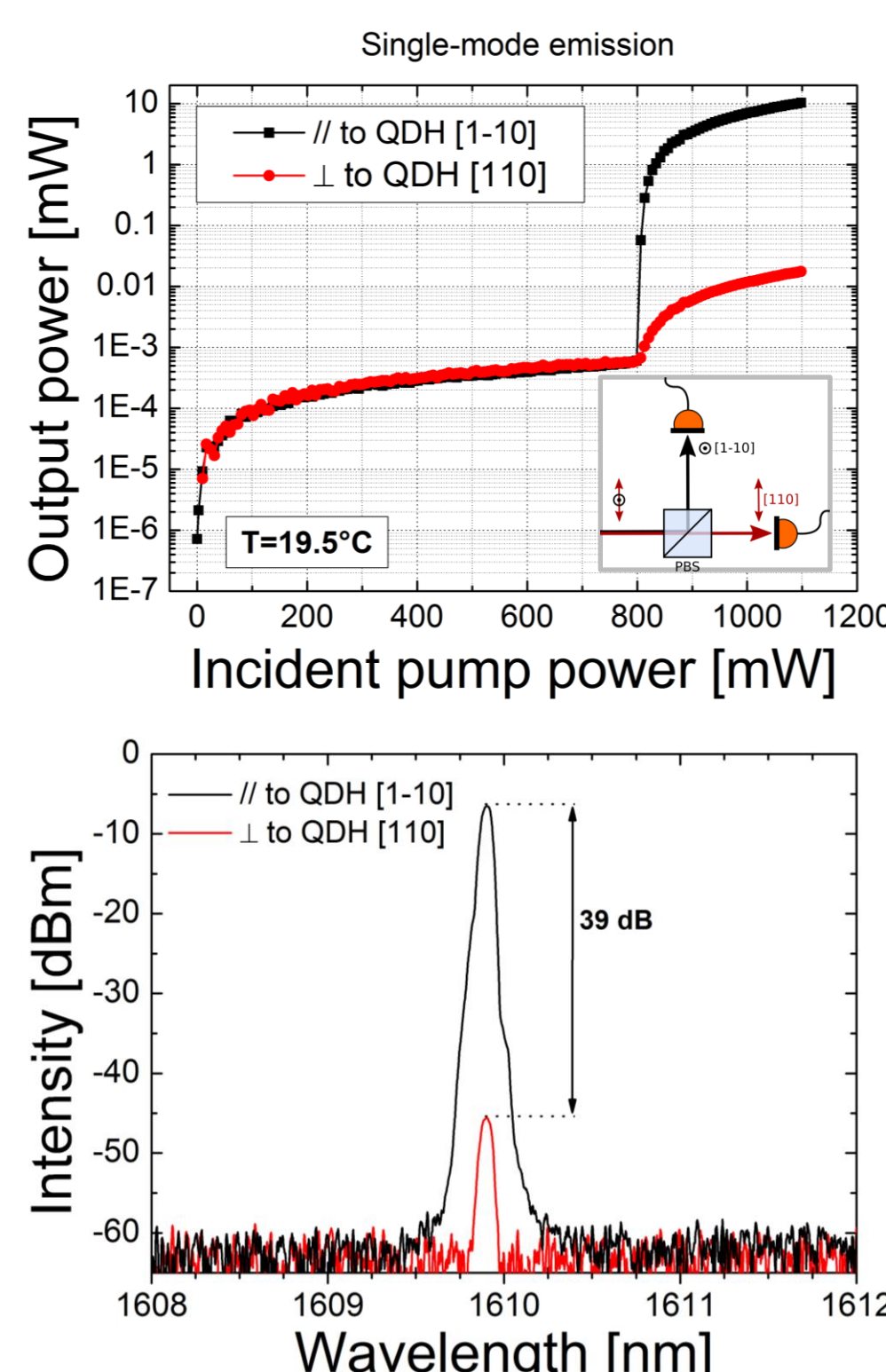

### Laser linewidth and phase noise

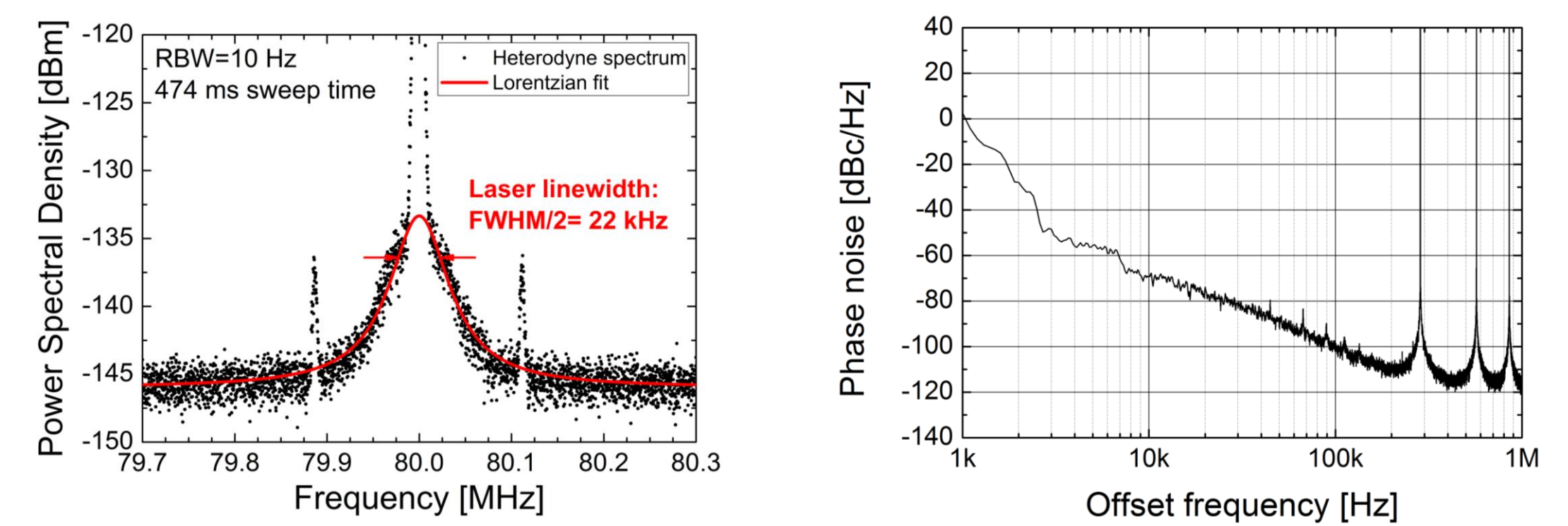

### Class-A operation

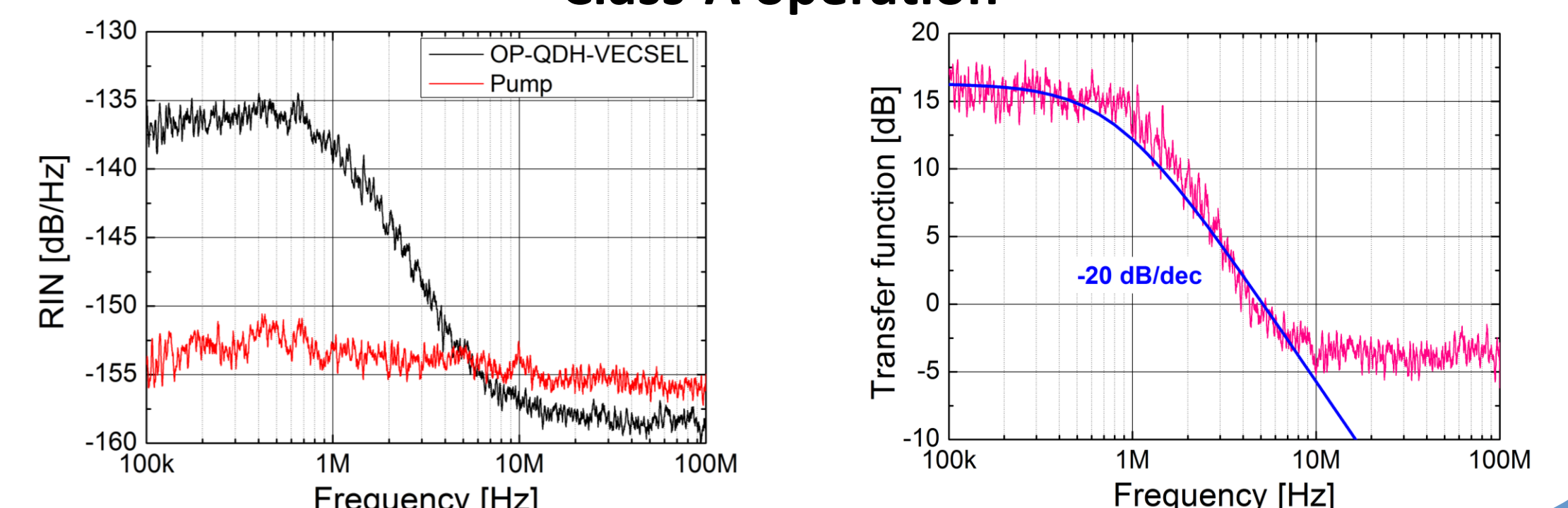

## Conclusion

Demonstration of a Class-A Optically-Pumped InAs Quantum Dash-based Vertical-External-Cavity Surface-Emitting Laser on InP.

**MM-emission:**  $P_{out} = 163 \text{ mW}$  @  $P_{inc} = 7 \text{ W}$ ,  $T=20^\circ\text{C}$

**SM-emission:**  $P_{out} = 10.4 \text{ mW}$  @  $P_{inc} = 1.1 \text{ W}$ ,  $T=19.5^\circ\text{C}$ , 32 nm tuning

Polarization stably aligned along dash [1-10] direction, OPSR = 39 dB

Laser linewidth estimation: 22 kHz (49 mm-long cavity)

Phase noise: -110 dBc/Hz @  $f > 200 \text{ kHz}$  (free-running)

Class-A operation:  $f_c = 800 \text{ kHz}$ , RIN = -158 dB/Hz ( $I_{phd} = 2 \text{ mA}$ )

## Future perspectives

Dual-frequency operation  
Laser stabilisation on ULE cavity (metrology)  
Electrical pumping

## Funding

ANR and DGA within the **ANR-ASTRID HYPOCAMP project** (grant ANR-14-ASTR-0007-01) and a DGA-MRIS/Région Bretagne scholarship (grant ARED-VELOCE 8917).

## References

S. Pes et al., "Class-A Operation of an Optically-Pumped 1.6  $\mu\text{m}$ -emitting Quantum Dash-based Vertical-External-Cavity Surface-Emitting Laser on InP", Opt. Express **25**(10), 11760-11766 (2017)