

Simulation Framework for Performance Evaluation of Passive RFID Tag-To-Tag Communications

Lin Zhou¹, Florin Hutu¹, Guillaume Villemaud¹, Yvan Duroc²

florin-doru.hutu@insa-lyon.fr

¹ Univ. Lyon, INSA Lyon, Inria, CITI, F-69621 Villeurbanne, France

² Univ. Lyon, UCBL, Ampere Laboratory, F-69622 Villeurbanne, France

Abstract — The concept of passive RFID tag-to-tag communications has been recently introduced and opens new promising perspectives, especially in the field of Internet-of-Things. In this paper, a simulation framework is proposed as a new tool allowing the performance evaluation of tag-to-tag radio links. The modeling takes into consideration the external source supplying the communication between tags, radiating characteristics of tag antennas, and reception system aspects. Performance results are expressed in terms of Bit Error Rate (BER) with respect to the distance between the tags and the position of the energy source relative to the position of the two tags.

Index Terms—Antenna, BER, radio front-end model, tag-to-tag communication, RFID.

I. INTRODUCTION

During the two past decades, Radio Frequency Identification (RFID) has become a key technology in the field of radio communications with well-known applications, especially in the areas of traceability, logistics and security [1]. But the scope of the RFID technology is not only limited to the identification and tracking of inventory. Thanks to remarkable benefits: standardized communication enabling inter-operability, intrinsically passive and wireless features that provide decisive practical advantages [2], and its potential to collect and compile massive amounts of detailed real-time data about the environment around us, RFID technology is the subject of a renewed interest. Indeed RFID and more particularly Ultra High Frequency (UHF) RFID has become a relevant candidate for a plethora of new applications in the area of Internet-of-Things [3], Smart Skins [4], Man-to-Machine and Cognitive Intelligence [5].

A strong indicator of its tendency is the development of new types of RFID tags, so called sensor-tags or augmented tags [6]-[8] that integrate new capabilities than only identification, and also, the proposition of new concepts in RFID communications as the use of a redundant communication channel based on the nonlinearity of RFID chips [9] or the tag-to-tag communication [10], [11].

This paper focuses on this latter that has been recently proposed by Nikitin & al. with the idea to establish a communication directly between tags in presence of an RFID reader. It should be noticed that similar techniques have been also proposed and are dedicated to ambient backscatter communication with enabled devices to communicate by backscattering RF signals using Wi-Fi signals or TV

transmissions [12] and also exploiting the Bluetooth 4.0 Low Energy standard [13]. In RFID context, for instance it is possible to imagine to have a "master" tag remotely powered whose the role would be multiple: to harvest energy from an external source (principle of RFID) and to communicate with it. At the same time, its role would be to power supply, to control, and/or to collect information from the associated "slave" tags (sensors or actuators) distributed close by.

The concept of tag-to-tag communication system had been analyzed and experimentally validated for very short distances between tags (about 25 mm) and consequently opens new interesting opportunities. However, to our knowledge, since these first studies few works and advances have been done about this promising topic. In [14] the authors propose a cross layer approach including the MAC (Medium Access Control) protocol as well as the routing protocol. In [15] the power harvesting and demodulation circuit blocks are investigated in terms of design constraints, optimization goals, and tradeoffs in the design of the analog front-end. In [16], the authors show the existence of a phase cancellation problem of tag-to-tag communication systems and propose solutions in order to reduce it.

The present work aims to help to the deployment of the tag-to-tag concept proposing a new modeling scheme taking into account a system view including electromagnetic aspects. After recalling briefly the principle of backscattered modulation in RFID, section II describes the physical concept of tag-to-tag communications, and especially highlights the approach of the proposed modeling. The modeled tag-to-tag radio link, including electromagnetic simulation of radiating elements and system modeling, is detailed in section III. Section IV presents the studies carried out in order to estimate the potential performance of tag-to-tag communications. The achieved results lead to the definition of operating limits in terms of signal-to-noise ratio (SNR). Finally, section V draws the conclusion and perspectives.

II. GLOBAL FRAMEWORK OF THIS STUDY

A. Tag-to-tag communications with an external source

In a classical RFID system, a reader is dedicated to generate a radio wave with a relative high power (until 4 W EIRP) in order to illuminate a distant tag. Then, the tag will modify the backscattered wave to the reader by modulating

its own impedance [1]. Therefore, the information exchange is performed based on the energy provided by the reader, the tag being potentially completely passive. Depending on the protocol version that is used, the frequency band and the range of this system could change in a large way [2].

The idea proposed in [10] is to establish a communication between two closely-spaced tags. In that case, the energy could come from any external source in the used frequency band, as long as the received power is high enough to ensure the activation of tags. The purpose is there to exchange information between two very simple and low cost devices, very close to each other (see Figure 1). Without detailing a specific protocol for this communication, we will consider that at a given timeslot, one tag (called Reader Tag RT) will modulate the signal incoming from the distant source in order to transmit information to the second tag (called Listener Tag LT).

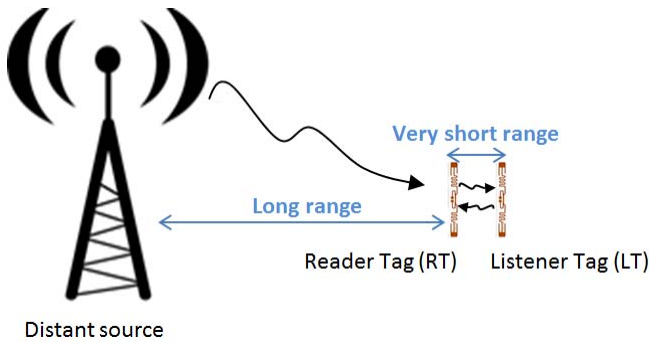

Fig. 1. Global principle of tag-to-tag communication.

Depending on the kind of source, the distance between this source and the tags, and the relative positions of the two tags, a reliable communication could be achieved or not.

B. Simulating a tag-to-tag communication

In order to evaluate the quality of the radio link that it is possible to establish between two tags from an external source, this paper proposes to use a combination of two kinds of simulation: electromagnetic simulation (with CST Microwave Studio) and system-level simulation (with Keysight's Advance Design System: ADS). The electromagnetic simulation will model the design of the antennas of the two tags, and evaluate the impact of the relative placement of these two devices. The system-level simulation will allow the performance evaluation in terms of Bit Error Rate (BER).

It is worth understanding that this system of two communicating tags can be represented as a simple array of two antennas close to each other. Assuming ideal commutation states, when RT is modulating the radio wave by switching on an Open Circuit (OC) or a Short Circuit (SC), this could be modeled via two simulations: one with the RT open at the center coupled with the LT antenna; and a second one with RT short circuited at the center and also coupled with the LT. By the way, each state of the

modulation will be relative to a specific value of the global gain of this array, as long as the input impedance viewed from LT (as represented on Figure 2 extracted from [10]).

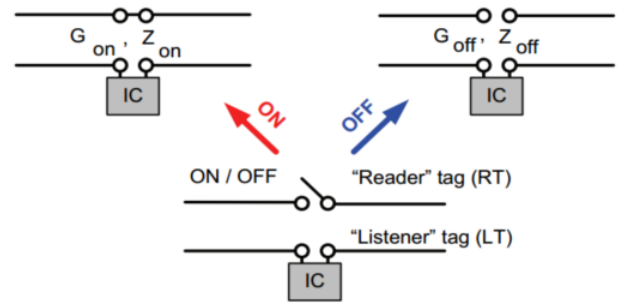

Fig. 2. Two states of the tag-to-tag communication: ON and OFF corresponding to the reader tag switching between an open circuit and a short circuit [10].

Each gain will correspond to a specific direction of arrival of the distant source. For each direction and each relative position between tags, two gain values will be obtained: G_{on} when RT is OC and G_{off} when RT is SC. Moreover, two impedance values (Z_{on} and Z_{off} respectively) will occur. Then, to simulate the complete communication chain, system-level simulations will be performed using ADS, as detailed in section IV.

III. MODELING OF THE ELECTROMAGNETIC PART

A. Antenna Design for Tag-to-tag

In order to build a first evaluation framework, a basic half-wavelength dipole is designed using CST software. This dipole is matched to operate at 868 MHz (i.e., for European UHF RFID standard, without loss of generality for the proposed simulation framework), using an FR-4 substrate (Figure 3).

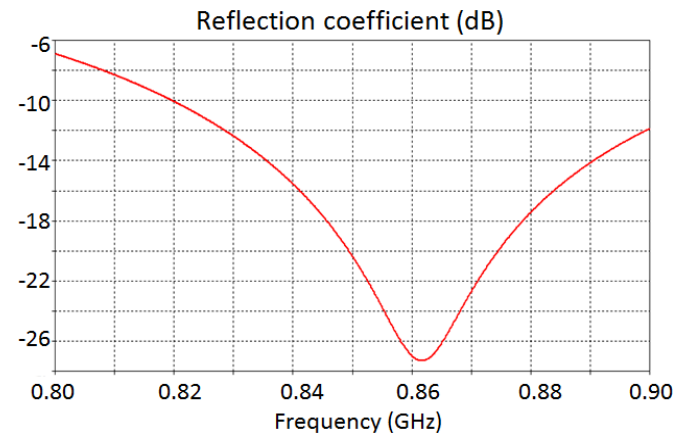

Fig. 3. Reflection coefficient (i.e., S_{11} parameter) of the simulated dipole without coupling with another tag.

Hence the two tags can be modeled as a combination of two dipoles: one (LT) with a 50 ohms port at its center, and

the other one (RT) switching from OC to SC. In practice, two sets of simulations are performed to obtain the global behavior of the two tags (see for example on Figure 4 the case for RT in SC). For this first study, the two tags were considered in the same plane.

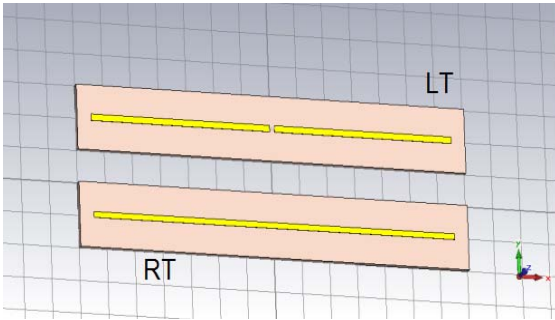

Fig. 4. Simulation of two tags: gain and impedance are measured at the Listener Tag (LT), while the Reader Tag (RT) could switch between Open Circuit and Short Circuit (here Short Circuit).

B. Extracted results

The purpose of these simulations is to collect information about the gains and the input impedance values of the association of these two tags. Actually, as the distance between the tags is quite short, the link between them is in Near Field, as the link between the external source and the array formed by the two tags is in Far Field.

Thus, the radiation pattern extracted from CST (see for instance Figure 5) gives the gain to apply to a plane wave arriving from a certain direction of the space (corresponding to the direction of the external source).

Consequently, different positions of the tags (i.e., different relative distances in Near Field) have been simulated, giving all gain values for RT in OC and in SC.

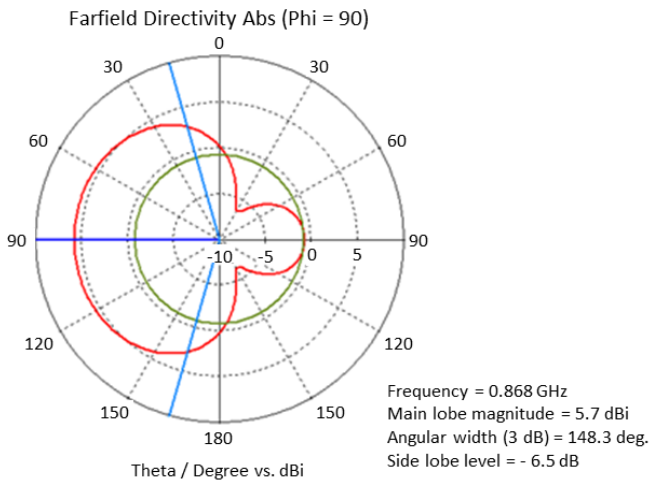

Fig. 5. Example of radiation pattern obtained when simulating the two near field coupled tags.

Moreover, for each position (and independently of the source direction), these simulations provides the output impedance viewed from LT. Table I is summarizing some values of gains and impedances. For the sake of clarity, here only three RT-LT distances are given.

TABLE I. SIMULATED VALUES OF IMPEDANCE AND GAIN RELATIVE TO THE DISTANCE BETWEEN TAGS AND THE POSITION OF THE SOURCE

Distance	Theta (°)	Z _{on} (Ω)	Z _{off} (Ω)	G _{on} (dBi)	G _{off} (dBi)
10 mm	0	16 + j.30	54 - j.1	-1.392	2.050
	45			5.320	1.655
	90			7.036	1.539
	135			5.32	1.655
	180			-1.392	2.050
40 mm	0	36 + j.33	52.7 + j.0	-1.795	1.996
	45			5.143	1.467
	90			6.737	1.384
	135			5.143	1.467
	180			-1.795	1.996
80 mm	0	67 + j.22	53.8 + j.5	0.141	1.752
	45			5.005	1.705
	90			5.704	1.980
	135			5.005	1.705
	180			0.141	1.752

IV. TAG TO TAG COMMUNICATION SYSTEM MODELING

As seen previously, the overall gain and mutual impedance vary function of the RT modulation state and the relative position of the two tags. In order to take into account the whole system, the RT to LT communication quality was evaluated in terms of BER.

As can be seen from Figure 6, the continuous wave (CW) signal from the distant source is modulated by the RT data. The distance between the source and the two tags is considered in such way that the received power level is -50 dBm. The source to tags channel model was considered here as a simple AWGN (Additive White Gaussian Noise) one. From the LT perspective, the received signal is given by the overall antenna gain and impedance.

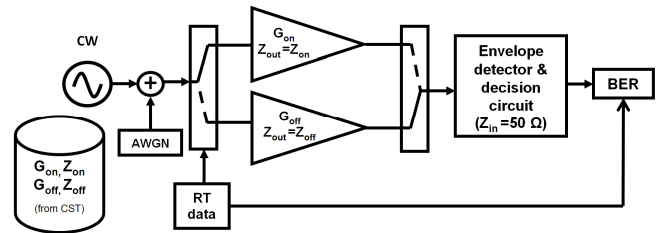

Fig. 6. Global scheme of the system-level simulations.

The signal received by LT is demodulated by using an envelope detector and then, by using a decision circuit the digital version is recovered. This result is compared with the baseband signal of RT and the BER value is estimated. For each E_b/N_o value (with E_b the energy per bit and N_o the noise

power spectral density), the emitted sequence is long enough to get a realistic BER value.

As can be seen from Figure 7, in the case where the source is in a perpendicular position with respect to the tags plane (angle of arrival of 0 degrees), the RT to LT distance d has a relatively small influence on the communication quality. Indeed, in the worst case, for a BER = 1e-4, the E_b/N_o variation is at maximum of 1dB which may be considered inside the confidence interval of the BER estimation.

On the contrary, when the source position with respect to the tags plane is 45 degrees, the RT to LT distance has a greater impact on the overall antenna gain and consequently on the BER. As can be seen from Figure 8, the worst case is when the distance is 80 mm. Here, the SNR should be increased by 4 dB in order to obtain the same BER value. For a smaller distance, $d = 10$ mm, the same BER is obtained for signal to noise ratios 4 dB below the previous case.

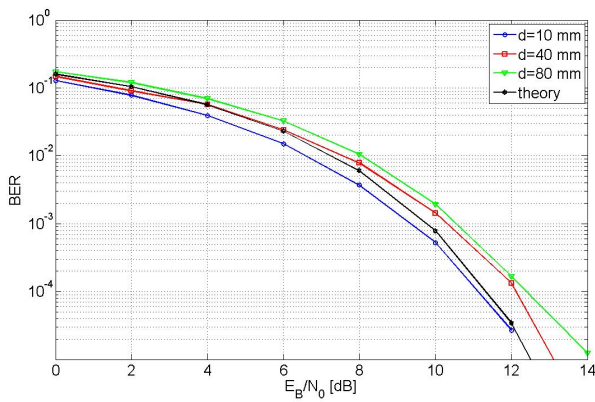

Fig. 7. BER variation with respect to the signal to noise ratio for different distances between RT and LT tags. The source position is at $\theta = 0$ degrees.

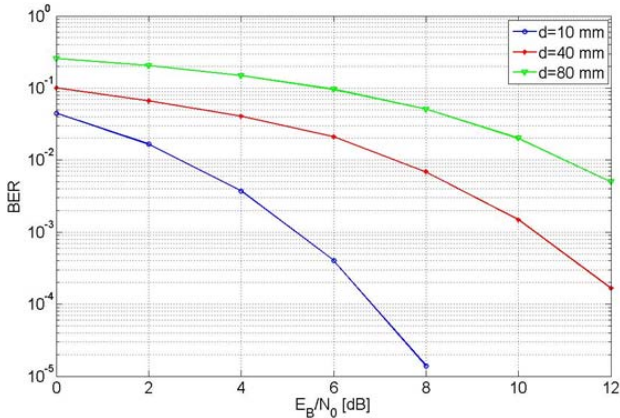

Fig. 8. BER variation with respect to the signal to noise ratio for different distances between RT and LT tags. The source position is at $\theta = 45$ degrees.

Globally, depending on the distance between the tags and the position of the source, a balance between the

variation of impedances Z_{on}/Z_{off} and gains G_{on}/G_{off} impacts the modulation depth, thus affecting the BER.

V. CONCLUSION

This paper presents the evaluation of a passive tag-to-tag communication by considering the two tags as two mutually coupled antennas in Near Field and an external source in Far Field. The BER evaluation demonstrates the importance of the relative position between the tags but also the importance of the position of the external source, with respect to the tags plane.

All results presented here are a first basis to establish a simulation framework to enable studying the actual potential of such tag-to-tag communications. For instance, a further study will be performed by considering scenarios where the backscattered signal is a complex RF waveform from an external system, also using a more realistic radio channel. Furthermore, this framework enables to study the effect of antenna design on this specific link, particularly for designing specific antennas such as their radiation patterns and their polarization characteristics ensure more reliability in the tag-to-tag link.

REFERENCES

- [1] K. Finkenzeller, "RFID Handbook: Fundamentals and Applications in Contactless Smart Cards and Identification, 2nd ed. New York, NY, USA: John Wiley & Sons, Inc., 2003.
- [2] EPCglobal, "EPC radio frequency identity protocols class-1 generation-2 UHF RFID protocol for communications at 860 MHz – 960 MHz version 1.2.0", EPC Global, October 2008.
- [3] L. Atzori, A. Iera, and G. Morabito, "The internet of things: a survey," *Computer networks*, vol. 54, no. 15, pp. 2787–2805, 2010.
- [4] B.S. Cook, T. Le, S. Palaios, A. Traill, M.M. Tentzeris, "Only skin deep," *IEEE Microwave Magazine, IMS Special Issue*, pp. 103-114, May 2013.
- [5] S. Kim, C. Mariotti, F. Alimenti, P. Mezzanote, A. Georgiadis, A. Collado, L. Roselli, M.M. Tentzeris, "No battery required: perpetual RFID-enabled wireless sensors for cognitive intelligence applications," *IEEE Microwave Magazine*, vol. 14, no. 5, pp. 66-77, July-August 2013.
- [6] A. Sample, D. Yeager, P. Powledge, J. Smith, "Design of a passively powered, programmable sensing platform for UHF RFID systems," in *Proc. IEEE Int. Conference on RFID*, March 2007, pp. 149-156.
- [7] R. Colella, L. Catarinucci and L. Tarricone, "Improved battery-less augmented RFID tag: application on ambient sensing and control", *IEEE Sensors Journal*, vol. 16, pp. 3484-3485, 2016.
- [8] S. Tedjini, G. Andia Vera, M. Zurita, R.C.S. Freire, Y. Duroc, "Augmented RFID tags," *IEEE Radio and Wireless Week: IEEE Topical Conference on Wireless Sensors and Sensor Networks*, US, January 24-27, 2016.
- [9] G. Andia Vera, Y. Duroc, S. Tedjini, "Third harmonic exploitation in passive UHF RFID," *IEEE Transactions on Microwave Theory and Techniques*, vol. 63, no. 9, pp. 2991-3004, September 2015.
- [10] P.V. Nikitin, S. Ramamurthy, R. Martinez, K.V.S. Rao, "Passive tag-to-tag communication," in *Proc. IEEE International Conference on RFID*, Orlando, FL, US, April 3-5, 2012.
- [11] G. Marrocco, S. Caizzone, "Electromagnetic Models for passive tag-to-tag communications," *IEEE Transactions on Antennas and Propagation*, vol. 60, no. 11, November 2012.
- [12] V. Liu, A. Parks, V. Talla, S. Gollakota, D. Wetherall, J.R. Smith, "Ambient backscatter: wireless communication out of thin air," in *Proc. ACM SIGCOMM Conference*, Hong Kong, China, August 12-16, 2013, pp. 39-50.

- [13] J.F. Ensworth, M.S. Reynolds, "Every smart phone is a backscatter reader: modulated backscatter compatibility with Bluetooth 4.0 low energy (BLE) devices," in Proc. IEEE International Conference on RFID, San Diego, CA, US, April 15-17, 2015.
- [14] H. Niu, S. Jagannathan, "A cross layer routing scheme for passive RFID tag-to-tag communication," in Proc. IEEE Conference on Local Computer Networks, Montreal, Canada, September 8-11, 2014.
- [15] A. Athalye, J. Jian, Y. KARimi, S.R. Das, P.M. Djuric, "Analog front end design for tags in backscatter-based tag-to-tag communication networks," in Proc. IEEE International Symposium on Circuits and Systems, Montreal, Canada, May 22-25, 2016.
- [16] Z. Shen, A. Athalye, P.M. Djuric, "Phase cancellation in backscatter-based tag-to-tag communication systems," IEEE Internet of Things Journal, vol. PP, no. 99, 25 February 2016.