



HAL
open science

The complexity of tropical graph homomorphisms.

Florent Foucaud, Ararat Harutyunyan, Pavol Hell, Sylvain Legay, Yannis Manoussakis, Reza Naserasr

► **To cite this version:**

Florent Foucaud, Ararat Harutyunyan, Pavol Hell, Sylvain Legay, Yannis Manoussakis, et al.. The complexity of tropical graph homomorphisms.. *Discrete Applied Mathematics*, 2017, 229, pp.64-81. 10.1016/j.dam.2017.04.027 . hal-01520739

HAL Id: hal-01520739

<https://hal.science/hal-01520739v1>

Submitted on 29 Sep 2024

HAL is a multi-disciplinary open access archive for the deposit and dissemination of scientific research documents, whether they are published or not. The documents may come from teaching and research institutions in France or abroad, or from public or private research centers.

L'archive ouverte pluridisciplinaire **HAL**, est destinée au dépôt et à la diffusion de documents scientifiques de niveau recherche, publiés ou non, émanant des établissements d'enseignement et de recherche français ou étrangers, des laboratoires publics ou privés.

The complexity of tropical graph homomorphisms

Florent Foucaud* Ararat Harutyunyan† Pavol Hell‡ Sylvain Legay§
Yannis Manoussakis§ Reza Naserasr¶

September 22, 2018

Note to readers. A shorter version of this article appeared in *Discrete Applied Mathematics* 229 (2017). The present extended version contains all missing proofs and additional figures.

Abstract

A tropical graph (H, c) consists of a graph H and a (not necessarily proper) vertex-colouring c of H . Given two tropical graphs (G, c_1) and (H, c) , a homomorphism of (G, c_1) to (H, c) is a standard graph homomorphism of G to H that also preserves the vertex-colours. We initiate the study of the computational complexity of tropical graph homomorphism problems. We consider two settings. First, when the tropical graph (H, c) is fixed; this is a problem called (H, c) -COLOURING. Second, when the colouring of H is part of the input; the associated decision problem is called H -TROPICAL-COLOURING. Each (H, c) -COLOURING problem is a constraint satisfaction problem (CSP), and we show that a complexity dichotomy for the class of (H, c) -COLOURING problems holds if and only if the Feder–Vardi Dichotomy Conjecture for CSPs is true. This implies that (H, c) -COLOURING problems form a rich class of decision problems. On the other hand, we were successful in classifying the complexity of at least certain classes of H -TROPICAL-COLOURING problems.

1 Introduction

Unless stated otherwise, the graphs considered in this paper are simple, loopless and finite. A *homomorphism* h of a graph G to a graph H is a mapping $h : V(G) \rightarrow V(H)$ such that adjacency is preserved by h , that is, the images of two adjacent vertices of G must be adjacent in H . If such a mapping exists, we note $G \rightarrow H$. For a fixed graph H , given an input graph G , the decision problem H -COLOURING (whose name is derived from the proximity of the problem to proper vertex-colouring) consists of determining whether $G \rightarrow H$ holds. Problems of the form H -COLOURING for some fixed graph H , are called *homomorphism problems*. A classic theorem of Hell and Nešetřil [21] states a *dichotomy* for this problem: if H is bipartite, H -COLOURING is polynomial-time solvable; otherwise, it is NP-complete.

Tropical graphs. As an extension of graph homomorphisms, homomorphisms of edge-coloured graphs have been studied, see for example [1, 6, 7, 8, 9]. In this paper, we consider the variant where the *vertices* are coloured. We initiate the study of *tropical graph homomorphism problems*, in which the vertex sets of the graphs are partitioned into colour classes. Formally, a *tropical graph* (G, c) is a graph G together with a (not necessarily proper) vertex-colouring $c : V(G) \rightarrow C$ of G , where C is a set of colours. If $|C| = k$, we say that (G, c) is a *k-tropical graph*. Given two tropical graphs (G, c_1) and (H, c_2) (where the colour set of c_1 is a subset of the colour set of c_2), a homomorphism h of (G, c_1) to (H, c_2) is a homomorphism of G to H that also preserves the colours, that is, for each vertex v of G , $c_1(v) = c_2(h(v))$. For a fixed tropical graph (H, c) , problem (H, c) -COLOURING asks whether, given an input tropical graph (G, c_1) , we have $(G, c_1) \rightarrow (H, c)$.

The homomorphism factoring problem. Brewster and MacGillivray defined the following related problem in [10]. For two fixed graphs H and Y and a homomorphism h of H to Y , the (H, h, Y) -FACTORIZING problem takes as an input, a graph G together with a homomorphism g of G to Y , and asks

*LIMOS, Université Blaise Pascal, Clermont-Ferrand (France). florent.foucaud@gmail.com

†IMT, Université Toulouse III (Paul Sabatier), Toulouse (France). aharutyu@math.univ-toulouse.fr

‡School of Computing Science, Simon Fraser University, Burnaby (Canada). pavol@sfu.ca

§LRI, Université Paris-Sud, Orsay (France). {legay,yannis}@lri.fr

¶CNRS - IRIF, Université Paris Diderot, Paris (France). E-mail: reza@irif.fr

for the existence of a homomorphism f of G to H such that $f = h \circ g$. The (H, c) -COLOURING problem corresponds to $(H, c, K_{|C|}^+)$ -FACTORING where $K_{|C|}^+$ is the complete graph on $|C|$ vertices with all loops (and with C the set of colours used by c). (Note that in [10], loops were not considered.)

Constraint satisfaction problems (CSPs). Graph homomorphism problems fall into a more general class of decision problems, the *constraint satisfaction problems*, defined for *relational structures*. A relational structure S over a *vocabulary* (a vocabulary is a set of pairs (R_i, a_i) of relation names and arities) consists of a *domain* $V(S)$ of vertices together with a set of relations corresponding to the vocabulary, that is, $R_i \subseteq V(S)^{a_i}$ for each relation R_i of the vocabulary. Given two relational structures S and T over the same vocabulary, a homomorphism of S to T is a mapping $h : V(S) \rightarrow V(T)$ such that each relation R_i is preserved, that is, for each subset of $V(S)^{a_i}$ of R_i in S , its image set in T also belongs to R_i . For a fixed relational structure T , T -CSP is the decision problem asking whether a given input relational structure has a homomorphism to T .

Using this terminology, a graph H is a relational structure over the vocabulary $\{(A, 2)\}$ consisting of a single binary relation A (adjacency). Hence, H -COLOURING is a CSP. Further, (H, c) -COLOURING is equivalent to the problem $C(H, c)$ -CSP, where $C(H, c)$ is obtained from H by adding a set of k unary relations to H (one for each colour class of the k -colouring c).

The Dichotomy Conjecture. In their celebrated paper [20], Feder and Vardi posed the following conjecture.

Conjecture 1.1 (Feder and Vardi [20]). *For every fixed relational structure T , T -CSP is polynomial-time solvable or NP-complete.*

Conjecture 1.1 became known as the *Dichotomy Conjecture* and has given rise to extensive work in this area, see for example [11, 12, 15, 16, 17, 18]. If the conjecture holds, it would imply a fundamental distinction between CSP and the whole class NP. Indeed, the latter is known (unless $P=NP$) to contain so-called *NP-intermediate* problems that are neither NP-complete nor polynomial-time solvable [26].

The Dichotomy Conjecture was motivated by several earlier dichotomy theorems for special cases, such as the one of Schaefer for binary structures [28] or the one of Hell and Nešetřil for undirected graphs, stated as follows.

Theorem 1.2 (Hell and Nešetřil Dichotomy [21]). *Let H be an undirected graph. If H is bipartite, then H -COLOURING is polynomial-time solvable. Otherwise, H -COLOURING is NP-complete.*

Digraph homomorphisms. Digraph homomorphisms are also well-studied in the context of complexity dichotomies. We will relate them to tropical graph homomorphisms. For a digraph D , D -COLOURING asks whether an input digraph admits a homomorphism to D , that is, a homomorphism of the underlying undirected graphs that also preserves the orientation of the arcs.

While in the case of undirected graphs, the H-COLOURING problem is only polynomial time for graphs whose core is either K_1 or K_2 , in the case of digraphs the problem remains polynomial time for a large class of digraphs which are cores. The classification of such cores has been one of the difficulties of the conjecture. Such classifications are given for certain interesting subclasses, see for example [2, 3, 4, 5, 14]. A proof of a conjectured classification of the general case has been announced while this paper was under review (see [19]). If valid, this would imply the truth of the Dichotomy Conjecture, as Feder and Vardi [20] showed the following (seemingly weaker) statement to be equivalent to it.

Conjecture 1.3 (Equivalent form of the Dichotomy Conjecture, Feder and Vardi [20]). *For every bipartite digraph D , D -COLOURING is polynomial-time solvable or NP-complete.*

In Section 3, similarly to its above reformulation (Conjecture 1.3), we will show that the Dichotomy Conjecture has an equivalent formulation as a dichotomy for tropical homomorphisms problems. More precisely, we will show that the Dichotomy Conjecture is true if and only if its restriction to (H, c) -COLOURING problems, where (H, c) is a 2-tropical bipartite graph, also holds. In other words, one can say that the class of 2-tropical bipartite graph homomorphisms is as rich as the whole class of CSPs.

For many digraphs D it is known such that D -COLOURING is NP-complete. Such a digraph of order 4 and size 5 is presented in the book by Hell and Nešetřil [22, page 151]. Such oriented trees are also known, see [23] or [22, page 158]; the smallest such known tree has order 45. A full dichotomy is known for oriented cycles [14]; the smallest such NP-complete oriented cycle has order between 24 and 36 [13, 14].

Using these results, one can easily exhibit some NP-complete (H, c) -COLOURING problems. To this end, given a digraph D , we construct the 3-tropical graph $T(D)$ as follows. Start with the set of vertices $V(D)$ and colour its vertices Blue. For each arc \vec{uv} in D , add a path $ux_u x_v v$ of length 3 from u to v in $T(D)$, where x_u and x_v are two new vertices coloured Red and Green, respectively. The following fact is not difficult to observe.

Proposition 1.4. *For any two digraphs D_1 and D_2 , we have $D_1 \rightarrow D_2$ if and only if $T(D_1) \rightarrow T(D_2)$.*

By the above results on NP-complete D -COLOURING problems and Proposition 1.4, we obtain a 3-tropical graph of order 14, a 3-tropical tree of order 133, and a 3-tropical cycle of order between 72 and 108 whose associated homomorphism problems are NP-complete. Nevertheless, in this paper, we exhibit (by using other reduction techniques) much smaller tropical graphs, trees and cycles (H, c) with (H, c) -COLOURING NP-complete.

List homomorphisms. Dichotomy theorems have also been obtained for a list-based extension of the class of homomorphism problems, the *list-homomorphism problems*. In this setting, introduced by Feder and Hell in [15], the input consists of a pair (G, L) , where G is a graph and $L : V(G) \rightarrow 2^{V(H)}$ is a list assignment representing a set of allowed images for each vertex of G . For a fixed graph H , the decision problem H -LIST-COLOURING asks whether there is a homomorphism h of G to H such that for each vertex v of G , $h(v) \in L(v)$. Problem H -LIST-COLOURING can be seen as a generalization of H -COLOURING. Indeed, restricting H -LIST-COLOURING to the class of inputs where for each vertex v of G , $L(v) = V(H)$, corresponds precisely to H -COLOURING. Therefore, if H -COLOURING is NP-complete, so is H -LIST-COLOURING. For this set of problems, a full complexity dichotomy has been established in a series of three papers [15, 17, 18]. We state the dichotomy result for simple graphs from [17], that is related to our work. (A circular arc graphs is an intersection graph of arcs on a cycle.)

Theorem 1.5 (Feder, Hell and Huang [17]). *If H is a bipartite graph such that its complement is a circular arc graph, then H -LIST-COLOURING is polynomial-time solvable. Otherwise, H -LIST-COLOURING is NP-complete.*

Given a tropical graph (H, c) , the problem (H, c) -COLOURING is equivalent to the restriction of H -LIST-COLOURING to instances (G, L) where each list is the set of vertices in one of the colour classes of c . Next, we introduce a less restricted variant of H -LIST-COLOURING that is also based on tropical graph homomorphisms.

The H -Tropical-Colouring problem. Given a fixed graph H , we introduce the decision problem H -TROPICAL-COLOURING, whose instances consist of (1) a vertex-colouring c of H and (2) a tropical graph (G, c_2) . Then, H -TROPICAL-COLOURING consists of deciding whether $(G, c_1) \rightarrow (H, c)$.

Alternatively, H -TROPICAL-COLOURING is an instance restriction of H -LIST-COLOURING to instances with *laminar lists*, that is, lists such that for each pair of distinct vertices $v_1, v_2 \in V(G)$, $L(v_1) = L(v_2)$ or $L(v_1) \cap L(v_2) = \emptyset$. (We remark that H -TROPICAL-COLOURING, as well as H -LIST-COLOURING, can also be formulated as a CSP, where certain unary relations encode the list constraints: so-called *full CSPs*, see [16] for details.)

Given the difficulty of studying (H, c) -COLOURING problems, as will be demonstrated in Section 3, the study of H -TROPICAL-COLOURING problems will be the focus of the other parts of this paper. This study is directed by the following question.

Question 1.6. *For a given graph H , what is the complexity of H -TROPICAL-COLOURING?*

Clearly, (H, c) -COLOURING where each vertex receives the same colour, is computationally equivalent to H -COLOURING. Therefore, by the Hell-Nešetřil dichotomy of Theorem 1.2, if H is non-bipartite, H -TROPICAL-COLOURING is NP-complete. Furthermore, by the above formulation of H -TROPICAL-COLOURING as an instance restriction of H -LIST-COLOURING, whenever H -LIST-COLOURING is polynomial-time solvable, so is H -TROPICAL-COLOURING.

Thus, according to Theorems 1.2 and 1.5, all problems H -TROPICAL-COLOURING where H is not bipartite are NP-complete, and all problems H -TROPICAL-COLOURING where H is bipartite and its complement is a circular-arc graph are polynomial-time solvable. Thus, it remains to study H -TROPICAL-COLOURING when H belongs to the class of bipartite graphs whose complement is not a circular-arc graph. This class of graphs has been well-studied, and characterized by forbidden induced subgraphs [29]. It is

a rich class of graphs that includes all cycles of length at least 6, all trees with at least one vertex from which there are three branches of length at least 3, and an many other graphs [29].

Observe that for any induced subgraph H' of a graph H , one can reduce H' -TROPICAL-COLOURING to H -TROPICAL-COLOURING by assigning, in the input colouring of H , a dummy colour to all the vertices of $H - H'$. Hence, if H -TROPICAL-COLOURING is polynomial-time solvable, then H' -TROPICAL-COLOURING is also polynomial-time solvable. Conversely, if H' -TROPICAL-COLOURING is NP-complete, so is H -TROPICAL-COLOURING. Therefore, to answer Question 1.6, it is enough to consider minimal graphs H such that H -TROPICAL-COLOURING is NP-complete.

A first question is to study the case of minimal graphs H for which H -LIST-COLOURING is NP-complete; such a list is known and it follows from Theorem 1.5. In particular, it contains all even cycles of length at least 6. In Section 4, we show that for every even cycle C_{2k} of length at least 48, C_{2k} -TROPICAL-COLOURING is NP-complete. On the other hand, for every even cycle C_{2k} of length at most 12, C_{2k} -TROPICAL-COLOURING is polynomial-time solvable. Unfortunately, for each graph H in the above-mentioned list that is not a cycle, H -TROPICAL-COLOURING is polynomial-time solvable, and thus larger graphs will be needed in the quest of a similar characterization of NP-complete H -TROPICAL-COLOURING problems.

In Section 5, we show that for every bipartite graph H of order at most 8, H -TROPICAL-COLOURING is polynomial-time solvable, but there is a bipartite graph H_9 of order 9 such that H_9 -TROPICAL-COLOURING is NP-complete.

Finally, in Section 6, we study the case of trees. We prove that for every tree T of order at most 11, T -TROPICAL-COLOURING is polynomial-time solvable, but there is a tree T_{23} of order 23 such that T_{23} -TROPICAL-COLOURING is NP-complete.

We remark that our NP-completeness results are finer than those that can be obtained from Proposition 1.4, in the sense that the orders of the obtained target graphs are much smaller. Similarly, we note that the results in [10] imply the existence of NP-complete H -TROPICAL-COLOURING problems, and H can be chosen to be a tree or a cycle. However, similarly as in Proposition 1.4, these results are also based on reductions from NP-complete D -COLOURING problems, where H is obtained from the digraph D by replacing each arc by a path (its length depends on D , but it is always at least 3). Thus, the NP-complete tropical targets obtained in [10] are trees of order at least 133 and cycles of order at least 72, which is much more than the ones exhibited in the present paper.

2 Preliminaries and tools

In this section we gather some necessary preliminary definitions and results.

2.1 Isomorphisms, cores

For tropical graph homomorphisms, we have the same basic notions and properties as in the theory of graph homomorphisms. A homomorphism of tropical graph (G, c_1) to (H, c_2) is an *isomorphism* if it is a bijection and it acts bijectively on the set of edges.

Definition 2.1. *The core of a tropical graph (G, c) is the smallest (in terms of the order) induced tropical subgraph $(G', c_{G'})$ admitting a homomorphism of (G, c) to $(G', c_{G'})$.*

In the same way as for simple graphs, it can be proved that the core of a tropical graph is unique. A tropical graph (G, c) is called a *core* if its core is isomorphic to (G, c) itself. Moreover, we can restrict ourselves to studying only cores. Indeed it is not difficult to check that (G, c_1) admits a homomorphism to (H, c_2) if and only if the core of (G, c_1) admits a homomorphism to the core of (H, c_2) .

2.2 Formal definitions of the used computational problems

We now formally define all the decision problems used in this paper.

H -COLOURING

Input: A (di)graph G .

Question: Does there exist a homomorphism of G to H ?

H -LIST-COLOURING

Input: A graph G and a list function $L : V(G) \rightarrow 2^{V(H)}$.

Question: Is there a homomorphism f of G to H such that for every vertex x of G , $f(x) \in L(x)$?

(H, c) -COLOURING

Input: A tropical graph (G, c_1) .

Question: Does (G, c_1) admit a homomorphism to (H, c) ?

H -TROPICAL-COLOURING

Input: A vertex-colouring c of H , and a tropical graph (G, c_1) .

Question: Does (G, c_1) admit a homomorphism to (H, c) ?

T -CSP

Input: A relational structure S over the same vocabulary as T .

Question: Does S admit a homomorphism to T ?

k -SAT

Input: A pair (X, C) where X is a set of Boolean variables and C is a set of k -tuples of literals of X , that is, variables of X or their negation.

Question: Is there a truth assignment $A : X \rightarrow \{0, 1\}$ such that each clause of C contains at least one true literal?

NAE k -SAT

Input: A pair (X, C) where X is a set variables and C is a set of k -tuples of variables of X .

Question: Is there a partition of X into two classes such that each clause of C contains at least one variable in each class?

It is a folklore result that 2-SAT is polynomial-time solvable, a fact for example observed in [25]. On the other hand, 3-SAT is NP-complete [24], and NAE 3-SAT is NP-complete as well [27] (even if the input formula contains no negated variables).

2.3 Bipartite graphs

We now give several facts that are useful when working with homomorphisms of bipartite graphs.

Observation 2.2. *Let H be a bipartite graph with parts A, B . If $\phi : G \rightarrow H$ is a homomorphism of G to H , then G must be bipartite. Moreover, if G and H are connected, then $\phi^{-1}(A)$ and $\phi^{-1}(B)$ are the two parts of G .*

The next proposition shows that for bipartite target graphs, we may assume (at the cost of doubling the number of colours) that no two vertices from two different parts of the bipartition are coloured with the same colour.

Proposition 2.3. *Let (H, c) be a connected tropical bipartite graph with parts A, B , and assume that vertices in A and B are coloured by c with colours in set C_A and C_B , respectively. Let c' be the colouring with colour set $(C_A \times 0) \cup (C_B \times 1)$ obtained from c with $c'(x) = (c(x), 0)$ if $x \in A$ and $c'(x) = (c(x), 1)$ if $x \in B$. If (H, c') -COLOURING is polynomial-time solvable, then (H, c) -COLOURING is polynomial-time solvable.*

Proof. Let (G, c_1) be a bipartite tropical graph. We may assume G is connected since the complexity of (H, c) -COLOURING and (H, c') -COLOURING stays the same for connected inputs. Let c'_1 and c''_1 be the colourings obtained from c_1 by performing a similar modification as for c' : $c'_1(x) = (c_1(x), 0)$ if $x \in A$ and $c'_1(x) = (c_1(x), 1)$ if $x \in B$, and $c''_1(x) = (c_1(x), 1)$ if $x \in A$ and $c''_1(x) = (c_1(x), 0)$ if $x \in B$. Now it is clear, by Observation 2.2, that $(G, c_1) \rightarrow (H, c)$ if and only if either $(G, c'_1) \rightarrow (H, c')$ or $(G, c''_1) \rightarrow (H, c')$. Since the latter condition can be checked in polynomial time, the proof is complete. \square

2.4 Generic lemmas for polynomiality

We now prove several generic lemmas that will be useful to prove that a specific (H, c) -COLOURING problem is polynomial-time solvable.

Definition 2.4. *Let (H, c) be a tropical graph. A vertex of (H, c) is a forcing vertex if all its neighbours are coloured with distinct colours.*

This is a useful concept since in any mapping of a tropical graph (G, c') to a target containing a forcing vertex x , if a vertex of G is mapped to x , then the mapping of all its neighbours is forced. We have the following immediate application:

Lemma 2.5. *Let (H, c) be a tropical graph. If all vertices of H are forcing vertices, then (H, c) -COLOURING is polynomial-time solvable.*

Proof. Choose any vertex x of the instance (G, c_1) , and map it to any vertex of (H, c) with the same colour. Once this choice is made, the mapping for the whole connected component of x is forced. Hence, try all $O(|V(H)|)$ possibilities to map x , and repeat this for every connected component of G . The tropical graph (G, c_1) is a YES-instance if and only if every connected component admits a mapping. \square

Lemma 2.6 (2-SAT). *Let (H, c) be a tropical graph and let $\{S_1, \dots, S_k\}$ be a collection of independent sets of H , each of size at most 2. Assume that for every tropical graph (G, c_1) admitting a homomorphism to (H, c) , there exists a partition $\mathcal{P} = P_1, \dots, P_\ell$ of $V(G)$ into $\ell \leq k$ sets and a homomorphism $f : (G, c_1) \rightarrow (H, c)$ such that for every $i \in \{1, \dots, \ell\}$, there is a $j = j(i) \in \{1, \dots, k\}$ such that all vertices of P_i map to vertices of S_j . Then (H, c) -COLOURING is polynomial-time solvable.*

Proof. We reduce (H, c) -COLOURING to 2-SAT. For every set S_i , if S_i contains only one vertex s , s represents TRUE. If S_i contains two vertices s, s' , one of them represents TRUE, the other FALSE (note that if some vertex belongs to two distinct sets S_i and S_j , it is allowed to represent, say, FALSE with respect to S_i and TRUE with respect to S_j). Now, given an instance (G, c_1) of (H, c) -COLOURING, we build a 2-SAT formula over variable set $V(G)$ that is satisfiable if and only if $(G, c_1) \rightarrow (H, c)$, as follows.

For every edge xy of G , assume that in f , x is mapped to a vertex of S_i and y is mapped to a vertex of S_j (necessarily if $(G, c_1) \rightarrow (H, c)$ we have $i \neq j$ since S_i, S_j induce independent sets). Let F_{xy} be a disjunction of conjunctive 2-clauses over variables x, y . For every edge uv between a vertex u in S_i and a vertex v in S_j , depending on the truth value assigned to u and v , add to F_{xy} the conjunctive clause that would be true if x is assigned the truth value of u and y is assigned the truth value of v . For example: if $u = \text{FALSE}$ and $v = \text{TRUE}$ add the clause $(\bar{x} \wedge y)$. When F_{xy} is constructed, transform it into an equivalent conjunction of disjunctive clauses and add it to the constructed 2-SAT formula. Now, by the construction, if the formula is satisfiable we construct a homomorphism by mapping every vertex x to the vertex of the corresponding set S_i that has been assigned the same truth value as x in the satisfying assignment. By construction it is clear that this is a valid mapping. On the other hand, if the formula is not satisfiable, there is no homomorphism of (G, c_1) to (H, c) satisfying the conditions, and hence there is no homomorphism at all. \square

As a corollary of Lemma 2.6 and Proposition 2.3, we obtain the following lemma:

Lemma 2.7. *If (H, c) is a bipartite tropical graph where each colour is used at most twice, then (H, c) -COLOURING is polynomial-time solvable.*

Given a set S of vertices, the *boundary* $B(S)$ is the set of vertices in S that have a neighbour out of S .

Lemma 2.8. *Let (H, c) be a tropical graph containing a connected subgraph S of forcing vertices such that:*

(a) every vertex in $B(S)$ is coloured with a distinct colour (let $C(S)$ be the set of colours given to vertices in $B(S)$), and (b) no colour of $C(S)$ is present in $V(H) \setminus S$.

If $(H - S)$ -LIST-COLOURING is polynomial-time solvable, then (H, c) -COLOURING is polynomial-time solvable.

Proof. Let $\bar{S} = V(H) \setminus S$. Let (G, c_1) be an instance of (H, c) -COLOURING. Consider an arbitrary vertex v of G with $c_1(v) = i$. Then, v must be mapped to a vertex coloured i . For every possible choice of mapping v , we will construct one instance of $(H - S)$ -LIST-COLOURING. To construct an instance from such a choice, we first partition $V(G)$ into two sets: the set V_S containing the vertices that must map to vertices in S (and their images are determined), and the set $V_{\bar{S}}$ containing the vertices that must map to vertices of \bar{S} . We now distinguish two basic cases, that will be repeatedly applied during the construction.

Case 1: vertex v is mapped to a vertex in S . If v has been mapped to a vertex x of S , since x is a forcing vertex, the mapping of all neighbours of v is determined (anytime there is a conflict we return NO for the specific instance under construction). We continue to propagate the forced mapping as much as possible (i.e. as long as the forced images belong to S) within a connected set of G containing v . This yields a connected set C_v of vertices of G whose mapping is determined, and whose neighbourhood $N_v = N(C_v) \setminus C_v$ consists of vertices each of which must be mapped to a determined vertex of \bar{S} . We add C_v to V_S . We now remove the set C_v from G and repeat the procedure for all vertices of N_v using Case 2.

Case 2: vertex v is mapped to a vertex in \bar{S} . We perform a BFS search on the remaining vertices in G , until we have computed a maximal connected set C_v of vertices containing v in which no vertex is coloured with a colour in $C(S)$. Then, for every vertex x of C_v with a neighbour y that is coloured i ($i \in C(S)$), by Property (a) we know that y must be mapped to a vertex in $B(S)$, and moreover the image of y is determined by colour i . Hence the neighbourhood $N_v = N(C_v) \setminus C_v$ has only vertices whose mapping is determined. We add C_v to set $V_{\bar{S}}$ and apply Case 1 to every vertex in N_v .

End of the procedure. Once $V(G)$ has been partitioned into V_S and $V_{\bar{S}}$ (where the mapping of all vertices in $V_S \cup N(V_S)$ is fixed), we can reduce this instance to a corresponding instance of $(H - S)$ -LIST-COLOURING.

In total, (G, c_1) is a YES-instance if and only if at least one of the $O(|V(G)|)$ constructed instances of $(H - S)$ -LIST-COLOURING is a YES-instance. \square

The next lemma is similar to Lemma 2.8 but now the boundary is distinguished using edges.

Lemma 2.9. *Let (H, c) be a tropical graph containing a connected subgraph S of forcing vertices with boundary $B = B(S)$ and $N = N(B) \setminus S$. Assume that the following properties hold:*

- (a) *for every pairs $xy, x'y'$ of distinct edges of $B \times N$, we have $(c(x), c(y)) \neq (c(x'), c(y'))$, and*
- (b) *for every edge xy of $B \times N$, there is no edge in $(H - S) \times (H - S)$ whose endpoints are coloured $c(x)$ and $c(y)$. If $(H - S)$ -LIST-COLOURING is polynomial-time solvable, then (H, c) -COLOURING is polynomial-time solvable.*

Proof. The proof is almost the same as the one of Lemma 2.8, except that now, while computing an instance of $(H - S)$ -LIST-COLOURING, the distinction between V_S and $V_{\bar{S}}$ is determined by the edges of $B \times N$. \square

The next lemma identify some unique features of a tropical graph to simplify the problem into a list-homomorphism problem.

Definition 2.10. *A Unique Tropical Feature in a tropical graph (H, c) is a vertex or an edge of H that satisfies one of the following conditions.*

Type 1. *A vertex u of H whose colour class is $\{u\}$.*

Type 2. *An edge uv of H such that there is no other edge in H whose vertices are coloured $c(u)$ and $c(v)$, respectively.*

Type 3. *A vertex u of H such that $N(u)$ is monochromatic in (H, c) with colour s , and every vertex coloured s that does not belong to $N(u)$ has no neighbour coloured with $c(u)$.*

Type 4. *A forcing vertex u of H such that for each pair v, w of distinct vertices in $N(u)$, there is no path $v'u'w'$ in $H - u$ with $c(v) = c(v')$, $c(u) = c(u')$ and $c(w) = c(w')$.*

Definition 2.11. *Let (H, c) be a tropical graph and S a set of Unique Tropical Features of (H, c) . S is partitioned into four sets as $S = S_1 \cup S_2 \cup S_3 \cup S_4$, where S_i is the set of unique tropical features of type i in S . We define $H(S)$ as follows : $V(H(S)) = (V(H) \cup \{u_v | u \in S_4, v \in N(u)\}) \setminus (S_1 \cup S_3 \cup S_4)$ and $E(H(S)) = (E(H[V(H(S))]) \setminus S_2) \cup \{u_v v | u \in S_4, v \in N(u)\}$.*

In other words, $H(S)$ is the graph obtained from H by removing unique tropical features of type 1, 2, and 3, and for each unique tropical feature u of type 4, replacing $N[u]$ by $d(u)$ pending edges.

Lemma 2.12. *Let (H, c) be a tropical graph and S a set of unique tropical features of (H, c) . If $(H(S))$ -LIST-COLOURING is polynomial-time solvable, then (H, c) -COLOURING is polynomial-time solvable.*

Proof. Let (G, c') be an instance of (H, c) -COLOURING. We are going to construct a graph G' and associate to each vertex of G' a list of vertices of $H(S)$ such that there is a list-homomorphism from G' to $H(S)$ (with respect to these lists) if and only if there is a tropical homomorphism of (G, c') to (H, c) . We proceed with sequential modifications, by considering the unique tropical features of S one by one.

First, we can see the instance (G, c') of (H, c) -COLOURING as an instance of H -LIST-COLOURING by giving to each vertex u in G the list $L(u)$ of vertex in H coloured $c'(u)$. If at any point in the following, we update the list of a vertex to be empty, we can conclude that there is no tropical homomorphism between (G, c') and (H, c) .

For each unique tropical feature u of type 1 in S , there is a colour s such that only the vertex u is coloured s in (H, c) . Every vertex in (G, c') coloured s must be mapped to u and has a list of size at most one. For each vertex v in (G, c') coloured s , we update the list of each of its neighbours w such that $L(w)$ becomes $L(w) \cap N(u)$. We can then delete v from (G, c') and forget $L(v)$ without affecting the existence of a list-homomorphism. Indeed, if a homomorphism exists, then it must map each neighbour of v to a neighbour of u . Moreover, there is no other vertex of (G, c') that can be mapped to u .

For each unique tropical feature uv of type 2 in S , there is no other edge than uv in H such that the colour of its vertices are $c(u)$ and $c(v)$. Every edge in (G, c') whose vertices are coloured $c(u)$ and $c(v)$ must be mapped to uv . For each edge xy in (G, c') such that $c'(x) = c(u)$ and $c'(y) = c(v)$, we update the list of x and y such that $L(x)$ becomes $L(x) \cap \{u\}$ and $L(y)$ becomes $L(y) \cap \{v\}$. We can then delete the edge xy from (G, c') without changing the existence of a list-homomorphism. Indeed, if a homomorphism exists, it must map x to u and y to v . Again, there is no other edge of (G, c') that can be mapped to uv .

For each unique tropical feature u of type 3 in S , $N(u)$ is monochromatic in (H, c) of colour s and any vertex coloured s with a neighbour coloured $c(u)$ must belong to $N(u)$. Let v be a vertex of G such that $c(v) = c(u)$ and $N(v)$ is monochromatic in (G, c') of colour s . Then, we can assume that v is mapped to u . Indeed, in every tropical homomorphism of (G, c') to (H, c) , if v is not mapped to u , it is mapped to a vertex at distance 2 from u , and one obtains another valid tropical homomorphism by only changing the mapping of v to u . For each such vertex v , we update the list of its neighbours w such that $L(w)$ becomes $L(w) \cap N(u)$. We can then delete v from (G, c') without affecting the existence of a list-homomorphism. Indeed, if a homomorphism exists, it maps every neighbour of v to a neighbour of u . Moreover, there no other vertex of (G, c') can be mapped to u .

Finally, let u be a vertex of type 4 in S . Thus, by the definition of type 4, for each $v, w \in N(u)$, there is no other path $v'u'w'$ in H such that $c(v) = c(v')$, $c(u) = c(u')$ and $c(w) = c(w')$. Furthermore, since u is a forcing vertex, we have $c(v) \neq c(w)$ for any two neighbours v and w of u .

Let x be a vertex of G such that $c'(x) = c(u)$ and such that at least two neighbours of x are of colours $c(v)$ or $c(w)$, one of each. Then, as x is of type 4, any homomorphism of (G, c') to (H, c) must map all such vertices x to u . Remove all such vertices from G and let (G', c') be the remaining tropical graph. For any vertex y of G' if it is of colour $c(u)$, it may then either map to another vertex of this colour, or all its neighbours must map a same neighbour of u . Let (H_1, c) be a tropical graph obtained from (H, c) by removing the vertex u , and then adding one new vertex for each vertex in $N_H(u)$ and assigning the colour $c(u)$ to it. It follows that (G', c') admits a homomorphism to (H', c) if and only if (G, c') admits a homomorphism to (H, c) , proving our claim.

In conclusion, we have built an instance (G', L) of $H(S)$ -LIST-COLOURING that maps to $H(S)$ if and only if (G, c') maps to (H, c) , thus proving our claim. We remark, furthermore, that these changes used to introduced (G', L) and $H(S)$ are compatible even between different types of vertices, thus we may allow S to contain a combination of such vertices. However, in this work we will only consider sets S whose elements are all of a same type. □

3 (H, c) -Colouring and the Dichotomy Conjecture

Since each (H, c) -COLOURING problem is a CSP, the Feder–Vardi Dichotomy Conjecture (Conjecture 1.1) would imply a complexity dichotomy for the class of (H, c) -COLOURING problems. As mentioned

before a proof of the conjecture has been recently announced, thus every (H, c) -COLOURING is either polynomial time solvable or it is an NP-complete problem. Here we point out that an independent proof even on a very restricted set of (H, c) would also prove the original conjecture.

Following the construction of Feder and Vardi ([20, Theorem 10]) and based on its exposition in the book by Hell and Nešetřil [22, Theorem 5.14], one can modify their gadgets to prove a similar statement for the class of 2-tropical bipartite graph homomorphism problems.

Theorem 3.1. *For each CSP template T there is a 2-coloured graph (H, c) such that (H, c) -COLOURING and T -CSP are polynomially equivalent. Moreover, (H, c) can be chosen to be bipartite and homomorphic to a 2-coloured forcing path.*

Proof. We follow the proof of Theorem 5.14 in the book [22] proving a similar statement for digraph homomorphism problems. The structure of the proof in [22] is as follows. First, one shows that for each CSP template T , there is a bipartite graph H such that the T -CSP problem and the H -RETRACTION problem are polynomially equivalent. Next, it is shown that for each bipartite graph H there is a digraph H' such that H -RETRACTION and H' -RETRACTION are polynomially equivalent. Finally it is observed that H' is a core and thus H' -RETRACTION and (H', c) -COLOURING are polynomially equivalent. We adapt this proof to the case of 2-tropical graph homomorphism problems.

The construction of H' from H in [22] is through the use of so-called zig-zag paths. In our case, we replace these zig-zag paths by specific 2-coloured graphs that play the same role. This will allow us to construct a 2-coloured graph H' from a bipartite graph H such that H -RETRACTION and H' -RETRACTION are polynomially equivalent. Our paths will have black vertices denoted by B and white vertices denoted by W . Hence the path WB^4W^4B consists of one white vertex, four black vertices, four white vertices and a black vertex. The maximal monochromatic subpaths are called *runs*. Thus the above path is the concatenation of four runs: the first and last of length 1, the middle two of length 4.

Given an odd integer ℓ , we construct a path P consisting of ℓ runs. The first and the last run each consist of a single white vertex. The interior runs are of length four. We denote that last (rightmost) vertex of P by 0. From P we construct $\ell - 2$ paths $P_1, \dots, P_{\ell-2}$. Path P_i ($i = 1, 2, \dots, \ell - 2$) is obtained from P by replacing the i^{th} run of length four with a run of length 2. We denote the rightmost vertex of P_i by i .

Similarly, for an even integer k , we construct a second family of paths Q and Q_j , ($j = 1, 2, \dots, k - 2$). The leftmost vertex of Q is 1 and the leftmost vertex of Q_j is j . The paths are described below:

$$\begin{array}{ll}
P & := W \underbrace{B^4 W^4 \dots W^4 B^4}_{} W \\
P_i & := W \underbrace{B^4 \dots W^4}_{\ell-2} B^2 \underbrace{W^4 \dots B^4}_{} W \quad (i \text{ odd}) \\
P_i & := W \underbrace{B^4 \dots B^4}_{i-1} W^2 \underbrace{B^4 \dots B^4}_{\ell-i-2} W \quad (i \text{ even}) \\
Q & := W \underbrace{B^4 W^4 \dots B^4 W^4}_{} B \\
Q_j & := W \underbrace{B^4 \dots W^4}_{k-2} B^2 \underbrace{W^4 \dots W^4}_{} B \quad (j \text{ odd}) \\
Q_j & := W \underbrace{B^4 \dots B^4}_{j-1} W^2 \underbrace{B^4 \dots W^4}_{k-j-2} B \quad (j \text{ even})
\end{array}$$

We observe the following (c.f. page 156 of [22]):

1. The paths P and P_i ($i = 1, 2, \dots, \ell - 2$) each admit a homomorphism onto a 2-colour forcing path of length $2\ell - 1$, (that is, a path consisting of one run of length 1, $\ell - 2$ runs each of length 2 and a final run of length 1: $WBBWWB \dots W$).
2. The paths Q and Q_j ($j = 1, 2, \dots, k - 2$) each admit a homomorphism onto a 2-colour forcing path of length $2k - 1$.
3. $P_i \rightarrow P_{i'}$ implies $i = i'$.
4. $Q_j \rightarrow Q_{j'}$ implies $j = j'$.
5. $P \rightarrow P_i$ for all i .
6. $Q \rightarrow Q_j$ for all j .
7. if X is a 2-tropical graph and x is a vertex of X such that $f : X \rightarrow P_i$ and $f' : X \rightarrow P_{i'}$ for $i \neq i'$ with $f(x) = i$ and $f'(x) = i'$, then there is a homomorphism $F : X \rightarrow P$ with $F(x) = 0$.

8. if Y is a 2-tropical graph and y is a vertex of Y such that $f : Y \rightarrow Q_j$ and $f' : Y \rightarrow Q_{j'}$ for $j \neq j'$ with $f(y) = j$ and $f'(y) = j'$, then there is a homomorphism $F : Y \rightarrow Q$ with $F(y) = 1$.

We note that 2-colour forcing paths in 2-tropical graphs can be used to define *height* analogously to height in directed acyclic graphs. More precisely, suppose G is a connected 2-tropical graph that admits a homomorphism onto a 2-colour forcing path, say FP , of even length. Let the vertices of FP be h_0, h_1, \dots, h_{2t} . Observe that each vertex in the path has at most one white neighbour and at most one black neighbour. Thus once a single vertex u in G is mapped to FP , the image of each neighbour of u is uniquely determined and by connectivity, the image of all vertices is uniquely determined. In particular, as G maps *onto* FP , there is exactly one homomorphism of G to the path. (More precisely, if the path has length congruent to 0 modulo 4, there is an automorphism that reverses the path. In this case there are two homomorphisms that are equivalent up to the reversing.) We then observe that if $g : G \xrightarrow{\text{onto}} FP$, $h : H \rightarrow FP$, and $f : G \rightarrow H$, then for all vertices $u \in V(G)$, $g(u) = h(f(u))$. This allows us to define the height of $u \in V(G)$ to be h_i when $g(u) = h_i$. Specifically, vertices at height h_i in G must map to vertices at height h_i in H .

For each problem T in CSP there is a bipartite graph H such that T -CSP and H -RETRACTION are equivalent [20, 22]. Let H be a bipartite graph with parts (A, B) , with $A = \{a_1, \dots, a_{|A|}\}$ and $B = \{b_1, \dots, b_{|B|}\}$. Let ℓ (respectively k) be the smallest odd (respectively even) integer greater than or equal to $|A|$ (respectively $|B|$). To each vertex $a_i \in A$ attach a copy of P_i identifying i in P_i with a_i in A . Colour all original vertex of H white. To each vertex $b_j \in B$ attach a copy of Q_j identifying j in Q_j with b_j in B . Call the resulting 2-tropical graph (H', c) . See Figure 1 for an illustration.

Let G be an instance of H -RETRACTION. In particular, we may assume without loss of generality that H is a subgraph of G , G is connected, and G is bipartite. We colour the original vertices of G white. Let (A', B') be the partite classes of G where $A \subseteq A'$ and $B \subseteq B'$. To each vertex v of $A' \setminus A$, we attach a copy of P , identifying v and 0. To the vertices of $A \cup B$, we attach paths P_i and Q_j as described above to create a copy of H' . Call the resulting 2-tropical graph (G', c') . In particular, note that (G', c') and (H', c') both map onto a 2-colour forcing path of length $2\ell + 2k - 1$. The (original) vertices of G and H are at height $2\ell - 1$ and 2ℓ for colour classes A and B respectively. In particular, by the eight above properties, under any homomorphism $f : G' \rightarrow H'$ the restriction of f to G must map onto H with vertices in A' mapping to A and vertices in B' mapping to B .

Using the eight properties of the paths above and following the proof of Theorem 5.14 in [22], we conclude that G is a YES instance of H -RETRACTION if and only if (G', c') is a YES instance of (H', c) -RETRACTION.

On the other hand, let (G', c') be an instance of (H', c) -RETRACTION. We sketch the proof from [22]. We observe that (G', c') must map to a 2-colour forcing path of length $2\ell + 2k - 1$. The two levels of G' corresponding to H induce a bipartite graph (with white vertices) which we call G . The components of $G' - E(G)$ fall into two types: those which map to lower levels and those that map to higher levels than G . Let C_t be a component that maps to a lower level. After required identifications we may assume C_t contains only one vertex from G (say v) and C_t must map to some P_i . If P_i is the unique P_i path to which C_t maps, then we modify G' by identifying v and i . Otherwise, C_t maps to two paths and (by the properties 5–8) hence to all paths. The resulting graph (G', c') retracts to (H', c) if and only if G retracts to H . \square

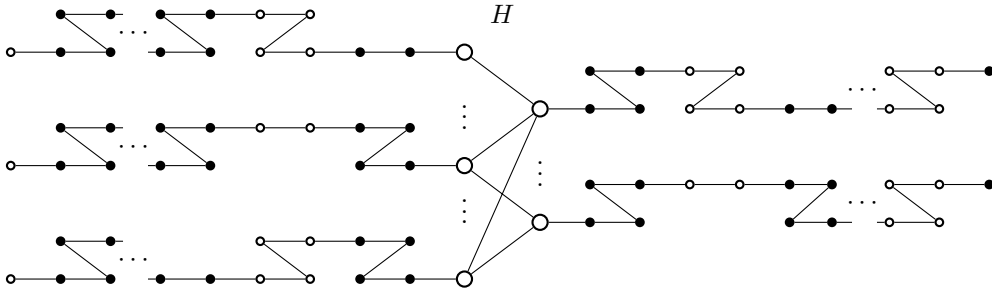

Figure 1: Construction of a 2-tropical target H' from a H -RETRACTION problem.

4 Minimal graphs H for NP-complete H -List-Colouring

Recall the dichotomy theorem for list homomorphism problems of Feder, Hell and Huang (Theorem 1.5): H -LIST-COLOURING is polynomial-time solvable if H is bipartite and its complement is a circular arc graph, otherwise NP-complete. Alternatively, the latter class of graphs was characterized by Trotter and Moore [29] in terms of seven families of forbidden induced subgraphs: six infinite ones and a finite one. See their descriptions in Table 1, as reproduced from [17]. To concisely describe these seven families, they employ the following notation: Let $\mathcal{F} = \{S_i : 1 \leq i \leq k\}$ be a family of subsets of $\{1, 2, \dots, \ell\}$. Define $H_{\mathcal{F}}$ to be the bipartite graph (X, Y) with $X = \{x_1, x_2, \dots, x_\ell\}$ and $Y = \{y_1, y_2, \dots, y_k\}$ such that $x_i y_j$ is an edge if and only if $i \in S_j$. The families \mathcal{C} , \mathcal{T} , \mathcal{W} , \mathcal{D} , \mathcal{M} , \mathcal{N} and \mathcal{G} in Table 1 are defined in this way. Note that the graph C_i in \mathcal{C} is the cycle of length i . See Figure 2 for an illustration of the other families from Table 1. Also note that G_1 , which is a claw where each edge is subdivided twice, is the only tree in the table.

Given the above characterization, we can reformulate Theorem 1.5 as follows.

Theorem 4.1 (Restatement of Theorem 1.5, Feder, Hell and Huang [17]). *If H contains one of the graphs defined in Table 1 as an induced subgraph, then H -LIST-COLOURING is NP-complete. Otherwise, H -LIST-COLOURING is polynomial-time solvable.*

$C_6 = \{\{1, 2\}, \{2, 3\}, \{3, 1\}\}$
$C_8 = \{\{1, 2\}, \{2, 3\}, \{3, 4\}, \{4, 1\}\}$
$C_{10} = \{\{1, 2\}, \{2, 3\}, \{3, 4\}, \{4, 5\}, \{5, 1\}\}$
...
$T_1 = \{\{1, 2\}, \{2, 3\}, \{3, 4\}, \{2, 3, 5\}, \{5\}\}$
$T_2 = \{\{1, 2\}, \{2, 3\}, \{3, 4\}, \{4, 5\}, \{2, 3, 4, 6\}, \{6\}\}$
$T_3 = \{\{1, 2\}, \{2, 3\}, \{3, 4\}, \{4, 5\}, \{5, 6\}, \{2, 3, 4, 5, 7\}, \{7\}\}$
...
$W_1 = \{\{1, 2\}, \{2, 3\}, \{1, 2, 4\}, \{2, 3, 4\}, \{4\}\}$
$W_2 = \{\{1, 2\}, \{2, 3\}, \{3, 4\}, \{1, 2, 3, 5\}, \{2, 3, 4, 5\}, \{5\}\}$
$W_3 = \{\{1, 2\}, \{2, 3\}, \{3, 4\}, \{4, 5\}, \{1, 2, 3, 4, 6\}, \{2, 3, 4, 5, 6\}, \{6\}\}$
...
$D_1 = \{\{1, 2, 5\}, \{2, 3, 5\}, \{3\}, \{4, 5\}, \{2, 3, 4, 5\}\}$
$D_2 = \{\{1, 2, 6\}, \{2, 3, 6\}, \{3, 4, 6\}, \{4\}, \{5, 6\}, \{2, 3, 4, 5, 6\}\}$
$D_3 = \{\{1, 2, 7\}, \{2, 3, 7\}, \{3, 4, 7\}, \{4, 5, 7\}, \{5\}, \{6, 7\}, \{2, 3, 4, 5, 6, 7\}\}$
...
$M_1 = \{\{1, 2, 3, 4, 5\}, \{1, 2, 3\}, \{1\}, \{1, 2, 4, 6\}, \{2, 4\}, \{2, 5\}\}$
$M_2 = \{\{1, 2, 3, 4, 5, 6, 7\}, \{1, 2, 3, 4, 5\}, \{1, 2, 3\}, \{1\}, \{1, 2, 3, 4, 6, 8\}, \{1, 2, 4, 6\}, \{2, 4\}, \{2, 7\}\}$
$M_3 = \{\{1, 2, 3, 4, 5, 6, 7, 8, 9\}, \{1, 2, 3, 4, 5, 6, 7\}, \{1, 2, 3, 4, 5\}, \{1, 2, 3\}, \{1\}, \{1, 2, 3, 4, 5, 6, 8, 10\}, \{1, 2, 3, 4, 6, 8\}, \{1, 2, 4, 6\}, \{2, 4\}, \{2, 9\}\}$
...
$N_1 = \{\{1, 2, 3\}, \{1\}, \{1, 2, 4, 6\}, \{2, 4\}, \{2, 5\}, \{6\}\}$
$N_2 = \{\{1, 2, 3, 4, 5\}, \{1, 2, 3\}, \{1\}, \{1, 2, 3, 4, 6, 8\}, \{1, 2, 4, 6\}, \{2, 4\}, \{2, 7\}, \{8\}\}$
$N_3 = \{\{1, 2, 3, 4, 5, 6, 7\}, \{1, 2, 3, 4, 5\}, \{1, 2, 3\}, \{1\}, \{1, 2, 3, 4, 5, 6, 8, 10\}, \{1, 2, 3, 4, 6, 8\}, \{1, 2, 4, 6\}, \{2, 4\}, \{2, 9\}, \{10\}\}$
...
$G_1 = \{\{1, 3, 5\}, \{1, 2\}, \{3, 4\}, \{5, 6\}\}$
$G_2 = \{\{1\}, \{1, 2, 3, 4\}, \{2, 4, 5\}, \{2, 3, 6\}\}$
$G_3 = \{\{1, 2\}, \{3, 4\}, \{5\}, \{1, 2, 3\}, \{1, 3, 5\}\}$

Table 1: Six infinite families \mathcal{C} , \mathcal{T} , \mathcal{W} , \mathcal{D} , \mathcal{M} , \mathcal{N} and family \mathcal{G} of size 3 of forbidden induced subgraphs for polynomial-time H -LIST-COLOURING problems.

In this section, we first turn our attention to the family of even cycles of length at least 6. We show that C_{2k} -TROPICAL-COLOURING is polynomial-time solvable for any $k \leq 6$. On the other hand, for any $k \geq 24$, C_{2k} -TROPICAL-COLOURING is NP-complete. We then prove that for all other minimal graphs H described in Table 1, H -TROPICAL-COLOURING is polynomial-time solvable.

time solvable.

We will consider all cases $k \in \{3, 4, 5, 6\}$ separately. But in each of those cases we note that if (C_{2k}, c) is not a core, then the core is path, and since the P_k -LIST-COLOURING is polynomial-time solvable for any $k \geq 1$, C_{2k} -TROPICAL-COLOURING would also be polynomial-time solvable. Hence in the rest of the proof we always assume (C_{2k}, c) is a core. Furthermore, by Proposition 2.3, we can assume that the colour sets of c in X and Y are disjoint.

First, assume $k = 3$. There are three vertices in each part of the bipartition of C_6 . If one vertex is coloured with a colour not present anywhere else in the part, Lemma 2.12 implies again that (C_6, c) -COLOURING is polynomial-time solvable. Hence, we can assume that each part of the bipartition is monochromatic. But then (C_6, c) is not a core, a contradiction with our assumption.

Suppose $k = 4$. There are four vertices in each part of the bipartition (X, Y) of C_8 . If there is a vertex that, in c , is the only one coloured with its colour, since P_k -LIST-COLOURING is polynomial-time solvable for any $k \geq 1$, by Lemma 2.12 (C_8, c) -COLOURING is polynomial-time solvable. Hence we may assume that each colour appears at least twice, in particular each part of the bipartition is coloured with either one or two colours. If some part, say X , is coloured with only one colour (say Blue) then (C_8, c) is not a core which again contradicts our assumption. Hence, in each part, there are exactly two vertices of each colour. In this case we can use Lemma 2.6 with S_1, S_2, S_3 and S_4 being the four sets of two vertices with the same colour. It follows that (C_8, c) -COLOURING is polynomial-time solvable.

Assume that $k = 5$, and let c be a vertex-colouring of C_{10} . By similar arguments as in the proof of Theorems 5.1 and 6.1, using Lemma 2.12 and the fact that (H, c) should not be homomorphic to a P_2 - or P_3 -subgraph, each part of the bipartition (X, Y) contains exactly two vertices of one colour and three vertices of another colour, say X has three vertices coloured 1 and two vertices coloured 2, and Y has three vertices coloured a and two vertices coloured b .

The cyclic order of the colours of X can be either $1-1-1-2-2$ or $1-1-2-1-2$ (up to permutation of colours and other symmetries). If this order is $1-1-1-2-2$, then the vertex of Y adjacent to the two vertices coloured 2 satisfies the hypothesis of Lemma 2.12 and hence (C_{10}, c) -COLOURING is polynomial-time solvable. The same argument can be applied to Y , hence the cyclic order of the colours of Y is $a-a-b-a-b$.

Hence, there is a unique vertex y of Y whose two neighbours are coloured 1. If $c(y) = b$, then the second vertex of Y coloured b is in the centre of a 3-vertex path coloured $1-b-2$ that satisfies the hypothesis of Lemma 2.12, hence (C_{10}, c) -COLOURING is polynomial-time solvable. Therefore, we have $c(y) = a$. By the same argument, the unique vertex of X adjacent to two vertices of Y coloured a must be coloured 1. Therefore, up to symmetries c is one of the three colourings $1-a-1-a-2-b-1-a-2-b$, $1-a-1-b-2-a-1-a-2-b$ and $1-a-1-b-2-a-1-b-2-a$ (in the cyclic order).

We are going to use the Lemma 2.6 to conclude the case $k = 5$. In a homomorphism to (C_{10}, c) , a vertex coloured 2 or b can only be mapped to the two vertices in (C_{10}, c) of the corresponding colour. A vertex v coloured 1 adjacent to at least one vertex coloured b or a vertex coloured a adjacent to at least one vertex coloured 2 also can only be mapped to two vertices of (C_{10}, c) (the ones having the same properties as v). However, a vertex coloured 1 all whose neighbours are coloured a can be mapped to three different vertices in (C_{10}, c) (say x_1, x_2, x_3 , the vertices coloured 1, that all have a neighbour coloured a). But at least one of x_1, x_2, x_3 , say x_1 , has a common neighbour coloured a with one of the two other vertices (say x_2). Therefore, if there is a homomorphism h of some tropical graph (G, c_1) to (C_{10}, c) mapping a vertex v of G coloured 1 all whose neighbours are coloured a to x_1 , we can modify h so that v is mapped to x_2 instead. In other words, there is a homomorphism of (G, c_1) to (C_{10}, c) where none of the vertices coloured 1 all whose neighbours are coloured a is mapped to x_1 . Therefore such vertices have two possible targets: x_2 and x_3 . The same is true for vertices coloured a all whose neighbours are coloured 1. Thus, (C_{10}, c) satisfies the hypothesis of Lemma 2.6 and (C_{10}, c) -COLOURING is polynomial-time solvable.

Finally, assume now that $k = 6$. Again, using Lemma 2.12, we can assume than each part of the bipartition has at most three colours, and each colour appears at least twice. Furthermore, if there are exactly three colours in each part, each colour appears exactly twice and hence (C_{12}, c) -COLOURING is polynomial-time solvable by Lemma 2.6. If one part of the bipartition has one colour and the other has at most two colours, then (C_{12}, c) would not be a core. Therefore, the numbers of colours of the parts in the bipartition are either one and three, two and three, or two and two.

Assume that one part, say X , is monochromatic (say Red) and the other, Y , has three colours (thus two vertices of each colour). For the graph to be a core and not satisfy Lemma 2.12, the three colours of Y must form the cyclic pattern $x - y - z - x - y - z$. In this case, considering any vertex v of colour Red in an input tropical graph (G, c_1) , in any homomorphism $(G, c_1) \rightarrow (C_{12}, c)$, all the neighbours of v with the same colour must be identified. Furthermore, no Red vertex in (G, c_1) can have neighbours of three distinct colours. Therefore, the mapping of each connected component is forced after making a choice for one vertex. Since there are two choices per vertex, we have a polynomial-time algorithm for (C_{12}, c) -COLOURING.

Assume now that one part, say X , contains two colours (a and b) and the other, Y , contains three colours (x , y and z). Note that there are exactly two vertices of each colour in Y . We are going to use Lemma 2.6 to conclude this case. A vertex of some input graph (G, c_1) coloured x , y or z can only be mapped to two possible vertices in (C_{12}, c) . A vertex of (G, c_1) coloured a or b (say a) and having all its neighbours of the same colour, say x , might be mapped to more than two vertices of (C_{12}, c) . However, once again, there are always two of these vertices that, together, are adjacent to all the vertices of colour x (indeed, there are only two vertices of colour x). These two vertices are the designated targets for Lemma 2.6. A vertex coloured a (or b) with two different colours in its neighbourhood can only be mapped to two possible vertices if there is no pattern $x - a - y - a - x - a - y$ in the graph (up to permutation of colours). Hence, if there is no such pattern in the graph (up to permutation of colours), (C_{12}, c) satisfies the hypothesis of Lemma 2.6 and (C_{12}, c) -COLOURING is polynomial-time solvable. On the other hand, if there is a pattern $x - a - y - a - x - a - y$ in the graph, then there is a unique path coloured $a - x - b$ or $a - y - b$ in the graph and, by Lemma 2.12, (C_{12}, c) -COLOURING is polynomial-time solvable as well.

Therefore, we are left to consider the cases where there are exactly two colours in each part. We assume first that there are two vertices coloured a and four vertices coloured b in one part, say X . If the neighbours of vertices of colour a all have the same colour, say x , then (C_{12}, c) is not a core because it can be mapped to its sub-path coloured $a - x - b - y$. We suppose without loss of generality that the coloured cycle contains a path coloured $y - a - x - b$. Then, if there is no other path coloured $y - a - x - b$, by Lemma 2.12 (C_{12}, c) -COLOURING is polynomial-time solvable. Therefore, there is another such path in (C_{12}, c) . If this other path is part of a path $x - a - y - a - x$, then the problem is polynomial-time solvable by applying Lemma 2.12 to the star $a - y - a$. Up to symmetry, we are left with two cases: $y - a - x - b - . - b - . - a - . - b - . - b$ or $y - a - x - b - . - b - . - b - . - a - . - b$ (where a dot could be colour x or y). The first case must be $y - a - x - b - . - b - y - a - x - b - . - b$, because otherwise, (C_{12}, c) is not a core. Any placement of the remaining x 's and y 's yields a polynomial-time solvable case using Lemma 2.8. Similarly, the second case must be $y - a - x - b - . - b - . - b - y - a - x - b$. Then, (C_{12}, c) -COLOURING is polynomial-time solvable because of Lemma 2.9, with $a - x - b - y - a$ as forcing set and $x - b - . - b - . - b - y$, which contains no vertex coloured a , as the other set.

Finally, we can assume, without loss of generality, that there are exactly three vertices for each of the two colours in each part. There are three possible configurations in each part: $a - a - a - b - b - b$, $a - a - b - b - a - b$ or $a - b - a - b - a - b$, up to permutations of colours. If one part of the bipartition is in the first configuration, then, either we have the pattern $a - x - b$ or $a - y - b$ that satisfies the hypothesis of Lemma 2.12, or we have two paths $a - x - b$, in which case, there is a unique path $a - y - a$ or $b - y - b$ which satisfies the hypothesis of Lemma 2.12. Suppose some part of the bipartition is in the second case. Then, if we have the pattern $a - x - a - . - b - x - b - . - a - . - b - .$, there is a unique path $a - x - b$ satisfying the hypothesis of Lemma 2.12. Otherwise, we have the pattern $a - x - a - . - b - y - b - . - a - . - b - .$, in which case we can apply Lemma 2.6 in a similar way as for C_{10} . Therefore, both parts of the bipartition must be in the third configuration. But then every vertex is a forcing vertex and we can apply Lemma 2.5. This completes the proof. \square

4.2 NP-completeness results for even cycles

We now show that C_{2k} -TROPICAL-COLOURING is NP-complete whenever $k \geq 24$. We present a proof using a specific 4-tropical 48-cycle. The proof holds similarly for any larger even cycle. It also works similarly for some 3-tropical cycles C_{2k} for $k \geq 24$ and for 2-tropical cycles C_{2k} for $k \geq 27$.

We use the colour set $\{G, B, R, Y\}$ (for Green, Blue, Red and Yellow).

We define $P_{x,y}$ to be a tropical path of length 8, with vertices $x = x_0, x_1, \dots, x_7, x_8 = y$ where $\{c(x), c(y)\} = \{G, B\}$, $c(x_5) = R$ and all others are coloured Yellow. Thus, $P_{x,y}$ represents one of the two

non-isomorphic tropical graphs from Figure 3. The distance of the only vertex of colour R from the two ends defines an orientation from one end to another. Thus, in our figures, an arc between two vertices u and v is a P_{uv} path.

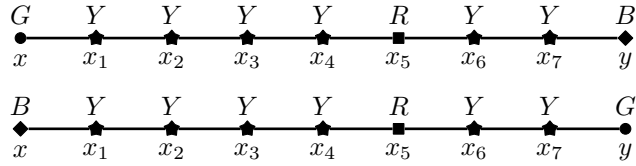

Figure 3: The two non-isomorphic graphs of type P_{xy} .

Similarly, $Q_{z,t}$ is defined to be a tropical path of length 10 with vertices $z = z_0, z_1, \dots, z_9, z_{10} = t$ where $\{c(z), c(t)\} = \{G, B\}$, $c(z_5) = R$ and all others are coloured Yellow. See Figure 4 for an illustration. In this case, as the only vertex of colour R is at the same distance from both ends, the two possible colourings of the end-vertices correspond to isomorphic graphs. Hence, in our figures, a dotted edge will be used to represent a Q -type path between two vertices.

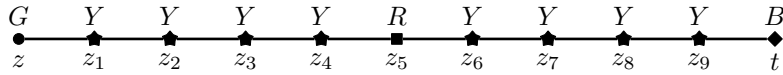

Figure 4: The Q -type path $Q_{z,t}$.

The following lemma is easy to observe.

Lemma 4.3. *The following is true.*

1. $P_{x,y}$ admits a tropical homomorphism to $P_{u,v}$ if and only if $c(x) = c(u)$ and $c(y) = c(v)$.
2. $Q_{z,t}$ admits a tropical homomorphism to $P_{u,v}$ both in the case where $c(z) = c(u)$ and $c(t) = c(v)$, and in the case where $c(z) = c(v)$ and $c(t) = c(u)$.

By Lemma 4.3, in our abbreviated notation of arcs and dotted edges, a dotted edge can map to a dotted edge or to an arc as long as the colours of the end-vertices are preserved. However, to map an arc to another arc, not only the colours of the end-vertices must be preserved, but also the direction of the arc.

With our notation, the tropical directed 6-cycle of Figure 5 corresponds to a 4-tropical 48-cycle, (C_{48}, c) .

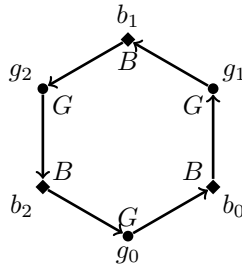

Figure 5: A short representation of the 4-tropical 48-cycle (C_{48}, c) .

Our aim is to show that NAE 3-SAT reduces (in polynomial time) to (C_{48}, c) -COLOURING.

Theorem 4.4. *For any $k \geq 24$, C_{2k} -TROPICAL-COLOURING is NP-complete.*

Proof. We prove the statement when $k = 24$ and observe that the same reduction holds for any $k \geq 24$. Indeed, one can make $P_{x,y}$ and $Q_{z,t}$ longer while still satisfying Lemma 4.3.

(C_{48}, c) -COLOURING is clearly in NP. To show NP-hardness, we show that NAE 3-SAT can be reduced in polynomial-time to (C_{48}, c) -COLOURING.

Let (X, C) be an instance of NAE 3-SAT. To partition X into two parts, it is enough to decide, for each pair of elements of X , whether they are in a same part or not. Thus, we are expected to define a binary relation among variables which satisfies the following conditions.

1. $X_p \sim X_q \wedge X_q \sim X_r \Rightarrow X_q \sim X_r$ (Partition)
2. $X_p \not\sim X_q \wedge X_q \not\sim X_r \Rightarrow X_p \sim X_r$ (Partition into two parts)

To build our gadget, we start with a partial gadget associated to each pair of variables of X . To each pair $x_i, x_j \in X$, we associate the 4-tropical 6-cycle $(C_{x_i x_j}, c)$ of Figure 6. Here, U_G (coloured Green) is a common vertex of all such cycles, but all other vertices are distinct.

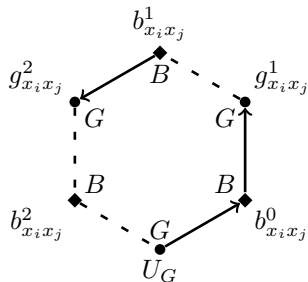

Figure 6: $(C_{x_i x_j}, c)$

We are interested in possible mappings of this partial gadget into our tropical 48-cycle, (C_{48}, c) of Figure 5. By the symmetries of (C_{48}, c) , we assume, without loss of generality, that U_G maps to g_0 . Having this assumed, we observe the following crucial fact.

Claim 4.5. *There are exactly two possible homomorphisms of $(C_{x_i x_j}, c)$ to (C_{48}, c) .*

1. A mapping σ given by $\sigma(U_G) = g_0$, $\sigma(b_{x_i x_j}^0) = b_0$, $\sigma(g_{x_i x_j}^1) = g_1$, $\sigma(b_{x_i x_j}^1) = b_1$, $\sigma(g_{x_i x_j}^2) = g_2$ and $\sigma(b_{x_i x_j}^2) = b_2$
2. A mapping ρ given by $\rho(U_G) = g_0$, $\rho(b_{x_i x_j}^0) = b_0$, $\rho(g_{x_i x_j}^1) = g_1$, $\rho(b_{x_i x_j}^1) = b_0$, $\rho(g_{x_i x_j}^2) = g_1$ and $\rho(b_{x_i x_j}^2) = b_0$

The main idea of our reduction lies in Claim 4.5. After completing the description of our gadgets, we will have a 4-tropical graph containing a copy of $C_{x_i x_j}$ for each pair x_i, x_j of variables. If we find a homomorphism of this graph to (C_{48}, c) , then its restriction to $C_{x_i x_j}$ is either a mapping of type σ , or of type ρ . A σ -mapping would correspond to assigning x_i and x_j to two different parts, and a ρ -mapping would correspond to assigning them to a same part of a partition of X .

Observation 4.6. *It is never possible to map $b_{x_i x_j}^2$ to b_1 or to map $b_{x_i x_j}^1$ to b_2 .*

To enforce the two conditions, partitioning X into two parts by a binary relation, we add more structures. Consider the three partial gadgets $(C_{x_p x_q}, c)$, $(C_{x_q x_r}, c)$ and $(C_{x_p x_r}, c)$. Considering $b_{x_p x_q}^1$ of $(C_{x_p x_q}, c)$, we choose vertices $b_{x_p x_r}^2$ and $b_{x_q x_r}^2$ from $(C_{x_p x_r}, c)$ and $(C_{x_q x_r}, c)$ respectively, and connect them by a tree as in Figure 7. The internal vertices of these trees are all new and distinct.

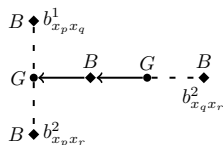

Figure 7: Tree connecting $b_{x_p x_q}^1$, $b_{x_p x_r}^2$ and $b_{x_q x_r}^2$

We build similar structures on $(b_{x_p x_r}^1, b_{x_q x_r}^2, b_{x_p x_q}^2)$ and on $(b_{x_q x_r}^1, b_{x_p x_q}^2, b_{x_p x_r}^2)$, where the order corresponds to the structure. Let $(C_{x_p x_q x_r}, c)$ be the resulting partial gadget (see Figure 8).

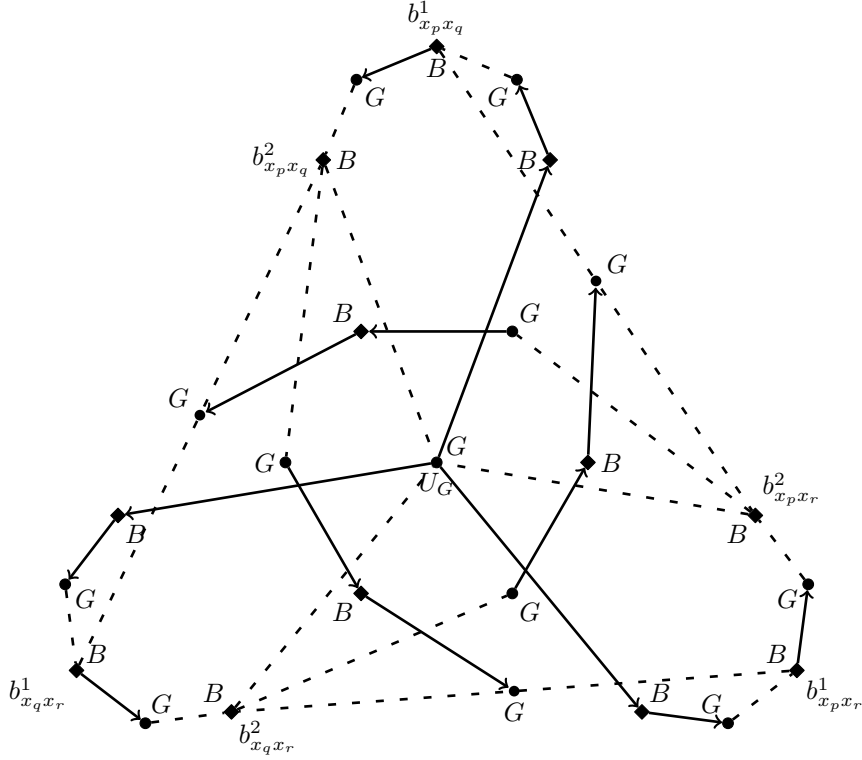

Figure 8: $C_{x_p x_q x_r}$

Claim 4.7. *In any mapping of $(C_{x_p x_q x_r}, c)$ to (C_{48}, c) , an odd number of $(C_{x_i x_j}, c)$ is mapped to (C_{48}, c) by a ρ -mapping. Furthermore, for any choice of an odd number of $(C_{x_i x_j}, c)$ (that is either one or all three of them), there exists a mapping of $(C_{x_p x_q x_r}, c)$ to (C_{48}, c) which induces a ρ -mapping exactly on our choice.*

Proof of claim Indeed, each $(C_{x_i x_j}, c)$ can be mapped to (C_{48}, c) only by σ or ρ , which implies that there are eight ways to map the union of $(C_{x_p x_q}, c)$, $(C_{x_p x_r}, c)$ and $(C_{x_q x_r}, c)$ to (C_{48}, c) . Of these eight ways, four map an odd number of $(C_{x_i x_j}, c)$ to (C_{48}, c) by a ρ -mapping. The four remaining ways are to map all $(C_{x_i x_j}, c)$ to (C_{48}, c) by a σ -mapping, or to choose one of them to map by a σ -mapping and to map the two others by a ρ -mapping. One can check easily that the union of $(C_{x_p x_q}, c)$, $(C_{x_p x_r}, c)$, $(C_{x_q x_r}, c)$ and the tree of Figure 7 has six ways to be mapped to (C_{48}, c) . Indeed, it is no longer possible to map all $(C_{x_i x_j}, c)$ by σ nor to map $(C_{x_p x_r}, c)$ by σ and $(C_{x_p x_q}, c)$ and $(C_{x_q x_r}, c)$ by ρ . By symmetry, this implies Claim 4.7. \square

Finally, to complete the gadget, what remains is to forbid the possibility of a ρ -mapping for all three of $(C_{x_p x_q}, c)$, $(C_{x_p x_r}, c)$ and $(C_{x_q x_r}, c)$ in the case where $(x_p x_q x_r)$ is a clause in C . This is done by adding a $b_{x_p x_q}^1 b_{x_q x_r}^2$ -path shown in Figure 9.

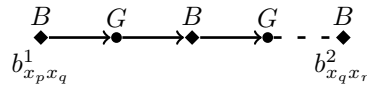

Figure 9: Partial clause gadget.

Let $f(X, C)$ the final gadget we have just built. Assuming that there are v variables and c clauses, the 4-tropical graph $f(X, C)$ has $1 + 53 \times v^2 + 132 \times v^3 + 33 \times c$ vertices. To complete our proof we want to prove the following.

(X, C) is a YES instance of NAE 3-SAT if and only if the 4-tropical graph $f(X, C)$ admits a homomorphism to (C_{48}, c) .

It follows directly from our construction that if $f(X, C) \rightarrow (C_{48}, c)$, then (X, C) is a YES instance of

NAE 3-SAT. We need to show that if (X, C) is a YES instance, then there exists a homomorphism of $f(X, C)$ to (C_{48}, c) .

Let (X, C) be a YES instance of NAE 3-SAT. There exists a partition $p : X \rightarrow \{A, B\}$ such that every clause in C is not fully included in A or B . We build a homomorphism of $f(X, C)$ to (C_{48}, c) in the following way. U_G is mapped to g_0 . For each pair of variables $x_i, x_j \in X$, we map $C_{x_i x_j}$ by a ρ -mapping if and only if $p(x_i) = p(x_j)$, and by a σ -mapping otherwise. For every triple of variable $x_p, x_q, x_r \in X$, there is an odd number of pairs x_i, x_j of variables in $\{x_p, x_q, x_r\}$ such that $p(x_i) = p(x_j)$. It follows from Claim 4.7 that one can extend the mapping to any $C_{x_p x_q x_r}$. Moreover, as two such structures only intersect on $C_{x_i x_j}$, we can extend the mapping to every $C_{x_p x_q x_r}$. It only remains to map the $b_{x_p x_q}^1 b_{x_q x_r}^2$ -path added for the clause, shown in Figure 9. If (x_p, x_q, x_r) is a clause in C , then $p(x_p) \neq p(x_q)$ or $p(x_q) \neq p(x_r)$. It follows that $C_{x_p x_q}$ or $C_{x_q x_r}$ is mapped by a σ -mapping, in which case the $b_{x_p x_q}^1 b_{x_q x_r}^2$ -path shown in Figure 9 can also be mapped. We have shown that there is a homomorphism of $f(X, C)$ to (C_{48}, c) . This concludes the proof. \square

We observe that the proof could be slightly modified to obtain variations of Theorem 4.4.

Remark 4.8.

1. In the reduction from Theorem 4.4, Red vertices are never in the same part of the bipartition as Blue and Green vertices. It follows that one could colour every Red vertex Blue, and Theorem 4.4 would still hold, for 3-tropical cycles.
2. The idea of this proof can also be extended for a 2-tropical 54-cycle. To do this we first insert a Red vertex between x_5 and x_6 in P_{xy} and a Red vertex between z_5 and z_6 in Q_{zt} . We observe that the proof follows similarly. However, in this case, all blue vertices are in one part and all green vertices are on the other part of the bipartition. Thus, as in the previous claim, we can remove two colours now and use the natural bipartition to distinguish two sets of colours for each colour class.

4.3 Other families of minimal graphs

Next, we show that for each of the minimal graphs H from Table 1 (other than even cycles) that make H -LIST-COLOURING NP-complete, H -TROPICAL-COLOURING is polynomial-time solvable.

Theorem 4.9. *For every graph H belonging to one of the six families $\mathcal{T}, \mathcal{W}, \mathcal{D}, \mathcal{M}, \mathcal{N}$ and \mathcal{G} described in Table 1, H -TROPICAL-COLOURING is polynomial-time solvable.*

Proof. We assume for contradiction, that for some integer i and a family \mathcal{F} among $\mathcal{T}, \mathcal{W}, \mathcal{D}, \mathcal{M}, \mathcal{N}$ and \mathcal{G} , there is a problem (F_i, c) -COLOURING that is not polynomial-time solvable.

Family \mathcal{T} . Suppose x_{i+4} is coloured m . Suppose y_{i+3} is coloured a , $a \neq m$ by Proposition 2.3. Then, y_{i+4} cannot be coloured a (otherwise it can be folded onto y_{i+3}), so it is coloured b . Because of Lemma 2.12, there must be another P_3 coloured amb on the graph, but for the graph to be a core, the vertex coloured m of this P_3 must not be adjacent to y_{i+3} . However, note that y_{i+3} is adjacent to every vertex of X except for x_1 and x_{i+3} , both of which have degree 1 and cannot create a 3-vertex path coloured a - m - b .

Family \mathcal{W} . Now, we consider W_i . We try to find a colouring c of W_i such that (W_i, c) -COLOURING is not polynomial-time solvable. Suppose y_{i+2} is coloured with colour a . Suppose x_{i+3} is coloured m . y_{i+4} cannot be coloured a , otherwise it can be folded onto y_{i+2} , so we may assume it is coloured b . y_{i+3} cannot be coloured b , for otherwise y_{i+4} can be folded onto it, so it is coloured a or d . Suppose first that it is coloured d . By Lemma 2.12, there is another vertex coloured a , and the only one which could not be folded onto y_{i+2} is y_{i+1} , so it must be coloured a . Similarly, y_1 is coloured d . By Lemma 2.12, there is another edge besides x_{i+3}, y_{i+4} with endpoints coloured m and b , but for the graph to be a core, the edge $x_{i+3} y_{i+4}$ must not be able to fold onto it. However, it is easily verified that this is impossible. So, we must assume that y_{i+3} is coloured a . There is no other vertex in Y coloured a , otherwise it can be folded onto y_{i+2} or y_{i+3} . We can assume, without loss of generality, that a connected subgraph of the source graph, coloured only with m and b , and with only vertices of colour a at distance 1, will be sent to x_{i+3} and y_{i+4} . Knowing this, we can contract each such subgraph to a single vertex, coloured with a new colour ω , and similarly replace x_{i+3} and y_{i+4} by a single vertex coloured ω , adjacent to y_{i+2} and y_{i+3} . There will be a homomorphism between the source graph and (W_i, c) if and only if there is one

after such transformation. However, the graph obtained after such transformation will not contain any induced subgraph from the table above, which yields a contradiction.

Family \mathcal{D} . Now, consider D_i and a colouring c such that (D_i, c) -COLOURING is not polynomial-time solvable. Suppose x_{i+4} is coloured m and y_{i+4} is coloured a . By Lemma 2.12, there is another vertex coloured a . We may assume that y_1 is such a vertex because it is the only one that cannot be folded on y_{i+4} . Then, x_1 cannot have colour m , for otherwise it can be folded onto x_{i+4} , so it is coloured l . By Lemma 2.12, there is another vertex in X coloured l , say v . y_1x_1 can be folded onto $y_{i+4}v$, which yields a contradiction.

Family \mathcal{M} . Now, consider M_i and a colouring c such that (M_i, c) -COLOURING is not polynomial-time solvable. Suppose x_2 is coloured m and y_{i+2} is coloured a . By Lemma 2.12, there is another vertex in X coloured m . The only vertex which can be coloured m without being able to be folded onto x_2 is x_1 . This is because y_{i+2} is adjacent only to x_1 and x_2 is adjacent to every vertex in Y except for y_{i+2} . So we may assume x_1 is coloured m . By Lemma 2.12, there is another vertex in Y coloured a , say v . x_1y_{i+2} can be folded onto x_2v since x_2 is adjacent to every vertex in Y except y_{i+2} , which yields a contradiction.

Family \mathcal{N} . Now, consider N_i and a colouring c such that (N_i, c) -COLOURING is not polynomial-time solvable. Suppose x_2 is coloured m . For $3 \leq j \leq 2i+3$, x_j cannot be coloured m , for otherwise it can be folded onto x_2 since $N(x_j) \subset N(x_2)$. By Lemma 2.12, x_1 or x_{2i+4} must be coloured m . Both x_1 and x_{2i+4} have a neighbour of degree 1 (namely, y_{i+1} and y_{2i+4} , respectively), which are the two only vertices in Y not adjacent to x_2 . By Lemma 2.12, neither x_1y_{i+1} nor $x_{2i+4}y_{2i+4}$ can be an edge of unique colour. Either exactly one of them is coloured ma and a neighbour v of x_2 is coloured a , in which case the graph is not a core because the edge can be folded on x_2v (since $N(x_1) \setminus \{y_{i+1}\}$ and $N(x_{2i+4}) \setminus \{y_{2i+4}\}$ are both subsets of $N(x_2)$), or both x_1y_{i+1} and $x_{2i+4}y_{2i+4}$ are coloured ma and the graph is not a core because $x_{2i+4}y_{2i+4}$ can be folded on x_1y_{i+1} since $N(x_{2i+4}) \setminus \{y_{2i+4}\} \subset N(x_1)$, yielding a contradiction.

Family \mathcal{G} . We try to find a colouring c of G_1 such that (G_1, c) -COLOURING is not polynomial-time solvable. The colour of y_1 is, say, a . By Lemma 2.12, colour a must be present somewhere else in Y . By symmetry, we can assume y_2 is coloured a . The two neighbours of y_2 cannot be coloured with the same colour, for otherwise we can fold x_2 on x_1 , implying that (G_1, c) is not a core, a contradiction. Without loss of generality, x_1 and x_2 are coloured 1 and 2 respectively. By Lemma 2.12 applied to edge y_2x_2 , there must be another edge coloured $a2$. However, if a neighbour of y_1 is coloured 2, we can fold y_2x_2 onto y_1 and the graph is not a core, a contradiction. It follows that the other edge coloured $a2$ is either y_3x_4 or y_4x_6 . By symmetry, we can assume that x_4 is coloured 2 and y_3 is coloured a . x_3 cannot be coloured 1 or 2, for otherwise (G_1, c) is not a core. Therefore, x_3 is coloured with a third colour, say 3. At this point, $y_1x_1y_2x_2$ is coloured $a1a2$ and $y_1x_3y_3x_4$ is coloured $a3a2$. Consider the colour of y_4 . It must be a by Lemma 2.12. There are only two uncoloured vertices, x_5 and x_6 , which must be coloured 1 and 3 by Lemma 2.12. The graph is not a core in both cases as we can either fold x_6y_4 onto x_1y_1 or the edge x_6y_4 onto x_3y_1 , a contradiction.

Now, let c be a colouring of G_2 such that (G_2, c) -COLOURING is not polynomial-time solvable. Suppose the vertex y_2 is coloured with a . Then, y_1 cannot be coloured a , for otherwise it can be folded onto y_2 , which yields a contradiction. Therefore, y_1 is coloured b . Because of Lemma 2.12, y_3 and y_4 must be coloured a and b . By symmetry, we may assume y_3 is coloured a and y_4 is coloured b . Suppose x_5 is coloured m . Then x_1, x_2, x_3 and x_4 cannot be coloured m , for otherwise y_3x_5 can be folded on y_2 . Thus, y_3x_5 is the only edge coloured am . Lemma 2.12 yields a contradiction.

Now, let c be a colouring of G_3 such that (G_3, c) -COLOURING is not polynomial-time solvable. By Lemma 2.12, there are at most two colours in each part of the bipartition. If x_1 and x_2 have the same colour, x_2 can be folded onto x_1 , a contradiction. Similarly, if y_1 and y_4 have the same colour, y_1 can be folded onto y_4 . Then x_1, y_1, x_2 and y_4 induce a complete bipartite graph with every colour of c , implying that (G_3, c) is not a core, a contradiction. \square

5 Bipartite graphs of small order

In this section, we show that for each graph H of order at most 8, H -TROPICAL-COLOURING is polynomial-time solvable. On the other hand, there is a graph H_9 of order 9 such that H_9 -TROPICAL-COLOURING is NP-complete.

Theorem 5.1. *For any bipartite graph H of order at most 8, H -TROPICAL-COLOURING is polynomial-time solvable.*

Proof. It suffices to prove that for each bipartite graph H of order at most 8 and each colouring c of H , (H, c) -COLOURING is polynomial-time solvable. In fact, by Proposition 2.3 it suffices to show the statement for colourings of H such that the colour sets in the two parts of the bipartition are disjoint. To prove that (H, c) -COLOURING is polynomial-time solvable it is enough to prove it for the core of $S(H, c)$, it is also enough to prove it for each connected component of (H, c) . Thus in the rest of the proof we always assume that (H, c) is connected core. Let (X, Y) be the bipartition of H .

Since the only graphs of order at most 8 in the characterization of minimal NP-complete graphs H with H -LIST-COLOURING NP-complete are the cycles C_6 and C_8 [17] (see Table 1), by Theorem 1.5, if H does not contain an induced 6-cycle or an induced 8-cycle, then H -LIST-COLOURING is polynomial-time solvable and therefore H -TROPICAL-COLOURING is polynomial-time solvable. Therefore H contains an induced 6-cycle or an induced 8-cycle.

If H contains an induced copy of C_8 , then H is isomorphic to C_8 itself and hence we are done by Theorem 4.2. Therefore, we can assume that H contains an induced copy of C_6 . Again by Theorem 4.2, if H is isomorphic to C_6 , we are done.

Now, assume that H is a bipartite graph of order 7 or 8 with an induced copy of C_6 . If one part, say X , is of order 3, then all its vertices belong to each 6-cycle of H . Hence, for each $x \in X$, $(H - x)$ -LIST-COLOURING is polynomial-time solvable. Thus, if X is not monochromatic, we can apply Lemma 2.12 and (H, c) -COLOURING is polynomial-time solvable. Therefore we may assume X is monochromatic, say Blue. If Y contains at most two colours, then (H, c) contains as a subgraph the path on three vertices where the central vertex is Blue and the other vertices are coloured with the colours of Y . But then (H, c) maps to this subgraph and, therefore, it is not a core, a contradiction. Hence, Y contains at least three colours. If $|Y| = 4$, then Y contains two colours that are the unique ones coloured with their colour. Moreover, $(H - \{x, y\})$ -LIST-COLOURING contains no 6-cycle and, therefore, by Lemma 2.12 (H, c) -COLOURING, is polynomial-time solvable. Hence we can assume that $|Y| = 5$. If Y contains at least four colours, by the same argument we are done, therefore, we assume that Y contains exactly three colours. If (H, c) contains a star with a Blue centre and a three leaves of different colours, then (H, c) is not a core. Therefore the neighbourhood of each vertex of X contains at most two colours. Assume that the three vertices y_1, y_2, y_3 of Y in the 6-cycle have three different colours. Let y_4 , another element of Y be of the same colour as y_i . By the previous observation, y_4 can only be adjacent to neighbours of y_i . But then mapping y_4 to y_1 is a homomorphism which means (H, c) is not a core. Therefore, we can assume that $c(y_1) = c(y_2) = 1$ and $c(y_3) = 2$. Then, the vertex coloured 3 has degree 1 and is adjacent to the common neighbour of y_1 and y_2 . But then again, (H, c) is not a core.

Therefore, H is a bipartite graph of order 8 and $|X| = |Y| = 4$. If there are at least three colours in one part of the bipartition (say X), then two vertices x_1, x_2 in X form two colour classes of size 1. Moreover, $H - \{x_1, x_2\}$ has no 6-cycle and therefore, by Lemma 2.12, (H, c) -COLOURING is polynomial-time solvable. We may then assume that each part of the bipartition contains at most two colours. If one part, say X , contains exactly one colour (say Blue), then (H, c) contains a path on three vertices with every colour of c (the central vertex is Blue) and is not a core, a contradiction. Therefore each part of the bipartition contains exactly two colours. If in each part, each colour has exactly two vertices, we can apply Lemma 2.6 to show that (H, c) -COLOURING is polynomial-time solvable. Therefore, we can assume that there is a colour, say Blue, where exactly three vertices of one part, say x_1, x_2, x_3 from part X , coloured Blue (x_4 is coloured Green). If $H - x_4$ contains no induced 6-cycle (it cannot contain an 8-cycle since it has order 7), then $(H - x_4)$ -LIST-COLOURING is polynomial-time solvable and we can use Lemma 2.12 and (H, c) -COLOURING is polynomial-time solvable. Hence we may assume $H - x_4$ contains an induced 6-cycle C . Note that C must contain three vertices of X and therefore contains all three of x_1, x_2, x_3 . If the three other vertices y_1, y_2 and y_3 of C are coloured with the same colour, then (H, c) is not a core, a contradiction. Therefore assume, without loss of generality, that $c(y_1) = c(y_2) = 1$ and $c(y_3) = 2$. Then, in order for (H, c) to be a core, we cannot have both x_1 and y_1 (respectively, y_2 and x_3) of degree 3. More precisely, either $d(y_1) = d(x_3) = 2$ and $d(x_1) = d(y_2) = 3$, or $d(y_1) = d(x_3) = 3$ and $d(x_1) = d(y_2) = 2$. In both cases, we have $d(y_3) = 2$, for otherwise (H, c) contains a 4-cycle with all four colours, and (H, c) is not a core. If $c(y_4) = 1$, then (H, c) contains a path on four vertices coloured 2-Blue-1-Green; moreover there is no edge in (H, c) whose endpoints are coloured Green and 2, therefore (H, c) is homomorphic to the above path and is not a core. If $c(y_4) = 2$, then (H, c) contains a 4-coloured

4-cycle and again (H, c) is not a core, a contradiction. As no such tropical graph exists, we have shown that for all possible cases the (H, c) -colouring problem is polynomial-time solvable. \square

Denote by H_9 the graph obtained from a 6-cycle by adding a pendant degree 1-vertex to three independent vertices (see Figure 10).

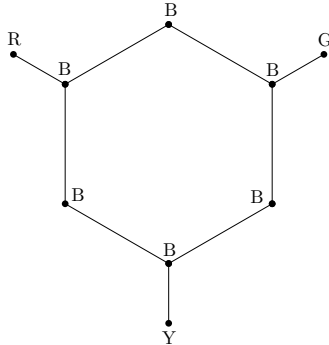

Figure 10: The 4-tropical graph H_9 .

Theorem 5.2. H_9 -TROPICAL-COLOURING is NP-complete.

Proof. We show that (H_9, c) -COLOURING is NP-complete, where c is the 4-colouring of H_9 illustrated in Figure 10. We describe a reduction from C_6 -LIST-COLOURING, which is NP-complete [17]. We label the vertices in C_6 from 1 to 6 sequentially. We also do that in the C_6 included in H_9 . We assume without loss of generality that the vertex adjacent to the Red vertex is labelled 1, and the one adjacent to the Green one is labelled 3. It follows that the vertex adjacent to the Yellow vertex is labelled 5.

Let (G, L) be an instance of C_6 -LIST-COLOURING, where L is the list-assignment function. If G is not bipartite, then G has no homomorphism to C_6 , so we can assume that G is bipartite. Since G and C_6 are bipartite, we may assume that $\forall u \in V(G)$, either $L(u) \subseteq \{1, 3, 5\}$, or $L(u) \subseteq \{2, 4, 6\}$. Thus $|L(u)| \leq 3$.

From (G, L) , we build an instance $f(G, L)$ of (H_9, c) -COLOURING as follows. First, we consider a copy G' of G , we let $G' \subset f(G, L)$ and colour every vertex of G' Black. We call u' the copy of vertex u in G' . Then, for each vertex u of G , we add a gadget H_u to $f(G, L)$ that is attached to u' . The gadget is described below and depends only on $L(u)$.

- If $L(u) = \{1\}$ (respectively, $\{3\}$ or $\{5\}$), then H_u is a single Red (respectively, Green or Yellow) vertex of degree 1 adjacent only to u' .
- If $L(u) = \{2\}$ (respectively, $\{4\}$ or $\{6\}$), then H_u consists of two 2-vertex path: a Red–Black path and a Green–Black path (respectively, a Green–Black path and a Yellow–Black path or a Yellow–Black path and a Red–Black path) whose Black vertex is of degree 2 and is adjacent to u' (the other vertex is of degree 1).
- If $L(u) = \{2, 4\}$ (respectively, $\{4, 6\}$ or $\{2, 6\}$), then H_u is a 2-vertex Green–Black (respectively, Yellow–Black or Red–Black) path whose Black vertex is of degree 2 and adjacent to u' (the other vertex is of degree 1).
- If $L(u) = \{1, 3\}$ (respectively, $\{3, 5\}$ or $\{1, 5\}$), then H_u is a 5-vertex Red–Black–Black–Black–Green path (respectively, Green–Black–Black–Black–Yellow or Yellow–Black–Black–Black–Red) whose middle Black vertex is of degree 3 and adjacent to u' (the endpoints of the path are of degree 1 and the other two vertices have degree 2).
- If $L(u) = \{1, 3, 5\}$, then H_u is a 3-vertex Black–Black–Red path with the black leaf adjacent to u' .
- If $L(u) = \{2, 4, 6\}$, then H_u is a 4-vertex Black–Black–Black–Red path with the black leaf adjacent to u' .

Let us prove that G has a homomorphism to C_6 that fulfils the constraints of list L , if and only if $f(G, L) \rightarrow (H_9, c)$.

For the first direction, consider a list homomorphism h of G to C_6 with the list function L . We build a homomorphism h' of $f(G, L)$ to (H_9, c) as follows. First of all, each copy v' of a vertex v of G with $h(v) = i$ is mapped to i in (H_9, c) . It is clear that this defines a homomorphism of the subgraph G' of $f(G, L)$ to the Black 6-cycle in (H_9, c) . It is now easy to complete h' into a homomorphism of $f(G, L)$ to (H_9, c) by considering each gadget H_u independently.

For the converse, let h_T be a homomorphism of $f(G, L)$ to (H_9, c) . Then, we claim that the restriction of h_T to the vertices of the subgraph G' of $f(G, L)$ is a list homomorphism of G to C_6 with list function L . Indeed, let u' be a vertex of G' . If H_u has one vertex (say a Red vertex), then $L(u) = \{1\}$. Then necessarily u' is sent to a neighbour of a vertex coloured Red in (H_9, c) . Since the only such neighbour is vertex 1, $u' \in h_T(u)$. All the other cases follow from similar considerations. \square

6 Trees

We now consider the complexity of tropical homomorphism problems when the target tropical graph is a tropical tree.

It follows from the results in Section 4 that for every tree T of order at most 10, T -TROPICAL-COLOURING is polynomial-time solvable. Indeed, such a tree needs to contain a minimal tree T of order at most 10 for which T -LIST-COLOURING is NP-complete, and the only such tree is G_1 , which has order 10 [17]. (See Table 1.) We proved in Theorem 4.9 that G_1 -TROPICAL-COLOURING is polynomial-time solvable. With some efforts, one can extend this to trees of order at most 11.

Theorem 6.1. *For every tree T of order at most 11, T -TROPICAL-COLOURING is polynomial-time solvable.*

Proof. Let G_1 be the smallest tree such that G_1 -LIST-COLOURING is NP-hard, as defined in Table 1 of Section 4 (G_1 has order 10 and is obtained from a claw by subdividing each edge twice). We let $V(G_1) = \{c, x_1, y_1, z_1, x_2, y_2, z_2, x_3, y_3, z_3\}$, with edges cx_i, x_iy_i, y_iz_i for $i = 1, 2, 3$.

Assume for a contradiction that there is a tree T_0 of order 11 such that T -TROPICAL-COLOURING is not polynomial-time solvable. Then, T_0 is a connected core. Once again, by Proposition 2.3, we may assume that the colour sets of the two parts in the bipartition of T_0 are disjoint. By Theorem 1.5, for any tree T which does not contain G_1 as an induced subgraph, T -LIST-COLOURING is polynomial-time solvable, and therefore T -TROPICAL-COLOURING is polynomial-time solvable. Hence G_1 is a subtree of T_0 .

There are four non-isomorphic trees of order 11 which contain G_1 , depending on where we attach the additional vertex a . If in T_0 , a is adjacent to c , then the same arguments as in the proof of Theorem 4.9 showing that G_1 -TROPICAL-COLOURING is polynomial-time solvable show that T_0 -TROPICAL-COLOURING is polynomial-time solvable, a contradiction.

Let (A, B) be the bipartition of T_0 with $\{c, y_1, y_2, y_3\} \subseteq A$ and $\{x_1, x_2, x_3, z_1, z_2, z_3\} \subseteq B$. For the remainder, we may assume that no vertex (except a) is the only one with its colour, for otherwise, by Lemma 2.12, T_0 -TROPICAL-COLOURING would be polynomial-time solvable. In particular, $A - a$ is coloured with at most two colours and $B - a$ is coloured with at most three colours.

Assume first that a is adjacent to a vertex x_i of G_1 , say x_1 . The colours of x_1 and z_1 must be distinct, otherwise (T_0, c_0) is not a core. Without loss of generality, assume that $c_0(x_1) = 1$ and $c_0(z_1) = 2$. Without loss of generality the central vertex c is Black. The supplementary vertex a must be coloured with a different colour than c and y_1 (say with colour Red), otherwise (T_0, c_0) is not a core. Hence y_1 is not Red. Assume first that y_1 is Green. Then (without loss of generality), y_2 is Black and y_3 is Green, otherwise we could apply Lemma 2.12. But by Lemma 2.12, there must be two edges with endpoints 1 and Green, and one with endpoints 2 and Green. Hence $c_0(x_3) = 1$ and $c_0(z_3) = 2$ (if $c_0(x_3) = 2$ and $c_0(z_3) = 1$ then (T_0, c_0) is not a core). But again by Lemma 2.12 we need another edge with endpoints Black and 1, and one with endpoints Black and 2. But in both cases (T_0, c_0) is not a core, a contradiction. This shows that vertex y_1 must be Black. Then, since (T_0, c_0) is a core, vertex c has no neighbour coloured 2. But if there is no second edge with endpoints coloured 2 and Black, then we could apply Lemma 2.12. Hence one of y_2 and y_3 , say y_2 , must be Black, and $c_0(z_2) = 2$. If $c_0(x_2) = 1$, (T_0, c_0) is not a core, therefore $c_0(x_2) = 3$, and $c_0(x_3) \in \{1, 3\}$. If y_3 is Black, then (T_0, c_0) is not a core, hence

y_3 is Red. But both neighbours of y_3 must have distinct colours, which means we can apply Lemma 2.12 to one of the edges incident with y_3 , a contradiction.

Assume now that a is adjacent to a vertex y_i of G_1 , say y_1 . Then, the colours of a , x_1 and z_1 must be distinct, say $c_0(x_1) = 1$, $c_0(z_1) = 2$, $c_0(a) = 3$. Without loss of generality the central vertex c is Black. By Lemma 2.12, there is another vertex coloured Black. If y_1 is Black, then by Lemma 2.12 we have two further edges with endpoints Black-2 and Black-3. But these edges cannot be both incident with c (otherwise (T_0, c_0) is not a core), hence there is another Black vertex. Then in fact, Lemma 2.12 implies that both y_2 and y_3 are Black. But then, any way to complete c_0 implies that (T_0, c_0) is not a core, a contradiction. Therefore, y_1 is not Black (say it is Red) and we can assume that y_2 is Black, and since we need a second Red vertex, y_3 is Red. But one of the type of edges among Red-1, Red-2 and Red-3 will appear only once, and we can apply Lemma 2.12, a contradiction.

We assume finally that a is adjacent to a vertex z_i of G_1 , say z_1 . Without loss of generality, vertex a is Black, vertex z_1 is coloured 1, and vertex y_1 is Red (otherwise, (T_0, c_0) is not a core). By Lemma 2.12, there must be another 3-vertex path coloured Black-1-Red. This path must be cx_iy_i with c Black, for otherwise (T_0, c_0) is not a core. We can assume that $c_0(x_2) = 1$ and y_1 is Red. Then $c_0(x_1) \neq 1$, assume $c_0(x_1) = 2$. Then again by Lemma 2.12 there is another 3-vertex path coloured Black-2-Red. The only possibility is that $c_0(x_3) = 2$ and y_3 is Red. Then $c_0(z_3) \notin \{1, 2\}$, otherwise (T_0, c_0) is not a core. Hence we assume $c_0(z_3) = 3$, which by Lemma 2.12 implies $c_0(z_2) = 3$. But then there is a unique 3-vertex path coloured 1-Red-3, and by Lemma 2.12, (T_0, c_0) -COLOURING is polynomial-time solvable, a contradiction. This completes the proof. \square

Let T_{23} be the tree of order 23 shown in Figure 11.

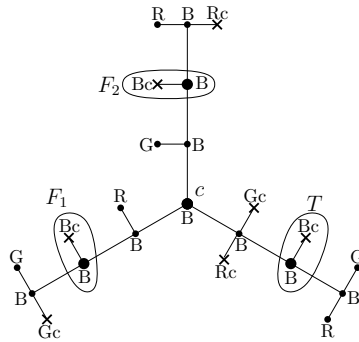

Figure 11: The 7-tropical tree (T_{23}, c)

Theorem 6.2. T_{23} -TROPICAL-COLOURING is NP-complete.

Proof. We give a reduction from 3-SAT to (T_{23}, c) -COLOURING, where c is the colouring of Figure 11. Given an instance (X, C) of 3-SAT, we construct an instance $f(X, C) = (G_{X,C}, c_{X,C})$ of (T_{23}, c) -COLOURING.

To construct the graph $G_{X,C}$, we first define the following building blocks. See Figure 12 for illustrations.

- The block $S_{1,2}$ is a graph built from a 7-vertex black-coloured path with vertex set $\{x_1, \dots, x_7\}$ where a BlackCross leaf is attached to vertices x_1 and x_7 , a RedDot leaf is attached to vertices x_2 and x_6 , and a GreenDot leaf is attached to vertex x_4 .
- The block $S_{1,T}$ is a graph built from a 7-vertex black-coloured path with vertex set $\{x_1, \dots, x_7\}$ where a BlackCross leaf is attached to vertices x_1 and x_7 , a RedDot leaf is attached to vertices x_2 and x_6 , and a RedCross leaf is attached to vertex x_4 .
- The block $S_{1,T}$ is a graph built from a 7-vertex black-coloured path with vertex set $\{x_1, \dots, x_7\}$ where a BlackCross leaf is attached to vertices x_1 and x_7 , a GreenDot leaf is attached to vertices x_2 and x_6 , and a GreenCross leaf is attached to vertex x_4 .
- The *NOT-block* is depicted in Figure 12(b).

- The A -block is depicted in Figure 12(c).

Illustrations of these blocks can be found in Figure 12.

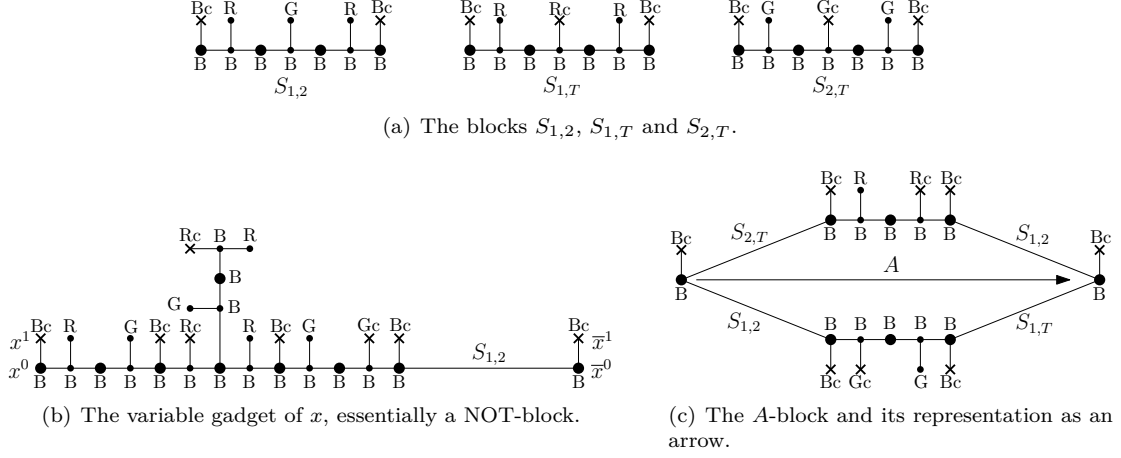

Figure 12: The building blocks of $G_{X,C}$.

We now define gadgets for each variable of X and each clause of C . The graph $G_{X,C}$ is formed by the set of all variable and clause gadgets.

- For a variable $x \in X$, the *variable gadget* of x consists of the four vertices x^0 , x^1 , \bar{x}^0 and \bar{x}^1 , coloured respectively BlackDot, BlackCross, BlackDot and BlackCross, joined by a NOT-block as described in Figure 12(b). The image of x^0 and x^1 in (T_{23}, c) correspond to the truth-value of the literal x . Similarly, the image of \bar{x}^0 and \bar{x}^1 correspond to the truth-value of the literal \bar{x} . For a literal l , we use the notation l^0 (resp. l^1) to describe either x^0 (resp. x^1) when $l = x$ with $x \in X$, or \bar{x}^0 (resp. \bar{x}^1) when $l = \bar{x}$ with $x \in X$.
- For each clause $c = (l_1, l_2, l_3) \in C$, there is a *clause gadget* of c (as drawn in Figure 13) connecting vertices l_1^0 , l_2^0 and l_3^0 .

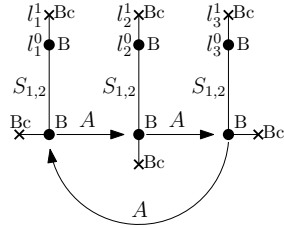

Figure 13: Example of a clause gadget of clause (l_1, l_2, l_3) . The full details of the A -blocks and $S_{1,2}$ -blocks are represented in Figure 12.

We now show that $G_{X,C} \rightarrow (T_{23}, c)$ if and only if (X, C) is satisfiable.

Assume first that there is a homomorphism h of $G_{X,C}$ to (T_{23}, c) . We first prove some properties of h .

Claim 6.3. *The homomorphism h satisfies the following properties.*

- (1) For each literal l of a variable of X , vertices l^0 and l^1 are mapped to the two vertices of one of the pairs T , F_1 or F_2 . The same holds for the extremities of the blocks $S_{1,2}$, $S_{1,T}$, $S_{2,T}$ and A .
- (2) The two extremities of each block $S_{1,2}$ are both mapped either to the vertices of T , or to vertices of $F_1 \cup F_2$.

- (3) The two extremities of each block $S_{1,T}$ are both mapped either to the vertices of F_2 , or to vertices of $F_1 \cup T$.
- (4) The two extremities of each block $S_{2,T}$ are both mapped either to the vertices of F_1 , or to vertices of $F_2 \cup T$.
- (5) For each variable x of X , exactly one of x^0 and \bar{x}^0 is mapped to a vertex of T , and the other is mapped to a vertex of F_1 or F_2 .
- (6) In any A -block, either some extremity is mapped to T (then the other extremity can be mapped to any of F_1, F_2 or T), or the left extremity is mapped to F_2 and the right extremity, to F_1 .

Proof of claim. (1) This is immediate since the only pairs in (T_{23}, c) consisting of two adjacent BlackDot and BlackCross vertices are the ones of T, F_1 and F_2 .

(2)–(4) We only prove (2), since the three proofs are not difficult and similar. By (1), the extremities of $S_{1,2}$ are mapped to vertices of $T \cup F_1 \cup F_2$. If one extremity is mapped to T , the remainder of the mapping is forced and the claim follows. If one extremity is mapped to $F_1 \cup F_2$, one can easily complete it to a mapping where the other extremity is mapped to either F_1 or F_2 .

(5) By (1), x^0 and \bar{x}^0 must be mapped to a vertex of $T \cup F_1 \cup F_2$. Without loss of generality, we can assume that x^0 corresponds to the left extremity of the NOT-block N_x connecting x^0 and \bar{x}^0 . First assume that x^0 and \bar{x}^0 are mapped to the vertex of T coloured BlackDot. Then, considering the vertices of N_x from left to right, the mapping is forced and the degree 3-vertex of N_x at distance 2 both of a RedDot and a RedCross vertex must be mapped to the vertex c of T_{23} . But then, continuing towards the right of N_x , \bar{x}^0 cannot be mapped to a vertex of T . Therefore, we may assume that both x^0 and \bar{x}^0 are mapped to the BlackCross vertices of $F_1 \cup F_2$. If x^0 is mapped to the BlackCross vertex in F_1 , then again going through N_x from left to right the mapping is forced; the central vertex of N_x must be mapped to a vertex of F_2 , and \bar{x}^0 must be mapped to a vertex of T , a contradiction. The same applied when x^0 is mapped to the BlackCross vertex in F_2 , completing the proof of (5).

(6) An A -block is composed of two parts: the upper part and the lower part. Observe that if the left extremity of an A -block is mapped to F_1 , then using (2) and (4), the mapping of the upper part of the A -block is forced and the right extremity has to be mapped to T . Similarly, if the left extremity is mapped to F_2 , by (2) and (3) the right extremity cannot be mapped to F_2 . On the other hand, for all other combinations of mapping the extremities to T, F_1 or F_2 the mapping can be extended. \square

We are ready to show how to construct the truth assignment $A(h)$. If $h(l^0) \in T$ for some literal l , we let l be True and if $h(l^0) \in F_1 \cup F_2$, we let l be False. By Claim 6.3(5), this is a consistent truth assignment for X . For any clause $c = (l_1, l_2, l_3)$, in the clause gadget of c , we have three A -blocks forming a directed triangle. Hence, by Claim 6.3(6), there must be one of the three extremities of this triangle mapped to a vertex of T . Therefore, by Claim 6.3(2), at least one of the vertices l_1^0, l_2^0 and l_3^0 is mapped to T . This shows that $A(h)$ satisfies the formula (X, C) .

Reciprocally, if there is a solution for (X, C) , one can build a homomorphism of $G_{X,C}$ to (T_{23}, c) by mapping, for each literal l , the vertices l_0 and l_1 to one of the vertex pairs F_1, F_2 and T of (T_{23}, c) corresponding to the truth value of l (if l is False, we may choose one of F_1 and F_2 arbitrarily). Then, using Claim 6.3, one can easily complete this to a valid mapping. \square

7 Conclusion

We have shown that the class of (H, c) -COLOURING problems has a very rich structure, since they fall into the classes of CSPs for which a dichotomy theorem would imply the truth of the Feder–Vardi Dichotomy Conjecture. Hence, we turned our attention to the class of H -TROPICAL-COLOURING problems, for which a dichotomy theorem might exist. Despite some initial results in this direction, we have not been able to exhibit such a dichotomy, and leave this as the major open problem in this paper.

Towards a solution to this problem, we propose a simpler question. All bipartite graphs H that we know with problem H -TROPICAL-COLOURING being NP-complete contain, as an induced subgraph, either an even cycle of length at least 6 (for example cycles themselves or H_9), or the graph G_1 from Table 1, that is, a claw with each edge subdivided twice (this is the case for T_{23}). Hence, we ask the following. (A bipartite graph is *chordal* if it contains no induced cycle of length at least 6.)

Question 7.1. *Is it true that for any chordal bipartite graph H with no induced copy of G_1 , H -TROPICAL-COLOURING is polynomial-time solvable?*

Note that Question 7.1 is not an attempt at giving an exact classification, since G_1 -TROPICAL-COLOURING and C_{2k} -TROPICAL-COLOURING for $k \leq 6$ are polynomial-time solvable.

Another interesting question would be to consider the restriction of H -TROPICAL-COLOURING to 2-tropical graphs. Recall that by Remark 4.8(2), one can slightly modify the gadgets from Theorem 4.4 and the colouring of the cycle, to obtain a 2-colouring c of C_{54} such that (C_{54}, c) -COLOURING is NP-complete.

Finally, we relate our work to the (H, h, Y) -FACTORING problem studied in [10] and mentioned in the introduction. Recall that (H, c) -COLOURING corresponds to $(H, c, K_{|C|}^+)$ -FACTORING where $K_{|C|}^+$ is the complete graph on $|C|$ vertices with all loops, and with C the set of colours used by c . In [10], the authors studied (H, h, Y) -FACTORING when Y has no loops. Using reductions from NP-complete D -COLOURING problems where D is an oriented even cycle or an oriented tree, they proved that for any fixed graph Y which is not a path on at most four vertices, there is an even cycle C and a tree T such that (C, h_C, Y) -FACTORING and (T, h_T, Y) -FACTORING are NP-complete (for some suitable homomorphisms h_C and h_T). Note that C and T here are fairly large. We can strengthen these results as follows. Consider our reduction of Theorem 4.4 showing in particular that C_{48} -TROPICAL-COLOURING is NP-complete. As noted in Remark 4.8(1), the given colouring c of C_{48} can easily be made a proper colouring by separating the red vertices into two classes, according to which part of the bipartition of C_{48} they belong to. Then, one can observe that c is in fact a homomorphism to a tree T_1 obtained from a claw where one edge is subdivided once (the three vertices of degree 1 are coloured Blue, Black and Green, and the two other vertices are the two kinds of Red). Thus, for any graph Y containing this subdivided claw as a subgraph, we deduce that $(C_{48}, c_{1|T_1}, Y)$ -FACTORING is NP-complete. We can use a similar approach for our result of Theorem 6.2, that T_{23} -TROPICAL-COLOURING is NP-complete. Note that the colouring c_2 we give is in fact a homomorphism to a tree T_2 which is obtained from a star with five branches by subdividing one edge once. Thus, for any graph Y containing T_2 as a subgraph, $(T_{23}, c_{2|T_2}, Y)$ -FACTORING is NP-complete. Of course we can apply this argument by replacing T_1 and T_2 by the underlying graph of any loop-free homomorphic image of (C_{48}, c_1) and (T_{23}, c_2) , respectively.

Acknowledgements. We thank Petru Valicov for initial discussions on the topic of this paper.

References

- [1] N. Alon and T. H. Marshall. Homomorphisms of edge-colored graphs and Coxeter groups. *Journal of Algebraic Combinatorics* 8(1):5–13, 1998.
- [2] J. Bang-Jensen and P. Hell. The effect of two cycles on the complexity of colorings by directed graphs. *Discrete Applied Mathematics* 26(1):1–23, 1990.
- [3] J. Bang-Jensen, P. Hell and G. MacGillivray. The complexity of colouring by semicomplete digraphs. *SIAM Journal on Discrete Mathematics* 1(3):281–298, 1988.
- [4] J. Bang-Jensen, P. Hell and G. MacGillivray. Hereditarily hard H -colouring problems. *Discrete Mathematics* 138(1–3):75–92, 1995.
- [5] L. Barto, M. Kozik and T. Niven. The CSP dichotomy holds for digraphs with no sources and sinks (a positive answer to a conjecture of Bang-Jensen and Hell). *SIAM Journal on Computing* 38(5):1782–1802, 2009.
- [6] R. C. Brewster. *Vertex colourings of edge-coloured graphs*, PhD thesis, Simon Fraser University, Canada, 1993.
- [7] R. C. Brewster. The complexity of colouring symmetric relational systems. *Discrete Applied Mathematics* 49(1–3):95–105, 1994.
- [8] R. C. Brewster, F. Foucaud, P. Hell and R. Naserasr. The complexity of signed and edge-coloured graph homomorphisms. *Discrete Mathematics* 340(2):223–23, 2017.

- [9] R. C. Brewster and P. Hell. On homomorphisms to edge-colored cycles. *Electronic Notes in Discrete Mathematics* 5:46–49, 2000.
- [10] R. C. Brewster and G. MacGillivray. The homomorphism factoring problem. *Journal of Combinatorial Mathematics and Combinatorial Computing* 25:33–53, 1997.
- [11] A. A. Bulatov. Tractable conservative constraint satisfaction problems. Proceedings of the 18th IEEE Annual Symposium on Logic in Computer Science, LICS’03, pages 321–330, 2003.
- [12] A. A. Bulatov. A dichotomy constraint on a three-element set. *Journal of the ACM* 53(1):66–120, 2006.
- [13] K. Draeger. Answer to the question “Complexity of digraph homomorphism to an oriented cycle”. *Theoretical Computer Science Stack Exchange*, 2016. <http://cstheory.stackexchange.com/q/33899>
- [14] T. Feder. Classification of homomorphisms to oriented cycles and of k -partite satisfiability. *SIAM Journal on Discrete Mathematics* 14(4):471–480, 2001.
- [15] T. Feder and P. Hell. List homomorphisms to reflexive graphs. *Journal of Combinatorial Theory Series B* 72(2):236–250, 1998.
- [16] T. Feder and P. Hell. Full constraint satisfaction problems. *SIAM Journal on Computing* 36(1):230–246, 2006.
- [17] T. Feder, P. Hell and J. Huang. List homomorphisms and circular arc graphs. *Combinatorica* 19(4):487–505, 1999.
- [18] T. Feder, P. Hell and J. Huang. Bi-arc graphs and the complexity of list homomorphisms. *Journal of Graph Theory* 42(1):61–80, 2003.
- [19] T. Feder, J. Kinne and A. Rafiey. Dichotomy for digraph homomorphism problems. ArXiv e-prints, 2017. <https://arxiv.org/pdf/1701.02409.pdf>
- [20] T. Feder and M. Y. Vardi. The Computational structure of monotone monadic SNP and constraint satisfaction: a study through datalog and group theory. *SIAM Journal of Computing* 28(1):57–104, 1998.
- [21] P. Hell and J. Nešetřil. On the complexity of H -coloring. *Journal of Combinatorial Theory Series B* 48(1):92–110, 1990.
- [22] P. Hell and J. Nešetřil. *Graphs and Homomorphisms*. Oxford Lecture Series in Mathematics and Its Applications, Oxford University Press, r2004.
- [23] P. Hell, J. Nešetřil and X. Zhu. Complexity of tree homomorphisms. *Discrete Applied Mathematics* 70(1):23–36, 1996.
- [24] R. M. Karp. Reducibility among combinatorial problems. In R. E. Miller and J. W. Thatcher, editors, *Complexity of Computer Computations*, pages 85–103. Plenum Press, 1972.
- [25] M. R. Krom. The decision problem for a class of first-order formulas in which all disjunctions are binary. *Zeitschrift für Mathematische Logik und Grundlagen der Mathematik* 13(1–2):15–20, 1967.
- [26] R. Ladner. On the structure of polynomial time reducibility. *Journal of the ACM* 22(1):155–171, 1975.
- [27] B. M. E. Moret. *The Theory of Computation*. Addison Wesley, 1998. Chapter 7, Problem 7.1, Part 2.
- [28] T. J. Schaefer. The complexity of satisfiability problems. Proceedings of the tenth annual ACM symposium on Theory of computing, STOC’78, pages 216–226, 1978.
- [29] W. T. Trotter and J. I. Moore. Characterization problems for graphs, partially ordered sets, lattices, and families of sets. *Discrete Mathematics* 16(4):361–381, 1976.