



HAL
open science

Poly-symmetry in processor-sharing systems

Thomas Bonald, Céline Comte, Virag Shah, Gustavo de Veciana

► **To cite this version:**

Thomas Bonald, Céline Comte, Virag Shah, Gustavo de Veciana. Poly-symmetry in processor-sharing systems. Queueing Systems, 2017, 10.1007/s11134-017-9525-2 . hal-01513544v2

HAL Id: hal-01513544

<https://hal.science/hal-01513544v2>

Submitted on 23 Oct 2019

HAL is a multi-disciplinary open access archive for the deposit and dissemination of scientific research documents, whether they are published or not. The documents may come from teaching and research institutions in France or abroad, or from public or private research centers.

L'archive ouverte pluridisciplinaire **HAL**, est destinée au dépôt et à la diffusion de documents scientifiques de niveau recherche, publiés ou non, émanant des établissements d'enseignement et de recherche français ou étrangers, des laboratoires publics ou privés.

Poly-Symmetry in Processor-Sharing Systems*

Thomas Bonald¹, Céline Comte¹, Virag Shah^{†2}, and Gustavo de Veciana³

¹Télécom ParisTech, Université Paris-Saclay, France

²Microsoft Research - Inria Joint Centre, France

³Department of ECE, The University of Texas at Austin, USA

October 23, 2019

Abstract

We consider a system of processor-sharing queues with state-dependent service rates. These are allocated according to balanced fairness within a polymatroid capacity set. Balanced fairness is known to be both insensitive and Pareto-efficient in such systems, which ensures that the performance metrics, when computable, will provide robust insights into the real performance of the system considered. We first show that these performance metrics can be evaluated with a complexity that is polynomial in the system size if the system is partitioned into a finite number of parts, so that queues are exchangeable within each part and asymmetric across different parts. This in turn allows us to derive stochastic bounds for a larger class of systems which satisfy less restrictive symmetry assumptions. These results are applied to practical examples of tree data networks, such as backhaul networks of Internet service providers, and computer clusters.

Keywords: Processor-sharing queueing systems, performance, balanced fairness, poly-symmetry.

1 Introduction

Systems of processor-sharing queues with state-dependent service rates have been extensively used to model a large variety of real communication and computation systems like content delivery systems [17, 18], computer clusters [2, 11] and data networks [8, 14]. They are natural models for such real systems as they capture the complex interactions between different jobs and also have a promise of analytical tractability of user performance when subject to stochastic loads. Indeed, in the past two decades researchers have been able to obtain explicit performance expressions and bounds for several such systems, see [4, 5, 6, 7, 12, 13, 14, 17, 18].

However, few performance results scale well with the system size. Those that do rely on restrictive assumptions related to the topology or the symmetry of the system [14, 18]. One of the main goals of this paper is to provide scalable performance results for a class of processor-sharing systems which find applications in bandwidth-sharing networks and computer clusters.

One of the key features of processor-sharing systems is the allocation of the service rates per queue in each state. A particular class of resource allocations which is more tractable for performance analysis is characterized by the balance property which constrains the relative gain in the service rate at one queue when we remove a job from another queue. Processor-sharing systems where the resource allocation satisfies this property are called Whittle networks [16]. In particular, if the service rates are constrained by some capacity set, corresponding to the resources of the real system considered, then there exists a unique policy which satisfies the balance property while being efficient, namely balanced fairness [3]. In this paper we

*The final publication is available at Springer via <http://dx.doi.org/10.1007/s11134-017-9525-2>.

[†]T. Bonald, C. Comte and V. Shah are members of LINCOS, see <http://www.lincos.fr>.

focus on systems which are constrained by a polymatroid capacity set [10, 17] and operate under balanced fair resource allocation.

It was proved in [17] that balanced fairness is Pareto-efficient when it is applied in polymatroid capacity sets, which in practice yields explicit recursion formulas for the performance metrics. However, if no further assumptions are made on the structure of the system, the time complexity to compute these metrics is exponential with the number of queues. It was proved in [17] that it can be made linear at the cost of strict assumptions on the overall symmetry of the capacity set and the traffic intensity at each queue. Under symmetry in interaction across queues, it was shown in [18] that the performance is robust to heterogeneity in loads and system configuration under an appropriate scaling regime. However, there is little understanding of performance for scenarios where queues themselves interact in heterogeneous fashion.

In this paper, we consider a scenario where the processor-sharing system is partitioned into a finite number of parts, so that queues are exchangeable within each part and asymmetric across different parts. For such systems, that we call *poly-symmetric*, we obtain a performance expression with computational complexity which is polynomial in the number of queues. We demonstrate the usefulness of these bounds by applying them to tree data networks, which are representative of backhaul networks, and to randomly configured heterogeneous computer clusters. In addition, we provide a monotonicity bound which allows us to bound performance of systems with capacity regions which are ‘nearly’ poly-symmetric.

The paper is organized as follows. Section 2 introduces the model and shows that it applies to real systems as varied as tree data networks and computer clusters. We also recall known facts about balanced fairness. In Section 3, we introduce the notion of poly-symmetry and show that it yields explicit recursion formulas for the performance metrics which have a complexity that is polynomial in the number of queues in the processor-sharing system. Finally, Section 4 gives stochastic bounds to compare the performance of different systems. We conclude in Section 5.

2 System model

2.1 Processor-sharing queueing system with a polymatroid capacity set

We consider a system of n processor-sharing queues with coupled service rates and we denote by $I = \{1, \dots, n\}$ the set of queue indices. For each $i \in I$, jobs enter the system at queue i according to some Poisson process with intensity λ_i and have i.i.d. exponential service requirements with mean σ_i , resulting in a traffic intensity $\rho_i = \lambda_i \sigma_i$ at queue i . Jobs leave the system immediately after service completion. Such a queueing system will be called a *processor-sharing system* throughout the paper.

The system state is described by the vector $x = (x_i : i \in I)$, where x_i is the number of jobs at queue i for each $i \in I$. For each $x \in \mathbb{N}^n$, $I(x) = \{i \in I : x_i > 0\}$ denotes the set of active queues in state x . Queues have state-dependent service rates. For each $x \in \mathbb{N}^n$, $\phi(x) = (\phi_i(x) : i \in I)$ denotes the vector of service rates per queue when the system is in state x .

The system is characterized by a *capacity set*, which is defined as the set of all feasible resource allocations $\phi = (\phi_i : i \in I) \in \mathbb{R}_+^n$. This capacity set may be specified by practical constraints like the capacities of the links in a data network or the service rates of the servers in a computer cluster. We are interested in queueing systems whose capacity set is a particular type of polytope called a *polymatroid* [10].

Definition 1. A polytope \mathcal{C} in \mathbb{R}_+^n is a *polymatroid* if there exists a non-negative function μ defined on the power set of I such that

$$\mathcal{C} = \left\{ \phi \in \mathbb{R}_+^n : \sum_{i \in A} \phi_i \leq \mu(A), \quad \forall A \subset I \right\}$$

and μ satisfies the following properties:

Normalization: $\mu(\emptyset) = 0$,

Monotonicity: for all $A, B \subset I$, if $A \subset B$, then $\mu(A) \leq \mu(B)$,

Submodularity: for all $A, B \subset I$, $\mu(A) + \mu(B) \geq \mu(A \cup B) + \mu(A \cap B)$.

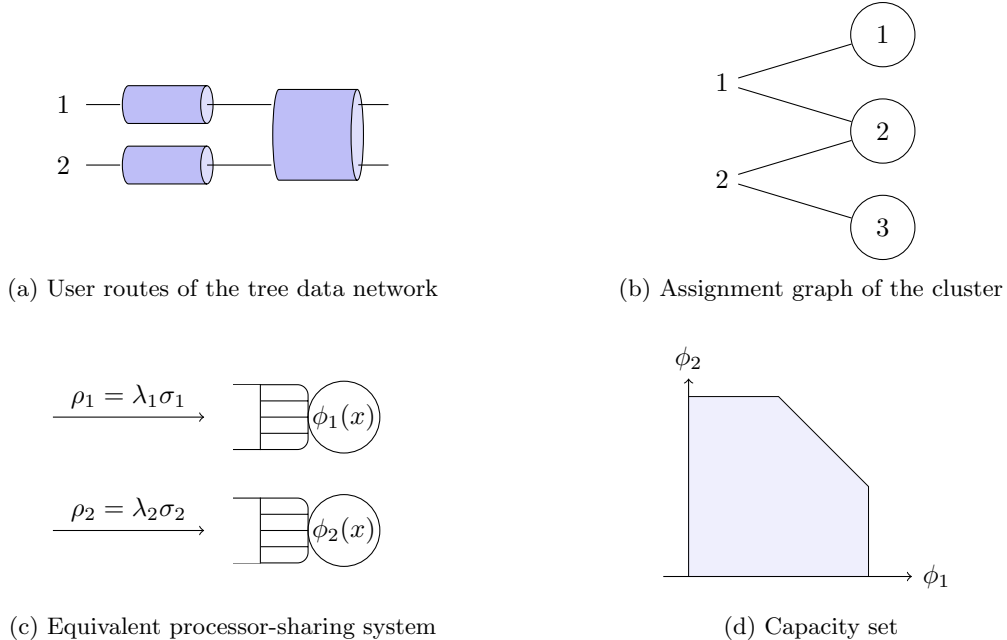

Figure 1: A tree data network and a computer cluster with their representation as a processor-sharing system with $n = 2$ queues

μ is called the *rank function* of the polymatroid \mathcal{C} .

Before we specify the resource allocation, we give two examples of real systems that fit into this model.

2.2 Tree data networks

The first example is a data network with a tree topology [6], representative of backhaul networks of Internet service providers. There are n users that can generate flows in parallel and we denote by $I = \{1, \dots, n\}$ the set of user indices. For any $i \in I$, user i generates data flows according to some Poisson process with intensity λ_i that is independent of the other users. All flows generated by user i follow the same route in the network and have i.i.d. exponentially distributed sizes with mean σ_i in bits, resulting in a traffic intensity $\rho_i = \lambda_i \sigma_i$ in bit/s. The state of the network is described by the vector $x = (x_i : i \in I)$, where x_i is the number of ongoing flows of user i , for each $i \in I$.

We make the following assumptions on the allocation of the resources. The capacity of each link can be divided continuously among the flows that cross it. Also, the resource allocation per flow only depends on the number of flows of each user in progress. In particular, all flows of a user receive the same capacity, so that the per-flow resource allocation is entirely defined in any state $x \in \mathbb{N}^n$ by the total capacity $\phi_i(x)$ allocated to flows of user i , for any $i \in I$.

Under these assumptions, we can represent the data network by a processor-sharing system with n queues, one per user. For each $i \in I$, the jobs at queue i in the equivalent processor-sharing system are the ongoing flows of user i in the data network, and the service rate of this queue in state x is the total capacity $\phi_i(x)$ allocated to the flows of user i . We will now describe the corresponding capacity set.

Each link can be identified by the set of users that cross it. Specifically, we can describe the network by a family \mathcal{T} of subsets of I , where a set $L \subset I$ is in \mathcal{T} if and only if there is a link crossed by the flows of all users $i \in L$. We assume that the network is a tree in the following way.

Definition 2. The network is called a *tree* if for all $L, M \in \mathcal{T}$, $L \cap M \neq \emptyset$ implies that $L \subset M$ or $M \subset L$.

There is no loss of generality in assuming that $I \in \mathcal{T}$, for if not, the network is a forest where each subtree can be considered independently. For each $L \in \mathcal{T}$, we denote by C_L the capacity in bit/s of link L . We assume that all links are constraining since otherwise we can simply ignore the non-constraining ones. The resource allocation must then satisfy the capacity constraints

$$\sum_{i \in L} \phi_i(x) \leq C_L, \quad \forall L \in \mathcal{T}, \quad \forall x \in \mathbb{N}^n, \quad (1)$$

so that the capacity set is given by

$$\mathcal{C} = \left\{ \phi \in \mathbb{R}_+^n : \sum_{i \in L} \phi_i \leq C_L, \quad \forall L \in \mathcal{T} \right\}.$$

Example 1. Figures 1a, 1c and 1d give the example of a tree data network with 2 users. The routes of the users are given in Figure 1a. The flows of each user cross one link that is individual and another that is shared by both users. The representation of this data network as a processor-sharing system is given in Figure 1c and the corresponding capacity set is given in Figure 1d. It is easy to see that it is a polymatroid for any value of the link capacities.

The following theorem generalizes this last remark to any tree data network.

Theorem 1. *The capacity set of a tree data network is a polymatroid with rank function μ defined by*

$$\mu(A) = \min \left\{ \sum_{L \in \Sigma} C_L : \Sigma \subset \mathcal{T} \text{ is a family of disjoint sets s.t. } A \subset \bigcup_{L \in \Sigma} L \right\}$$

for all non-empty set $A \subset I$. In addition, we have $\mu(L) = C_L$ for each $L \in \mathcal{T}$.

Proof. We can certainly assume that \mathcal{T} contains all the singletons since letting $C_{\{i\}} = \min_{L \subset \mathcal{T}, i \in L} C_L$ for each $i \in I$ does not modify the capacity set \mathcal{C} . We can easily see that the result remains true if we do not make this assumption.

We apply the following lemma which is a direct consequence of Theorems 2.5 and 2.6 of [10] about intersecting-submodular functions on intersecting families of subsets.

Lemma 1. *Let \mathcal{T} be a family of subsets of I and $g : \mathcal{T} \rightarrow \mathbb{R}$ such that, for all $L, M \in \mathcal{T}$ with $L \cap M \neq \emptyset$, we have $L \cap M \in \mathcal{T}$, $L \cup M \in \mathcal{T}$ and $g(L) + g(M) \geq g(L \cup M) + g(L \cap M)$. Further assume that $\emptyset, I \in \mathcal{T}$, $g(\emptyset) = 0$ and \mathcal{T} contains all the singletons of I . Then the set of solutions in \mathbb{R}^n of the equations*

$$\sum_{i \in L} \phi_i \leq g(L), \quad \forall L \in \mathcal{T},$$

is given by

$$\left\{ \phi \in \mathbb{R}^n : \sum_{i \in A} \phi_i \leq f(A), \quad \forall A \in I \right\},$$

where f is the real-valued, normalized, submodular function defined on the power set of I by

$$f(A) = \min \left\{ \sum_{L \in \Sigma} g(L) : \Sigma \subset \mathcal{T} \text{ is a partition of } A \right\}, \quad \forall A \subset I.$$

The definition of a tree ensures that $\mathcal{T} \cup \{\emptyset\}$ satisfies the assumptions of the lemma, with the function g defined on $\mathcal{T} \cup \{\emptyset\}$ by $g(L) = C_L$ for any $L \in \mathcal{T}$ and $g(\emptyset) = 0$. Hence, the set of solutions of the capacity constraints (1) in \mathbb{R}^n is

$$\mathcal{P} = \left\{ \phi \in \mathbb{R}^n : \sum_{i \in A} \phi_i \leq f(A), \quad \forall A \subset I \right\}$$

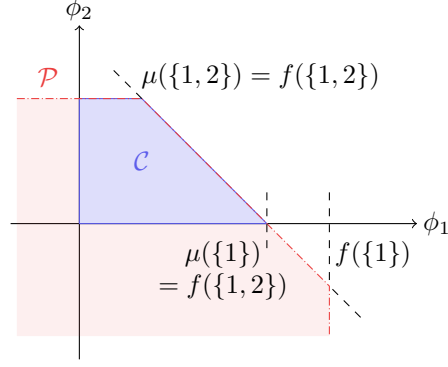

Figure 2: Construction of the capacity set of a tree data network in \mathbb{R}_+^n from the set of solutions of its capacity constraints in \mathbb{R}^n

where f is the normalized, submodular function given by

$$f(A) = \min \left\{ \sum_{L \in \Sigma} C_L : \Sigma \subset \mathcal{T} \text{ is a partition of } A \right\}, \quad \forall A \subset I.$$

Note that no claim about the monotonicity of f can be made above because the points in \mathcal{P} can have negative components. This is illustrated in Figure 2, where the intersection point of the sides of \mathcal{P} corresponding to the sets $\{1\}$ and $\{1, 2\}$ has a negative ordinate because $f(\{1, 2\}) < f(\{1\})$.

Since the components of a vector of resource allocation are always positive, the capacity set \mathcal{C} of the data network is given by $\mathcal{C} = \mathcal{P} \cap \mathbb{R}_+^n$. As we will see, since we restrict ourselves to points with positive components, the function μ which characterizes \mathcal{C} is not only normalized and submodular like f but also non-decreasing. This is illustrated in Figure 2, which shows that we can replace $f(\{1\})$ by $f(\{1, 2\})$ to describe the side corresponding to the set $\{1\}$ in \mathcal{C} .

More formally, we prove that \mathcal{C} is equal to the polymatroid \mathcal{C}' with rank function μ given by

$$\mu(A) = \min \{f(B) : A \subset B \subset I\}, \quad \forall A \subset I.$$

One can check that this function μ coincides with the one given in the theorem statement. We first show that μ is indeed a rank function and then we prove that \mathcal{C} is equal to \mathcal{C}' .

The normalization of μ follows from that of f . Also μ is non-decreasing by construction. Finally, for each $A, B \subset I$, we have $\mu(A) + \mu(B) = f(A') + f(B')$ for some $A', B' \subset I$ such that $A \subset A'$ and $B \subset B'$, and also

$$f(A') + f(B') \geq f(A' \cup B') + f(A' \cap B') \geq \mu(A \cup B) + \mu(A \cap B),$$

where the first inequality holds by submodularity of f and the second by definition of μ , since $A \cup B \subset A' \cup B'$ and $A \cap B \subset A' \cap B'$. Hence μ is submodular.

We finally prove that $\mathcal{C} = \mathcal{C}'$. It is clear that any vector in \mathcal{C}' is also in $\mathcal{C} = \mathcal{P} \cap \mathbb{R}_+^n$ since $\mu(A) \leq f(A)$ for all $A \subset I$. Conversely, consider $\phi \in \mathcal{C}$. If ϕ is not in \mathcal{C}' , then there is $A \subset I$ so that $\sum_{i \in A} \phi_i > \mu(A)$, which implies that $\mu(A) < f(A)$. By definition of μ , it follows that there is $B \subset I$ so that A is a strict subset of B and $f(B) = \mu(A)$. But then

$$\sum_{i \in B \setminus A} \phi_i = \sum_{i \in B} \phi_i - \sum_{i \in A} \phi_i < f(B) - \mu(A) = 0,$$

so that at least one component of ϕ is negative. This is a contradiction. \square

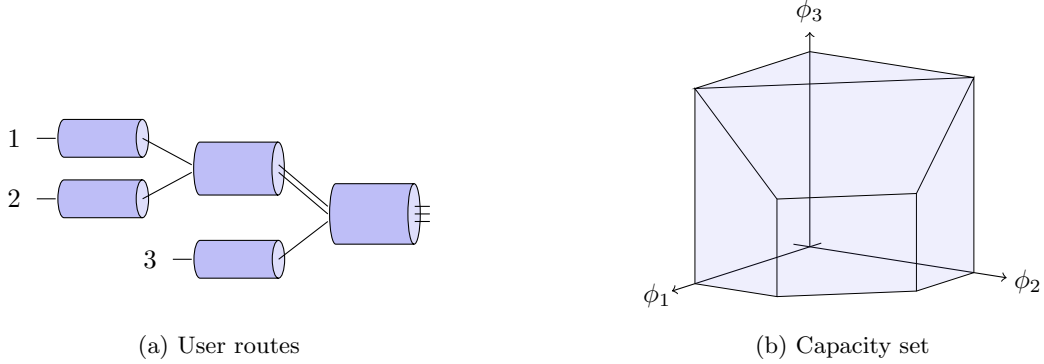

Figure 3: Representation of a tree data network

Example 2. Figure 3 gives the example of a tree data network with its capacity set. The routes of the users are given in Figure 3a. Each link is labeled with the set of user indices whose flows cross this link. The capacity constraints are

$$\phi_1 \leq C_{\{1\}}, \quad \phi_2 \leq C_{\{2\}}, \quad \phi_3 \leq C_{\{3\}}, \quad \phi_1 + \phi_2 \leq C_{\{1,2\}}, \quad \phi_1 + \phi_2 + \phi_3 \leq C_{\{1,2,3\}}.$$

The rank function μ of the capacity set is given by

$$\begin{aligned} \mu(\{1\}) &= C_{\{1\}}, & \mu(\{1, 2\}) &= C_{\{1,2\}}, & \mu(\{1, 2, 3\}) &= C_{\{1,2,3\}}. \\ \mu(\{2\}) &= C_{\{2\}}, & \mu(\{1, 3\}) &= \min(C_{\{1\}} + C_{\{3\}}, C_{\{1,2,3\}}), \\ \mu(\{3\}) &= C_{\{3\}}, & \mu(\{2, 3\}) &= \min(C_{\{2\}} + C_{\{3\}}, C_{\{1,2,3\}}), \end{aligned}$$

2.3 Computer clusters

We consider a cluster of m servers which can be pooled to process jobs in parallel. The set of servers is denoted by $S = \{1, \dots, m\}$. There are n classes of jobs and we denote by $I = \{1, \dots, n\}$ the set of class indices. For any $i \in I$, class- i jobs enter the cluster as a Poisson process with intensity λ_i and have i.i.d. exponential service requirements with mean σ_i , resulting in a traffic intensity $\rho_i = \lambda_i \sigma_i$ for class i . Jobs leave the cluster immediately after service completion. The state of the cluster is described by the vector $x = (x_i : i \in I)$, where x_i is the number of jobs of class i , for each $i \in I$.

The class of a job defines the set of servers that can process it. The server assignment is given by a family $(S_i : i \in I)$ of subsets of S , where S_i denotes the set of servers that can serve class- i jobs, for each $i \in I$. Equivalently, the server assignment can be described by a bipartite graph

$$G = \left(I, S, \bigcup_{i \in I} (\{i\} \times S_i) \right)$$

called the *assignment graph* of the computer cluster. The service capacity of server s is μ_s for each $s = 1, \dots, m$. For any set $A \subset I$ of job classes, we let

$$\mu(A) = \sum_{s \in \bigcup_{i \in A} S_i} \mu_s \tag{2}$$

denote the aggregate capacity available for the classes in A .

We make the following assumptions on the allocation of the server capacities. Servers can be pooled to process jobs in parallel. When a job is in service on several servers, its service rate is the sum of the rates allocated by each server to this job. We also assume that the capacity of each server can be divided

continuously among the jobs it can serve. Finally, the allocation of the service rates per job only depends on the number of jobs of each class in the cluster. In particular, all jobs of a class receive service at the same rate, so that the per-job resource allocation is entirely defined in any state $x \in \mathbb{N}^n$ by the total capacity $\phi_i(x)$ allocated to class- i jobs, for each $i \in I$.

Under these assumptions, we can describe the evolution of the cluster with a processor-sharing system with n queues, one per class. For each $i \in I$, queue i contains class- i jobs and its service rate in state x is the total capacity $\phi_i(x)$ allocated to class- i jobs collectively. It was proved in [17] that the capacity set of such a cluster is a polymatroid and that the function μ defined by (2) is its rank function.

Example 3. Figure 1b gives the assignment graph for an example of a computer cluster, where job classes are on the left and servers are on the right. Server 2 can serve both classes whereas servers 1 and 3 are specialized. The corresponding processor-sharing system with 2 queues is shown in Figure 1c and its capacity set, which is a polymatroid in \mathbb{R}_+^2 , is depicted Figure 1d. The vertical and horizontal sides correspond to the individual constraints of classes 1 and 2, with $\mu(\{1\}) = \mu_1 + \mu_2$ and $\mu(\{2\}) = \mu_2 + \mu_3$. The diagonal side corresponds to the joint constraint on classes 1 and 2, with $\mu(\{1, 2\}) = \mu_1 + \mu_2 + \mu_3$.

2.4 Balanced fairness

The service rates are allocated by applying balanced fairness [3] in the polymatroid capacity set \mathcal{C} introduced in Section 2.1.

For each $i \in I$, let e_i denote the n -dimensional vector with 1 in position i and 0 elsewhere. Balanced fairness is defined as the only resource allocation that both satisfies the *balance property*

$$\phi_i(x)\phi_j(x - e_i) = \phi_i(x - e_j)\phi_j(x), \quad \forall x \in \mathbb{N}^n, \quad \forall i, j \in I(x),$$

and maximizes the resource utilization in the following sense: in any state $x \in \mathbb{N}^n$, $\phi(x) \in \mathcal{C}$ and there exists $A \subset I(x)$ such that

$$\sum_{i \in A} \phi_i(x) = \mu(A).$$

The balance property ensures that there exists a balance function Φ on \mathbb{N}^n such that $\Phi(0) = 1$ and

$$\phi_i(x) = \frac{\Phi(x - e_i)}{\Phi(x)}, \quad \forall x \in \mathbb{N}^n \setminus \{0\}, \quad \forall i \in I(x).$$

The second condition implies that Φ satisfies the recursion

$$\Phi(x) = \max_{A \subset I(x)} \left\{ \frac{\sum_{i \in A} \Phi(x - e_i)}{\mu(A)} \right\}, \quad \forall x \in \mathbb{N}^n \setminus \{0\}.$$

In [17] it is proved that balanced fairness is Pareto-efficient in polymatroid capacity sets, which means that this maximum is always achieved by the set $I(x) = \{i \in I : x_i > 0\}$ of active queues:

$$\Phi(x) = \frac{\sum_{i \in I(x)} \Phi(x - e_i)}{\mu(I(x))}, \quad \forall x \in \mathbb{N}^n \setminus \{0\}. \quad (3)$$

Since the balance property is satisfied, the processor-sharing system defined in Section 2.1 is a Whittle network [16]. A stationary measure of the system state $\mathbf{X} = (\mathbf{X}_i : i \in I)$ is

$$\pi(x) = \pi(0)\Phi(x)\rho^x, \quad \forall x \in \mathbb{N}^n,$$

where we use the notation $\rho^x = \prod_{i \in I} \rho_i^{x_i}$ for any $x \in \mathbb{N}^n$. Substituting (3) into this expression yields

$$\pi(x) = \frac{\sum_{i \in I(x)} \rho_i \pi(x - e_i)}{\mu(I(x))}, \quad \forall x \in \mathbb{N}^n \setminus \{0\}.$$

It is proved in [3] that the system is stable, in the sense that the underlying Markov process is ergodic, if and only if

$$\sum_{i \in A} \rho_i < \mu(A), \quad \forall A \subset I,$$

which means that the vector of traffic intensities belongs to the interior of the capacity set. In the rest of the paper, we assume that this condition is satisfied and we denote by π the stationary distribution of the system state.

2.5 Performance metrics

By abuse of notation, for each $A \subset I$, we denote by $\pi(A)$ the stationary probability that the set of active queues is A :

$$\pi(A) = \mathbb{P}\{I(\mathbf{X}) = A\} = \sum_{\substack{x \in \mathbb{N}^n, \\ I(x) = A}} \pi(x), \quad \forall A \subset I.$$

For each $i \in I$, let $L_i = \mathbb{E}[\mathbf{X}_i]$ denote the mean number of jobs at queue i and, for each $A \subset I$, let $L_i(A) = \mathbb{E}[\mathbf{X}_i | I(\mathbf{X}) = A]$ denote the mean number of jobs at queue i given that the set of active queues is A . By the law of total expectation, we have

$$L_i = \sum_{A \subset I} L_i(A) \pi(A), \quad \forall i \in I.$$

The following theorem gives a recursive formula for $\pi(A)$ and $L_i(A)$ for any $A \subset I$ and $i \in I$. It is a restatement of Theorem 4 in [17] using the same idea as Proposition 4 and Theorem 1 in [18].

Theorem 2. *For each non-empty set $A \subset I$, we have*

$$\pi(A) = \frac{\sum_{i \in A} \rho_i \pi(A \setminus \{i\})}{\mu(A) - \sum_{i \in A} \rho_i}. \quad (4)$$

Let $i \in I$. For each set $A \subset I$, we have $L_i(A) = 0$ if $i \notin A$, and otherwise

$$\pi(A) L_i(A) = \frac{\rho_i \pi(A \setminus \{i\}) + \rho_i \pi(A) + \sum_{j \in A \setminus \{i\}} \rho_j \pi(A \setminus \{j\}) L_i(A \setminus \{j\})}{\mu(A) - \sum_{j \in A} \rho_j}. \quad (5)$$

Observe that (4) allows one to evaluate recursively $\pi(A)/\pi(\emptyset)$ for each $A \subset I$, from which $\pi(\emptyset)$ can be computed. Similarly, for each $i \in I$, (5) allows one to evaluate recursively $\pi(A) L_i(A)/\pi(\emptyset)$ for each $A \subset I$ and each $i \in I$, from which the value of L_i can be deduced. One could then compute performance metrics like the mean delay or the mean service rate per queue from L_i by applying Little's law. Note that the complexity is exponential in the number of queues.

3 Poly-symmetry

3.1 Definition

The exponential complexity of the formulas of Theorem 2 makes it impractical when we want to predict the performance of large-scale systems. To cope with this, we introduce the notion of poly-symmetry, which allows us to obtain formulas with a complexity that is polynomial in the number of queues at the cost of some regularity assumptions on the capacity set and the traffic intensity at each queue. Poly-symmetry is a generalization of the notion of symmetry which was considered in [17, 18].

The following definition will be used subsequently to introduce poly-symmetry. It is easy to check that it defines an equivalence relation on the set I of indices.

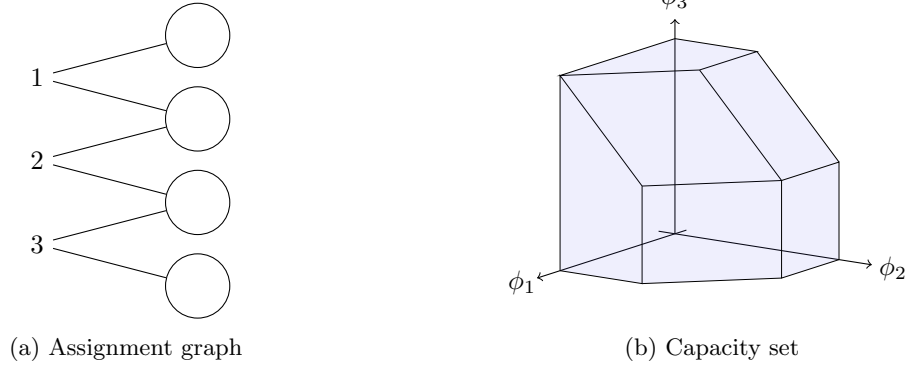

Figure 4: Computer cluster with two exchangeable indices and a third index

Definition 3. Let \mathcal{C} be a polymatroid on \mathbb{R}_+^n and denote its rank function by μ . Let $i, j \in I$ with $i \neq j$. We say that indices i and j are *exchangeable* in \mathcal{C} if

$$\mu(A \cup \{i\}) = \mu(A \cup \{j\}), \quad \forall A \subset I \setminus \{i, j\}.$$

As the name suggests, two indices are exchangeable if and only if exchanging these indices does not modify the capacity set. Note that the exchangeability of two indices i and j implies that they have the same individual constraints $\mu(\{i\}) = \mu(\{j\})$. The reverse implication is not true when $n > 2$, as we will see in the following example.

Example 4. Consider the computer cluster with the assignment graph depicted in Figure 4a, where all servers have the same unit capacity. The corresponding polymatroid capacity set is illustrated in Figure 4b. We have $\mu(\{1\}) = \mu(\{3\}) = 2$ and $\mu(\{1, 2\}) = \mu(\{2, 3\}) = 3$, so that indices 1 and 3 are exchangeable. Index 2 is not exchangeable with any of the two other indices because $\mu(\{1, 2\}) = \mu(\{2, 3\}) = 3$ while $\mu(\{1, 3\}) = 4$.

Let us now define poly-symmetry. Suppose $K \geq 1$ and consider a partition $\Sigma = (I_k : k = 1, \dots, K)$ of I in K parts.

Definition 4. Let \mathcal{C} be a polymatroid in \mathbb{R}_+^n . \mathcal{C} is called *poly-symmetric* with respect to partition Σ if for any $k = 1, \dots, K$, all indices in I_k are pairwise exchangeable in \mathcal{C} .

Since the exchangeability of indices defines an equivalence relation on I , we can consider the quotient set of I by this relation, which is the partition of I into the maximal sets of pairwise exchangeable indices. Definition 4 can then be rephrased as follows: a polymatroid \mathcal{C} is poly-symmetric with respect to a partition Σ if and only if Σ is a refinement of the quotient set of I by the exchangeability relation in \mathcal{C} . It follows directly from the definition that the polymatroid of Example 2 is poly-symmetric with respect to partition $(\{1, 2\}, \{3\})$ when $C_{\{1\}} = C_{\{2\}}$, as we can see in Figure 3b. Also in Example 4, the polymatroid is poly-symmetric with respect to partition $(\{1, 3\}, \{2\})$.

For each $k = 1, \dots, K$, let $n_k = |I_k|$ denote the size of part k , where by part we mean a subset of the partition. For any $A \subset I$, let $|A|_\Sigma = (|A \cap I_k| : k = 1, \dots, K)$ denote the vector of sizes of each part of A in the partition. The set of these vectors is denoted by

$$\mathcal{N} = \prod_{k=1}^K \{0, 1, \dots, n_k\}.$$

We now give an alternative definition of poly-symmetry which is equivalent to Definition 4. It is a generalization of the definition of symmetry given in [17, 18]. We will use it to express and prove Theorem 3.

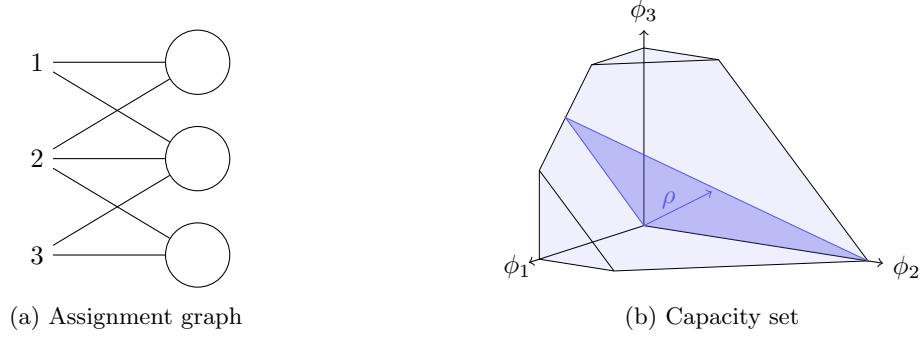

Figure 5: Computer cluster with a polymatroid capacity set which is poly-symmetric with respect to partition $\Sigma = (\{1, 3\}, \{2\})$

Definition 5. Let \mathcal{C} be a polymatroid in \mathbb{R}_+^n and denote its rank function by μ . \mathcal{C} is called *poly-symmetric* with respect to partition Σ if for any $A \subset I$, $\mu(A)$ depends on A only through the size of $A \cap I_k$ for each $k = 1, \dots, K$. Equivalently, there exists a componentwise non-decreasing function $h : \mathcal{N} \rightarrow \mathbb{R}_+$ such that $\mu(A) = h(|A|_\Sigma)$ for all $A \subset I$. We call h the *cardinality rank function* of \mathcal{C} with respect to partition Σ .

Proof of the equivalence. We only prove that Definition 4 implies Definition 5; the reverse implication is clear. For any $A, B \subset I$ with $|A|_\Sigma = |B|_\Sigma$, we can write $A = (A \setminus B) \sqcup (A \cap B)$ and $B = (B \setminus A) \sqcup (A \cap B)$, where \sqcup denotes the union of two disjoint sets. Since we have $|A \setminus B|_\Sigma = |B \setminus A|_\Sigma$, we are thus reduced to proving that $\mu(A \sqcup C) = \mu(B \sqcup C)$ for all disjoint sets $A, B, C \subset I$ such that $|A|_\Sigma = |B|_\Sigma$. This can be done by ascending induction on the cardinality of A and B . \square

Example 5. Consider the computer cluster with the assignment graph depicted in Figure 5, where all servers have the same unit capacity. The corresponding capacity set is illustrated in Figure 5b. It is poly-symmetric with respect to partition $\Sigma = (\{1, 3\}, \{2\})$ and the corresponding cardinality rank function h is given by $h(0, 0) = 0$, $h(1, 0) = 2$ and $h(0, 1) = h(1, 1) = 3$.

3.2 Performance metrics

Let $\Sigma = (I_k : k = 1, \dots, K)$ be a partition of I . We consider a processor-sharing system with a polymatroid capacity set which is poly-symmetric with respect to Σ . For each $A \subset I$, the vector $|A|_\Sigma = (|A \cap I_k| : k = 1, \dots, K)$ gives the number of active queues in each part of the partition when the set of active queues is A . By abuse of notation, for each $k = 1, \dots, K$, we denote by e_k the vector of \mathbb{N}^K with 1 in component k and 0 elsewhere.

As in Section 2.4, the resources are allocated by applying balanced fairness in this capacity set under some vector of traffic intensity ρ which satisfies the stability constraints. For simplicity of notation, for each $a \in \mathcal{N}$, we denote by $\pi(a)$ the probability that the number of active queues in part k is a_k for each $k = 1, \dots, K$:

$$\pi(a) = \mathbb{P}\{|I(\mathbf{X})|_\Sigma = a\} = \sum_{\substack{A \subset I, \\ |A|_\Sigma = a}} \pi(A).$$

For each $k = 1, \dots, K$, let $L_k = \mathbb{E}[\sum_{i \in I_k} \mathbf{X}_i]$ denote the mean number of jobs in the queues of part k and, for each $a \in \mathcal{N}$, let $L_k(a) = \mathbb{E}[\sum_{i \in I_k} \mathbf{X}_i | |I(\mathbf{X})|_\Sigma = a]$ denote the mean number of jobs in the queues of part k given that there are a_l active queues in part l for each $l = 1, \dots, K$. The regularity assumptions ensure that, for each $k = 1, \dots, K$, $\frac{1}{n_k} L_k$ and $\frac{1}{n_k} L_k(a)$ for each $a \in \mathcal{N}$ also give the mean numbers of jobs at queue i for any $i \in I_k$. By the law of total expectation, we have

$$L_k = \sum_{a \in \mathcal{N}} L_k(a) \pi(a), \quad \forall k = 1, \dots, K.$$

The following theorem gives a recursive formula for $\pi(a)$ and $L_k(a)$ that allows one to compute recursively these quantities with a complexity $O(n_1 \cdots n_K)$. The proof is given in Appendix A.

Theorem 3. Consider a system of n processor-sharing queues with state-dependent service rates allocated according to balanced fairness in a polymatroid capacity set \mathcal{C} . Assume that \mathcal{C} is poly-symmetric with respect to partition Σ and denote by h the corresponding cardinality rank function. Further assume that for each $k = 1, \dots, K$, all queues of I_k receive jobs with the same traffic intensity ϱ_k , i.e. $\rho_i = \varrho_k$ for all $i \in I_k$. For each $a \in \mathcal{N} \setminus \{0\}$, we have

$$\pi(a) = \frac{\sum_{k=1}^K (n_k - a_k + 1) \varrho_k \pi(a - e_k)}{h(a) - \sum_{k=1}^K a_k \varrho_k}. \quad (6)$$

Let $k = 1, \dots, K$. For each $a \in \mathcal{N}$, we have $L_k(a) = 0$ if $a_k = 0$, and otherwise

$$\pi(a) L_k(a) = \frac{a_k \varrho_k \pi(a) + (n_k - a_k + 1) \varrho_k \pi(a - e_k) + \sum_{l=1}^K (n_l - a_l + 1) \varrho_l \pi(a - e_l) L_k(a - e_l)}{h(a) - \sum_{l=1}^K a_l \varrho_l}. \quad (7)$$

This result applies to Example 5 with the partition $\Sigma = (\{1, 3\}, \{2\})$ when classes 1 and 3 have the same traffic intensity. The set of suitable vectors of traffic intensities is depicted as the darkly shaded region in Figure 5b.

In this theorem, we have assumed that the cardinality rank function h was given. Given a real system like those of Sections 2.2 and 2.3 which is known to be poly-symmetric with regard to some partition $\Sigma = (I_k : k = 1, \dots, K)$, one could ask if it is also possible to build h with a complexity $O(n_1 \cdots n_K)$. This is straightforward for a computer cluster. Concerning the tree data networks, we can actually apply a method similar to that of the proof of Theorem 1. Specifically, we first define recursively a concave function f on \mathcal{N} by $f(0) = 0$, $f(a) = C_L$ if there is $L \in \mathcal{T}$ so that $|L|_\Sigma = a$, and otherwise

$$f(a) = \min\{f(b) + f(c) : b, c \in \mathcal{N} \text{ s.t. } b, c \neq a \text{ and } a = b + c\},$$

from which we can construct h by letting

$$h(a) = \min\{f(b) : b \in \mathcal{N} \text{ and } a \leq b\}, \quad \forall a \in \mathcal{N}.$$

We will now see two examples of real systems where this result applies.

3.3 Application to tree data networks

We consider the simple example of a tree data network where each user has an individual access line and all users share an aggregation link which has a capacity C in bit/s. The user access lines can have K different capacities r_1, \dots, r_K in bit/s. This corresponds to the model introduced in [1] to predict some performance metrics in Internet service provider access networks, where the individual access lines represent subscriber lines which are connected to the aggregation link by the digital subscriber line access multiplexer (DSLAM).

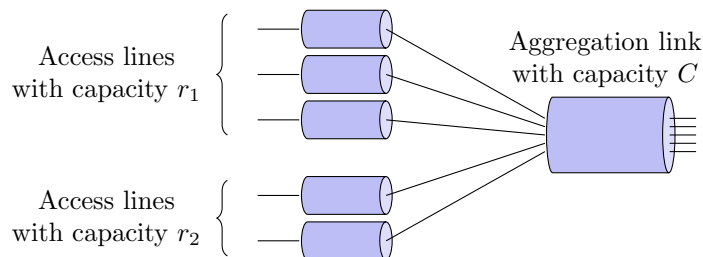

Figure 6: User routes

Example 6. Figure 6 gives a toy example with $K = 2$ possible access rates r_1 and r_2 . There are three users with access rate r_1 and two users with access rate r_2 . All users are constrained by the aggregation link with capacity C .

For each $k = 1, \dots, K$ we denote by I_k the set of users with access rate r_k . These form a partition of the set $I = \bigsqcup_{k=1}^K I_k$ of users. Theorem 1 ensures that the capacity set of this data network is a polymatroid with rank function μ given by

$$\mu(A) = \min \left(\sum_{k=1}^K |A \cap I_k| r_k, C \right), \quad \forall A \subset I. \quad (8)$$

It is poly-symmetric with respect to partition $\Sigma = (I_k : k = 1, \dots, K)$. The corresponding cardinality rank function h is given by

$$h(a) = \min \left(\sum_{k=1}^K a_k r_k, C \right), \quad \forall a \in \mathcal{N}.$$

We further assume that for each $k = 1, \dots, K$, all users with access rate r_k have the same traffic intensity $\varrho_k < r_k$. Then the network is stable whenever $\sum_{k=1}^K n_k \varrho_k < C$, and it meets the conditions of Theorem 3.

A metric of interest is the mean throughput per user. For each $i \in I$, we denote by \mathbb{P}_i and \mathbb{E}_i the conditional probability measure and expectation given that user i is active, corresponding to the stationary distribution $\pi_i(x) \propto 1_{x_i > 0} \pi(x)$. For each $k = 1, \dots, K$ and each $i \in I_k$, the mean throughput perceived by user i is then given by

$$\mathbb{E}_i[\phi_i(\mathbf{X})] = \frac{\mathbb{E}[\phi_i(\mathbf{X})]}{\mathbb{P}\{\mathbf{X}_i > 0\}} = \frac{\varrho_k}{\mathbb{P}\{\mathbf{X}_i > 0\}},$$

where the second equality holds by the conservation equation $\varrho_k = \mathbb{E}[\phi_i(\mathbf{X})]$ for all $i \in I_k$. Using the notations of Section 3.2, the mean throughput of the users with access rate r_k is given by

$$\gamma_k = \frac{\varrho_k}{1 - \sum_{a \in \mathcal{N} : a_k < n_k} \binom{n_k - 1}{a_k} \prod_{l \neq k} \binom{n_l}{a_l} \pi(a)}.$$

where $\pi(a)$ for each $a \in \mathcal{N}$ can be computed with a complexity $O(n_1 \cdots n_K)$ by (6). Other performance metrics such as the mean congestion rate per user can be computed similarly.

3.4 Application to computer clusters

Let $d_1, d_2 \geq 1$. We consider a computer cluster with $m = d_1 d_2$ servers and $n = d_1 + d_2$ classes. All servers have the same unit capacity and all jobs have a unit mean size. The set I of classes is partitioned into two subsets I_1 and I_2 . I_1 contains d_2 classes that can each be served by d_1 servers and I_2 contains d_1 classes that can each be served by d_2 servers. For any $i = 1, \dots, d_2$, the i -th class of I_1 can be served by the servers $(i-1)d_1 + j$ for $j = 1, \dots, d_1$. For any $i = 1, \dots, d_1$, the i -th class of I_2 can be served by the servers $i + (j-1)d_1$ for $j = 1, \dots, d_2$. Figure 7 gives a toy example with $d_1 = 2$ and $d_2 = 3$.

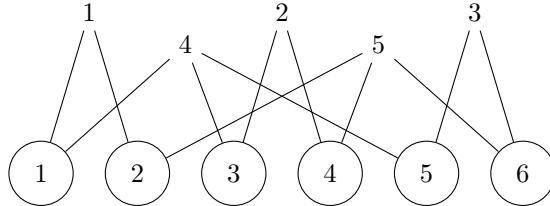

Figure 7: Computer cluster with $d_1 = 2$ and $d_2 = 3$

Any class of I_1 shares exactly one server with any class of I_2 , and this server is dedicated to these two classes. The rank function of this cluster is thus given by

$$\mu(A) = |A \cap I_1| d_1 + |A \cap I_2| d_2 - |A \cap I_1| \times |A \cap I_2|, \quad \forall A \subset I.$$

The polymatroid capacity set defined by this rank function is poly-symmetric with respect to partition $\Sigma = (I_1, I_2)$ and the corresponding cardinality rank function is given by

$$h(a) = a_1 d_1 + a_2 d_2 - a_1 a_2, \quad \forall a \in \mathcal{N}.$$

For each $k = 1, 2$, assume that all classes in I_k have the same traffic intensity ϱ_k . Further assume that the vector of traffic intensities $\varrho = (\varrho_1, \varrho_2)$ stabilizes the system, that is

$$a_1 \varrho_1 + a_2 \varrho_2 < a_1 d_1 + a_2 d_2 - a_1 a_2, \quad \forall a \in \mathcal{N}.$$

We can then apply Theorem 3 with partition Σ to compute the mean number of jobs of each class with a complexity $O(n_1 n_2)$. We deduce the mean delay δ_i of class- i jobs for each $i \in I$ by Little's law:

$$\delta_i = \frac{L_k}{n_k \lambda_i}, \quad \forall k = 1, 2, \quad \forall i \in I_k.$$

4 Stochastic Bounds

4.1 Monotonicity result

While the property of poly-symmetry is not often satisfied in practice, except in specific cases like the examples of Sections 3.3 and 3.4, it can be used to derive stochastic bounds on most systems, as shown below. The following result will allow us to control the impact of the capacity set on performance.

Given $0 < \epsilon < 1$ and a polymatroid \mathcal{C} in \mathbb{R}_+^n with rank function μ , we denote by $(1 + \epsilon)\mathcal{C}$ the polymatroid in \mathbb{R}_+^n with rank function $(1 + \epsilon)\mu$ and by $(1 - \epsilon)\mathcal{C}$ the polymatroid in \mathbb{R}_+^n with rank function $(1 - \epsilon)\mu$.

Theorem 4. *Let $0 < \epsilon < 1$. Consider two polymatroids $\hat{\mathcal{C}}$ and \mathcal{C} in \mathbb{R}_+^n such that $\hat{\mathcal{C}}$ is a subset of $(1 + \epsilon)\mathcal{C}$ and a superset of $(1 - \epsilon)\mathcal{C}$. Let ρ be an element in the interior of $(1 - \epsilon)\mathcal{C}$ and denote respectively by π , π_+ and π_- the steady state distributions of the processor-sharing systems with capacity sets $\hat{\mathcal{C}}$, $(1 + \epsilon)\mathcal{C}$ and $(1 - \epsilon)\mathcal{C}$ under traffic intensity ρ . Then*

$$\frac{\pi_-(0)}{\pi_+(0)} \pi_+(x) \leq \pi(x) \leq \frac{\pi_+(0)}{\pi_-(0)} \pi_-(x), \quad \forall x \in \mathbb{N}^n.$$

Specifically, for each $i \in I$, we have

$$\frac{\pi_-(0)}{\pi_+(0)} L_{i,+} \leq L_i \leq \frac{\pi_+(0)}{\pi_-(0)} L_{i,-},$$

where L_i , $L_{i,+}$ and $L_{i,-}$ are the mean number of job at queue i under distributions π , π_+ and π_- respectively.

Proof. Denote by $\hat{\mu}$ and μ the rank functions of $\hat{\mathcal{C}}$ and \mathcal{C} respectively. Let Φ , Φ_+ and Φ_- denote the balance functions of the resource allocations defined by balanced fairness in the capacity sets $\hat{\mathcal{C}}$, $(1 + \epsilon)\mathcal{C}$ and $(1 - \epsilon)\mathcal{C}$ respectively. We first prove by induction on $|x|$ that

$$\Phi_+(x) \leq \Phi(x) \leq \Phi_-(x), \quad \forall x \in \mathbb{N}^n.$$

The property holds for $x = 0$. Let $x \in \mathbb{N}^n \setminus \{0\}$ and assume the inequality is valid for any $y \in \mathbb{N}^n$ such that $|y| < |x|$. Then we have by (3):

$$\Phi(x) = \frac{\sum_{i \in I(x)} \Phi(x - e_i)}{\hat{\mu}(I(x))} \leq \frac{\sum_{i \in I(x)} \Phi_-(x - e_i)}{\hat{\mu}(I(x))} \leq \frac{\sum_{i \in I(x)} \Phi_-(x - e_i)}{(1 - \epsilon)\mu(I(x))} = \Phi_-(x)$$

where the first inequality holds by the induction assumption and the second holds by the inclusion of $(1 - \epsilon)\mathcal{C}$ into $\hat{\mathcal{C}}$. We prove the other side of the inequality by using the inclusion of $\hat{\mathcal{C}}$ into $(1 + \epsilon)\mathcal{C}$. This completes the proof by induction.

It follows that

$$\frac{1}{\pi(0)} = \sum_{x \in \mathbb{N}^n} \Phi(x) \rho^x \geq \sum_{x \in \mathbb{N}^n} \Phi_+(x) \rho^x = \frac{1}{\pi_+(0)}.$$

Thus for each $x \in \mathbb{N}^n$, we obtain

$$\pi(x) = \pi(0) \Phi(x) \rho^x \leq \pi(0) \Phi_-(x) \rho^x \leq \pi_+(0) \Phi_-(x) \rho^x = \frac{\pi_+(0)}{\pi_-(0)} \pi_-(x).$$

The proof for the other part of the inequality is similar. The second inequality about the mean number of jobs follows by summation. \square

The following sections illustrate how we can apply this result to the models of tree data networks and computer clusters.

4.2 Application to tree data networks

We first use this result to relax some assumptions of Section 3.3. The flows of each user go through an individual access line which is dedicated to this user and an aggregation link shared by all users. We still consider K groups I_1, \dots, I_K of users which form a partition of the set I . For each $k = 1, \dots, K$, the access rates of the users in I_k may be different but we assume that they are all between $(1-\epsilon)r_k$ and $(1+\epsilon)r_k$ for some $\epsilon > 0$. Similarly, the capacity of the aggregation link is between $(1-\epsilon)C$ and $(1+\epsilon)C$. The corresponding polymatroid capacity set $\hat{\mathcal{C}}$ is not poly-symmetric with respect to partition $\Sigma = (I_k : k = 1, \dots, K)$ any more but its rank function $\hat{\mu}$ satisfies:

$$(1-\epsilon)\mu(A) \leq \hat{\mu}(A) \leq (1+\epsilon)\mu(A), \quad \forall A \subset I,$$

where μ is the rank function defined by (8). Denoting by \mathcal{C} the polymatroid defined by μ , it follows that $\hat{\mathcal{C}}$ is a superset of $(1-\epsilon)\mathcal{C}$ and a subset of $(1+\epsilon)\mathcal{C}$. We can thus apply Theorem 4. In the special case where for each $k = 1, \dots, K$, all users of I_k have the same traffic intensity $\varrho_k < (1-\epsilon)r_k$, with $\sum_{k=1}^K n_k \varrho_k < (1-\epsilon)C$, we can use Theorem 3 to compute the bounds.

Specifically, let π_+ and π_- denote the steady state distributions of the processor-sharing systems with capacity sets $(1+\epsilon)\mathcal{C}$ and $(1-\epsilon)\mathcal{C}$ respectively under traffic intensity ρ . For each $k = 1, \dots, K$ and each $i \in I_k$, the mean throughput γ_i of user i satisfies

$$\frac{\pi_-(0)}{\pi_+(0)} \gamma_{k,-} \leq \gamma_i \leq \frac{\pi_+(0)}{\pi_-(0)} \gamma_{k,+},$$

where $\gamma_{k,+}$ and $\gamma_{k,-}$ are the mean throughputs under distributions π_+ and π_- respectively. We have

$$\gamma_{k,\pm} = \frac{\varrho_k}{1 - \sum_{a \in \mathcal{N}: a_k < n_k} \binom{n_k-1}{a_k} \prod_{l \neq k} \binom{n_l}{a_l} \pi_{\pm}(a)}, \quad \forall k = 1, \dots, K,$$

and by (6)

$$\pi_{\pm}(a) = \frac{\sum_{k=1}^K (n_k - a_k + 1) \varrho_k \pi_{\pm}(a - e_k)}{(1 \pm \epsilon)h(a) - \sum_{k=1}^K a_k \varrho_k}, \quad \forall a \in \mathcal{N} \setminus \{0\}.$$

4.3 Application to computer cluster with random assignment

Random assignment. Consider a cluster as described in Section 2.3, where we denote by $S = \{1, \dots, m\}$ the set of servers and by I the set of class indices. Let $K \geq 1$ and consider for simplicity a partition $\Sigma = (I_1, \dots, I_K)$ of I into K parts of size n , so that the total number of job classes in the cluster is now given by Kn . We can easily generalize the result to K parts of different sizes. We use the same notation as in Sections 3.1 and 3.2: for each $A \subset I$, $a = |A|_{\Sigma}$ denotes the K -dimensional vector whose k -th component

is $a_k = |A \cap I_k|$, the size of the k -th part of A in partition Σ , for each $k = 1, \dots, K$; the set of these vectors is denoted by $\mathcal{N} = \{0, 1, \dots, n\}^K$.

We now introduce a random assignment of the servers to the job classes, which is described by an assignment graph with random edges. Each realization of this random assignment defines a polymatroid capacity set as in Section 2.1. Hence, once this initial assignment is settled, we can apply balanced fairness over the associated capacity set as described in Section 2.4. Note that our assignment is static in the sense that the assignment graph does not change with time. For a given realization, we can thus observe the evolution of the cluster under stochastic arrivals and compute the resulting performance metrics as we did in Section 2.5.

The servers are randomly assigned to the job classes as follows. Let $d = (d_k : k = 1, \dots, K)$ be a vector of positive integers. For any $k = 1, \dots, K$ and $i \in I_k$, the set \mathbf{S}_i of servers that can process class- i jobs is chosen uniformly and independently at random among the subsets of $S = \{1, \dots, m\}$ of cardinality d_k . As in Section 2.3, the random assignment is described by the family $(\mathbf{S}_i : i \in I)$ which defines a random bipartite graph

$$\mathbf{G} = \left(I, S, \bigcup_{i \in I} (\{i\} \times \mathbf{S}_i) \right)$$

with deterministic sets of vertices I and S and a random set of edges. Each realization $(S_i : i \in I)$ of the random assignment defines a polymatroid capacity set with a rank function given by (2). This allows us to define a random rank function associated with the random assignment by

$$\mathbf{M}(A) = \sum_{s \in S} \mu_s \mathbf{1}_{s \in \bigcup_{i \in A} \mathbf{S}_i}, \quad \forall A \subset I.$$

Now let μ denote the corresponding mean rank function:

$$\mu(A) = \mathbb{E}[\mathbf{M}(A)], \quad \forall A \subset I.$$

The following lemma proves that the polymatroid defined by μ is poly-symmetric with respect to Σ .

Lemma 2. *For each $A \subset I$, we have $\mu(A) = \xi m p_a$ with $\xi = \frac{1}{m} \sum_{s \in S} \mu_s$, $a = |A|_\Sigma$ and*

$$p_a = 1 - \prod_{k=1}^K \left(1 - \frac{d_k}{m} \right)^{a_k}.$$

Proof. Let $a \in \mathcal{N}$ and consider any set $A \subset I$ with $|A|_\Sigma = a$. We just need to observe that

$$\mu(A) = \sum_{s \in S} \mu_s \mathbb{P} \left\{ s \in \bigcup_{i \in A} \mathbf{S}_i \right\}.$$

For each $k = 1, \dots, K$ such that $a_k > 0$, the probability that a server can not serve a specific class of $A \cap I_k$ is $\binom{m-1}{d_k} / \binom{m}{d_k} = 1 - \frac{d_k}{m}$. Since the assignments of the classes are independent, it follows that the probability that this server can serve at least one class in A is given by p_a . \square

Let $\rho = (\rho_i : i \in I)$ be a vector of traffic intensities. If G is a realization of the random assignment graph \mathbf{G} such that ρ is in the interior of the polymatroid capacity set defined by G , then the corresponding processor-sharing system is stable under balanced fairness and we can study its steady-state behavior. We thus denote by $\mathbf{X} = (\mathbf{X}_i : i \in I)$ the random vector distributed according to the stationary distribution of the system state when ρ is in the interior of \mathbf{G} , and for completeness we let $\mathbf{X} = 0$ otherwise. For each realization G of the random assignment such that ρ is in the interior of the corresponding capacity set, we let

$$L_i(G) = \mathbb{E}[\mathbf{X}_i | \mathbf{G} = G], \quad \forall i \in I,$$

which is simply the mean number of jobs of each class in the corresponding processor-sharing system under balanced fairness, as defined in Section 2.5. For each realization G which is not stabilized by ρ , we let $L_i(G) = +\infty$.

Asymptotic poly-symmetry. We consider a sequence of computer clusters with random assignment as defined in the previous section. Let $K \geq 1$ and $b > 0$.

For each $n \geq 1$, the n -th random cluster of the sequence contains $m^{(n)} = \lceil bn \rceil$ servers and Kn job classes. We denote the set of servers by $S^{(n)} = \{1, \dots, m^{(n)}\}$ and the set of job classes by $I^{(n)} = \{1, \dots, Kn\}$. The service rate of server s is $\mu_s^{(n)}$ for each $s \in S^{(n)}$. For simplicity, we consider a partition $\Sigma^{(n)} = (I_k^{(n)} : k = 1, \dots, K)$ of $I^{(n)}$ into K parts of size n . We can generalize the result to K parts of different sizes as long as the size of each part is linear in n . For each $k = 1, \dots, K$ and $i \in I_k^{(n)}$, the set $\mathbf{S}_i^{(n)}$ of servers that can process class- i jobs is chosen uniformly and independently at random among the subsets of $S^{(n)}$ of cardinality $d_k^{(n)}$. Let $\mathbf{G}^{(n)}$ denote the random graph defined by this random assignment, $\mathbf{M}^{(n)}$ the corresponding random rank function and $\mu^{(n)}$ its expectation.

By Lemma 2, for any $n \geq 1$ and $a \in \mathcal{N}^{(n)} = \{0, \dots, n\}^K$, we have

$$\mu^{(n)}(A) = \mathbb{E} \left[\mathbf{M}^{(n)}(A) \right] = \xi^{(n)} m^{(n)} p_a^{(n)} \quad \text{with} \quad p_a^{(n)} = 1 - \prod_{k=1}^K \left(1 - \frac{d_k^{(n)}}{m} \right)^{a_k}$$

for all set $A \subset I^{(n)}$ with $|A|_{\Sigma^{(n)}} = a$, where $\xi^{(n)} = \frac{1}{m^{(n)}} \sum_{s \in S^{(n)}} \mu_s^{(n)}$ is the mean server capacity. Theorem 5 below shows that, under the following two assumptions on the server capacities and the degrees of parallelism, the probability that the random rank function is uniformly close to its mean is $1 - o\left(\frac{1}{n}\right)$. The proof is given in Appendix B.

Assumption 1. For each $n \geq 1$, $S^{(n)}$ is partitioned into a constant number of groups. Each group contains $\Omega(n)$ servers which have the same capacity.

Assumption 2. For each $k = 1, \dots, K$, the sequence $(d_k^{(n)} : n \geq 1)$ satisfies $d_k^{(n)} = \omega(\log n)$.

Theorem 5. Let $0 < \epsilon < 1$. Under Assumptions 1 and 2, there exists a sequence $(g_n : n \geq 1)$ such that $g_n = \omega(\log n)$ and for any $n \geq 1$,

$$\mathbb{P} \left\{ \exists A \subset I^{(n)} \text{ s.t. } \mathbf{M}^{(n)}(A) \leq (1 - \epsilon) \mu^{(n)}(A) \right\} \leq e^{-g_n}$$

and

$$\mathbb{P} \left\{ \exists A \subset I^{(n)} \text{ s.t. } \mathbf{M}^{(n)}(A) \geq (1 + \epsilon) \mu^{(n)}(A) \right\} \leq e^{-g_n}.$$

Corollary 1 follows from Theorem 5. For any $n \geq 1$, let $\mathcal{C}^{(n)}$ denote the polymatroid defined by the rank function $\mu^{(n)}$. $\mathcal{C}^{(n)}$ is poly-symmetric with respect to the partition $\Sigma^{(n)}$.

Corollary 1. Let $0 < \epsilon < 1$. Under Assumptions 1 and 2, the random capacity set resulting from the random assignment is a subset of $(1 + \epsilon)\mathcal{C}^{(n)}$ and a superset of $(1 - \epsilon)\mathcal{C}^{(n)}$ with probability $1 - o\left(\frac{1}{n}\right)$.

Performance metrics. For each $n \geq 1$, we consider a vector $\varrho^{(n)} \in \mathbb{R}_+^K$ of traffic intensities per part which stabilizes the processor-sharing system with n queues and capacity set $(1 - \epsilon)\mathcal{C}^{(n)}$ under balanced fairness, that is,

$$\sum_{k=1}^K a_k \varrho_k^{(n)} < (1 - \epsilon) h^{(n)}(a), \quad \forall a \in \mathcal{N}^{(n)},$$

where $h^{(n)}$ is the cardinality rank function of the mean capacity set with respect to partition $\Sigma^{(n)}$:

$$h^{(n)}(a) = \xi^{(n)} m^{(n)} p_a^{(n)}, \quad \forall a \in \mathcal{N}^{(n)}.$$

Let $\mathbf{X}^{(n)}$ denote the state in the n -th randomized computer cluster when we allocate the resources according to balanced fairness. Given a realization $G^{(n)}$ which is stabilized by $\varrho^{(n)}$, the mean numbers of jobs per class are given by

$$L_i \left(G^{(n)} \right) = \mathbb{E} \left[\mathbf{X}_i^{(n)} \mid \mathbf{G}^{(n)} = G^{(n)} \right], \quad \forall i \in I^{(n)}.$$

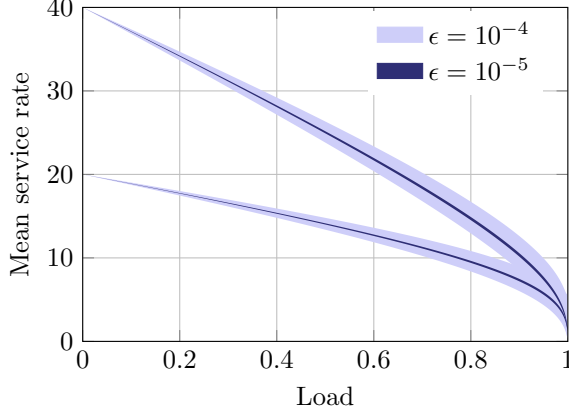

Figure 8: Bounds obtained with $m = 10,000$, $n = 1,000$, $d_1 = 20$, $d_2 = 40$

For each realization $G^{(n)}$ which is not stabilized by $\varrho^{(n)}$, we let $L_i(G^{(n)}) = +\infty$. This allows us to define the random variables

$$\mathbf{L}_i^{(n)} = L_i(\mathbf{G}^{(n)}), \quad \forall i \in I.$$

Combining Theorems 4 and 5 yields the following result.

Theorem 6. *Let $0 < \epsilon < 1$. For any $n \geq 1$, denote by $\pi_+^{(n)}$ and $\pi_-^{(n)}$ the stationary distributions of the processor-sharing systems with n queues and capacity sets $(1 + \epsilon)\mathcal{C}^{(n)}$ and $(1 - \epsilon)\mathcal{C}^{(n)}$ respectively, when the traffic intensity of the classes in $I_k^{(n)}$ is $\varrho_k^{(n)}$, for any $k = 1, \dots, K$. Let $L_{k,+}^{(n)}$ and $L_{k,-}^{(n)}$ denote the corresponding mean number of jobs per queue in part k , for each $k = 1, \dots, K$.*

Under Assumptions 1 and 2, we have

$$\mathbb{P} \left\{ \frac{\pi_-^{(n)}(0)}{\pi_+^{(n)}(0)} \frac{L_{k,+}^{(n)}}{n} \leq \mathbf{L}_i^{(n)} \leq \frac{\pi_+^{(n)}(0)}{\pi_-^{(n)}(0)} \frac{L_{k,-}^{(n)}}{n}, \quad \forall k = 1, \dots, K, \quad \forall i \in I_k \right\} = 1 - o\left(\frac{1}{n}\right).$$

For each $n \geq 1$, Theorem 3 gives formulas to compute $\pi_{\pm}^{(n)}$ and $L_{k,\pm}^{(n)}$ for each $k = 1, \dots, K$ with a complexity $O(n^K)$. Using Little's law, we can deduce bounds on the mean delay per class.

Numerical application. We omit writing the exponents for brevity. Consider a randomized cluster with $m = 10,000$ servers with unit capacity. The set of classes is partitioned into two parts I_1 and I_2 with $n = 1,000$ classes each. The classes of I_1 have a degree $d_1 = 20$ and the ones of I_2 have a degree $d_2 = 40$. All jobs have a mean size 1 and the arrival rates are proportional to the degrees. The traffic intensity of any class in I_2 is thus twice that of any class in I_1 . Let $\varrho \in \mathbb{R}_+^2$ so that

$$\varrho_1 = \frac{d_1}{d_1 + d_2} \frac{h(n, n)}{n} \quad \text{and} \quad \varrho_2 = \frac{d_2}{d_1 + d_2} \frac{h(n, n)}{n},$$

where h is the cardinality rank function of the mean capacity set with respect to partition $\Sigma = (I_1, I_2)$:

$$h(a) = m \left\{ 1 - \left(1 - \frac{d_1}{m}\right)^{a_1} \left(1 - \frac{d_2}{m}\right)^{a_2} \right\}, \quad \forall a \in \{0, 1, \dots, n\}^2.$$

We can prove that the vector of traffic intensities $\rho \in \mathbb{R}_+^{2n}$ with $\rho_i = \varrho_1$ for all $i \in I_1$ and $\rho_i = \varrho_2$ for all $i \in I_2$ is on the boundary of the mean capacity set.

Let $0 < \epsilon < 1$. For each $\alpha \in (0, 1 - \epsilon)$, $\alpha\varrho$ stabilizes the processor-sharing systems with capacity sets $(1 + \epsilon)\mathcal{C}$ and $(1 - \epsilon)\mathcal{C}$. The bounds on the mean delay that follow from Theorem 6 by applying Little's law

are given by

$$\frac{1 + \epsilon \pi_-(0) L_{k,+}}{\alpha \pi_+(0) n \varrho_k} \quad \text{and} \quad \frac{1 - \epsilon \pi_+(0) L_{k,-}}{\alpha \pi_-(0) n \varrho_k},$$

where $\pi_{\pm}(0)$ and $L_{k,\pm}$ are computed with the recursion expressions of Theorem 3 as follows. For each $a \in \{0, 1, \dots, n\}^2$,

$$\pi_{\pm}(a) = \frac{(n - a_1 + 1) \varrho_1 \pi_{\pm}(a - e_1) + (n - a_2 + 1) \varrho_2 \pi_{\pm}(a - e_2)}{\frac{1 \pm \epsilon}{\alpha} h(a) - a_1 \varrho_1 - a_2 \varrho_2}.$$

For any $k = 1, 2$ and $a \in \mathcal{N}$, we have $L_{k,\pm}(a) = 0$ if $a_k = 0$, and otherwise

$$\pi_{\pm}(a) L_{k,\pm}(a) = \frac{1}{\frac{1 \pm \epsilon}{\alpha} h(a) - a_1 \varrho_1 - a_2 \varrho_2} \left\{ a_k \varrho_k \pi_{\pm}(a) + (n - a_k + 1) \varrho_k \pi_{\pm}(a - e_k) + \sum_{l=1}^2 (n - a_l + 1) \varrho_l \pi_{\pm}(a - e_l) L_{k,\pm}(a - e_l) \right\}.$$

Figure 8 gives the bounds obtained as a function of $\alpha \in (0, 1 - \epsilon)$, for different values of ϵ . For simplicity, we draw the mean service rate per job, which is simply the inverse of the mean delay since all jobs have a unit mean size.

5 Conclusion

In this paper, we consider processor-sharing systems and introduce a poly-symmetry criterion on the structure of their capacity set which ensures that the performance metrics can be computed with a complexity which is polynomial in the number of queues if the traffic intensities per queue are adjusted accordingly. We showed that these formulas can also be used to bound the performance of a system when its capacity set is nearly poly-symmetric. We applied these results to tree data networks and computer clusters.

In future works, we would like to generalize the notion of poly-symmetry to relax some symmetry assumptions imposed in this paper while keeping a reasonable time complexity for the calculation of the performance metrics. We also believe there is further scope of enhancing the stochastic bounds by expanding their scope as well as obtaining tighter bounds in some specific scaling regimes.

Appendix

A Proof of Theorem 3

A.1 Recursion (6)

Let $a \in \mathcal{N} \setminus \{0\}$. By (4), we have

$$\pi(a) = \sum_{\substack{A \subset I \\ |A|_{\Sigma} = a}} \pi(A) = \sum_{\substack{A \subset I \\ |A|_{\Sigma} = a}} \frac{\sum_{i \in A} \rho_i \pi(A \setminus \{i\})}{\mu(A) - \sum_{i \in A} \rho_i}.$$

The regularity assumptions ensure that $\mu(A) - \sum_{i \in A} \rho_i = h(a) - \sum_{k=1}^K a_k \varrho_k$ for any $A \subset I$ with $|A|_{\Sigma} = a$. Thus we obtain

$$\left(h(a) - \sum_{k=1}^K a_k \varrho_k \right) \pi(a) = \sum_{\substack{A \subset I \\ |A|_{\Sigma} = a}} \sum_{i \in A} \rho_i \pi(A \setminus \{i\}) = \sum_{k=1}^K \varrho_k \sum_{i \in I_k} \sum_{\substack{A \subset I, i \in A \\ |A|_{\Sigma} = a}} \pi(A \setminus \{i\}).$$

For any $k = 1, \dots, K$ and any $i \in I_k$, we do the substitution

$$\sum_{\substack{A \subset I, i \in A \\ |A|_\Sigma = a}} \pi(A \setminus \{i\}) = \sum_{\substack{B \subset I \setminus \{i\} \\ |B|_\Sigma = a - e_k}} \pi(B),$$

and thus we obtain for any $k = 1, \dots, K$,

$$\sum_{i \in I_k} \sum_{\substack{A \subset I, i \in A \\ |A|_\Sigma = a}} \pi(A \setminus \{i\}) = \sum_{\substack{B \subset I \\ |B|_\Sigma = a - e_k}} \sum_{i \in I_k \setminus (B \cap I_k)} \pi(B) = (n_k - a_k + 1)\pi(a - e_k). \quad (9)$$

This proves (6).

A.2 Recursion (7)

Let $k = 1, \dots, K$ and $a \in \mathcal{N} \setminus \{0\}$. By definition of $L_k(a)$, we have

$$L_k(a) = \mathbb{E} \left[\sum_{i \in I_k} \mathbf{X}_i \middle| |I(\mathbf{X})|_\Sigma = a \right] = \sum_{i \in I_k} \mathbb{E} [\mathbf{X}_i | |I(\mathbf{X})|_\Sigma = a].$$

It follows that

$$\pi(a)L_k(a) = \sum_{i \in I_k} \sum_{\substack{A \subset I, i \in A \\ |A|_\Sigma = a}} \pi(A)L_i(A), \quad (10)$$

and by (5), we obtain

$$\pi(a)L_k(a) = \sum_{i \in I_k} \sum_{\substack{A \subset I, i \in A \\ |A|_\Sigma = a}} \frac{\rho_i \pi(A \setminus \{i\}) + \rho_i \pi(A) + \sum_{j \in A \setminus \{i\}} \rho_j \pi(A \setminus \{j\}) L_i(A \setminus \{j\})}{\mu(A) - \sum_{j \in A} \rho_j}.$$

Using the regularity assumptions, this can be rewritten as

$$\begin{aligned} \left(h(a) - \sum_{l=1}^K a_l \varrho_l \right) \pi(a)L_k(a) &= \varrho_k \sum_{i \in I_k} \sum_{\substack{A \subset I, i \in A \\ |A|_\Sigma = a}} \pi(A \setminus \{i\}) + \varrho_k \sum_{i \in I_k} \sum_{\substack{A \subset I, i \in A \\ |A|_\Sigma = a}} \pi(A) \\ &\quad + \sum_{i \in I_k} \sum_{\substack{A \subset I, i \in A \\ |A|_\Sigma = a}} \sum_{\substack{j \in A \\ j \neq i}} \rho_j \pi(A \setminus \{j\}) L_i(A \setminus \{j\}). \end{aligned}$$

The first term is given by (9). The second term is simply

$$\varrho_k \sum_{i \in I_k} \sum_{\substack{A \subset I, i \in A \\ |A|_\Sigma = a}} \pi(A) = \varrho_k \sum_{\substack{A \subset I \\ |A|_\Sigma = a}} \sum_{i \in A \cap I_k} \pi(A) = a_k \varrho_k \pi(a).$$

Finally, for any $i \in I_k$, we have

$$\sum_{\substack{A \subset I, i \in A \\ |A|_\Sigma = a}} \sum_{\substack{j \in A \\ j \neq i}} \rho_j \pi(A \setminus \{j\}) L_i(A \setminus \{j\}) = \sum_{l=1}^K \varrho_l \sum_{\substack{j \in I_l \\ j \neq i}} \sum_{\substack{A \subset I, i, j \in A \\ |A|_\Sigma = a}} \pi(A \setminus \{j\}) L_i(A \setminus \{j\}).$$

Doing the same substitution as in (9), we have for any $l = 1, \dots, K$,

$$\begin{aligned} \sum_{\substack{j \in I_l \\ j \neq i}} \sum_{\substack{A \subset I, i, j \in A \\ |A|_\Sigma = a}} \pi(A \setminus \{j\}) L_i(A \setminus \{j\}) &= \sum_{\substack{B \subset I, i \in B \\ |B|_\Sigma = a - e_l}} \sum_{j \in I_l \setminus (B \cap I_l)} \pi(B) L_i(B), \\ &= (n_l - a_l + 1) \sum_{\substack{B \subset I, i \in B \\ |B|_\Sigma = a - e_l}} \pi(B) L_i(B). \end{aligned}$$

Hence the third term of the sum is equal to

$$\begin{aligned} \sum_{i \in I_k} \sum_{l=1}^K (n_l - a_l + 1) \varrho_l \sum_{\substack{B \subset I, i \in B \\ |B|_\Sigma = a - e_l}} \pi(B) L_i(B) &= \sum_{l=1}^K (n_l - a_l + 1) \varrho_l \sum_{i \in I_k} \sum_{\substack{B \subset I, i \in B \\ |B|_\Sigma = a - e_l}} \pi(B) L_i(B), \\ &= \sum_{l=1}^K (n_l - a_l + 1) \varrho_l \pi(a - e_l) L_k(a - e_l), \end{aligned}$$

where the second equality holds by (10). When we substitute the three terms by their expressions, we obtain (7).

B Proof of Theorem 5

We give the proof only for the case $K = 2$ for ease of notation; the other cases follow analogously. For now, we assume that for all $n \geq 1$, all servers have the same capacity $\mu_s^{(n)} = \xi^{(n)}$ for any $s \in S^{(n)}$.

Let $0 < \epsilon < 1$. We will show that there exists a sequence $(g_n : n \geq 1)$ such that $g_n = \omega(\log n)$ and for any $n \geq 1$,

$$\mathbb{P} \left\{ \exists A \subset I^{(n)} \text{ s.t. } \mathbf{M}^{(n)}(A) \leq (1 - \epsilon) \mu^{(n)}(A) \right\} \leq e^{-g_n}.$$

Let us first give the main ideas of the proof. As in [18], it is divided in three steps. We first provide a bound for $\mathbb{P} \left\{ \mathbf{M}^{(n)}(A) \leq (1 - \epsilon) \mu^{(n)}(A) \right\}$ for each $A \subset I^{(n)}$ for n large enough. Then, for each $a \in \mathcal{N}^{(n)} = \{0, 1, \dots, n\}^2$, we use the union bound to obtain a uniform bound over all sets $A \subset I^{(n)}$ with $|A|_{\Sigma^{(n)}} = a$. Finally, another use of the union bound over all $a \in \mathcal{N}^{(n)}$ gives us the result.

B.1 Partial bound

Let $n \geq 1$, $a \in \mathcal{N}^{(n)}$ and $A \subset I^{(n)}$ so that $|A|_{\Sigma^{(n)}} = a$. Recall that $\mu^{(n)}(A) = \mathbb{E}[\mathbf{M}^{(n)}(A)]$ with

$$\mathbf{M}^{(n)}(A) = \xi^{(n)} \sum_{s \in S^{(n)}} \mathbf{1}_{s \in \bigcup_{i \in A} \mathbf{S}_i^{(n)}}.$$

The variables $\mathbf{1}_{s \in \bigcup_{i \in A} \mathbf{S}_i^{(n)}}$ for $s \in S^{(n)}$ are Bernoulli distributed with parameter

$$p_a^{(n)} = 1 - \prod_{k=1}^K \left(1 - \frac{d_k^{(n)}}{m^{(n)}} \right)^{a_k}.$$

Dubbashi et al. proved in Theorem 10 of [9] that these random variables are negatively associated in the sense of Definition 3 of [9]. Their Theorem 14 then showed that the Chernoff-Hoeffding bounds (see for instance [15, 19]), which hold for independent random variables, can also be applied to these random variables. Hence we have

$$\mathbb{P} \left\{ \mathbf{M}^{(n)}(A) \leq (1 - \epsilon) \mu^{(n)}(A) \right\} \leq e^{-\frac{\epsilon^2}{2} m^{(n)} p_a^{(n)}}, \quad (11)$$

$$\mathbb{P} \left\{ \mathbf{M}^{(n)}(A) \leq (1 - \epsilon) \mu^{(n)}(A) \right\} \leq e^{-m^{(n)} H[(1 - \epsilon) p_a^{(n)} \| p_a^{(n)}]}, \quad (12)$$

where for any $p, q \in (0, 1)$, $H[p||q]$ is the KL divergence between two Bernoulli random variables with parameters p and q respectively, given by

$$H[p||q] = p \log \left(\frac{p}{q} \right) + (1-p) \log \left(\frac{1-p}{1-q} \right).$$

We also use the following lemmas which will be proved later in Appendix C:

Lemma 3. *Let $0 < \delta < \frac{1}{2}$. Consider a sequence $(g_n : n \geq 1)$ such that $g_n = o(d_1^{(n)})$ and $g_n = o(d_2^{(n)})$. For large enough n , we have*

$$p_a^{(n)} \geq \delta \frac{(a_1 + a_2)g_n}{n}, \quad \forall a = (a_1, a_2) \in \left\{ 0, 1, \dots, \left\lfloor \frac{n}{g_n} \right\rfloor \right\}^2.$$

Lemma 4. *There exists a positive constant δ such that*

$$H \left[(1-\epsilon)p_a^{(n)} || p_a^{(n)} \right] \geq -\delta + \epsilon \frac{a_1 d_1^{(n)} + a_2 d_2^{(n)}}{m^{(n)}}, \quad \forall n \geq 1, \quad \forall a \in \mathcal{N}^{(n)}.$$

Consider the sequence $(g_n : n \geq 1)$ given by

$$g_n = \left(\min \left(d_1^{(n)}, d_2^{(n)} \right) \log n \right)^{1/2}, \quad \forall n \geq 1.$$

Observe that $g_n = \omega(\log n)$, $g_n = o(d_1^{(n)})$ and $g_n = o(d_2^{(n)})$. Now let $n \geq 1$ and $a \in \mathcal{N}^{(n)}$. We distinguish two cases depending on the value of a .

B.1.1 Case 1: $0 \leq a_1 \leq \frac{n}{g_n}$ and $0 \leq a_2 \leq \frac{n}{g_n}$

By Lemma 3, there is a positive constant δ_1 such that, for large enough n ,

$$p_a^{(n)} \geq \delta_1 \frac{(a_1 + a_2)g_n}{n}.$$

Using (11), we deduce that

$$\mathbb{P} \left\{ \mathbf{M}^{(n)}(A) \leq (1-\epsilon)\mu^{(n)}(A) \right\} \leq e^{-\frac{\epsilon^2}{2} \delta_1 b (a_1 + a_2) g_n}$$

for any $A \subset I^{(n)}$ such that $|A|_{\Sigma^{(n)}} = a$. The union bound yields

$$\begin{aligned} & \mathbb{P} \left\{ \exists A \subset I^{(n)} \text{ s.t. } |A|_{\Sigma^{(n)}} = a \text{ and } \mathbf{M}^{(n)}(A) \leq (1-\epsilon)\mu^{(n)}(A) \right\} \\ & \leq e^{-\frac{\epsilon^2}{2} \delta_1 b (a_1 + a_2) g_n} \binom{n}{a_1} \binom{n}{a_2}, \\ & \leq e^{-\frac{\epsilon^2}{2} \delta_1 b (a_1 + a_2) g_n} n^{a_1} n^{a_2}, \\ & \leq e^{a_1 g_n \left(-\frac{\epsilon^2}{2} \delta_1 b + \frac{\log n}{g_n} \right)} e^{a_2 g_n \left(-\frac{\epsilon^2}{2} \delta_1 b + \frac{\log n}{g_n} \right)}. \end{aligned}$$

Since $g_n = \omega(\log n)$, we obtain for large enough n

$$\mathbb{P} \left\{ \exists A \subset I^{(n)} \text{ s.t. } |A|_{\Sigma^{(n)}} = a \text{ and } \mathbf{M}^{(n)}(A) \leq (1-\epsilon)\mu^{(n)}(A) \right\} \leq e^{-\delta_2 (a_1 + a_2) g_n}$$

with $\delta_2 = \frac{\epsilon^2}{4} \delta_1 b > 0$.

B.1.2 Case 2: $a_1 > \frac{n}{g_n}$ or $a_2 > \frac{n}{g_n}$

Combining Lemma 4 with (12), we deduce that there is a positive constant δ_3 such that

$$\mathbb{P} \left\{ \mathbf{M}^{(n)}(A) \leq (1 - \epsilon)\mu^{(n)}(A) \right\} \leq e^{\delta_3 m^{(n)} - \epsilon(a_1 d_1^{(n)} + a_2 d_2^{(n)})}$$

for any $A \subset I^{(n)}$ such that $|A|_{\Sigma^{(n)}} = a$. Since $m^{(n)} = \lceil bn \rceil$ and $g_n = o\left(d_1^{(n)}\right)$, we have $\delta_3 m^{(n)} \leq \frac{\epsilon}{2} \frac{nd_1^{(n)}}{g_n}$ when n is large enough. If $a_1 > \frac{n}{g_n}$, we also have that $\frac{\epsilon}{2} \frac{nd_1^{(n)}}{g_n} \leq \frac{\epsilon}{2} a_1 d_1^{(n)}$ so that

$$\delta_3 m^{(n)} - \epsilon \left(a_1 d_1^{(n)} + a_2 d_2^{(n)} \right) \leq -\frac{\epsilon}{2} a_1 d_1^{(n)} - \epsilon a_2 d_2^{(n)} \leq -\frac{\epsilon}{2} \left(a_1 d_1^{(n)} + a_2 d_2^{(n)} \right)$$

for large enough n . The same argument holds by inverting a_1 and a_2 when $a_2 > \frac{n}{g_n}$, so we conclude that there is a positive constant δ_4 such that for large enough n , we have

$$\mathbb{P} \left\{ \mathbf{M}^{(n)}(A) \leq (1 - \epsilon)\mu^{(n)}(A) \right\} \leq e^{-\delta_4 (a_1 d_1^{(n)} + a_2 d_2^{(n)})}$$

for any $A \subset I^{(n)}$ such that $|A|_{\Sigma^{(n)}} = a$. The union bound yields

$$\begin{aligned} & \mathbb{P} \left\{ \exists A \subset I^{(n)} \text{ s.t. } |A|_{\Sigma^{(n)}} = a \text{ and } \mathbf{M}^{(n)}(A) \leq (1 - \epsilon)\mu^{(n)}(A) \right\} \\ & \leq e^{-\delta_4 (a_1 d_1^{(n)} + a_2 d_2^{(n)})} \binom{n}{a_1} \binom{n}{a_2}, \\ & \leq e^{-\delta_4 (a_1 d_1^{(n)} + a_2 d_2^{(n)})} n^{a_1} n^{a_2}, \\ & \leq e^{a_1 d_1^{(n)} (-\delta_4 + \log n/d_1^{(n)})} e^{a_2 d_2^{(n)} (-\delta_4 + \log n/d_2^{(n)})}. \end{aligned}$$

Since $d_1^{(n)} = \omega(\log n)$ and $d_2^{(n)} = \omega(\log n)$, for large enough n , we have

$$\mathbb{P} \left\{ \exists A \subset I^{(n)} \text{ s.t. } |A|_{\Sigma^{(n)}} = a \text{ and } \mathbf{M}^{(n)}(A) \leq (1 - \epsilon)\mu^{(n)}(A) \right\} \leq e^{-\delta_5 a_1 d_1^{(n)}} e^{-\delta_5 a_2 d_2^{(n)}} = e^{-\delta_5 (a_1 d_1^{(n)} + a_2 d_2^{(n)})}$$

for some positive constant $\delta_5 < \delta_4$.

B.2 Conclusion

Combining cases B.1.1 and B.1.2, we deduce that there exists a positive constant δ_6 such that

$$\mathbb{P} \left\{ \exists A \subset I^{(n)} \text{ s.t. } |A|_{\Sigma^{(n)}} = a \text{ and } \mathbf{M}^{(n)}(A) \leq (1 - \epsilon)\mu^{(n)}(A) \right\} \leq e^{-\delta_6 g_n}, \quad \forall a \in \mathcal{N}^{(n)}$$

when n is large enough. Using the union bound again, we obtain

$$\mathbb{P} \left\{ \exists A \subset I^{(n)} \text{ s.t. } \mathbf{M}^{(n)}(A) \leq (1 - \epsilon)\mu^{(n)}(A) \right\} \leq n^2 e^{-\delta_6 g_n} = e^{2 \log n} e^{-\delta_6 g_n} = e^{-g_n \left(\delta_6 - \frac{2 \log n}{g_n} \right)}.$$

Since $g_n = \omega(\log n)$, we conclude that for a constant $\delta_7 < \delta_6$, we have for large enough n

$$\mathbb{P} \left\{ \exists A \subset I^{(n)} \text{ s.t. } \mathbf{M}^{(n)}(A) \leq (1 - \epsilon)\mu^{(n)}(A) \right\} \leq e^{-\delta_7 g_n}.$$

Finally, when servers are in groups as in Assumption 1, we can break down $\mathbf{M}^{(n)}$ into a sum of random rank functions, one for each groups. The result follows by showing the concentration in each group as above, and then using the union bound again.

C Proof of the lemmas for Theorem 5

Lemma 3. Let $0 < \delta < \frac{1}{2}$. Consider a sequence $(g_n : n \geq 1)$ such that $g_n = o(d_1^{(n)})$ and $g_n = o(d_2^{(n)})$. For large enough n , we have

$$p_a^{(n)} \geq \delta \frac{(a_1 + a_2)g_n}{n}, \quad \forall a = (a_1, a_2) \in \left\{0, 1, \dots, \left\lfloor \frac{n}{g_n} \right\rfloor\right\}^2.$$

Proof. Consider the sequence $(f_n : n \geq 1)$ of functions defined on \mathbb{R}_+^2 by

$$f_n(t_1, t_2) = 1 - \left(1 - \frac{d_1^{(n)}}{bn}\right)^{t_1} \left(1 - \frac{d_2^{(n)}}{bn}\right)^{t_2}, \quad \forall (t_1, t_2) \in \mathbb{R}_+^2.$$

We have

$$f_n\left(\frac{2n}{g_n}, 0\right) = 1 - \left[\left(1 - \frac{d_1^{(n)}}{bn}\right)^{\frac{n}{g_n}}\right]^2 \xrightarrow{n \rightarrow \infty} 1 \quad \text{and} \quad f_n\left(0, \frac{2n}{g_n}\right) = 1 - \left[\left(1 - \frac{d_2^{(n)}}{bn}\right)^{\frac{n}{g_n}}\right]^2 \xrightarrow{n \rightarrow \infty} 1.$$

Thus, there is $n_\delta \geq 1$ so that $f_n\left(\frac{2n}{g_n}, 0\right) \geq 2\delta$ and $f_n\left(0, \frac{2n}{g_n}\right) \geq 2\delta$ for all $n \geq n_\delta$.

Then, for any $n \geq n_\delta$ and any $t_1, t_2 \leq \frac{n}{g_n}$, we have

$$\begin{aligned} f_n(t_1, t_2) &= f_n\left(\frac{t_1}{t_1 + t_2}(t_1 + t_2), 0\right) + \left(1 - \frac{t_1}{t_1 + t_2}\right) f_n(0, t_1 + t_2), \\ &\geq \frac{t_1}{t_1 + t_2} f_n(t_1 + t_2, 0) + \frac{t_2}{t_1 + t_2} f_n(0, t_1 + t_2), \\ &\geq \frac{t_1}{t_1 + t_2} \frac{t_1 + t_2}{\frac{2n}{g_n}} f_n\left(\frac{2n}{g_n}, 0\right) + \frac{t_2}{t_1 + t_2} \frac{t_1 + t_2}{\frac{2n}{g_n}} f_n\left(0, \frac{2n}{g_n}\right), \\ &\geq 2\delta \frac{t_1 g_n}{2n} + 2\delta \frac{t_2 g_n}{2n}, \\ &= \delta \frac{(t_1 + t_2)g_n}{n}, \end{aligned}$$

where the first two inequalities hold by concavity of f_n . □

Lemma 4. There exists a positive constant δ such that

$$H\left[(1 - \epsilon)p_a^{(n)} \parallel p_a^{(n)}\right] \geq -\delta + \epsilon \frac{a_1 d_1^{(n)} + a_2 d_2^{(n)}}{m^{(n)}}, \quad \forall n \geq 1, \quad \forall a \in \mathcal{N}^{(n)}.$$

Proof. By definition of H ,

$$\begin{aligned} H\left[(1 - \epsilon)p_a^{(n)} \parallel p_a^{(n)}\right] &= (1 - \epsilon)p_a^{(n)} \log(1 - \epsilon) \\ &\quad + \left(1 - (1 - \epsilon)p_a^{(n)}\right) \log\left(1 - (1 - \epsilon)p_a^{(n)}\right) \\ &\quad - \left(1 - (1 - \epsilon)p_a^{(n)}\right) \log\left(1 - p_a^{(n)}\right). \end{aligned}$$

The first and the second terms are greater than $(1 - \epsilon) \log(1 - \epsilon)$ and $\log(\epsilon)$ respectively. With $\delta = (1 - \epsilon) \log\left(\frac{1}{1 - \epsilon}\right) + \log\left(\frac{1}{\epsilon}\right) > 0$, we obtain

$$H\left[(1 - \epsilon)p_a^{(n)} \parallel p_a^{(n)}\right] \geq -\delta - \left(1 - (1 - \epsilon)p_a^{(n)}\right) \log\left(1 - p_a^{(n)}\right) \geq -\delta - \epsilon \log\left(1 - p_a^{(n)}\right).$$

Finally, observe that

$$\log \left(1 - p_a^{(n)} \right) = a_1 \log \left(1 - \frac{d_1^{(n)}}{m^{(n)}} \right) + a_2 \log \left(1 - \frac{d_2^{(n)}}{m^{(n)}} \right) \leq -\frac{a_1 d_1^{(n)} + a_2 d_2^{(n)}}{m^{(n)}},$$

where in the inequality we used the fact that $\log \left(1 - \frac{d_k^{(n)}}{m^{(n)}} \right) \leq -\frac{d_k^{(n)}}{m^{(n)}}$ for $k = 1, 2$. Hence, we obtain the expected result. \square

References

- [1] T. Bonald and C. Comte. The multi-source model for dimensioning data networks. *Computer Networks*, 2016.
- [2] T. Bonald and C. Comte. Balanced fair resource sharing in computer clusters. *CoRR*, abs/1604.06763v2, 2017.
- [3] T. Bonald and A. Proutière. Insensitive bandwidth sharing in data networks. *Queueing Syst.*, 44(1):69–100, 2003.
- [4] T. Bonald and A. Proutière. On performance bounds for balanced fairness. *Perform. Eval.*, 55(1-2):25–50, Jan. 2004.
- [5] T. Bonald and A. Proutière. On stochastic bounds for monotonic processor sharing networks. *Queueing Systems*, 47(1):81–106, 2004.
- [6] T. Bonald and J. Virtamo. Calculating the flow level performance of balanced fairness in tree networks. *Performance Evaluation*, 2004.
- [7] T. Bonald and J. Virtamo. A recursive formula for multirate systems with elastic traffic. *IEEE Communications Letters*, 9(8):753–755, 2005.
- [8] G. de Veciana, T.-J. Lee, and T. Konstantopoulos. Stability and performance analysis of networks supporting elastic services. *IEEE/ACM Transactions on Networking*, 9(1):2–14, Feb 2001.
- [9] D. Dubhashi, V. Priebe, and D. Ranjan. Negative dependence through the FKG inequality. *BRICS Report Series*, 3(27), 1996.
- [10] S. Fujishige. *Submodular functions and optimization*, volume 58. Elsevier, 2005.
- [11] K. Gardner, S. Zbarsky, M. Harchol-Balter, and A. Scheller-Wolf. The power of d choices for redundancy. *SIGMETRICS Perform. Eval. Rev.*, 44(1):409–410, June 2016.
- [12] V. Joseph and G. de Veciana. Stochastic networks with multipath flow control: Impact of resource pools on flow-level performance and network congestion. In *Proceedings of the ACM Sigmetrics*, pages 61–72, 2011.
- [13] F. Kelly, L. Massoulié, and N. Walton. Resource pooling in congested networks: proportional fairness and product form. *Queueing Systems*, 63(1-4):165–194, 2009.
- [14] L. Massoulié and J. Roberts. Bandwidth sharing and admission control for elastic traffic. *Telecommunication Systems*, 15(1-2):185–201, 2000.
- [15] R. Motwani and P. Raghavan. *Randomized Algorithms*. Cambridge University Press, New York, NY, USA, 1995.

- [16] R. Serfozo. *Introduction to Stochastic Networks*. Stochastic Modelling and Applied Probability. Springer New York, 1999.
- [17] V. Shah and G. de Veciana. High-performance centralized content delivery infrastructure: Models and asymptotics. *IEEE/ACM Transactions on Networking*, 23(5):1674–1687, Oct 2015.
- [18] V. Shah and G. de Veciana. Impact of fairness and heterogeneity on delays in large-scale centralized content delivery systems. *Queueing Systems*, 83(3):361–397, 2016.
- [19] A. Sinclair. Cs271 randomness & computation, lecture 13. <https://people.eecs.berkeley.edu/~sinclair/cs271/n13.pdf>, 2011.