



HAL
open science

Dealing with Complexity through Advanced Control Techniques

P. Bidaud, L. Burlion, H. de Plinval, T. Loquen, J. Marzat, C. Pralet

► **To cite this version:**

P. Bidaud, L. Burlion, H. de Plinval, T. Loquen, J. Marzat, et al.. Dealing with Complexity through Advanced Control Techniques. Aerospace Lab, 2017, 12, p. 1-18. 10.12762/2016.AL12-13. hal-01512955

HAL Id: hal-01512955

<https://hal.science/hal-01512955>

Submitted on 24 Apr 2017

HAL is a multi-disciplinary open access archive for the deposit and dissemination of scientific research documents, whether they are published or not. The documents may come from teaching and research institutions in France or abroad, or from public or private research centers.

L'archive ouverte pluridisciplinaire **HAL**, est destinée au dépôt et à la diffusion de documents scientifiques de niveau recherche, publiés ou non, émanant des établissements d'enseignement et de recherche français ou étrangers, des laboratoires publics ou privés.

P. Bidaud, L. Burlion,
H. De Plinval, T. Loquen,
J. Marzat, C. Pralet
(ONERA)

E-mail: philippe.bidaud@onera.fr

DOI : 10.12762/2016.AL12-13

Dealing with Complexity through Advanced Control Techniques

The control of complex dynamic systems, both in their behavior and in their mission, goes through the implementation of multi-loop control architectures based on information about the system internal state and from the environment, as well as on the mission plan state. This results in systems that are becoming increasingly autonomous, for which requirements in terms of safety and reliability, as well as expected performance, are increasingly high. Research works developed at ONERA in the field of control for autonomous systems cover all levels of the control architectures, which are basically structured with respect to temporal aspects, as well as the level of abstraction that they entail for the system dynamic. We will consider them in this paper by increasing level. We will discuss the advances achieved recently in the robust control techniques of uncertain dynamic systems generally implemented at the lower control level and we will discuss their extensions to consider input and output constraints, as well as the hybrid nature of most of the systems considered. To design "task" level control primitives that take place just above the previous control loops, we will introduce sensor-based robust and non-linear control techniques. These are based on information on the environment extracted from exteroceptive sensors, to adapt system behavior to uncertainties and perturbations. Multi-sensor and/or multi-objective controls will be discussed in this particular context. We will also present several recent results in the field of trajectory tracking based on visual navigation techniques in complex environments, which combine objectives and constraints within the same control architecture. We will discuss how model predictive control (MPC) techniques and advanced optimization techniques can be used for solving the resulting control problems. In addition, we will discuss several ongoing developments of these methods by exploiting distributed model predictive control techniques (DMPC) and predictive control of hybrid systems. Finally, integration with the control architectures at the upper level of reactive, predictive and distributed planning capabilities will be proposed to accommodate time constraints and uncertainties in decision.

Introduction

The issues underlying a large number of research activities in the departments for Information Processing and Systems at ONERA deal with control of systems with complex dynamic behavior, such as aircraft, spacecraft, robotics systems etc., and this in the presence of uncertainties and various constraints related to physical systems and the environments in which they evolve. Consideration of these phenomena is of major importance in the control of real systems.

In order to cope with the increasing complexity of technological systems in general and with the requirements in terms of performance and adaptability, for which there are increasing demands, a trend that can be observed since over two decades ago is to abstract the complexity of systems by integrating the control means responsible for the system behavior and their adaptation to the various "tasks" defined at a high-level; tasks which may require coordination between multiple

entities. In the implementation of these systems, which thereby become "robotic systems", safety and security issues are and remain of major importance.

The various components of the control software are designed to be integrated into an overall architecture whose structure generally separates different levels that may or may not be implemented, depending on the degree of "autonomy" to be achieved.

- The lower level is in charge of multi-loop actuator servo modules, generating control inputs and perception modules that are often used in sensor-based control loops. This level allows elementary actions of the systems to be controlled and allows perception information on the environment, as well as on the system state, to be accessed.
- The executive level operates the execution control of elementary functions (*i.e.*, the tasks defined through low-level components carried out by the entities involved, their organization and their interactions defined as a plan) and the evaluation of a number of functional and temporal properties to be fulfilled at runtime.
- The decision-making level is in charge of scheduling algorithms (*i.e.*, creation and supervision plans). It controls how the robot will bind tasks to achieve each objective of its mission. Higher-level decision-making mechanisms, known traditionally as deliberative mechanisms, are the central mechanisms in these architectures [1].

Notice that, beyond these control methods and algorithms, ONERA jointly carries out important work on formal and semi-formal specification and verification software of the underpinned critical software architectures, taking into account their hardware implementation [2].

One of the major limitations in these control structures, which combine reactive and deliberative mechanisms around an execution controller, is that complex behaviors are not anticipated, nor are the constraints on these behaviors. Also, we frequently seek to mix the principles of predictive control and stochastic optimization, aiming towards "goal-driven control architectures". This concern, as we shall see, is strongly present in the current research developments at ONERA and is expected to increase in the future.



Figure 1 – Example of a robotics system composed of several autonomous entities deployed to perform high-level tasks, such as the surveillance of an area

In this paper, we review and discuss the potential offered by current and future developments carried out at ONERA in the field of control engineering for the autonomy and reliability of complex systems. On this occasion, we will introduce, in the various sections concerned, several ONERA-toolboxes (*SMAC*, *COPERNIC*, *InCELL*, etc.).

We will start with robust control tools and their ongoing enhancements to consider hybrid systems and sub-system constraints (all physical systems have inputs and outputs, which are limited in size due to safety or physical constraints). Robust control laws are designed to achieve the desired behavior of the controlled system and maintain this behavior when faced with disturbances and hazards that affect the system during operation. Achieving a high performance and ensuring the safe behavior of complex dynamic systems, despite the parametric uncertainties and/or failures, has been for several years a central theme in control engineering activities at ONERA. These issues have led to the development of a consistent set of estimation methods for robust control synthesis, analysis and validation of control laws, in particular to limit the costs of the certification process. They provide a unified framework for control from modeling to time-frequency analysis and synthesis of robust control laws. We will discuss more specifically here the extensions of this work, first to consider input/output constraints through model predictive control techniques and anti-windup compensation and then to exploit hybrid control techniques.

At a higher level of control, exteroceptive-sensor based control loops enable "task-oriented" functions to be set by controlling a system, not in the system configuration space, but rather in the "sensor measurement" space in the form of a local relationship between the system and its environment. These output feedback control loops are called "sensor-based control". They permit the need for an accurate model of the system and errors to be avoided by setting control loops based on the information obtained by the sensors (vision sensors, force sensors, proximetric sensors, etc.). The use of visual feedback to perform closed-loop control on geometric primitives extracted from features observed by a camera embedded on aerial robots have been specifically developed at ONERA to deal with complex behaviors. We have developed methods of analysis and synthesis of "advanced" 2D/2 visual feedback, taking into account all of the constraints (visibility, saturation of actuators, 3D constraints while driving, etc.), uncertainties related to the calibration of cameras and the non-modeled dynamic environment like the aerologic perturbations, for example. We will discuss how these techniques enable the problem of "hybrid tasks" to be solved rigorously, combining heterogeneous sensor data in the low-level servo controller.

In addition, we are also developing vision-based state estimation and trajectory control approaches (monocular-, stereo-, and RGB/D camera-based) that exploit the principles of SLAM (Simultaneous Localization and Mapping). We will not discuss SLAM techniques in this paper and the reader can refer to several recent references from ONERA in this field [3] [4]. However, we will propose a generalization of navigation techniques with steady and dynamic obstacle avoidance, as well as cooperative guidance based on predictive models of the behavior of the system. We will, more particularly, put into perspective the potential of Distributed Model Predictive Control (DMPC) methods and hybrid methods for dealing with continuous and discrete variables.

At the higher level, to achieve a complex mission, action/perception tasks are then structured into a plan generated by algorithms (planners), which relies on both a representation of the dynamic properties of the system and of the tasks, as well as on an integrative level of

information to obtain a certain representation of the world in which the system operates. The mission management is a high-level control, which determines, depending on the operating environment and on the overall goal, the elementary tasks to be carried out by the perception and action entities. The methods studied at ONERA in this field rely on formal models of the considered system (or subsystem), a formal model of the possible changes in the environment in which the system operates, and a formal model of the goals to be achieved. We thus use general mathematical modeling frameworks, such as Constraint Satisfaction Problems (CSP), discrete event systems (Petri Nets, Temporal Networks, etc.) or Markov Decision Processes (MDP), to make decisions based on uncertain data. We will discuss several directions that we are exploring to increase the system autonomy at the planning level and to make planners more reactive and proactive, such as hierarchical deliberations, distributed planning and the use of stochastic optimization and predictive models.

The following sections consider these ongoing developments, or those considered on these different control levels, from the point of view that we have of the evolution of aerospace and defense/security systems autonomy.

Achieving robust constrained control of dynamical systems

The development of robust control techniques for sequenced and multi-objectives systems is an important area of research at ONERA. Robustness to uncertainties for stationary systems (LTI) has been the purpose of many developments based on the LFT formalism and a large set of appropriate tools for the construction of this type of model and for robustness analysis are today available in the SMAC toolbox w3.onera.fr/smac/.

Once an LFT model of the closed loop is available, validation of control laws may be considered by various analytical techniques for robust stability and performance, using analysis techniques [5] particularly suitable for LTI systems. Current research at ONERA in this area is aimed at:

- better controlling the trade-off complexity/precision [6, 7, 8],
- dealing with higher order systems (flexible modes, finer modeling calculators) [9],
- controlling precision and reducing conservatism (less pessimistic margins) [10].

Stationary uncertainties represent only a relatively small part of all of the uncertainties encountered in practice. Most effects vary over time and systems being studied become unsteady. Consequently, analysis techniques are no longer applicable and the control law validation issue becomes numerically much more complex. Two large families of techniques exist to address this kind of uncertainty. The first one, inspired by analysis techniques, is based on the optimization of matrix "scaling" that are constant (for LTV uncertainties) and dynamic (for LTI uncertainties) in the frequency domain [11, 12]. This approach relies on special techniques based on the IQC formalism (Integral quadratic constraints). The second one makes use of dependent Lyapunov parameters. For the cost of higher computational complexity, these techniques can be considered to be bounds on speed parameter variation. The specific contribution that we made to these techniques is the reduction of their numerical complexity to make them competitive over intensive simulations [13].

The robustness analysis in the presence of nonlinearities such as input/output constraints remains an open research area, which

motivates various extensions for tools developed as part of the analysis of robustness LTI/LTV. Inputs and outputs constraints arise in most control engineering applications. This topic is crucial since ignoring these constraints can lead to a dramatic loss of stability and performance. It is therefore not surprising that the topics of model predictive control [14, 15] and anti-windup compensation [16, 17] have been intensively studied for many years.

Model predictive control

Model Predictive Control (MPC) is a branch of control design techniques that take advantage of the knowledge of an explicit model to predict the future response of the plant over a sufficiently large time interval (i.e., the selected time horizon exceeds the expected transient time of the control system). Using such a prediction, the control problems are then formulated as optimizing on line the system behavior under its input and output constraints. Although this technique is very popular and effective when the model is linear, low dimensional and perfectly known, it is sometimes criticized because of its lack of intuition in terms of tuning, thus designing a controller "from scratch" by an "obscure" optimization and because of its computational load or conservatism when the model is uncertain or even nonlinear. Recent research has already started addressing such issues [18, 19, 20] and model predictive control deserves further consideration in aerospace control where the models are often uncertain and high dimensional. We will consider the use of MPC techniques in Section 5. Another limitation in use of the MPC is the computational cost compared to anti-windup techniques, which are discussed below.

Anti-windup compensation

Anti-windup is a very popular technique that is currently mainly used to deal with control saturation. In anti-windup compensation, a nominal controller that does not explicitly take into account controller saturations is first designed using the best control design tools. Then, after that, an anti-windup compensator is combined with this controller to both ensure the stability (at least in some region near the origin when the open loop system is unstable) and to avoid performance degradation when saturations are active. It is worth noting that such a technique is appealing because the desired response of the nominal control law is recovered when the saturation limits are not exceeded.

Nominal control law design

As a main drawback for practitioners, the nominal control design (i.e., the unconstrained control law design) specifications of many aerospace applications require either a large amount of tuning or mastering advanced control design tools.

Most of the time, the nominal control law must be designed using powerful control design techniques that account for uncertain and high dimensional linear models. Another possibility in which we are deeply involved is the use of specialized non-smooth optimization techniques dedicated to control system design [21, 22, 23].

Input constraints and anti-windup

Among many possibilities that are summarized in [16, 17], the so-called MRAW (Model Recovery Anti-Windup) is often preferred because it can be applied with any (possibly nonlinear) nominal

controller [24, 25]. First, the nominal control is designed; then it is merged with a global controller that is able to globally (or at least locally) stabilize the plant, despite the control saturations. This anti-windup solution is illustrated in Figure 2.

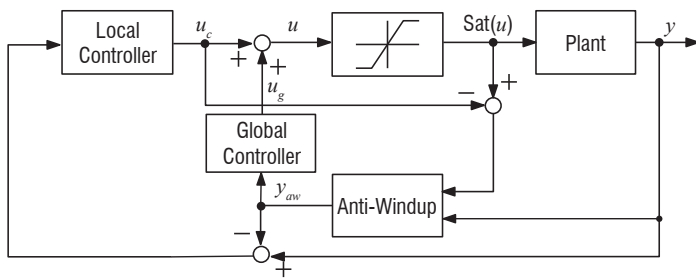

Figure 2 – Model recovery anti-windup architecture for merging the local and global controllers.

Basically, anti-windup block design involves solving some LMIs (Linear Matrix inequalities) [16, 17]. However, some papers have shown how this problem should be addressed, by using other powerful non-smooth optimization techniques [26, 27]. Recent efforts have also been concentrated on MRAW design when the plant model is uncertain (see e.g., [28, 29]).

Output constraints and anti-windup

Among several approaches summarized in [30, 31], taking output constraints into account may consist in modifying a nominal controller whenever the constraints are about to be violated. Following this line, the Output to Input Saturation Transformation (OIST) approach was recently proposed [32] to replace an output constraint by a state-dependent control saturation. Such an approach is attractive because the output constrained problem is then recast into an input constrained problem, which may in particular lead to considering the aforementioned MRAW loop design.

This OIST technique was originally proposed for the state feedback control of nonlinear systems when a minimum phase output is constrained. Guarantees on the global asymptotic stability of the closed-loop in the presence of the obtained control saturation have also been studied for a large class of linear systems [33]. The OIST technique has then been further developed in the output feedback case [34]: an interval observer was used in combination with the OIST technique, to ensure that the constraint is still not violated; this new technique was therefore called OISTeR, which means OIST extended with robustness properties (with respect to the uncertain initial state). Figure 3 illustrates this novel framework.

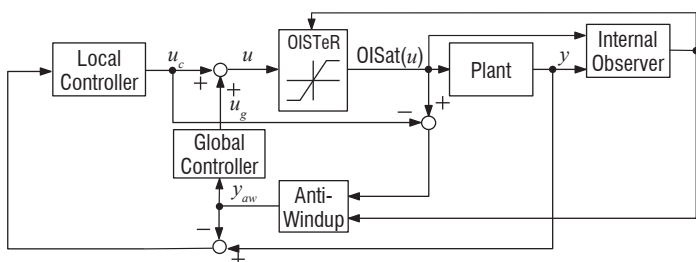

Figure 3 – Model recovery anti-windup architecture associated with OISTeR.

Anti-windup techniques can now be applied to control design problems under both input and output constraints; the major interest of using the anti-windup framework is to apply some very sophisticated robust control design techniques when we are far from the constraints. Anti-windup is now mature enough to take into account input constraints. Then, a novel Output to Input Saturation technique has recently been developed, in order to recast an output-constrained control problem into an input-constrained control problem. Such an innovative technique has been already successfully assessed for several aerospace applications, including:

- the longitudinal control of a large scale long range flexible aircraft under a wing root bending moment constraint [35],
- the problem of satellite attitude reference trajectory tracking under some angular velocity limitations [36],
- the atmospheric flight control of a flexible launch vehicle under an angle of attack constraint [37, 38],
- the obstacle avoidance of a UAV [39].

Future research may extend this technique by considering modeling uncertainties. Moreover, current research is aimed at studying local stability results when the constrained outputs are non-minimum-phase.

Hybrid system control

Aircraft flight control systems implement a gain-scheduled controller switching strategy for linear parameter-varying systems. However, the switching action tends to generate non-smooth control input, which may cause undesired behavior and even instability. For other systems, such as robotics systems, breaking down the overall control task into several simpler ones can simplify the design process; here also, the instantaneous changes in the system dynamics and the rules of the discrete switching logic may result in unexpected system behaviors, or even catastrophic failures, making the analysis and safety verification of the overall system significantly more challenging. Hence, to guarantee safety and to meet the specific performance requirements, these couplings should be properly incorporated into the mathematical representation of the system, necessitating the use of a hybrid system model incorporating discrete and continuous variables. Many of the aeronautic and aerospace vehicles or robotics systems that we are considering show continuous and discrete dynamics interactions and can be seen as hybrid systems. This is the case for:

- self/event-triggered systems, including sample and hold control, quantized control systems, etc. [40, 41, 42],
- switching systems, including systems described by a family of differential equations, combination of local and global controllers, systems with explicit discrete states (or logical modes), hybrid automata, etc. [43, 44],
- "hybridized" systems, including nonlinear models seen as sets of simpler equations, reset controllers, etc. [45, 46].

Hybrid control system methods provide a unique framework to investigate systems with such dynamical behavior. Let us briefly recall that, from control theory point of view, the term hybrid refers to combinations or compositions of continuous and discrete parts and a hybrid dynamical system (or simply a hybrid system) combines behaviors that are typical of continuous-time dynamical systems with behaviors that are typical of discrete-time dynamical systems

(see Figure 4). In this framework, a system can be represented in the following way:

$$\begin{cases} x \in C & \dot{x} = f(x) \\ x \in D & x^+ = g(x) \end{cases}$$

This representation suggests that the state of the hybrid system, represented by x , can change according to a differential equation $\dot{x} = f(x)$ while in the set C , and it can change according to a differential equation $x^+ = g(x)$ while in the set D . The notation \dot{x} represents the time derivative of the state x , while x^+ represents the value of the state after an instantaneous change.

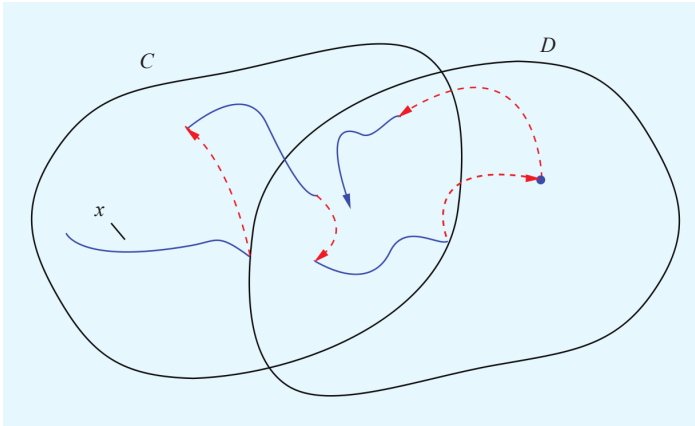

Figure 4 – Hybrid behavior: succession of continuous-time trajectories (blue line) in the set C and discrete transition (red dashed line) in the set D

The modeling and design of the control solutions for hybrid dynamical systems have been widely studied over these last years [44, 47]. They can be used to capture and better understand the behavior of control change between free and constrained movements of a robotic arm (or an autonomous robot moving in a constrained environment) where the switching between sensor-based control laws is stochastic and provided by finite state automata. Moreover, in a context of aeronautic applications, it can be useful to transform, in a more suitable framework, detailed models that include equations, lookup tables and switching logics that are excellent for simulation but not for analysis or controller design. The dynamical behavior of systems like air-

craft subject to transitions between different phases of flight (with a gain-scheduled/linear parameter-varying control law and supervisory switching control). In practice, such control laws are often in block diagram form, where time-continuous processes and logical modes are nested and cannot be manually identified. A problem of interest is the development of tools that, based on such block schemes, generate automatically structured formal code like Lustre and Prelude high-level programming languages for real-time embedded applications, allowing the modeling of the overall systems as a hybrid automata: sets of differential equations and switching rules among this model.

Regarding the analysis of hybrid dynamical systems, switching among simpler dynamical systems or integrator resets has been used successfully in practice for many decades. Recent efforts concentrate on guaranteeing properties such as reachability and stability. Reachability concerns more specifically discrete automata or Petri net states and must assess, among other things, the absence of Zeno execution (infinity of instantaneous transition in a finite delay which is unrealistic for real systems) [48, 44]. The stability of the continuous states of a hybrid system is often carried out using multiple or piecewise Lyapunov functions (see Figure 6) [49, 50]. Such functions can be seen as particular energy functions depending on continuous states of the system. By proving the monotonical decrease of this function along state trajectories (continuous behavior and instantaneous transition), the asymptotic stability of the hybrid system can be assessed.

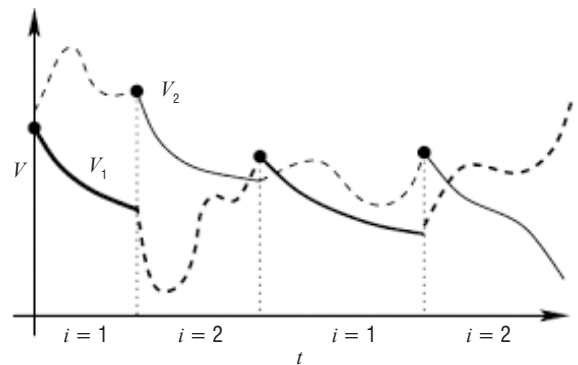

Figure 6 – Multiple Lyapunov functions: a function V_i is used in Logical Mode i

Stability of sets can be considered for systems that include timers, counters, and other discrete states that do not converge. By exploiting such approaches, a major issue for aerospace control engineering is the stability analysis of hybrid dynamical systems in the presence of uncertain inputs and uncertain parameters (see Figure 7).

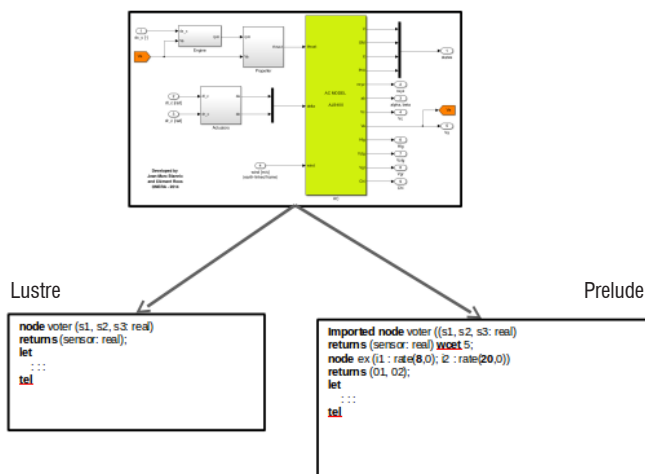

Figure 5 – From Block schemes to structured language

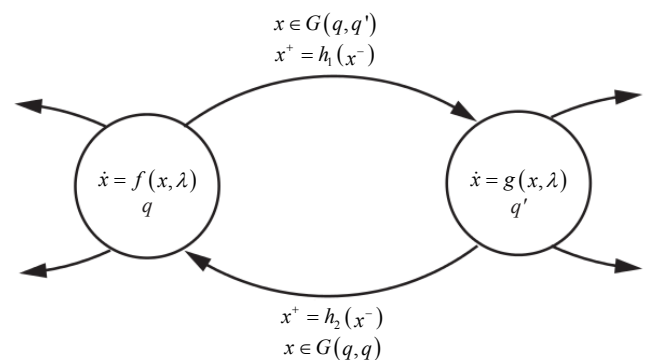

Figure 7 – Hybrid automata with uncertain time-continuous dynamics: Stochastic Parameter λ

The practical stability of such system can be studied with Monte Carlo and Quasi-Monte Carlo methods. Such time consuming sampling methods might be improved by exploiting Polynomial Chaos expansions to deal with uncertainties and properties of Multiple Lyapunov functions.

Hybrid control framework also opens a large field of investigation in terms of synthesis, both for controllers and for the corresponding switching rules. Making hybrid time-continuous controllers to improve performance is another form of investigation. This includes, among others, reset systems where a reset law enriches a nominal controller to improve controller state decrease or L_2 gain [51, 52]. By resetting, under conditions and when necessary, all or part of the controller states, such approaches enable performance improvements without modifying the nominal structure and behavior of the nominal controller [53, 54].

Moreover, the fact that a hybrid dynamical system framework enables the widest representation of systems opens up promising perspectives for Model Predictive Control (MPC). Indeed, such control methods are based on the explicit use of a model of the process (see Section 2) and the richer the model is, the more efficient the control law is (beyond the efficiency of the chosen optimization algorithm, terminal cost, stage cost and prediction horizon). A number of controller design techniques have been proposed recently based on representations relying, in particular, on piecewise-affine (PWA) or mixed logical dynamical (MLD) systems [55, 56]. They can be achieved by formulating a MPC problem and solving it on-line using a mixed-integer quadratic program (MIQP) [57] or a multi-parametric mixed-integer linear program (mp-MILP) and computing a piecewise linear (PWL) optimal control law offline [58].

Beyond the challenge of the hybrid modeling of complex systems, several other issues must be addressed, in order to consider large size problems (in terms both of continuous and discrete states), uncertainties (in terms of inputs and parameters) and computation load (critical for aircraft future configurations, for instance, see Figure 8) specifically encountered in such industrial processes.

type of control directly exploits, in a closed loop, physical cues of the environment perceived by sensors to obtain a desired behavior with regard to the environment. The control is defined in the formalism introduced in [59] [60] as the control to zero steady-state error on a time horizon of a function $e(q;t)$ called "task function".

$$e(q;t) = C(s(r(q;t);t) - s(t))$$

The vector $s(r(t))$ is a set of measurements (e.g., for a vision sensor: geometric characteristics of an object) given by a sensor whose configuration in $SE(3)$ is known from a set of state parameters q . The vector $s(t)$ contains the desired value of the features, which can be either constant in the case of a fixed goal, or varying if the task consists in following a specified trajectory. C is a matrix for taking into account a possible redundancy of information.

Vision-based control

We have used this technique recently to deal with under-actuated systems (rotary wing UAVs) equipped with a monocular visual sensor to obtain control laws providing stability and robustness properties. The latter includes local stabilization on visual landmarks [61] [62] or in large displacements for path tracking or moving object tracking [63] [64]. Their design makes no a priori assumption on the environment (with respect to the tracking object configuration, for instance, or type of tracking motion) and by taking into account physical constraints acting on the system (flight envelope, actuator saturation) which makes it particularly nonlinear. Using anti-windup techniques (see Section "anti-windup compensation"), input saturation has been incorporated into the control scheme to implicitly deal with constraints on the output variables. This approach has been used for reactive obstacle avoidance [39] and to permanently maintain the availability of visual cues in the image while performing maneuvers [65] [66].



Figure 9 – Vision-based tracking of an autonomous mobile robot by an AirMax drone equipped with a monocular camera

Multi-task control

Multi-task control (tracking a vehicle with obstacle avoidance, for example, or spatial manipulation under constraints) or control using multimodal exteroceptive sensors can be considered using extensions of sensor-based control technique [67].

Several tasks may be indeed considered simultaneously using a cascade of orthogonal projections in the null-space of tasks (expressed in the form of linear relations between the operational variables and the control variables) of higher priority using the recursive approach

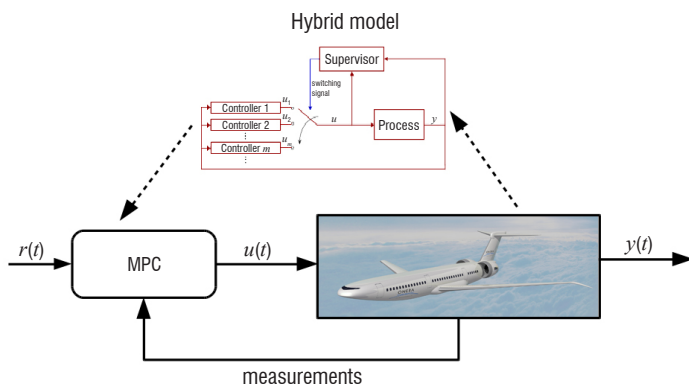

Figure 8 – Predictive control based on the evolution of the hybrid system

Multi-sensor-based control

Sensor-based control provides a framework to control the evolution of systems with embedded sensors in dynamic environments (not known a priori: disturbances, moving obstacles, etc.). Basically, this

proposed in [68]. Let q be the generalized coordinate vector for the considered system, the multi-task motion control can be obtained from:

$$\ddot{q}_k = \ddot{q}_k - 1 + (\mathbf{J}_k \mathbf{P}_{k-1})^\dagger (\ddot{x}_k - \dot{\mathbf{J}}_k \dot{q}_{k-1} - \mathbf{J}_k \ddot{q}_{k-1})$$

where $\ddot{q}_0 = 0$, and where \mathbf{J}_k is the Jacobian associated with the task k and \mathbf{P}_k is the projector operator in the null-space of the augmented Jacobian matrix for the task k , which can be computed as:

$$\mathbf{P}_k = \mathbf{P}_{k-1} - (\mathbf{J}_k \mathbf{P}_{k-1})^\dagger \mathbf{J}_{k-1} \mathbf{P}_{k-1}$$

starting from $\mathbf{P}_0 = \mathbf{I}_d$.

Equality or inequality constraints (such as actuator saturation or obstacles) can thus be placed in a Jacobian of constraints, as proposed in [69]. The various tasks can also be decoupled by using a consistent pseudo-inverse [70]. Using this algebraic form, inequality constraints can be verified and enforced a posteriori only, thus potentially leading to sub-optimal solutions using, for instance, the Constraint Compliant Control framework [71] [72]. However, once the number of constraints becomes high, this type of method cannot lead to control solutions that can strictly guarantee constraint satisfaction and the use of Quadratic Programming (QP) techniques may thus be considered (see the following section).

The sensor-based control paradigm can be extended to systems with several types of embedded sensors. A multi-sensor approach can either use several identical sensors and exploit their redundancy, or use different sensor types for their complementarity and reduce inaccuracies and uncertainties in the measurements. This may lead to the implementation of fault-tolerant control schemes if a decision layer for detection and reconfiguration is associated with the multi-sensor based controller.

Heterogeneous sensor data can be fed into fusion algorithms (e.g., Kalman or Bayesian methods) to provide state estimation for modeling the environment. However, since these sensors generally measure different physical phenomena, it is preferable to use them directly in the low-level servo controller rather than to apply multisensory fusion, or to design complex state machines [73]. This idea, originally proposed in the hybrid position-force control paradigm [74], can be extended to feedback from multiple sensors. This brings new challenges to controller design (e.g., related to the sensor characteristics (synchronization, hybrid control, task compatibility, etc.) or to the task representation [75]. A matrix C must be defined for this purpose to either decompose the sensor feedback in an orthogonal or reciprocal base and smoothly switching between different sensor feedback (transition between free and constrained motions for instance) or by treating the data coming from different sensors as a unique, higher-dimensional signal.

In another approach, each sensor is given a reference signal and considered as an independent sub-task in the global task function [76]. Control can thus be drawn as a hierarchy between the different sensors to build a control scheme that prevents lower subtasks from disturbing higher ones. This hierarchy can be made dynamic to avoid local minima [77], as suggested above for multi-task control schemes.

Quadratic multi-objective optimization

The control problem for a system whose behavior results from sensor-based task redundancy may be expressed as the problem of finding series of control inputs that will drive the system from an initial state towards several objectives and can be seen as a multi-objective optimization problem that can be treated with optimization techniques, such as a quadratic multi-objective optimization problem under linear constraints (system dynamics) and inequality constraints (control input and other physical constraints) where priorities between the objectives can be dealt with through a strict or soft hierarchy. Assuming a convex solution space, the optimal solution of the control problem lies at the boundary of the feasible (constraint compliant) solution space. Finding the optimal solution thus boils down to finding the active constraint set, *i.e.*, the boundary where it lies. Optimization problem solvers are designed to optimally choose this subset of constraints that should be considered when computing the optimal solution of the control problem.

Obstacle avoidance techniques included in the control law structure based on a Quadratic Program (QP) were investigated initially by [78]. Since then, control approaches relying on optimization tools such as a Linear Quadratic Problem (LQP), enable inequality constraints to be solved more easily and Hierarchical Quadratic Programming (HQP) has been introduced [79] by starting to solve a QP to obtain a solution for a higher priority task and then solving other QP for lower priority tasks, without interfering with any higher priority task.

An alternative solution is to solve a single QP for a prioritized multi-objective problem by introducing a weighting vector influenced by a decision variable [76]. Note that Pareto-optimal solutions can also be sought. Prioritized constraint satisfaction and, if needed, constraint relaxation or uncertainties can be introduced via slack variables to "soften" the constraints and can be considered through setting adequate multiparametric-MINLP or mp-MIQP problems [80]. Smooth task transitions can be easily achieved within a framework using a weighting strategy [76]. More recently, a generalized hierarchical framework that enables both soft and strict priority problems with smooth priority transitions to be described have been proposed [81] [82].

Notice that the problem can also be formulated using Model Predictive Control (MPC) to ease the integration of constraints (through soft-constraints and an exact penalty function to guarantee the problem feasibility) and to explicitly take into account the effect of uncertainty and disturbances on the future evolution of the system (see next Section).

Model Predictive Control techniques in navigation

For the evolution of vehicles in outdoor environments, absolute localization by merging the INS (Inertial Navigation System) and GPS information is often used. It is however subject to a lack of robustness, due to GPS signal masking problems and to multipath signals encountered in urban environments, or even no signal at all. The localization can be carried out alternatively or additionally by combining measurements of proprioceptive sensors

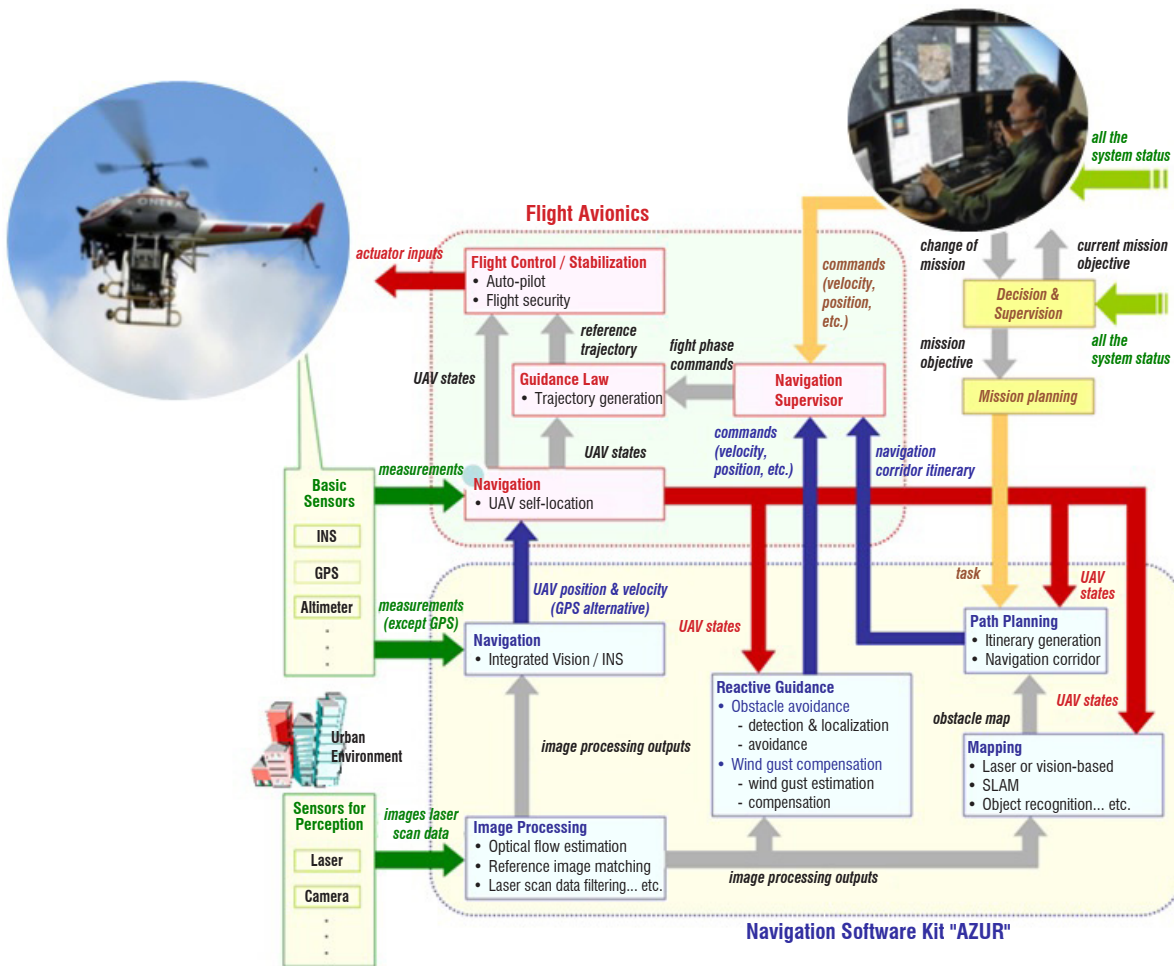

Figure 10 – "AZUR" navigation software kit

(inertial, odometry) and visual cues perceived by active sensors (lidar, camera RGBD) or passive sensors (stereo and monocular cameras). We have developed at ONERA a navigation software kit called *AZUR*, which combines in a modular way several techniques for localization and guidance with a path planner (see Figure 10), which can be said to belong to *map-based navigation techniques*, which rely on the absolute localization on a previously acquired map of the environment. For navigation in large and unknown environments, techniques that simultaneously associate safe exploration/navigation and mapping/self-localization processes automatically and on-line have been investigated for more than a decade. These techniques are grouped under the SLAM (Simultaneous Localization And Mapping) or CML (Concurrent Mapping and Localization) acronyms. They basically rely on an estimation of the mobile sensor configuration and then of the trajectory from noisy sensor data and probabilistic methods. Today, the latter experience a rapid development due to their central role in the development of autonomous vehicles.

Most advanced navigation techniques, map-based navigation and mapless navigation combine a multi-metric representation of the environment in which the robot operates with perceptual information "as they come" (optical flow, feature detection and tracking, environment appearance, and other qualitative information). Thus, with an accurate estimation of the vehicle trajectory, the information gathered on the environment over time can be aggregated into a common reference to build a 3D representation of the scene (stereo depth map or RGBD camera or cloud Lidar points) in which high level semantic

information on the objects, such as the dynamic type of the object or object class (car, pedestrian, tree, etc.) can be added. Figure 11 shows the result of a 3D modeling chain developed at ONERA for the real-time environment modeling from embedded vision sensors of autonomous vehicles, which have to be equipped with safe navigation algorithms (obstacle detection and path planning).

Indeed, while the vehicle state is estimated and the environment modeled, navigation algorithms must run to plan and execute optimal paths to fulfill a mission, which can, for instance, be to explore the environment while avoiding obstacles (*i.e.*, to perform an active vision function). The mission objectives can be translated for this into various cost functions expressed in terms of control variables. Based on these principles, we have developed a whole set of autonomous safe navigation algorithms in dynamic environments which have been grouped in a toolbox call COPERNIC (w3.onera.fr/coper-nic). Many of the techniques take advantage of Model Predictive Control principles.

MPC principles as a general framework for navigation

MPC is an effective means to deal with a multi-variable constrained control strategy for which the issues of real-time implementation, stability and performance are well understood for linear systems. Moreover, much progress have been made over the last decade with regard to non-linear systems, with model uncertainties [83], as well as with regard to systems that are subject to a large set of constraints [84].

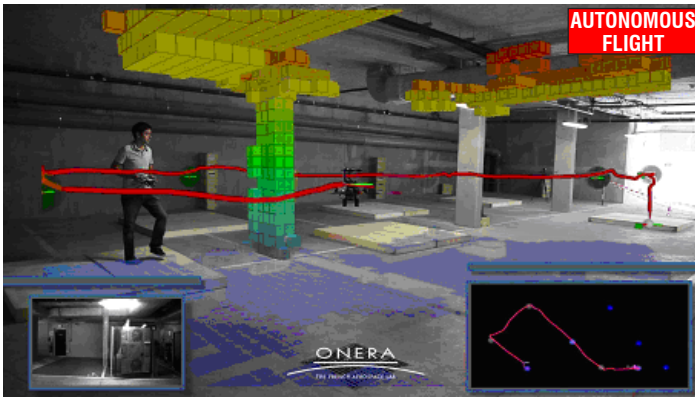

Figure 11 – 3D modeling of an indoor environment based on stereo images where the voxel color code displays the height information

The MPC problem for a discrete time model of a LTI system can be formalized as:

$$x(k+1) = A_x(k) + Bu(k)$$

where $x(k) \in R^n$ et $u(k) \in R^m$ denote the state and control input respectively [83]. The predictive control feedback law is computed by minimizing a predicted performance cost, which is defined in terms of the predicted sequences of state and input predictions over prediction horizons. This predicted cost can be set in the following quadratic form:

$$J_{(p,m)} = \underset{u(\cdot)}{\text{minimize}} \left[x(p)^T P_0 x(p) + \sum_{i=0, (p-1)} x(i)^T Q x(i) + \sum_{i=1, (m-1)} Ru(i) \right]$$

subject to

$$Ex + Fu \leq \Phi$$

where p and m denote respectively the prediction and the control horizons with $p \geq m$. P , Q , R are positive definite matrices (Q may be positive semi-definite). The origin of the problem ($x = 0$, $u = 0$) is assumed to be in a feasible region. Once the minimizing control sequence is determined, a receding horizon scheme proceeds by implementing the first control $u_{(p,m)}^*(0|x(k))$ to obtain $Ax(k) + Bu_{(p,m)}^*$, the rest of the control sequence being used to update the problem. When the constraints are linear, the convex optimization problem of the objective function under constraints, which therefore has a unique solution, requires Quadratic Program (QP) to be solved.

Fast and reliable solvers based on interior point or active set methods are today available for solving QP problems in real-time, and parallelizable forms exists (PQP) that can readily exploit the full parallelism of multiprocessor machines, including multi-core, SIMD, and GPU [85]. MPC may be used in various control problems as discussed in the previous sections. In particular, we used this problem formulation in navigation algorithms. Based on a prediction of the system behavior, a multi-objective performance criterion is optimized at each time-step for computing control inputs that achieve the required goals. Unlike most path planning methods, this scheme allows the dynamics of the system to be adequately described using model reduction techniques, for instance, as well as environment changes, since new control inputs are computed on the basis of measurements acquired in real time. Moreover, MPC translates the preview over a future horizon of the consequences of the control on the system state in the sense of a certain cost while satisfying the constraints for producing emergent behaviors.

Example of emergent behaviors

Using this MPC framework, a first contribution has been made to 3D trajectory tracking with obstacle avoidance for UAVs [86] defining a multi-objective control problem. The latter consists in finding, under constraints, the desired sub-task parameters (a set of gains of PD-feedback elementary controllers) over a preview horizon N that minimizes the sub-task errors; *i.e.*, $\|\hat{x} - \hat{x}^r\|$ according to the measured state (x_k, \dot{x}_k) , at the time period k , the optimization problem:

$$\underset{K_{k+N|k}}{\text{minimize}} \sum_{i=1, N} \omega_m \left\| \hat{x}_{k+i|k} - \hat{x}_{k+i|k}^r \right\|^2 + r_{k+i|k}^m$$

while considering the system dynamics to satisfy which can be expressed as equality constraints. $K_{k+N|k}$ denotes the horizon of the task parameters. The terms r^m are regularization costs introduced to limit the variations of the optimization variables.

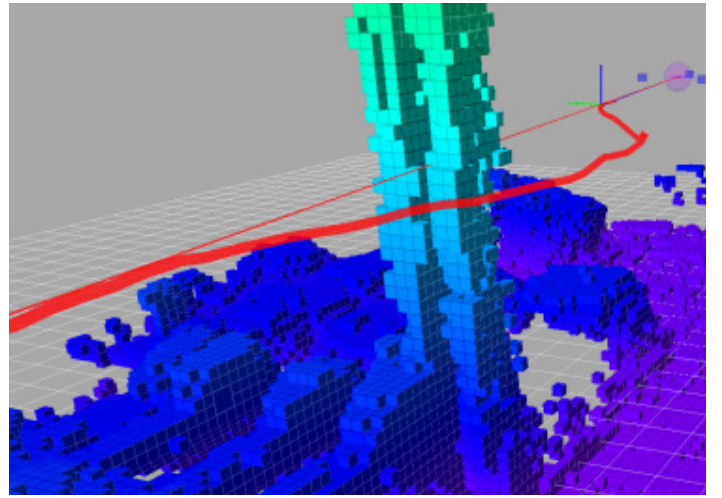

Figure 12 – Obstacle avoidance trajectory by a UAV from a real-time reconstruction of the 3D environment using a predictive model of the vehicle and a multi-objective optimization for its motion control

Several types of behaviors have been explored for a fleet of autonomous robots equipped in the experimental setup with stereo vision sensors by using this general framework [87].

- Exploration strategies of a finite environment have been experimented on using a weighted cost function combining a cost of navigation, which allows the regulation of the speed of vehicles and the control of their travel to waypoints to be minimized, a security cost whose cost minimization allows obstacle and collision avoidance between vehicles and a cost on the energy consumption [87].
- Another contribution [88, 89] relies on the resolution of the optimization problem (non-linear and constrained) by a discretization and exploration of the control space to complete the exploration of a defined area, considering that each point of the zone was visited by at least one of the vehicles in the fleet. The algorithm has the advantage of ensuring a constant computation time at each iteration, to be potentially less sensitive to local minima and to optimizer initialization. It has been successfully implemented on mobile robots and UAVs for safe exploration of a cluttered environment [90].

- Source localization strategies within a pre-defined area by a swarm of robotic systems have been designed in a distributive way and have shown high efficiency in terms of time spent and robustness to vehicle and communication failures [131].

Other emergent behaviors for swarms of autonomous vehicles can be explored on the basis of Distributed Model Predictive Control (DMPC) [91], this by exploiting MPCs on local sub-systems and exchanging predictions so as to coordinate with each other, the whole system convergence and stability being ensured by consensus mechanisms [92, 93, 94] or by using structured optimization techniques (see the next section).

The potential offered by the various DMPC strategies is quite broad and could constitute a general framework for implementing agile autonomous sensor networks (embedded on autonomous robots) whose implementation would face a set of practical difficulties, such as the existence of possible communications between the distributed sensors, uncertainty on the measurements collected and the environment, and the possible loss of observability depending on trajectories, taking into account strapdown constraints [95, 96]. Based on such a framework, we can, for instance, benefit from the information redundancy to increase the localization robustness by fusing individual localizations or, in a more integrated way, by merging information collected on the environment from various sensors in a distributed filter architecture, a problem which is known as: distributed localization and mapping [97, 98, 99]. Collaborative SLAM (CoSLAM) [100, 88, 95], considering non-coordinated vehicles sharing their SLAM information under communication constraints can also be investigated on the basis of such a framework.

Structured Distributed Control

It is possible to go further in the integration of subsystem MPCs, while controlling the overall system performance/stability by the use of structured optimization methods to compute a distributed control law. Distributed control is introduced as an alternative architecture to centralized and decentralized control [91]. Distributed approaches suggest breaking down the system into autonomous sub-agents organized into an information exchange network, in order to reduce the drawbacks of a centralized architecture by taking advantage of the sparsity of large-scale systems where the interaction between sub-systems can generally be reduced to direct neighbors. Setting up distribution techniques nevertheless requires the coordination problem of the several local controllers to be addressed. In this perspective, Model Predictive Control is particularly relevant since it provides a temporal window – the preview horizon – to exploit in order to establish a coordination strategy.

Distributed architectures rely on a decomposition of the system into subsystems of lower dimension, and single out from decentralized approaches by the coordination of sub-agents. The table in Figure 13 presents an optimal control architecture nomenclature in the case of two coupled sub-systems [101]. This coordination is aimed at bringing the distributed optimization toward a collective optimum (in the sense of Pareto), in the case of cooperative algorithms. It may be viewed as a class of sub-optimal control. Conversely, non-cooperative algorithms imply the respective optimization from each sub-agent of a local cost function, whose evolution is also subject to known actions from the other sub-systems. As a result, actions are taken

individually, with each controller being aimed at accepting a change in a variable under the sole condition of a local benefit, and thus tending to produce solutions drawing the system towards a Nash equilibrium. This equilibrium is a stable state around which one or all system(s) would have a handicap with respect to its or their respective local objective.

| Input variables | $\mathbf{u}^{(1)} \in K_{\mathbf{u}}^{(1)}$ | $\mathbf{u}^{(2)} \in K_{\mathbf{u}}^{(2)}$ |
|------------------------------------|--|--|
| Cost functions | $\bar{g}^{(1)}(\mathbf{u}^{(1)}), g^{(1)}(\mathbf{u}^{(1)}, \mathbf{u}^{(2)}), \bar{g}^{(2)}(\mathbf{u}^{(2)}), g^{(2)}(\mathbf{u}^{(1)}, \mathbf{u}^{(2)})$ $g(\mathbf{u}^{(1)}, \mathbf{u}^{(2)}) \triangleq \omega_1 g^{(1)}(\mathbf{u}^{(1)}, \mathbf{u}^{(2)}) + \omega_2 g^{(2)}(\mathbf{u}^{(1)}, \mathbf{u}^{(2)})$ | |
| Decentralized | $\min_{\mathbf{u}^{(1)} \in K_{\mathbf{u}}^{(1)}} \tilde{g}^{(1)}(\mathbf{u}^{(1)})$ | $\min_{\mathbf{u}^{(2)} \in K_{\mathbf{u}}^{(2)}} \tilde{g}^{(2)}(\mathbf{u}^{(2)})$ |
| Non-cooperative distributed (Nash) | $\min_{\mathbf{u}^{(1)} \in K_{\mathbf{u}}^{(1)}} g^{(1)}(\mathbf{u}^{(1)}, \mathbf{u}^{(2)})$ | $\min_{\mathbf{u}^{(2)} \in K_{\mathbf{u}}^{(2)}} g^{(2)}(\mathbf{u}^{(1)}, \mathbf{u}^{(2)})$ |
| Cooperative distributed (Pareto) | $\min_{\mathbf{u}^{(1)} \in K_{\mathbf{u}}^{(1)}} g(\mathbf{u}^{(1)}, \mathbf{u}^{(2)})$ | $\min_{\mathbf{u}^{(2)} \in K_{\mathbf{u}}^{(2)}} g(\mathbf{u}^{(1)}, \mathbf{u}^{(2)})$ |
| Centralized | $\min_{(\mathbf{u}^{(1)}, \mathbf{u}^{(2)}) \in K_{\mathbf{u}}^{(1)} \times K_{\mathbf{u}}^{(2)}} g(\mathbf{u}^{(1)}, \mathbf{u}^{(2)})$ | |

Figure 13 – Distributed control architecture nomenclature for two coupled sub-systems (from [102])

Problems for which decomposition (in which variables can be partitioned into sub-vectors and each constraint involves only variables from one of the sub-vectors) lead evidently to the ability of solving each problem separately (and in parallel), and then re-assembling the solution. A more interesting situation occurs when there is some coupling or interaction between the sub-vectors, so the problems cannot be solved independently. For these cases, such decomposition techniques can be used to solve the overall problem by iteratively solving a sequence of smaller problems, including the dual decomposition technique [103].

This approach makes it possible to strictly decompose the multi-objective MPC problem into coupled and conflicting sub-problems. The coordination problem is translated into a non-cooperative game problem, providing the control architecture with a gain in modularity that allows approximations on the couplings between sub-systems to be naturally enforced. A parallel algorithm can then be used to solve the resulting distributed control problem as a set of sub-problems of various time scales and approximation levels, able to successfully solve conflicts between objectives [102].

DMPC also offers a set of possibilities for the implementation of Fault-Tolerant Control (FTC) laws in case of sensor and actuator fault detection, in order to maintain the desired closed-loop performance [104]. In [105], a data-based monitoring and reconfiguration system was developed for a distributed model predictive control system in the presence of control actuator faults. In addition to a monitoring method, appropriate DMPC reconfiguration (fault-tolerant control) strategies were designed to handle the actuator faults and maintain the closed-loop system state within a desired operating region.

Coordination strategies between autonomous vehicles can also involve discrete and continuous variables. The use of mixed-integer variables allows discrete actions to be described in the model and non-convex admissible domains to be handled. The mixed-integer MPC formulation thus allows discrete actions to be drawn at the control layer, which are commonly supported by the decision layer, and thus enables a more consistent coordination of discrete events. Mixed-Integer Programming (MIP) [57] indeed proposes an ideal framework to account for logic events and non-convex admissible domains. MIP approaches generally use integer variables to describe logic and combinatorial systems, with these variables being used either as discrete state/input values or as triggers to activate and deactivate constraints in the optimization problem. The latter use offers opportunities to regard non-convex admissible domains as an arrangement of convex regions, an integer variable specifying in which convex region the now convex problem is currently being considered. While integer programs are NP-hard, efficient algorithms and solvers are available for specific classes of programs, exploiting the form of the optimization problem or employing heuristics. For example, quadratic MIPs (MIQPs) can be solved using branch and bound algorithms which solve a graph of QP problems resulting from the con-sideration of integer variables as real variables [106]. Given that real-valued QP problems are convex, the resolution of these relaxed sub-problems is computationally efficient.

Dynamic Adaptive Planning

At the upper level of the control hierarchy, the role of the decision layer is to produce high-level activity plans composed of sequences of elementary tasks to be fulfilled by a system whose control would be performed at a task-level by making use of some of the techniques discussed before. Such plans are especially useful for complex missions requiring high-level goals to be achieved, which could be, for example, the "long-term surveillance of critical areas". High-level goals of this type are hardly satisfied by using only low-level reactive strategies, which is the reason why a deliberative planner comes into play [107]. Several toolboxes have been developed at ONERA over this last decade to solve planning and scheduling problems, such as *InCELL* [108], *HiPOP* [109] or *CPT* [110].

As an input, the planner considers a symbolic representation of the current state of the system (e.g., a Boolean component failure status), a symbolic representation of the environment (e.g., a waypoint graph for modeling trajectories on a complex terrain), goals that must be fulfilled (tasks to be performed, states to be reached, etc.), constraints that must be met (temporal constraints, resource constraints, etc.), optimization criteria (mission duration, action costs, etc.), and simplified equations of the dynamic behavior (e.g., navigation durations modeled as arc weights in the waypoint graph).

The planner uses these inputs to produce a plan. In practice, it must also be able to cope with the uncertainty about the current state of the system and about possible future evolutions of the environment, and with dynamic missions in which the set of high-level goals provided can be updated following new event detections or

new operator requests. Two main approaches are classically used in such contexts:

- *Reactive planning*, which consists in building an initial plan based on arbitrary deterministic assumptions and in performing online replanning or online plan repairs each time that a new relevant item of data coming from the lower levels of control or from the perception modules is received [111]. The integration of this planning level with the task control level is tricky. The necessary dialog between action and cognition is a particularly complex issue. Receding horizon optimization methods, such as those discussed in the previous section, may help to anticipate the effects of actions and produce local adaptations, for instance by using Mixed-Integer Linear Programming (MILP) to incorporate kino-dynamic, obstacle avoidance and collision avoidance constraints, as proposed in [112] or Mixed-Integer Quadratic Programming (MIQP) to reach complex adaptive behavior [113]. This dialog must be supported by a common representational medium, such as that proposed by the Theory of Event Coding (TEC), in which perceptual contents and action plans are coded for an adequate theoretical treatment of perception and action planning [114].
- *Proactive planning*, which consists in producing offline a decision strategy covering several situations; such a strategy might be represented as a *decision policy* (mapping from observable state values to actions), as a *conditional plan* (a plan with branches), or as a *robust plan* by explicitly taking into account the effect of uncertainty and *constraint satisfaction* using for instance adaptations of the MPC formulation [115].

See Figure 14 for an illustration of these concepts. For more detailed examples of reactive planning, see [116] for an application to a multi-robot area surveillance mission and [117] for an application to an autonomous satellite surveillance mission. On the proactive side, see [118] for the production of decision policies for a UAV and [119] for the production of temporally flexible plans for multi-robot deployment.

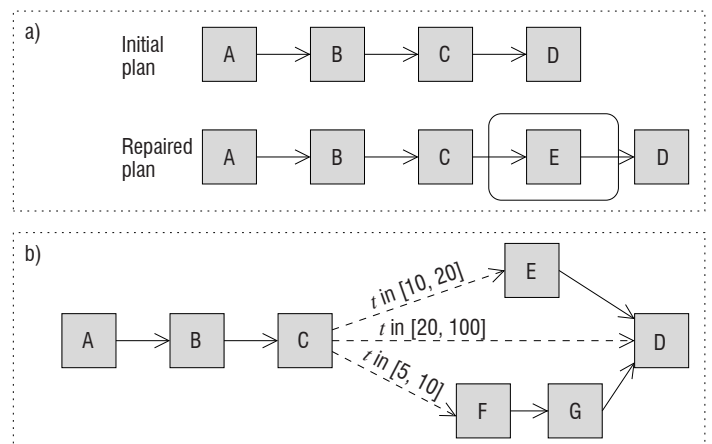

Figure 14 – (a) Reactive planning transforming an online plan containing a sequence of four tasks into a new plan containing one more task. (b) Proactive conditional plan (dashed lines correspond to conditional branches depending on an observable state parameter t and affecting the performance of tasks E, F, G)

Reactive and proactive planners can be based on various resolution methods, such as PDDL-like deterministic and non-deterministic planning algorithms [107], scheduling algorithms [120], constraint programming [121], Markov Decision Processes [122], Simple Temporal Networks with Uncertainty [123], etc. In each case, complete or approximate search techniques can be used (exhaustive tree search, local search, global optimization, dynamic programming, etc.).

In the following, we describe research directions deserving to be explored to achieve increasing system autonomy at the planning level. These directions are summarized in Figure 15.

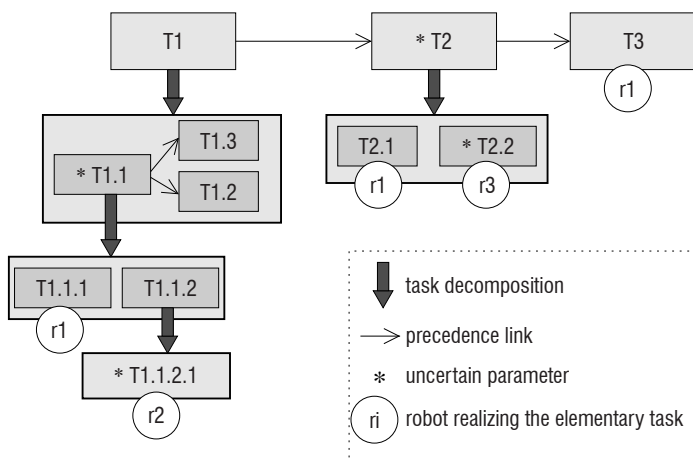

Figure 15 – Hierarchical distributed plans with uncertain parameters and temporal constraints (other constraints, such as resource constraints, are not represented, nor the planning criteria)

Hierarchical deliberations

In the case of reactive planning, the first idea is to push *hierarchical deliberations* further, which produce plans containing high-level tasks decomposed into lower level tasks, such as in *Hierarchical Task Networks* (HTN [124]). With regard to HTN, a major objective is to mix hierarchical representations with scheduling models containing complex temporal constraints among tasks, complex resource constraints, and complex criteria. Another objective is to refine physical models used at the lower levels of the hierarchy (e.g., navigation models). These lower levels could for instance embed Model Predictive Control techniques to obtain a more accurate view of the impact of high-level decisions. Such an integration with MPC would be quite natural since reactive planning and MPC are based on similar principles (search for a control strategy over a finite horizon using deterministic modeling of future evolutions). Note also that using hierarchical representations enables for more modularity in mission modeling, for shorter computation times, and for more readability from an operational point of view [109].

Real-time planning strategies

From the online reasoning side, a second goal is to explore *real-time planning* strategies more in depth. On this point, hierarchical deliberations pave the way for obtaining a continuum between conservative high-level coarse-grain reasoning when quick deliberations are required, and fine-grain reasoning at lower levels of the hierarchy when more computation time is available. Hierarchical deliberations

can also help to make plan repairs more local, leading to increased plan stability [125]. Another advantage of hierarchical representations is that they can help to handle the tricky issues classically encountered when combining online reactive planning and real-time execution [126] (action interruption issues, state projection issues, plan concatenation issues, etc.). For example, reactive planners need an initial state as an input and, with current approaches, this initial state is very often either the state obtained by interrupting all pre-emptible actions, or the state obtained by finishing all ongoing actions. Having low-level tasks embedding MPC techniques could help in considering intermediate states obtained in the course of actions, which could lead to more fluidity in the real-time control of the system.

Distributed plans

In another direction, a third objective is to push further *distributed plans*, which are needed for missions involving multiple agents that must be coordinated for achieving common high-level goals, such as robots performing acquisition tasks and robots deployed to establish an *ad hoc* communication network. Concerning distributed plans, our ambition is to develop generic strategies combining centralized reasoning for high-level decisions, like task allocation among agents, and decentralized plan repair for low-level decisions referring to a single agent or team of agents. When using distributed plans, one major difficulty is also the outage of communication links between agents, which is why the plans built in a centralized way must ideally be robust to the absence of communication links (*multi-agent dynamic controllability* issues [127]). Another difficulty is that operators supervising the mission must have some global situation awareness, which is why the generic schemes developed should explicitly describe by which agent a particular decision can be made. As an illustration, see [128] for a space mission where robust plans sent to satellites are built at a centralized mission center, while opportunistic reactive planning is performed by decentralized satellite on-board reasoning. Note that since we target missions in which agents all share the same high-level goals, using multiagent negotiation schemes is less relevant.

Uncertainty management

Lastly, some of the planners that we develop are built upon constraint-based optimization models solved using local search and global optimization strategies [129, 108]. Using such planners for reactive planning is quite natural, but there is still some work to be done before an efficient adaptation to proactive planning can be obtained, e.g., for producing plans maximizing an expected reward or minimizing a risk-level as in *Online Combinatorial Stochastic Optimization* (OSCO [130]). For this, we would like to explore new combinations between constraint-based scheduling on the one hand and stochastic uncertainty reasoning or set uncertainty reasoning on the other hand. Finally, uncertainty management should be combined with all of the hierarchical and distributed aspects mentioned above.

Conclusion

Functional and decisional autonomy in automated systems is at the core of research activities for designing future aircraft and spacecraft, as well as all systems for mobility in the fields of transportation,

the environment, security, defense, etc. The control architectures of these autonomous systems must meet requirements in terms of performance that are different in nature (robustness to disturbances, adaptation to non-deterministic and varied functions, intersystem and man/system interaction capabilities, etc.) while satisfying security constraints and the reliability required for their implementation.

Several advances, at different levels of these control architectures, are discussed in this paper. Robust control techniques should allow the various physical constraints imposed on scalable systems to be addressed as well as dealing with sequences of control modes.

In addition, we have considered evolutions on sensor-control techniques for performing hybrid tasks (combining several types of sensors), or multiple tasks (multiple functional objectives). Model-based control techniques can contribute greatly to complex control problems for guidance/navigation and coordination of dynamic systems under constraints, especially in view of a real-time implementation of optimization methods on the novel hardware architectures of embedded computers. Finally, considering that the reactive and deliberative control levels have to be more integrated in these control architecture, we have discussed the need for hierarchical and/or distributed decision in the context of real-time planning with uncertainties ■

References

- [1] A. TATE - *Intelligible AI Planning - Generating Plans Represented as a Set of Constraints*. Springer London, London, p. 3-13, 2001.
- [2] V. WIELS, R. DELMAS, D. DOOSE, P.-L. GAROCHE, J. CAZIN, and G. DURRIEU - *Formal Verification of Critical Aerospace Software*. AerospaceLab Journal Issue 4, p. 526-531, 2013.
- [3] M. SANFOURCHE, V. VITTORI, and G. LE BESNERAIS - *EVO: A realtime Embedded Stereo Odometry for MAV Applications*. 2013 IEEE/RSJ International Conference on Intelligent Robots and Systems, p. 2107-2114, Nov 2013.
- [4] M. SANFOURCHE, B. LE SAUX, A. PLYER, and G. LE BESNERAIS - *Environment Mapping Amp; Interpretation by Drone*. 2015 Joint Urban Remote Sensing Event (JURSE), p. 1-4, March 2015.
- [5] G. FERRERES and J. M. BIANNIC - *Smt : The Skew μ Toolbox (a Matlab Toolbox for Robustness Analysis)*. SMT: The skew Mu Toolbox, <http://www.onera.fr/staff/jean-marc-biannic>, 2004.
- [6] J.M. BIANNIC and C. ROOS - *Flight Control Laws : Recent Advances in the Evaluation of their Robustness Properties*. AerospaceLab Journal, 4, 2012.
- [7] C. ROOS and J.M. BIANNIC - *Efficient Computation of a Guaranteed Stability Domain for a Figh-Order Parameter Dependent Plan*. American Control Conference, Baltimore, Maryland, USA, 30 06(2 07):3895-3900, 2010.
- [8] C. ROOS, F. LESCHER, J.-M. BIANNIC, C. DLL and G. FERRERES - *A Set of Analysis Based Tools to Evaluate the Robustness Properties of High-Dimensional Uncertain Systems*. 2011 IEEE International Symposium on Computer- Aided Control System Design (CACSD), p. 644-649, Sept 2011.
- [9] J.-M. BIANNIC and C. ROOS - *Enhanced Mu-Analysis Techniques for Clearance of Flight Control Laws*. Final COFCLUO Workshop. Also published in a Springer Book, LNCIS series, 416:131-147, 2010.
- [10] C. ROOS - *A Practical Approach to Worst-Case h_{∞} ; Performance Computation*. 2010 IEEE International Symposium on Computer-Aided Control System Design, p. 380-385, Sept 2010.
- [11] C. ROOS and J.-M. BIANNIC - *Robustness Analysis Versus Mixed LTI/LTV Uncertainties for On-Ground Aircraft*. Springer Berlin Heidelberg, Berlin, Heidelberg, p. 175-194, 2007.
- [12] G. FERRERES and C. ROOS - *Robust Feedforward Design in the Presence of LTI/LTV Uncertainties*. International Journal of Robust and Nonlinear Control, 17(14):12781293, 2007.
- [13] J.-M. BIANNIC, C. PITTET, L. LAFOURCAD, and C. ROOS - *LPV Analysis of Switched Controllers in Satellite Attitude Control Systems*. AIAA Guidance, Navigation, and Control Conference, Toronto, Canada, 4, 2010.
- [14] J. MACIEJOWSKI - *Predictive Control with Constraints*. Prentice Hall, 2001.
- [15] S. J. QIN and T. A. BADGWELL - *A Survey of Industrial Model Predictive Control Technology*. Control Engineering Practice, 11(7):733 - 764, 2003.
- [16] S. GALEANI, S. TARBOURIECH, M. TURNER, and L. ZACCARIAN - *A Tutorial on Modern Anti-Windup Design*. European Journal of Control, 15(34):418-440, 2009.
- [17] S. TARBOURIECH and M. TURNER - *Anti-Windup Design: an Overview of Some Recent Advances and Open Problems*. Control Theory Applications, IET, 3(1):1-19, 2009.
- [18] D. Q. MAYNE, S. V. RAKOVI, R. FINDEISEN, and F. ALLGWER - *Robust Output Feedback Model Predictive Control of Constrained Linear Systems*. Automatica, 42(7):1217-1222, 2006.
- [19] R. FINDEISEN, R. ALLGOWER, and L. BIEGLER - *Assessment and Future Directions of Nonlinear Model Predictive Control*. Lecture Notes in Control and Information Sciences, Springer Verlag, Berlin, 2008.
- [20] M. ALAMIR - *A Framework for Real-Time Implementation of Low-Dimensional Parameterized NMPC*. Automatica, 48(1):198-204, 2012.
- [21] P. APKARIAN and D. NOLL - *Nonsmooth H-infinity Synthesis*. IEEE Transactions on Automatic Control, 51(1):71-86, Jan 2006.
- [22] P. APKARIAN, M. N. DAO, and D. NOLL - *Parametric Robust Structured Control Design*. IEEE Transactions on Automatic Control, 60(7):1857-1869, July 2015.
- [23] J. LESPRIER, J.-M. BIANNIC, and C. ROOS - *Nonlinear Structured H-Infinity Controllers for Parameter-Dependent Uncertain Systems with Application to Aircraft Landing*. 2014 IEEE Conference on Control Applications (CCA), p. 433-438, Oct 2014.
- [24] A. R. TEEL and N. KAPOOR - *Uniting Local and Global Controllers*. European Control Conference, Brussels, Belgium, July 1997.
- [25] A. R. TEEL and N. KAPOOR - *The I2 Anti-Windup Problem: Its Definition and Solution*. Control Conference (ECC), 1997 European, p. 1897-1902, July 1997.
- [26] J.-M. BIANNIC and P. APKARIAN - *Anti-Windup Design via Nonsmooth Multiobjective H-Infinity Optimization*. Proceedings of the 2011 American Control Conference, p. 4457-4462, June 2011.
- [27] J.-M. BIANNIC - *Limit-Cycles Prevention via Multiple H-Infinity Constraints with an Application to Anti-Windup Design*. 9th IFAC Symposium on Nonlinear Control Systems, IFAC Proceedings Volumes, 46(23):640-645, 2013.

- [28] S. FORMENTIN, F. DABBENE, R. TEMPO, L. ZACCARIAN, and S. M. SAVARESI - *Robust Linear Static Anti-Windup with Probabilistic Certificates*. To appear in IEEE Transactions on Automatic Control.
- [29] C. ROOS and J.-M. BIANNIC - *Aircraft-On-Ground Lateral Control by an Adaptive LFT-Based Anti-Windup Approach*. IEEE Conference on Computer Aided Control System Design, 2006 IEEE International Conference on Control Applications, 2006 IEEE International Symposium on Intelligent Control, p. 2207-2212, Oct 2006.
- [30] G. C. GOODWIN, M. M. SERONK, and J. A. DE DONA - *Constrained Control and Estimation: an Optimization Approach*. Springer, 2004.
- [31] A. H. GLATTFELDER and W. SCHAUFELBERGER - *Control Systems with Input and Output Constraints*. Springer, 2003.
- [32] L. BURLION - *A New Saturation Function to Convert an Output Constraint into an Input Constraint*. Control Automation (MED), 2012 20th Mediterranean Conference on, p. 1217-1222, 2012.
- [33] E. CHAMBON, L. BURLION, and P. APKARIAN - *Time-Response Shaping Using Output to Input Saturation Transformation*. International Journal of Control, 2017.
- [34] E. CHAMBON, L. BURLION, and P. APKARIAN - *Robust Output Interval Constraint Using O/I Saturation Transformation with Application to Uncertain Linear Launch Vehicle*. Control Conference (ECC), 2015 European, p. 1802-1807, 2015.
- [35] L. BURLION, C. POUSSOT-VASSAL, P. VUILLEMIN, M. LEITNER, and T. KIER - *Longitudinal Manoeuvre Load Control of a Flexible Large-Scale Aircraft*. 19th IFAC World Congress, IFAC Proceedings Volumes, 47(3):3413-3418, 2014.
- [36] L. BURLION, J.M. BIANNIC, and T. AHMED-ALI - *Interval Based Robust Control of a Flexible Spacecraft Under Angular Velocity Constraints*. Submitted.
- [37] E. CHAMBON, L. BURLION, and P. APKARIAN - *Robust Output Interval Constraint Using O/I Saturation Transformation with Application to Uncertain Linear Launch Vehicle*. Control Conference (ECC), 2015 European, p. 1802-1807, 2015.
- [38] E. CHAMBON - *Frequency- and Time-Domain Constrained Control of Linear Systems Application to a Flexible Launch Vehicle*. PhD thesis, University of Toulouse, 2016.
- [39] C. CHAUFFAUT, F. DEFAY, L. BURLION, and H. DE PLINVAL - *UAV Obstacle Avoidance Scheme Using an Output to Input Saturation Transformation Technique*. 2016 International Conference on Unmanned Aircraft Systems (ICUAS), p. 227-234, June 2016.
- [40] R. POSTOYAN, P. TABUADA, D. NESIC, and A. ANTA - *A Framework for the Event-Triggered Stabilization of Nonlinear Systems*. IEEE Transactions on Automatic Control, 60(4):982-996, 2015.
- [41] A. SEURET, C. PRIEUR, and L. L. ZACCARIAN - *LQ-Based Event-Triggered Controller Co-Design for Saturated Linear Systems*. Working paper or preprint, 2016.
- [42] D. LIBERZON - *Hybrid Feedback Stabilization of Systems with Quantized Signals*. Automatica, 39(9):1543-1554, 2003.
- [43] J. LYGEROS, K. H. JOHANSSON, S. N. SIMIC, J. ZHANG, and S. S. SASTRY - *Dynamical Properties of Hybrid Automata*. IEEE Transactions on Automatic Control, 48(1):2-17, 2003.
- [44] R. GOEBEL, R. G. SANFELICE, and A. R. TEEL - *Hybrid Dynamical Systems*. IEEE Control Systems Magazine, 29(2):28-93, April 2009.
- [45] O. BEKER, C. V. HOLLOT, and Y. CHAIT - *Fundamental Properties of Reset Control System*. Automatica, 40:905-915, 2004.
- [46] D. NESIC, L. ZACCARIAN, and A. R. TEEL - *Stability Properties of Reset Systems*. Automatica, 44, 8:2019-2026, August 2008.
- [47] R. GOEBEL, J. HESPANHA, A. R. TEEL, C. CAI, and R. G. SANFELICE - *Hybrid Systems: Generalized Solutions and Robust Stability*. Proc. IF AC: Symp on Nonlinear Control Systems, Stuttgart, Germany, p. 1-12, September 2004.
- [48] K. H. JOHANSSON, J. LYGEROS, S. SASTRY, and M. EGERSTEDT - *Simulation of Zeno Hybrid Automata*. Proceedings of the 38th IEEE Conference on Decision and Control, volume 4, p. 3538-3543, December 1999.
- [49] M. JOHANSSON and A. RANTZER - *Computation of Piecewise Quadratic Lyapunov Functions for Hybrid Systems*. IEEE Transactions on Automatic Control, 43(4):555-559, April 1998.
- [50] M. S. Branicky - *Multiple Lyapunov Functions and Other Analysis Tools for Switched and Hybrid Systems*. IEEE Transactions on Automatic Control, 43(4):475-482, Apr 1998.
- [51] T. LOQUEN, S. TARBOURIECH, and C. PRIEUR - *Stability of Reset Control Systems with Nonzero Reference*. Proceedings of the 47th IEEE Conference on Decision and Control, Cancun, Mexico, p. 3386-3391, December 2008.
- [52] G. WITVOET, W. H. T. M. AANGENENT, W. P. M. H. HEEMELS, M. J. G. VAN DE MOLENGRAFT, and M. STEINBUCH - *H2 Performance Analysis of Reset Control Systems*. Proceedings of the 46th IEEE Conference on Decision and Control, New Orleans, LA, USA, p. 3278-3284, December 2007.
- [53] J. CARRASCO, A. BANOS, and A. BARREIRO - *Stability of Reset Control Systems with Inputs*. 16th Mediterranean Conference on Control and Automation, p. 1496-1501, June 2008.
- [54] J. BAKKEHEIM, T. A. JOHANSEN, O. N. SMOGELI, and A. J. SORENSEN - *Lyapunov-Based Integrator Resetting with Application to Marine Thruster Control*. IEEE Transactions on Control Systems Technology, 16(5):908-917, September 2008.
- [55] E. F. CAMACHO, D. R. RAMIREZ, D. LIMON, D. MUOZ DE LA PEA, and T. ALAMO - *Model Predictive Control Techniques for Hybrid Systems*. Annual Reviews in Control, 34(1):21-31, 2010.
- [56] A. BEMPORAD and S. DI CAIRANO - *Model-Predictive Control of Discrete Hybrid Stochastic Automata*. IEEE Transactions on Automatic Control, 56(6):1307-1321, 2011.
- [57] A. BEMPORAD and M. MORARI - *Control of Systems Integrating Logic, Dynamics, and Constraints*. Automatica, 35(3):407-427, 1999.
- [58] A. BEMPORAD, F. BORRELLI, and M. MORARI - *Piecewise Linear Optimal Controllers for Hybrid Systems*. American Control Conference, 2000, Proceedings of the 2000, volume 2, p. 1190-1194 vol. 2, 2000.
- [59] C. SAMSON, B. ESPIAU, and M. LE BORGNE - *Robot Control: the Task Function Approach*. 1991.
- [60] B. ESPIAU, F. CHAUMETTE, and P. RIVES - *A New Approach to Visual Servoing in Robotics*. IEEE Transactions on Robotics and Automation, 8(3):313-326, Jun 1992.
- [61] H. DE PLINVAL, P. MORIN, P. MOUYON, and T. HAMEL - *Visual Servoing for Underactuated VTOL UAVs: a Linear, Homography-Based Approach*. Robotics and Automation (ICRA), 2011 IEEE International Conference on, p. 3004-3010, May 2011.
- [62] H. DE PLINVAL, P. MORIN, P. MOUYON, and T. HAMEL - *Visual Servoing for Underactuated VTOL UAVs: a Linear, Homography-Based Framework*. International Journal of Robust and Nonlinear Control, Wiley - 24 (16), 2014.
- [63] H. DE PLINVAL, P. MORIN, and P. MOUYON - *Nonlinear Control of Underactuated Vehicles with Uncertain Position Measurements and Application to Visual Servoing*. 2012 American Control Conference (ACC), p. 3253-3259, June 2012.

- [64] P. MORIN, H. DE PLINVAL, and P. MOUYON - *Stabilization of a Class of Underactuated Vehicles with Uncertain Position Measurements and Application to Visual Servoing*. Automatica, p. 155-169, 2017.
- [65] L. BURLION and H. DE PLINVAL - *Keeping a Ground Point in the Camera Field of View of a Landing UAV*. Robotics and Automation (ICRA), 2013 IEEE International Conference on, p. 5763-5768, May 2013.
- [66] H. DE PLINVAL and L. BURLION - *Nonlinear Visual Servoing Control for VTOL UAVs with Field of View Constraint*. Advances in Aerospace Guidance Navigation and Control - Springer, p. 531-548, 2015.
- [67] A. CHERUBINI and F. CHAUMETTE - *A Redundancy-Based Approach for Obstacle Avoidance in Mobile Robot Navigation*. Intelligent Robots and Systems (IROS), 2010 IEEE/RSJ International Conference on, p. 5700-5705, Oct 2010.
- [68] B. SICILIANO and J. J. E. SLOTINE - *A General Framework for Managing Multiple Tasks in Highly Redundant Robotic Systems*. Advanced Robotics, 1991. "Robots in Unstructured Environments", 91 ICAR., Fifth International Conference on, p. 1211-1216 vol.2, June 1991.
- [69] S. RUBRECHT - *Contributions to the Control of Constrained Robots*. PhD Thesis Department of Engineering, University Paris 6, UPMC, 2011.
- [70] L. SENTIS and O. KHATIB - *Synthesis of Whole-Body Behaviors through Hierarchical Control of Behavioral Primitives*. International Journal of Humanoid Robotics, 02(04):505-518, 2005.
- [71] S. RUBRECHT, V. PADOIS, P. BIDAUD, M. DE BROISSIA, and M. DA SILVA SIMOES - *Motion Safety and Constraints Compatibility for Multibody Robots*. Autonomous Robots, 32(3):333-349, 2012.
- [72] S. RUBRECHT, V. PADOIS, P. BIDAUD, and M. DE BROISSIA - *Constraints Compliant Control: Constraints Compatibility and the Displaced Configuration Approach*. Intelligent Robots and Systems (IROS), 2010 IEEE/RSJ International Conference on, p. 677-684, Oct 2010.
- [73] O. KERMORGANT and F. CHAUMETTE - *Multi-Sensor Data Fusion in Sensor-Based Control: Application to Multi-Camera Visual Servoing*. Robotics and Automation (ICRA), 2011 IEEE International Conference on, p. 4518-4523, May 2011.
- [74] J. J. CRAIG and M. H. RAIBERT - *A Systematic Method of Hybrid Position/Force Control of a Manipulator*. Computer Software and Applications Conference, 1979. Proceedings. COMPSAC 79. The IEEE Computer Society's Third International, p. 446-451, 1979.
- [75] T. YOSHIKAWA and A. SUDOU - *Dynamic Hybrid Position/Force Control of Robot Manipulators: On-Line Estimation of Unknown Constraint*. Springer Berlin Heidelberg, Berlin, Heidelberg, p. 116-134, 1990.
- [76] J. SALINI, V. PADOIS, and P. BIDAUD - *Synthesis of Complex Humanoid Whole-Body Behavior: a Focus on Sequencing and Tasks Transitions*. Robotics and Automation (ICRA), 2011 IEEE International Conference on, p.1283-1290, May 2011.
- [77] A. ESCANDE, N. MANSARD, and P. B. WIEBER - *A Framework for the Event-Triggered Stabilization of Nonlinear Systems*. International Journal of Robotics Research, 33(7):1006-1028, 2015.
- [78] B. FAVERJON and P. TOURNASSOUD - *A Local Based Approach for Path Planning of Manipulators with a High Number of Degrees of Freedom*. Robotics and Automation. Proceedings. 1987 IEEE International Conference on, volume 4, p. 1152-1159, Mar 1987.
- [79] O. KANOUN, F. LAMIRAUX, P. B. WIEBER, F. KANEHIRO, E. YOSHIDA, and J. P. LAUMOND. *Prioritizing Linear Equality and Inequality Systems: Application to Local Motion Planning for Redundant Robots*. Robotics and Automation, 2009. ICRA'09. IEEE International Conference on, p. 2939-2944, May 2009.
- [80] D. A. C. NARCISO, V. DUA, and E. N. PISTIKOPOULOS - *Multiparametric Mixed-Integer Quadratic and Nonlinear Programming*. Wiley-VCH Verlag GmbH Co. KGaA, p. 73-97, 2007.
- [81] R. LOBER, V. PADOIS, and O. SIGAUD - *Multiple Task Optimization Using Dynamical Movement Primitives for Whole-Body Reactive Control*. 2014 IEEE-RAS International Conference on Humanoid Robots, p. 193198, Nov 2014.
- [82] R. LOBER, V. PADOIS, and O. SIGAUD - *Variance Modulated Task Prioritization in Whole-Body Control*. Intelligent Robots and Systems (IROS), 2015 IEEE/RSJ International Conference on, p. 3944-3949, Sept 2015.
- [83] M. MORARI and J. H. LEE - *Model Predictive Control: Past, Present and Future*. Computers Chemical Engineering, 23(45):667-682, 1999.
- [84] E. C. KERRIGAN, A. BEMPORAD, D. MIGNONE, M. MORARI, and J. M. MACIEJOWSKI - *Multi-Objective Prioritisation and Reconfiguration for the Control of Constrained Hybrid Systems*. American Control Conference, 2000. Proceedings of the 2000, vol.3, p. 1694-1698, 2000.
- [85] M. BRAND, V. SHILPIEKANDULA, C. YAO, and S. A. BORTOFF - *A Parallel Quadratic Programming Algorithm for Model Predictive Control*. World Congress of the International Federation of Automatic Control (IFAC), June 2011.
- [86] M. SANFOURCHE, J. DELAUNE, G. LE BESNERAIS, H. DE PLINVAL, J. ISRAEL, P.-H. CORNIC, A. TREIL, Y. WATANABE, and A. PLYER - *Perception for UAV: Vision-Based Navigation and Environment Modeling*. AerospaceLab Journal, 4, 2012.
- [87] S. BERTRAND, J. MARZAT, H. PIET-LAHANIER, A. KHAN, and Y. ROCHEFORD - *Model Predictive Control Strategies for Cooperative Guidance of Autonomous Vehicles*. Aerospace Lab Journal, 8, 2014.
- [88] Y. ROCHEFORT, H. PIET-LAHANIER, S. BERTRAND, D. BEAUVOIS, and D. DUMUR - *Model Predictive Control of Cooperative Vehicles Using Systematic Search Approach*. Control Engineering Practice, 32:204-217, 2014.
- [89] J. MARZAT, H. PIET LAHANIER, and A. KAHN - *Cooperative Guidance of Lego Mindstorms NXT Mobile Robots*. 11th International Conference on Informatics in Control, Automation and Robotics (ICINCO 2014), pages 667 - 682, 2014.
- [90] H. ROGGEMAN, J. MARZAT, M. SANFOURCHE, and A. PLYER - *Embedded Vision-Based Localization and Model Predictive Control for Autonomous Exploration*. IROS Workshop on Visual Control of Mobile Robots (ViCoMoR 2014), Chicago, 2014.
- [91] P. D. CHRISTOFIDES, R. SCATTOLINI, D. MUOZ DE LA PEA, and J. LIU - *Distributed Model Predictive Control: a Tutorial Review and Future Research Directions*. Computers Chemical Engineering, 51:21-41, 2013. {CPC} {VIII}.
- [92] W. REN and R. BEARD - *Distributed Consensus in Multi-Vehicle Cooperative Control : Theory and Applications*. Springer-Verlag London, 2008.
- [93] G. LAFFERRIERE, A. WILLIAMS, J. CAUGHMAN, and J. J. P. VEERMAN - *Decentralized Control of VehicleFormations*. Systems Control Letters, 54(9):899-910, 2005.
- [94] C. C. CHEAH, S. P. HOU, and J. J. E. SLOTINE - *Region-Based Shape Control for a Swarm of Robots*. Automatica, 45(10):2406-2411, 2009.
- [95] C. FORSTER, S. LYNEN, L. KNEIP, and D. SCARAMUZZA - *Collaborative Monocular Slam with Multiple Micro Aerial Vehicles*. 2013 IEEE/RSJ International Conference on Intelligent Robots and Systems, p. 3962-3970, Nov 2013.

- [96] G. BRESSON, R. AUFRRE, and R. CHAPUIS - *Consistent Multi-Robot Decentralized Slam with Unknown Initial Positions*. Information Fusion (FUSION), 2013 16th International Conference on, p. 372-379, July 2013.
- [97] I. V. MELNYK, J. A. HESCH, and S. I. ROUMELIOTIS - *Cooperative Vision-Aided Inertial Navigation Using Overlapping Views*. Robotics and Automation (ICRA), 2012 IEEE International Conference on, p. 936-943, May 2012.
- [98] M. W. ACHELTIK, S. WEISS, M. CHLI, F. DELLAERTY, and R. SIEGWART - *Collaborative stereo*. 2011 IEEE/RSJ International Conference on Intelligent Robots and Systems, p. 2242-2248, Sept 2011.
- [99] N. PIASCO, J. MARZAT, and M. SANFOURCHE. *Collaborative Localization and Formation Flying Using Distributed Stereo-Vision*. 2016 IEEE International Conference on Robotics and Automation (ICRA), p. 1202-1207, May 2016.
- [100] D. ZOU and P. TAN. *Coslam: Collaborative Visual Slam in Dynamic Environments*. IEEE Transactions on Pattern Analysis and Machine Intelligence, 35(2):354-366, Feb 2013.
- [101] A. N. VENKAT - *Distributed Model Predictive Control: Theory and Applications*. PhD Thesis University of Wisconsin Madison, June 2006.
- [102] A. IBANEZ - *Emergence of Complex Behaviors from Coordinated Predictive Control in Humanoid Robotics*. PhD Thesis University Pierre and Marie Curie, Paris, France, 2015.
- [103] M. D. DOAN, T. KEVICZKY, and B. DE SCHUTTER - *A Dual Decomposition-Based Optimization Method with Guaranteed Primal Feasibility for Hierarchical MPC Problems*. 18th IFAC World Congress. IFAC Proceedings Volumes, 44(1):392-397, 2011.
- [104] M. BLANKE, M. STAROSWIECKI, and N. E. WU - *Concepts and Methods in Fault-Tolerant Control*. American Control Conference, 2001. Proceedings of the 2001, volume 4, p. 2606-2620, 2001.
- [105] D. CHILIN, J. LIU, J. F. DAVIS, and P. D. CHRISTOFIDES - *Data-Based Monitoring and Reconfiguration of a Distributed Model Predictive Control System*. Proceedings of the 2011 American Control Conference, p. 3158-3165, June 2011.
- [106] D. AXEHILL - *Applications of Integer Quadratic Programming in Control and Communication*. PhD thesis, Department of Electrical Engineering Linköping universitet, Sweden, 2005.
- [107] M. GHALLAB, D. NAU, and P. TRAVERSO - *Automated Planning: Theory and Practice*. Morgan Kaufmann, 2004.
- [108] C. PRALET and G. VERFAILLIE - *Dynamic Online Planning and Scheduling Using a Static Invariant-Based Evaluation Model*. Proceedings of the International Conference on Automated Planning Scheduling (ICAPS- 13), 2013.
- [109] P. BECHON, M. BARBIER, G. INFANTES, C. LESIRE, and V. VIDAL - *HiPOP: Hierarchical Partial-Order Planning*. Proc. of STAIRS-14, 2014.
- [110] V. VIDAL and H. GEFFNER. *Branching and Pruning: an Optimal Temporal POCL Planner Based On Constraint Programming*. Artificial Intelligence, 170(3):298-335, 2006.
- [111] S. CHIEN, R. KNIGHT, A. STECHERT, R. SHERWOOD, and G. RABIDEAU - *Using Iterative Repair to Improve the Responsiveness of Planning and Scheduling*. 2000.
- [112] T. SCHOUWENAARS - *Safe Trajectory Planning of Autonomous Vehicles*. PhD Thesis Department of Aeronautics and Astronautics, Katholieke Universiteit Leuven, 2001.
- [113] A. IBANEZ, P. BIDAUD, and V. PADOIS - *Emergence of Humanoid Walking Behaviors from Mixed-Integer Model Predictive Control*. 2014 IEEE/RSJ International Conference on Intelligent Robots and Systems, p. 40144021, Sept 2014.
- [114] B. HOMMEL, J. MSSELER, G. ASCHERSLEBEN, and W. PRINZ. *The Theory of Event Coding (Tec): a Framework for Perception and Action Planning*. Behavioral and Brain Sciences, 24(5):849-878.
- [115] A. G. RICHARDS - *Robust Constrained Model Predictive Control*. PhD Thesis Department of Aeronautics and Astronautics, Massachusetts Institute of Technology, 2005.
- [116] P. BECHON, M. BARBIER, C. LESIRE, G. INFANTES, and V. VIDAL - *Using Hybrid Planning for Plan Reparation*. Proc. of ECMR-15 (European Conference on Mobile Robots), 2015.
- [117] C. PRALET, G. INFANTES, and G. VERFAILLIE - *Application Showcase: a Generic Constraint-Based Local Search Library for the Management of an Electromagnetic Surveillance Space Mission*. Proc. of the ICAPS-13 Application showcase, 2013.
- [118] C. PONZONI CARVALHO CHANEL, C. LESIRE, and F. TEICHTIL-KONIGSBUCH - *A Robotic Execution Framework for Online Probabilistic (Re)Planning*. Proc. of the 24th International Conference on Automated Planning and Scheduling (ICAPS-14), 2014.
- [119] C. PRALET and C. LESIRE - *Deployment of Mobile Wireless Sensor Networks for Crisis Management: a Constraint-Based Local Search Approach*. 20th International Conference on Principles and Practice of Constraint Programming (CP-14), 2014.
- [120] M. PINEDO - *Scheduling: Theory, Algorithms, and Systems*. Springer, 2012.
- [121] F. ROSSI - *Handbook of Constraint Programming*. Elsevier, 2006.
- [122] M. PUTERMAN - *Markov Decision Processes, Discrete Stochastic Dynamic Programming*. John Wiley & Sons, 1994.
- [123] P. MORRIS, N. MUSCETTOLA, and T. VIDAL - *Dynamic Control of Plans with Temporal Uncertainty*. 2001.
- [124] K. EROL, J. HENDLER, and D. S. NAU. *HTN Planning: Complexity and Expressivity*. Proc. of the 12th National Conference on Artificial Intelligence (AAAI-94), 1994.
- [125] M. FOX, A. GEREVINI, D. LONG, and I. SERINA - *Plan Stability: Replanning Versus Plan Repair*. Proceedings of The International Conference on Automated Planning Scheduling (ICAPS-06), 2006.
- [126] S. LEMAI and F. INGRAND - *Interleaving temporal planning and execution in robotics domains*. AAAI'04 Proceedings of the 19th national conference on Artificial intelligence (AAAI04P), pages 617-622, 2004.
- [127] G. CASANOVA, C. PRALET, C. LESIRE, and T. VIDAL - *Solving Dynamic Controllability Problem of Multi-Agent Plans with Uncertainty Using Mixed Integer Linear Programming*. Proc. of the 22nd European Conference on Artificial Intelligence (ECAI-16), 2016.
- [128] A. MAILLARD, C. PRALET, J. JAUBERT, I. SEBBAG, F. FONTANARI, and J. L'HERMITTE - *Ground and Bboard Decision-Making on Data Downloads*. 25th International Conference on Automated Planning and Scheduling (ICAPS-15), 2015.
- [129] P. VAN HENTENRYCK and L. MICHEL - *Constraint-Based Local Search*. The MIT Press, 2005.
- [130] P. VAN HENTENRYCK and R. BENT - *Online Stochastic Combinatorial Optimization*. MIT Press, 2006.
- [131] A. KAHN, J. MARZAT, H. PIET-LAHANIER, and M. KIEFFER - *Cooperative Estimation and Fleet Reconfiguration for Multi-Agent Systems*. 3rd IFAC Workshop on Multi-Vehicle Systems, IFAC Proceedings Volumes, 48(5):11 - 16, 2015.

Acronyms

| | |
|---------|---|
| CML | (Concurrent Mapping and Localization) |
| CoSLAM | (Collaborative SLAM) |
| DMPC | (Distributed MPC) |
| FTC | (Fault-Tolerant Control) |
| GPS | (Global Positioning System) |
| GPU | (Graphics Processing Unit) |
| HQP | (Hierarchical Quadratic Programming) |
| HTN | (Hierarchical Task Networks) |
| INS | (Inertial Navigation System) |
| IQC | (Integral Quadratic Constraints) |
| LFT | (Linear Fractional Transformation) |
| LMI | (Linear Matrix Inequality) |
| LTI | (Linear Time Invariant) |
| LTV | (Linear Time Varying) |
| MILP | (Mixed Integer Linear Programming) |
| MIQP | (Mixed Integer Quadratic Programming) |
| MLD | (Mixed Logical Dynamical) |
| MPC | (Model Predictive Control) |
| mp-MILP | (multi-parametric Mixed Integer Quadratic Programming) |
| MRAW | (Model Recovery Anti Windup) |
| OIST | (Output to Input Saturation Transformation) |
| OISTeR | (Output to Input Saturation Transformation extended for Robustness) |
| PD | (Proportional-Derivative) |
| PWA | (Piecewise Affine) |
| PWL | (Piecewise Linear) |
| QP | (Quadratic Programming) |
| SIMD | (Single Instruction, Multiple Data) |
| SLAM | (Simultaneous Localization And Mapping) |
| TEC | (Theory of Event Coding) |
| UAV | (Unmanned Aerial Vehicle) |

AUTHORS



Philippe Bidaud received his PhD in Robotics in 1984 and he was recruited as a CNRS researcher in 1985. He began his career at the Laboratory of Mechanics and Robotics at the Pierre and Marie Curie University in Paris. He subsequently directed several research groups at Robotics Laboratory of Paris. Meanwhile. In 1998, he was hired as a professor at the University Pierre and Marie Curie. He became deputy director of the Robotics Laboratory of Paris in 1999 and then director in 2002 before creating the Institute of Intelligent Systems and Robotics which he provided leadership until 2013. Today Philippe Bidaud is Scientific Director for Information Technologies and Sciences at ONERA. For several years now, his research activities focuses design and control complex robotics systems specifically all-terrain robot, dextrous manipulation systems, humanoid robotics, interactive robotics systems and more recently space robotics. All of his work is the subject of more than 230 publications in journals and international conferences and a dozen of patents.



Laurent Burlion graduated from the French engineering school Ensietia (now Ensta Bretagne) in 2003 and received the same year the M.Sc. degree in Control at the IRRCyN in Nantes. Dr. Burlion received his Ph.D degree from the University of Paris Sud in 2007. He was a control Engineer with the Laboratoire de Recherches Balistiques et Aerodynamiques from 2003 to 2010. Since 2010, he has been working as a research scientist at the French Aerospace Lab (ONERA). His current research interests are focused on the problems of input saturations and output constraints with application to UAVs and satellites.



Henry de Plinval graduated from Ecole Polytechnique, France, in 2006 and received his M.Sc. in Aeronautics and Astronautics in 2006 from MIT (USA) and his Ph.D in automatic control from the University of Toulouse in 2014. Since 2008, he is working with ONERA. His areas of interest include guidance, navigation and control, mostly for UAVs, with a particular focus on visual servoing for VTOL UAVs. Since 2015, he is the UAVs Program Director at ONERA, covering the related activities in the areas of automatic control, artificial intelligence, fluid mechanics, optronics, radar, telecommunications, ...



Thomas Loquen is researcher with ONERA, Information Processing and Systems Department (DTIS). In 2006, he completed his Engineering degree and M.Sc in Electrical engineering and Automatics from INPT-ENSEEIH. In 2010, he completed his Ph.D. degree in Control Systems within the INP-Toulouse, by working on stability analysis of hybrid systems. His main interests concern hybrid dynamical systems (modelling, robust analysis) and embedded systems (joint works with computer science researchers of ONERA).



Julien Marzat graduated as an engineer from ENSEM (INPL Nancy) in 2008 and completed his PhD Thesis from University Paris Sud XI in 2011. Since then, he has been working as a Researcher at ONERA. His research interests include guidance, control, estimation and fault diagnosis with application to autonomous vehicles and aerial robotics.



Cédric Pralet graduated from SUPAERO (French engineering school in aeronautics and space) in 2003. He passed his PhD in Computer Science in Toulouse in 2006. He is now working as a research engineer at ONERA. His research interests concern constraint-based combinatorial optimization and automated planning and scheduling. His research activities are applied to space and aeronautics.