



HAL
open science

Ion hydration number and electroosmosis during electrodialysis of mixed salt solution

Le Han, Sylvain Galier, H el ene Roux De-Balmann

► **To cite this version:**

Le Han, Sylvain Galier, H el ene Roux De-Balmann. Ion hydration number and electroosmosis during electrodialysis of mixed salt solution. *Desalination*, 2015, 373, pp.38-46. 10.1016/j.desal.2015.06.023 . hal-01512566

HAL Id: hal-01512566

<https://hal.science/hal-01512566>

Submitted on 24 Apr 2017

HAL is a multi-disciplinary open access archive for the deposit and dissemination of scientific research documents, whether they are published or not. The documents may come from teaching and research institutions in France or abroad, or from public or private research centers.

L'archive ouverte pluridisciplinaire **HAL**, est destin ee au d ep ot et  a la diffusion de documents scientifiques de niveau recherche, publi es ou non,  emanant des  tablissements d'enseignement et de recherche fran ais ou  trangers, des laboratoires publics ou priv es.



Open Archive Toulouse Archive Ouverte (OATAO)

OATAO is an open access repository that collects the work of Toulouse researchers and makes it freely available over the web where possible.

This is an author-deposited version published in: <http://oatao.univ-toulouse.fr/>
Eprints ID: 17747

To link to this article : DOI:10.1016/j.desal.2015.06.023

URL : <http://dx.doi.org/10.1016/j.desal.2015.06.023>

To cite this version: Han, Le and Galier, Sylvain and Roux-de Balmann, H el ene
Ion hydration number and electroosmosis during electro dialysis of mixed salt solution. (2015) Desalination, vol. 373. pp. 38-46. ISSN 0011-9164

Any correspondence concerning this service should be sent to the repository administrator:
staff-oatao@listes-diff.inp-toulouse.fr

Ion hydration number and electro-osmosis during electrodialysis of mixed salt solution

Le Han, Sylvain Galier, H el ene Roux-de Balmann *

Universit e de Toulouse, INPT, UPS, Laboratoire de G enie Chimique, F-31062 Toulouse cedex 09, France
CNRS, Laboratoire de G enie Chimique, F-31062 Toulouse cedex 09, France

ABSTRACT

Water transfer is an important aspect to be considered in electrodialysis since it fixes the performances of the process. It is due to electro-osmosis, i.e. the water carried by the migrating species and is thus related to their hydration. Few results were reported about the hydration number of solutes transferring through ion-exchange membranes. In this work, a methodology is proposed to calculate the hydration numbers of ions transferring through ion exchange membranes during electrodialysis. It is based on the experimental measurements of ion and water transfer under different conditions, like salt compositions and current. Salt hydration is first obtained, and then the hydration numbers of 4 transferring ions (Na^+ , Mg^{2+} , Cl^- , SO_4^{2-}) are calculated simultaneously. It is shown that these hydration numbers are constant, independent from the salt composition and current. The hydration number for monovalent ions is found to be lower than that of divalent ones, which is in agreement with the values of the hydration free energy. Further comparison with the reported values concerning the hydration of the same ions in solution shows that for monovalent ions the hydration numbers are close to those reported for the 1st hydration shell while much higher values are obtained for divalent ions.

1. Introduction

Electrodialysis (ED) is an electrochemical separation process based on the selective transport of ions from one solution to another through ion-exchange membranes (IEM) under the driving force of an electrochemical potential gradient [1]. It has been extensively used to produce concentrated brines or salt depleted waters for industrial or domestic purposes, such as to produce potable water from sea water since several decades. But water desalination is not the only application. Stimulated by the development of IEM with better selectivity, lower electrical resistance, and improved thermal, chemical, and mechanical properties, other uses of ED, especially in food, beverage, drug and chemical process industry as well as in biotechnology and wastewater treatment, have gained a broader interest [2-6].

It is noteworthy that the mass transport through the membrane is the key part of ED process determining to a very large extent its efficiency. For the sake of current/energy efficiency, the current is supposed to transfer only the target charged species. However, the ion transfer is always associated with a water transfer that results from a kinetic coupling with the ion fluxes under current, referred as electro-osmosis [1]. Thus, this electro-osmotic flux can restrict the process efficiency and its control is thus a key point.

As an example, to scale-up desalination units, the water recovery and energy consumption are the main concerns to be taken into account [7,8]. Moreover, the water transfer may limit the application of ED as a concentration process in different application fields [9,10]. For example, in case of coarse salt production from brine, it is crucial to limit the water transfer through the membrane to avoid the dilution of the final brine solution [11]. Likewise, when ED is to be used as a concentration step in the production of organic acid from fermentation, it was reported that the maximum achievable concentration of organic acid salt is directly limited by such electro-osmotic flux [12]. Thus, water transfer

is an important aspect to be considered in ED process with respect to various uses.

As aforementioned, the water transfer due to electro-osmosis and salt transfer are directly linked in ED. The amount of water accompanying the ions migration is linked to the hydration number of the ions transferring through the membranes during the ED process [7,12,13]. Then, knowing the hydration numbers enables predicting the water transfer and so the performance of ED.

Many values can be found in the literature concerning the hydration numbers of different ions in aqueous solution but these values can differ from each other [14,15]. On the other hand, very few concern the hydration number of solutes during their transfer through membranes, like those used in ED. The determination of the hydration numbers of ions transferring through a membrane is difficult and requires a specific procedure. For example ion-H₂O-(2H)₂O system [16] or complex computational approach [17] were reported. In fact, knowing both the salt and the water flux in the system, it is possible to determine the salt hydration number. But a proper dissociation of the salt hydration is further necessary to get the individual contributions of the ions and this is still problematic [10,13,18,19]. Some simplifications can be made to split the total water transfer like for instance to assume that the ions have the same hydration numbers [10]. Finally, the few studies reported mainly focus on single electrolyte (NaCl) while in practice the solutions treated in ED can be much more complex, probably with multi-components and sometimes not only mixed inorganic salts but also organic matter.

Then, the objective of this paper is to investigate the hydration number of ions transferring through IEM in ED process, since it is a key parameter with respect to the process performance. Experiments will be carried out with different mixtures of salts including Na⁺, Mg²⁺, Cl⁻, and SO₄²⁻. Based on the determination of the ions and water flux through the membranes, the hydration numbers of the salts and of the 4 individual ions will be calculated simultaneously. The values will be compared with those obtained from the literature in order to check the methodology and to determine the influence of the membrane on the ion hydration.

2. Theory

2.1. Mass transfer phenomena

2.1.1. Salt transfer

In ED process, the salt flux, j_s (mol·m⁻²·s⁻¹), is the sum of two contributions. The first one is a flux coupled with the chemical potential gradient, i.e. a diffusion flux, j_s^{diff} , due to the difference of solute's concentration across the membrane and with the direction towards the compartment of decreasing concentration. The other one is the flux coupled with the electrical current, i.e. the migration flux, j_s^{mig} due to the electrical potential gradient [1]. Then the salt transfer is expressed by the following Eq. (1):

$$j_s = j_s^{diff} + j_s^{mig} \quad (1)$$

Previous experimental results have shown that in most of the ED conditions, the diffusion contribution can be neglected compared to that of migration [5,12]. Furthermore, it was demonstrated that the migration flux is proportional to the current, so that the following equation was obtained for the flux by phenomenological approach as Eq. (2),

$$j_s \approx j_s^{mig} = \alpha I \quad (2)$$

using α (mol·m⁻²·s⁻¹·A⁻¹) as the current coefficient.

2.1.2. Water transfer

The volumetric flux, j_v (m³·m⁻²·s⁻¹), can be obtained from the volume variation in the compartments during ED. It should be noted that this flux includes the volume contribution of both water and ion transferred, as shown in Eq. (3):

$$j_v = j_w + \sum_i j_v^i \quad (3)$$

The total ionic volume contribution $\sum_i j_v^i$ can be calculated according to Eq. (4):

$$\sum_i j_v^i = \sum_i \frac{j_i}{z_i} \times V_m^i \quad (4)$$

with j_i (eq·m⁻²·s⁻¹) the ionic flux, V_m^i the molar volume of the ion (m³·mol⁻¹) and z_i the valence of the ion (eq·mol⁻¹).

In most ED conditions, like those in this study, the ionic volume contribution is negligible compared to that of water (lesser than 7% of the total volume flux). Therefore, the volume flux can be considered as a water flux, as represented in Eq. (5).

$$j_v \approx j_w \quad (5)$$

As previously described for the ionic flux, the water transfer in ED is the result of two contributions, osmosis (j_w^{os}) and electro-osmosis (j_w^{eo}), as expressed in the following equation:

$$j_w = j_w^{os} + j_w^{eo} \quad (6)$$

where the osmotic flux is due to the chemical potential gradient across the membrane, while the electro-osmotic flux is due to the water transfer coupling the ion migration through the membrane [1].

Usually in ED, when an electric current is applied, the water flux due to osmosis can be neglected compared to that of electro-osmosis [5,7,11,12]. And owing to its link to the salt, this flux j_w^{eo} is also proportional to the current. By introducing an electro-osmotic coefficient, β (m³·m⁻²·s⁻¹·A⁻¹), the expression of the water transfer can be written as in Eq. (7):

$$j_w \approx j_w^{eo} = \beta I \quad (7)$$

2.2. Hydration number calculation

As discussed above, the water transfer (electro-osmotic flux) is linked to the salt transfer in ED. Then, one can calculate the salt hydration number (n_h^s), defined as the number of mole of water per mole of salt, knowing the simultaneous transfer of salt and the associated water, according to Eq. (8):

$$n_h^s = \frac{j_w/V_m^w}{j_s} \quad (8)$$

where V_m^w is the molar volume of water (m³·mol⁻¹).

Combining with Eqs. (2) and (7), this equation can be expressed as below:

$$n_h^s = \frac{\beta/V_m^w}{\alpha} \quad (9)$$

Therefore, the hydration number for each single electrolyte can be calculated from the experimental measurements of the salt and water flux. Indeed, this salt hydration number can be assumed as the total amount of water accompanying the cation and anion migration through the membranes. For any electrolyte like $C_{\vartheta_C}A_{\vartheta_A}$ (ϑ_C and ϑ_A being

Table 1
Ionic hydration number constraint for calculation.

n_h^i	Na ⁺	Mg ²⁺	Cl ⁻	SO ₄ ²⁻
Lower limit	0	0	0	0
Upper limit	$\max(n_h^{\text{NaCl}}, n_h^{\text{Na}_2\text{SO}_4})$	$\max(n_h^{\text{MgCl}_2}, n_h^{\text{MgSO}_4})$	$\max(n_h^{\text{NaCl}}, n_h^{\text{MgCl}_2})$	$\max(n_h^{\text{Na}_2\text{SO}_4}, n_h^{\text{MgSO}_4})$

the stoichiometric coefficients for cation and anion, respectively), the following relation can be drawn:

$$n_h^{S(C_c A_a)} = \vartheta_C n_h^C + \vartheta_A n_h^A \quad (10)$$

where n_h^C and n_h^A are the hydration numbers for cation and anion, respectively. But in order to solve Eq. (10) to get the individual hydration numbers of cation and anion, an additional equation is necessary.

In general, one can calculate the hydration number of a transferring ion, n_h^i , as:

$$n_h^i = \frac{m_w^i}{m_i} \quad (11)$$

where m_i (mol) and m_w^i (mol) are the number of moles of ion and water transferred through the membrane.

Assuming that the ion hydration number remains constant over time, this equation can be further expressed as:

$$n_h^i = \frac{m_w^i(t)}{m_i(t)} \quad (12)$$

where the values $m_i(t)$, $m_w^i(t)$ are the transferred quantities (in mole) for ion and water respectively, from initial beginning of ED until the time t .

However, as previously explained, it is not possible to get the individual values of the water transfer corresponding to each ion, $m_w^i(t)$, versus time, but only the total amount of water transferred, $m_w(t)$, deduced from the variation of the volume, which can be expressed by Eq. (13):

$$m_w(t) = \sum_i m_w^i(t) \quad (13)$$

Thus, combining Eqs. (12) and (13), one can obtain Eq. (14):

$$m_w(t) = \sum_i n_h^i \times m_i(t) \quad (14)$$

The ion hydration numbers are obtained by fitting the value of the water transfer as obtained by Eq. (14) knowing the experimental values of the ion transfer m_i for each ion with that obtained experimentally. The least square method is used for that fitting. The ionic hydration numbers are assumed to be constant, regardless of the ion concentration and composition in mixtures. This assumption will be further checked.

This theoretical water transfer can be written as a matrix considering the 4 ions (Na⁺, Mg²⁺, Cl⁻, SO₄²⁻) used in this study, as seen in Eq. (15):

$$(m_w) = \begin{pmatrix} m_{Na} & m_{Mg} & m_{Cl} & m_{SO_4} \end{pmatrix} \times \begin{pmatrix} n_h^{Na} \\ n_h^{Mg} \\ n_h^{Cl} \\ n_h^{SO_4} \end{pmatrix} \quad (15)$$

Table 2
Calculation assumptions.

Negligible ionic volume	Cumulative volume/hydration	Constant n_h^i
$j_v \approx j_w$	$m_w = \sum_i m_w^i(t)$	$n_h^i = \text{constant}$
	$n_h^{S(C_c A_a)} = \vartheta_C n_h^C + \vartheta_A n_h^A$	$0 \leq n_h^i \leq n_h^s$

The experimental results corresponding to the different salt compositions offer a database for ion and water transfer at each time t during the ED, and thus the 4 ion hydration numbers can be solved simultaneously.

In addition, to solve the matrix and ensure the calculated result reasonable, a constraint, i.e. upper and lower limits, of hydration numbers for the 4 ions is required.

In this study, we are dealing with hydration number during ion's migration through IEM. Then, on the one hand, the lower limit corresponds to the case where the ion sheds its waters of hydration, upon sorbing into the polymer, in favor of possible interactions with the polymer matrix [20,21]. Thus, a value of zero, corresponding to an unhydrated ion, may be regarded as the lower limit. On the other hand, the upper limit can be considered to be that obtained for the salt hydration number as determined from single electrolyte solutions, since the individual value of an ion, n_h^i , cannot exceed the value of the salt hydration number n_h^s based on Eq. (10).

Therefore, the constraint for ionic hydration number is seen in Table 1.

As shown in Table 1, the constraint of hydration number is with the lower limit as 0, and the upper limit as the higher value of two salt hydration numbers n_h^s involving the same ion (e.g. $n_h^{Na} \leq \max(n_h^{\text{NaCl}}, n_h^{\text{Na}_2\text{SO}_4})$), which needs further estimation. This constraint is the input parameter to the experimental database for hydration number calculation.

To sum up, the assumptions used for the calculation of the ion hydration numbers in this study are listed in Table 2.

Hydration number is assumed as cumulative. Ionic hydration number is considered to be not affected by using different current intensities and salt composition as well as concentration.

3. Materials and methods

3.1. ED set-up

The ED experiments were performed with EUR 2B-10 stack (Eurodia, France). The ED stack comprised 10 cells of Neosepta anion-exchange membrane AMX and cation-exchange membrane CMX, from Tokuyama Corp, Japan. For each type of membrane, the total effective area was 0.2 m², i.e. 0.02 m² per cell. The principal properties of these membranes AMX and CMX are listed in Table 3.

Then, the ED set-up used in this study is depicted in Fig. 1.

The experiments were carried out in batch mode (complete recycling of diluate, concentrate and electrode solutions). Three centrifugal pumps were used to circulate these solutions, and flow meters were used to set the flow rates. The feed flow rates were set at constant values of 180 L·h⁻¹ for the diluate and concentrate, and 360 L·h⁻¹ for

Table 3
Principal properties of ion-exchange membranes.

Membrane property	AMX	CMX
Exchange capacity (meq·g ⁻¹)	1.4–1.7	1.5–1.8
Specific resistance (Ω·cm ⁻¹)	2.0–3.5	2.0–3.5
Permselectivity (%)	0.98	0.98
Water content (%)	25–30 [22]	25–30 [23]
pH	0–12	0–12
Functional group	Ammonium quaternary	Sulfonic acid
Thickness (mm)	0.16–0.18	0.17–0.19
Cross linker	Divinyl benzene	Divinyl benzene

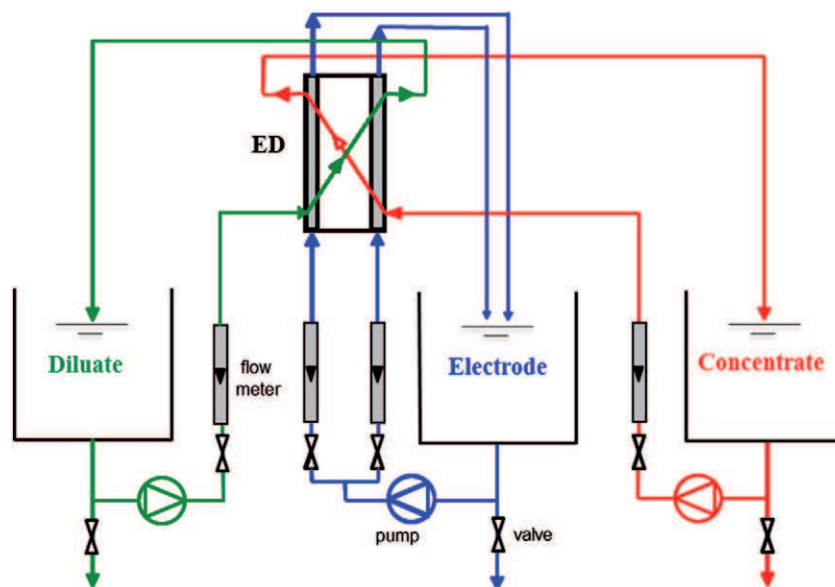

Fig. 1. Schematic diagram of the electro dialysis set-up.

the electrode solution. All the experiments were carried out at constant temperature 25 ± 1 °C. The experiment duration was determined according to the conductivity of the diluate. Experiments were stopped once that conductivity reached about $5 \text{ mS}\cdot\text{cm}^{-1}$ in order to have current lower than the limiting current for any set of experiments.

Experiments were performed at a constant current, in the range of 0–6 A ($0\text{--}300 \text{ A}\cdot\text{m}^{-2}$), with solution conductivities, temperature, pH and voltage measured in real time. The solutes concentration and the volume were determined in both compartments as function of time.

Different sets of experiments were carried out, with each one corresponding to a given electrolyte solution (S1 to S10 in Table 4). For each experiment set, the membranes were first soaked in 4 L of the electrolyte solution by running the set-up for about 4 h at a flow rate of $180 \text{ L}\cdot\text{h}^{-1}$ and then stopping at least 10 h without circulation. This soaking solution was exactly the same electrolytic solution as that used in ED. Since the quantity of ions in these solutions is about 40 times higher than the total ion-exchange capacity of AMX and CMX membranes in the ED stack, one can consider that this procedure ensures a complete exchange of the membrane counter ion, thus a fully equilibrated IEM.

3.2. Salts and ions

Four different electrolytes were selected and used in the ED experiments, making salt solutions of single electrolyte and mixed ones (2 or 3 electrolytes) as shown in Table 4.

Ten solutions of different compositions were prepared according to Table 4, namely S1–S10. The total salt concentration in this study was fixed at $1 \text{ eq}\cdot\text{L}^{-1}$ except for S10 ($0.87 \text{ eq}\cdot\text{L}^{-1}$). Single salt solutions (solution S1–S4) were used for the determination of the salt hydration number. Mixed salt solutions (solution S5–S9) were used to calculate the individual ion hydration numbers. Finally, S10 was an artificial

seawater reverse osmosis concentrate (SROC), prepared according to the standard method (ASTM D 1141–86) for artificial sea water preparation.

Both concentrate and diluate compartments were initially fed with 2 L of salt solution at the given composition. The electrode compartment was initially fed with 3 L of a Na_2SO_4 solution at $10 \text{ g}\cdot\text{L}^{-1}$. All the salts (Acros Organics) were dissolved in RO water (resistivity $>1 \text{ M}\Omega\cdot\text{cm}$, Elga, France) to get the proper solution composition.

3.3. Analytical and computational methods

For single electrolyte, the salt/ion concentration was determined from conductivity measurements, using a conductivity meter (HI933100, Hanna Instruments). For mixed electrolyte solutions (containing more than two ions) the concentrations of ions were determined by ionic chromatography. Ion chromatography system (ICS-3000, Dionex, France) was using an ionPac column, equipped with an auto sampler AS50 and conductivity detector CD20. The injection volume was $25 \mu\text{L}$ and the temperature was set at 30 °C. Samples were diluted to a maximum of 1000-folds by ultra-pure water (resistivity $>18 \text{ M}\Omega\cdot\text{cm}$, Elga, France) before analysis.

In this study, the mass balance for water and ions was checked, knowing the variation of the volume and concentrations in the 2 compartments. The maximum deviation was less than 2% for volume and 5% for salt/ions.

The fitted values of the hydration numbers were obtained using an open access software Rstudio (RStudio Inc, Version 3.0), based on a nonlinear regression method.

4. Results and discussions

4.1. Hydration number of salts

An example of the variations of the salt and water quantities transferred versus time in the case of single electrolyte is shown in Fig. 2 for different current intensities.

Fig. 2 shows a simultaneous increase of both salt (a) and water (b) quantities transferred versus time from the diluate to the concentrate compartment. And according to mass balance, a decrease trend of salt and water quantities in diluate compartment was found.

One can also observe in Fig. 2 that the transfer increases with the current intensity (2–6 A). For each current, there is a linear variation

Table 4
Composition and concentration of the salt solutions used in ED experiments.

Salt	Single salts ($\text{eq}\cdot\text{L}^{-1}$)				Mixed salts ($\text{eq}\cdot\text{L}^{-1}$)					
	S1	S2	S3	S4	S5	S6	S7	S8	S9	S10
NaCl	1				0.5	0.5			0.33	0.63
Na_2SO_4		1			0.5		0.5		0.33	0.08
MgCl_2			1			0.5		0.5	0.33	0.16
MgSO_4				1			0.5	0.5		

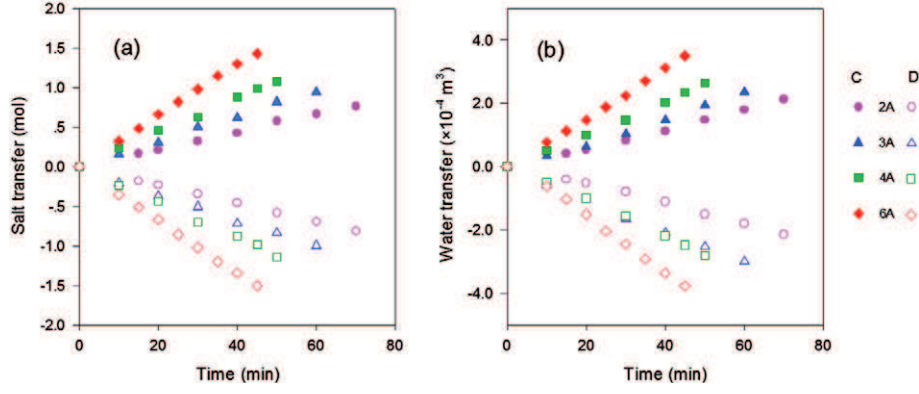

Fig. 2. Variation of the salt transfer (a) and water transfer (b) under different current intensities (2-6A) versus time, e.g. solution S1 (C for concentrate, D for diluate).

of the salt and water transfer over time, which is in agreement with previous results [5,11,12,24]. Then the corresponding slopes provide the salt and water flux densities, the values of which are plotted in Fig. 3 versus the current, with S1 as example.

Fig. 3 demonstrates that the flux densities for both salt and water are proportional to the current. This confirms that under current, migration and electro-osmosis fix the salt and water transfer respectively, i.e. that the contribution of diffusion to the salt flux as well as that of osmosis to the water flux are negligible [5].

Then, according to Eqs. (2) and (7), the aforementioned coefficients α and β can be estimated from the linear variation of the salt and water transfer versus current, based on the corresponding slope. The salt hydration number can also be calculated based on these two coefficients according to Eq. (9). The results obtained for the different salts are reported in Table 5.

The following trend for the salt hydration numbers of the 4 electrolytes is obtained:

$$n_h^{\text{NaCl}} < n_h^{\text{Na}_2\text{SO}_4} \approx n_h^{\text{MgSO}_4} < n_h^{\text{MgCl}_2}.$$

These results can be compared with the ones obtained from experimental studies previously reported in the literature. For instance, the hydration number of NaCl is found to be 14 in this study. This is close to the values of 11, 11.4 and 13 reported in comparable conditions [18,8,16].

However, much lower values like a hydration number as low as 5 were also reported but in different conditions [19,25]. This will be discussed later into more details. Concerning Na_2SO_4 , the value of 26.1 obtained in this work is very close to that, equal to 26, previously reported [18]. No value was reported for MgCl_2 . However, Mg^{2+} is known to be more hydrated than Ca^{2+} [15] and a value of 29 was reported for the hydration number of CaCl_2 [16]. Then the value of 31 obtained in the present work seems to be in agreement with the one that can be expected. Finally, one can conclude that the values obtained in the present work are in good agreement with the ones previously reported in comparable conditions.

Knowing the salt hydration number (n_h^s), the upper limit of the ion hydration number can be fixed, as previously explained (see Table 1). Then the range of values is reported in Table 6.

4.2. Hydration number of ions

The transfer of water and ions versus time obtained under different currents in mixed electrolytes (containing at least 3 different ions) is shown in Fig. 4, with solution S5 (NaCl - Na_2SO_4 case, 3 ions included) as example.

For any current, one can observe a linear increase of the water transferred versus time, as observed in the case of single electrolyte. The transfer of Na^+ varies also in a linear manner versus time. On the contrary, the transfer of the individual anions, Cl^- and SO_4^{2-} does not

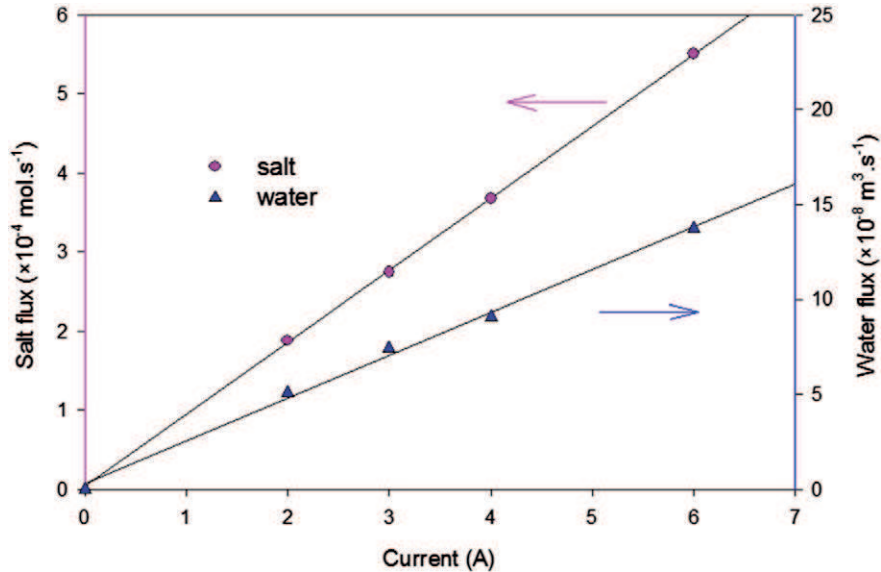

Fig. 3. Flux of salt and water versus current, e.g. solution S1.

Table 5Transfer coefficient of salt (α), water (β) and salt hydration number (n_h^i).

Salt	NaCl	Na ₂ SO ₄	MgCl ₂	MgSO ₄
α ($\times 10^{-4} \text{ mol} \cdot \text{m}^{-2} \cdot \text{s}^{-1} \cdot \text{A}^{-1}$)	4.60	2.38	2.46	2.93
β ($\times 10^{-7} \text{ m}^3 \cdot \text{m}^{-2} \cdot \text{s}^{-1} \cdot \text{A}^{-1}$)	1.16	1.12	1.36	1.37
n_h^i (mol water/mol salt)	14.0	26.1	30.8	26.0

follow a linear trend. A selectivity between the anions is thus emphasized, as already reported with the same membranes [26]. Finally, in this study, only the anion selectivity was observed (solution S5, S8, S9, S10) while there was no such phenomenon for cations (Na⁺ and Mg²⁺).

In fact, for the calculation of the ion hydration number, mass transfer data under 4 different currents in all these experiments are mixed as an overall database. One can arrange all these data as function of the electrical charge (i.e. the product of current with time, as quantity of coulomb given to ED stack) [9]. Fig. 5 illustrates these transfer variations versus the electrical charge.

Fig. 5(a) shows that the mass transfer data obtained under different currents are located on a single curve when plotted as function of the electrical charge, for Na⁺, Cl⁻ and SO₄²⁻ respectively. Likewise, in Fig. 5(b), one can observe that the water transfer is directly related to the electrical charge.

Moreover, it should be noted that although NaCl and Na₂SO₄ have variable composition ratio versus the electrical charge, because of the anion selectivity, and their hydration numbers are different (as seen in Table 5), no visible influence is observed on the water transfer once considering the electrical charge. Indeed, salt hydration numbers in Table 5 indicate that for an electrical driving charge of 1 equivalent, the number of moles for water transferred with NaCl is 14 while it is 13 (26/2) for Na₂SO₄.

Finally, following the method explained in Section 2.2, it is possible to get the values of the ion hydration numbers knowing the values of the water and ion transfer determined experimentally. The fitted values obtained for the 4 ions investigated are reported in Table 7.

The validation of the result is checked by comparing the calculated water transfer obtained according to Eq. (14) considering the hydration numbers reported in Table 7, with the experimental one. For any condition (S1–S9), the difference does not exceed 7%.

To further check the robustness of the method and the values of the hydration numbers, another solution, S10, with a different ionic

Table 6

Input ion hydration number constraint.

n_h^i	Na ⁺	Mg ²⁺	Cl ⁻	SO ₄ ²⁻
Constraint	0–27	0–31	0–31	0–27

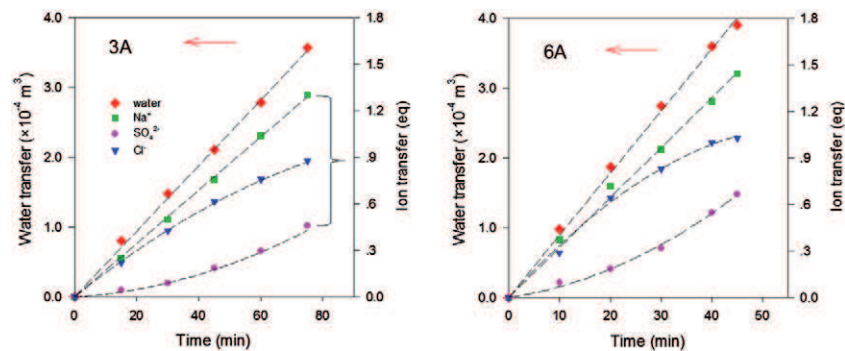
**Fig. 4.** Variation of the water and ion transfer versus time, e.g. solution S5 under current intensity 3A (left) and 6A (right).

composition is used. On the one hand, the experimental values of the ion and water transfer are plotted in Fig. 6(a) versus the electrical charge. On the other hand, the water transfer, m_w^{theo} , is calculated using the ion transfer and the values of the hydration numbers previously determined. The obtained values are reported in Fig. 6(b). One can observe that there is a good agreement between these calculated values and the experimental ones (relative difference ca. 3%).

It means that in the conditions of this study for a salt concentration up to 1 eq·L⁻¹, the hydration numbers of the individual ions do not change with the ionic composition or with the current intensity.

4.3. Discussion

It is further interesting to compare the ion hydration numbers obtained in this study with those reported in the literature. However, it is important to keep in mind that the literature values concern the hydration number of the ions in solution, while those obtained in this study are related to the ions transferring through the membranes. One can expect the hydration of the transferring ions to be lower than that in the solution.

Fig. 7 provides the values reported in the literature for the hydration number for each ion investigated in this work. More precisely, the plot shows the frequency distribution of the different values reported in the literature, concerning the 1st hydration shell, i.e. that in which the water molecules interact directly and strongly with the ion. The values of the hydration numbers obtained in this work are also indicated on the graph for comparison.

Fig. 7 shows a broad distribution of the reported values for each ion, 3 to 9 for Na⁺, 4 to 12 for Mg²⁺, 2 to 10 for Cl⁻ and 3 to 15 for SO₄²⁻. As already mentioned, this broad distribution comes from the different methods (experimental and computational ones based on various assumptions on the ion structure and water dynamic) used to get the hydration number [14,15]. Nevertheless, for any ion, the distribution shows a maximum, corresponding to the most frequently reported value. Then the hydration number for Na⁺ is about 6–7, a value similar to that for Mg²⁺ (6–7). For the anions, the hydration number of Cl⁻ is 6–9, while it is around 8 for SO₄²⁻.

The values obtained in this work can be further compared to the ones reported. For monovalent ions (Na⁺, Cl⁻), one can observe that the hydration number of the transferring ion obtained in this work is not only within the reported 1st shell distribution but also quite close to the most frequent value of the considered ion. On the contrary, the values obtained for divalent ions are higher than the most frequently reported values. In the case of SO₄²⁻ it is close to the highest value reported in the literature for the 1st hydration shell, about 15. For Mg²⁺ it is still higher, around 16 while the highest reported value is around 12.

Other ionic characteristics, like ion charge density and hydration free energy for instance, are also interesting to characterize the ion hydration. For instance, the hydration energy represents the strength of the bound between the ion and its surrounding water. Then it can probably

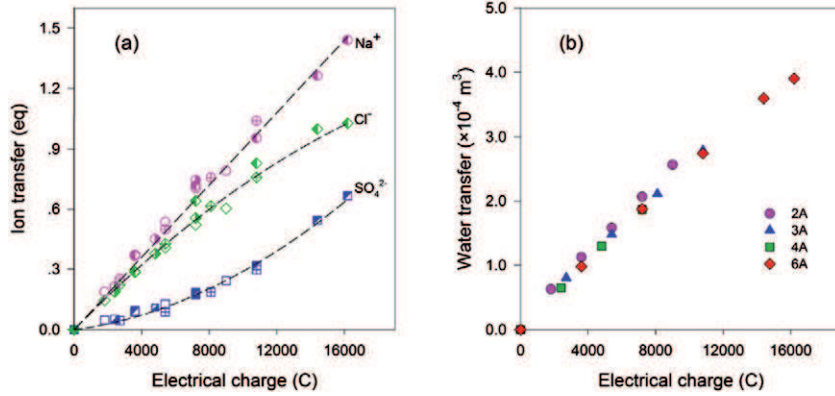

Fig. 5. Variation of the ion transfer (a) and water transfer (b) versus electrical charge, e.g. solution S5; symbol of different filling in (a) indicating under different current as 2A (blank), 3A (cross), 4A (right solid), 6A (left solid).

Table 7
Calculated values of the ion hydration number n_h^i .

Na ⁺	Mg ²⁺	Cl ⁻	SO ₄ ²⁻
6	15–16	8	13–14

be linked to the variation of the hydration number of the ion while transferring through the membrane [27,28]. The values are reported in Table 8 for the 4 ions considered in this study.

One can state that the hydration free energy of divalent ions, and thus the bonding strength of water and ion, is stronger compared to that of monovalent ones (3–5 times for anion and cation, respectively). In particular, the fact that Mg²⁺ has the highest value may also agree with its highest hydration energy among the considered ions.

Meanwhile, the fact that these transferring hydration numbers of monovalent ions approximate the values corresponding to the 1st hydration shell has to be pointed out. It means that in the conditions investigated, the water contained in the 1st hydration shell is transferred together with the ion through the membranes. But it also suggests that while transferring through the membranes, the ions are dehydrated, losing the water contained in their 2nd hydration shell. It is accepted that the 2nd shell's water molecules are weakly bonded and can more easily be reoriented and/or detached when ion is in motion, even in aqueous solution, compared with the 1st shell [15,29]. The very few data available regarding the 2nd hydration shell of ions can also be attributed to its weak strength and a consequently not well-defined hydration structure [14].

Concerning divalent ions, it is shown that the hydration number of the transferring ions is higher than the most frequent value corresponding to

the 1st hydration shell. Especially for Mg²⁺ the hydration number of the transferring ion is about 15–16, while the only reported value of hydration number of the 2nd hydration shell is about 12 [14], that of the first hydration shell ranging from 4 to 12 with the most frequent value about 6–7. Then, the results show that the Mg²⁺ transferring through the membrane carries more water than that comprised in its 1st hydration shell, i.e. also part of the water in its 2nd hydration shell.

These results show that the membranes used in this study have no significant influence on the hydration of the transferring ions, at least on their first hydration shell. It means that the water–ion interactions are dominant with respect to membrane–ion interactions. In fact, there is hypothesis that transfer through membrane depends on the comparison of ‘transport energy’ and the hydration energy that bonds the hydrated shell to the ion [30]. In ED, the ion migrates towards the membrane with current as driving force; the polymer matrix of the ion exchange membrane may interact with the ion and serve as barrier to the ion transfer. Thus, one can imagine that with stronger membrane–ion interaction, stronger dehydration of the ions may happen. As a result, lower hydration numbers can be expected [10,17,19,29]. Indeed, lower salt hydration number of NaCl (4.5 [10] and 3.5 [19]) have been sometimes reported, compared with that (equal to 14) obtained in this study. Further comparison shows that the membranes used in these previous studies were selective IEM membranes for which lower electro-osmotic flux was observed [8]. As a result, the hydration number of the migrating ions, directly linked to the electro-osmotic flux as indicated in the present work, was lower.

Overall, attention should be paid to hydration of ions that fixes electro-osmosis and thus the performances of ED. The present work shows that mass transfer prediction in ED is possible knowing hydration

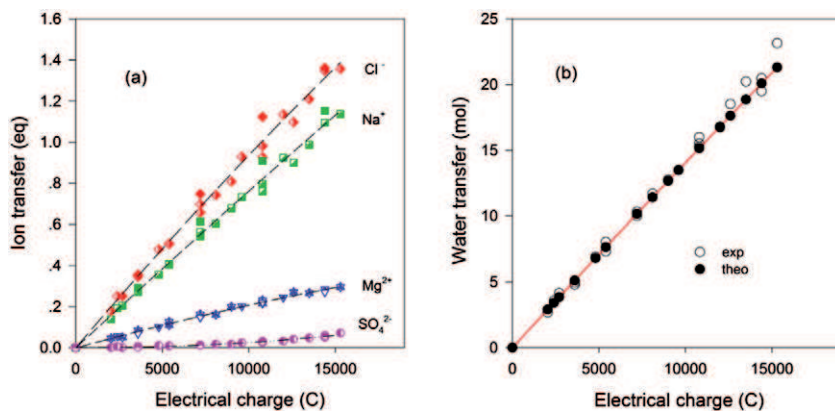

Fig. 6. Variation of the ion transfer (a) and the theoretical and experimental water transfer (b) versus electrical charge in solution S10; symbol of different filling in (a) indicating under different current as 2A (blank), 3A (cross), 4A (right solid), 6A (left solid).

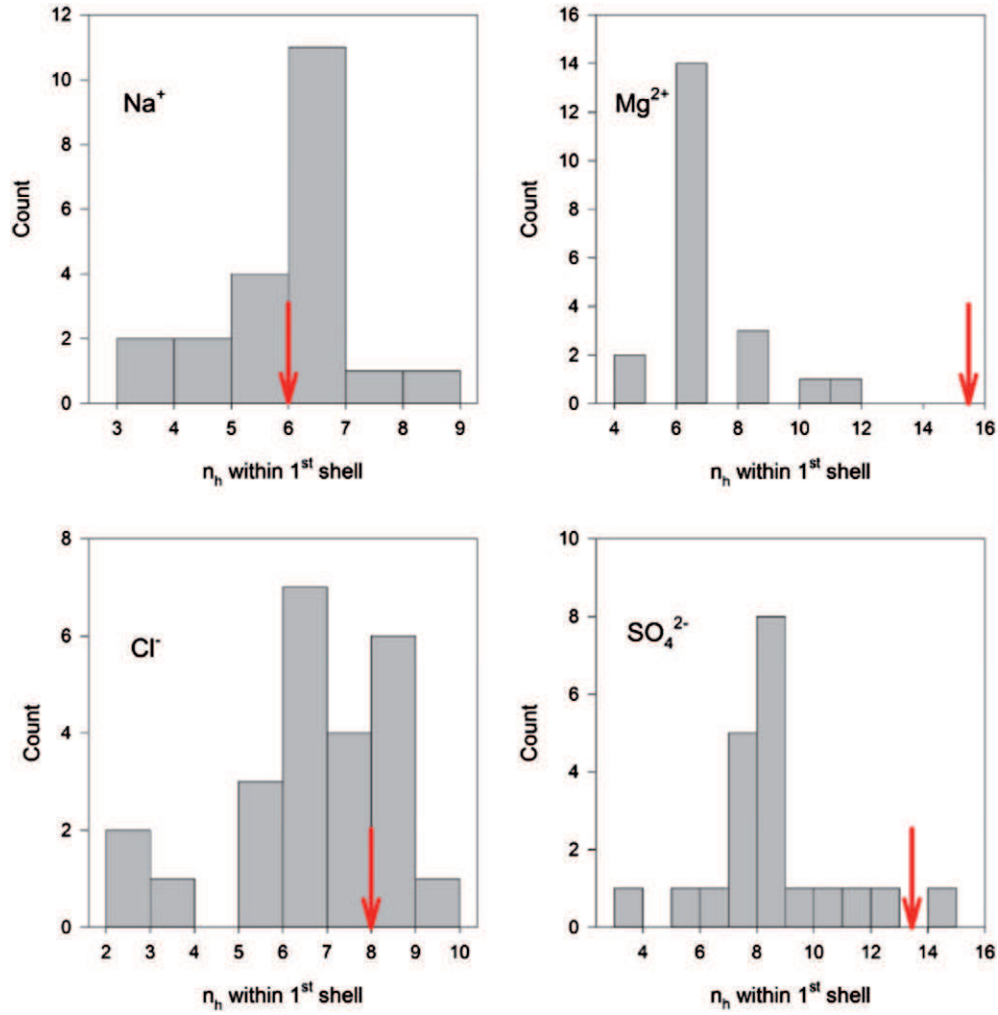

Fig. 7. Frequency distribution histogram of ion hydration number within 1st shell from literature [14,15] (each value based on different methodology but same electrolyte as in this study; arrows indicating the values obtained in this study).

number of ions, as shown in Fig. 6, which can be significant for process control, considering different kinds of applications like purification of fermentation broth or desalination/concentration of brines [12].

5. Conclusions

The aim of this work was to investigate the transfer of salt and water during ED. The objective was to determine the water transfer due to electro-osmosis and the hydration number of ions transferring through IEM, since it is a key parameter with respect to the process performance.

A methodology was proposed to calculate these ion hydration numbers. It was based on the experimental measurements of ion and water transfer under different conditions, like salt composition and concentration and current. Salt hydration was first obtained, and then the individual hydration numbers of 4 transferring ions (Na^+ , Mg^{2+} , Cl^- , SO_4^{2-}) were calculated simultaneously. It was shown that, in the conditions

investigated, these hydration numbers are constant, independent from the salt composition and current. The hydration number for monovalent ion was found to be lower than that of divalent one, for cation and anion respectively. This is in agreement with the values of the hydration free energy, characterizing the strength of bond between the ion and its surrounding water. Further comparison with the reported values concerning the hydration of the same ions in solution demonstrated that for monovalent ions the hydration numbers are close to those reported for the 1st hydration shell while much higher values are obtained for divalent ions.

Future work will be devoted to the study of membrane-solute-water interactions with a focus on hydration mechanisms. This will be carried using computational as well as experimental approach. Regarding the process performances, further work is necessary to consider more complex solutions closer to applications, containing both mixed salts and organic compounds.

Table 8

Calculated ion hydration number in this study and some other ionic characteristics.

Parameter	Na ⁺	Mg ²⁺	Cl ⁻	SO ₄ ²⁻	Reference
Molar mass (g·mol ⁻¹)	23	24	35.5	96	
Valence (eq·mol ⁻¹)	1	2	-1	-2	
Hydration free energy (kJ·mol ⁻¹)	-375	-1838	-347	-1090	[15]
Hydration number (mol water/mol ion)	6	15-16	8	13-14	This study

Nomenclature

List of symbols

j_s	salt flux (mol·m ⁻² ·s ⁻¹)
j_i	ion flux (eq·m ⁻² ·s ⁻¹)
j_v	volumetric flux (m ³ ·m ⁻² ·s ⁻¹)
j_w	water flux (m ³ ·m ⁻² ·s ⁻¹)
m_i	number of mole transferred for ion (mol)
m_w	number of mole transferred for water (mol)

n_h^i	ion hydration number, (mol water/mol ion)
n_h^s	salt hydration number, (mol water/mol salt)
V_m^i	ion molar volume ($\text{m}^3 \cdot \text{mol}^{-1}$)
V_m^w	water molar volume ($1.8 \times 10^{-5} \text{ m}^3 \cdot \text{mol}^{-1}$)
z	valence ($\text{eq} \cdot \text{mol}^{-1}$)
I	current intensity (A)

Greek symbols

α	current coefficient ($\text{eq} \cdot \text{m}^{-2} \cdot \text{s}^{-1} \cdot \text{A}^{-1}$)
β	electro-osmotic coefficient ($\text{m}^3 \cdot \text{m}^{-2} \cdot \text{s}^{-1} \cdot \text{A}^{-1}$)

Superscripts & subscripts

A	anion
C	cation
diff	diffusion
eo	electro-osmosis
exp	experimental data
h	hydration
i	ion
mig	migration
s	salt
t	experiment time
theo	theoretical data
w	water

Acknowledgments

The authors would like to acknowledge the support provided by the China Scholarship Council (CSC), Ministry of Education, P. R. China to the PhD student (Le Han).

References

- [1] H. Strathmann, Ion-Exchange Membrane Separation Processes, Elsevier Science, Stuttgart, 2004.
- [2] H. Strathmann, Electrodialysis, a mature technology with a multitude of new applications, *Desalination* 264 (2010) 268–288.
- [3] C. Huang, T. Xu, Y. Zhang, Y. Xue, G. Chen, Application of electrodialysis to the production of organic acids: state-of-the-art and recent developments, *J. Membr. Sci.* 288 (2007) 1–12.
- [4] C. Abels, F. Carstensen, M. Wessling, Membrane processes in biorefinery applications, *J. Membr. Sci.* 444 (2013) 285–317.
- [5] F.J. Borges, H. Roux-de Balmann, R. Guardani, Investigation of the mass transfer processes during the desalination of water containing phenol and sodium chloride by electrodialysis, *J. Membr. Sci.* 325 (2008) 130–138.
- [6] Y. Zhang, K. Ghyselbrecht, B. Meesschaert, L. Pinoy, B. Van der Bruggen, Electrodialysis on RO concentrate to improve water recovery in wastewater reclamation, *J. Membr. Sci.* 378 (2011) 101–110.
- [7] A.H. Galama, M. Saakes, H. Bruning, H.H.M. Rijnaarts, J.W. Post, Seawater pre-desalination with electrodialysis, *Desalination* 342 (2013) 61–69.
- [8] W. Walker, Y. Kim, D. Lawler, Treatment of model inland brackish groundwater reverse osmosis concentrate with electrodialysis – Part II: sensitivity to voltage application and membranes, *Desalination* 345 (2014) 128–135.
- [9] M. Fidaleo, M. Moresi, Electrodialytic desalting of model concentrated NaCl brines as such or enriched with a non-electrolyte osmotic component, *J. Membr. Sci.* 367 (2011) 220–232.
- [10] T. Rottiers, K. Ghyselbrecht, B. Meesschaert, B. Van der Bruggen, L. Pinoy, Influence of the type of anion membrane on solvent flux and back diffusion in electrodialysis of concentrated NaCl solutions, *Chem. Eng. Sci.* 113 (2014) 95–100.
- [11] C. Jiang, Y. Wang, Z. Zhang, T. Xu, Electrodialysis of concentrated brine from RO plant to produce coarse salt and freshwater, *J. Membr. Sci.* 450 (2014) 323–330.
- [12] M. Bailly, H. Roux-de Balmann, P. Aimar, F. Lutin, M. Cheryan, Production processes of fermented organic acids targeted around membrane operations: design of the concentration step by conventional electrodialysis, *J. Membr. Sci.* (2001) 129–142.
- [13] N.P. Berezina, N.A. Kononenko, O.A. Dyomina, N.P. Ghusin, Characterization of ion-exchange membrane materials: properties vs structure, *Adv. Colloid Interf. Sci.* 139 (2008) 3–28.
- [14] H. Ohtaki, T. Radnai, Structure and dynamics of hydrated ions, *Chem. Rev.* 93 (1993) 1157–1204.
- [15] Y. Marcus, *Ion Properties*, Marcel Dekker, INC., New York, 1997.
- [16] A.J. Rutgers, Y. Hendrikx, Ionic hydration, *Trans. Faraday Soc.* 58 (1962) 2184–2191.
- [17] L.A. Richards, A.I. Schäfer, B.S. Richards, B. Corry, The importance of dehydration in determining ion transport in narrow pores, *Small* 8 (2012) 1701–1709.
- [18] E. Singlande, Integrated Process Coupling Electrodialysis and Upstream Biological Treatment: Influence of the Ionic Composition and Application to the Treatment of Salted Liquid Wastes (Ph.D. Thesis) Université Paul Sabatier, 2006.
- [19] H.Y. Lu, C.S. Lin, S.C. Lee, M.H. Ku, J.P. Hsu, S. Tseng, et al., In situ measuring osmosis effect of Selemion CMV/ASV module during ED process of concentrated brine from DSW, *Desalination* 279 (2011) 278–284.
- [20] G.M. Geise, D.R. Paul, B.D. Freeman, Fundamental water and salt transport properties of polymeric materials, *Prog. Polym. Sci.* 39 (2014) 1–42.
- [21] D.A. Doyle, J.M. Cabral, R.A. Pfuetzner, A. Kuo, J.M. Gulbis, The structure of the potassium channel: molecular basis of K^+ conduction and selectivity, *Science* 280 (1998) 69–77.
- [22] A. Elattar, A. Elmidaoui, N. Pismenskaia, C. Gavach, G. Pourcelly, Comparison of transport properties of monovalent anions through anion-exchange membranes, *J. Membr. Sci.* 143 (1998) 249–261.
- [23] J.H. Choi, H.J. Lee, S.H. Moon, Effects of electrolytes on the transport phenomena in a cation-exchange membrane, *J. Colloid Interface Sci.* 238 (2001) 188–195.
- [24] S. Galier, H. Roux-de Balmann, Demineralization of glucose solutions by electrodialysis: influence of the ionic composition on the mass transfer and process performances, *Can. J. Chem. Eng.* 93 (2015) 378–385.
- [25] K. Ghyselbrecht, A. Silva, B. Van der Bruggen, K. Boussu, B. Meesschaert, L. Pinoy, Desalination feasibility study of an industrial NaCl stream by bipolar membrane electrodialysis, *J. Environ. Manag.* 140 (2014) 69–75.
- [26] A.H. Galama, G. Daubaras, O.S. Burheim, H.H.M. Rijnaarts, J.W. Post, Seawater electrodialysis with preferential removal of divalent ions, *J. Membr. Sci.* 452 (2013) 219–228.
- [27] J. Havel, E. Högfeldt, Evaluation of water sorption equilibrium data on Dowex ion exchanger using WSLET-MINUIT program, *Scr. Fac. Sci. Masaryk Univ.* 25 (1995) 73–84.
- [28] B. Tansel, Significance of thermodynamic and physical characteristics on permeation of ions during membrane separation: hydrated radius, hydration free energy and viscous effects, *Sep. Purif. Technol.* 86 (2012) 119–126.
- [29] R. Rautenbach, R. Albrecht, *Membrane Processes*, Wiley, 1989.
- [30] L.J. Banasiak, A.I. Schäfer, Removal of boron, fluoride and nitrate by electrodialysis in the presence of organic matter, *J. Membr. Sci.* 334 (2009) 101–109.