



**HAL**  
open science

## Observation of Arcing inside a Fuse under VSI Short Circuit Conditions using 5.106 Frames per Sec. X-ray Imaging

Jean-Louis Gelet, Jean-Marc Chaix, Xavier Just, Pierre Lhuissier, Gérard Thomas, Olivier Bonnefoy, Alexander Rack, Margie Olbinado

► **To cite this version:**

Jean-Louis Gelet, Jean-Marc Chaix, Xavier Just, Pierre Lhuissier, Gérard Thomas, et al.. Observation of Arcing inside a Fuse under VSI Short Circuit Conditions using 5.106 Frames per Sec. X-ray Imaging. COSYS-DC 2017 - International Conference on Components and SYStems for DC Grid, APIME, Mar 2017, Grenoble, France. hal-01505692

**HAL Id: hal-01505692**

**<https://hal.science/hal-01505692>**

Submitted on 11 Apr 2017

**HAL** is a multi-disciplinary open access archive for the deposit and dissemination of scientific research documents, whether they are published or not. The documents may come from teaching and research institutions in France or abroad, or from public or private research centers.

L'archive ouverte pluridisciplinaire **HAL**, est destinée au dépôt et à la diffusion de documents scientifiques de niveau recherche, publiés ou non, émanant des établissements d'enseignement et de recherche français ou étrangers, des laboratoires publics ou privés.

# Observation of Arcing inside a Fuse under VSI Short Circuit Conditions using 5.10<sup>6</sup> Frames per Sec. X-ray Imaging

Jean-Louis GELET<sup>1</sup>, Jean-Marc CHAIX<sup>2</sup>, Xavier JUST<sup>2</sup>, Pierre LHUISSIER<sup>2</sup>,  
G rard THOMAS<sup>3</sup>, Olivier BONNEFOY<sup>3</sup>, Alexander RACK<sup>4</sup>, Margie OLBINADO<sup>4</sup>

<sup>1</sup> *MERSEN France SB SAS, Rue Vaucanson, 69720 Saint-Bonnet de Mure. France*

<sup>2</sup> *SIMAP. ENSEEG BP75, 38402 Saint-Martin d'H res. France*

<sup>3</sup> *Ecole des Mines de Saint-Etienne – Groupe SPIN, 42000 Saint-Etienne. France*

<sup>4</sup> *ESRF. Structure of Materials Group - ID19, S-19 CS 40220, 38043 Grenoble Cedex 9. France*

---

## Abstract

The fuse is one of the oldest components of electrical engineering. As soon as engineers made use of electricity for practical, domestic or industrial applications, they met problems with over-currents. And the solution they chose immediately was the fuse [1]. Without the safe protection provided by this component, electricity would be probably regarded as far too dangerous for widespread use and there would be no modern electrical industry [2]. Even today, despite their apparent banality, electric fuses remain the ultimate protection against short-circuits in equipment, including those with the most advanced topologies.

Let us consider power-electronics converters. They are very reliable equipment and are widely used in many activities including industries, services and even residential. However, there is a non-negligible risk of failure of a semi-conductor acting to commutate in a leg. In that case, the semi-conductor will short-circuit and all the available energy will pass through the leg. There is then a very high risk of explosion of the semi-conductor, with occurrence of an electric arc inside the converter and even outside. A huge amount of energy is to be dissipated and not only the converter and its components will be concerned and destroyed, but also fragments will be ejected, intensive radiations emitted, toxic gases produced and a pressure wave propagated. All these dangers fly in the face of the safety requirements in the industrial field. Moreover, designers of equipment for the general public – think to automotive, railways, aeronautics – will be especially concerned by this issue. More particularly, VSI-inverters present specific short circuits conditions, the over-current coming from the discharge of a capacitor into a no-inductive circuit [3] [4]. The fuse operates very fastly, in a range from about ten to hundred microseconds. The optimization of its design justifies to undertake fundamental studies in order to offer the right protection to the customer.

For the first time, a team of engineers from MERSEN and researchers from Grenoble-INP and Ecole des Mines de St-Etienne, together with scientists of the European Synchrotron for Research Facilities in Grenoble, could record X-ray-movies through the insulating envelope and at very high speed. They carried out records up to 5 million frames per second at the ESRF, and through this approach, they gathered very rich information on the arc phenomenon in the fuse.

---

## I. Introduction

A fuse is generally considered a very simple device, most people knowing that when the heating is too high, the fuse will melt. But things are not so simple. A fuse has to fulfil two main functions: conduction and breaking. Breaking itself consists in two phases, called prearcing and arcing. Due to Joule's effect, heating occurs during conduction. Both electrical and thermal equations are well-known and can be easily coupled, especially with today's software and the power of modern computers. Breaking also calls in coupling between electrical and thermal phenomena during the prearcing period, with the difference that a large range of temperature is covered, binding to take into account variations of physical characteristics such as electrical and thermal resistivities. Nevertheless, it can be considered that models are available.

Arcing is much more difficult to consider. Of course, for decades engineers and researchers have developed many studies and proposed a lot of models. But except in very specific cases where diverted methods have been used, only *post-mortem* observations were available and the dream remained to see the arc inside the fuse in order to approach its dynamics. For the first time, a team of researchers have run tests and recorded movies of the arc inside the envelope, using ultra-fast X-ray imaging.

Thanks to their very high frequencies, the films carried out at ESRF allow visualizing how the conductive material turns from a solid-liquid phase to an embryo of plasma. At the end of this transition, conditions are fulfilled for the arc to grow in section and length. Also, the end of this transition corresponds to the initial conditions for usual modeling of the arcs. On another hand the movies give access to the burn-back. By synchronizing pictures with electric parameters, i.e. voltage and current, a large amount of information becomes available. In this paper, we have chosen to take into consideration calculations of the electric field  $E$  in the arc-plasma and to compare the curves  $E(i)$  to the data in the literature.

## II. Electrical arcing in a fuse is a very dynamic phenomena

In the rest of this text, we will not take into account the conduction function anymore and we will focalize upon breaking, and more specifically on arcing. After melting of the metallic conductor, current is not instantaneously turned to zero. During this period the transfer of electrical charges through the fuse goes on. The medium that insures this transfer is an electric arc. Figure 1 compares the operation of a fuse under maximal energy conditions according to IEC 269.1 for AC voltage at 50 Hz. and the operation under VSI-conditions.

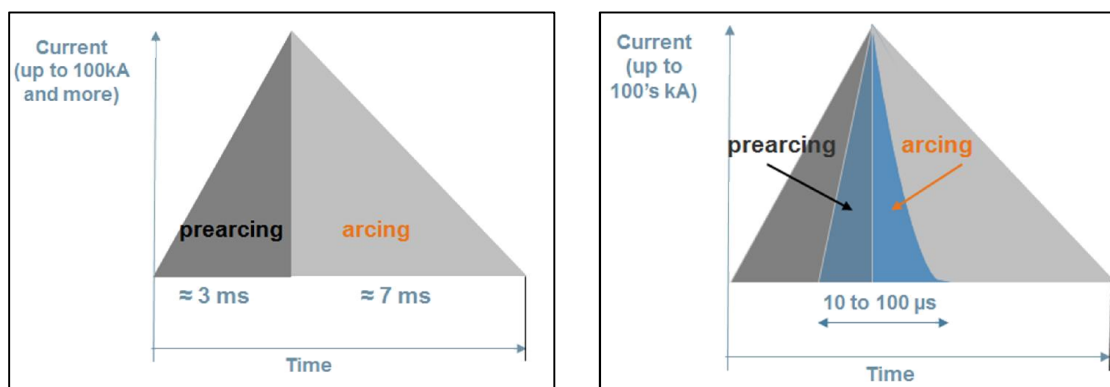

Figure 1- Current-curve for prearcing and arcing periods. Left : Principle-graphic of breaking at  $I_2$ -current according to IEC 269.1 standard. Right : Principle graphic for VSI-short circuit.

Electro-technical engineers use to consider the fuse and then the arc as a voltage-source in the circuit of figure 2:

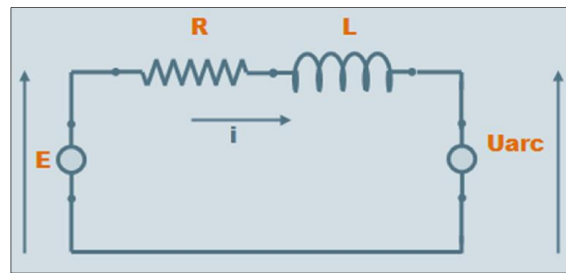

Figure 2 - Electrical circuit including the arc as a voltage-generator in opposition to the main generator.

The electrical equation of the circuit is written as

$$E = L \cdot \frac{di}{dt} + R \cdot i + u_{arc}$$

By neglecting the voltage across the resistor, the decrease of current comes as

$$\frac{di}{dt} = \frac{E - u_{arc}}{L}$$

Another way to approach the electrical arc is to consider the aspect of the energy. During tests, the energy of an arc is calculated as  $\int u \cdot i \cdot dt$ . For example, a fuse rated at 1000A and 690V, operating under IEC 60-260-1 I2 conditions, will have to manage an arc-energy reaching typical values of about 100 kJ by ensuring the transfer of this energy to the surrounding medium. Because of the high values of specific heat, melting temperature and latent melting heat of silica, only a reduced volume of material is needed, in opposition with what would happens in air or vacuum. From its ignition, the arc propagates through the sand according to a continuous process. Figure 3 hereunder is a sketch of what is supposed to occur.

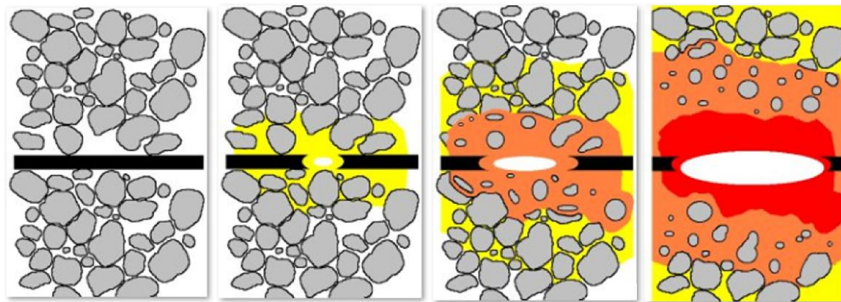

Figure 3 : 4-pictures description of the continuous phenomenon of an arc in granular medium.

Unfortunately, up to now it was only possible to observe the results of the arc a long time after its extinction, either by disassembling or by X-radiography.

### III. X-ray imaging at $5 \cdot 10^6$ frames per second

Generations of engineers and scientists have investigated to understand complex phenomena related to interaction between arc and sand arranged as energy-absorbent. Most of their observations have been run *post mortem*. All had the dream to make an actual movie of an arc inside the fuse-envelope. A few of them approached this fantasy by using diverting methods such as spectroscopy through a window or a matrix of magnetic sensors. Nevertheless, despite deficient information, very relevant conclusions have been drawn out. W. Bussière [5] built an

experiment around special fuses fitted with a window allowing observing and making records with a fast-camera at 35,000 frames per second. He could measure the burnback-rate during AC-operations. Unfortunately the experiments were biased as the energy-absorbent medium did not fully surround the arc. Also, the rate of shooting seems to be sufficient as it offers 350 images for half a period at 50 Hz, but it remains low for looking at quicker phenomena such as the establishment of the arc-voltage and for operations under VSI-conditions.

For the first time a team of engineers from MERSEN and researchers from Grenoble-INP and Ecole des Mines de St-Etienne have done ultra-fast X-ray imaging of the arc across the envelope. Observations up to 5,000,000 frames per second have been performed. Analysis of the records brings valuable information about the arc in the fuse and allows adjusting models, with a major interest for very fast operation under high di/dt [6].

For the experiments, the fuse is included in the discharging circuit of a capacitor, this capacitor being previously loaded to the required voltage by a DC supply. Discharging conditions are adjusted by the inductance of a wiring cable. The fuse is illuminated by a parallel X-ray beam whose energy was previously tuned according to the absorbance of the materials integrated in the fuse-sample. The image is formed on a scintillator that transforms information from X-ray to visible light. This image is captured by a CCD-camera in the back of a lens in order to adapt the magnification. The synchronization of the beam-opening, of the closing of the discharging circuit and of the CCD-camera shooting is ensured by a programmable microcontroller.

Table I : Testing Circuit Components

X-ray source	ESRF (European Synchrotron Radiation Facility) in Grenoble. Line ID19
Scintillator	LYSE : Ce 550 mm thick
CCD (Charge-Coupled Device) Camera	SHIMATZU HPV-X2
Microcontroller	ARDUINO UNO
Capacitor	3 // SIC-SAFCO Felsic DI 2200 $\mu$ F 480 Vdc
Switch for circuit closing	2 // thyristors SEMIKRON SKT 40 14 <sup>E</sup>
DC-supply for capacitor charging	KEITHLEY 247 High Voltage Supply
Current and voltage recording	AGILENT Technology DSO-X 2004A
Current probes	Rogowski Coil
Voltage probes	KEITHLEY

A draft of the physical organization of the different parts of the test-equipment is presented hereunder in figure 4.

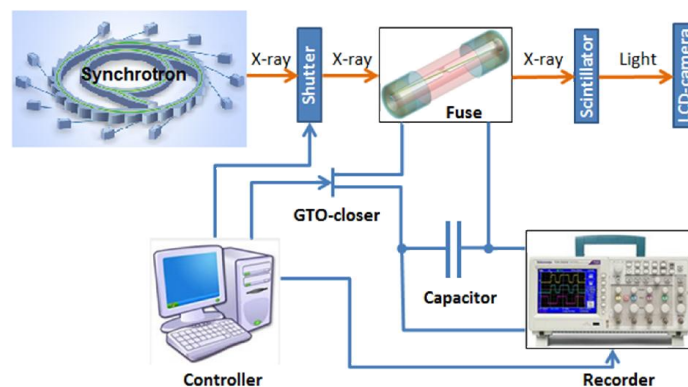

Figure 4: Simplified organization of the test equipment, showing its principal parts

Figure 5 gives additional details on the electrical circuit.

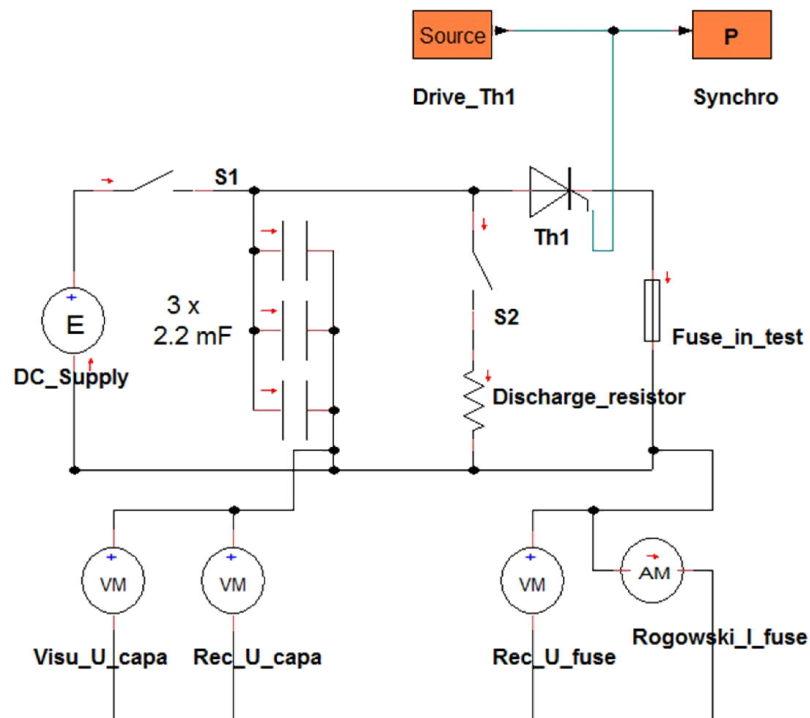

Figure 5: Electrical circuit

A first signal is given to the shutter of the chamber for opening the X-ray beam, with a delay of 100 ms to be sure its opening is achieved. Then three signals are sent simultaneously to:

- the acquisition of electrical signals by the oscilloscope
- the opening of the shutter of the CCD-camera and the beginning of the acquisition of the images
- the capacitor discharge

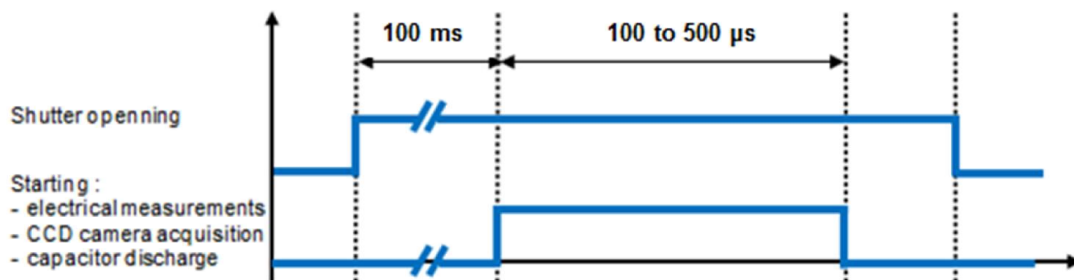
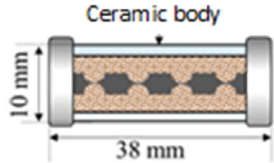
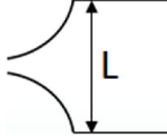
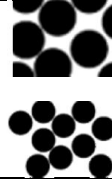

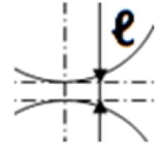

Figure 6 : sinogram for events synchronization

The test samples were cylindrical fuses (diameter 10 mm, length 38 mm) from MERSEN's commercial range. They belong to gR-class, their nominal current rating is 20 A and their nominal operation voltage is 690 V. In comparison with the standard version, several variants were prepared and tested according to the following table.



Table II: Variants for test-samples

	Conduction width	Sand grains mean size	Glued sand grains	Width of the constriction neck
				
Standard	20 mm	350 $\mu\text{m}$	no	180 $\mu\text{m}$
Variants	20 mm	350 $\mu\text{m}$	no	135 $\mu\text{m}$
	20 mm	350 $\mu\text{m}$	yes	180 $\mu\text{m}$
	20 mm	350 $\mu\text{m}$	yes	135 $\mu\text{m}$
	20 mm	200 $\mu\text{m}$	no	180 $\mu\text{m}$
	20 mm	200 $\mu\text{m}$	no	135 $\mu\text{m}$
	20 mm	200 $\mu\text{m}$	yes	180 $\mu\text{m}$
	20 mm	200 $\mu\text{m}$	yes	135 $\mu\text{m}$
	25 mm	350 $\mu\text{m}$	no	180 $\mu\text{m}$
	25 mm	350 $\mu\text{m}$	yes	180 $\mu\text{m}$

The protocol for experiments consists in testing different versions of samples under several electrical conditions (voltage, length of the loop of the circuit), setting the fuse element so that it presents its edge or its surface toward the X-ray beam, and finally under different shooting frequencies. Indeed, the memories of the CCD-camera allow recording only 128 frames. Then, depending on whether the whole arcing is to be recorded or only the beginning of the arc, it will be necessary to adapt the acquisition frequency. At 1 frame for 100 microseconds, it will be possible to record all the duration of the arc. Higher frequencies, such as 1 frame for 0.2 microseconds will be used for focusing on the transition from prearcing to arcing and the first moments of the arc. Thanks to the good repeatability of fuse operation, by reproducing several times the same electric conditions under different shooting frequencies and for the two perpendicular positions of the fuse-element, acquisition of information will be optimized.

Table III: testing conditions

Voltage	Current and $di/dt$	Position of the conductor towards X-ray-beam	Shooting-frequency
450 V 400 V 300 V	Short loop	edge	1 im./0,2 $\mu\text{sec.}$
			1 im./0,5 $\mu\text{sec.}$
			1 im./1 $\mu\text{sec.}$
			1 im./2 $\mu\text{sec.}$
			1 im./5 $\mu\text{sec.}$
	Large loop	surface	1 im./10 $\mu\text{sec.}$
			1 im./20 $\mu\text{sec.}$
			1 im./100 $\mu\text{sec.}$
			1 im./200 $\mu\text{sec.}$

Hereafter is a picture showing the synchronization of the current and voltage records with two X-ray movies, one with the fuse element seen on its edge, one on its flat surface.

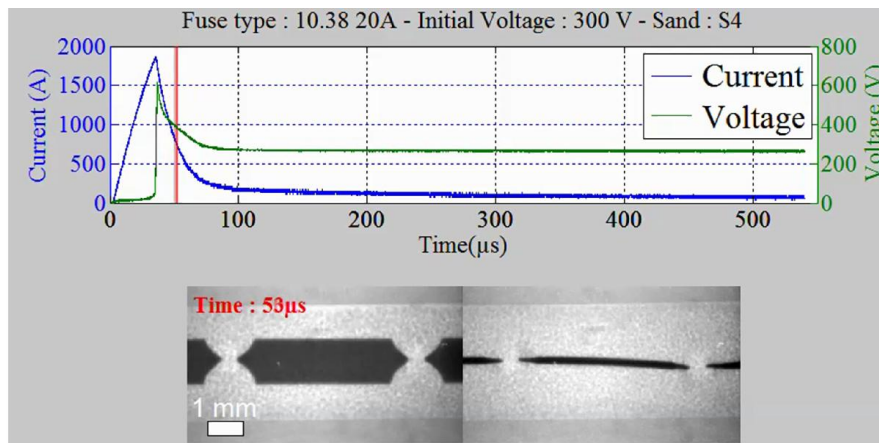

Figure 7: Synchronization of the current and the voltage with two pictures extracted from two different movies, one with the element seen on its flat surface, the other on its edge. In this case, for all curves and pictures, time is 53 μsec.

#### IV. Analysis of the observations

For the same definition of the samples, i.e. same element width and thickness, same geometry of the constrictions, same sand and same compaction of the sand, and for the same electrical conditions, i.e. same voltage and same inductance, tests have been repeated for several shooting frequencies, in order to cover all the arcing period and get as much information as possible.

The first analysis concerned standard fuses tested under capacitor discharges at 300, 400 and 450 V with a short loop. Of course, it is possible to draw the curves of current and voltage across the fuse versus time.

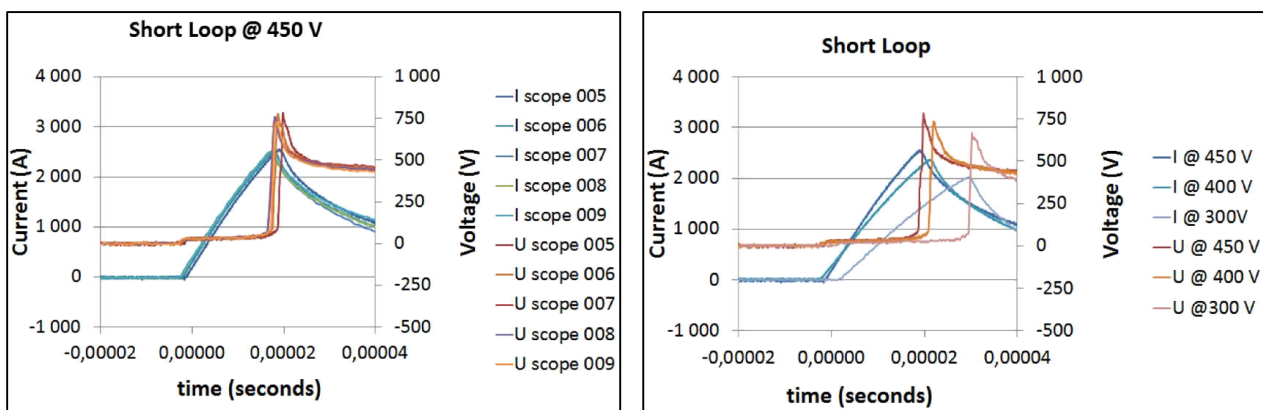

Figure 8 : Curves of current and voltage for identical samples. Left: five samples have been tested under 450 V and a short loop. Right: samples have been tested under 300, 400 and 450 V.



Voltage curves show a sharp rise corresponding to the beginning of current decrease. In a very short time, conduction of electric charges passes from the metallic mode to the transfer in an electrical field between two electrodes. This transitional phase between the pre-arcing phase and the arcing phase is not considered in the publications to which we had access. Usually the authors define an initial condition that amounts to the assumption of an arc instantly reaching a non-zero initial length  $\ell_0$ , this arc spreading and lengthening later as current and voltage vary. Applying this hypothesis to the fuse means that the transition is instantaneous between pre-arcing and arcing, the initial arc having dimensions close to those of the constriction and ready to increase:

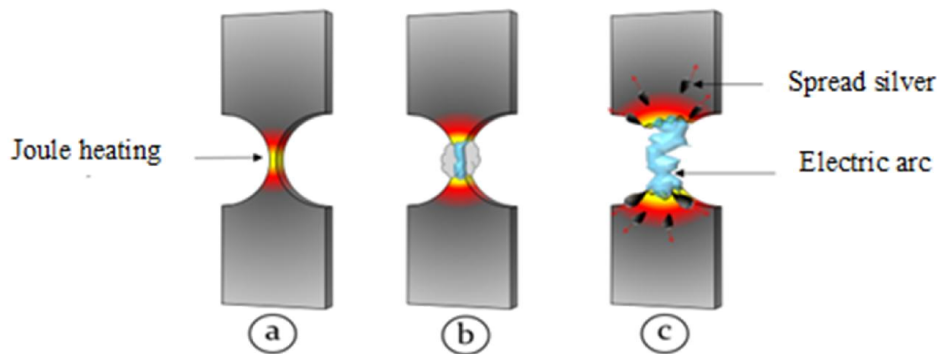

Figure 9 : Generally, authors make the hypothesis that conduction goes directly from (a) to (c).

In a recent work, A. Coulbois [7] carried out a quasi-exhaustive approach of all the phenomena being liable to take part in the transition from prearcing to arcing. The most interesting seem to be internal nucleation, magneto-hydro-dynamics and surface vaporization. During the tests at ESRF, R-ray-films have been recorded at up to 1 frame per 0.2 micro-second. They make it possible to observe this transition from prearcing to arcing. Hereunder a series of pictures extracted from a film is given.

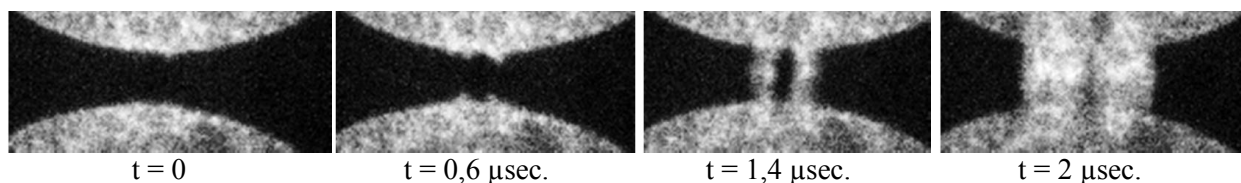

Figure 10 : Series of pictures extracted from a film; shooting-frequency is 1 frame per 0.2  $\mu\text{sec}$ .

At the beginning, the narrowest area of the constriction inflates and then gradually separates from both sides of the remaining conductor. This seems to corroborate the magneto-hydro-dynamic hypothesis.

But, for the time being, X-ray records have been taken into consideration for measuring the arc-length from the time  $t_0$  it is actually established. Time  $t_0$  is chosen as the instant of the first picture of the film where there is no more material between the two separated sides of the constriction. For example, in figure 10 above, the picture on the right, at  $t = 2 \mu\text{sec}$ , it has been considered that the arc is not completely established.

Frame by frame, arc lengths have been measured for all the tests carried out on standard fuse samples under 300, 400 and 450 V with the short loop. For high shooting frequencies (1 frame/μsec and more), only the first instants of the arc are recorded; corresponding arc lengths are plotted on the left side of the graph hereafter. For low shooting frequencies (1 frame for 10 to 100 μsec.), the entire arc duration is recorded; corresponding arc lengths are plotted on the full width of the graph. All the points, recorded at both high and low shooting frequencies, have been fitted with a piecewise linear law in logxlog axes. These calculations have been run for the three voltages 300, 400 and 450 V. A reference document about lengthening of the arc is the paper written by Turner and Turner [8] in 1977.

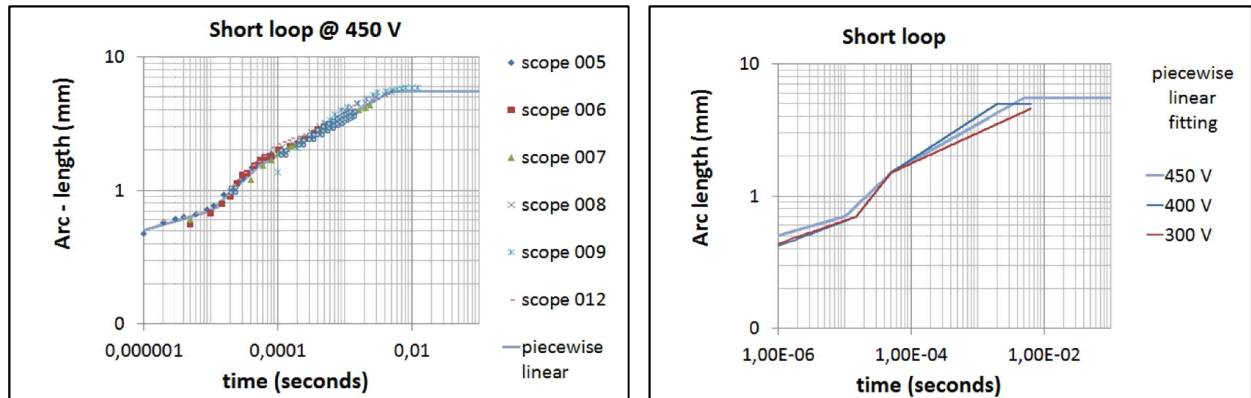

Figure 11 : Arc lengthening measured for standard fuse samples. Left: repeatability of tests under 450V for several shooting frequencies. Right: effect of the capacitor voltage, piecewise linear law for each voltage.

From the piecewise linear law, it becomes possible to evaluate arc length at any time and to compare it with electrical parameters, i.e. current and voltage.

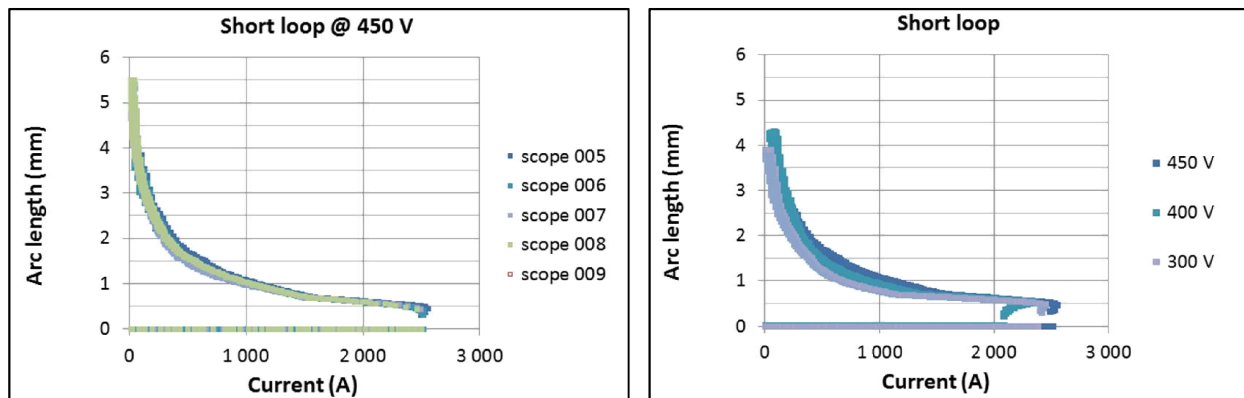

Figure 12: Arc lengthening vs. current for several standard fuse samples. Left: repeatability of tests under 450 V. Right: effect of the capacitor voltage.

Also it is possible to evaluate the value of the electrical field in the arc. It will be supposed that the field is homogenous within the arc column and the voltage at the electrodes will be estimated with equations from the literature. Authors like Dolegowski [9], Onuphrienko [10], and Wright and Beaumont [11] have proposed laws as follows:

$$U_{electrodes} = (20 \pm 5) + 1.5 \cdot [i(t)]^{0.39} \quad \text{Dolegowski}$$

For the following calculations, a model given by Gnanalingam and Wilkins [12] has been used:

$$U_{electrodes} = 15 + 1.0. [i(t)]^{0.39} \quad \text{Gnanalingam and Wilkins}$$

Consequently, the electrical field has been calculated according to the expression:

$$E = \frac{U_{measure} - 15 - 1.0. [i(t)]^{0.39}}{L_{piecewise\ linear\ fitted}}$$

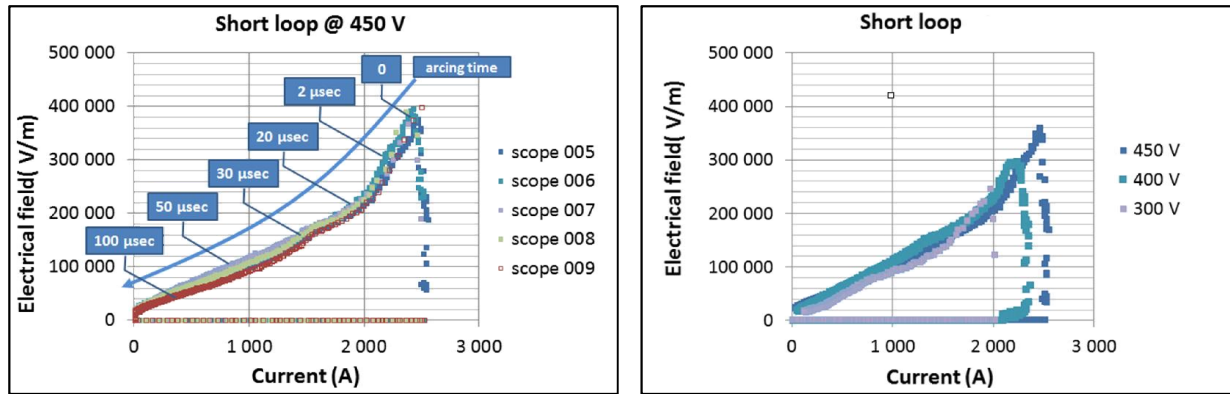

Figure 13 : Electrical field for several standard fuse samples. Left: repeatability of tests under 450 V. Right: effect of the capacitor voltage.

### IV. Discussion

Gnanalingam and Wilkins and Daalder and Schreurs [13] started from the following equation to consider the arc:

$$u_a = u_b + \int_0^x E \cdot dx$$

Where:

- $u_a$  arc voltage
- $u_b$  voltage at the electrodes (anodic and cathodic)
- $E$  electric field (V/mm)
- $x$  length of the arc

Table IV: Models of the literature for the voltage at the electrodes, the electric field and the rate of lengthening during fuse operation.

Voltage at the electrodes	Electric field	length
Dolegowski: $U_{electrodes} = (20 \pm 5) + 1.5. [i(t)]^{0.39}$	Wheeler [14]: $E = \frac{K. i(t)^{0.4}}{S\gamma}$	Gnanalingam and Wilkins: $\frac{dx}{dt} = (a + b. i^{0.6}). \frac{i}{S}$
Gnanalingam and Wilkins: $U_{electrodes} = 15 + 1.0. [i(t)]^{0.39}$	cylindrical geometry: $K \approx 1.93\ to\ 2.55$ $\gamma = 0.7$	$S$ : section for conduction (mm <sup>2</sup> )
	plane geometry: $K \approx 3.5\ to\ 4.6$ $\gamma = 0.85$	

Based on these bibliographic data, we focused our study on the curve of electrical field vs. current.

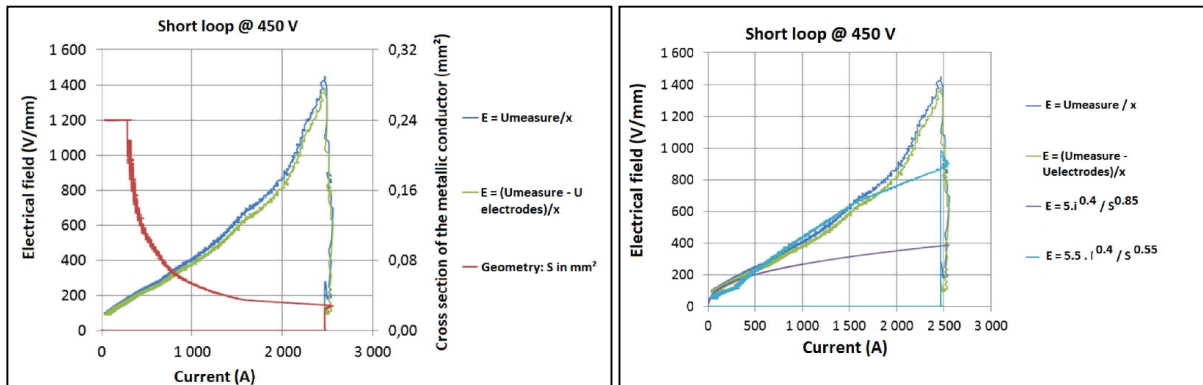

Figure 14 : Curves of measured electrical field vs. current. Left: the value of the element cross-section has also been plotted. Right: Curves calculated from Wheeler have also been plotted.

The electrical field is calculated from the measurements of the voltage and the arc length, by either taking into account the electrode drop voltage or not. But the results for both methods are very close as shown in figure 14. The same figure presents several areas. From right to left:

- On the very right, a very sharp increase of the electrical field, corresponding to the establishment of the arc voltage and to the “explosion” of the metallic conductor.
- Between 2500 and 1650 A, a fast drop-down of the value of the field, the shape of the curve  $E = f(i)$  being far from the literature. An explanation could be that the arc is not yet at the thermo-dynamic equilibrium. It is noticeable that the current then reaches 1650 A and the time is 10  $\mu$ sec. This duration should correspond to the time-constant of de-ionization (or ionization) of the arc.
- Between 1650 and 620 A, the curve of the field vs. the current can be fitted by a law  $(i) = \frac{5.5 \cdot i^{0.4}}{S^{0.55}}$ , which, according to Wheeler, is between laws for cylindrical and flat conductors.
- Under 620 A, the curve of the field vs. the current can be fitted by a law  $E(i) = \frac{5 \cdot i^{0.4}}{S^{0.85}}$  close to the one proposed by Wheeler for a flat conductor.

For the time being a general conclusion about a model for the electrical arc inside a fuse operating under DC high di/dt conditions cannot be drawn out. In order to reach this aim, it will be necessary to complete the analysis of the huge amount of data, i.e. electrical records and X-ray films, which have been acquired during the tests at ESRF. Nevertheless, there is already evidence that a comparison can be borne with models from the literature. This is justifying an investment for some exhaustive analysis.

## Conclusion

Researchers from Mersen Saint-Bonnet-de-Mure, Grenoble INP, Ecole des Mines de Saint-Etienne, in collaboration with scientists from European Synchrotron Radiation Facilities located at Grenoble, used the sophisticated single-bunch imaging techniques available at ESRF

to track the ultrafast processes that take place in fuses during electrical breakdown. Series of tests gave a database in which both electrical parameters and geometrical parameters of the fuse have been adjusted. X-ray movies have been shot and synchronized with current and voltage during fuse-operations.

Tests sessions carried out on commercial fuses brought a new and better knowledge of arcing in a fuse. First very valuable information concerns the determination of the initial conditions for any arc model. Indeed, very spectacular pictures of the transition between prearcing and arcing have been got which will help to make the decision about the initial dimensions of the arc. Additionally very fast imaging allows to observe the “explosion” of the metallic conductor and to validate or not different hypothesis of the literature i.e. internal nucleation, magneto-hydro-dynamics or surface vaporization. Second valuable information is the evidence of a preliminary phase of arcing during which the plasma is out of thermodynamic equilibrium, this second point coming from a comparison of the curve of the electrical field vs. the current with models available in the literature. It has not been yet demonstrated that this phase is specific to VSI-arcing, but it is sure that it becomes decisive and that it will have to be taken into account in the design of the fuses.

The combination of expertise from synchrotron scientists and fuse development engineers, together with arc specialists, open the way to very fundamental skills. It has been demonstrated that ultra-fast operation of fuses, typically under capacitor discharge with high  $di/dt$ , as occurs in case of VSI short circuits, present specific characteristics. The understanding of these specificities will now allow adjusting consequently the geometry of the constrictions in the conductor and the arrangement of the arc-energy absorber. Final purpose is to offer to the customer, i.e. the engineer in charge of the development of VSI-inverters, the best protection, including the lowest watt-losses, the lowest loop-inductance and the fastest breaking, for the more attractive cost.

- 
- [1] JL. Gelet, “To the origins of fuses”, *International Conference on Electrical Fuses and their Applications*, Clermont-Ferrand, 2007.
  - [2] A.D. Stokes, D.K. Sweeting, “Electric arcing burn hazards”, *International Conference on Electrical Fuses and their Applications*, Gdansk, 2003.
  - [3] JL. Gelet, “Characterization of fuses for applications under high  $di/dt$ ’s”, *International Conference on Electrical Fuses and their Applications*, Dresden, 2015.
  - [4] JL. Gelet, “Protection against external faults in VSI”, *International Conference on Electrical Fuses and their Applications*, Dresden, 2015.
  - [5] W. Bussi ere, “Influence of sand granulometry on electrical characteristics, temperature and electron density during high-voltage fuse arc extinction”, *Journal of Physics D: Appl. Phys.* 34 925-935, 2001.
  - [6] A. Rack, M. Scheel, L. Hardy, C. Curfs, A. Bonnin and H. Reichert, “Exploiting coherence for real-time studies by single-bunch imaging”, *Journal of Synchrotron Radiation* 21, 815-818, 2014.
  - [7] A. Coulbois, “Etude de la transition pr arc-arc dans les  l ments fusibles”, Th se de doctorat en Physique des plasmas. Universit  de Clermont-Ferrand, France, 2015.
  - [8] H.W. Turner, C. Turner, “Calculation of burn-back rate of a fuse-element and its relation to contact erosion”, *Switching Arc Phenomena*, Ł dź 1977.
  - [9] M. Dolegowski, “Calculation of the course of the current and voltage of a current limiting fuse”, *ICEFA Liverpool*, 1978.

- 
- [10] Y.J. Onuphrienko, "On researches of the arcing process in fuses with filler (sand filled fuses)", *3rd Int. Symp. on switching arc phenomena, Lodz, Poland*, 1977.
  - [11] A. Wright, K.J. Beaumont, "Analysis of high-breaking capacity fuselink arcing phenomena", *Proc. IEE*, 123, pp 252-258, 1976.
  - [12] S. Gnanalingam, R. Wilkins, "Digital simulation of fuse breaking tests", *IEE PROC. Vol. 127. Pt; C, No.6*, 1980.
  - [13] J.E. Daalder, E.F. Schreurs, "Arcing phenomena in high voltage fuses", *Department of Electrical Engineering, Eindhoven University of Technology, EUT report 83-E-137*, 1983.
  - [14] C.B. Wheeler, "The high-power constricted plasma discharge column – 1. Theoretical analysis", *J. Phys. D. 3. pp 1374-1380*, 1970.