



HAL
open science

Waste Heat Recovery Applied to a Tractor Engine

Quentin Danel, Christelle Périlhon, Stéphanie O.L. Lacour, Plamen Punov,
Amélie Danlos

► **To cite this version:**

Quentin Danel, Christelle Périlhon, Stéphanie O.L. Lacour, Plamen Punov, Amélie Danlos. Waste Heat Recovery Applied to a Tractor Engine. The International Conference on Technologies and Materials for Renewable Energy, Environment and Sustainability - TMREES 15, Apr 2015, Beirut, Lebanon. pp.331 - 343, 10.1016/j.egypro.2015.07.622 . hal-01504527

HAL Id: hal-01504527

<https://hal.science/hal-01504527>

Submitted on 16 May 2020

HAL is a multi-disciplinary open access archive for the deposit and dissemination of scientific research documents, whether they are published or not. The documents may come from teaching and research institutions in France or abroad, or from public or private research centers.

L'archive ouverte pluridisciplinaire **HAL**, est destinée au dépôt et à la diffusion de documents scientifiques de niveau recherche, publiés ou non, émanant des établissements d'enseignement et de recherche français ou étrangers, des laboratoires publics ou privés.



International Conference on Technologies and Materials for Renewable Energy, Environment and Sustainability, TMREES15

Waste heat recovery applied to a tractor engine

Q.Danel^{1a}, C.Périlhon^a, S.Lacour^b, P.Punov^c, A.Danlos^a

a : (CMGPCE-EA21)

Conservatoire national des arts et métiers, 292 Rue Saint-Martin, 75003 Paris, France.

b : IRSTEA

Irstea Rue Pierre-Gilles de Gennes,
CS 10030, 92761 Antony cedex – France

c : Department of Internal Combustion Engines, Automobiles and Transport, Technical University, Sofia, Bulgaria

Abstract

Due to the environmental impact of pollution, the depletion and increasing price of fossil fuel resources, current research focuses on reducing vehicle fuel consumption. The modern agricultural sector is highly dependent on petrol, as no exploitation can work without tractors or agricultural machinery. One solution to reduce the dependence on petrol is to install waste heat recovery systems on engine exhaust gases. Tractors are good candidates for waste heat recovery since they are used at high load over long periods, which are ideal operating conditions for waste heat recovery systems. Several technologies can be used to achieve this aim, such as an external heat engine, thermoelectricity or thermoacoustics. The present study considers the external heat engine, in particular the Rankine-Hirn cycle which is a phase change fluid engine. This well-proven technology is the one most widely used in industry to recover lost heat. Different heat loss recovery techniques are presented in this paper, in which we detail our model of the Rankine-Hirn engine used to dimension our future test bench. We focus on the selection of fluid, pressure and temperature as a function of the hot source temperature. Lastly, we present an initial evaluation of the increase in efficiency depending on the variation in the heat source.

© 2015 The Authors. Published by Elsevier Ltd. This is an open access article under the CC BY-NC-ND license (<http://creativecommons.org/licenses/by-nc-nd/4.0/>).

Peer-review under responsibility of the Euro-Mediterranean Institute for Sustainable Development (EUMISD)

Keywords: Waste Heat Recovery, Rankine-Hirn cycle, Simulation

^{1*} Corresponding author.

E-mail address: quentin.danel@outlook.fr

1. Introduction

The rising energy prices due to the depletion in resources, and policies to reduce the pollution due to vehicle emissions, have forced industry to find new solutions to reduce fuel consumption. One solution to reduce the dependence on petrol is to install waste heat recovery systems on engine exhaust gases. The typical tractor working cycle is well-adapted to recover the energy lost through exhaust gases [1,2]. Lacour et al. showed that tractor activity resembles a square wave (Fig. 1), with an alternation between long high-power phases and short low-power phases. In the internal combustion engine, fuel energy is converted into 3 main kinds of energy: mechanical energy, which is the usable energy, and heat, equally distributed between exhaust gases and cooling water.

Nomenclature

A	Surface: m^2
Cp	Heat capacity at constant pressure: $J/kg.K$
Ex	Exergy: J
H	Enthalpy: J
m	mass: kg
Q	Heat: W
S	Entropy: J/K
T	Temperature: K or $^{\circ}C$
U	Heat exchange coefficient: $W/K.m^2$
W	Work: W
η	Efficiency: %

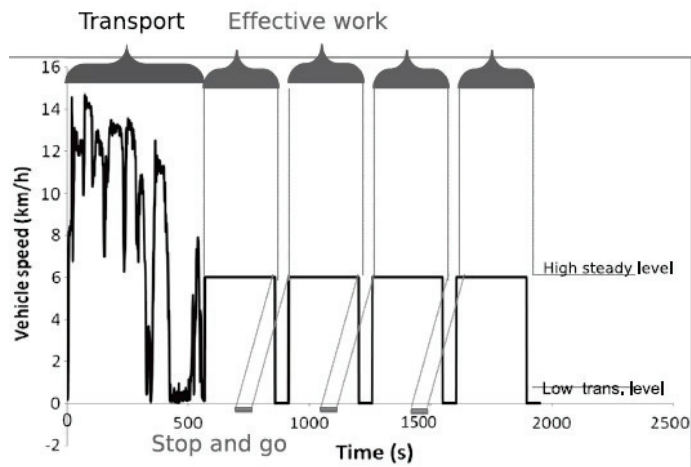

Fig. 1. Idealized tractor activity.

Exhaust gases have the highest energy potential because their temperature is considerably higher than that of the cooling water. Even if cooling water and exhaust gases contain the same energy, the useful energy of exhaust gases is approximatively three times greater than that of the cooling water. Punov et al. [3-5] and Milkov et al. [4] studied the characteristics of a tractor engine and automotive engine, they demonstrated the high energy potential of its exhaust gases. The tractor studied had a maximum power of 110kW.

Lacour et al. [1,2] showed that the high power phase of the work corresponded to a power between 60% and 80% of maximum engine power. On Fig. 2 the engine speed during crop line work is plotted on the exergy map of exhaust gases Fig. 3 taken from the work by Punov et al. shows that the maximum usable energy recoverable during typical work is between 20 kW and 30 kW for 1600rpm. This is approximatively one third of the engine shaft power. Waste heat recovery is therefore a major means for improving the consumption of internal combustion engines.

In the present article different technologies that can be used to recover waste heat are presented. We focus on one technology in particular, the Rankine-Hirn cycle. The static model of the Rankine-Hirn cycle is presented and was used to select the working fluid. As the typical operating mode of a tractor is the same as a square wave, two points were studied depending on the respective operating time of each point.

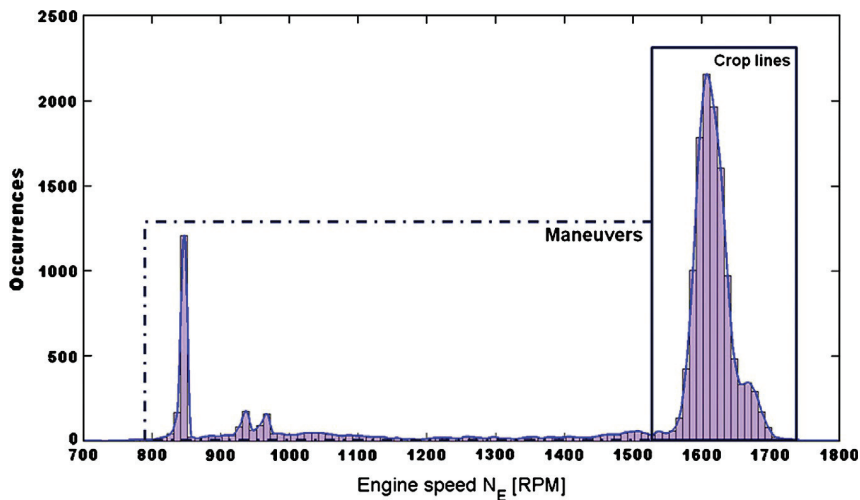

Fig. 2. Distribution of the engine speed over a plowing operation.

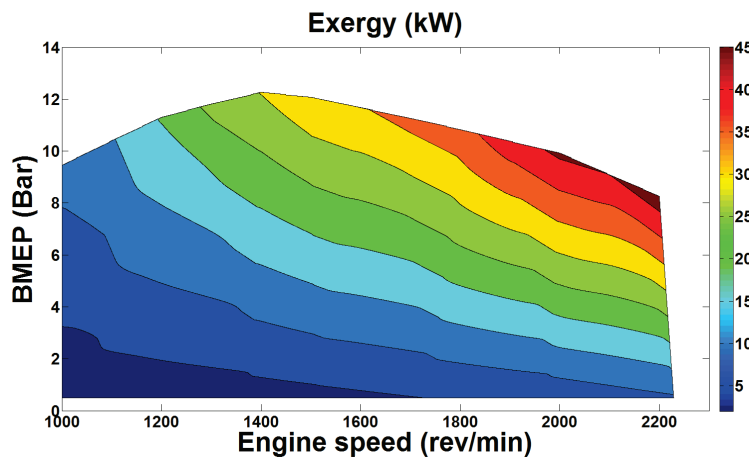

Fig. 3. Exergy of the exhaust gases at studied points in the exhaust system.

2. Waste heat recovery technologies

Various technologies can be used to recover waste heat.

1.1. Stirling cycle

The Stirling cycle is an external heat engine invented by Robert Stirling in 1816 [6]. A gas which is the working fluid is enclosed in the machine, a piston displaces the gas alternately to the hot side and the cold side and a working piston converts the gas pressure variation into work. The Stirling thermodynamic cycle shown in Fig.4 is composed of four stages: isothermal compression AB, isochoric heating BC, isothermal expansion CD and isochoric cooling DA. Due to its simple mechanics, this kind of engine is robust. By adding a regenerator to the engine, the efficiency can be improved, approaching that of a Carnot cycle. Nowadays, Stirling engines are not widely used for vehicle waste heat recovery as they are unsuitable for partial load operation. They are however used for space and military applications and are studied for micro cogeneration applications. The Stirling cycle is extensively used in cryogenic applications to produce low temperature.

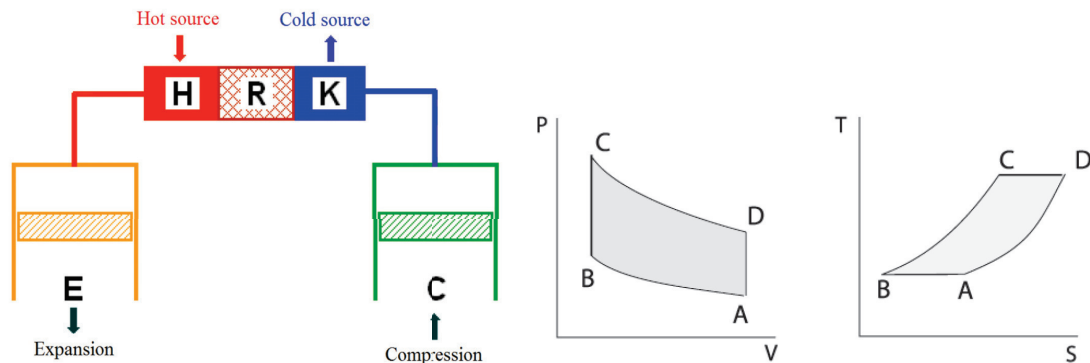

Fig. 4. Schematic diagram of Stirling engine and Stirling cycle PV and TS diagram (Juliette Bert thesis figure [6])

C : compression cylinder ; *E* : expansion cylinder ; *H* : heater ; *R* : regenerator ; *K* : cooler

1.2. Ericsson cycle

An Ericsson engine is another external combustion engine, invented by John Ericsson in 1833 [7-9]. It is an open cycle so the working fluid is air and is not enclosed in the machine, but a closed configuration can also be achieved to work with fluids other than air and a pressure different from atmospheric pressure. In the open cycle, the air is compressed, heated and expanded to produce the work; in the closed cycle, it is cooled after expanding. As in the Stirling engine, a regenerator can be added to obtain an efficiency similar to that of the Carnot cycle. The Ericsson thermodynamic cycle shown in Fig.5 is composed of an isothermal compression AB, an isobaric heating BC, an isothermal expansion CD and an isobaric cooling DA. This machine is mechanically more complicated than a Stirling engine but in the open cycle configuration it does not require a cooling system. As with the Stirling engine, the Ericsson engine is seldom used in vehicle applications. Ericsson engines are mainly implemented in micro cogeneration applications.

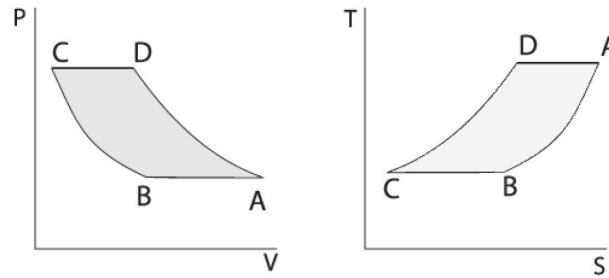

Fig. 5. Schematic diagram of Ericsson cycle

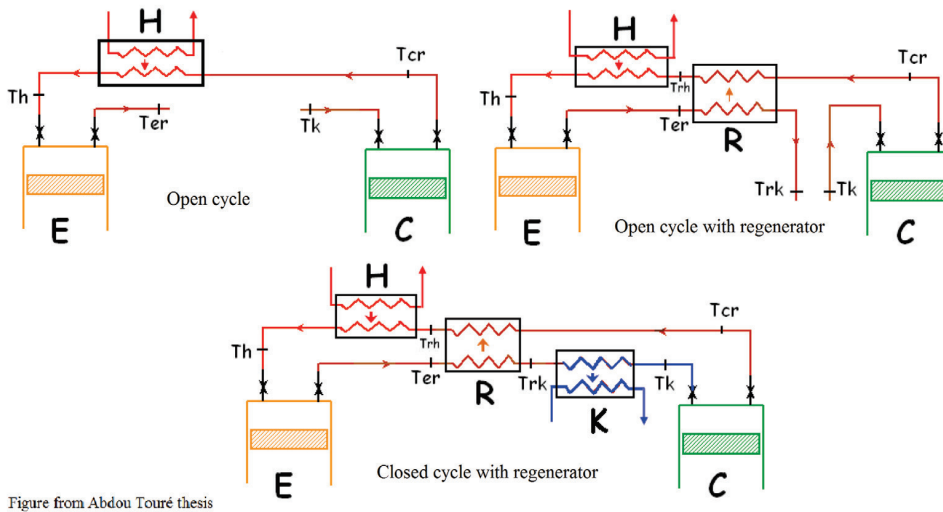

Figure from Abdou Touré thesis

Fig. 6. Schematic diagram of Ericsson engine configuration (Abdou Touré thesis figure [7])

C : compression cylinder ; *E* : expansion cylinder ; *H* : heater ; *R* : regenerator ; *K* : cooler

1.3. Thermoelectricity

Thermo-electricity is a Seebeck effect application discovered by Thomas Johann Seebeck in 1821. Electrical energy is directly produced by a heat flux through an assembly of 2 different semiconductor metals [10]. These 2 materials should have different electronics conductivities. The main interest of this technology is the absence of mechanical parts. Due to its simplicity, thermo-electricity is investigated in automotive applications but the efficiency is lower than that of thermodynamic cycles and its cost is higher. Currently, this technology is mainly used in space applications.

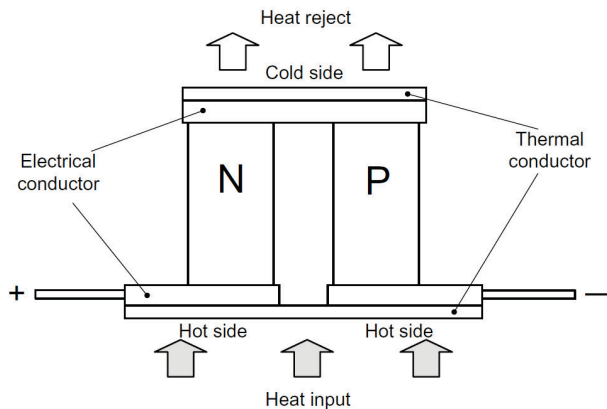

Fig. 7. Schematic diagram of thermo electricity (Juliette Bert thesis figure [6])

1.4. Thermoacoustics

The development of this technology, the newest among thermal engines, started in the 1980s. It consists in amplifying an acoustic wave with a heat flux due to a temperature difference [11]. The acoustic wave is converted into electrical energy by a microphone or a piston connected to a linear electric alternator. It can be used either as an engine or as a refrigerating machine. As with thermoelectricity, a great advantage of this technology is the absence or quasi absence of mechanical parts, thus ensuring its robustness. At present, there are no industrial developments of thermoacoustics.

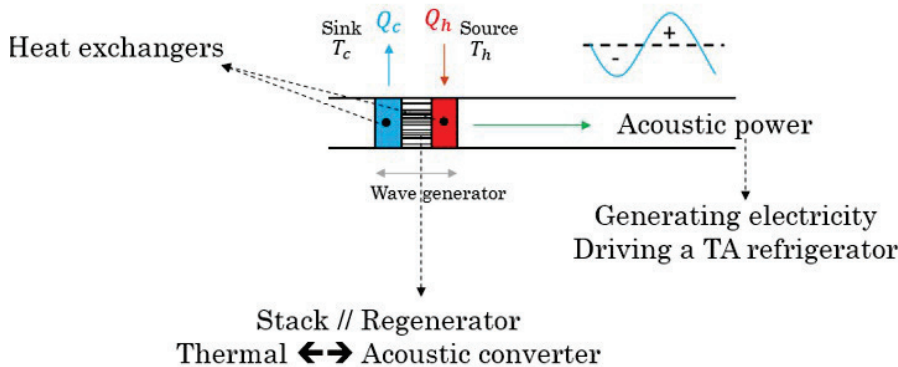

Fig. 8. Schematic diagram of a thermoacoustic engine (Cynthia Haddad figure [11])

1.5. Rankine-Hirn cycle

This is the cycle used in steam engines, and it is the oldest kind of thermal engine. In the 1st century AD, Hero of Alexandria discovered the possibility of converting heat into work [12]. From the 18th century on, steam engines were used industrially and in 1781 James Watt’s steam engine established the current form of this cycle. Today these machines are mainly used in large plants to produce electricity with coal or nuclear energy. Over the last decade, the Rankine-Hirn cycle has been studied for small-scale applications of heat recovery [13] due to the

increase in oil prices and more stringent environmental considerations. Historically, water was the working fluid but as this fluid is not the best for all heat source temperatures, other fluids can be used. Many of these fluids are organic, in which case the cycle is called the organic Rankine cycle or ORC. In a Rankine cycle the fluid is pumped into a heat exchanger where it is vaporized. Vapor is expanded in a turbine or another expander (historically a piston machine) and the expanded vapor is then condensed in a condenser. In the Hirn cycle the difference is that the vapor is super-heated after evaporating but the rest of the cycle is same. This is the most widely used technology in industry and the most intensively studied for automotive waste heat recovery applications. In the present study, this technology was chosen due to the extensive knowledge acquired and the relative easiness in constructing a prototype. Moreover Bianchi et al. [14] showed that the Rankine cycle provides better performances than other technologies.

3. Model of the Rankine - Hirn cycle

The model simulates a Rankine-Hirn cycle. Only sub-critical cycles are simulated. A calculation code was developed in Python [15] as the CoolProp database was used for fluid properties [16].

This system shown in Fig. 9 consists of an evaporator, an expander, a condenser and a pump. The waste heat, i.e. hot exhaust gases, is absorbed through the evaporator by a pressurized working fluid; in stage 1 to 2 it is isobaric heating. High pressure vapor is expanded in the expander and converted to mechanical energy; stage 2 to 3 is isentropic expansion. The expanded vapor is condensed in the condenser; stage 3 to 4 is isobaric cooling, and the low pressure liquid working fluid is pumped to the evaporator in stage 4 to 1 by isentropic compression. The cycle then starts again. The model was developed for a counter flow heat exchanger.

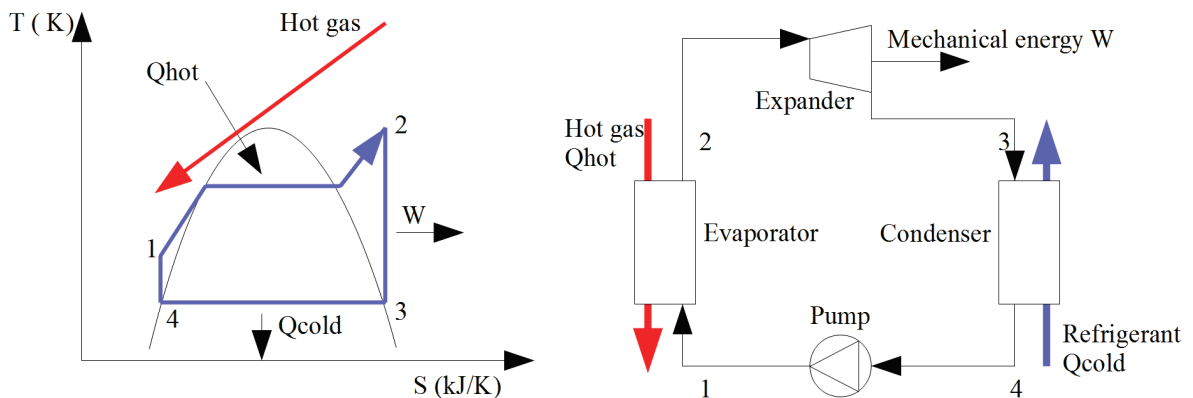

Fig. 9. Schematic diagram of the Hirn cycle

The pump work and the pressure drop in the circuit were neglected. The thermal capacity of exhaust gases was assumed to be constant $cp_{gaz} = 1,157 \text{ kJ/kg} \cdot \text{K}$. The pinch point method was used to calculate the results. Input parameters of the model are the following:

- Hot source temperature and gas mass flow
- Condenser temperature fixed at 100°C
- Surface A and heat exchange coefficients U of the hot heat exchanger
- Maximum and minimum pressure of the cycle
- Super-heating temperature

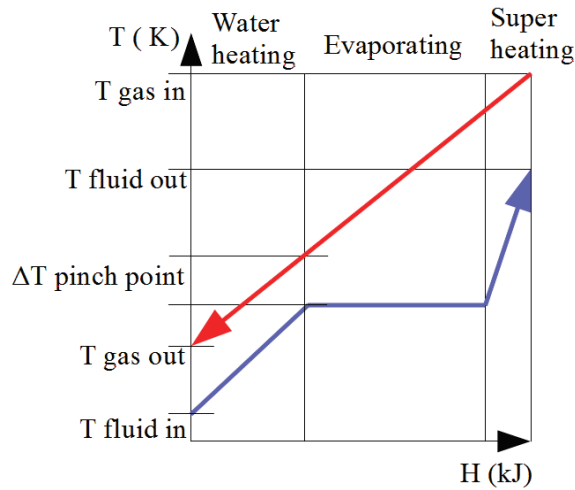

Fig. 10. Temperature evolution in the hot heat exchanger according to enthalpies exchanged

An iterative calculation links the pinch point and the surface of the heat exchanger. The LMTD or Logarithmic Mean Temperature Difference in each area of the exchanger in Fig. 10 was used to calculate the total surface A. This value is needed to calculate the heat flux in a heat exchanger. As the fluid heat capacity should be constant, this implies a three-zone heat exchanger model for each working fluid phase.

$$LMTD = \frac{((T_{gas\ out} - T_{fluid\ in}) - (T_{gas\ in} - T_{fluid\ out}))}{\ln\left(\frac{T_{gas\ out} - T_{fluid\ in}}{T_{gas\ in} - T_{fluid\ out}}\right)} \quad (1)$$

$$\dot{Q}_{exchange} = U \cdot A \cdot LMTD \quad (2)$$

$$\dot{Q}_{exchange} = \dot{m}_{gas} \cdot cp_{gas} \cdot \Delta T_{gas} \quad (3)$$

$$\dot{Q}_{exchange} = \dot{m}_{workingfluid} \cdot \Delta h_{workingfluid} \quad (4)$$

The power on the expander shaft is:

$$\dot{W} = \dot{m}_{workingfluid} \cdot \Delta h_{workingfluid} \quad (5)$$

The most interesting results to find the best operating point parameters are maximum power and global exergy efficiency. The thermal power available is calculated using the ambient temperature as the reference.

$$\dot{Q} = \dot{m}_{\sigma_{gas}} \cdot cp_{\sigma_{gas}} \cdot (T_{\sigma_{gas}} - T_0) \quad (6)$$

Applying the second law of thermodynamics, the maximum useful energy of the exhaust gases can be obtained.

$$\dot{E}x_{gas} = \Delta \dot{H}_{gas} - T_0 \cdot \Delta \dot{S}_{gas} \quad (7)$$

$$\Delta \dot{H}_{gas} = \dot{m}_{gas} \cdot cp_{gas} \cdot (T_{gas} - T_0) \quad (8)$$

$$\Delta \dot{S}_{gas} = \dot{m}_{gas} \cdot cp_{gas} \cdot \ln \frac{T_{gas}}{T_0} \tag{9}$$

$$\dot{E} x_{gas} = \dot{m}_{gas} \cdot cp_{gas} \cdot (T_{gas} - T_0) \cdot \left(1 - \frac{T_0 \cdot \ln \frac{T_{gas}}{T_0}}{T_{gas} - T_0} \right) \tag{10}$$

The global energy efficiencies are:

$$\eta_I = \frac{\dot{W}}{\Delta \dot{H}_{gas}} \tag{11}$$

The global exergy efficiencies are:

$$\eta_{II} = \frac{\dot{W}}{\dot{E} x_{gas}} \tag{12}$$

The best exergy efficiency is sought iteratively for each hot source temperature. The control parameters are the working fluid mass flow, pressure and the super heating temperature.

4. Results and discussion

Three fluids were analyzed: water, ethanol and R245fa. These fluids are the ones most commonly studied and used for Rankine – Hirm and organic Rankine cycles (ORC) [17-20]. The first objective was to find the best working fluid for our hot source temperature range which is 300°C to 500°C. This first study was conducted with no pressure limit and no super heating temperature limit. The heat exchanger surface was considered to be infinite.

This model was used to find the best global efficiency which corresponds to the maximum mechanical power produced by the waste heat recovery system.

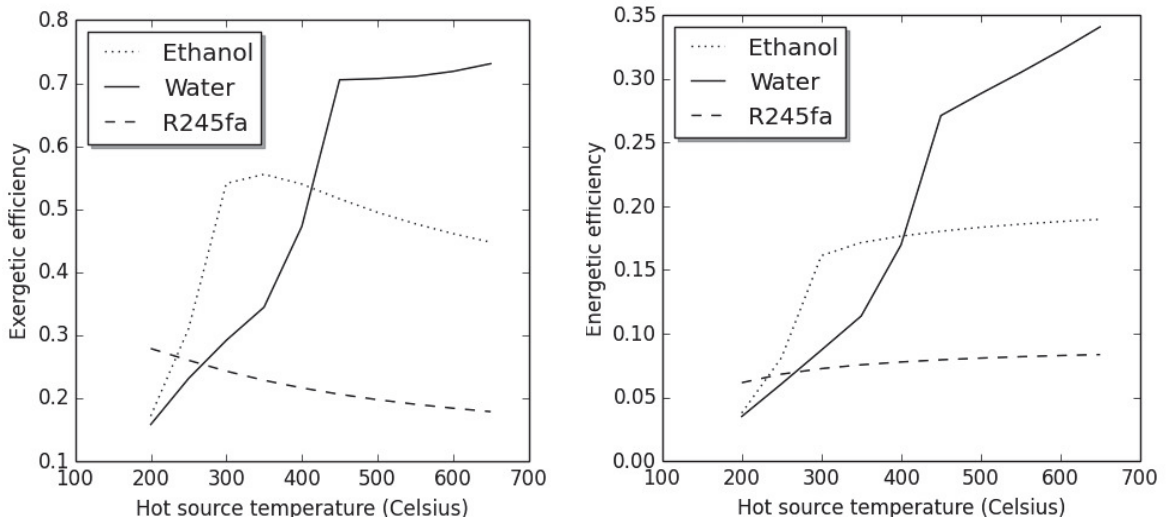

Fig. 11. Exergetic efficiency (η_{II}) of Hirm cycle without constraints. Cycle with super-heating.

The cold source was fixed at 100°C. This temperature was chosen because it is a value compatible with the engine coolant temperature and it is not necessary to depressurize the condenser for water. The same cold source temperature was used to study the other fluids.

The first simulation was conducted for a Hirn cycle, i.e. super-heating. It was found that each fluid performed better than the others within a limited range of hot source temperature (Fig. 11). R245fa performed better for a temperature below 200°C, ethanol was better within the range of 200°C to 400°C and water was preferable for temperatures above 400°C. R245fa does not appear to be efficient enough for the temperature range studied here, which is from 300°C to 500°C. The efficiency of ethanol increases rapidly up to a maximum around 350°C hot source and decreases after that. The efficiency of water increases significantly for higher temperatures than ethanol (450°C) but does not decrease after reaching its maximum. This first result shows that both ethanol and water are interesting for our temperature range: ethanol is the best fluid between 200°C and 400°C, and water between 400°C and 600°C. R245fa is unsuitable for the application considered here. These observations are in agreement with the findings of [21-23].

The marked increase in efficiency observed between 400°C and 450°C for water and between 250°C and 300°C for ethanol are in agreement with Chambadal's [24] observation on the Rankine cycle with water as working fluid. The marked increase appears when the heat source temperature exceeds the working fluid critical temperature by a few dozen degrees. The critical temperature of water is 373°C and of ethanol it is 241°C.

As these initial results did not enable us to choose between water and ethanol, we included some additional constraints. Firstly the heat exchanger surface was limited. Secondly since a real machine cannot in practice work at very high pressure, the pressure was limited to 30 bar and lastly the super heating was limited to 30°C higher than the evaporating temperature. The expander efficiency was fixed at 60%, which is the value aimed for by Daccord et al. [19]. Fig. 11 and 12 show the efficiency for ethanol and water with these constraints. The exhaust gases enthalpy was assumed constant for the two temperature ranges studied.

Table 1. Cycle characteristics

Condenser temperature	100°C
Maximum evaporator pressure	30bar
Super heating	30°C
Evaporator surface	1 to 16 m ²
Expander efficiency	60%

We wished to study two working points (see Fig. 1), a long high-power phase and a short, low-power phase. The characteristics of these two points are given in table 2.

Table 2. Tractor engine operating points

	Exhaust gases heat (kW)	Temperature (C°)
High load point	70	420
Low load point	20	300

These two exhaust gas powers are shown on Fig. 12 and 13. The efficiency at 20kW is greater than at 70kW due to the higher relative heat exchanger surface in the 20kW case. As in the first simulation, ethanol and water provide a better efficiency for different temperature ranges, i.e. under 400°C for ethanol and above 400°C for water. To determine which fluid to select, we compared the effect of the operating time at high and low load on the efficiency.

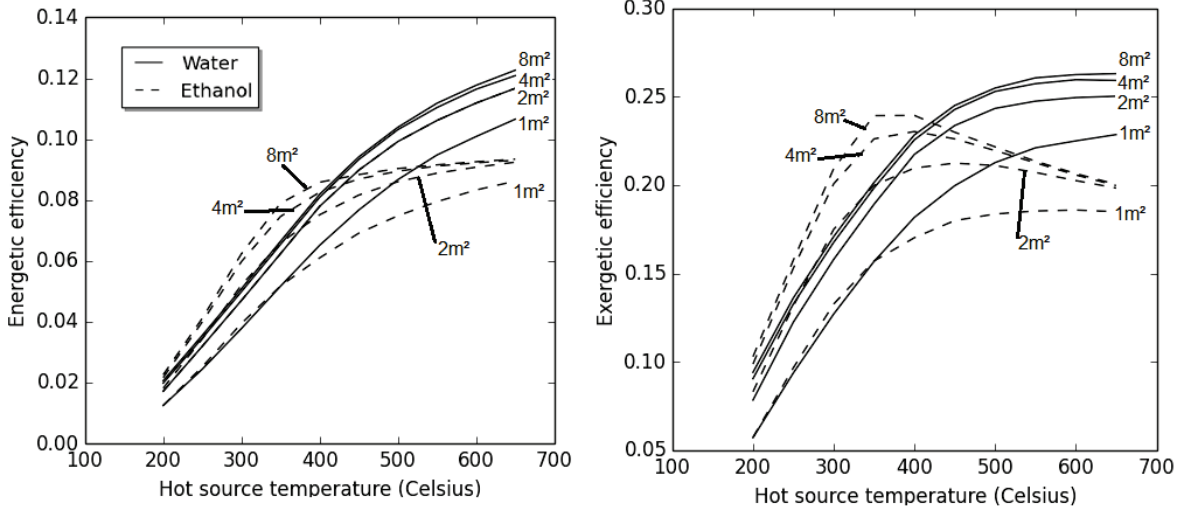

Fig. 12. Energetic and exergetic efficiency for different heat exchanger surfaces with water and ethanol for 20kW exhaust gas power.

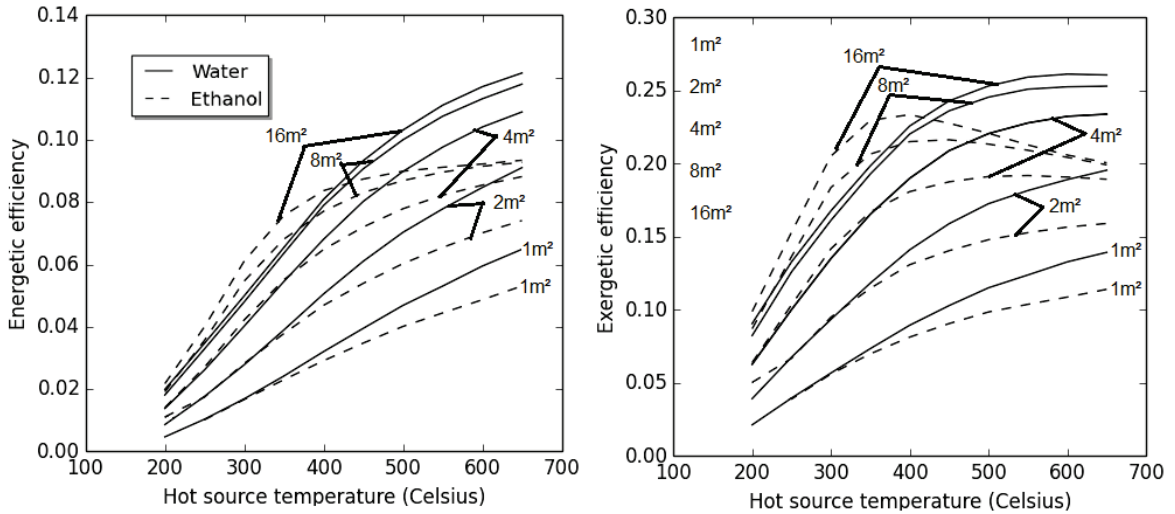

Fig. 13. Energetic and exergetic efficiency for different heat exchanger surfaces with water and ethanol for 70kW exhaust gas power.

The energy efficiency is plotted on Fig.14 versus time (in percent) at high load and low load. This diagram traces the energy efficiency of the waste heat recovery system from the case where the tractor operates constantly at low load to the case where the tractor operates constantly at high load. The most frequent case shown by Lacour et al.[1-2] corresponds to the 85% point. For this case water is the preferable fluid for each exchanger surface.

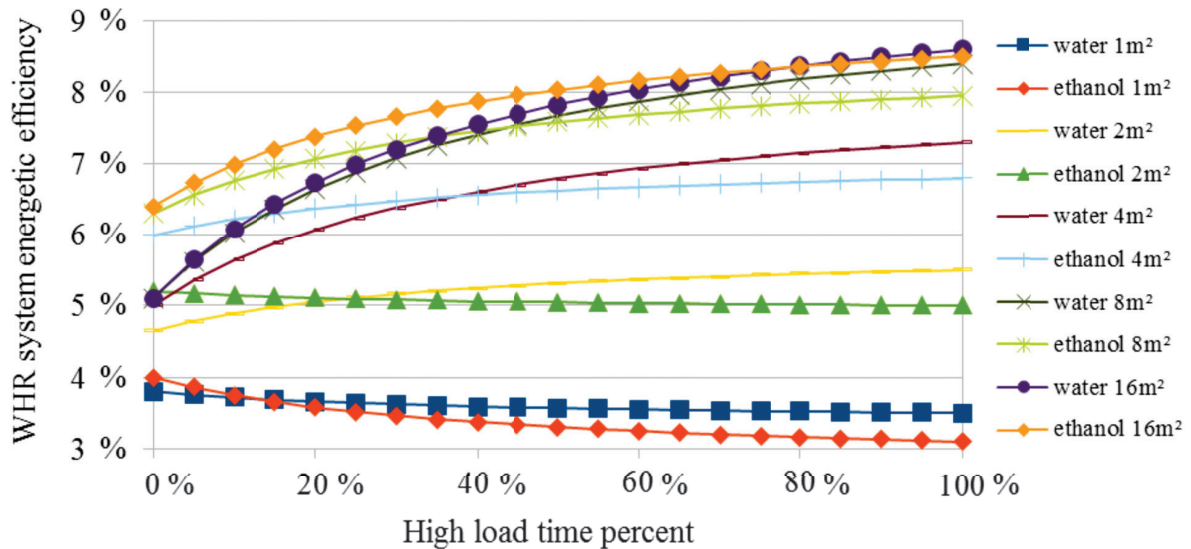

Fig. 14. Energy efficiency of waste heat recovery system as a function of the evaporator surface, fluid and high load operating time percent

Water is suitable for the high load point and ethanol for the low load point but it can be seen that for a 'small' heat exchanger, under 4m² here, the energy efficiency is less impacted by the engine load. Ethanol provides a better performance than water for low loads especially with a large heat exchanger but for a small exchanger, water is almost the best over the whole temperature range. In our case, defined as 85% at high load, water appears to be the best fluid but Fig. 13 shows that the operating mode needs to be precisely defined because the efficiency of the waste heat recovery system can vary with the load.

5. Conclusion

Environmental and economic constraints have obliged engineers and researchers to explore different ways to reduce energy consumption in all industrial sectors. One way to achieve this is waste heat recovery. It has been shown that the tractor is a good candidate to recover heat from exhaust gases. Among the various technologies available, hot gas engines such as Stirling and Ericsson engines can be used. Thermoelectricity and thermoacoustics are promising innovative technologies but they require further research before being exploited. The Rankine-Hirn cycle appears to be a good choice as the technology is well-established and widely applied. As different working fluids can be used, simulation is necessary to select the most suitable one. Simulation results showed that the best fluid depends on the hot source temperature. Based on this study, water and ethanol were selected, but the operating point of our application was not fixed. The influence of evaporator surface and of the high load time percent was therefore assessed. It was found that ethanol is preferable for low load and water for high load. The heat exchanger has of course a great influence on the efficiency and also on the threshold at which water becomes preferable to ethanol. For small heat exchangers, water performs better than ethanol over almost the whole operating range. For large exchangers, ethanol is interesting over the greatest operating range. Thorough knowledge of the operating mode is necessary to select the best fluid. In our application, this proved to be water. Further work is in progress to investigate transient phenomena, which were neglected in the present study.

References

- [1] Lacour, S., Burgun, C., Perilhon, C., Descombes, G., & Doyen, V. (2014). A model to assess tractor operational efficiency from bench test data. *Journal of Terramechanics*, 54, 1–18. doi:10.1016/j.jterra.2014.04.001
- [2] Lacour, S., F. M., & Podevin, P. (2012). Récupération d' énergie dans les gaz d' échappement d' un moteur diesel : Effet des phénomènes transitoires . COFRET'12, Sozopol.
- [3] Punov P., Lacour S., Podevin P., Perilhon C, "Possibilities of waste heat recovery on tractor engines", Proceedings of Scientific conference BulTrans - 2013, Sofia, 2013, pp. 7-15.
- [4] Milkov N., Punov P., Evtimov T., Descombes G., Podevin P, "Energy and exergy analysis of an automotive direct injection diesel engine", Proceedings of Scientific conference BulTrans - 2014, Sozopol, Bulgaria, 2014, pp. 149-154
- [5] Punov P., Perilhon C., Danel Q., Lacour S., Descombes G., Podevin P., Evtimov T., "Development of 0D simulational model for Rankine-Hirn cycle heat exchanger optimisation", Proceedings of Scientific conference BulTrans - 2014, Sozopol, Bulgaria, 2014, pp. 142-148
- [6] Bert, J. (2013). Contribution à l'étude de la vaporisation des rejets thermiques : étude et optimisation de moteurs Stirling.
- [7] Touré, A. (2010). Etude théorique et expérimentale— d'un moteur Ericsson à cycle TMde Joule pour TM conversion thermodynamique d'énergie solaire ou pour micro-cogénération.
- [8] Stouffs, P. Les moteurs à apport de chaleur externe. *10ème Cycle de Conférences CNAM/SIA, Mars 2009.*
- [9] Sebastien Bonnet. (2005). Moteurs thermiques à apport de chaleur externe : étude d'un moteur STIRLING et d'un moteur ERICSSON.
- [10] LeBlanc, S. (2014). Thermoelectric generators: Linking material properties and systems engineering for waste heat recovery applications. *Sustainable Materials and Technologies*. doi:10.1016/j.susmat.2014.11.002
- [11] Haddad, C., Périlhon, C., Danlos, A., François, M.-X., & Descombes, G. (2014). Some Efficient Solutions to Recover Low and Medium Waste Heat: Competitiveness of the Thermoacoustic Technology. *Energy Procedia*, 50, 1056–1069. doi:10.1016/j.egypro.2014.06.125
- [12] R.H.Thurston, (1882) Histoire de la machine à vapeur.
- [13] Sprouse, C., & Depcik, C. (2013). Review of organic Rankine cycles for internal combustion engine exhaust waste heat recovery. *Applied Thermal Engineering*, 51(1-2), 711–722. doi:10.1016/j.applthermaleng.2012.10.017
- [14] Bianchi, M., & De Pascale, A. (2011). Bottoming cycles for electric energy generation: Parametric investigation of available and innovative solutions for the exploitation of low and medium temperature heat sources. *Applied Energy*, 88(5), 1500–1509. doi:10.1016/j.apenergy.2010.11.013
- [15] G. van Rossum, Python tutorial, Technical Report CS-R9526, Centrum voor Wiskunde en Informatica (CWI), Amsterdam, (1995).
- [16] Bell, I. H., Wronski, J., Quoilin, S., & Lemort, V., Pure and Pseudo-pure Fluid Thermophysical Property Evaluation and the Open-Source
- [17] Quoilin, S., Aumann, R., Grill, A., Schuster, A., Lemort, V., & Spliethoff, H., Dynamic modeling and optimal control strategy of waste heat recovery Organic Rankine Cycles. *Applied Energy*, (2011).
- [18] E Barrieu, J Hergott A, R. (n.d.). Power from Wasted Heat : Challenges and Opportunities of Rankine Based Systems for Passenger Vehicles. In *ICE Powertrain Electrification & Energy Recovery*, (2013).
- [19] Daccord, R., Melis, J., Kientz, T., Darmedru, A., Pireyre, R., Brisseau, N., & Fonteneau, E. (2009). Exhaust Heat Recovery with Rankine piston expander. In *ICE Powertrain Electrification & Energy Recovery*, (2013).
- [20] Espinosa, N., Tilman, L., Lemort, V., Quoilin, S., & Lombard, B., Rankine cycle for waste heat recovery on commercial trucks: approach, constraints and modelling, In *ICE Powertrain Electrification & Energy Recovery*, (2013).
- [21] Maraver, D., Royo, J., Lemort, V., & Quoilin, S. (2014). Systematic optimization of subcritical and transcritical organic Rankine cycles (ORCs) constrained by technical parameters in multiple applications
- [22] O. Badr, S. D. Probert, P. W. O., Selecting a working fluid for a Rankine-cycle engine. *Applied Energy*, (1985).
- [23] Liu C., HenC., GaonH., Xun X., & Xu J. (2012). The Optimal Evaporation Temperature of Subcritical ORC Based on Second Law Efficiency for Waste Heat
- [24] Chambadal, P. Les centrales nucléaires, Armand Colin (1957).