



HAL
open science

Heats pipes for temperature homogenization: A literature review

Nicolas Blet, Stéphane Lips, Valérie Sartre

► **To cite this version:**

Nicolas Blet, Stéphane Lips, Valérie Sartre. Heats pipes for temperature homogenization: A literature review. Applied Thermal Engineering, 2017, 118, pp.490–509. 10.1016/j.applthermaleng.2017.03.009 . hal-01487695

HAL Id: hal-01487695

<https://hal.science/hal-01487695v1>

Submitted on 20 Mar 2019

HAL is a multi-disciplinary open access archive for the deposit and dissemination of scientific research documents, whether they are published or not. The documents may come from teaching and research institutions in France or abroad, or from public or private research centers.

L'archive ouverte pluridisciplinaire **HAL**, est destinée au dépôt et à la diffusion de documents scientifiques de niveau recherche, publiés ou non, émanant des établissements d'enseignement et de recherche français ou étrangers, des laboratoires publics ou privés.

Heats pipes for temperature homogenization: a literature review

Nicolas Blet, Stéphane Lips, Valérie Sartre

Univ Lyon, CNRS, INSA-Lyon, CETHIL UMR5008, F-69621, Villeurbanne, France

Abstract

Heat pipes offer high effective heat transfer in a purely passive way. Other specific properties of heat pipes, like temperature homogenization, can be also reached. In this paper, a literature review is carried out in order to investigate the existing heat pipe systems mainly aiming the reduction of temperature gradients. The review gathering more than sixty references is sorted into various application fields, like thermal management of electronics, of storage vessels or of satellites, for which the management of the temperature uniformity differs by the isothermal surface area, temperature ranges or the targeted precision of the temperature flattening. A summary of heat pipe characteristics for this function of temperature homogenization is then performed to identify their specificities, compared to other applications of heat pipes.

1. Introduction

The applications of heat pipes have increased over time, due to new thermal constraints for which standard cooling systems are more and more limiting. Based on an evaporation/condensation cycle, heat pipes exhibit a high effective thermal conductivity and offer the advantage of operating in a purely passive way. A heat pipe consists of a sealed container, a wick structure and an amount of a working fluid at liquid/vapor equilibrium. Heat is applied externally to the evaporator section and is released by an external heat sink at the condenser section. From the evaporator, the generated vapor is driven to the condenser thanks to the difference of pressure between the hot and cold sections. The liquid resulting from the condensation flows back to the evaporator by the capillary pumping created by the presence of the wick structure.

Specific properties of heat pipes with various sizes or shapes allow them to be used in various applications, as introduced in several literature reviews about heat pipe research and development [1-7]. For instance, Lips et al. [7] classified the type of heat pipes depending on whether the return of the liquid to the evaporator is gravity or capillary assisted. Other heat pipes, as rotating and pulsating heat pipes are also described. The diversity of the different kinds of heat pipe reflects the diversity of the applications in which they are used. The main function of heat pipes is to transfer high heat fluxes with a low temperature difference between the hot and the cold sources. However, other functions can also be used by choosing a specific type of heat pipe. Thus, heat pipes can be used for heat flux spreading, for thermal control, as thermal diodes or for temperature homogenization. Obviously, several of these functions can be combined in the same system. A short description of each function is introduced hereafter.

In most cases, heat pipes improve heat transfer between the heat source and the heat sink, especially when they are distant. Conventional heat pipes are able to transfer a power of around one kilowatt over a distance of about one meter. Loop heat pipes (LHP) can dissipate around 10 kW over several meters [8]. The most typical examples come from electronics cooling, from smallest components like chips [9] to largest power electronics like railway applications [10], via battery cooling [11].

Furthermore, when high heat flux densities are dissipated, heat pipes can assist in spreading the heat flux from the small surface of the evaporator section to a larger cooling surface. This function is widely used for electronics cooling. The typical heat pipes are here flat heat pipes, like vapor chambers [12-14], or solid plates with embedded conventional heat pipes or pulsating heat pipes [15-16]. A vapor chamber is a capillary-driven planar heat pipe with a small aspect ratio. If the condenser is above the evaporator, the wick is not necessary. The pulsating heat pipe (PHP) consists of a long capillary tube bent in many turns, looped or unlooped. Due to capillary action, the fluid is distributed

in vapor plugs and liquid slugs in the tube. Evaporation or boiling of the liquid slugs gives rise to strong oscillations of the fluid in the entire tube. Heat is so transferred from the heat sources to cold sections by latent heat and sensible heat.

Additionally, specific heat pipes, like variable conductance heat pipe (VCHP) or capillary pumped loop (CPL), can perform a thermal control. A VCHP is merely a conventional heat pipe linked to a reservoir filled with non-condensable gases (NCG) at the condenser. During heat pipe operation, NCG are rejected at the condenser by the vapor pressure. With an active regulation of the temperature or the pressure of the reservoir, the volume of NCG in the condenser can be modulated, as well as the heat exchange surface area of the condenser, leading to a control of the heat pipe thermal conductance. For a CPL, liquid and vapor phases flow in separate pipes. The porous structure is only located in the evaporator. The operating temperature of a CPL can be controlled by an active thermal or hydraulic regulation at the two-phase reservoir decoupled from the evaporator [17].

Heat pipes can also be used in special applications to allow a single direction of heat transfer, like a thermal diode. Most applications, like the preservation of permafrost [18-19], are based on the use of thermosyphons, heat pipes without porous structure. Here, the liquid can only return by gravity. No heat transfer is so possible when the evaporator is above the condenser. VCHP can also be used as a thermal switch. A passive regulation is indeed merely reached by the presence of NCG. At low temperature, they fill a larger volume thus degrading the heat pipe conductance. Conversely, at high temperature, NCG are compressed at the end of the condenser, increasing its conductance. By this way, during temporary non-dissipative periods, the equipment can keep its integrity by being insulated from the heat sink, when its temperature is too low [20-21].

Table 1 shows the various functions for which the various types of heat pipes are intended, presented above in addition to the classical heat transfer function. This last function requires capacity to transfer high heat powers over long distances, sometimes against gravity. These features are compared for each type of heat pipe in the first columns of the table. The implementation of heat pipes in industrial applications requires also additional features which are compared in the following columns: low cost, and ease of integration and sizing. For most heat pipes, except for PHPs for which the models are not available, the sizing is usually based on global expressions for calculations of heat power limitations and of the operating temperature. This type of model is sufficient when considering the heat transfer function. However, it is not suitable when considering the heat spreader function, because the heat pipe temperature distribution is often not precisely estimated: more advanced numerical modeling are required in that case, along with a specific spatial discretization. Some references are given to the reader in Table 1 for more explanations about the development of these models.

Table 1 - Summary of the advantages (+) and drawbacks (-) of each type of heat pipe

Type of heat pipe	Characteristics of heat pipe							Sizing
	Additional functions	Maximum heat power	Distance evaporator - condenser	Impact of gravity	Cost	Integration		
Capillary heat pipe	Heat transfer spreading Thermal control (VCHP) Thermal diode (VCHP)	-	-	-	+	-	+	<i>Existence of global analytical expressions of heat power limitations and some numerical models [22-23]</i>
Thermosyphon	Thermal diode	++	++	--	++	-	+	<i>Existence of global analytical expressions of heat power limitations and some numerical models [22-23]</i>
Flat heat pipe	Heat transfer spreading	-	--	-	-	-	+	<i>Models based on works developed for capillary heat pipes and thermosyphons and adapted to flat geometry</i>
Loop heat pipe	Thermal control (CPL)	+	+	+	--	+	-	<i>Strong thermohydraulic couplings between the loop parts / Existence of some analytical expressions of operating temperature and some numerical models [6, 24-25]</i>
Pulsating heat pipe	Heat transfer spreading	+	-	++	+	-	--	<i>Unsteady phenomena / Analytical or numerical models still poorly developed [26-29]</i>

Contrarily to previous review papers that mainly focused on heat transfer performances of heat pipes, the present paper specially highlights the isothermal function of heat pipe systems. To complete information of Table 1, the focus is done on the reduction of thermal gradients (in K/m), rather than speaking in terms of thermal resistances (K/W) or heat flux densities (W/m²). By its intrinsic nature, based on a liquid/vapor phase change phenomenon, a heat pipe indeed operates at a quasi-uniform temperature. The temperature difference of the vapor between the two extremities is linked to the pressure difference, which is usually very small. Thus, the global thermal resistance of the heat pipe mainly depends on the fluid/wall thermal resistances at evaporator and condenser, which main contribution is due to conduction through the capillary structure. Usually, the total thermal resistance is lower than 1 K/W. A literature review is performed about the different technologies of heat pipes mainly designed to reduce temperature gradients, between two parts of a same piece or between several pieces. In the first part of the article, technologies are sorted into various application fields: thermal management of electronics, solar collector optimization, temperature homogenization of storage and reactive vessels, integration in metrology systems, specific avionic applications, and spatial applications. For each application field, a table gathers the mean characteristics of the heat pipes used for temperature homogenization. For each reference, the type of heat pipe, the fluid, the materials of the envelope and of the potential wick structure, the operating temperature range of the heat pipe, the characteristic dimensions of the isothermal zone and the evaluated data about the temperature gradient (direction, value without heat pipe, value with heat pipe) are summarized. In the second part of the article, a general summary of heat pipe characteristics listed for this particular function of temperature gradient reduction is carried out.

2. Fields of application of heat pipes for temperature homogenization

2.1 Thermal management of electronic components

With the miniaturization of chips, the improvement of the cooling capacity for electronics become essential. Indeed, heat flux densities increase more and more and cannot be dissipated by standard systems based on air convection. An ineffective cooling would lead to an excessive temperature of the junction and thus to a drastic decrease of the lifetime of the component. For example, heat dissipation in light-emitting diodes (LED) can lead to a brightness reduction or a shift in wavelength [30]. Heat pipes appear very effective, on one hand, to evacuate heat dissipation up to 100 W/cm^2 [31] to distant heat sink, and on the other hand, to reduce hot spots by temperature flattening. Small surfaces, lower than 0.01 m^2 , are here involved and undergo local temperature gradients from 0.1 K/mm to several K/mm . The temperature homogenization is usually associated to a spreading of the heat flux. According to the literature, two main designs of flat heat spreader are used for such applications: a solid plate with embedded heat pipes or a vapor chamber.

2.1.1 Embedded cylindrical heat pipes or pulsating heat pipes

The easiest solution is to thermally link the electronic card to a metallic plate in which standard heat pipes are embedded.

According to studies of Campo et al. [32] about cooling of electronic boards, heat pipes were chosen rather than forced convection by air or liquid, to avoid risks of dust-clogged fans, electric power losses, or liquid line leaks (Figure 1.a). Standard curved copper/water heat pipes are embedded in the aluminum plate on which standard 3U-size cards ($100 \times 120 \text{ mm}^2$) are located. Additionally, a plate with straight heat pipes is bolt on the chassis where electronics cards are slid in rails. This plate aims to reduce temperature gradient between the cards and to spread heat from electronics to the liquid cooled baseplate located under the chassis. The new design of the system with heat pipes has the advantage not to require large modifications of the mechanical or electrical previous designs. According to numerical results, the temperature gradients at the cards surface are reduced by 0.5 K/mm , corresponding to a decrease of temperature peaks from 137°C to 109°C . The heat spreader on the chassis reduces the temperature gradients in the vertical direction from 0.25 K/mm to 0.06 K/mm and decreases the maximum temperature of the chassis from 95°C to 71°C .

For similar objectives, some authors, like Hsu [33], patented a plate with embedded cross heat pipes for a 2D- or 3D-homogenization of temperatures (Figure 1.b). Two designs were proposed: in the first one, cylindrical grooves were machined on both sides of the plates; in the second one, the network of grooves was machined on a single side. Experimental tests highlighted a too high thermal contact resistance between the flat heat source and the nearest row of heat pipes in the first designed plate. The new concept with the network of heat pipes on the side of the plate opposite to the heat source overcomes this problem.

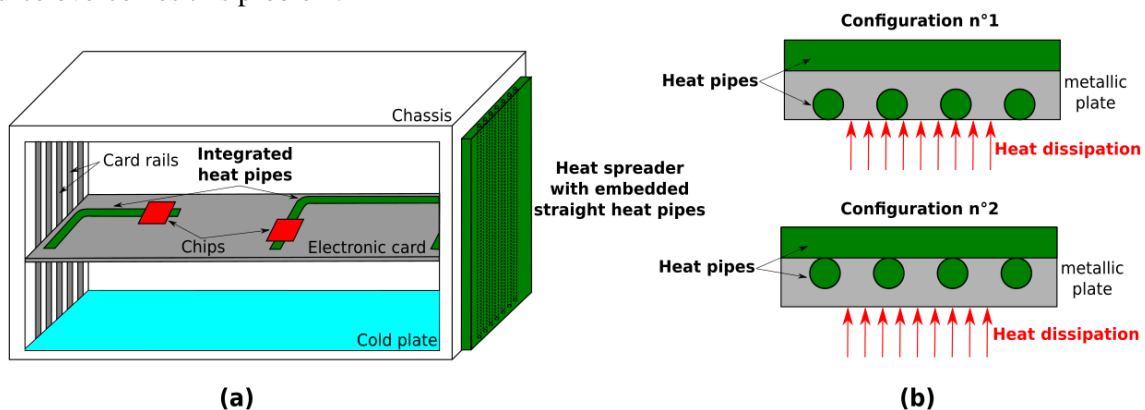

Figure 1 – Scheme of integration of heat pipes for electronics: (a) electronic cards slid in protective chassis (from [32]), (b) isothermal plate module (from [33])

At the same time, micro heat pipes have been developed to increase the cooling efficiency of small-size electronic devices. The operation of these system of few millimeters diameter is however greatly influenced by the wick structure, orientation, vacuum degree and the fluid fill charge. According to the work of Tang et al. [34] on copper/water micro-grooved heat pipes of 24 cm of length, the homogenization of temperature proves to be better for a low filling, for operating temperatures between 30°C and 60°C. Furthermore, the mean temperature difference between condenser and evaporator is greatly reduced, thanks to a second vacuuming.

Some others heat pipes, like the PHP, can be easily integrated in a metallic plate for the cooling of electronics. For example, Hemadri et al. [16] studied the efficiency of aluminum and steel plates with an embedded copper/water PHP (2 mm in diameter and 22 bends) having fluid fill charge of 60%. The plates placed in vertical position, with the heat source at bottom are cooled by natural convection and radiation. IR visualization and numerical results highlight that the reduction of temperature gradients is improved for metallic plates with a low thermal conductivity (or low Biot number). For example, the temperature gradient in the vertical direction is almost halved for the steel plate, from 0.19 K/mm for a plain plate to 0.11 K/mm for the plate with the integrated PHP. Furthermore, the temperature flattening ability increases with the heat power. Nevertheless, the PHP has a very low impact on the thermal behavior of the aluminum plate, because of the intrinsic great thermal conductivity of aluminum. Furthermore, other experimental and numerical tests highlight that the orientation of the PHP affects the efficiency of the heat transfer, because of the change of internal flows and oscillations.

2.1.2 Vapor chambers

The second main solution to reduce temperature gradients of electronics is to use a vapor chamber as a heat spreader, for example, to cool printed circuit boards (PCB). Here, the flat heat pipe is directly embedded in the PCB and replaces the metallic plate to enhance the effective thermal conductivity. Thus, for a same dissipated heat flux, the maximum temperature is reduced.

Works of Fan et al. [35] highlight that a vapor chamber (Figure 2.a) is more efficient than systems with thermal vias through the epoxy (Figure 2.b) or with aluminum plate (Figure 2.c), to dissipate heat and to homogenize the temperatures of 2.7 cm² PCBs. Computational fluid dynamics results prove that the vapor chamber reduces the in-plane temperature gradient, from 0.9 K/mm and 0.4 K/mm, respectively for the design with vias and for the plain plate, to 0.1 K/mm for the PCB with heat spreader. The axial heat conduction between the PCB and the heat sink is thereby improved: the temperature gradient is 2.2 K/mm, against 4.2 K/mm for the aluminum plate and 15.6 K/mm for the system with vias.

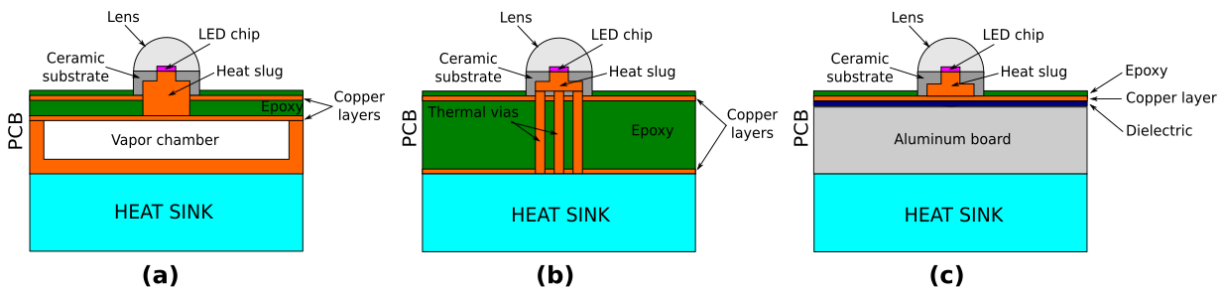

Figure 2 - Diagrams of different LED chip packages: (a) with integrated vapor chamber, (b) with thermal vias, (c) with metallic board (from [35])

Several other studies and patents compare the use of vapor chambers instead of a metallic plate for larger surfaces. For example, the high-efficiency aluminum/acetone vapor chamber patented by Sun et al. [28] decreases the temperature difference by 8 K on an aluminum surface of 263 cm² heated by a centered source of 17 cm². It corresponds to a reduction of the temperature gradient from 0.06 K/mm for the plain plate to 0.01 K/mm for the vapor chamber. A decrease of 10 K on the mean temperature

is measured by Wang et al. [31] for a 16 LED chips package of 64 cm² equipped with a copper/water vapor chamber, comparatively to an aluminum baseplate. IR visualizations clearly reveal the presence of hot spots at each chip on the aluminum back surface of the standard baseplate, while a rapid temperature homogenization happens with the vapor chamber baseplate. Finally, an experimental study on a similar vapor chamber performed by Boukhanouf et al. [12] proves the efficiency of such system to flatten the temperature of a 50 cm² heat source by spreading heat to a 500 cm² heat sink. The IR images of the hot copper surface (Figure 3) highlight a decrease of the in-plane temperature gradient from 0.32 K/mm for a solid copper plate to 0.08 K/mm for the evaporator of the vapor chamber, along with a reduction of the maximum temperature of the heat source of more than 10 K.

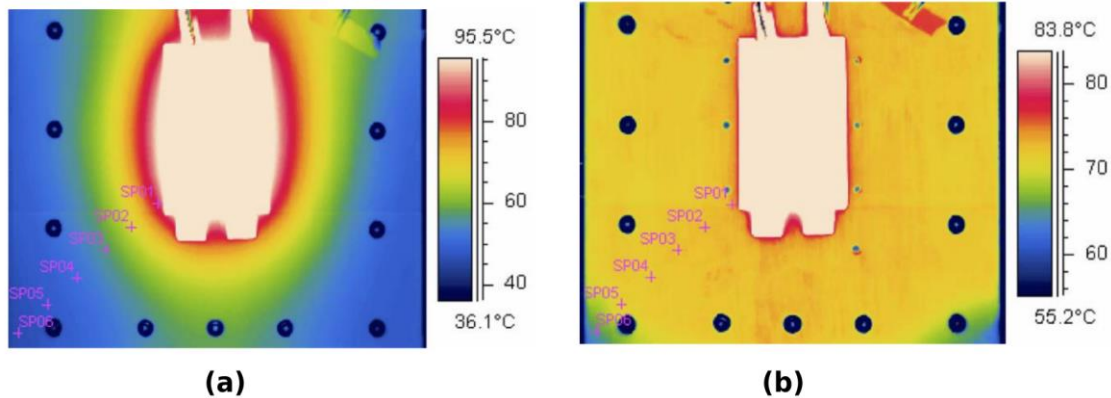

Figure 3 – IR images of the hot surface temperature at 28 W/cm² [12]: (a) solid copper plate, (b) evaporator of the vapor chamber

Reyes et al. [13] emphasize the weight gain with the flat heat pipe technology (between 10% and 20% for the same heat dissipation) compared to the metallic plate. Additionally, a specific spreader design [36], based on the division of the vapor core by parallel porous walls, can improve the mechanical strength of the system during vacuum, filling and operating phases because of vapor overpressures.

The worst disadvantage of a vapor chamber can be the negative effect of the gravity on its operation [14]. In horizontal position, the fluid is indeed uniformly in-plane distributed if the capillary pumping of the wick is sufficient. In vertical position, if the heat source is at the center of the vapor chamber, the vapor flow is divided into a gravity assisted up flow and a gravity opposed down flow. This phenomenon can involve a temperature gradient disparity between the top and the bottom of the vertical vapor chamber. However, it seems that the temperature uniformity is well preserved for thin vapor chambers, like those used in electronics. For example, Tsai et al. [14] studied an 81 cm² copper/water vapor chamber, of 2 mm internal thickness, under various inclinations. The same temperature gradients were measured for both horizontal positions, favorable (evaporator below) and unfavorable (evaporator above). The tested inclinations had insignificant effects on the temperature homogenization, since a maximum difference of 5% on the temperature gradients (on the order of 0.04 K/mm) was recorded between vertical and horizontal positions.

Another possible drawback of the vapor chamber is the occurrence of a leak. Indeed, due to the flat design, vapor chambers cannot sustain operating pressures as high as cylindrical geometries. It increases the risk of leak and of the loss of a large part of the fluid charge. This phenomenon strongly deteriorates the efficiency of the heat pipe. A defective vapor chamber is indeed less effective than a solid metallic plate. For example, a hollow aluminum plate tested by Sun et al. [36], at the same conditions as above, sustains a temperature gradient of 0.12 K/mm, twice as high as the gradient of the plain plate. The defective vapor chamber of Boukhanouf et al. [12] exhibits a thermal gradient of 0.4 K/mm, against 0.32 K/mm for the solid plate. However, the thermal resistance between the

evaporator and the condenser of the defective system decreases with the increase of the heat power, thanks to a residual presence of liquid in the porous media.

2.1.3 *Summary*

Electronic components can dissipate high heat flux densities. Heat pipes can be used to transfer the heat to a distant heat sink, but they are also widely used as a thermal spreader. In this configuration, their role is to homogenize the temperature of the heat sink itself, for instance a finned area, in order to increase its efficiency. According to the synthesis provided in Table 2, it concerns small surface areas (lower than 0.01 m²), for temperature ranges limited between 10°C and 130°C. The temperature gradients are reduced on average from 1 K/mm without heat pipe to 0.1 K/mm with integrated heat pipe. For this kind of application, capillary heat pipes and flat heat pipes are well adapted.

2.2 *Solar collector optimization*

2.2.1 *Introduction*

Heat pipes are used to improve the efficiency of solar collectors, corresponding to the ratio between the solar radiation that reaches the effective area of the collector and the heat flux provided to the coolant. This fluid can be directly the domestic water or the heating air, but also a working fluid (usually oil or steam) to produce electrical energy via an external power system. Two main types of conventional solar collectors can be found. Both consist in the circulation of the coolant over the entire surface of the collector to recover heat from the absorber surface (Figure 4.a). The first design is the flat plate collector. The cooling pipe is directly brazed to the flat plate absorber. This absorber is placed in an insulated casing with a glass cover, transparent to the solar radiation and opaque to infrared radiation to generate the greenhouse effect. The second design is the evacuated tube collector. The cooling pipes are in a vacuum transparent tube placed on a reflector. The vacuum reduces heat losses due to natural convection. The drawbacks of all these collectors are a high pumping requirement due to pressure drops in the system, large heat losses by natural convection (for flat plate collectors) and by radiation from the collector surface, and for water systems, a possible occurrence of freezing during cold days, corrosion and scale formation inside the pipes. All these issues lead to a non-uniform distribution of the temperature, in-plane for the flat collectors, circumferentially and axially for the evacuated tube collectors, involving a decrease of the system efficiency.

Even if all types of heat pipes are used in heat recovery and renewable energy applications [37], cylindrical heat pipes and vapor chambers are the most common systems used for solar collectors. The primary purpose is to decrease the thermal resistance between the absorber and the coolant. Heat pipes are embedded in the absorber and replace the cooling pipes over its entire surface (Figure 4.b). The collected heat is increased by the temperature homogenization and is transported from the heat pipe to the coolant via a heat exchanger localized at the top of the system. Thus, the temperature is flattened along the collector length. In the case of inclined collectors equipped with thermosyphons, the temperature flattening is further associated with a thermal diode effect, avoiding a reversed cycle during cloudy periods of the day and the night, what was possible with conventional collectors.

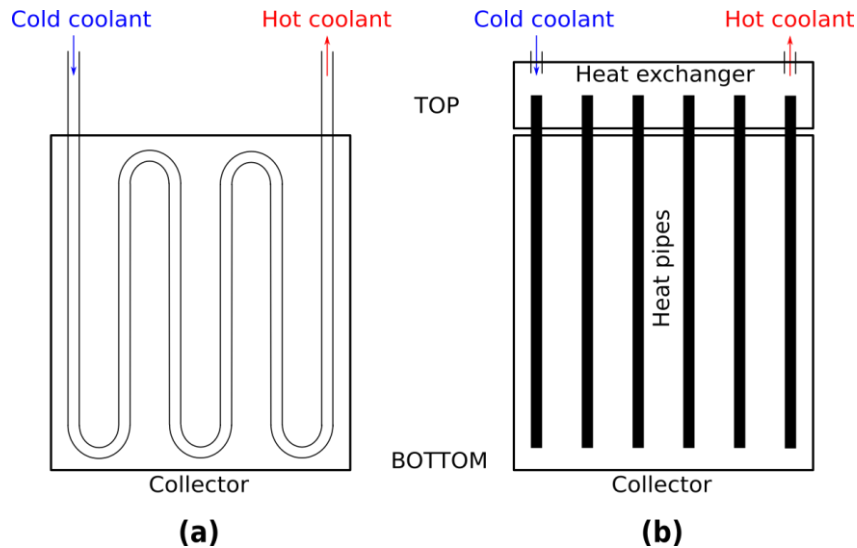

Figure 4 - Comparison diagrams between solar collectors: (a) conventional, (b) with heat pipes

Most studies unfortunately give very few data about temperature distributions of the absorber and do not allow to estimate the temperature gradients. Authors usually mention that the temperature field of the absorber plate is well uniform to ensure the relevance of a correct calculation of the system efficiency.

2.2.2 Embedded cylindrical heat pipes or pulsating heat pipes

The problematic of a conventional evacuated tube collector without heat pipe is the circumferential gradient of temperature. Indeed, the upper part of the system receives the direct solar heat, more intense at the middle of the day, whereas the lower part receives the solar heat reflected by the parabolic trough, more intense in the morning and in the evening. In the case of Direct Steam Generation (DSG) systems, the circumferential temperature difference may reach up to 60°C [38]. Cylindrical heat pipes can be easily embedded in such collectors (Figure 5). The temperature distribution is proven to be well uniform for the carbon steel/naphthalene thermosyphon of Liu and Zhang [38]. The longitudinal temperature gradient is around 0.01 K/mm at the absorption section of the collector, for a temperature range between 200°C and 400°C. Furthermore, it does not vary with the mode of application of the heat radiation (semicircular heating or complete lateral heating) and with the tilt (between 4° and 8° relatively to the horizontal).

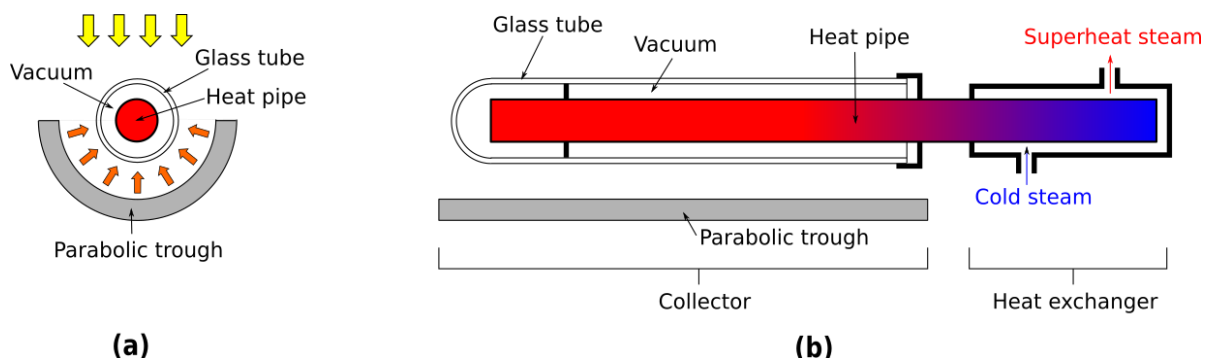

Figure 5 – Diagram of evacuated collector with embedded heat pipe (from [38]): (a) cross-section of absorber, (b) lengthwise section

Standard cylindrical thermosyphons are also used in flat plate collectors, especially for domestic water heating applications, with a temperature range between 0°C and 100°C. In these collectors, the main temperature gradient is recorded in the direction of the fluid flow. The parallel tubes can be connected to each other by a bottom and an upper horizontal headers. The upper collecting pipe is

integrated into the heat exchanger to transfer the absorbed heat from the collector to the coolant loop. Heat pipes can be integrated in the absorbing plate in various ways [39]. They can be located under [40] or in the middle [41-42] of the absorber plate. They are either bonded [42] or directly integrated [40] in the structure (Figure 6). Efficiencies of such collectors are around 0.65. By performing an additional vacuuming between the absorber plate and the protective glass, Wei et al. [42] improved the efficiency, from 0.66 to 0.73, for a collector with fifteen bonded thermosyphons filled with ethanol. Hussein et al. [41] highlighted that an elliptic cross section improves the performance of copper/water thermosyphons welded in the middle of the absorber plate, at low filling ratios (under 10%).

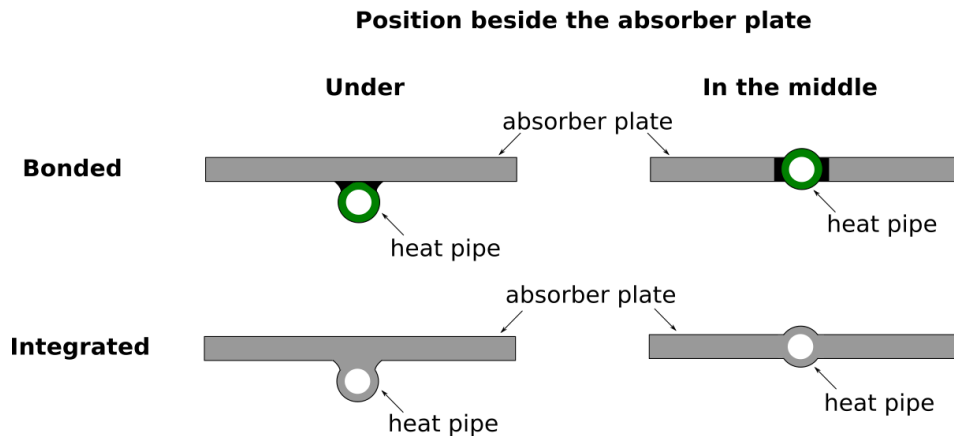

Figure 6 - Different embedding of cylindrical heat pipes beside absorber plate of flat plate collectors

Other original prototypes can be found in the literature like the flat plate collector of Rittidech and Wannapakne [43] for domestic water heating. The collector includes a copper closed-end oscillating heat pipe, 3 mm in diameter and 70 m in length, with fourteen turns, soldered to the 2 m² collecting plate. Experimental tests with R134a as working fluid, a filling ratio of 50% and an inclination of 18° relatively to the horizontal, demonstrated an efficiency of 0.62, comparable to the one of the standard heat pipe collectors. The introduced PHP offers the additional advantages of simple construction and corrosion free operation.

2.2.3 Vapor chambers

For flat plate collectors of small surface areas (lower than 0.1 m²), vapor chambers can be used for an in-plane temperature homogenization and additionally to reduce the thermal inertia of the collector. The absorbent thin plate covers here the top surface of the vapor chamber. Facao and Oliveira [44] recorded a thermal efficiency of 0.64 and an inertial time of 7 minutes with their collector. Several specific shapes of flat heat pipes have been proposed to increase the thermal and hydraulic performances of solar collectors. Deng et al. [45] introduced a micro-channel array in the vapor chamber. The temperature difference was less than 1 K all over the surface, corresponding to a thermal gradient of around 1 mK/mm. The global efficiency of the collector was increased up to 25%, compared to a standard collector.

2.2.4 Summary

Embedded heat pipes in solar collectors are first of all used to reduce the thermal resistance between the absorber plate and the coolant. They enable to increase the global efficiency of the systems by limiting the heat losses to the ambient. The temperature homogenization mainly occurs following one direction and concerns medium surfaces area, between 0.1 m² and 2 m² (Table 3). The temperature gradients are lower than 0.01 K/mm, even if very few information about temperature distributions of the absorber are provided in the literature. Thermosyphons are particularly adapted to the stationary solar system applications thanks to their size and their general geometry.

2.3 Temperature homogenization of storage vessels, reactors and furnaces

Homogenization of temperature in storage or reaction vessels increases their efficiency [46] and the quality of the products. For example, in some silos, the temperature of lower layers of grains can be 10 K higher than the temperature of the upper ones, and moisture can appear [47]. The reduction of temperature gradients enhances the performance of heat storage tanks during the phases of heat removal or recovery too [5]. In chemical reactors, the temperature flattening improves the catalysis of products. Standard systems are usually based on an external heating of the reaction tubes. In some cases, this process leads to deactivate the catalysis at the reactor inlet, or to mechanical failures of the tubes because of a too sudden heating [48]. Strong temperature gradients can further significantly slow the chemical reaction. In addition to the temperature flattening, size and mass of the reactor can be reduced with the implantation of heat pipes. Finally, in the case of furnaces, isothermal conditions can be desired, for example, to avoid risk of malformation of products elaborated by melting [49].

Two main types of heat pipes are found in the literature. Vessels or furnaces can be embedded in the core of annular heat pipes, usually placed in horizontal position. In that case, the external surface area of the vessel are lower than 0.01 m². To homogenize temperatures of the volume of a chemical or storage reactor, vertical thermosyphons are selected. Thanks to additional external fins, heat pipes can homogenize big volumes, up to several tens of cubic meters.

2.3.1 External annular heat pipes

The annular capillary heat pipes are often closed containers formed by the external wall of the vessel and a larger coaxial tube (Figure 7). The annular section is usually divided in several vapor channels separated by a screen mesh wick, in order to ensure a good mechanical strength and a high capillary pumping of the heat pipe.

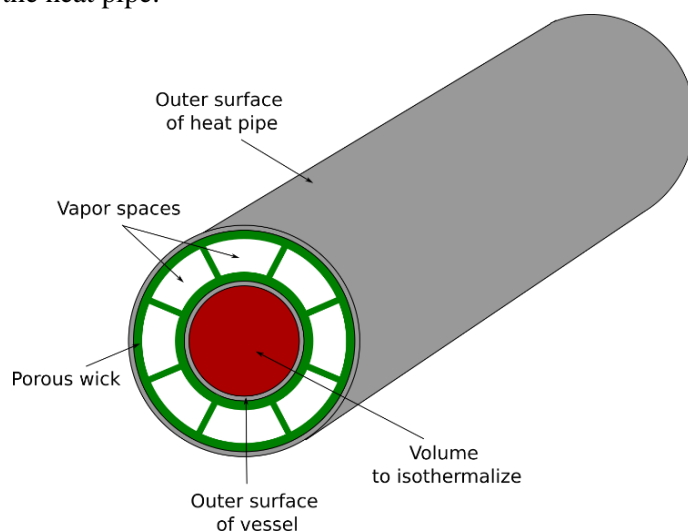

Figure 7 – Diagram of annular capillary heat pipe for vessel

The stainless steel/sodium heat pipe of Parent et al. [50] (inner diameter of 2 cm and outer diameter of 4.1 cm) decreases the maximum lengthwise temperature gradient of their 3 m long reactor to 0.01 K/mm, compared to 0.06 K/mm with a conventional cooling. The efficiency of the catalysis of naphthalene is thus improved. The stainless steel/naphthalene heat pipe of Choi et al. [49] provides a longitudinal and circumferential temperature flattening of a furnace, which outer diameter is 159 mm and length is 200 mm. To secure the design of sintered porous pieces from copper nanoparticles, the technique requires isothermal conditions to avoid mechanical deformation of the final product. The temperature gradients are estimated at 0.02 K/mm despite a heterogeneous heating, only supplied to

the lower part of the furnace. Experimental results highlighted a very good temperature stability, around 200°C or 300°C.

2.3.2 Internal heat pipes

The second solution for temperature homogenization is to put the heat pipe, often a thermosyphon, inside the vessel (Figure 8). In the case of heat storage containers, the condenser of the heat pipe is located outside the vessel, and acts as a heat exchanger to release the stored heat to the coolant, like domestic water, for example (Figure 8.a). During inactive periods (no coolant flow), heat losses of the container are reduced thanks to the thermal diode function of the thermosyphon. To improve temperature homogenization in the radial direction of the tank, standard metallic fins or flat heat pipes can be added, as patented by Le [51] and illustrated in Figure 8.a. For chemical reactors, the evaporator of the thermosyphon is located outside the vessel to supply the required heat for the catalysis (Figure 8.b). The purpose is mainly here the improvement of the temperature uniformity to assist in the catalyst.

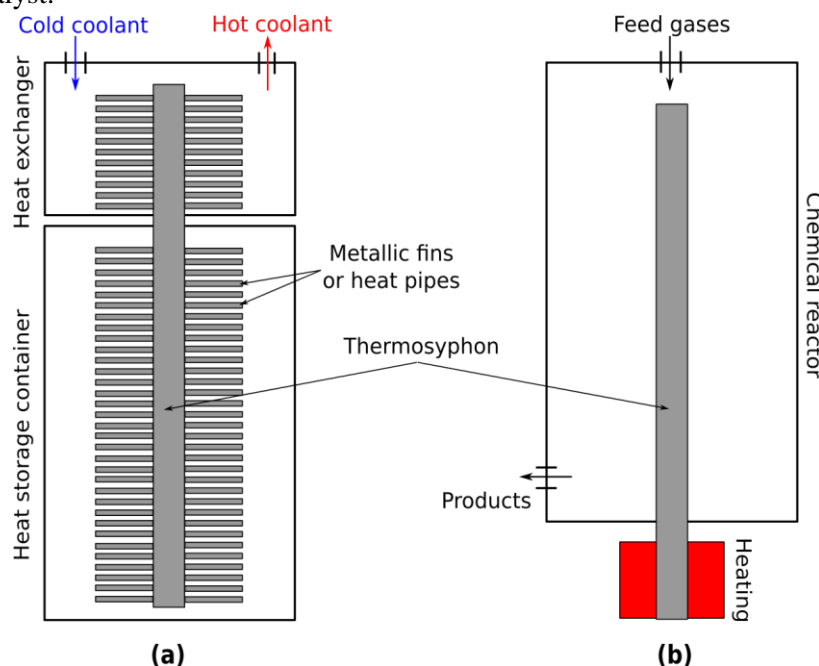

Figure 8 – Diagrams of vertical vessels with embedded thermosyphon: (a) heat storage container, (b) chemical reactor

Reay [5] highlighted the efficiency of a copper/water thermosyphon with external fins in a tank of erythritol, a phase change material (PCM). The heat pipe especially boosts the solidification time of the PCM thanks to a better temperature uniformity of the tank. Temperature gradient along the vertical axis is decreased to 0.22 K/mm, compared to 0.39 K/mm with a same-sized copper tube. In the reactor of Richardson et al. [48] for methane reforming (temperature range between 600°C and 1000°C), a faster heating is achieved with the improvement of the heat dissipation to the reactants by an Inconel/sodium thermosyphon. The achieved lengthwise thermal gradient in the 1.83 m long catalyst bed is 0.03 K/mm. To improve the liquid distribution, four 3.2 mm wide helical grooves have been machined at the condenser section of the thermosyphon and two types of porous layers made from stainless steel screen are placed at the evaporator. Infiltration of non-condensable gases coming from the reaction mixture into the heat pipe is specially considered. Indeed, Richardson et al. [48] detected a hydrogen infiltration during the first reduction of the catalyst, using dry hydrogen. A progressive obstruction of the condenser led to a difficulty to maintain a constant temperature.

Finally, Wang et al. [52] studied a high temperature special-shaped heat pipe (HTSSHP) incorporated in a solar reactor designed to produce Zn from thermal reduction of ZnO particles in solar dish systems (Figure 9.a). The solar reactor consists of a compound parabolic concentrator (CPC), a quartz window, a heat absorber chamber, the HTSSHP and a reaction chamber. The HTSSHP consists of four cylindrical heat pipes (CHP) mounted on a flat heat pipe (FHP) made of stainless steel and filled with sodium (Figure 9.b). The FHP is thermally linked to the heat absorber chamber, whereas the CHPs are located in the reactor chamber. A double wick structure is machined within the HTSSHP: triangular channels aim to decrease the return flow resistance of condensate, and metal felts covering the grooves provide capillary pumping forces for the diffusion of the working fluid. The role of the heat pipe is mainly the temperature homogenization of the absorber and reaction chambers to improve the reliability and thermal shock resistance of the solar reactor, while increasing its efficiency, as compared to a standard indirect solar reactor. Experimental tests on the HTSSHP alone highlight the existence of a temperature gradient around 1.8 K/mm along the CHPs in natural convection conditions. However, a great uniformity of temperatures is reached in forced convection conditions, corresponding to a normal operation of the reaction chamber, with a longitudinal temperature gradient of around 0.3 K/mm. The FHP can reduce the temperature difference of the heat absorber from 190 K to 85 K, corresponding to a decrease of the in-plane thermal gradient from 2.4 K/mm to 1.1 K/mm, by inhibiting the hot spots due to an uneven solar radiation.

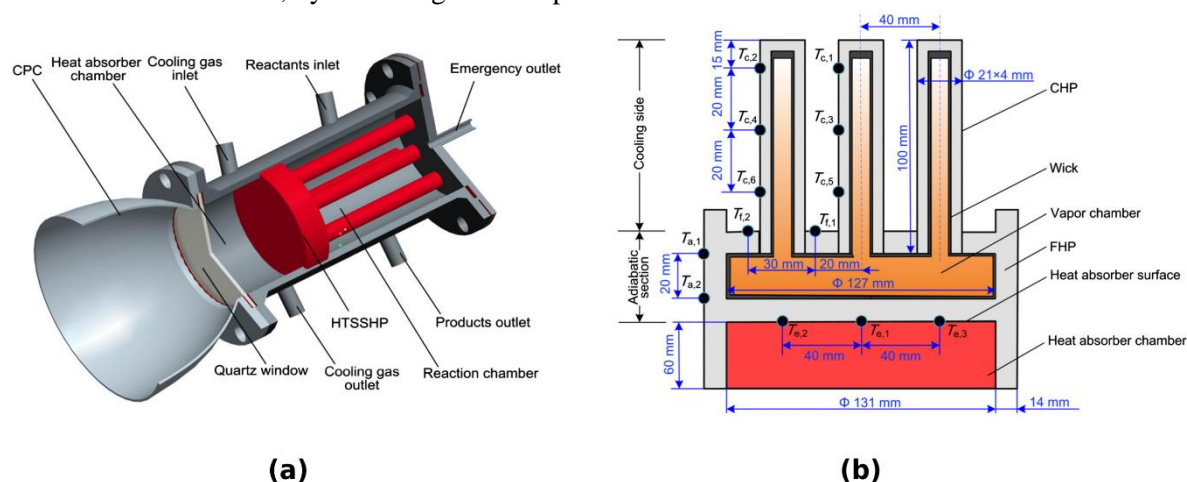

Figure 9 - High temperature special-shaped heat pipe [52]: (a) schematic view of the solar reactor with the integrated heat pipe, (b) structure of the heat pipe

2.3.3 Summary

Heat pipes are integrated in storage or chemical vessels with the main objective of the reduction of the temperature gradients, during the steady-state operation of the vessels. The particularity of these systems is the necessity to homogenize the temperature of a volume and not only of a surface. According to Table 4, the temperature homogenization mainly concerns volumes from 1 dm³ for small furnaces to several tens of cubic meters for the largest chemical reactors. The temperature gradients are on average reduced from 1 K/mm with conventional cooling to 0.1 K/mm with embedded heat pipe. As this kind of application is almost stationary, thermosyphon or capillary heat pipe can be used, but they have to be coupled to transversal fins in order to achieve a good volumetric temperature homogenization.

2.4 Integration of heat pipes in metrology

The calibration of temperature sensors requires an isothermal reference source, having temperature gradients lower than 0.01 K/mm, perfectly stable in time. To reach such a temperature uniformity, the source can be located inside an annular heat pipe.

2.4.1 Specific designs

The simplest design is a thermosyphon with an annular geometry, over its full length [53] (Figure 10.a) or over a partial length [54] (Figure 10.b). The involved surfaces are therefore smaller than for previous furnaces. Sanchez-Silva et al. [54] developed a copper/water annular thermosyphon to calibrate thermal sensors by a comparative method. Reproducibility issues of experimental tests reveal that the direct use of such thermosyphon may be difficult when the required reference temperature is close to the ambient. In that case, the internal flow stability strongly depends on external boundary conditions. Furthermore, a quite high applied power is required to reach a good temperature uniformity, and the temperature gradient remains important (above 0.02 K/mm). At higher temperatures, isothermal reference source can be more easily developed. For example, Yan et al. [53] used a stainless steel/sodium annular thermosyphon to precisely identify the freezing point of aluminum. Axial knurls and helical grooves are machined on the outer surface of the inner shell and on the inner surface of the outer shell, respectively, to improve the liquid distribution. It ensures a maximum temperature gradient of 0.02 mK/mm, for temperatures around 657°C. Wu et al. [55] built a more complex thermostat design based on a stainless steel/cesium annular thermosyphon. The heat pipe is fitted with three 220 mm long wells with different diameters, corresponding to different thermometer sizes. The purpose is here to reduce the temperature gradients of each well longitudinally and between the three wells. For reference temperatures between 400°C and 800°C, the maximum temperature gradient along each well is 0.5 mK/mm. The maximum temperature difference between wells is estimated to 0.2 K. The maximum measurement uncertainty, which mainly depends on the thermal contact between the well wall and the thermometers, is evaluated to 12 mK. The temperature homogenization for the highest temperatures is improved due to boiling conditions that increase the heat transfer at the evaporator (the boiling point of cesium is 668°C).

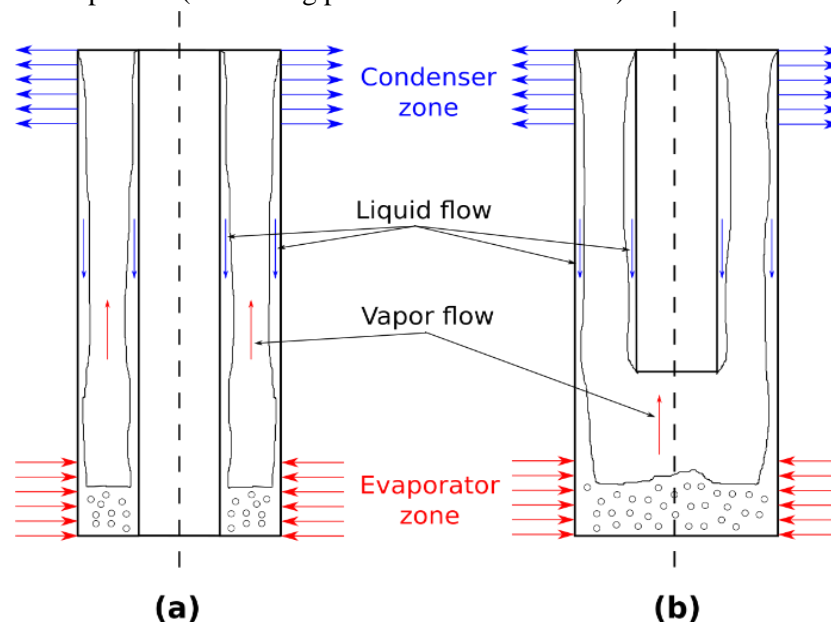

Figure 10 - Schematic view of annular thermosyphon for calibration of thermal measurement devices: (a) full length annular geometry, (b) partial length annular geometry

Another solution is to create an isothermal generator using the vapor line of a LHP. For this, Joung et al. [56] placed an annular pipe on a portion of the vapor line of their stainless steel/water LHP

(Figure 11). Like thermosyphons, the temperature difference is reduced when a sufficient power is applied at the evaporator, due to higher velocities of the vapor flow. The temperature gradient varies from 0.004 K/mm to 0.001 K/mm, for an applied power between 400 W and 1700 W, corresponding to an operating temperature ranging from 40°C to 70°C. A possible generation of non-condensable gases leads however to hysteresis behaviors and can compromise the use of the system as a direct reference source.

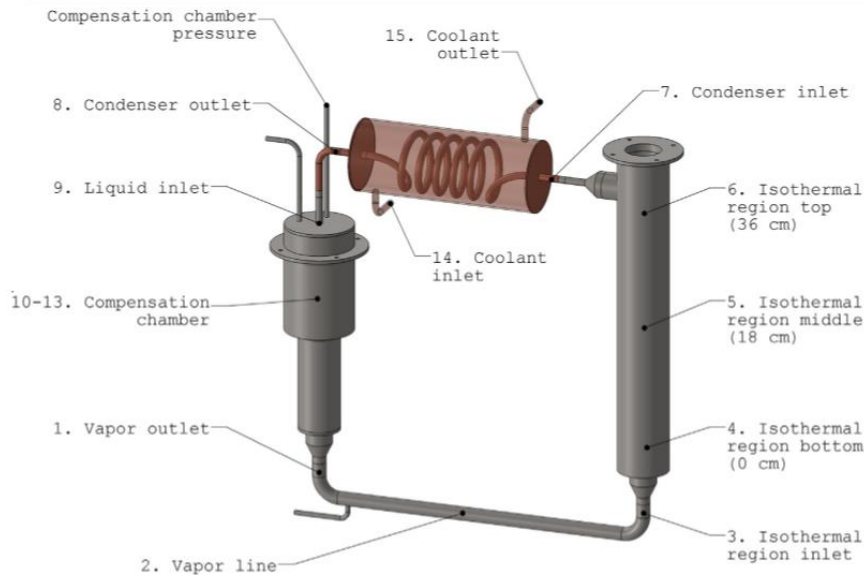

Figure 11 - Loop Heat Pipe with isothermal generator [56]

2.4.2 Summary

According to the synthesis provided in Table 5, the temperature homogenization for metrology systems with heat pipes must be very accurate with temperature gradients lower than 1 mK/mm. To reach this performance, the concerned isothermal surface areas are accordingly small, around 0.05 m². The heat flux densities are relatively low but the heat pipe systems have to be carefully designed to avoid any temperature gradient.

2.5 Temperature homogenization for aeronautical applications

In addition to the thermal management of electronics, already mentioned in 2.1, specific needs of temperature homogenization in avionics are highlighted in the literature. They are related to the reduction of the fatigue of mechanical shaped parts caused by strong temperature gradients.

2.5.1 Specific applications

The first example is the cooling of turbine vanes in avionic engines. Conventional cooling systems are internal convection by air and external air film cooling. These technologies lead unfortunately to aerodynamic losses in the turbine and additional costs for the machining of internal passages for the air, associated with a relative thick geometry of the vane. Furthermore, air cooled vanes are still subjected to strong temperature gradients, located at leading and trailing edges, leading to thermal fatigue and cracking. Langston and Faghri [57] proposed various possibilities to embed heat pipes inside the vane (Figure 12). The first design is based on the conversion of all the internal volume of the turbine vane to a heat pipe. The second design is based on two separate heat pipes in the vane at the leading and trailing edges, dedicated to the removal of heat from hot spots. Between the heat pipes, an additional internal air flow, diverted from the engine compressor, removes heat from the turbine vane surfaces. The last option is the use of an annular heat pipe with an internal air flow. Considering the involved high temperatures, heat pipes are filled with metallic fluids (sodium, lithium). Some

limitations can however appear like during strong accelerations of the aircraft (above 8g). Furthermore, the total mass of the vanes can become excessive.

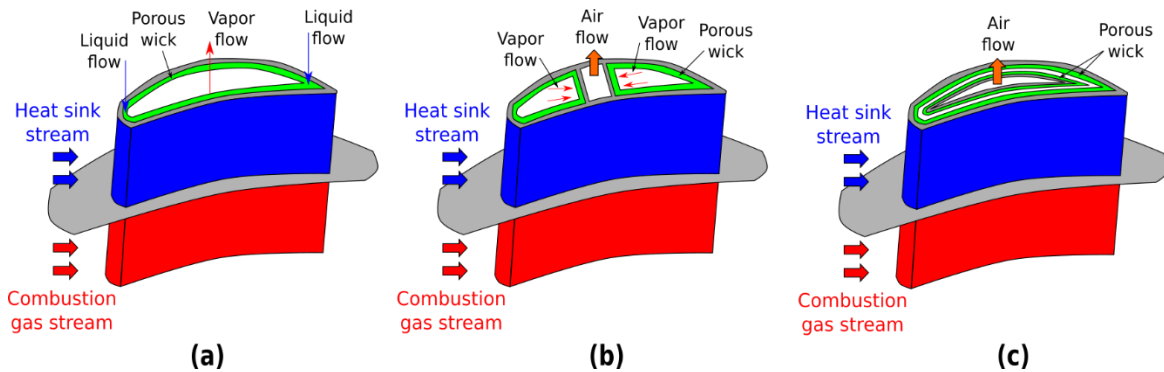

Figure 12 - Turbine vane design with embedded heat pipe (from [57]): (a) with one heat pipe, (b) double separated heat pipes, (c) annular heat pipe

The second example is the integration of heat pipes at leading edges of supersonic aircraft (Mach number above 6). Aerodynamic conditions lead indeed to significant temperature gradients, between 1 K/mm and 5 K/mm, corresponding to temperatures up to 1300°C. In order that the leading edge is able to sustain high mechanical constraints resulting from these temperature gradients, high temperature materials like carbon-fiber-based composites or specific ceramics are generally used, but heat pipes can also be integrated. The first design is based on parallel capillary heat pipes, specially shaped to fit with the geometry of the leading edge (Figure 13.a). Several cross sections of the heat pipes are possible, like D-shaped [58-60] or rectangular ones [61-62]. The second design is to consider the whole leading edge as a capillary heat pipe (Figure 13.b). Several reinforcing pieces are here required in the vapor space, like cruciform structural members wrapped by porous wick [63] or simple ribs [64].

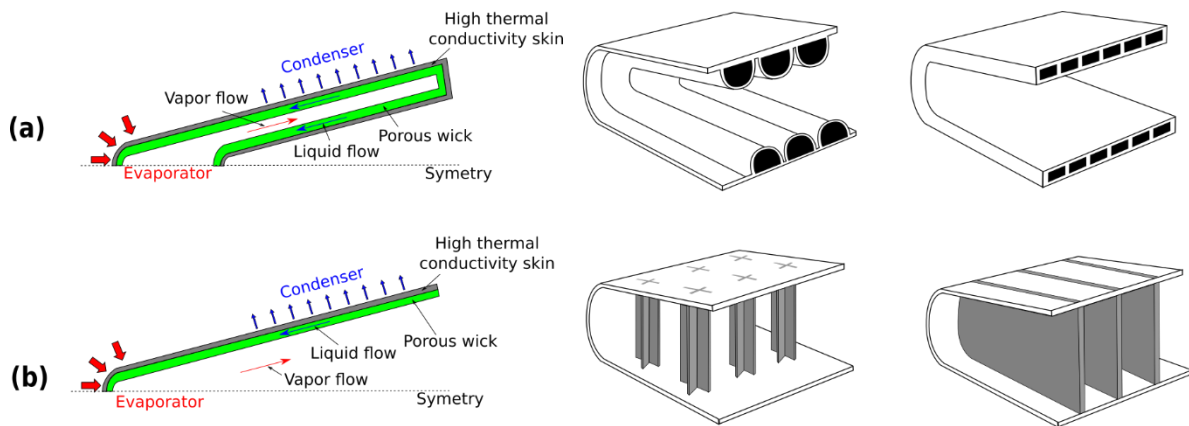

Figure 13 - Heat-pipe-cooled leading edges for hypersonic aircraft: (a) parallel capillary heat pipes: lengthwise schematic view, with D-shaped cross section, with rectangular cross section, (b) leading edge heat pipe: lengthwise schematic view, with cruciform structural members, with structural ribs.

Considering the high temperatures, alkali metals (sodium, lithium or potassium) are selected. Initiated in the 1970's, feasibility studies like Silverstein's one [61] reveal the promising potential of the technology if specific high temperature alloys are designed. Senterfitt et al. [64] selected an alloy of tungsten and rhenium, the tungsten providing a good thermal conductivity and the rhenium the ductility. Glass et al. [58-59] fabricated and tested heat pipes made of a molybdenum-rhenium alloy, embedded in a carbon/carbon structure with a D-shaped cross section. The heat pipes started from the frozen state and operated successfully up to a temperature of 1350°C, with a decrease of the longitudinal temperature gradient from 0.81 K/mm to 0.15 K/mm. The use of the additional

carbon/carbon structure prevents a deformation of the flat side of heat pipes, due to the internal pressure. Progress has also been made on the development of analytical and numerical tools to size such systems. Steeves et al. [63] worked out a systematic method for calculating heat fluxes, temperatures and thermal stresses in a sharp leading edge with an integrated planar heat pipe. The analytical method, based on simple approximations and validated by comparison with a finite element method, enables an easier comparison between various materials. Niobium alloy Cb-752 seems to be a better heat pipe material than nickel alloy Inconel 625, with lower Mises stresses and higher transported heat power, for a leading edge of 3 mm curvature radius at Mach 8 or below. Both materials have however similar thermal performance: the temperature gradient of 5 K/mm without heat pipe is reduced to 0.2 K/mm with heat pipe. Analytical and numerical calculations of Peng et al. [65] confirm the worst mechanical performance of Inconel 625 with the same leading edge radius, for Mach numbers from 6 to 8, compared to results with niobium alloy C-103 and tantalum alloy T-111, although the reduction of the temperature gradient is similar. For a less sharp leading edge, of curvature radius of 15 mm, with a nickel alloy/sodium heat pipe, the numerical results of Liu and Liu [62] highlight a decrease of the tip temperature from 1365°C to 1076°C with an increase of the rear temperature from 699°C to 1007°C, corresponding to a decrease of the temperature gradient from 4.2 K/mm to 0.4 K/mm. Finally, the model of Guangming et al. [60] shows that the sonic limit affects the heat pipe behavior at start-up. The need to defreeze the working fluid results in an increase of the operating temperature around 5% at steady-state.

2.5.2 Summary

The introduced aeronautical applications involve very specific geometries of heat pipes. According to the synthesis provided in Table 6, heat pipes are used here for a temperature homogenization over a high temperature range from 650°C to 2500°C. The temperature gradients reduction is around 2.8 K/mm on average, for small lengths. However, the general constraints in the aeronautical applications, coupled to the difficulty to design very specific systems, limit for now the industrial development of heat pipes in this domain.

2.6 Heat pipes for spatial applications

Thermal control of satellites is widely based on heat pipe systems. The main purpose is here to maintain a right range of temperatures of board electronic devices. It involves to properly evacuate the heat dissipated during their operation to the radiative panels, but also to insulate them from both hot solar and cold space radiations. So, temperature gradients are of two types: a first in-plane gradient coming from the heat dissipation of electronics distributed on a single satellite panel, and a second gradient between the panels due to the relative orientation of the satellite to the sun and to the earth. With the absence of gravitational forces, capillary heat pipes are selected. For larger systems, they can create a complicated heat transfer network forming an integral part of the satellite structure, and homogenize the temperature of a total surface area of around 10 m². For reasons of system mass reduction, heat pipes are mainly in aluminum. The working fluid is often ammonia because it is convenient for the temperature ranges, from -50°C to 100°C, and it is chemically compatible with aluminum.

2.6.1 Temperature homogenization of a single panel

Several more and more complex heat pipe networks have been developed to reduce temperature gradients on a complete honeycomb panel for satellites. Electronic devices are mounted on the inner face sheet of the panel and the entire or a partial part of the outer face sheet of the panel directly forms the radiator surface. Many designs of heat pipe network are introduced in the literature.

The first solution is the use of standard heat pipes diffusing heat in a preferential direction. For small satellites, the temperature homogenization of the entire panel can be achieved by simply curving the heat pipes (Figure 14.a). In the Magion and Bird microsattellites, Baturkin et al. [66] introduced aluminum/ammonia L-shaped or U-shaped heat pipes fixed to the panel by carbon adhesive. The temperature field of a 0.1 m² surface is flattened during the phases of eclipse or variations of earth and sun radiation to which the scientific satellites may be subjected, and the temperature of electronics is maintained in the range from -50°C to 60°C. For many satellites, especially with a large size, two crossed series of straight heat pipes are usually implemented (Figure 14.b). The first row of heat pipes, called “feeders”, receives heat dissipated by electronics mounted on the inner face sheet of the panel. The second perpendicular row of heat pipes, called “headers”, thermally links the feeders between them and with the cold outer face sheet. The patent of Rowe [67] advises to adapt the spacing between the feeders with regards to the heat dissipations of electronic equipment so that each header operates like an isothermal conductor and the global thermal resistance of the heat pipe network between electronics and the radiator decreases. Various arrangements of the “feeders-headers” network can be designed. For example, Bugby et al. [68] selected C-shaped feeders and a single O-shaped header (Figure 14.c). This last heat pipe is sufficient to get a good in-plane temperature homogenization due to the small size of the panel (around 1 m²). The in-plane temperature gradient of one of their studied aluminum honeycomb panel decreases from 0.32 K/mm without heat pipes to 0.03 K/mm with six C-shaped and one O-shaped heat pipes.

The thermal link between the heat pipes is usually insured by epoxy adhesive. Heat pipes are often made of the same material than the honeycomb panel, usually aluminum. The insertion of different materials involves a specific attention. The patent of Peck et al. [69] is a good example, with a panel coating made of graphite, a lightweight and more thermal conductive material than aluminum. Carbon fibers must be well oriented to avoid problems of asymmetric thermal dilatation. Furthermore, a specific seal material must replace the epoxy adhesive to fix aluminum heat pipes to the graphite panel coating.

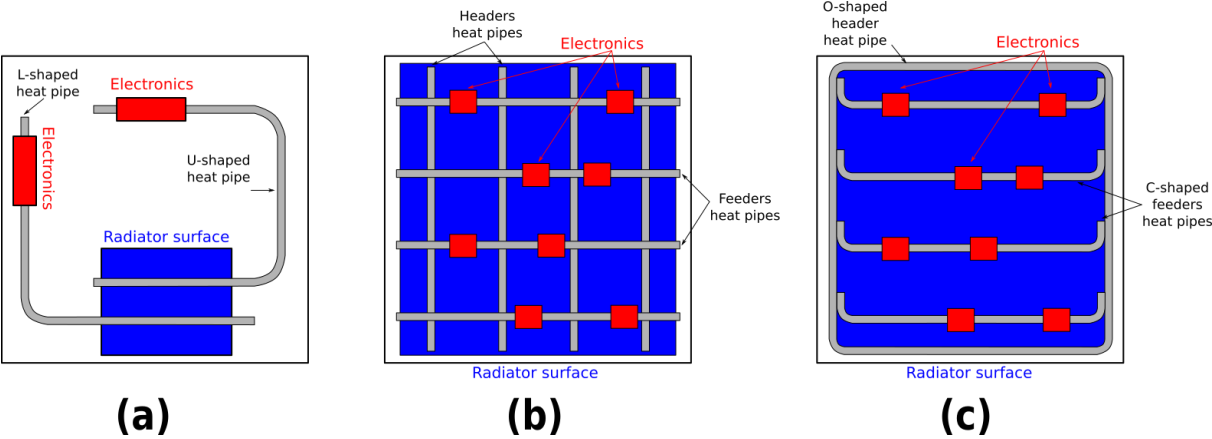

Figure 14 – Front views from the inner face sheet of a satellite panel with capillary heat pipes in contact: (a) special shaped heat pipes for small satellites (from [66]), (b) crossed heat pipes network (from [67]), (c) special shaped heat pipes network (from [68])

The second solution is a network of hydraulically connected heat pipes (Figure 15). Patents of Huang [70], and Figus and Ounougha [71] introduced various design options of the network, with small diameter tubes like a PHP or capillary heat pipes, respectively. These designs improve heat transfer at the conductive junctions of previous header and feeder heat pipes. While a PHP network is currently used for surface areas smaller than 0.1 m², the network of capillary heat pipes can be dedicated to larger surfaces. For the latter, Figus and Ounougha [71] proposed a cross brace design with embedded porous wicks to simply connect straight heat pipes already existing in the space

industry. However, the pore diameter of the brace must be lower than the one of the capillary structure pores, to avoid slowing down the capillary pumping at the junctions.

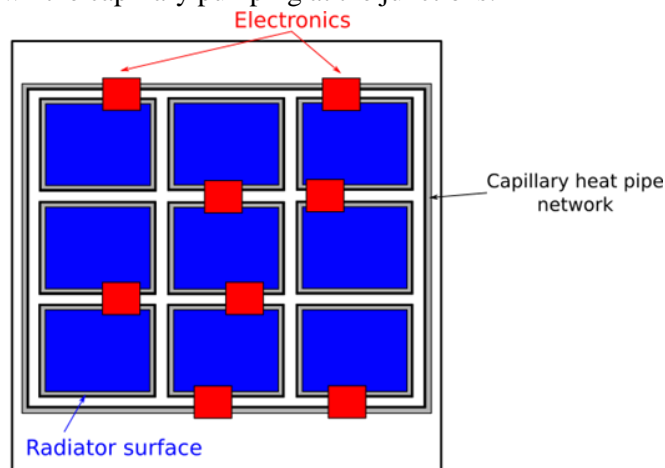

Figure 15 – Front view from the inner face sheet of a satellite panel with network of interconnected capillary heat pipes (from [71])

The last proposed design to homogenize the temperatures of a honeycomb panel is to convert it into an entire flat heat pipe. The geometry of the honeycomb structure must be adapted. Queheillalt et al. [72] propose a regular lattice arranged by cross-braces on which a nickel porous wick is deposited (Figure 16). The porous wick is likewise deposited on the internal surfaces of the panel coating. The authors presented experimental results with an external structure in aluminum of 0.36 m² heated by a propane flame. Deionized water is the working fluid. A very good temperature homogenization was highlighted via infrared measurement. The maximum temperature was reduced from 204°C with a solid plate of aluminum to 52°C with the heat pipe panel, corresponding to a decrease of the in-plane temperature gradient from 0.5 K/mm to 0.05 K/mm.

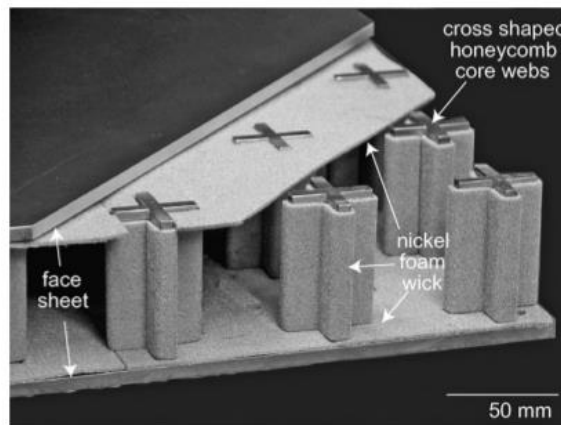

Figure 16 - Heat pipe sandwich panel internal structure [72]

2.6.2 Temperature homogenization between panels

The reduction of temperature differences between the panels of a satellite can be advantageous to gain heating or cooling energy. Furthermore, in many cases, all panels cannot be used as radiative surfaces, like during missions for sun observation, when all the time one panel is submitted to sun radiation and the opposite panel faces the space. Thus, the radiator is often located on a single panel. A thermal link between panels is required to evacuate heat from electronics of the panels insulated from the space. Several alternatives of assembly are introduced in the literature, depending on the expected degree of temperature uniformity between the panels, often corresponding to the type of satellite mission. The choice of the heat pipe network dedicated to the temperature homogenization of a single panel often depends on the one dedicated to the temperature uniformity between panels.

The patent of Low and Goodman [73] links two parallel panels with crossed heat pipe networks (like in Figure 14.b) thanks to standard heat pipes fixed on a transverse panel (Figure 17.a). These heat pipes simply extend and link the headers of each opposed panels. Solar heat is then better shared during solstice periods. The additional efficiency in terms of heat dissipation is evaluated at 11% thanks to the temperature homogenization. For a temperature flattening between two adjacent panels, designs with hydraulically connected heat pipes introduced in Figure 15 can be easily employed. Like in the patent of Huang [70] with capillary tubes, the network is separated in one heat dissipating unit near the radiative panel and one heat absorbing unit near the electronics (Figure 17.b). Another alternative to reduce temperature gradients between two adjacent panels is the use of high conductance bolted seams in association with specific shaped headers, like O-shaped heat pipes in Figure 17.c, to ensure a good heat exchange along the seam [68]. Finally, the complete temperature homogenization between all panels of the satellite can be provided by an additional network of heat pipes at the junction of lateral panels and end panels. This network can be simply a super header heat pipe [74] linking headers of each heat absorbing panels with the dissipating panel (Figure 17.c). In most cases, the thermal system at the radiator panel is here often a two-phase loop, preferable for large heat loads on long transport lengths. In the case of the use of a super header heat pipe, the evaporator of the loop is located near the header and the condenser covers the radiative surface (Figure 17.c).

The knowledge of heat pipe operation for space applications is today enough wide to build a quickly assembled system of thermal control for satellites according to the previous introduced systems. A modular architecture [60], called SMARTS (for “Satellite Modular and Reconfigurable Thermal System”), aims to design an efficient two-phase thermal control system for small satellites, within maximum 6 days, taking into account mechanical, electrical and software requirements.

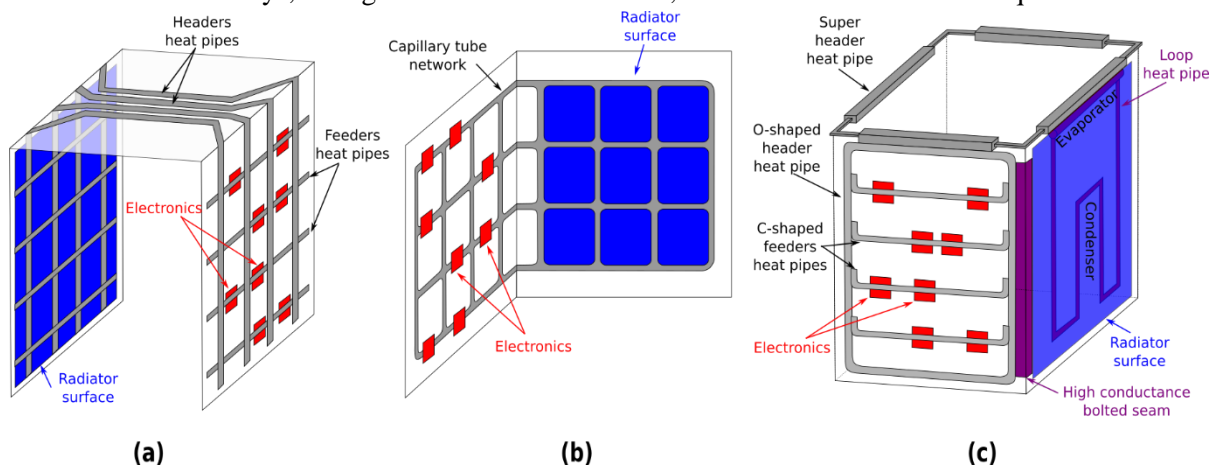

Figure 17 – Examples of configuration for global thermal system for satellites: (a) between two opposite panels with crossed heat pipes (from [65]), (b) between two adjacent panels with capillary tube network (from [70]), (c) between all the panels with super header pipe (from [74])

2.6.3 Summary

The heat pipe designs developed in space industry to reduce the temperature gradients are extremely advanced. Capillary heat pipes are essential in the thermal management of satellites due to the absence of the gravitational forces. The temperature homogenization must be efficient, with regards to the evaluated temperature gradients, lower than 0.05 K/mm, because of the limitation of the temperature range from -50°C to 150°C (Table 7) to preserve a good operation of electronic devices. A continuous improvement of both the heat pipe systems and the numerical tools to design them is observed for the spatial applications and more and more optimized systems can still be expected in the future.

3. Summary of heat pipe characteristics for temperature homogenization

From all the gathered data, an assessment about the characteristics of heat pipes used for temperature homogenization is introduced. An analysis is then proposed about typical fluid/material couples used for these heat pipes, especially about the chemical compatibility.

3.1 Types of heat pipes and embedding

The diversity of the applications leads to various configurations and constraints in terms of temperature homogenization. Table 8 summarizes the characteristics associated to each introduced application and highlights their specificities. If the thermal management of electronics components involves high heat flux densities over small surfaces, the temperature homogenization of solar collectors and reactors requires to deal with large surfaces and volumes. In metrology applications, the temperature gradients have to be particularly low. For aeronautical applications, two-phase systems are subjected to high temperatures whereas in spatial applications, the systems have to deal with the lack of gravity.

As a consequence, specific heat pipes were designed for each application. In Figure 18, the proportion of each type of heat pipe selected in the about sixty studied papers is plotted. Standard capillary heat pipes are the most commonly used because their operation is well known and predictable thanks to design tools already developed. According to the literature, these heat pipes can reach one meter long for a 1D-homogenization of temperatures and the surface areas covered by a crossed heat pipe network can be up to 10 m². Thermosyphons are essentially used for terrestrial applications, when the temperature gradient direction corresponds to the gravity one. They are from a few centimeters to several meters long. For a 2D-homogenization, vapor chambers can be a good alternative to the network of straight heat pipes. However, the heat transfer surface area is still limited to about 0.5 m² for a good temperature homogenization. Finally, LHP and PHP are rarely found in the literature to reduce temperature gradients. LHPs are mainly used to transfer heat over long distances. Even if their performances are promising, the thermohydraulic behavior of PHPs is still poorly known and limits the industrial design of these systems.

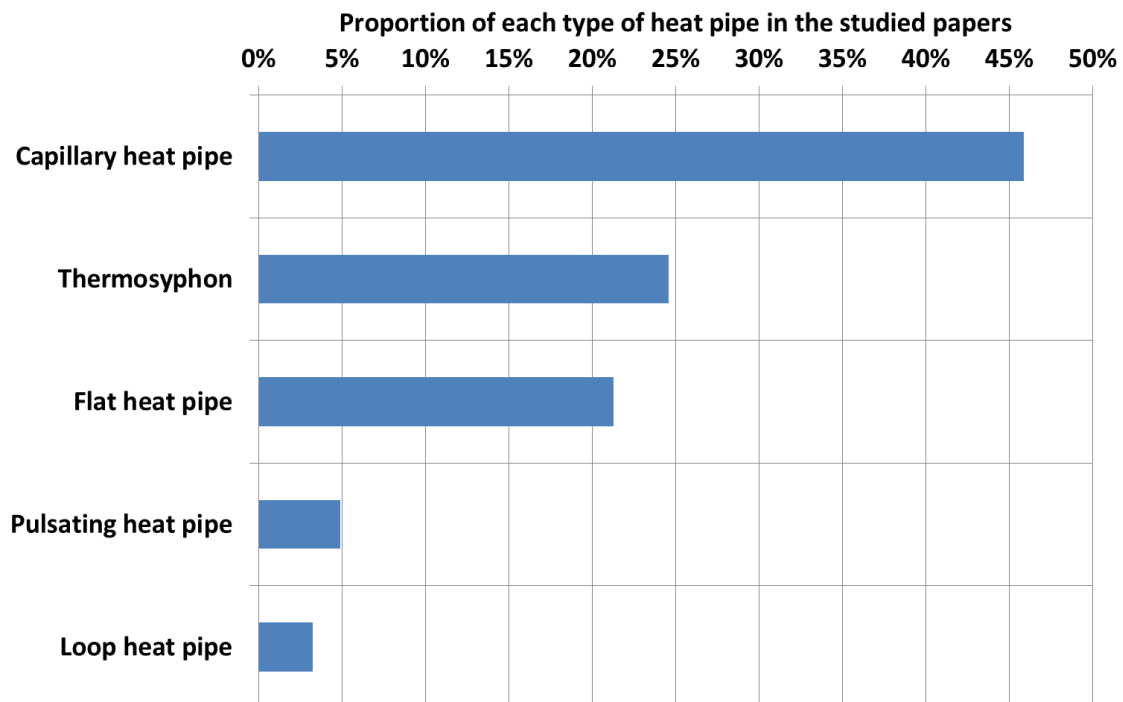

Figure 18 - Types of heat pipes selected in the studied papers

3.2 Fluid/material pairs

The choice of the working fluid is firstly based on the temperature range of the application which should be between the melting point and the boiling point of the fluid. Faghri [4] provides a list of useful temperature ranges for some working fluids commonly used in heat pipes (Figure 19). These temperature ranges correspond to a vapor pressure greater than 0.1 atm and less than 20 atm. Below 0.1 atm, the vapor pressure limit can be reached and may limit the heat transfer. Above 20 atm, the thickness of the heat pipe casing, due to mechanical resistance requirements, is considered excessive. However, these recommended temperature ranges can be widely extended in the case of temperature homogenization, as highlighted in the literature (Figure 19). At low pressure, the heat pipe is performant if heat flux densities to transfer are not too high and if a preliminary design of the heat pipe considers sonic, viscous and/or entrainment limits. In that case, the heat pipe can provide the required reduction of temperature gradients. At high pressure, the heat pipe casing can be thinned by using specific robust material with a relatively low thermal conductivity, like stainless steel or titanium. Usual limits of heat pipes near the critical point, like capillary limit or boiling limit, do not necessarily have an impact on the performance in terms of temperature homogenization, if the heat flux densities remain low.

Other additional criteria can be determinant, as environmental risks, mass constraints or thermal and hydraulic performances (via the thermodynamic properties of the fluid).

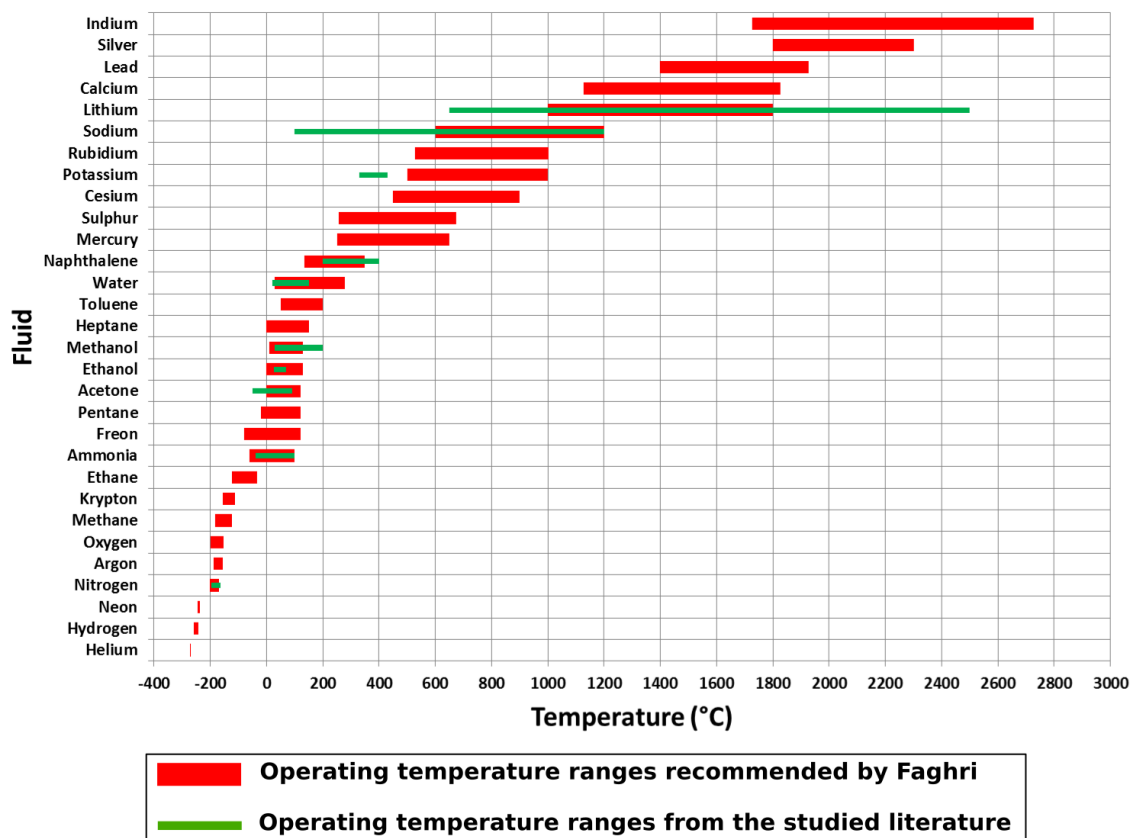

Figure 19 - Operating temperature ranges of various fluid recommended by Faghri [4] and from the introduced literature

The choice of the fluid can directly impact the choice of the heat pipe material. Indeed, the material must be chemically compatible with the fluid (under penalty of generation of non-condensable gases for example). It must meet the specified mechanical and thermal constraints. From the literature survey, metallic materials are almost exclusively used because of their good thermal conductivity: aluminum, carbon steel, copper and stainless steel. Other specific metals can be found

for high temperature applications, like Inconel, niobium, nickel or molybdenum-rhenium. The only mentioned non-metallic material is the graphite, even if it is not used yet. It is a good thermal conductor ($\lambda = 100 - 500 \text{ W/mK}$) and fairly light ($\rho = 200 \text{ kg/m}^3$). The main problematic is linked to the weaving of the carbon fibers to avoid thermal dilatation issues with the surrounding systems [69].

Even if the available data on the chemical compatibility are rare and can be contradictory (example with water and nickel), due to the many possible configurations of heat pipes, Mishkinis et al. [75], Yang et al. [76] and Faghri [4] provide some general experimental results introduced in Table 9. These results are compared to the fluid/material couples found in the introduced literature. A good agreement between the studied papers and the other three sources is highlighted. One noticeable inconsistency is the use of the aluminum/water pair, prohibited by the three literature references, but allowed by Queheillalt et al. [72], if deionized water is used and if the aluminum is covered by an electrolytic nickel layer. Finally, in [65, 69], lithium is used with Inconel 625, a specific nickel alloy. Even if the nickel is not compatible with lithium according to Faghri [4], the alloy of nickel especially containing niobium and molybdenum leads to a better coexistence. However, Inconel 625 appears less performant than niobium or tantalum alloys in terms of mechanical resistance and heat transfer.

4. Conclusion

Heat pipes are usually used to transfer high heat fluxes with a low temperature gradient between a hot and cold sources, but other functions can also be sought, as the temperature homogenization. This paper highlights the efficiency of heat pipes to improve this function in several application fields, with many alternatives in terms of type and geometry of heat pipes. The introduced literature shows that the temperature flattening is usually not the only purpose of using heat pipes, especially for systems of small surfaces. However, it leads to an increase of lifetime of the cooled systems thanks to an effective decrease of temperature peaks, potentially involving severe mechanical stresses. The temperature homogenization can concern very small surface areas lower than 0.01 m^2 as well as larger ones over 10 m^2 . Even if the capillary heat pipes are the most used heat pipes for temperature homogenization, all types can be efficient depending on the environment of the system, especially the presence of gravitational forces, and the size of the surface or volume to homogenize in temperature. The favored use of conventional heat pipes (capillary heat pipe, thermosyphons, and flat heat pipes) can be also explained by the existence of sufficiently detailed models to estimate the temperature distribution along the system, as introduced in Table 1. In contrast with the usual sizing for the heat transfer function, where global analytical expressions of heat power limitations and operating temperature can be adequate, the accurate estimation of the reduction of temperature gradients by heat pipe requires much more advanced models. The poor advances in predictive modeling of PHPs still avoid a real application in the designed systems for temperature homogenization, while their manufacturing appears simpler. Even major progresses have been achieved in the understanding and modeling of LHPs, some improvements still have to be reached in the prediction of transient and hysteresis behaviors. Additionally, their large size is not adapted to reduce temperature gradients of small systems.

The introduced examples highlight that the temperature homogenization can be performed at very large temperature ranges, from low temperatures below -40°C to very high temperatures above 2500°C . The working fluid of the heat pipe is chosen following the operating temperature of the system, in the same way as for any application of heat pipes. However, in the case of the reduction of temperature gradients, the operating temperature range of the working fluid can be extended, compared to a standard use of heat pipe as high effective heat transfer system. Even if heat flux densities are low, the temperature homogenization property of the heat pipe can be sufficient depending on the application. The material of the casing must be then chosen with regards to the compatibility with the fluid and the mechanical stresses from the environment of the system.

According to the literature, metallic materials are the most favored materials due to their high thermal conductivity. Improvement of new thermally conductive and lighter materials, like plastics or polymer composites, and the research of new fluids chemically compatible with this kind of materials, are one of the future challenges for heat pipes design. Finally, the knowledge of physical and chemical properties of the usual or new material/fluid couples remains poor, as shown by the contradictory results available in the literature. More interactions between the heat pipe and the material science research communities should be created to answer this issue.

Table 2 - Characteristics of heat pipes for temperature homogenization in thermal management of electronics

Authors	Year	Type of heat pipe	Material	Porous media	Fluid	Temperature range	Characteristic dimension of the isothermal zone	Temperature gradient		
								Direction	Without heat pipes	With heat pipes
Bonner et al.	2013	Thermosyphon	Aluminum	-		50°C – 80°C	L = 30 cm	Lengthwise		0.05 K/mm
Campo et al.	2014	Capillary heat pipe	Copper		Water	50°C – 120°C	S = 120 cm ²	Lengthwise	0.25 K/mm	0.06 K/mm
								In-plane	0.8 K/mm	0.3 K/mm
Hsu [P]	2006	Capillary heat pipe						Axial		
								In-plane		
Tang et al.	2013	Capillary heat pipe	Copper	Grooves	Water	30°C – 65°C	L = 24 cm	Lengthwise	0.08 K/mm (plain tube)	0.02 K/mm
Hemadri et al.	2011	Pulsating heat pipe	Copper	-	Water Methanol	30°C – 130°C	S = 1200 cm ²	Lengthwise	0.19 K/mm	0.11 K/mm
Fan et al.	2012	Flat heat pipe	Copper	Sintered copper	Novec 7200	25°C – 35°C	S = 2,7 cm ²	Axial	15.6 K/mm (thermal vias) 4.2 K/mm (aluminum plate)	2.2 K/mm
								In-plane	0.9 K/mm (thermal vias) 0.4 K/mm (aluminum plate)	0.1 K/mm
Sun et al. [P]	1995	Flat heat pipe	Aluminum	Grooves	Acetone	40°C – 90°C	S = 263 cm ²	In-plane	0.12 K/mm (hollow plate) 0.06 K/mm (plain plate)	0.01 K/mm
Wang et al.	2010	Flat heat pipe	Copper	-	Water	30°C – 80°C	S = 64 cm ²	Axial		
								In-plane		
Boukhanouf et al.	2006	Flat heat pipe	Copper	Sintered copper	Water	20°C – 90°C	S = 500 cm ²	In-plane	0.32 K/mm (plain plate) 0.40 K/mm (defective heat pipe)	0.08 K/mm
Reyes et al.	2012	Flat heat pipe	Aluminum	-	HFE 7100	20°C – 100°C	S = 266 cm ²	In-plane		
Tsai et al.	2013	Flat heat pipe	Copper	Sintered copper	Water	10°C – 60°C	S = 81 cm ²	In-plane		0.03 - 0.05 K/mm

Table 3 - Characteristics of heat pipes for temperature homogenization in solar collectors' optimization

Authors	Year	Type of heat pipe	Material	Porous media	Fluid	Temperature range	Characteristic dimension of the isothermal zone	Temperature gradient		
								Direction	Without heat pipes	With heat pipes
Liu and Zhang	2014	Thermosyphon	Carbon steel	-	Naphthalene	200°C – 400°C	S = 1570 cm ²	Lengthwise		0.01 K/mm
Azad	2012	Thermosyphon	Stainless steel	-	Ethanol		S = 2 m ²	Lengthwise		
Wei et al.	2013	Thermosyphon		-	Ethanol	25°C – 70°C	S = 565 cm ²	Lengthwise		
Rassamakin et al.	2013	Capillary heat pipe	Aluminum	Grooves		0°C – 75°C	S = 2 m ²	Lengthwise		
Hussein et al.	2006	Thermosyphon	Copper	-	Water	25°C – 35°C	S = 2850 cm ²	Lengthwise		
Rittidech and Wannapkane	2007	Pulsating heat pipe	Copper	-	R134a	30°C – 50°C	S = 2 m ²	Lengthwise		
Facao and Oliveira	2006	Flat heat pipe					S = 949 cm ²	In-plane		
Deng et al.	2013	Flat heat pipe	Aluminum	Grooves	Acetone	50°C – 90°C	S = 558 cm ²	In-plane		0.001 K/mm

Table 4 - Characteristics of heat pipes for temperature homogenization of storage vessels, reactors and furnaces

Authors	Year	Type of heat pipe	Material	Porous media	Fluid	Temperature range	Characteristic dimension of the isothermal zone	Temperature gradient		
								Direction	Without heat pipes	With heat pipes
Parent et al.	1983	Capillary heat pipe	Stainless steel	Sintered stainless steel	Sodium Potassium	330°C – 430°C	S = 942 cm ²	Lengthwise	0.06 K/mm (conventional cooling)	0.01 K/mm
Choi et al.	2014	Capillary heat pipe	Stainless steel	Sintered stainless steel	Naphthalene	200°C – 300°C	S = 1000 cm ²	Lengthwise		0.02 K/mm
								Circumferential		0.02 K/mm
Zhi-Ang	1998	Thermosyphon	Carbon steel	-	Ammonia		L = 4,5 m	Lengthwise		
Le [P]	2003	Thermosyphon Capillary heat pipe	Copper Aluminum				V = 22 m ³	Lengthwise		
Reay	2015	Thermosyphon	Copper	-	Water		V = 1,57 dm ³	Lengthwise	0.39 K/mm (finned pipe)	0.22 K/mm
Richardson et al.	1988	Thermosyphon Capillary heat pipe	Inconel	Grooves Sintered stainless steel	Sodium	600°C – 1000°C	V = 38,6 dm ³	Lengthwise		0.03 K/mm
								Circumferential		0.33 K/mm
Wang et al.	2016	Flat heat pipe Capillary heat pipe	Stainless steel	Grooves Sintered stainless steel	Sodium	100°C – 800°C	V = 1,21 dm ³	Lengthwise (reaction chamber)		0.3 K/mm
								In-plane (absorber plate)	2.4 K/mm	1.1 K/mm

Table 5 - Characteristics of heat pipes integrated in metrology for temperature homogenization

Authors	Year	Type of heat pipe	Material	Porous media	Fluid	Temperature range	Characteristic dimension of the isothermal zone	Temperature gradient		
								Direction	Without heat pipes	With heat pipes
Yan et al.	2011	Thermosyphon Capillary heat pipe	Stainless steel	Sintered stainless steel	Sodium	500°C – 1200°C	S = 961 cm ²	Lengthwise		0.0002 K/mm
Sanchez-Silva et al.	2015	Thermosyphon	Copper	-	Water	30°C – 130°C	S = 206 cm ²	Lengthwise		0.02 K/mm
Wu et al.	2013	Thermosyphon	Stainless steel	-	Cesium	400°C – 800°C	L = 22 cm	Lengthwise		0.0005 K/mm
Joung et al.	2013	Loop Heat Pipe	Stainless steel	Sintered stainless steel	Water	40°C – 70°C	S = 565 cm ²	Lengthwise		0.001 – 0.004 K/mm

Table 6 - Characteristics of heat pipes for temperature homogenization in aeronautical applications

Authors	Year	Type of heat pipe	Material	Porous media	Fluid	Temperature range	Characteristic dimension of the isothermal zone	Temperature gradient		
								Direction	Without heat pipes	With heat pipes
Langston and Faghri	1995	Capillary heat pipe			Sodium Lithium			Lengthwise		
Silverstein [TR]	1971	Capillary heat pipe	Haynes 25 (Co-Ni-Cr-W high temperature alloy)	Sintered H11	Sodium		L = 84 cm	Lengthwise		
Senterfitt et al. [P]	1990	Capillary heat pipe	W-Re alloy		Lithium	1800°C – 2500°C		Lengthwise		
Glass et al. [TR]	1998	Capillary heat pipe	Mo-Re alloy	Sintered Mo-Re alloy	Lithium	650°C – 1320°C	L = 45 cm	Lengthwise	0.81 K/mm	0.15 K/mm
Steeves et al.	2009	Capillary heat pipe	Inconel 625 (Ni alloy) Cb-752 (Nb alloy)		Lithium	800°C – 1300°C	L = 30 cm	Lengthwise	5 K/mm	0.2 K/mm
Peng et al.	2015	Capillary heat pipe	Inconel 625 (Ni alloy) C-103 (Nb alloy) T-111 (Ta alloy)		Lithium	1130°C – 2130°C	L = 15cm	Lengthwise	4.4 K/mm	0.6 K/mm
Liu and Liu	2016	Capillary heat pipe	IN 718 (Ni alloy)	Sintered nickel	Sodium	1000°C – 1100°C	L = 16 cm	Lengthwise	4.2 K/mm	0.4 K/mm
Guangming et al.	2014	Capillary heat pipe	Mo-Re alloy	Sintered niobium	Lithium	1130°C – 2130°C	L = 50 cm	Lengthwise	1.9 K/mm	0.9 K/mm

Table 7 - Characteristics of heat pipes for temperature homogenization in spatial applications

Authors	Year	Type of heat pipe	Material	Porous media	Fluid	Temperature range	Characteristic dimension of the isothermal zone	Temperature gradient		
								Direction	Without heat pipes	With heat pipes
Baturkin et al.	2003	Capillary heat pipe	Aluminum	Grooves	Ammonia	-50°C – 60°C	S = 945 cm ²	In-plane		
Rowe [P]	1996	Capillary heat pipe Flat heat pipe	Aluminum	Grooves	Ammonia			In-plane		
Peck et al. [P]	2002	Capillary heat pipe	Aluminum					In-plane		
Huang [P]	2001	Pulsating heat pipe				40°C – 60°C	S = 600 cm ²	In-plane		
Figus and Ounougha [P]	2009	Capillary heat pipe			Ammonia	-40°C – 100°C		In-plane		
Queheillalt et al.	2008	Flat heat pipe	Aluminum	Sintered nickel	Water	25°C – 150°C	S = 3600 cm ²	In-plane	0.5 K/mm (aluminum plate)	0.05 K/mm
Low and Goodman [P]	2004	Capillary heat pipe						In-plane		
Bugby et al.	2007	Capillary heat pipe Flat heat pipe Loop heat pipe	Aluminum		Ammonia	-20°C – 50°C	S = 10 m ²	In-plane	0.32 K/mm (aluminum plate)	0.03 K/mm

Table 8 - Summary of the characteristics associated to each application

Applications	Type of configuration	Temperature range	Type of temperature homogenization	Characteristic dimension	Temperature gradient	Type of heat pipe
Electronic components	On board	30°C – 120°C	Lengthwise 2D heat spreading	0.002 m ² - 0.05 m ²	0.05 – 0.3 K/mm	Capillary heat pipe Flat heat pipe
Solar collectors	Stationary	0°C – 400°C	Lengthwise	0.5 m ² - 2 m ²	0.01 K/mm	Thermosyphon Flat heat pipe
Storage vessels, reactors and furnaces	Stationary	100°C – 1000°C	Volumetric	0.01 m ² - 20 m ³	0.01 – 0.3 K/mm	Thermosyphon Capillary heat pipe
Metrology	Stationary	40°C – 1200°C	Surface	0.02 m ² - 0.1 m ²	0.0002 – 0.02 K/mm	Thermosyphon
Aeronautical applications	On board	650°C – 2500°C	Lengthwise	15 cm – 84 cm	0.15 – 0.9 K/mm	Capillary heat pipe
Spatial applications	Zero gravity	-50°C – 150°C	In-plane	0.06 m ² - 10 m ²	0.05 K/mm	Capillary heat pipe

Table 9 - Compatibility between fluid and material of heat pipes

Fluid	Material										
	Aluminum	Carbon steel	Copper	Stainless steel	Mo alloy	Nb alloy	Ni alloy	Re alloy	Ta alloy	Ti alloy	W alloy
Nitrogen			L	L							
Ammonia	L C	L		C			C				
Freon	C										
Acetone	L C		L C	L CI			C				
Ethanol	I			L			CI				
Methanol	I		L C	L C			CI				
Heptane	C										
Water	L I		L C	L CI			CI			CI	
Naphthalene		L		L							
Mercury				C	I	I	I		I	I	
Cesium				L C		C				C	
Potassium				L			C			I	
Sodium				L C		C	L C			I	
Lithium				I	L C	L C	L I	L	L C	I	L C
Lead				I		I	I		C	I	C
Silver								I	C		C

L : Fluid/material couple from the studied literature
C or I : Compatibility or incompatibility from Mishkinis et al. [75], Yang et al. [76] and Faghri [4]

References

- [1] M. Groll, Heat pipe research and development in Western Europe, *Heat Recovery Systems and CHP* 9 (1) (1989) 19-66.
- [2] S. Launay, V. Sartre, J. Bonjour, Parametric analysis of loop heat pipe operation: a literature review, *International Journal of Thermal Sciences* 46 (2007) 621-636.
- [3] R. Singh, M. Mochizuki, T. Nguyen, A. Akbarzadeh, Applications of heat pipes in energy conservation and renewable energy based systems, *Frontiers in Heat Pipes* 2 (3) (2011) 1-13.
- [4] A. Faghri, Heat pipes: review, opportunities and challenges, *Frontiers in Heat Pipes* 5 (1) (2014) 1-48.
- [5] D.A. Reay, Thermal energy storage: the role of the heat pipe in performance enhancement, *International of Low-Carbon Technologies Advance Access* 10 (2015) 1-11.
- [6] B. Siedel, V. Sartre, F. Lefèvre, Literature review: steady-state modelling of loop heat pipes, *Applied Thermal Engineering* 75 (2015) 709-723.
- [7] S. Lips, V. Sartre, F. Lefèvre, S. Khandekar, J. Bonjour, Overview of heat pipe studies during the period 2010-2015, *Interfacial Phenomena and Heat Transfer* 4 (2016) 33-53.
- [8] Y.F. Maydanik, Loop heat pipes, *Applied Thermal Engineering* 25 (2005) 635-657.
- [9] G. Ribeiro, J. Barbosa, A. Prata, Mini-channel evaporator/heat pipe assembly for a chip cooling vapor compression refrigeration system, *International Journal of Refrigeration* 33 (2010) 1402-1412.
- [10] V. Ayel, L. Lachassagne, Y. Bertin, C. Romestant, D. Lossouarn, Experimental analysis of a capillary pumped loop for terrestrial application, *Journal of Thermophysics and Heat Transfer* 25 (2011) 561-571.
- [11] F. Liu, F. Lan, J. Chen, Dynamic thermal characteristics of heat pipe via segmented thermal resistance model for electric vehicle battery cooling, *Journal of Power Sources* 321 (2016) 57-70.
- [12] R. Boukhanouf, A. Haddad, M.T. North, C. Buffone, Experimental investigation of a flat heat pipe performance using IR thermal imaging camera, *Applied Thermal Engineering* 26 (2006) 2148-2156.
- [13] M. Reyes, D. Alonso, J.R. Arias, A. Velazquez, Experimental and theoretical study of a vapor chamber based heat spreader for avionics applications, *Applied Thermal Engineering* 37 (2012) 51-59.
- [14] M. Tsai, S. Kang, K. Vieira de Paiva, Experimental studies of thermal resistance in a vapor chamber heat spreader, *Applied Thermal Engineering* 56 (2013) 38-44.
- [15] H. Yang, S. Khandekar, M. Groll, Performance characteristics of pulsating heat pipes as integral thermal spreaders, *International Journal of Thermal Sciences* 48 (2009) 815-824.
- [16] V.A. Hemadri, A. Gupta, S. Khandekar, Thermal radiators with embedded pulsating heat pipes: infra-red thermography and simulations, *Applied Thermal Engineering* 31 (2011) 1332-1346.
- [17] E. Videcoq, M. Girault, V. Ayel, C. Romestant, Y. Bertin, On-line thermal regulation of a capillary pumped loop via state feedback control using a low order model, *Applied Thermal Engineering* 108 (2016) 614-627.
- [18] E.D. Waters, Heat pipes for the trans-Alaskan pipeline, *Proceedings of the 2nd International Heat Pipe Conference* (1976) 803-814, Bologna, Italy.
- [19] M. Zhang, Y. Lai, J. Zhang, Z. Sun, Numerical study on cooling characteristics of two-phase closed thermosyphon embankment in permafrost regions, *Cold Regions Science and Technology* 65 (2011) 203-210.
- [20] W. Anderson, M. Ellis, J. Hartenstine, C. Peters, C. Tarau, K. Walker, Variable conductance heat pipes for variable thermal links, in: 42nd International Conference on Environmental Systems (ICES), San Diego (CA), USA, 2012.
- [21] M. Leriche, S. Harmand, M. Lippert, B. Desmet, An experimental and analytical study of variable conductance heat pipe: application to vehicle thermal management, *Applied Thermal Engineering* 38 (2012) 48-57.
- [22] A. Faghri, *Heat pipe science and technology* (1995) Taylor & Francis.
- [23] S. Lips, F. Lefevre, A general analytical model for the design of conventional heat pipes, *International Journal of Heat and Mass Transfer* 72 (2014) 288-298
- [24] E. Pouzet, J.L. Joly, V. Platel, J.Y. Grandpeix, C. Butto, Dynamic response of a capillary pumped loop subjected to various heat load transients, *International Journal of Heat and Mass Transfer* 47 (2004) 2293-2316
- [25] N. Blet, V. Platel, V. Ayel, Y. Bertin, C. Romestant, Transient modeling of a capillary pumped loop for terrestrial applications, *Journal of Heat Transfer* 138 (2016) 072802 1-15
- [26] B. Holley, A. Faghri, Analysis of pulsating heat pipe with capillary wick and varying channel diameter, *International Journal of Heat and Mass Transfer* 48 (2005) 2635-2651
- [27] S.P. Das, V.S. Nikolayev, F. Lefevre, B. Pottier, S. Khandekar, J. Bonjour, Thermally induced two-phase oscillating flow inside a capillary tube, *International Journal of Heat and Mass Transfer* 53 (2010) 3905-3913
- [28] V.S. Nikolayev, A dynamic film model of the pulsating heat pipe, *Journal of Heat Transfer* 133 (2011) 081504 1-9
- [29] M. Mameli, M. Marengo, S. Zinna, Thermal simulation of a pulsating heat pipe: effects of different liquid properties on a simple geometry, *Heat Transfer Engineering* 33 (2012) 1177-1187
- [30] R. Bonner, A. Fan, D. Pounds, E. Yakhshi-Tafti, Heat pipe integration strategies for LED applications, *Electronics cooling* (2013), www.electronics-cooling.com/2013/09/heat-pipe-integration-strategies-for-led-applications.
- [31] J.C. Wang, R.T. Wang, T.L. Chang, D.S. Hwang, Development of 30 Watt high-power LEDs vapor chamber-based plate, *International Journal of Heat and Mass Transfer* 53 (2010) 3990-4001.
- [32] D. Campo, J. Weyant, B. Muzyka, Enhancing thermal performance in embedded computing for ruggedized military and avionics applications, in: 14th IEEE ITherm Conference, Lake Buena Vista (FL), USA, 2014.
- [33] H.C. Hsu, Isothermal plate module, United States Patent 20080035310A1, Taiwan, 2006.
- [34] Y. Tang, Z. Hu, J. Qing, Z. Xie, T. Fu, W. Chen, Experimental investigation on isothermal performance of the micro-grooved heat pipe, *Experimental Thermal and Fluid Science* 47 (2013) 143-149.
- [35] A. Fan, R. Bonner, S. Sharatt, Y. Sungtaek, An innovative passive cooling method for high performance light-emitting diodes, in: Semitherm Conference, San Jose (CA), USA, 2012.

- [36] J.Y. Sun, T. Chain, D.K. Shih, C.Y. Wang, High-efficiency isothermal heat pipe, United States Patent US005465782A, Taiwan, 1995.
- [37] H.N. Chaudhry, B.R. Hughes, S.A. Ghani, A review of heat pipe systems for heat recovery and renewable energy applications, *Renewable and Sustainable Energy Reviews* 16 (2012) 2249-2259.
- [38] Y. Liu, H. Zhang, Experimental studies on the isothermal and heat transfer performance of trough solar power collectors, *Advanced Materials Research* 1044-1045 (2014) 320-326.
- [39] E. Azad, Assessment of three types of heat pipe solar collectors, *Renewable and Sustainable Energy Reviews* 16 (2012) 2833-2838.
- [40] B. Rassamakin, S. Khairnasov, V. Zaripov, A. Rassamakin, O. Alforova, Aluminum heat pipes applied in solar collectors, *Solar Energy* 94 (2013) 145-154.
- [41] H. Hussein, H. El-Ghetany, S. Nada, Performance of wickless heat pipe flat plate solar collectors having different pipes cross sections geometries and filling ratios, *Energy Conversion and Management* 47 (2006) 1539-1549.
- [42] L. Wei, D. Yuan, D. Tang, B. Wu, A study on a flat-plate type of solar heat collector with an integrated heat pipe, *Solar Energy* 97 (2013) 19-25.
- [43] S. Rittidech, S. Wannapakne, Experimental study of the performance of a solar collector by closed-end oscillating heat pipe (CEOHP), *Applied Thermal Engineering* 27 (2007) 1978-1985.
- [44] J. Facao, A.C. Oliveira, Analysis of a plate heat pipe solar collector, *International Journal of Low Carbon Technologies* 1 (1) (2006) 1-9.
- [45] Y. Deng, Y. Zhao, W. Wang, Z. Quan, L. Wang, D. Yu, Experimental investigation of performance for the novel flat plate solar collector with micro-channel heat pipe array (MHPA-FPC), *Applied Thermal Engineering* 54 (2013) 440-449.
- [46] D. Reay, A. Harvey, The role of heat pipes in intensified unit operations, *Applied Thermal Engineering* 57 (2013) 147-153.
- [47] Z. Zhi-Ang, A study on using heat pipe technology for lowering temperature for storing up grain, *Proceedings of the 7th International Working Conference on Stored-product Protection Proceedings* 2 (1998) 1143-1147, Beijing, China.
- [48] J.T. Richardson, S.A. Paripatyadar, J.C. Shen, Dynamics of a sodium heat pipe reforming reactor, *AIChE Journal* 34 (5) (1988) 743-752.
- [49] J. Choi, Y. Yuan, D.A. Borca-Tasciuc, H. Kang, Design, construction and performance testing of an isothermal naphthalene heat pipe furnace, *Review of Scientific Instruments* 85, 095105 (2014).
- [50] Y.O. Parent, H.S. Caram, R.W. Coughin, Tube-wall catalytic reactor cooled by an annular heat pipe, *AIChE Journal* 29 (3) (1983) 443-451.
- [51] V.N. Le, Stratified flow chemical reactor, United States Patent 20030133856A1, Saudi Arabia, 2003.
- [52] X. Wang, T. Ma, Y. Zhu, H. Chen, J. Zeng, Experimental investigation on startup and thermal performance of a high temperature special-shaped heat pipe coupling the flat plate heat pipe and cylindrical heat pipes, *Experimental Thermal and Fluid Science* 77 (2016) 1-9.
- [53] X.K. Yan, Y.N. Duan, C.F. Ma, Z.F. Lv, Construction of sodium heat pipe furnace and the isothermal characteristics of the furnaces, *International Journal of Thermophysics* 32 (2011) 494-504.
- [54] F. Sanchez-Silva, I. Carvajal-Mariscal, A.E. Morino-Cordobes, P.Q. Diez, M.T. Velazquez, Study of an annular two-phase thermosyphon used as an isothermal source in thermometry, *Journal of Mechanical Engineering* 61 (4) (2015) 273-282.
- [55] F. Wu, D. Song, X. Yi, Z. Yu, K. Sheng, J. Wu, Cesium heat-pipe thermostat, in: *AIP Conference Proceedings* 1552 (2013) 830, Los Angeles (CA), USA.
- [56] W. Joung, Y.G. Kim, I. Yang, K.S. Gam, Operating characteristics of a loop heat pipe-based isothermal region generator, *International Journal of Heat and Mass Transfer* 65 (2013) 460-470.
- [57] L. Langston, A. Faghri, Heat pipe turbine vane cooling, in: *Advanced Turbine Systems Annual Program Review*, Morgantown (WV), USA, 1995.
- [58] D. Glass, M. Merrigan, J. Sena, R. Reid, Fabrication and testing of a leading-edge-shaped heat pipe, Technical Report NASA CR-1998-208720, 1998.
- [59] D. Glass, M. Merrigan, J. Sena, Fabrication and testing of Mo-Re heat pipes embedded in Carbon/Carbon, Technical Report NAS CR-1998-207642.
- [60] X. Guangming, D. Yanxia, G. Yewei, L. Lei, Y. Xiaofeng, W. Dong, Heat transfer characteristics and limitations analysis of heat-pipe-cooled thermal protection structure, *Applied Thermal Engineering* 70 (2014) 655-664.
- [61] C.C. Silverstein, A feasibility study of heat-pipe-cooled leading edges for hypersonic cruise aircraft, Technical Report NASA CR-1857, 1971.
- [62] H. Liu, W. Liu, A numerical model for the platelet heat-pipe-cooled leading edge of hypersonic vehicle, *Acta Astronautica* 118 (2016) 210-217.
- [63] C.A. Steeves, M.Y. He, S.D. Kasen, L. Valdevit, H.N.G. Wadley, A.G. Evans, Feasibility of metallic structural heat pipes as sharp leading edges for hypersonic vehicles, *Journal of Applied Mechanics* 76 (2009) 1-9.
- [64] D. Senterfitt, J. Mullaly, L. Hammer, A. Khan, J. Smeggil, Leading edge heat pipe arrangement, United States Patent US4966229, USA, 1990.
- [65] W. Peng, Y. He, X. Wang, J. Zhu, J. Han, Thermal protection mechanism of heat pipe in leading edge under hypersonic conditions, *Chinese Journal of Aeronautics* 28 (1) (2015) 121-132.
- [66] V. Baturkin, S. Zhuk, J. Vojta, F. Lura, B. Bierling, H.G. Lötze, Elaboration of thermal control systems on heat pipes for microsatellites Magion 4, 5 and BIRD, *Applied Thermal Engineering* 23 (2003) 1109-1117.
- [67] N.C. Rowe, Structural panel having integral heat pipe network, United States Patent US5506032, USA, 1996.
- [68] D. Bugby, W. Zimbeck, E. Krolczek, A. Williams, Satellite Modular and Reconfigurable Thermal System (SMARTS), in: *22nd Annual AIAA/USU Conference on Small Satellites*, Logan (UT), USA, 2007.
- [69] S.O. Peck, W.S. Bonneville, J. Cooney, Embedded heat pipe sandwich panel constructed using dissimilar materials, United States Patent US20020102384A1, USA, 2001.
- [70] B.J. Huang, Network-type heat pipe device, United States Patent US6269865B1, Taiwan, 2001.
- [71] C. Figus, L. Ounougha, Dispositif de régulation thermique à réseau de caloducs capillaires interconnectés, French Patent FR2009052156, France, 2009.
- [72] D.T. Queheillalt, G. Carbajal, G.P. Peterson, H.N.G. Wadley, A multifunctional heat pipe sandwich panel structure, *International Journal of Heat and Mass Transfer* 51 (2008) 312-326.

- [73] L. Low, C. Goodman, Spacecraft radiator system using crossing heat pipes, United States Patent US6776220B1, USA, 2004.
- [74] D.C. Bugby, W.R. Zimbeck, J.C. Preble, E.J. Kroliczek, SMARTS Thermal Architecture for PnPsat-2, in: AIP Conference Proceedings 1208 (2010) 34, Huntsville (AL), USA.
- [75] D. Mishkinis, P. Prado, R. Sanz, A. Torres, A.S. Merino, T. Tjptahardja, Development of LHP for intermediate temperature range, in: 15th International Heat Pipe Conference (IHPC), Clemson (SC), USA, 2010.
- [76] X. Yang, Y.Y. Yan, D. Mullen, Recent developments of lightweight, high performance heat pipes, Applied Thermal Engineering 33-34 (2012) 1-14.