



HAL
open science

Deep fusion of vector tracking GNSS receivers and a 3D city model for robust positioning in urban canyons with NLOS signals

Mohamed Sahmoudi, Aude Bourdeau, Jean-Yves Tournet

► To cite this version:

Mohamed Sahmoudi, Aude Bourdeau, Jean-Yves Tournet. Deep fusion of vector tracking GNSS receivers and a 3D city model for robust positioning in urban canyons with NLOS signals. 7th ESA Workshop on Satellite Navigation Technologies and European Workshop on GNSS Signals and Signal Processing (NAVITEC 2014), Dec 2014, Noordwijk, Netherlands. pp. 1-7. hal-01485015

HAL Id: hal-01485015

<https://hal.science/hal-01485015>

Submitted on 8 Mar 2017

HAL is a multi-disciplinary open access archive for the deposit and dissemination of scientific research documents, whether they are published or not. The documents may come from teaching and research institutions in France or abroad, or from public or private research centers.

L'archive ouverte pluridisciplinaire **HAL**, est destinée au dépôt et à la diffusion de documents scientifiques de niveau recherche, publiés ou non, émanant des établissements d'enseignement et de recherche français ou étrangers, des laboratoires publics ou privés.



Open Archive TOULOUSE Archive Ouverte (OATAO)

OATAO is an open access repository that collects the work of Toulouse researchers and makes it freely available over the web where possible.

This is an author-deposited version published in : <http://oatao.univ-toulouse.fr/>
Eprints ID : 17111

The contribution was presented at NAVITEC 2014 :
<http://esaconferencebureau.com/2014-events/14c12/introduction>

To cite this version : Sahmoudi, Mohamed and Bourdeau, Aude and Tournet, Jean-Yves *Deep fusion of vector tracking GNSS receivers and a 3D city model for robust positioning in urban canyons with NLOS signals*. (2014) In: 7th ESA Workshop on Satellite Navigation Technologies and European Workshop on GNSS Signals and Signal Processing (NAVITEC 2014), 3 December 2014 - 5 December 2014 (Noordwijk, Netherlands).

Any correspondence concerning this service should be sent to the repository administrator: staff-oatao@listes-diff.inp-toulouse.fr

Deep Fusion of Vector Tracking GNSS Receivers and a 3D City Model for Robust Positioning in Urban Canyons with NLOS Signals

Mohamed Sahmoudi
ISAE / SUPAERO
University of Toulouse
Toulouse, France

Aude Bourdeau
TESA Laboratory
University of Toulouse
Toulouse, France

Jean-Yves Tournet
ENSEEIH
University of Toulouse
Toulouse, France

Abstract—In urban canyons, the GNSS satellite signals may travel an additional distance due to reflection and diffraction before reaching the receiver antenna. Where no direct path is available, this is called a non-line of-sight (NLOS) propagation and adds a positive bias to the geometric measured pseudorange. In this paper, we address the issue of GNSS positioning in harsh environments using constructively the NLOS signals. To exploit these biased signals, we compensate for the NLOS bias using a 3D GNSS simulation model of the environment. We use the 3D model as a priori information to characterize the additional NLOS bias. In this work, we propose a deep integration of the 3D model-based signal characterization into an advanced GNSS receiver architecture called vector tracking loops. The proposed architecture is a combination of a vector tracking receiver and a co-processor of external local information to correct the GNSS measurements. Obtained results with real GPS signals illustrates the effectiveness of this approach to improve the accuracy and reliability of the navigation solution in urban canyons.

I. INTRODUCTION

The number of global navigation satellite system (GNSS) applications has steadily increased over the last decades, in particular for personal mobility (e.g., GNSS-enabled mobile-phones, smartphones and services). Intelligent systems of transportation are also an important segment of the GNSS market including in-car navigation and road user charging. However, the urban environment presents significant challenges for satellite positioning, because of satellite masking, multipath and NLOS propagation. As a consequence, the receiver delivers a position that can be biased by an error of several tens of meters [5], when it is not totally impossible to calculate a position. This is particularly true in the context of urban canyons, i.e., when the streets are very narrow and/or the buildings are very high. Multipath and NLOS propagation occurs when GNSS signals bounce off buildings and reach the receiver's antenna via different paths with a travelling time longer than that of the LOS path. Multipath and NLOS signals can be very strong and have small relative delays which makes them difficult to be distinguished from the desired path signal. Where no direct path is available, this is called a non-line of-sight (NLOS) propagation. These signals add a positive bias to the geometric measured pseudorange and thus are more challenging to mitigate in absence of the LOS. Existing works focus on the multipath mitigation problem and on detection and exclusion of NLOS. Examples of efficient in-receiver multipath mitigation methods include robust discriminators such as the

narrow correlator, the strobe correlator (see [5] for more details), and methods of multipath estimation and cancellation such as multipath estimating delay lock loop (MEDLL), the multipath elimination technology, the fast iterative maximum-Likelihood algorithm [13] and Bayesian filtering methods [6]. Most of these solutions can be applied only if the LOS signal is present. However, in urban canyon environment, the number of LOS satellites is very low and the position dilution of precision (PDOP) of these satellites is usually unsatisfactory. We suggest in this work to investigate the constructive use of multipath and NLOS signals instead of simply mitigating those reflections as in most current GNSS receivers.

If the user is in an NLOS context, the receiver will consider the received GNSS signal as a LOS and will estimate a pseudorange from the satellite biased by up to several tens of meters. It has been recognized that a stand-alone GNSS receiver is not enough to provide reliable location service in severely obstructed signal conditions. To deal with these difficulties, the GNSS receiver can be assisted by several sources of information such as inertial navigation sensors, wireless network or pseudolites retransmitting the GPS signal in constrained areas, requiring additional infrastructure and complex hybridization technologies. Another possibility is to exploit all the available information for improving the positioning performance in these harsh environments. One solution consists of comparing visible satellites with an a priori knowledge of the shadowed satellites [7]. Another solution is to use NLOS constructively rather than just deleting them. However, the difficulty in using NLOS signals is the capability of modelling the length of the indirect paths to characterize the bias. Without this knowledge, it is difficult to correct the distance error carried by the signal that has undergone secondary path. In [9] a geometric path model is used, whose parameters are estimated by a nonlinear filter. In [15], paths are calculated by laser scanning the environment. In [2], we have proposed a new navigation strategy based on the augmentation of GNSS measurements by a 3D model of the environment to compensate for the pseudorange errors. This approach tightly integrates the 3D model information in the measurements domain at the level of position computation. However, when not enough GNSS signals are tracked, methods of processing in the position-domain become insufficient, because available pseudoranges are not enough. In this context of GNSS reception with reduced availability, effort has to be made at the level of signals tracking in order to produce

measurements from very weak NLOS signals. Other recent works used a 3D map to assist the position computation in GNSS harsh environments [1], [16].

In this paper, we introduce a new approach of deep fusion that uses constructively non-line-of-sight (NLOS) GNSS signals jointly with a geometric city model in order to track enough signals to compute the user's position. We use the SE-NAV software to predict the geometric paths of NLOS signals using a high realistic 3D model of the urban environment [4]. To deal with the problem of signal outage in GNSS signals positioning, we use the advanced receiver architecture called vector tracking loops that has attracted much attention in recent years [8]. Although a vector-based architecture can greatly improve the tracking performance of the GNSS receiver, it is too limited if it cannot track enough satellites to compute a navigation solution, or if it tracks NLOS signals. In the proposed approach, the measurement model traditionally based on the trilateration equations is constructed from the received paths estimated by SE-NAV. The Jacobian of the measurement model is calculated through knowledge of the objects on which the reflections have occurred. To use even less reliable measurements, we use a robust version of the extended Kalman filter (EKF) in order to reduce the impact of non consistent measurements (i.e. outliers) [12].

II. SIMULATING GNSS SIGNALS WITH A 3D MODEL

The SE-NAV software has been developed by the company OKTAL-SE to simulate GNSS signal reception in a urban environment. SE-NAV simulates the propagation of a GNSS signal in a 3D virtual scene, using a ray-tracing algorithm to compute the shadowing effects and the multipath generated by objects of the environment. It uses geometric optics to calculate reflected, diffracted and transmitted rays. In this paper, only the reflected signals are considered for reason of simplicity. Fig. 1 presents a SE-NAV simulation of reflected signals in Toulouse downtown. Signals in white are LOS signals and signals in blue or red are multipath and NLOS signals.

3D virtual scenes can be loaded in SE-NAV from the most classical 3D formats if the environment is represented as plans. For this paper, we have worked with a scene provided by the SE-NAV software, which corresponds to Capitole Square in Toulouse. After the configuration of the 3D virtual scene, SE-NAV can take as inputs the satellite and receiver positions and speeds. The software outputs are the geometrical configurations of received signals and Dopplers for all signals. If the received signal is a multipath/NLOS, SE-NAV provides also the coordinates of the reflection points and the equations of the reflection plans.

In summary, the SE-NAV simulator provides deterministic geometric information for the received GNSS signals at a certain position and for a given time instant. Note that the physical aspect of signal propagation is not considered in this paper as we focus on the geometric bias compensation in the stage of signal tracking.

III. VECTOR TRACKING GNSS RECEIVER

A. Basics of Vector Tracking Architecture

1) *Measurements model*: During the tracking loops, generated replica of code and carrier signals are correlated

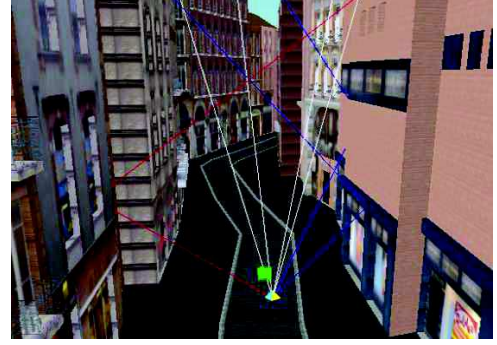

Fig. 1. SE-NAV simulation in Toulouse downtown by OKTAL-SE

with incoming signals to generate three correlator pairs $(I_E, Q_E, I_P, Q_P, I_L, Q_L)$, where I and Q stands for the inphase and quadrature components of a correlator,

respectively. The subscripts E, P and L represent early, prompt and late versions of the correlator pairs, respectively. For a given satellite, the correlator output at time epoch k is expressed as follow:

$$\begin{aligned} I_k &= \frac{A}{\sqrt{2}} M D_k \frac{\sin(\pi \Delta f_{d_k} T_{coh})}{\pi \Delta f_{d_k} T_{coh}} R(\tau_k + \delta T_c) \cos(\Delta \Phi_k) + n_k \\ Q_k &= \frac{A}{\sqrt{2}} M D_k \frac{\sin(\pi \Delta f_{d_k} T_{coh})}{\pi \Delta f_{d_k} T_{coh}} R(\tau_k + \delta T_c) \sin(\Delta \Phi_k) + n_k, \end{aligned} \quad (1)$$

where M is the number of samples by correlation period, D_k denotes the navigation data bit, T_{coh} denotes the coherent integration time, $R(\cdot)$ is the GPS C/A-code signal autocorrelation function and $\Delta \Phi_k$ is the average of the phase error. The code chip is denoted by T_c and the correlator early-late spacing by d . The value of $\delta = -d/2$ corresponds to the early correlation, $\delta = -d/2$ to the prompt and $\delta = d/2$ corresponds to the late correlation. The noise term is assumed to be normally with zero mean and variance $\sigma_{I,Q}^2$.

Each period T_a , the discriminator delivers a value of errors. After averaging L output of discriminator over LT_a ms, they are used by the non-linear discriminator to estimate the code phase and frequency shift errors. At each time epoch, the early-minus-late power discriminator output of each satellite number $i = 1, \dots, N$ is given by [10],

$$D(\tau_i) = (I_E^2 + Q_E^2)^2 - (I_L^2 + Q_L^2)^2 = A^2 M^2 (2-d) \tau_k + \xi_i \quad (2)$$

or,

$$\tilde{D}(\tau_i) = D(\tau_i) / A^2 M^2 (2-d) = \tau_i + \tilde{\xi}_i \quad (3)$$

It should be noted that the cross product FLL (frequency lock-loop) discriminator is chosen in this work and computed by using adjacent pairs of prompt correlator samples at time t_1 and t_2 as,

$$D(\Delta f_{d_i}) = (I_{P_1} Q_{P_1} - I_{P_2} Q_{P_2}) / (t_1 - t_2) = \pi A^2 M^2 \Delta f_{d_i} + \varsigma_i, \quad (4)$$

or

$$\tilde{D}(\Delta f_{d_i}) = D(\Delta f_{d_i}) / \pi A^2 M^2 = \Delta f_{d_i} + \tilde{\varsigma}_i, \quad (5)$$

where Δt is the accumulation interval for early and late correlators, ξ_i and ς_i are the code and Doppler measurements noise samples. According to equations (3) and (5), the discriminators output is linear with the code error (i.e. pseudorange residuals) and frequency errors, respectively, over a region of

small errors. The above equations are also used to estimate the discriminators noise variances needed for the noise covariance matrix in the Kalman filter of the VDLL.

2) *EKF of the vector tracking loop*: In this paper we use the vector tracking (VDLL) instead of the standard code delay loops DLLs to track the *code phase* of satellite collectively and we use standard scalar FLLs to track the *frequency* of each satellite independently as implemented in [18]. In comparison to conventional tracking loops, the VDLL uses an extended Kalman filter (EKF) to track all channels together taking advantage of the spatial correlation between different satellite signals instead of processing them individually. The VDLL track the signals but also estimate the user position. By this combination of tracking and positioning modules the vector approach is able to predict the code phase from the computed position to maintain the tracking lock over short outage of a satellite signal, and to maintain track of weak signals. Thus the tracking of weak signals is aided by the other strong ones.

The vector loop navigation filter is an EKF which combines information from all satellites to estimate the following state vector $\Delta X_k = [\delta x, \delta y, \delta z, \delta b, \delta V_x, \delta V_y, \delta V_z, \delta d]^T_k$, where $\delta x, \delta y, \delta z$ are the residuals of the position coordinates, $\delta V_x, \delta V_y, \delta V_z$ are the residuals of velocity coordinates. The receiver clock bias is denoted by b_k and d_k denotes the clock drift. The estimated position, velocity and clock terms are predicted over time using the dynamic model according to the prediction step of the EKF:

$$X_{k+1}^- = F X_k^+, \quad (6)$$

where F is the transition matrix corresponding to a constant velocity motion model [10]. In the non-coherent VDLL, the used measurements in the EKF are the averaged outputs of the code phase and carrier frequency discriminators. The code discriminator output is accumulated over 20 ms and a number of such outputs are averaged over T sec for smoothing the measurements updates. Both code and carrier frequency discriminator outputs are proportional to code and frequency errors, respectively. Then, they are viewed as pseudorange and range rate residuals (i.e. $\delta \rho_i$ and $\delta \dot{\rho}_i$, respectively). To express the pseudorange in meters, we use the formula:

$$\delta \rho_i = -\tilde{D}(\tau_i) \frac{c}{f_0}. \quad (7)$$

For expressing the range rate in meters/second, we use the following unit transformation:

$$\delta \dot{\rho}_i = -\tilde{D}(\Delta f_{d_i}) \frac{c}{f_{L1}} \quad (8)$$

The constant c is the speed of light, f_0 is the chipping rate (1.023 MHz for GPS C/A code), and f_{L1} is the L1 band carrier frequency (1575.42 MHz for the GPS L1 signal). The code and frequency discriminators output are used as measurements and are related to the errors in the position, velocity and clock

parameters as follows,

$$\begin{aligned} e_{k+1} &= \begin{pmatrix} \delta \rho_1 \\ \vdots \\ \delta \rho_N \\ \delta \rho_1 \\ \vdots \\ \delta \dot{\rho}_N \end{pmatrix}_{k+1} \\ &= H_{k+1} \Delta X_{k+1} + \varepsilon_{k+1}, \end{aligned} \quad (9)$$

where H_{k+1} is the geometric matrix composed of zeros and LOS vectors [10]. The estimation of position, velocity, and clock parameters via the VDLL EKF are given by the correction step of the Kalman filter as follows,

$$X_{k+1}^+ = X_{k+1}^- + K_{k+1} e_{k+1}, \quad (10)$$

$$P_{k+1}^+ = (I_8 - K_{k+1} H_{k+1}) P_{k+1}^- \quad (11)$$

where K_{k+1} is the Kalman gain matrix and e_{k+1} is the vector of measurements residuals obtained from equation (9). The required noise statistics R and Q for tuning the EKF of the VDLL is adopted from existing references [10], [8], [18].

The estimated state vector is used to command the NCO to generate the code replica inside the receiver. This is done by predicting the pseudorange $\delta \rho_i$ by subtraction between the VDLL receiver position and the computed satellites positions plus ionospheric $\delta \rho_I$ and tropospheric $\delta \rho_T$ terms obtained from standard models and clocks compensation. For each time epoch k as follows:

$$\tilde{\delta \rho}_i = \|X_{rec} - X_{sat,i}\| + \delta \rho_{T,i} + \delta \rho_{I,i} + \delta \rho_{sv,i} - b_k \quad (12)$$

The receiver clock bias b_k is obtained from the VDLL navigation solution and the satellite clock error $\delta \rho_{sv,i}$ is estimated by the polynomial correction with parameters from the decoded navigation message. The vector tracking approach gains more sensitivity than scalar tracking DLLs, because the NCO command for each channel is computed via the VDLL solution using information from all channels.

According to the above equations, the performance of the state estimation and then the performance of signal tracking via the NCO corrections depend on the geometry of used satellites via matrix H_k , the signal quality via the discriminators output used as measurements and the user dynamics through the residuals of Doppler frequency.

B. Performance of vector tracking in NLOS

In the tracking of NLOS, the geometric range will have an additional path, or equivalently the code delay will have a bias term b_{nlos} . Produced by the discriminator, this bias will be injected in the state estimation during the step of measurements update in the Kalman filter. If we consider only the position components of the state vector $X_{k,p}$, we can write:

$$\begin{aligned} X_{p,k+1}^+ &= X_{p,k+1}^- + K_{p,k+1} (e_{k+1} + B_{k+1,nlos}), \quad (13) \\ &= X_{p,k+1}^- + K_{p,k+1} e_{k+1} + K_{p,k+1} v_{k+1,nlos} \end{aligned}$$

where $K_{p,k+1}$ the Kalman gain corresponding to the position part of the state and $B_{k+1,nlos}$ denotes the bias introduced in the pseudorange residuals. This results in the state correction being corrupted by a factor of $K_{p,k+1}B_{k+1,nlos}$ related to the NLOS bias, which is not taken into account in the design of the optimal Kalman gain matrix. Accordingly, this bias will be propagated into the tracking loops via the generated code replica from the estimated position introducing a bias of $H_{k+1}K_{p,k+1}B_{k+1,nlos}$. Therefore, statistical techniques (e.g. test based on innovation) are not effective in the case of NLOS, because the predicted measurements are biased then the comparison with received measurements from the biased discriminator output is useless. Because the NLOS effect depends on the varying receiver environment, to mitigate its effect we need geometric information about the signal reflections.

Where the user position is known a priori within hundreds of meters, one can use a 3D model to predict the signal geometric configuration via a GNSS simulator such as SE-NAV [2], [11]. We propose to integrate this bias information in the vector tracking loops to prevent the position from deviating from the true value, then affecting the VDLL. Vice versa the tracking loops will help the EKF/3D model to track weak NLOS signals and then improve availability of the navigation solution. To achieve a more accurate positioning solution and better predict the satellite signal characteristics, we use a 3D model to predict the bias related to NLOS. More precisely, we propose a new version of the vector tracking GNSS receiver augmented by the information provided by SE-NAV, for GNSS navigation in a NLOS context.

IV. DEEP FUSION OF VDLL GNSS AND 3D MODEL

Currently a major trend in the field of navigation of automotive systems is the use of mapping and Geographic Information Systems (GIS) to integrate a timeliness and accurate geospatial data in the process of perception and navigation. Mobile mapping and positioning systems can exploit this geospatial information to achieve greater efficiency over traditional GPS/inertial systems.

A. Proposed approach and measurements model

Using a 3D urban model to forecast satellite visibility in urban contexts to improve availability and reliability of GNSS positioning is the main contribution of this article. In this section, we explain how we compensate for the NLOS bias using a 3D model of the environment, which is better adapted for the bias estimation of NLOS measurements than statistical methods that are based only on the received signals. Using SE-NAV we obtain the estimation of the reflector objects (e.g. walls) on which the reflections occur. In the case of two successive reflections of the signal, we can express the equation of pseudorange as,

$$\rho_i = \|X_{rec} - I_1\| + \|I_1 - I_2\| + \|I_2 - X_{sat}\| + e_i \quad (14)$$

where X_{rec} denotes the receiver position, X_{sat} is the satellite position and e_i denotes the error budget (noise, tropospheric and ionospheric delays, receiver and satellite clock errors). In the above equation of biased measurement, I_1 and I_2 are the reflection points on walls 1 and 2 respectively. The walls are defined by their normal vectors N_1 and N_2 and their

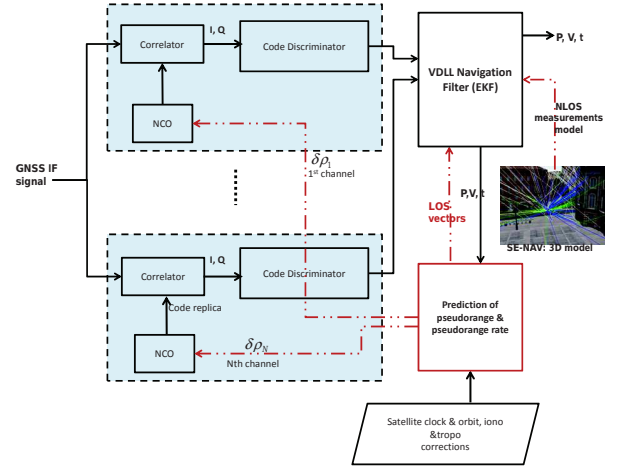

Fig. 2. The architecture of the proposed VDLL assisted by the SE-NAV simulator (a 3D environment model).

coefficients d_1 and d_2 , which are determined thanks to SE-NAV information (see [3] for more details). When a multipath or NLOS is predicted by SE-NAV, we compute the Jacobian matrix of measurements H_k of equation (9) using the above complex equation instead of the classic root square function linking the pseudorange to receiver and satellite positions plus errors. In this case, we propose to use the 3D city model & GNSS simulator to determine the true geometric path traveled by the signal at the correction step of the Kalman filter of the vector tracking, as sketched in diagram 2. More precisely, the compensation of the NLOS bias is performed in two steps:

- 1) *3D model Bias correction:*

$$\begin{aligned} \rho_{meas,k} &= \rho_{k,los} + e_k + B_{k,nlos} \\ \text{then } \delta\rho_k &= e_k + B_{k,nlos} \end{aligned} \quad (15)$$

The bias term $B_{k,nlos}$ is provided by the 3D city model-dependent GNSS simulator, then subtracted from the measured pseudorange $\rho_{meas,k}$ at the output of the vector tracking discriminator. Two different methods may be used to estimate the bias from the simulator information; either use directly the additional geometrical distance provided by SE-NAV (using ray-tracing geometric optics of waves propagation) as in [3] or reconstruct the correlator and code discriminator output from the signal parameters predicted by SE-NAV as in [4].

- 2) *Covariance adaptation:* the Kalman filter performance is very sensitive to the prior information on the measurements uncertainty given by the covariance matrix R . In this work, we use $R = \text{diag}[\sigma_1^2, \dots, \sigma_N^2]$, where

$$\sigma_k^2 = (\sigma_{k,0} + B_{k,nlos})^2, \quad (16)$$

and $\sigma_{k,0}$ corresponds to the computed variance of the code discriminator in the presence of white Gaussian noise given in many references [10].

As SE-NAV requires an input position, we use the predicted position in the Kalman filter via the motion model. To

robustify the proposed method, we generate a set of 20 position candidates around the predicted one, we apply a robust Kalman filter version [12], then we select the most probable solution using the well known Mahalanobis distance.

B. Integrity and robustness of the 3D augmented VDLL GNSS

The objective of this section is to assess the performance of the VDLL augmented by a 3D model.

- **Monitoring of the efficiency of the 3D model assistance:** The first 3x3 bloc of the state covariance matrix corresponds to the VDLL uncertainty on the position solution noted by $P_{pos,k+1}^+$. To monitor the impact of degraded 3D model input to the Kalman filter we propose to use a test of consistency checking between the pseudorange residuals and position uncertainty. The residual covariance is given by $H_{k+1}P_{pos,k+1}^+H_{k+1}^T$, then it depends on both geometry (of satellites and 3D model) via H_{k+1} and the position accuracy via $P_{pos,k+1}$. We propose to compute a maximum position uncertainty indicator by applying techniques of principal component analysis (PCA). The position covariance matrix can be decomposed as follows:

$$P_{pos,k+1}^+ = \sum_{n=1}^3 \lambda_n \mathbf{u}_n \mathbf{u}_n^T. \quad (17)$$

When the 3D model prediction is degraded the residual data still contain NLOS terms instead of white noise in the case of a good estimation. This fact motivates us to use a statistical test to check the spreading of the covariance spectrum via the following test [14]:

$$T_2 = \frac{\frac{1}{3} \text{Trace}[P_{pos,k+1}^+]}{[\det(P_{pos,k+1}^+)]^{\frac{1}{3}}} = \frac{\frac{1}{3} \sum_{n=1}^3 \lambda_n}{[\prod_{n=1}^3 \lambda_n]^{\frac{1}{3}}} \quad (18)$$

In the presence of only white Gaussian noise, the diagonal elements of the position error covariance matrix have identical values, which implies that the statistic satisfies $T_2 \leq 1$. Then, when T_2 is significantly larger than 1, we decide that there is a contribution from multipath and NLOS signals in the input data that is mismodeled by SE-NAV and we compute again the PVT without the predicted information from the 3D model. In that case, we increase the covariance of the measurements noise and we apply a pre-processing of data whitening before the EKF [8].

- **Integrity monitoring of the VDLL inputs: output of discriminators.** One distinct issue of the vector tracking is that one fault or large error in one channel will affect all other pseudoranges via the collective processing of satellite in the navigation filter. To prevent this side effect on the VDLL, we introduce a new technique to monitor the vector tracking integrity by checking and validating the discriminators output depending to each situation. We apply the same concept of RAIM (receiver autonomous integrity monitoring) but using the output of discriminators rather than pseudorange residuals of VDLL. The reason is that

in vector VDLL architecture, $\tilde{\delta\rho}_i$ include already the impact of the PVT. Therefore, we use the following metric as input to RAIM processing instead of $\tilde{\delta\rho}_i$:

$$z_k = \frac{1}{L} \sum_{k=1}^L \delta\rho_i \propto \frac{1}{L} \sum_{k=1}^L D_i(\tau_{i,k}), \quad (19)$$

where $D_i(\tau_{i,k})$ is the early-late power code discriminator output accumulated over T_d .

We average the pseudorange residuals or equivalently the non-linear signals to improve the signal to noise ratio (SNR) before applying the integrity monitoring method weighted RAIM [17]. In the processed GPS signals, satellite N16 was detected as faulty then excluded from the set of satellites in visibility.

V. RESULTS WITH REAL GPS SIGNALS IN URBAN CANYONS

In this work, we processed real RF GPS L1 C/A signals collected by a bittgrabber and a reference system as well (a high grade GPS/IMU system). The trajectory was recorded in the old downtown of the city of Toulouse in France, close to "Place du Capitole" characterized by narrow streets as presented in Fig. 3. The Novatel antenna was fixed on the roof of the car in a medium dynamic scenario. The used CRISTALINA bit-grabber provides the baseband measurements I and Q signals, at a frequency of 25 MHz.

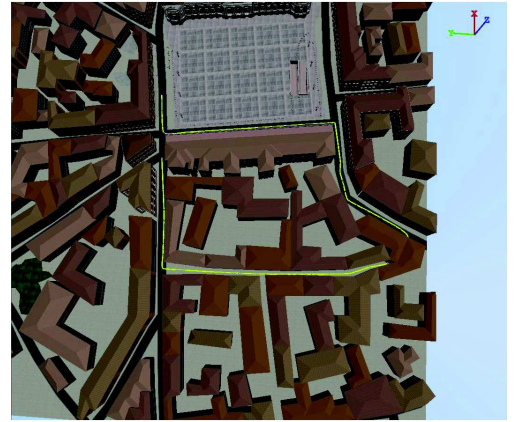

Fig. 3. Trajectory of the measurements campaign in the city of Toulouse.

The satellites in visibility during this trajectory are plotted in the sky plot of figure 4. We can observe that satellites N3, N6, N16 and N25 are very low and close to the horizon.

Applying the proposed technique of using weighted RAIM to monitor vector tracking channels, we excluded satellite N16 which was in a restricted visibility. Actually, the chi-square test related to RAIM was observed to exceed the threshold most of the time, because of large residuals due to high attenuation and large NLOS bias.

To compare the results of a standard DLL tracking module and a VDLL one, we plot the visibility of satellite N25 to the receiver in Fig. 5. Clearly, the VDLL tracks this weak satellite

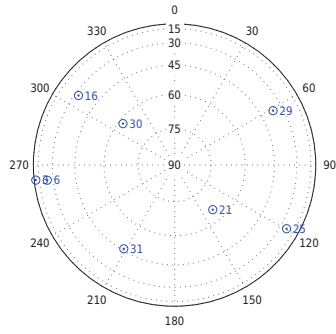

Fig. 4. Positions of satellites in visibility to the receiver antenna during the period of data collection in Toulouse.

signal over a longer period of time, because the weak channels benefit from the strong ones in the collaborative processing of vector tracking.

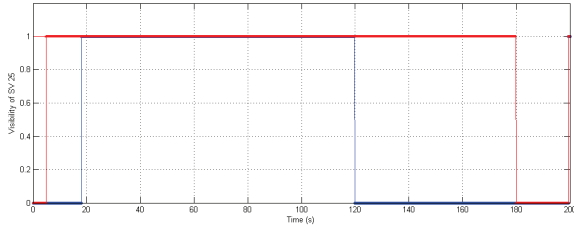

Fig. 5. Visibility of satellite number 25 to the DLL-based receiver (in blue) and to the VDLL-assisted by the 3D model (in red).

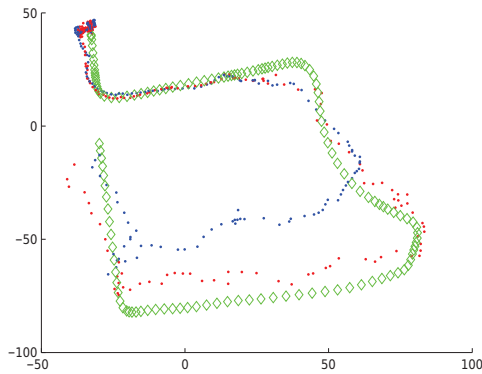

Fig. 6. Trajectories estimated by the robust EKF with the standard VDLL (in blue) and the robust EKF with the VDLL assisted by a 3D model (in red). The reference trajectory is plotted in green.

Figures 6 and 7 illustrates position error and the 3σ bounds for both robust EKF with a standard VDLL and for the robust EKF with VDLL assisted by 3D. For all satellites, the computed positions with the VDLL augmented with a 3D model & GNSS simulator outperforms the standard VDLL after 130s providing more accurate navigation solution than the existing vector tracking. In degraded situations, a better

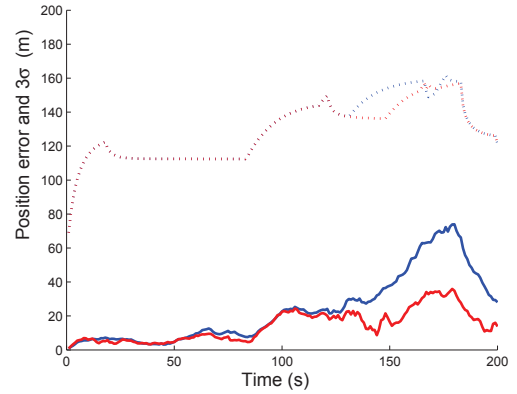

Fig. 7. Position error (solid lines) and the 3σ bounds in dashed lines for both robust EKF with a standard VDLL (in blue) and for the robust EKF with VDLL assisted by 3D (in red).

prediction of code delays improves the tracking results and then the PVT final solution. This is a promising scheme for positioning in deep urban canyons, motivated by the growth of connected receivers able to use information from external resources.

VI. CONCLUSION AND PERSPECTIVES

In this work, we proposed a new architecture of a vector tracking GNSS receiver augmented by a 3D city model and a GNSS propagation simulator. We take into account the uncertainty on the required initial position to the 3D model coupled with the GNSS simulator by considering a refinement step for better selection among several results when using a grid of initial inputs. To select the best solution, a map-matching algorithm with a 2D map could help in solving this problem. Indeed, if the candidate positions are fed to SE-NAV then different solutions will be computed and projected in the 2D map to consider only those on the correct road segment before applying innovations and Mahalanobis distance to discriminate against outliers.

To overcome the limitation of the realism of the 3D model & GNSS simulator, we proposed also three statistical techniques for robustness and integrity monitoring in presence of errors related to non modeled bias in the predicted measurements. The obtained results permit us to conclude that assisting the vector tracking receiver by predicting signals reception in urban areas by a GNSS simulator and a 3D mapping model, the receiver could use constructively the weak NLOS signals to improve the accuracy and integrity of its solution. Other methods could be proposed to use the 3D model information jointly with the predicted propagation of signals from the GNSS simulator, also to deal with the gap between simulation and real world.

The SE-NAV 3D simulation model is highly computationally intensive and demanding in terms of a priori information. However, according to our exchange with industrial partners this approach is still interesting and has promising applications, because the heavy computation could be done on a server or on a computation center for the case of a connected receiver,

which is the case of most of future GNSS utilizations including intelligent transportation systems and personal devices.

ACKNOWLEDGMENT

The authors would like to thank OKTAL-SE, Thales Alenia Space and DGA for supporting this work.

REFERENCES

- [1] D. Betaille, F. Peyret, M. Ortiz, S. Miquel and L. Fontenay, "A New Modeling Based on Urban Trenches to Improve GNSS Positioning Quality of Service in Cities," *IEEE Intelligent transportation systems magazine*, Fall 2013.
- [2] A. Bourdeau, M. Sahnoudi, and J.Y. Tourneret, "Constructive Use of GNSS NLOS-Multipath: Augmenting the Navigation Kalman Filter with a 3D Model of the Environment", *Proceedings of International Conference on Information Fusion (FUSION 2012)*, Singapore, July 2012.
- [3] A. Bourdeau, M. Sahnoudi and J.-Y. Tourneret, "Tight Integration of GNSS and a 3D City Model for Robust Positioning in Urban Canyons," in *Proceedings of the ION GNSS 2012*, Nashville, TN, USA, Sept. 2012.
- [4] A. Bourdeau, M. Sahnoudi, J.-Y. Tourneret, "Prediction of GNSS Signal Bias Using a 3D Model in Urban Environments," *Proc. European Navigation Conference (ENC 2012)*, Wien, Austria, April 2013.
- [5] E. Kaplan, *Understanding GPS: Principles and Application*, 2nd Edition, Artech House, Norwood, MA, 2006.
- [6] P. Closas, C. Fernandez-Prades, J. Diez, and D. de Castro, "Nonlinear Bayesian Tracking Loops for Multipath Mitigation," *International Journal of Navigation and Observation*, Hindawi, Volume 2012.
- [7] P. Groves, "Shadow Matching: A New GNSS Positioning Technique for Urban Canyons", *Journal of the Royal Institute of Navigation*, vol.64, pp. 417-430, 2011.
- [8] Paul Groves, *Principles of GNSS, Inertial, and Multisensor Integrated Navigation Systems*, Second Edition, Artech House 2013.
- [9] D. Gustafson, J. Elwell, and J. Soltz, "Innovative Indoor Geolocation Using RF Multipath Diversity", *Proceedings of IEEE/ION Position Location and Navigation Symposium*, San Diego, CA, April 2006.
- [10] M. Lashley, and D. Bevely, "A Valid Comparison of Vector and Scalar Tracking Loops," *Proceedings of IEEE/ION PLANS 2010*, Indian Walls, CA, Ma 2010.
- [11] <http://www.oktal-se.fr/>
- [12] K. D. Rao, M.N.S. Swamy and I. Plotkin, "GPS Navigation with Increased Immunity to Modeling Errors", *IEEE Transaction of Aerospace and Electronic Systems*, vol.40, no.1, pp. 2-11, Jan. 2004.
- [13] M. Sahnoudi and M. Amin, "Fast Iterative Maximum-Likelihood Algorithm (FIMLA) for Multipath Mitigation in Next Generation of GNSS Receivers", *IEEE Transactions in Wireless Communications*, vol.11, no.7, pp. 4352-4374, Nov. 2008.
- [14] M. Sahnoudi and M. Amin, "Robust Synchronization of Weak GPS Signals in Multipath and Jamming Environments," *Elsevier Signal Processing*, 89(7), 2009.
- [15] A. Soloviev and F. Van Graas, "Utilizing Multipath Reflections in Deeply Integrated GPS/INS Architecture for Navigation in Urban Environments", *Proceedings of IEEE/ION Position Location and Navigation Symposium*, Monterey, CA, May 2008.
- [16] Taro Suzuki, Nobuaki Kubo, "Correcting GNSS Multipath Errors Using a 3D Surface Model and Particle Filter," In *Proceedings of the ION GNSS'2013 conference*, Spetember, Nashville, TN, 2013.
- [17] Todd Walter and Per Enge, "Weighted RAIM for Precision Approach," in *Proceedings of the ION GPS conference*, USA, September 1995.
- [18] Hui ZHOU, *Study of a GNSS Receiver with Vector Tracking Loops Robuist to Multipath*, Master Thesis under supervision of M. Sahnoudi, ISAE, University of Toulouse, September 2012.