

Eco-design of Reducing energy use in food manufacturing processes by process flowsheeting: application to milk evaporation

Martial Madoumier
Catherine Azzaro-Pantel
Geneviève Gésan-Guiziou

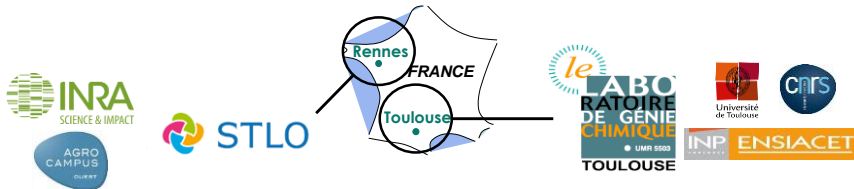

Skills:

- Concentration and separation processes
 - Mechanisms involved in dairy processes
 - Modelling of dairy processes
- www.rennes.inra.fr/stlo

Skills:

- Modelling and simulation
 - Optimisation
 - Product and process design
- <http://lgc.inp-toulouse.fr/>

Eco-design approach 1: Comparative assessment of processes

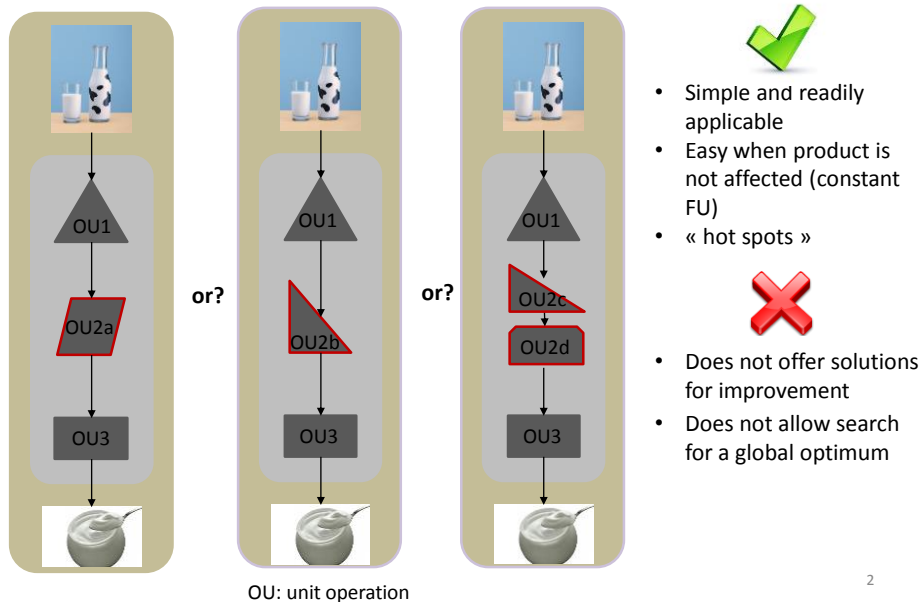

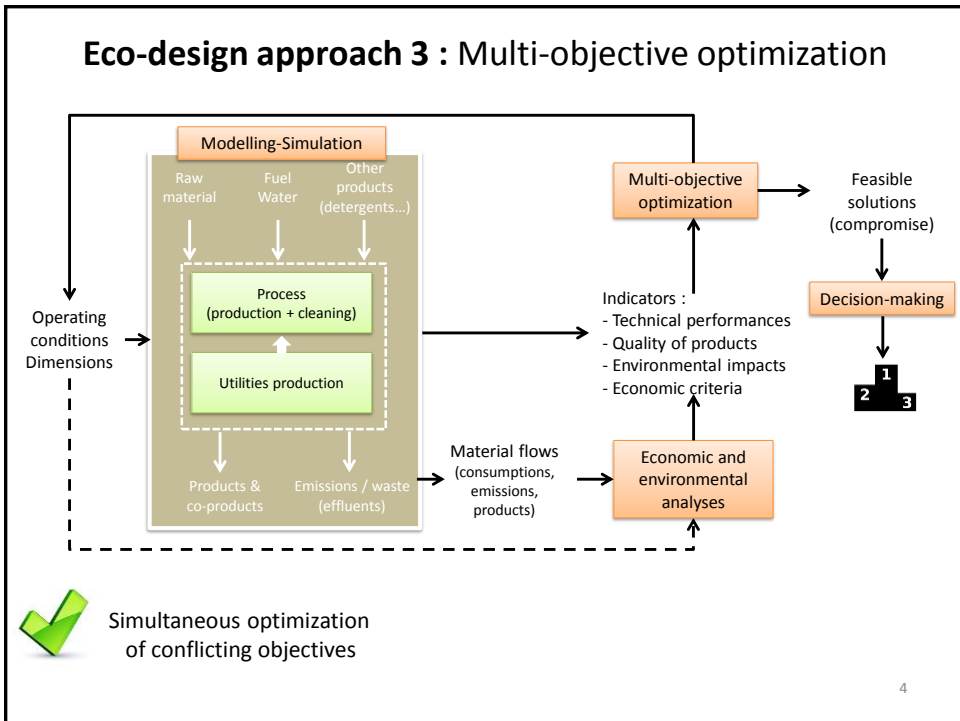
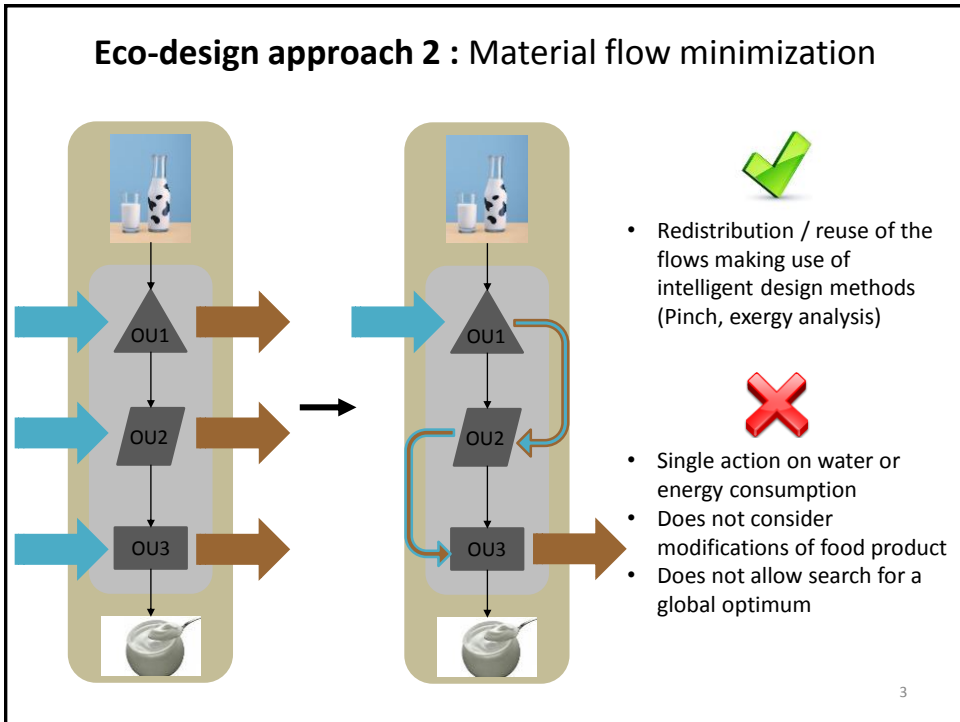

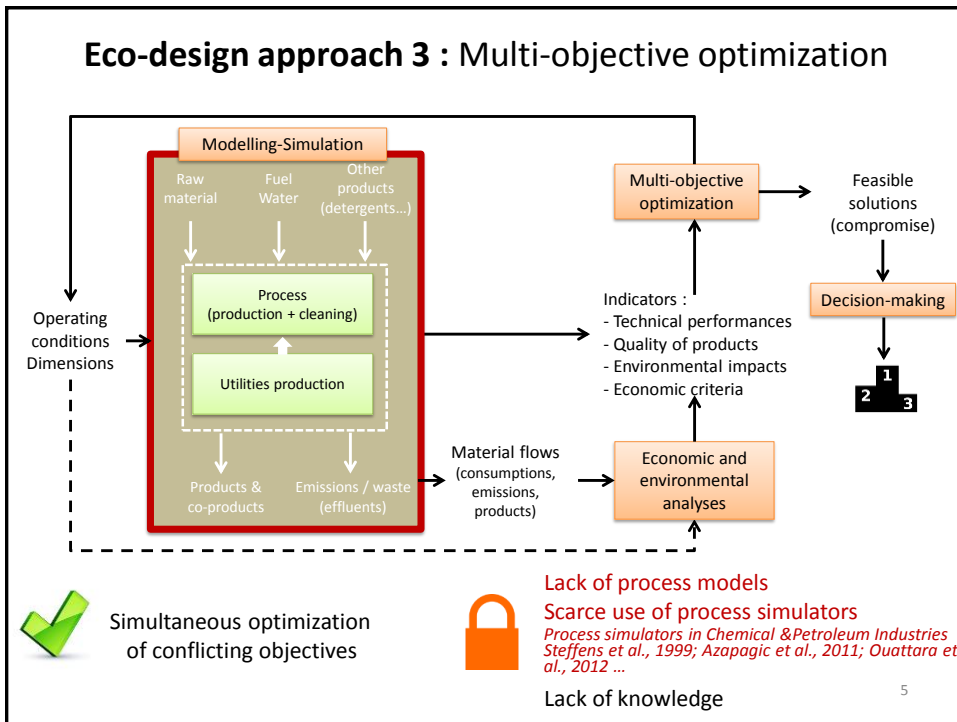

Objective

To develop a framework for the eco-design of food processes using the multi-objective optimization approach

To use process flowsheeting simulator to model the food process

Case study : a falling film evaporator treating milk

Case study: evaporation of milk

Concentration and drying of dairy products

- Dairy industry = key sector in the EU food sector
- Highly energy-intensive process: 25% of the total energy used in the dairy industry (Agreste, 2011)

- > 50% of the energy consumption of the overall concentration and drying process (Jebson, 1991)
- Various options for evaporator design
- No holistic approach for the design of evaporator

Milk

- Low fouling of the evaporator (/whey)
- Experimental and industrial data available for the process

7

Building-up of the framework for the eco-design of a evaporator using the multi-objective optimization approach

Choice of Aspen Plus

- Coupling with optimization algorithms
- Integration of data/correlations/ models in the software by users

8

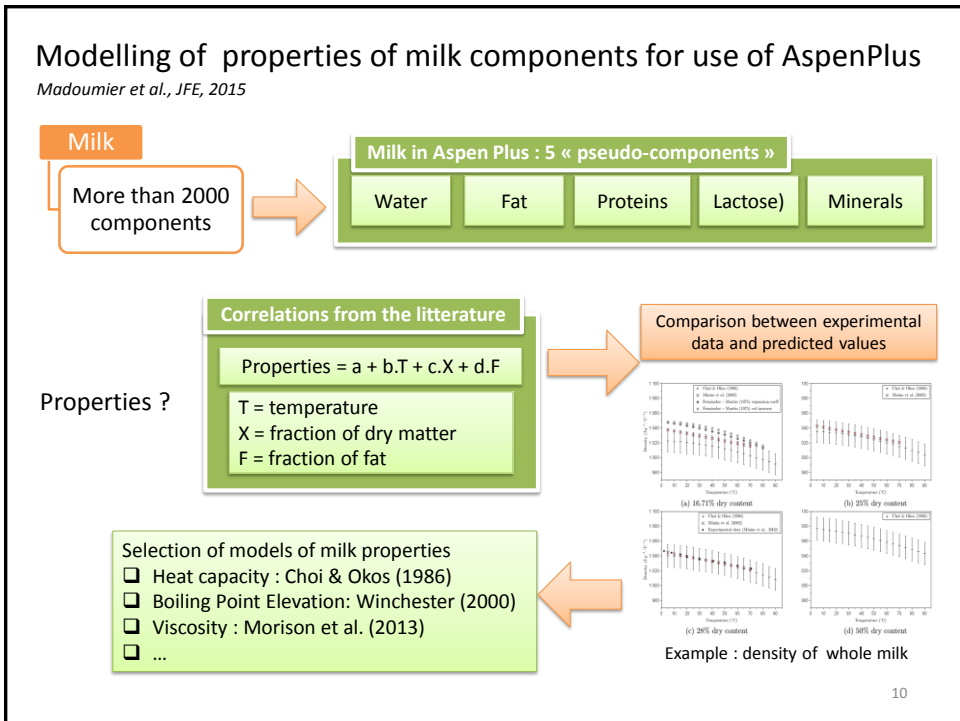
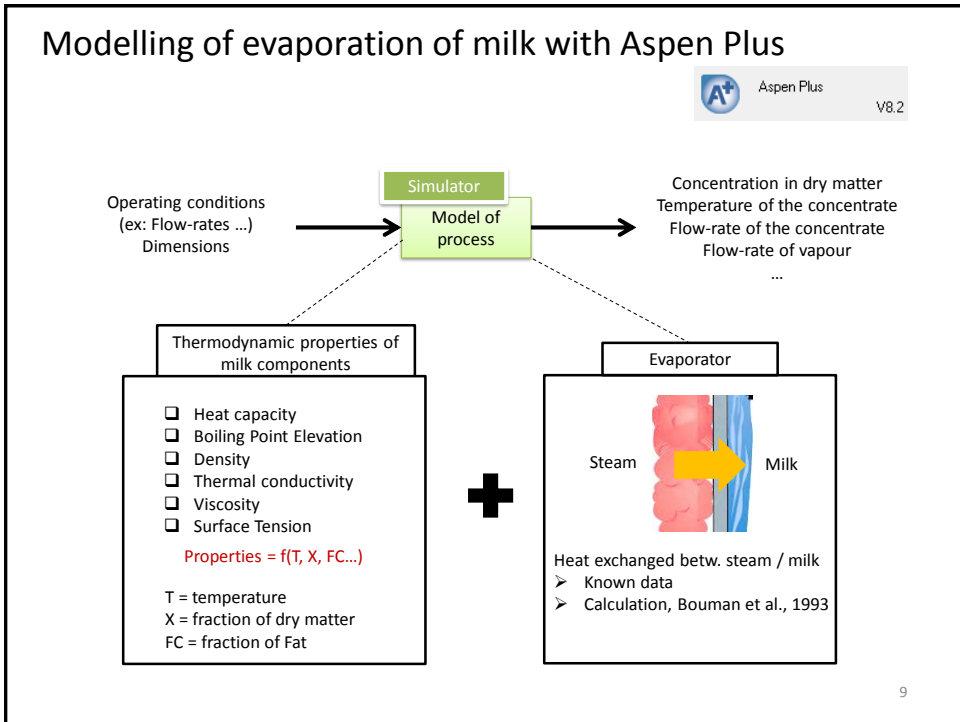

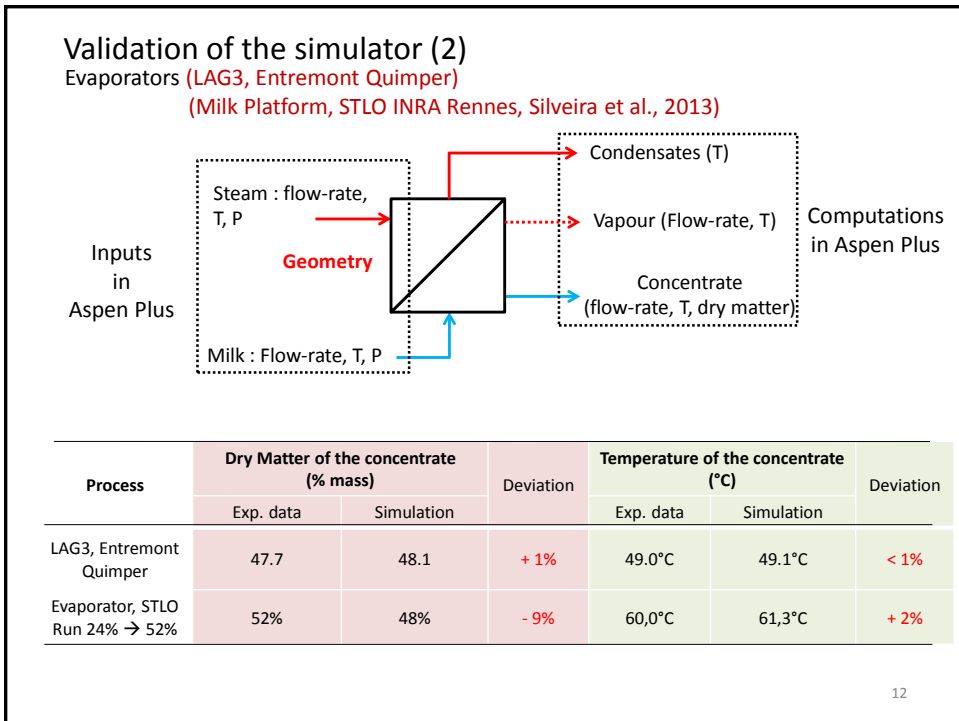
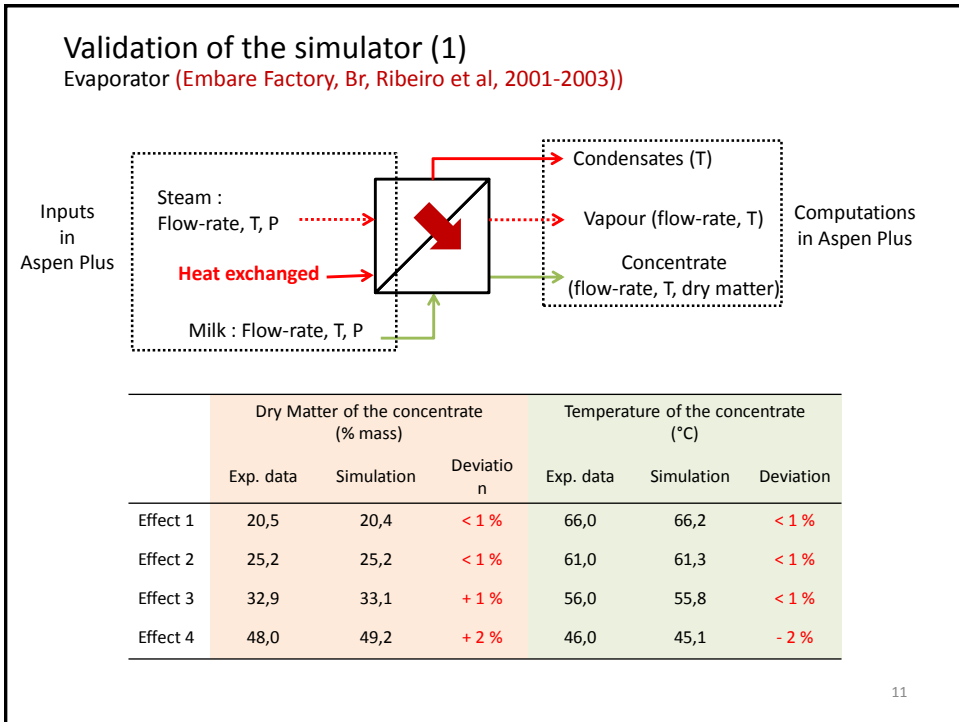

Building-up of the framework

for the eco-design of an evaporator using the multi-objective optimization approach

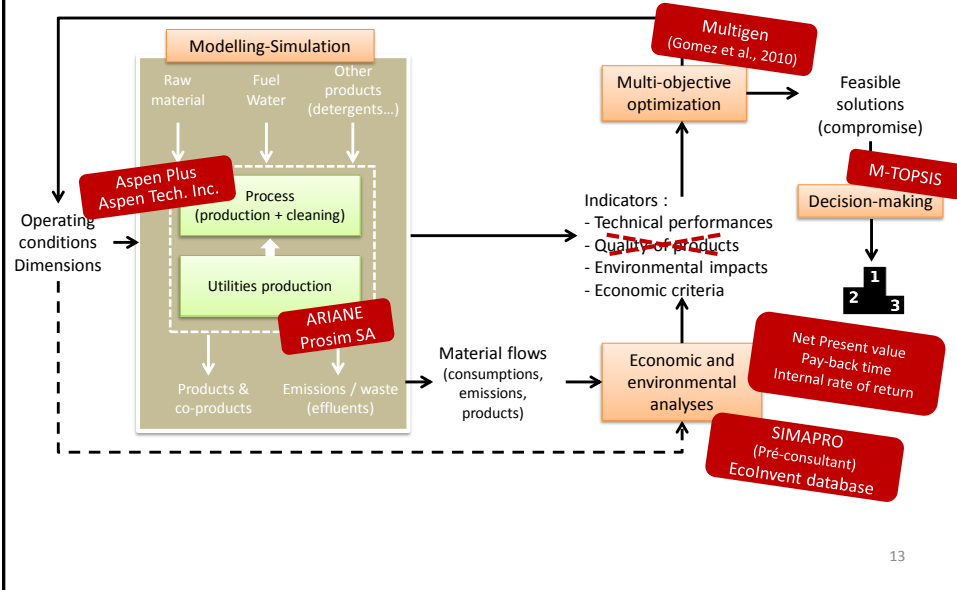

13

Applications of the framework

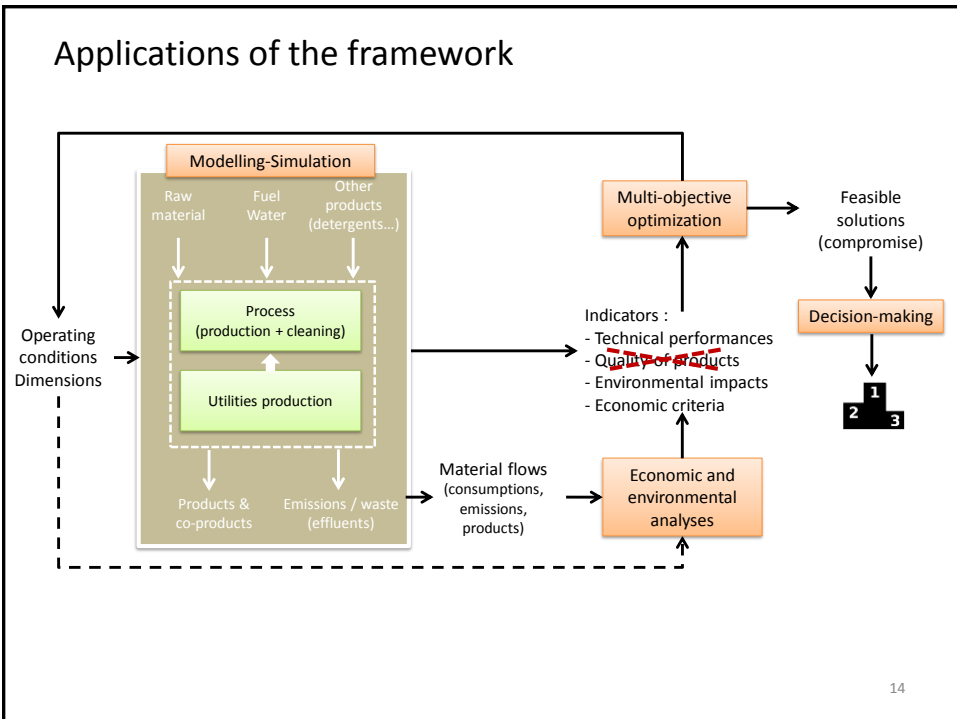

14

Applications of the framework: 1st example

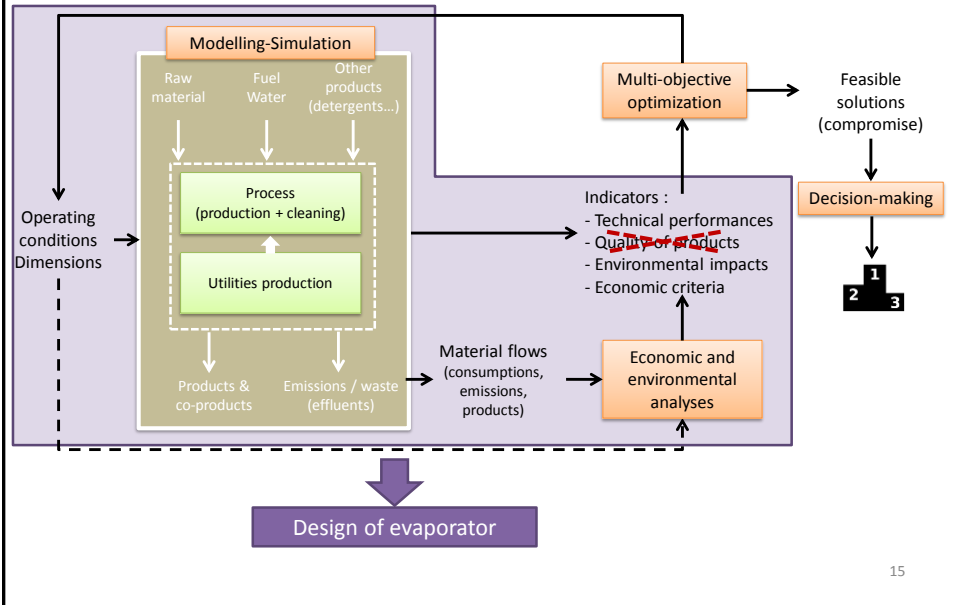

1st example : design of evaporator / number of effects

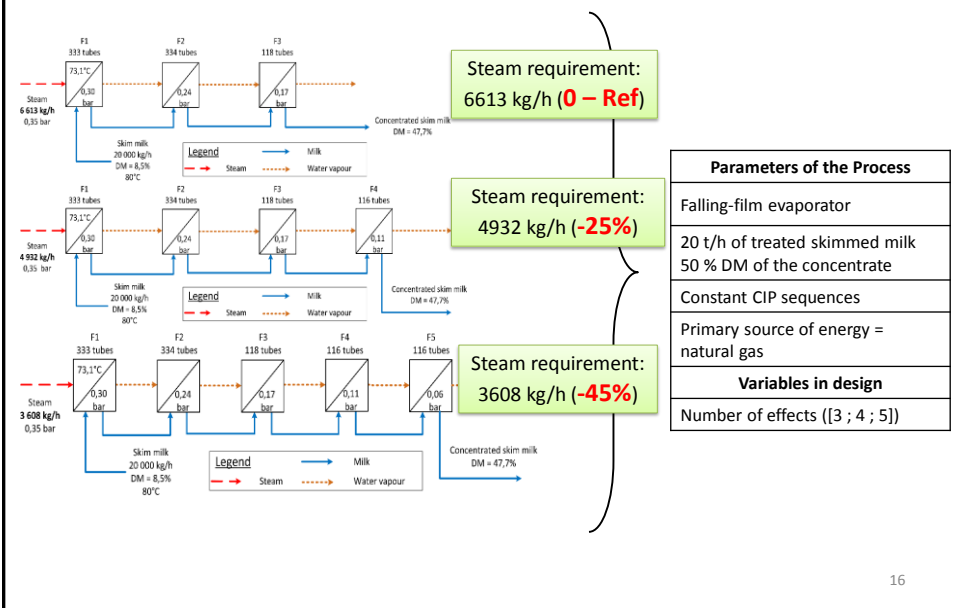

1st example : design of evaporator / number of effects

Comparison of indicators

Number of effects	Energy consumption (kg/h)	Net Present Value (M€)	Pay-back time (years)	Internal Rate of Return	Climate change Impact 2002+ (kg CO ₂ eq/ kg treated milk)	Single score Impact 2002+ (pt/kg treated milk)
3 😞	6613	1.05	11	17%	0.97	2.44
4 😊	4932	3.72	6	28%	0.74	1.87
5 😄	3608	5.78	5	35%	0.56	1.43

No conflicting objectives

17

Applications of the framework: 2nd example

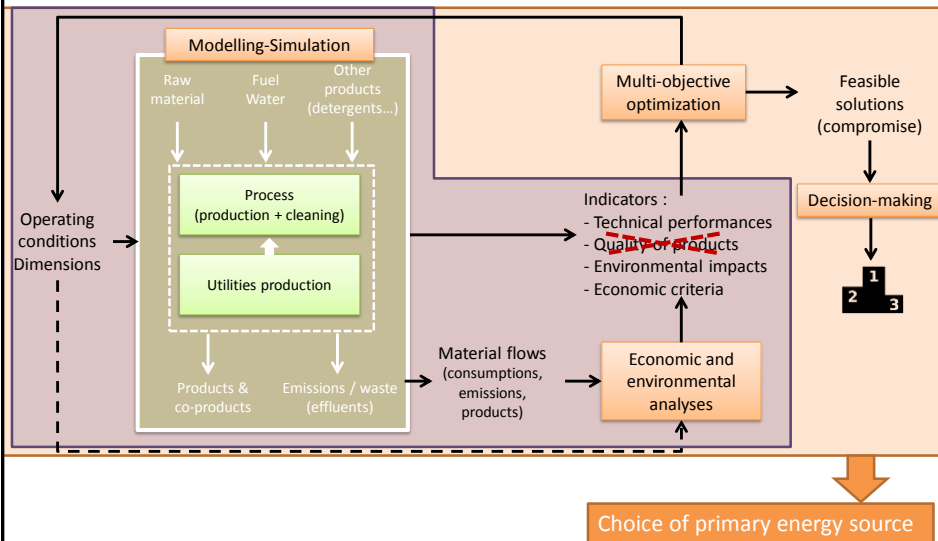

18

2nd example : choice of the primary source of energy

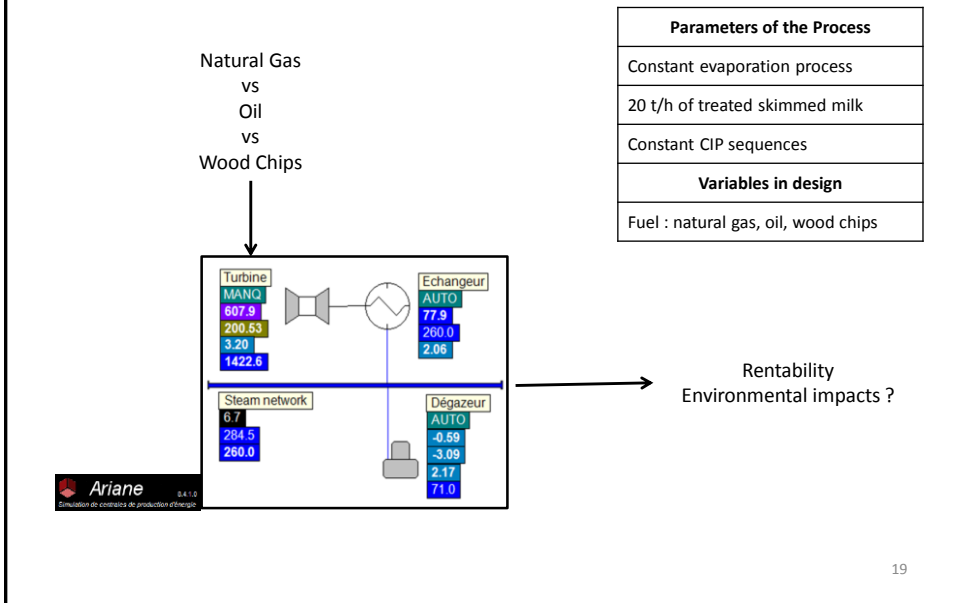

2nd example : choice of the primary source of energy

Indicateurs économiques et environnementaux

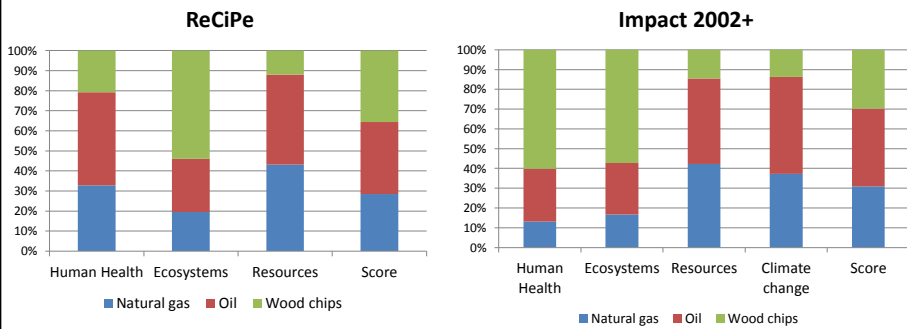

	Net Present Value (M€)	Pay-back time (years)	Internal Rate of Return
Natural Gas (reference)	8,26	3,6	47%
Oil	9,34 (+13%)	3,4 (-7%)	51% (+9%)
Wood Chips	9,54 (+16%)	4,0 (+9%)	42% (-10%)

2nd example : choice of the primary source of energy

Multicriteria analysis (M-TOPSIS)

	Combustible		
	Natural gas	Oil	Wood chips
Net Present Value, Single score ReCiPe	1	3	2
Net Present Value, Single score Impact 2002+	2	3	1
3 economic criteria, 3 Endpoint scores ReCiPe	2	3	1

21

2nd example : choice of the primary source of energy

Multicriteria analysis (M-TOPSIS)

	Combustible		
	Natural gas	Oil	Wood chips
Net Present Value, Single score ReCiPe	1	3	2
Net Present Value, Single score Impact 2002+	2	3	1
3 economic criteria, 3 Endpoint scores ReCiPe	2	3	1

22

Conclusions

Development of a framework for the eco-design of food processes

- ✓ Process simulator adapted to milk specificities
- ✓ Cleaning procedures integrated
- ✓ Environmental impacts
- ✓ Economic criteria

Demonstration of the potentialities of the framework



Still some improvements

- ✓ Heat transfer coefficient
- ✓ Cleaning modelling
- ✓ Fouling of evaporators
- ✓ Product quality
- ✓ Sensivity analysis

23

Further developments

- Addition of the drying step to the simulation

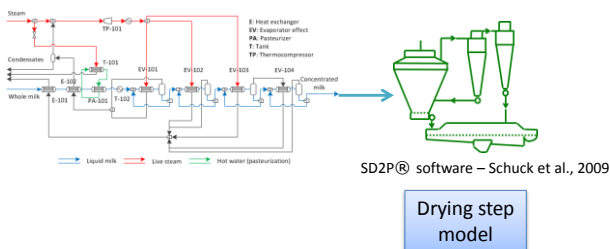

Multi-objective optimization

- Extend system boundaries:

+ Impacts of milk at the farm gate and milk transportation

24

Thank you for your attention



Martial.madoumier@supagro.fr
Catherine.AzzaroPantel@ensiacet.fr
Genevieve.Gesan-Guiziou@inra.fr, presenting author