



**HAL**  
open science

## A dual band 915MHz/2.44GHz RF energy harvester

Romain Bergès, Ludivine Fadel, Laurent Oyhenart, Valérie Vigneras, Thierry  
Taris

► **To cite this version:**

Romain Bergès, Ludivine Fadel, Laurent Oyhenart, Valérie Vigneras, Thierry Taris. A dual band 915MHz/2.44GHz RF energy harvester. 45th European Microwave Conference, Sep 2015, Paris, France. pp.307 - 310, 10.1109/EuMC.2015.7345761 . hal-01475276

**HAL Id: hal-01475276**

**<https://hal.science/hal-01475276v1>**

Submitted on 23 Feb 2017

**HAL** is a multi-disciplinary open access archive for the deposit and dissemination of scientific research documents, whether they are published or not. The documents may come from teaching and research institutions in France or abroad, or from public or private research centers.

L'archive ouverte pluridisciplinaire **HAL**, est destinée au dépôt et à la diffusion de documents scientifiques de niveau recherche, publiés ou non, émanant des établissements d'enseignement et de recherche français ou étrangers, des laboratoires publics ou privés.

# A dual Band 915MHz/2.44GHz RF Energy Harvester

Romain Bergès, Ludivine Fadel, Laurent Oyhenart, Valérie Vigneras and Thierry Taris

IMS Laboratory, University of Bordeaux  
33405 Talence Cedex, FRANCE  
ludivine.fadel@ims-bordeaux.fr

**Abstract**— This paper presents the development of a dual-band rectenna optimized to convert far-field RF energy to DC voltage at very low received power. Implemented on a standard FR4 substrate with commercially off-the-shelf (COTS) devices, the RF harvester provides a rectified voltage of 1V for a combined power of -19.5dBm at 915MHz and -25dBm at 2.44GHz. The remote powering of a clock is demonstrated, and the rectenna yields a power efficiency of 27%.

**Keywords** – Energy harvesting, dual-band rectenna, Wireless Power Transmission.

## I. INTRODUCTION

Today's the society is evolving toward creating smart environments where a multitude of sensors and devices are interacting to deliver an abundance of useful information. Essential to the implementation of this Internet Of Things (IoT) is the design of energy efficient solutions. Within this context, the RF energy harvesting appears as an alternative to provide systems with self-sustained operation.

Research efforts focus on the development of Wireless Power Transfer (WPT) systems according two scenarios: the RF energy scavenging [1] and the RF energy transfer [2]. In the first case the energy collected from the local communication traffic is weak and unpredictable. RF energy transfer, assumes an identified source that is dedicated to perform the WPT. The amount of transmitted power is controlled by the source and the collected energy is larger than in scavenging approach. Today the RF energy transfer in ISM Bands [3] is not only promising, it becomes a reality as some pioneer companies propose some full kits: Powercast Corporation, AnSem and MicroChip to name a few. However there is still a lot of work to make the RF energy transfer an appropriate, low cost and easy-to-use solution for remote powering. So far the commercial kits referenced above only explore the 900MHz ISM allocation to perform the WPT. This work proposes to demonstrate the interest of concurrent harvesting at 915MHz and 2.44GHz. The design and implementation of a modified 4-stage RF to DC converter, including a concurrent matching network, is first presented. The section III details the design of a 915MHz/2.44GHz dual-band antenna on a 1.6mm FR4 substrate. The last part of the paper presents the measurement results of the assembled RF harvesters. To conclude the demonstration of the remote powering of a clock is reported as a case of application.

## II. CONCURRENT RF TO DC CONVERTER

In RF energy harvesting the expected range of operation varies from 1 meter to 10 meters. The amount of collectable power is so very low, from -10dBm to -25dBm, and the

remote powering is difficult. For this reason the energy is first accumulated during a period of time, it is then released to the application. The power sensitivity is an important specification for the design of the RF to DC converter.

### A. Dual-band Rectifier Architecture and matching network

Since the collectable power is low in a RF harvesting scenario, the rectifier architecture is preferably based on voltage multipliers to provide an adequate output DC voltage. Focusing on the sensitivity, the RF to DC converter is designed to maximize the rectified voltage at a fixed input power. This optimization is investigated in [4]. The architecture of the RF to DC converter, reported in Fig.1, is based on a 4-stage voltage multiplier implemented with schottky diodes (Avago-HSMS285). The input matching network includes a L-section and a distributed network of micro-strip lines. The circuit of Fig. 1 was first fabricated on a printed circuit board (PCB) -1,6mm FR4 -.

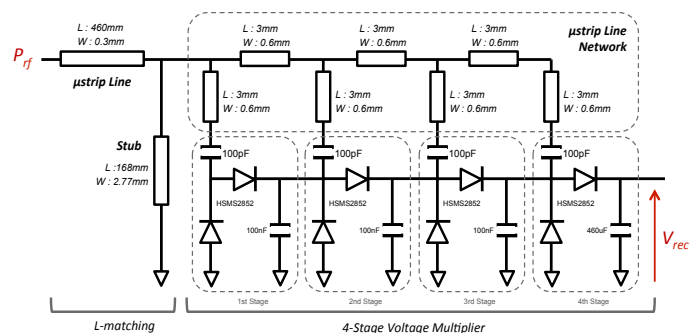

Fig. 1. Architecture of the RF to DC converter

An equivalent impedance model of the RF to DC converter of Fig. 1 is proposed in Fig. 2(a) at 915MHz and Fig. 2(b) at 2440MHz. The voltage multiplier, including the rectification stages and the micro-strip line network, is modeled with a shunt capacitor (5pF) and a shunt resistor of 270Ω at 915MHz (Fig.2a). The stub is equivalent to an inductor, which compensates the shunt capacitor. The input microstrip line is a quarter wave impedance transformer, it converts the 270Ω into 50Ω. At 2.44GHz the micro-strip line network distributing the RF signal to the voltage doublers, becomes inductive (Fig. 2b). The stub is equivalent to a shunt capacitor of 120fF, its effect is negligible. The impedance transformation is actually performed by the input micro-strip line, which is modeled with a shunt capacitor (0,6pF) and a series inductor of 5.6nH. The input return,  $S_{11}$ , of the RF to DC harvester is reported in Fig. 5. It is measured with a HP8720 network analyzer for an input power of -20dBm. It exhibits a minimum of -13dB at 915MHz and -20dB at 2.44GHz.

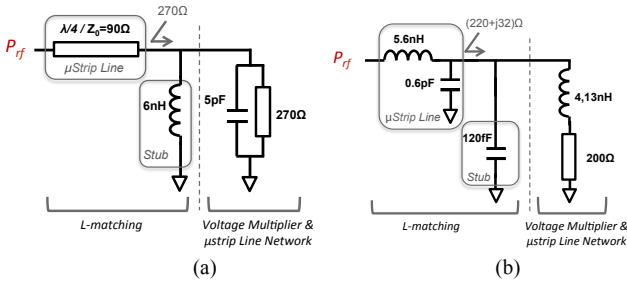

Fig. 2. Equivalent model of the RF to DC converter, 915MHz(a)-2.44GHz(b)

### B. Dual band characterization

The power efficiency and the power sensitivity are two conversion characteristics of importance in RF harvesters. Each is related to a different mode of operation. The power efficiency rates the output DC power delivered to a load  $R_{load}$ , to the available input power  $P_{rf}$ . The measurement results at 915MHz and 2.44GHz are reported respectively in Fig. 3(a) and Fig. 3(b). The power efficiency increases with  $P_{rf}$  and reaches an optimum for a fixed load. To prevent diode degradation the input power is limited to -5dBm. At 915MHz, Fig. 3(a), the power efficiency peaks at 47% for  $R_{load}=70k\Omega$ . At 2.44GHz, Fig. 3(b), a maximum of 33% is achieved for  $R_{load}=25k\Omega$ . The lower efficiency at 2.44GHz comes from the increase of losses in diodes.

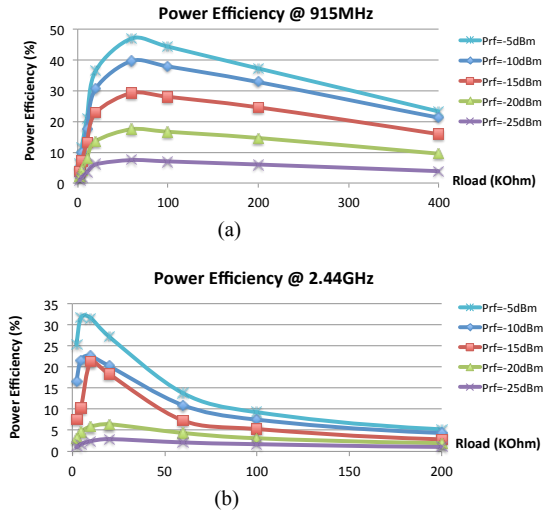

Fig. 3. Power efficiency versus the load resistance  $R_{load}$  for various power  $P_{rf}$  at 915MHz (a) and 2.44GHz (b)

It is interesting to note that the power efficiency significantly drops, and becomes less sensitive to  $R_{load}$ , for an input power below -15dBm. The RF harvester operating at low power level accumulates the energy in a storage element, to further release it to the application. In such accumulation mode the power sensitivity becomes more important than the power efficiency. The power sensitivity is represented by the rectified voltage ( $V_{REC}$ ), when the RF to DC converter is unloaded. The measurement results of  $V_{REC}$  are reported in Fig. 4. The grey columns represent the single tone mode, at 915MHz and at 2.44GHz respectively. The white column gives  $V_{REC}$  with a dual-band 915MHz/2.44GHz source. The target is a rectified voltage of 1V. In a single tone mode, the required  $P_{rf}$  is close to

-18dBm at 915MHz, and would be larger than -15dBm at 2.44GHz according Fig. 4. In a dual-band mode the circuit only needs a power  $P_{rf}$  of -20dBm at each frequency. The dual-band rectification significantly improves the power sensitivity. The reverse breakdown voltage of the HSMS285 schottky diode limits the input power to -9dBm,  $V_{REC} = 4,5V$ , in this mode.

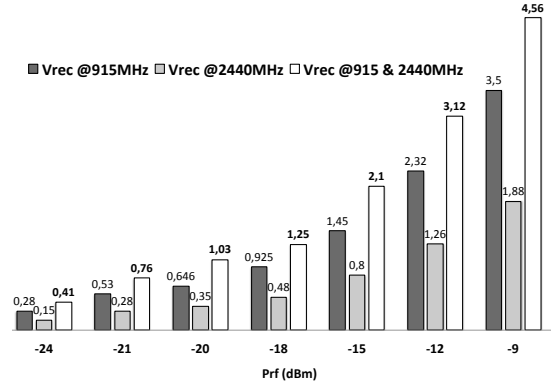

Fig. 4. Unloaded rectified voltage for various input power

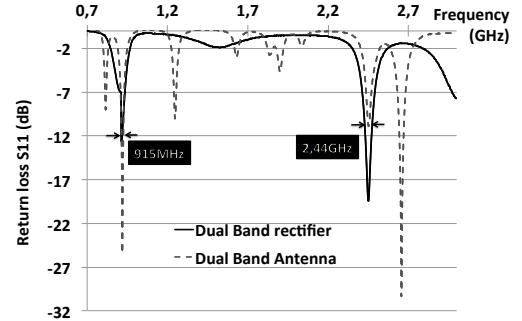

Fig. 5. Measured return loss  $S_{11}$  of the dual-band antenna and 4-stages rectifier

### III. DUAL BAND ANTENNA

A rectangular micro-strip patch antenna (RMPA) has been chosen to suit with both low cost technology of implementation and co-integration with the rectifier. Based on the cavity-model approximation, we can write the resonant frequencies of the RMPA for the  $TM_{mn}$  mode as (1):

$$f_{mn} = \frac{c}{2\sqrt{\epsilon_r}} \sqrt{\left(\frac{m}{L}\right)^2 + \left(\frac{n}{W}\right)^2} \quad (1)$$

Where  $c$  is the speed of light and  $W$ ,  $L$  are the patch dimensions.

Only  $TM_{m0}$  and  $TM_{0n}$  modes are potentially useful, other modes exist but result in exotic radiation patterns. If we use the fundamental modes  $TM_{01}$  and  $TM_{10}$  for the considered frequencies, we have a large aspect ratio,  $W/L=2.7$ , which reduce the performance of the RMPA. The choice of  $TM_{01}$  and  $TM_{30}$  modes keeps an aspect ratio close to 1 and interesting radiation patterns for our application. The RMPA is fed by a probe whose position  $(x,y)$  adjusts the matching both at 915MHz and 2.44GHz. The geometric parameters of RMPA have been optimized with an approximate model, the TL model [5], and with a full wave method (Fig. 6).

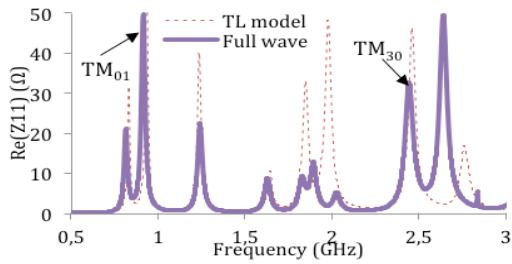

Fig. 6. Input impedance calculation to the following geometric parameters of the RMPA:  $W=78\text{mm}$ ,  $L=88\text{mm}$ ,  $x=16\text{mm}$ ,  $y=26\text{mm}$

The TL model predicts the input impedance for  $\text{TM}_{01}$  mode with a good accuracy, but it exhibits a discrepancy with the full-wave method for  $\text{TM}_{30}$  mode. In a first approximation, the feed position is determined from the TL model, the geometry is fine tuned with the full-wave approach.

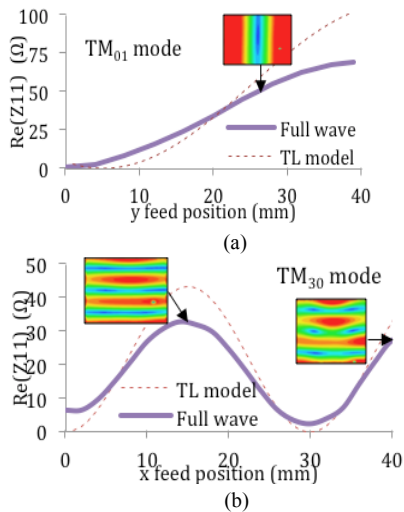

Fig. 7. Input impedance versus feed position for  $\text{TM}_{01}$  mode a)  $\text{TM}_{30}$  mode b)

To verify the accuracy of the process, the input impedance versus feed position for each mode is plotted on Fig. 7. For the  $\text{TM}_{01}$  mode, the input impedance increases with the  $y$ -position and is independent of the  $x$ -position. The input impedance is  $50\ \Omega$  for  $y = 26\text{mm}$ . The  $\text{TM}_{30}$  mode has both maximum at  $x=16\text{mm}$  and  $x = 43\text{mm}$ . The return loss of the fabricated antenna is represented in Fig. 5. It is lower than  $-10\text{dB}$  and centered with the minimum of  $S_{11}$  of the RF to DC converter. For our application  $\text{TM}_{01}$  and  $\text{TM}_{30}$  have been used for their good radiation patterns (figure 8) and also to keep an aspect ratio close to one. The radiation pattern is omnidirectional above the patch antenna for the fundamental mode and more directive for the second operating frequency, which compensates the return loss. This two operating bands of the proposed antenna are on cross polarization planes.

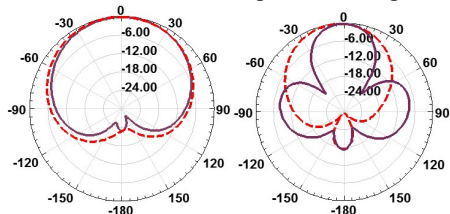

Fig. 8. Radiation patterns of the dual-band antenna (normalized-dB). Solide and dashed lines correspond to E-plane and H-plane respectively

## IV. WIRELESS POWER TRANSMISSION

This part presents the measurement results of the assembled dual-band RF harvester of Fig. 9. The RF to DC converter board, including the matching network and the rectifier, is reported on the backside, Fig. 9(b). It is connected to the radiation part, on the front side, Fig. 9(c), through a via as illustrated in Fig. 9(a).

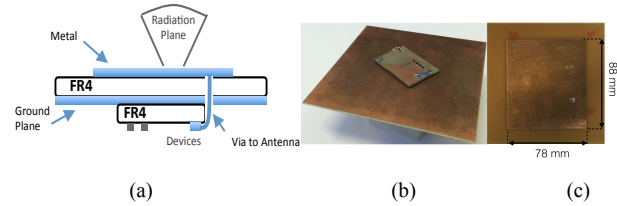

Fig. 9. Dual-band rectenna : Schematic (a) Rectenna back side (b) and front side (c)

### A. Remote Powering and Power Efficiency

The rectenna is connected to a clock which mimics a low power application. The remote powering of this clock is performed in a furnished room of the lab according to the schematic of Fig. 10. The  $I(V)$  characteristic of the clock is represented in Table I.

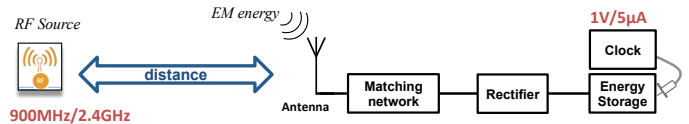

Fig. 10. Schematic of the scene of remote powering of a clock

TABLE I:  $I(V)$  characteristic of the clock

$V_{\text{clock}} \text{ (V)}$	0.9	1	1.2	1.4	1.6	1.8	2
$I_{\text{clock}} \text{ (}\mu\text{A)}$	2	2.5	3.1	3.9	4.5	5.4	6.4

The clock is turned on at 1, 2 and 3 meters for different scenarios of transmitted power. The power efficiency of the rectenna, presented in Fig. 11, is worked out from these experiments. A maximum of 27% is achieved for a combined power of  $-16.5\text{dBm}$  at  $915\text{MHz}$  and  $-16\text{dBm}$  at  $2.44\text{GHz}$  at the antenna. For these conditions of operation, the rectified voltage is  $2.1\text{V}$  and the current consumption is  $8.9\mu\text{A}$ .

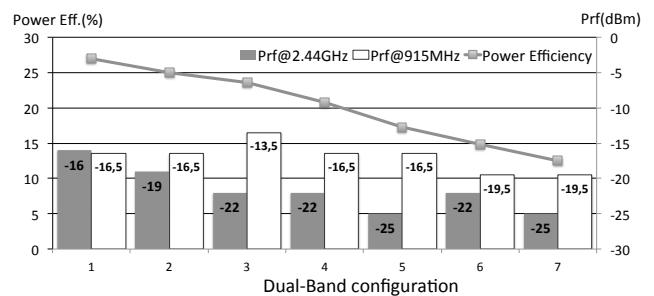

Fig. 11. Power sensitivity of the dual band rectenna

### B. Power Sensitivity

The power sensitivity is measured with the same scenario of Fig. 10 but the clock is disconnected. The resulting rectified

voltage,  $V_{REC}$ , is reported in Fig. 12 for various combinations of collectable power at the antenna in a dual-band mode transmission. To provide a rectified voltage of 1V, a power of only -19.5dBm at 915MHz and -25dBm at 2.44GHz is needed, according the configuration 8 in Fig. 12. With less than -16dBm (25 $\mu$ W) power in each tone, configuration 4 in Fig. 12,  $V_{REC}$  reaches 2.25V. Actually the gain of the antenna improves the overall sensitivity of the assembled rectenna compared to the characterization of the RF to DC converter (Fig. 4).

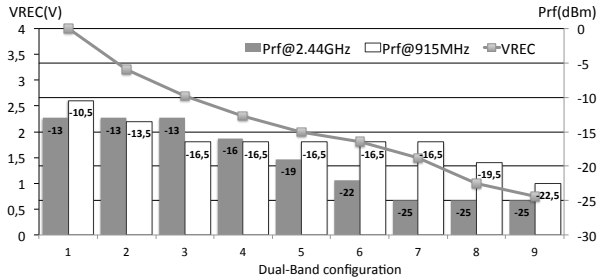

Fig. 12. Power Sensitivity of the dual-band rectenna

The performances of others works are reported in Table 1. Clearly the increase of the number of stages improves the sensitivity but degrades the efficiency. The design of RF harvesters always deals with this trade-off. The dual band rectenna proposed in this work exhibits the second best power efficiency with 27% at -16dBm. The best result is 28%, with a rectified voltage of 0.5V, at -20dBm in [8]. The best sensitivity is obtained in [10] with a 17-stage CMOS based rectifier. This circuit only needs a power of -22dBm to provide 1V. The dual band rectenna is close with the same rectified voltage (1V) for a combined power of -19,5dBm at 915MHz and -25dBm at 2440MHz. The harvesters of references [9-11], developed in CMOS technologies, achieve a good sensitivity but the power efficiencies do not exceed 20% because of the multi-stage topology. The 4-stage dual band RF harvester proposed in this paper, finally exhibits the best trade-off between sensitivity and efficiency.

## V. CONCLUSION

This work presents the implementation of a 915MHz/2.44GHz dual band RF harvester with Schottky diodes (Avago-HSMS285). The design of a concurrent matching network together with a 4-stage rectifier, is optimized to be assembled with a dual-band rectangular micro-strip patch antenna on a 1.6mm FR4 printed circuit board. The remote powering of a clock is demonstrated, and the rectenna yields an overall power efficiency of 27% at -16dBm. The concurrent energy harvesting significantly improves the sensitivity of the rectenna. A rectified voltage of 1V is produced for a combined input power of -19.5dBm at 915MHz and -25dBm at 2.44GHz. This RF harvester exhibits among the best trade-off between power sensitivity and efficiency in the -15dBm to -25dBm power range.

## REFERENCES

- [1] H. Nishimoto, Y. Kawahara, and T. Asami, "Prototype implementation of ambient RF energy harvesting wireless sensor networks," *IEEE Sens. J.*, pp. 1282-1287, Nov. 2010.
- [2] N. Shinohara, "Power without wires," *IEEE Microwaves. Mag.*, vol. 12, no. 7, pp. S64-S73, Dec. 2011.
- [3] C. Valenta, G. Durgin, "Harvesting Wireless Power", *IEEE Microwaves*, pp. 114-120, June 2014.
- [4] T. Taris et al., "COTS-Based Modules for Far-Field Radio Frequency", *IEEE NEWCAS*, Paris, France, June 2013, pp. 1-4.
- [5] H. J. Visser, "Approximate Antenna Analysis for CAD", Wiley, 2009.
- [6] D. Masotti, et al., "Genetic-based design of a tetra-band high-efficiency radio-frequency energy harvesting system," *IET Microwaves, Antennas Propagation*, vol.7, no. 15, pp. 1254-1263, June 2013.
- [7] G. Vera, A. Georgiadis, A. Collado, and S. Via, "Design of a 2.45GHz rectenna for electromagnetic (EM) energy scavenging," in *Proc. IEEE Radio and Wireless Symp.*, 2010, pp. 61-64.
- [8] U. Olgun, C. Chen, and J. Volakis, "Investigation of rectenna array configurations for enhanced RF power harvesting", *IEEE Antennas Wireless Propagation. Letter*, vol. 10, pp. 262-265, Apr. 2011.
- [9] L. Bo, S. et.al "An antenna co-design dual band RF Energy Harvester", *Circuits and Systems I, IEEE Transactions on*, vol 60, no. 12, pp3256-3266, Dec. 2013.
- [10] G. Papotto, F. Carrara, and G. Palmisano, "A 90-nm CMOS threshold-compensated RF energy harvester," *IEEE Trans. Solid-State Electron*, vol. 46, no. 9, pp. 1985-1997, Sept. 2011.
- [11] S. Scorcioni, et al., "An integrated RF energy harvester for UHF wireless powering applications," *IEEE Wireless Power Transfer*, 92-95, May 2013.

TABLE II: Comparison with the state of the art

Ref	[6]	[6]	[7]	[8]	[9]*	[9]*	[10]*	[11]	This Work
Frequency (MHz)	900	2400	2450	2450	900	1900	915	900	915/2440
Efficiency %@Prf	15%@ -10dBm	9%@ -13dBm	10.5%@ -20dBm	28%@ -20dBm	9%@ -19.3dBm	9%@ -19dBm	11%@ -15dBm	20%@ -14dBm	27%@ -16dBm
Sensitivity $V_{REC}$ @Prf	750mV @-17.5dBm	90mV @-25dBm	75mV @-20dBm	<500mV @-20dBm	1.1V @-19.3dBm	1.1V @-19dBm	1V @-22dBm	2V @-16dBm	1V@ -19.5dBm/915M -25dBm/2440M
Number of stages	1	1	1	2	4	5	17	2	4
Technology	SMS7630	SMS7630	SMS7630	HSMS285	130nm CMOS	130nm CMOS	90nm CMOS	130nm CMOS	HSMS285
Size $cm^2$	15×15	15×15	3.4×3.4	2.5×1.8	NA	NA	NA	3×15	7.8×8.8

\*Rectifier only