



HAL
open science

Impact analysis of the CAP reform on main agricultural commodities. Report I AGMEMOD – Summary report

Lubica Bartova, Robert M'Barek, Hans van Meijl, Myrna van Leeuwen, Andrzej Tabeau, Petra Salamon, Oliver von Ledebur, Frederic Chantreuil, Fabrice Levert, Trevor Donnellan, et al.

► **To cite this version:**

Lubica Bartova, Robert M'Barek, Hans van Meijl, Myrna van Leeuwen, Andrzej Tabeau, et al.. Impact analysis of the CAP reform on main agricultural commodities. Report I AGMEMOD – Summary report. [Contract] EUR 22940 EN/1, European Commission. 2008, 74 p. hal-01462422

HAL Id: hal-01462422

<https://hal.science/hal-01462422>

Submitted on 6 Jun 2020

HAL is a multi-disciplinary open access archive for the deposit and dissemination of scientific research documents, whether they are published or not. The documents may come from teaching and research institutions in France or abroad, or from public or private research centers.

L'archive ouverte pluridisciplinaire **HAL**, est destinée au dépôt et à la diffusion de documents scientifiques de niveau recherche, publiés ou non, émanant des établissements d'enseignement et de recherche français ou étrangers, des laboratoires publics ou privés.



Impact Analysis of CAP Reform on the Main Agricultural Commodities

Report I
AGMEMOD – Summary Report

Authors: AGMEMOD Partnership
Editors: Lubica Bartova and Robert M'barek



EUR 22940 EN/1 - 2008

The mission of the IPTS is to provide customer-driven support to the EU policy-making process by researching science-based responses to policy challenges that have both a socio-economic and a scientific or technological dimension.

Impact Analysis of CAP Reform on the Main Agricultural Commodities

Report I

AGMEMOD - Summary Report

Authors:

AGMEMOD Partnership

Editors:

Lubica Bartova, Robert M'barek

2008

The mission of the IPTS is to provide customer-driven support to the EU policy-making process by researching science-based responses to policy challenges that have both a socio-economic and a scientific or technological dimension.

European Commission

Joint Research Centre
Institute for Prospective Technological Studies

Contact information

Address: Edificio Expo. c/ Inca Garcilaso, s/n. E-41092
Seville (Spain)

E-mail: jrc-ipts-secretariat@ec.europa.eu

Tel.: +34 954488318

Fax: +34 954488300

<http://ipts.jrc.ec.europa.eu>

<http://www.jrc.ec.europa.eu>

Legal Notice

Neither the European Commission nor any person acting on behalf of the Commission is responsible for the use which might be made of this publication.

A great deal of additional information on the European Union is available on the Internet.

*It can be accessed through the Europa server
<http://europa.eu/>*

JRC38071

EUR 22940 EN/1

ISBN 978-92-79-07623-7

ISSN 1018-5593

DOI 10.2791/59386

Luxembourg: Office for Official Publications of the
European Communities

© European Communities, 2008

*Reproduction is authorised provided the source is
acknowledged*

Printed in Spain

■ AGMEMOD Partnership:

- *Agricultural Economics Research Institute (LEI), The Hague, The Netherlands:* Hans van Meijl, Myrna van Leeuwen, Andrzej Tabeau
- *Bundesforschungsanstalt für Landwirtschaft (FAL), Braunschweig, Germany:* Petra Salamon, Oliver von Ledebur
- *Centre of Agricultural Economics, INRA-ESR, Rennes, France:* Frédéric Chantreuil, Fabrice Levert
- *Teagasc-Rural Economy Research Centre (RERC), Athenry, Co. Galway, Ireland:* Trevor Donnellan, Kevin Hanrahan
- *Latvian State Institute of Agrarian Economics (LSIAE), Riga, Latvia:* Danute Jasjko, Guna Salputra, Ludmilla Fadejeva
- *University of Ljubljana, Biotechnical Faculty (LJUB), Ljubljana, Slovenia:* Emil Erjavec, Stane Kavcic, Darja Regoršek
- *Universität für Bodenkultur Wien (BOKU), Wien, Austria:* Martin Kniepert
- *Université Catholique de Louvain (UCL), Louvain-La-Neuve, Belgium:* Bruno Henry de Frahan, Olivier Harmignie
- *Institute of Agriculture Economics (IEABG), Sofia, Bulgaria:* Nedka Ivanova, Mariya Peneva
- *Research Institute of Agriculture Economics (VUZE), Prague, Czech Republic:* Ivan Foltyn, Jan Kubát
- *Food and Resource Economic Institute (FØI), Frederiksberg C, Denmark:* Jorgen Dejgaard Jensen
- *Institute of Economics and Social Sciences of Estonian Agricultural University (EAU), Tartu, Estonia:* Mati Sepp
- *MTT Agrifood Research Finland (MTT), Helsinki, Finland:* Jyrki Niemi, Lauri Kettunen
- *Department of Economics, University of Athens (NKUA), Athens, Greece:* Elias Mantzouneas
- *Corvinus University of Budapest (CUB), Budapest, Hungary:* Tibor Ferenczi
- *Polytechnic University of Marche-Ancona (UNIVPM), Ancona, Italy:* Roberto Esposti, Antonello Lobianco
- *Lithuanian Institute of Agrarian Economics (LAEI), Vilnius, Lithuania:* Irena Krisciukaitiene, Salomeja Andrekiene, Andrej Jedik, Willi Meyers, Aiste Galnaityte
- *Warsaw School of Economics (WSE), Warsaw, Poland:* Sylwia Krawczyńska, Katarzyna Kowalska
- *Institute of Agricultural Economics (IEARO), Bucharest, Romania:* Camelia Serbanescu, Cristian Kevorchian
- *Slovak Agricultural University (SAU), Nitra, Slovak Republic:* Lubica Bartova, Pavel Ciaian, Jan Pokrivcak
- *Unidad de Economía Agraria, Centro de Investigación y Tecnología Agroalimentaria de Aragón, (CITA), Zaragoza, Spain:* Azucena Gracia
- *Queen's University of Belfast (QUB), Belfast, UK:* Zi Ping Wu, Philip Kostov

■ Foreword

Quantitative models are important tools for analysing the impact of agricultural policies. One of the modelling approaches used to analyse the impact of the Common Agricultural Policy is AGMEMOD (AGricultural MEmber states MODelling), an econometric, dynamic, partial equilibrium, multi-country, multi-market model. AGMEMOD models provide extensive details of the agricultural sector in individual EU Member States including the new members Bulgaria and Romania, and the EU as a whole.

A study was carried out from November 2005 until June 2007 by the AGMEMOD Partnership under the management of the Agricultural Economics Research Institute (LEI, the Netherlands), in cooperation with the European Commission's Joint Research Centre - Institute for Prospective Technological Studies (JRC-IPTS). The aim was to generate projections for the main agricultural commodity markets for each year from 2005 until 2015.

Detailed documentation on the AGMEMOD modelling approach, along with the outcome of the study, is published in five reports in the JRC-IPTS Scientific and Technical Report Series (Box 1) under the heading "Impact analysis of CAP reform on the main agricultural commodities".

■ *Box 1 Impact analysis of CAP reform on the main agricultural commodities*

Report I AGMEMOD – Summary Report

This report presents the projections of agricultural commodity markets under the baseline, further CAP reform, enlargement scenarios and exchange rate change sensitivity analyses for the aggregates EU-10, EU-15, EU-25 and EU-27. It summarises the characteristics of the modelling tool used, focusing in particular on the features implemented in this study, and addresses issues that need further attention. (<http://www.jrc.es/publications>)

Report II AGMEMOD – Member States Results

This report outlines the results of the baseline projections of agricultural commodity markets, further CAP reform scenario impact analyses and exchange rate change sensitivity analyses for individual EU-27 Member States except Malta and Cyprus. For Bulgaria and Romania enlargement and non-enlargement scenarios are analysed. (<http://www.jrc.es/publications>)

Report III AGMEMOD – Model Description

This report describes the modelling techniques used by the AGMEMOD Partnership, with the emphasis on new commodities modelled and policy modelling approaches. (<http://www.jrc.es/publications>)

Report IV AGMEMOD – GSE Interface Manual

The Manual gives an overview of the GAMS Simulation Environment (GSE) interface and its application with the AGMEMOD model. (<http://www.jrc.es/publications>)

Report V Commodity Modelling in an Enlarged Europe – November 2006 Workshop Proceedings

These proceedings consist of presentations and conclusions of a workshop held in November 2006. The presentation of outcomes of the other models such as FAPRI, ESIM, AGLINK and CAPSIM are included in addition to the AGMEMOD approach. (<http://www.jrc.es/publications>)

We acknowledge the work undertaken by country teams of the AGMEMOD Partnership and by Myrna van Leeuwen, LEI, the Netherlands, the project co-ordinator.

■ Executive Summary

This report presents the main outcome of the study “Impact Analysis of CAP Reform on the Main Agricultural Commodities” providing projections for each year from 2005 until 2015 for individual Member States, for the aggregates EU-10, EU-15, EU-25 and EU-27. The study was carried out by the AGMEMOD Partnership under the management of the Agricultural Economics Research Institute (LEI, the Netherlands), in cooperation with the European Commission’s Joint Research Centre - Institute for Prospective Technological Studies (JRC-IPTS).

AGMEMOD is an econometric, dynamic, partial equilibrium, multi-country, multi-market model. The AGMEMOD models provide extensive details of the agricultural sector in individual EU Member States and the EU as a whole.

The objectives of the study were threefold:

- i) To provide market projections for the main European agricultural commodities based on the latest agricultural and trade policy developments and information available;
- ii) To assess the impacts of selected scenarios on the main European agricultural commodity markets. In particular, these scenarios concern the introduction of decoupling and new direct payment schemes as well as the enlargement of the EU in 2007;
- iii) To apply and improve an agricultural sector model for the enlarged EU, implemented in standard computer software (GAMS and MS Excel), and to make a preliminary version operational and available for the European Commission.

Projections and simulations have been generated for individual EU Member States and the EU at different aggregation levels (EU-10, EU-15, EU-25, EU-27), providing results on supply, demand, trade and prices for the main agricultural commodities (cereals, oilseeds, livestock products and dairy products).

Impact of the following **scenarios** was analysed:

- The Baseline scenario for the EU-15 and Slovenia reflects the 2003 CAP reform, which covers the additional milk quotas, a cut in intervention prices and national implementation of the Single Farm Payment Scheme. For the EU-10 implementation of the Single Area Payment Scheme until 2008 followed by introduction of the Single Farm Payment Scheme from 2009 onwards are assumed. Complementary national direct payments remain in force in the EU-10 until 2013;
- The Further CAP Reform scenario, in which all direct payments are decoupled and the rates of compulsory modulation are doubled to 10%, both from 2007 onwards;
- The Enlargement scenario, which examines the consequences of accession to the EU of Bulgaria and Romania.

The AGMEMOD **modelling system** applied in this study has been econometrically estimated at individual Member State level. The country models contain the behavioural responses of economic agents to changes in prices, policy instruments and other exogenous variables of agricultural markets. Commodity prices adjust so as to clear all markets considered. For each commodity modelled in each country and each aggregate, the system generates the main domestic market variables such as production, food and feed demand, prices, trade and stocks. Agricultural income is calculated at sector level. As all policy-relevant

agricultural markets are covered, the econometrically modelled country-specific agricultural markets also provide a sound basis for an analysis of the impacts of policy changes.

To ensure that the projections of the modelling system are consistent from an economic and policy perspective, projections have been validated by standard econometric methods and through consultation with national experts. In addition, the study analysed the impact of three alternative paths of US dollar versus euro exchange rate changes in a form of a sensitivity analysis. The obtained projections largely accord with the *a priori* expectations. A decline (increase) in the value of the €/US dollar exchange rate compared with the baseline assumptions leads to higher (lower) internal EU market prices and consequent adjustments to production, domestic use, imports and exports.

Although results differ across countries and the aggregates (EU-15, EU-10), the **key findings of this study** regarding the aggregated EU-25 **baseline projection analyses** are as follows:

- Despite the decoupling measures of the 2003 CAP reform (also referred to as the Luxembourg Agreement), the EU production in several sectors (wheat, maize) will grow over the period 2005-2015.
- Higher dynamics can be found in the oilseed sector with demand propelling the markets.
- The decoupled payments will induce a further decline in beef and lamb production.
- Pig meat and poultry production are largely unaffected by decoupling.
- The EU dairy production is expected to decline as a consequence of the reductions in intervention prices for dairy products, but milk quotas will be fulfilled.
- Butter and skimmed milk powder production will decrease and at the same time growth in the production of cheese is projected.

The **key findings** of this study regarding the **scenario projection analyses** are as follows:

- The *Further CAP Reform scenario* projections tie in with *a priori* expectations, in that the impact of policy measures assumed in this scenario is very limited due to the fact that many Member States had already chosen to largely decouple direct payments under their implementation of the Luxembourg Agreement at national level.
- The *2007 Enlargement of the EU* with the accession of Romania and Bulgaria is not expected to dramatically change the situation of most key EU agricultural markets. There are increases projected for the production of EU sunflower oil, soft wheat and maize, but accession is projected to have less of an impact on livestock and meat markets.

Although the agricultural markets of the individual countries have differing levels of development and the country models are being further developed, the projections provide useful information about general trends on the EU's main agricultural markets.

■ Table of contents

Foreword	5
Executive Summary	7
Acronyms	13
1. Introduction	15
2. Model description / methodological approach	17
3. Baseline and Scenario Results	21
3.1. Descriptions of scenarios and assumptions	21
3.2. Baseline	21
3.2.1. <i>Agricultural policy</i>	21
3.2.2. <i>Trade policy</i>	22
3.2.3. <i>Macro-economy</i>	22
3.2.4. <i>World market prices</i>	23
3.3. Scenarios	24
3.3.1. <i>Further CAP Reform scenario</i>	25
3.3.2. <i>EU Enlargement scenario</i>	25
3.3.3. <i>Exchange Rate Change scenario (sensitivity analysis)</i>	27
4. EU-25 baseline and scenarios projections	29
4.1. Crops	29
4.1.1. <i>EU-25 - grains and oilseeds</i>	29
4.1.2. <i>EU-15 and EU-10 - grains and oilseeds</i>	32
4.2. Livestock and dairy products	34
4.2.1. <i>EU-25 - livestock products</i>	34
4.2.2. <i>EU-25 - dairy products</i>	37
4.2.3. <i>EU-15 and EU-10 - livestock products</i>	37
4.2.4. <i>EU-15 and EU-10 - dairy products</i>	40
4.3. Agricultural income	42
4.3.1. <i>EU-25 – gross income</i>	42
4.3.2. <i>EU-15 and EU-10 – gross income</i>	43

5. EU-27 baseline and scenarios projections	45
5.1. Crops	45
5.1.1. Bulgaria and Romania – grains and oilseeds	45
5.1.2. EU-27 – grains and oilseeds	46
5.2. Livestock and dairy products	47
5.2.1. Bulgaria and Romania – livestock products and milk	47
5.2.2. EU-27 – livestock products and milk	49
5.3. Agricultural income	50
5.3.1. Bulgaria and Romania – gross income	50
5.3.2. EU-27 – gross income	51
6. Discussion and Conclusions	53
8. References	55
9. Appendix 1 Baseline projections and scenario impacts in EU-15 and EU-10	57

List of Tables		
Table 3.1	Crop-related policy instruments used in AGMEMOD	23
Table 3.2	Livestock and livestock product-related policy instruments used in AGMEMOD	23
Table 3.3	Summary of scenarios to be analysed	26
Table 4.1	Self-sufficiency rates for grains in the EU-15, EU-10 and EU-25 under baseline	33
Table 4.2	Self-sufficiency rates for oilseeds in the EU-15, EU-10 and EU-25 under baseline	34
Table 4.3	Self-sufficiency rates for livestock products in the EU-15, EU-10 and EU-25 under baseline	40
Table 4.4	Self-sufficiency rates for dairy products in the EU-15, EU-10 and EU-25 under baseline	41
Table 4.5	EU-25 output value, subsidies, feed costs and gross income in baseline	42
Table 4.6	EU-25 output value, subsidies, feed costs and gross income in Further CAP Reform scenario (% change from baseline)	42
Table 4.7	Agricultural output value, subsidies, feeding costs and agricultural income in the EU-15, EU-10 and EU-25 under baseline (2000=1)	43
Table 5.1	Increase in EU-27 crop production (% change from EU-25 production)	46
Table 5.2	Self-sufficiency rates for crops in the EU-25 compared to the EU-27 in 2015	47
Table 5.4	Self-sufficiency rates for livestock products in the EU-25 compared to the EU-27 in 2015	49
Table 5.3	Increase in EU-27 livestock production (% change from EU-25 production)	49
Table 5.5	Agricultural output value, subsidies and agricultural income in the EU-25 and EU-27 (2007=1.0)	51

List of Figures		
Figure 2.1	File structure of EU-15 combined model	17
Figure 2.2	EU-25 hybrid model structure of AGMEMOD	18
Figure 2.3	EU-27 hybrid model structure of AGMEMOD	19
Figure 3.1	Macroeconomic projections for EU groups	24
Figure 3.2	US dollar/Euro exchange rate projection	24
Figure 3.3	World market price projections used in the baseline and scenarios	25
Figure 4.1	EU-25 soft wheat and maize projections under baseline and scenarios	30
Figure 4.2	EU-25 rapeseed and sunflower seed projections under baseline and scenarios	31
Figure 4.3	Grain production and consumption in the EU-15, EU-10 and EU-25 under baseline	32
Figure 4.4	Oilseed production and consumption in the EU-15, EU-10 and EU-25 under baseline	33
Figure 4.5	EU-25 beef and lamb meat projections under baseline and scenarios	35
Figure 4.6	EU-25 pig meat and poultry projections under baseline and scenarios	36
Figure 4.7	EU-25 butter and cheese projections under baseline and scenarios	38
Figure 4.8	EU-25 skimmed and whole milk powder projections under baseline and scenarios	39
Figure 4.9	Livestock products production and consumption in the EU-15, EU-10 and EU-25 under baseline	40
Figure 4.10	Dairy products production and consumption in the EU-15, EU-10 and EU-25 under baseline	41
Figure 4.11	EU-25 output value, subsidies, feeding costs and gross income projections under exchange rate scenario	43
Figure 4.12	Agricultural output value, subsidies, feeding costs and agricultural income in the EU-15, EU-10 and EU-25 under baseline	44
Figure 5.1	Crop production in Bulgaria and Romania under the Enlargement scenario (% change from baseline)	46
Figure 5.2	Livestock production in Bulgaria and Romania under the Enlargement scenario (% change from baseline)	49
Figure 5.3	Agricultural output, subsidies and income in Bulgaria and Romania under the Enlargement scenario (% change from baseline)	50
Figure A 1	EU-15 and EU-10 soft wheat projections under baseline and scenarios	57
Figure A 2	EU-15 and EU-10 barley projections under baseline and scenarios	58
Figure A 3	EU-15 and EU-10 maize projections under baseline and scenarios	59
Figure A 4	EU-15 and EU-10 rapeseed projections under baseline and scenarios	60
Figure A 5	EU-15 and EU-10 sunflower projections under baseline and scenarios	61
Figure A 6	EU-15 and EU-10 soybean projections under baseline and scenarios	62
Figure A 7	EU-15 and EU-10 beef and veal projections under baseline and scenarios	63

Figure A 8 EU-15 and EU-10 pig meat projections under baseline and scenarios	64
Figure A 9 EU-15 and EU-10 poultry meat projections under baseline and scenarios	65
Figure A 10 EU-15 and EU-10 sheep meat projections under baseline and scenarios	66
Figure A 11 EU-15 and EU-10 butter projections under baseline and scenarios	67
Figure A 12 EU-15 and EU-10 skimmed milk powder projections under baseline and scenarios	68
Figure A 13 EU-15 and EU-10 cheese projections under baseline and scenarios	69

Acronyms

AGMEMOD:	AGricultural MEmber states MODelling
AGMEMOD 2020:	The EU 6 th Framework Programme project
CAP:	Common Agricultural Policy
CEECs:	Central and Eastern European Countries
CNDP:	Complementary National Direct Payments (top-ups)
EU-10:	8 EU Member States of 2004 enlargement, Malta and Cyprus not included
EU-15:	15 EU Member States before 2004
EU-25:	23 EU Member States after 2004 enlargement, Malta and Cyprus not included
EU-27:	25 EU Member States after 2007 enlargement, Malta and Cyprus not included
FAPRI:	Food and Agricultural Policy Research Institute, USA
GAMS:	General Algebraic Modelling System
GDP:	Gross Domestic Product
GSE:	GAMS Simulation Environment
JRC-IPTS:	Joint Research Centre - Institute for Prospective Technological Studies (Spain)
OECD:	Organisation for Economic Co-operation and Development
PSE:	Producer Support Estimate
SAPS:	Single Area Payment Scheme
SFP:	Single Farm Payment
USD:	U.S. Dollar
WTO:	World Trade Organisation

■ 1. Introduction

In the context of the ongoing Common Agricultural Policy (CAP) reform(s) and EU accession of new Member States in 2004 and 2007 with a significant agricultural sector, quantitative analysis is crucial for policy-makers. Agricultural models are important tools for assessing the impact of policies and economic parameters on market variables and sector income.

AGMEMOD (AGricultural MEmber states MODelling) an econometric, dynamic, partial, multi-country, multi-market equilibrium model is characterised by its bottom-up approach and is one of the agricultural sector models focusing on the European Union. The AGMEMOD Partnership consists of 22 research teams, representing most of the EU Member States.

As a part of a comprehensive study the AGMEMOD modelling team in cooperation with the European Commission's JRC-IPTS has improved the model and carried out projections for the main European agricultural commodity markets for each year from 2005 until 2015 and assessed the impacts of policies selected scenarios.

The study provided projections and simulations for:

- the individual EU Member States: Austria, Belgium (including Luxembourg), the Czech Republic, Denmark, Estonia, Finland, France, Germany, Greece, Hungary, Ireland, Italy, Latvia, Lithuania, the Netherlands, Poland, Portugal, the Slovak Republic, Slovenia, Spain, Sweden, the United Kingdom;
- the recently acceded countries Bulgaria and Romania;
- the EU-15 as a whole (15 Member States before 2004 Enlargement);
- the EU-10 as a whole (8 Member States of 2004 Enlargement, Malta and Cyprus not included);
- the EU-25 as a whole (Malta and Cyprus not included);
- the EU-27 as a whole (Malta and Cyprus not included).

Projections for supply, demand, trade and prices in all countries and at all levels were provided for the following agricultural commodities:

- soft wheat, durum wheat, barley, maize, rye, other grains;
- rapeseed, sunflower seed, soybeans, vegetables oils and meals;
- milk, butter, skimmed milk powder, cheese, whole milk powder;
- beef and veal, pork, poultry, sheep and goats.

Impact of the following **scenarios** was analysed:

- The Baseline scenario for the EU-15 and Slovenia models reflects the 2003 CAP reform, which covers the additional milk quotas, a cut in intervention prices and national implementation of the Single Farm Payment Scheme. For the EU-10 implementation of the SAPS until 2008 followed by introduction of the Single Farm Payment Scheme from 2009 onwards are assumed. Complementary national direct payments remain in force in the EU-10 until 2013.
- The Further CAP Reform scenario, in which all direct payments are decoupled and the rates of compulsory modulation are doubled to 10%, both from 2007 onwards;

- The Enlargement scenario, which examines the consequences of accession to the EU of Bulgaria and Romania.

The AGMEMOD modelling system which has been improved and applied in this study captures: (i) the dynamics of a large number of agricultural commodity markets and (ii) the impact on these markets of a variety of applied policy instruments as implemented by each EU Member State.

The present summary report gives a general overview of the modelling approach, the description and implementation of the baseline, further CAP reform, enlargement scenarios and exchange rate change (ERC) sensitivity analysis. It

outlines the main results for the aggregates EU-10, EU-15, EU-25 and EU-27, focusing in particular on the features implemented in this study, and addresses issues that need further attention.

Chapter 2 of this Summary Report describes the main characteristics of the applied modelling tool, with a special focus on the features implemented in this study. Chapter 3 outlines the baseline and the scenarios. Scenario results for the EU-10, EU-15 and EU-25 are analysed in Chapter 4, while Chapter 5 presents scenario results for Bulgaria, Romania and the EU-27. Finally, Chapter 6 provides conclusions regarding the outcomes of this study and addresses a number of issues that need further attention.

■ 2. Model description / methodological approach

AGMEMOD is an econometric, dynamic, partial equilibrium, multi-country, multi-market modelling system which uses a bottom-up approach. Using a common country model template, country-level models, with country-specific characteristics, were developed to reflect the specific situation of their agricultural sectors and to be subsequently combined in a composite EU model. This approach captures the inherent heterogeneity of the different agricultural systems across the EU, while still maintaining analytical consistency across the country models via as close as possible adherence to the template. Maintaining analytical consistency across the country models is essential for aggregation and it also facilitates comparisons of the impact of a policy across different Member States. One of the aims of this study is to integrate the old Member State models into an EU-15 combined model. Figure 2.1 presents the file structure of the EU-15

combined model. It covers the old Member State models, indicated by country XX to country ZZ.

The procedure applied to solve and simulate this EU-15 model is the same as for the individual country models in GAMS. First, all common exogenous data, the specific country XX to country ZZ data and the sets are read into GAMS to create a complete EU dataset used to solve the combined EU model. Second, this EU data file is combined with the estimated old Member State country models XX through ZZ expressed in GAMS code. If the GAMS solver finds feasible solutions for all markets, in all time periods and for all countries, the results are exported to the country-level Excel files. These country-specific result files (XX-results.xls) capture the projections of agricultural activity levels (areas harvested, livestock numbers), supply and use balances (production, domestic use, imports, exports and ending stocks) and prices at country level. Also,

■ Figure 2.1 File structure of EU-15 combined model

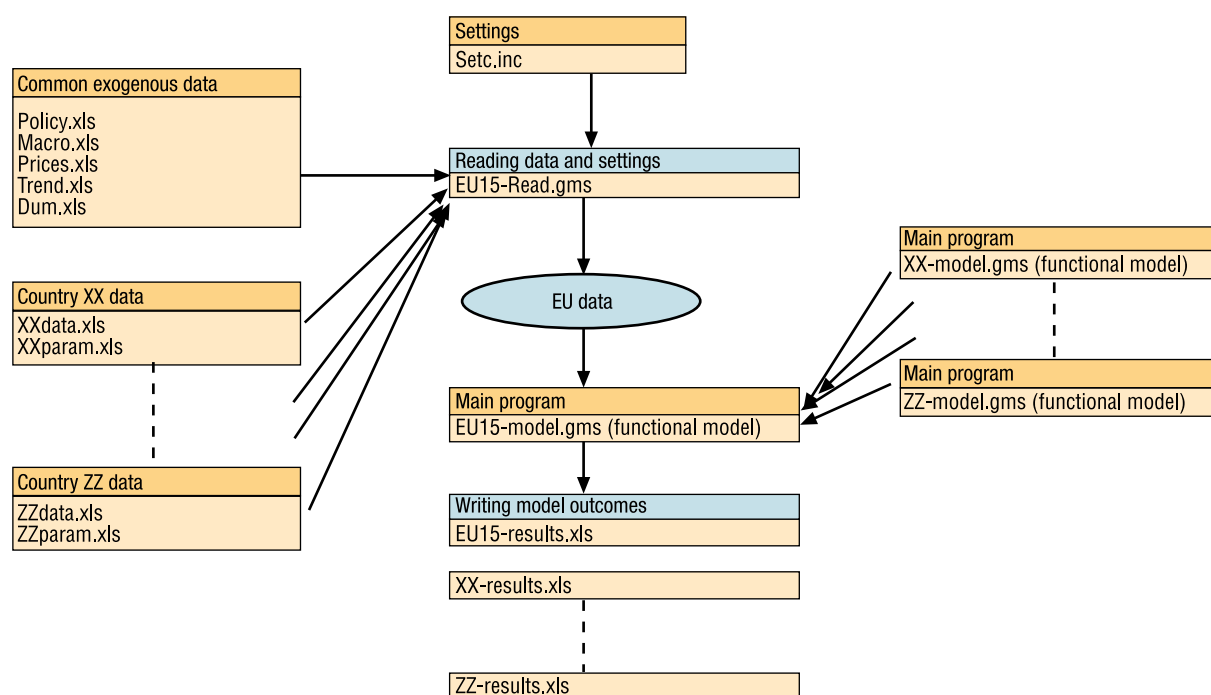
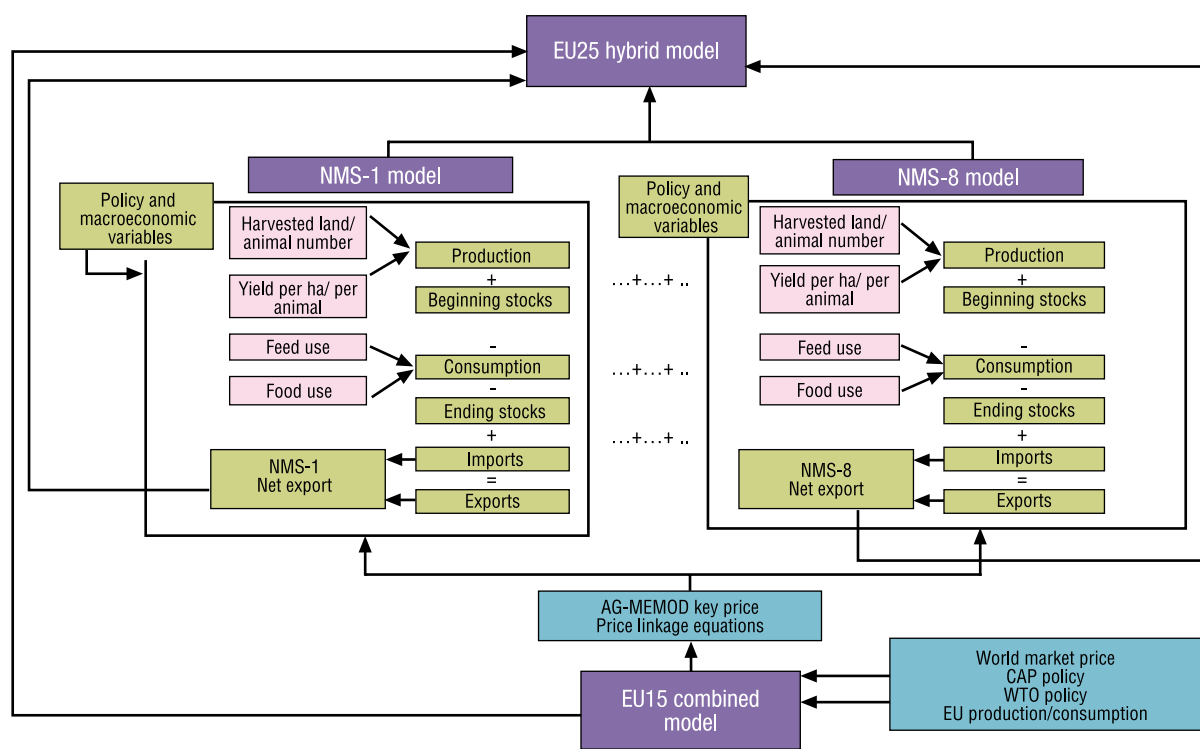

Figure 2.2 EU-25 hybrid model structure of AGMEMOD



an EU-15-specific result file (EU-results.xls) is produced with agricultural activity levels (areas harvested, livestock numbers), supply and use balances (production, domestic use, net exports and ending stocks) and market clearing prices for the EU-15.

One of the next aims of the AGMEMOD Partnership is to develop a combined model version of the EU-25. This is planned for 2008 as part of the AGMEMOD 2020 project. As this task lies beyond the scope of this study, the market projections and scenario simulations of the EU-25 have been conducted in a practical way. The EU-10 models are solved as stand-alone GAMS versions and added to the EU-15 combined model. The result is the so-called *EU-25 hybrid model*: it is a summation of the integrated EU-15 model of the old Member States (with endogenous key price formation) and the stand-alone EU-10 models (solved with exogenous key prices delivered by the EU-15 combined model).

In addition, the Bulgarian and Romanian models are solved as stand-alone versions and added to the EU-25 hybrid model. This provides the so-called *EU-27 hybrid model*.

Figure 2.2 presents the conceptual framework for generating the link between the EU-15 combined model and the EU-10 models, which generates the EU-25 hybrid model.

Figure 2.3 shows the linkage of the EU-25 hybrid model with the Bulgarian and Romanian models, which generates the EU-27 hybrid model version of AGMEMOD.

The endogenous EU key prices calculated with the EU-15 combined model are used as exogenous EU key prices to run the stand-alone models of the EU-10, Bulgaria and Romania. The results capture projections of agricultural activity levels (areas harvested, livestock numbers), supply and use balances (production, domestic use,

Figure 2.3 EU-27 hybrid model structure of AGMEMOD

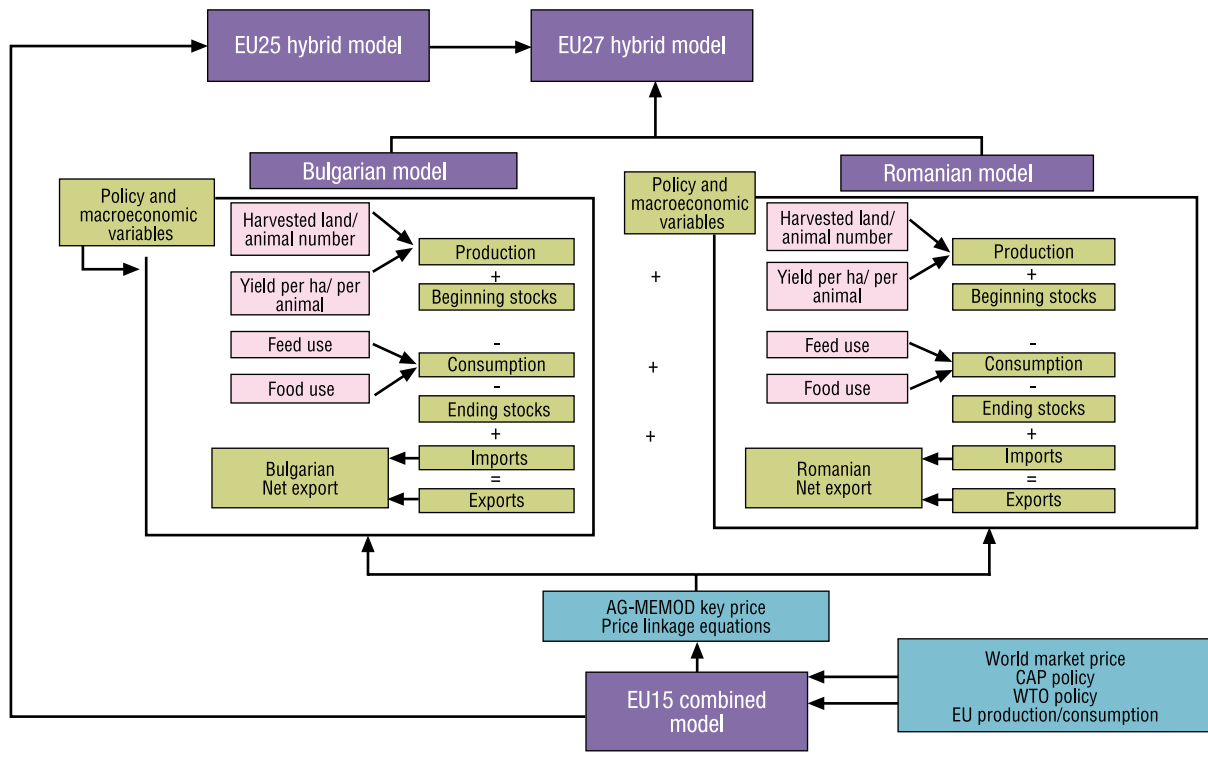

imports, exports and ending stocks) and prices up to 2015 for the EU-25 and EU-27.

When solving the EU models, just as in the individual country models, all commodity markets modelled must close to ensure that the supply and use identity for all commodities and all time periods exactly holds. This general condition concerns all EU model versions (EU-15, EU-25 and EU-27). The distinction between

intra and extra-EU imports and exports is not maintained within the country-level models, but implicitly total intra-EU exports of all country models are equal to total intra-EU imports of all country models. Consequently, the European net export variable (aggregation of the net exports of all countries) can be used as closure at European level to ensure that the supply and use identity always holds.

■ 3. Baseline and Scenario Results

This chapter describes the baseline and scenario projections generated by the AGMEMOD model version developed in this study.

Baseline projections:

- For main agricultural commodities in Member States and the EU-25/EU-27 up to 2015.
- 2003 CAP reforms implemented.

Scenarios:

1. Further CAP Reform.
2. Enlargement of the EU-25 to include Bulgaria and Romania.
3. USD/euro Exchange Rate Change (sensitivity analysis).

Section 3.1 describes the narratives and main assumptions underlying the baseline and the scenarios conducted. Sections 3.2 and 3.3 then provide the most significant results of the baseline projections and focus on each of the scenario impacts for the EU-25 and the EU-27 respectively.

3.1. Descriptions of scenarios and assumptions

One of the principal objectives of this study is to assess the impact of various scenarios on the main European agricultural commodities. In particular, the scenarios represent the differential implementation of the CAP across Member States and the enlargement of the EU. The first step in this respect was to generate baseline projections on the basis of the latest agricultural policy developments (Luxembourg Agreement) and other information available. In general, all baseline and scenario analyses for the old EU-15 Member States have been conducted using the combined model, while baseline and scenario analyses for the EU-10, Bulgaria and Romania

have been conducted using the stand-alone AGMEMOD country-level models. The impact of all of the scenarios analysed on the main agricultural commodities in the countries had been examined by comparing their results with the baseline projections at country level.

3.2. Baseline

This section outlines the assumptions concerning agricultural and trade policy, the macro-economy and world market prices underlying the baseline analysis.

3.2.1. Agricultural policy

The essential part of the baseline projections comprises the definition of agricultural policy implementation in the AGMEMOD country-level models. The baseline policy of the EU-15 Member State models reflects the 2003 CAP reform, which covers the additional milk quotas, the cut in intervention prices and implementation of the Single Farm Payment scheme. Implementation of the 2003 CAP reform was not immediate, but is scheduled over the period 2005 to 2007, depending on the Member States concerned. Also, Member States chose different schemes, as provided for in the respective regulations adopted in the Luxembourg Agreement and their choices are reflected in the AGMEMOD country-level models.

Following the Accession Agreement negotiated at the Copenhagen EU Summit in 2002, the EU-10 joined the EU on 1 May 2004. The AGMEMOD new Member State models have simulated the impacts of accession on their domestic agricultural markets on the basis of the adoption of the Single Area Payment Scheme (SAPS) in 2004-2008 period and the regional version - uniform payments per hectare - of the Single Farm Payment (SFP) scheme (from 2009).

The baseline for Bulgaria and Romania, which joined the EU on 1 January 2007, reflects the continuation of pre-accession agricultural policy up to 2015. The support policy mechanisms used in Bulgaria in the period up to 2004 consist mainly of credit subsidies (lower interest rate credits for long and short-term credits provided via the State "Agriculture" Fund) and small direct payments per hectare or animal. These direct payments were introduced in 2002 and increased on a per hectare basis up to 2004, but remained at a much lower rate compared to such payments in the EU. Agricultural support in Romania during the pre-accession period consisted of three main instruments: price support for wheat, milk and pork, subsidised credit for investments and - since 1997 - general support for agricultural landowners. The price support for products varied greatly during the pre-accession period and was granted only for a part of the output. Also, these direct payments are rather low when compared with EU payment levels. Policy in the pre-accession period was structured along the lines of CAP payments to make for an estimate of the policy impact on supply. This was achieved in the Bulgarian and Romanian models on the basis of the OECD PSE methodology (total support for the product considered by way of direct support, indirect support and market price support) and appropriate multipliers.

Detailed information on the adoption of the SFP in the Member State models and on the rates of nationally funded support for agriculture permitted under the Accession Agreement in the models of the EU-10, Bulgaria and Romania, is available in Report III AGMEMOD – Model description.

3.2.2. Trade policy

As regards trade policy, the baseline makes no assumptions concerning the outcome of the Doha Development Round of the WTO. As there is no probable quantitative outcome so far, the impact of the Doha Round on EU agriculture would be speculative. Hence, the Uruguay Round

Agreement on Agriculture is assumed to prevail for the whole projection period.

Table 3.1 and Table 3.2 contain the policy dataset for the crops and livestock (products) used by AGMEMOD to generate its baseline projections. After the introduction of the 2003 CAP reform, the direct hectare and animal payments mentioned in the tables were decoupled from production and are entered in the country models with adjusted 'synthetic' values (as per the method described in Report III AGMEMOD – Model description).

Thus, compensation for cereals, oilseeds and durum wheat (Table 3.1) and the premiums for suckler cows, bulls and ewes (Table 3.2) are reduced, depending on the decoupling rates and multiplier rates used across the Member States.

3.2.3. Macro-economy

Macroeconomic data are needed to generate baseline projections for the main agricultural commodities in the EU Member States. Historical data on macroeconomic variables such as population, inflation, per capita economic growth and currency exchange rates have been assembled at country level. To simulate and generate projections to a ten-year horizon, exogenous projections for the development of the macroeconomic variables were also needed. In general, these macroeconomic projections were obtained from the national statistical services in the Member States.

Figure 3.1 summarises the baseline assumptions for the key macroeconomic aggregates for the EU-10, EU-15, EU-25 and EU-27 groups regarding population rate, GDP, inflation rate and economic growth per capita. Full details of the macroeconomic assumptions for each AGMEMOD country model were reported in Report III AGMEMOD – Model description.

Furthermore, the exchange rate between the euro and the US dollar is a key macroeconomic factor, since it influences the euro value of the exogenous world prices used in the AGMEMOD

Table 3.1 Crop-related policy instruments used in AGMEMOD

Agricultural Policy	Unit	2000	2001	2002	2003	2004	2005	2006	2007	2008	2009	2010	2015
Common wheat intervention price	euro/tonne	110.3	101.3	101.3	101.3	101.3	101.3	101.3	101.3	101.3	101.3	101.3	101.3
Barley intervention price	euro/tonne	110.3	101.3	101.3	101.3	101.3	101.3	101.3	101.3	101.3	101.3	101.3	101.3
Maize intervention price	euro/tonne	101.3	101.3	101.3	101.3	101.3	101.3	101.3	101.3	101.3	101.3	101.3	101.3
Rye intervention price	euro/tonne	101.3	101.3	101.3	101.3	101.3	101.3						
Cereal compensation	euro/tonne	59	63	63	63	63	63	63	63	63	63	63	63
Oilseed compensation	euro/tonne	82	72	63	63	63	63	63	63	63	63	63	63
Durum wheat- traditional	euro/tonne	88	88	88	88	88	88	88	88	88	88	88	88
Durum wheat-not traditional	euro/tonne	36	36	36	36	36	36	36	36	36	36	36	36
Cereal set-aside rate	percentage	10	10	10	10	10	10	10	10	10	10	10	10

Source: Agra Europe (EC) for the period 2000-2005; assumptions in the AGMEMOD model for the period 2006-2015.

Table 3.2 Livestock and livestock product-related policy instruments used in AGMEMOD

Agricultural Policy	Unit	2000	2001	2002	2003	2004	2005	2006	2007	2008	2009	2010	2015
Beef intervention price	euro/100 kg	324	301	278	243	243	243	243	243	243	243	243	243
Butter intervention price	euro/100kg	328	328	328	328	305	282	260	246	246	246	246	246
SMP intervention price	euro/100kg	206	206	206	206	206	195	185	175	175	175	175	175
Suckler cow premium	euro/head	163	182	200	200	200	200	200	200	200	200	200	200
Male bovine premium	euro/head	160	185	210	210	210	210	210	210	210	210	210	210
Butter consumption subsidy	euro/100kg	40	40	40	40	40	32	24	16	16	16	16	16
SMP feed subsidy	euro/100kg	75	75	75	75	75	60	45	30	30	30	30	30
Ewe premium	euro/head	18	12	19	21	20	20	21	21	21	21	21	21
Milk quota (applied)	1,000 tonne	118,392	118,894	118,894	118,894	118,894	119,370	119,845	120,320	120,320	120,320	120,320	120,320
Suckler cow quota	1,000 head	10,824	10,824	10,824	10,824	10,824	10,824	10,824	10,824	10,824	10,824	10,824	10,824

Trade Policy	Unit	2000	2001	2002	2003	2004	2005	2006	2007	2008	2009	2010	2015
Beef export subsidy limit	1,000 tonne	822	822	822	822	822	822	822	822	822	822	822	822
Pig meat export subsidy limit	1,000 tonne	444	444	444	444	444	444	444	444	444	444	444	444
Poultry export subsidy limit	1,000 tonne	286	286	286	286	286	286	286	286	286	286	286	286
Cheese export subsidy limit	1,000 tonne	321	321	321	321	321	321	321	321	321	321	321	321
Butter export subsidy limit	1,000 tonne	399	399	399	399	399	399	399	399	399	399	399	399
SMP export subsidy limit	1,000 tonne	273	273	273	273	273	273	273	273	273	273	273	273
Other dairy export subsidy limit	1,000 tonne	958	958	958	958	958	958	958	958	958	958	958	958
Beef tariff rate quote	1,000 tonne	144	144	144	144	144	144	144	144	144	144	144	144
Pig meat tariff rate quote	1,000 tonne	76	76	76	76	76	76	76	76	76	76	76	76
Poultry tariff rate quote	1,000 tonne	30	30	30	30	30	30	30	30	30	30	30	30
Sheep meat tariff rate quote	1,000 tonne	280	280	280	280	280	280	280	280	280	280	280	280
Cheese tariff rate quote	1,000 tonne	102	102	102	102	102	102	102	102	102	102	102	102
Butter tariff rate quote	1,000 tonne	87	87	87	87	87	87	87	87	87	87	87	87
SMP tariff rate quote	1,000 tonne	68	68	68	68	68	68	68	68	68	68	68	68

Source: Agra Europe (EC) for the period 2000-2005; assumptions in the AGMEMOD model for the period 2006-2015.

model. For euro-zone countries, the baseline projection for the evolution of the euro/US dollar exchange rate is illustrated in Figure 3.2.

Since AGMEMOD does not have the capacity in this area, this exchange rate projection is sourced from internationally recognised macroeconomic forecasters. For non-euro-zone countries, the exchange rate between these national currencies and the US dollar is derived from their exchange rate with the euro and the baseline US dollar/euro exchange rate, so that projected exchanges rates are consistent with the absence of possibilities for triangular arbitrage. The assumptions on the evolution of the US dollar/euro exchange rate are based on the observed exchange rate for 2005 and the percentage change in this exchange rate published in the *FAPRI 2006 US and World Agricultural Outlook*.

3.2.4. World market prices

The last dataset, required to generate baseline and scenario projections, concerns the world market prices of the commodities included in the model. The price projections have been taken, in general, from the *FAPRI 2006 U.S. and World Agricultural Outlook*. The world livestock and grain prices are market prices from the U.S. dairy commodity prices and oilseed, oilseed meal and oil prices are generally northern European prices. World market prices are specifically induced in the key price equations to capture the effects of the world on the EU. For all simulations (baseline and scenarios) the world agricultural commodity price projections are assumed to be unchanged (in US dollars) from the baseline levels. This reflects the structure of the AGMEMOD model, where developments on

Figure 3.1 Macroeconomic projections for EU groups

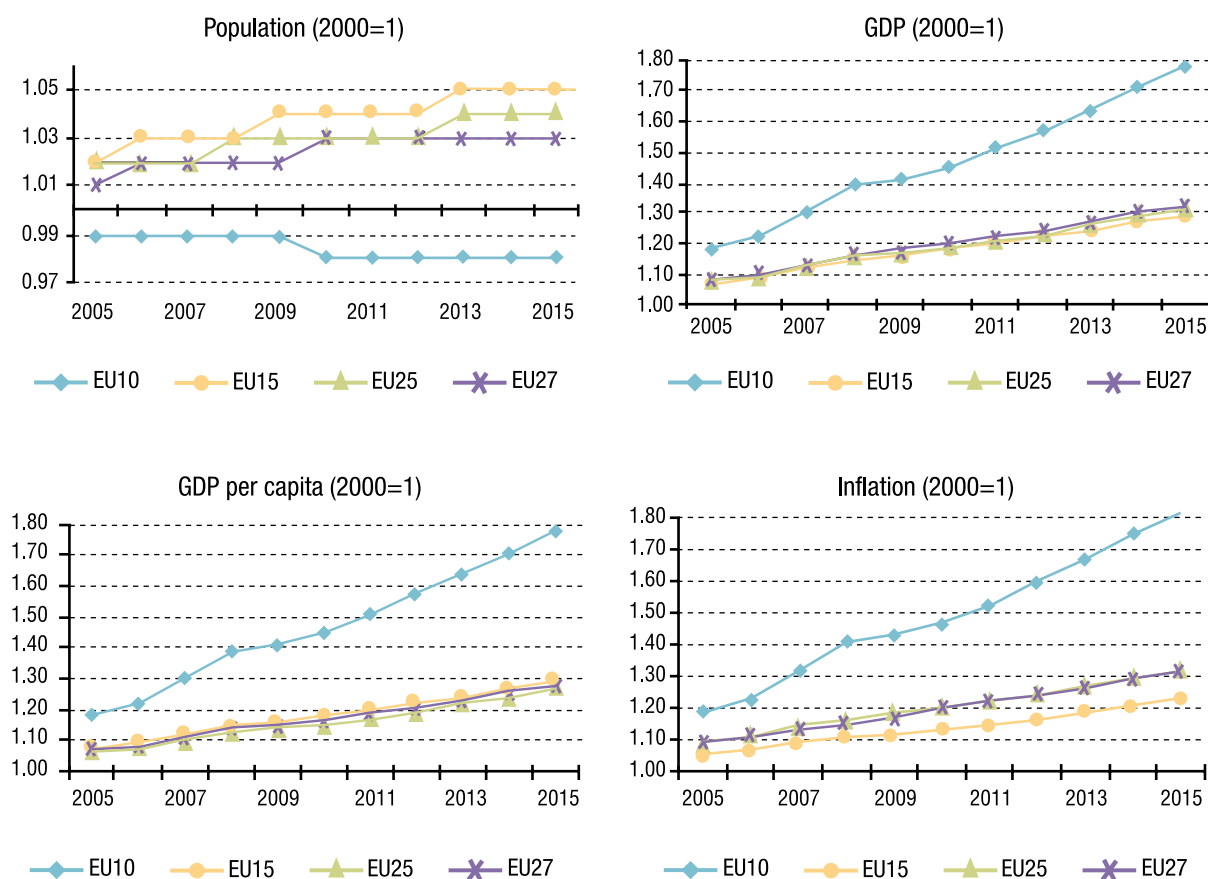

Source: EU Member State national services

Figure 3.2 US dollar/Euro exchange rate projection

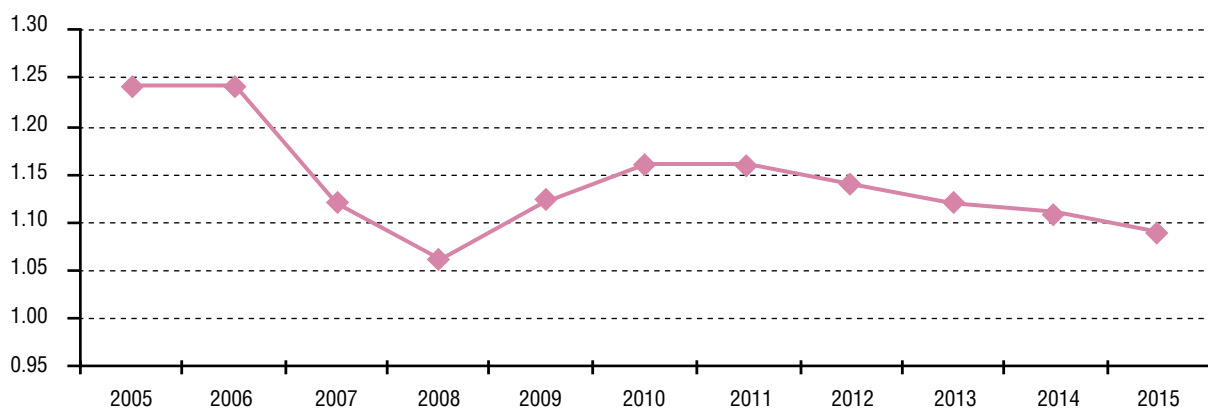

Source: FAPRI 2006 US and World Agricultural Outlook (www.fapri.org and www.fapri.missouri.edu)

EU markets are not assumed to have any impact on the level of world prices. This assumption is a feature of the AGMEMOD model that will be revised as part of a research programme of another project. The developments of world market prices are presented in Figure 3.3.

3.3. Scenarios

Three sets of scenarios were analysed as part of this study. These scenarios are briefly described here and are termed "Further CAP reform", "Exchange Rate Change" and "EU

Figure 3.3 World market price projections used in the baseline and scenarios

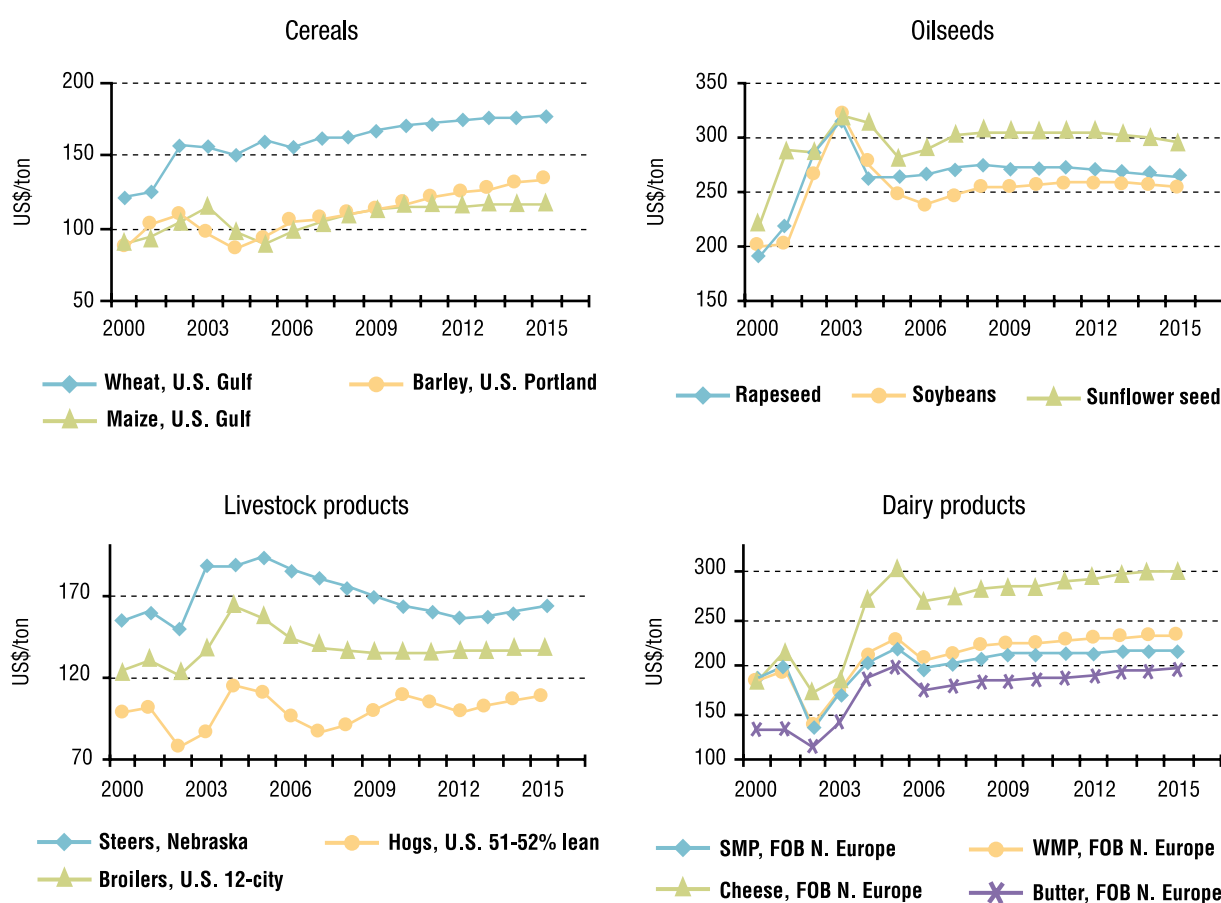

Source: FAPRI 2006 US and World Agricultural Outlook

Enlargement". The scenarios have been analysed with a time horizon to 2015, for each EU Member State, EU-15, EU-10 and for EU-25 and EU-27 aggregates. The results of the scenarios analysed have been compared with the AGMEMOD baseline projections. Table 3.3 provides a summary of the key elements of each scenario.

3.3.1. Further CAP Reform scenario

The Luxembourg Agreement of June 2003 introduced decoupled direct payments to EU farmers, but permitted differential implementation of these payments across EU Member States (e.g. countries were allowed to retain certain direct payments as coupled payments). In addition, the CAP payments system that applies in most of the Member States that acceded to the EU in May 2004 differs from those that apply in

the old Member States. Under the Further CAP Reform scenario, all direct payments will be decoupled from 2007 onwards. Equally, the rates of compulsory modulation that apply under the Luxembourg Agreement will be doubled to 10% from 2007 onwards. The existing € 5 000 franchise, under which the modulation provision does not apply, will be retained.

3.3.2. EU Enlargement scenario

The EU Enlargement scenario examines the consequences of accession to the EU of Bulgaria and Romania (which took place on 1 January 2007) on agricultural markets in these two countries and the impact of accession on the agricultural markets of an expanded EU. The counterfactual scenario of non-enlargement is based on the continuation of pre-accession

Table 3.3 Summary of scenarios to be analysed

	Baseline	Further CAP Reform	Exchange Rate Change	EU Enlargement**
EU-15*	CAP with national implementation of Luxembourg Agreement SFP system. Includes possibility for continuation of coupled direct payments as permitted under the Luxembourg Agreement	From 2007 full decoupling of all remaining coupled direct payments allowed under the Luxembourg Agreement. Compulsory modulation rate doubled from 2007	National currency versus US\$ exchange rate change scenarios from 2007: Euro = USD 1.0 Euro = USD 1.3 Euro = USD 1.4	As baseline with Romanian and Bulgarian accession
EU-10	CAP with SAPS to 2008. SFP system from 2009. CNDP [#] until 2013. With the adoption of the SFP system in 2009 coupled direct payments can be introduced. CNDP may also be coupled	From 2007 all direct payments fully decoupled from production. This includes coupled CNDP and coupled payments allowed on adoption of the SFP system. Modulation rate doubled from 2013 onwards	As per old Member States with national currency exchange rates versus the euro assumed fixed	As baseline with Romanian and Bulgarian accession
Bulgaria and Romania	Not applied	Not applied	As per EU Member States with national currency exchange rates versus the euro assumed fixed	On accession in 2007, SAPS is implemented with no adoption of the SFP system before 2015

Source: Report 3 of JRC-IPTS Contract No 150267-2005-FIED-NL

* For the purposes of the analysis conducted in this study, the EU-15 aggregate includes Slovenia. Slovenia has chosen to adopt the conventional CAP and SFP system and will not be utilising SAPS.

** A non-enlargement scenario will also be analysed. In this scenario, the non-accession policy for Bulgaria and Romania will continue for the whole projection period.

[#] CNDP – Complementary National Direct Payments (top-ups)

agricultural policy (defined as policy in 2004) in Bulgaria and Romania over the projection period (i.e. to 2015). This Non-enlargement scenario enables the impact of accession on Romanian and Bulgarian agriculture to be estimated.

The Enlargement scenario is based on a set of policy and price assumptions. On accession, Bulgaria and Romania adopted the SAP Scheme. This scheme provides a flat-rate per hectare payment to farmers paid once per year, irrespective of the crops produced or even whether any crops at all are produced. These payments per unit hectare are calculated in the same way as in other Member States operating the SAPS, i.e. the total amount of direct payment funds available for a given Member State is divided by the total amount of eligible agricultural area.

Within specific defined limits, Bulgaria and Romania (like the other EU-10) have the option of “topping up” EU-funded direct payments with national subsidies. The Enlargement scenario analysed took account of the gradual increase in the value of direct payments following accession

and the possibility of nationally funded top-up CNDP. It is assumed that the 2003 CAP reform will not be implemented in Bulgaria and Romania following their accession, but that their agricultural policy will be determined by SAPS up to 2015, with the possible addition of nationally financed complementary direct payments.

Under the Enlargement scenario, prices for most Bulgarian and Romanian agricultural products are assumed to converge to the EU level of prices by the end of the projection period. Generally, the producer price levels in these countries are significantly lower than the price level in the EU. However, this situation differs somewhat from sector to sector. Bulgarian country experts predict different price convergence patterns among the commodities modelled. For most products an immediate price increase is projected to occur following accession to the EU. Under the Enlargement scenario the most substantial increase projected to occur is in Bulgarian milk prices, which are assumed to increase by almost 25%. This large increase

exceeds the projected increases for barley and wheat prices of 17% and 10% respectively. For all other analysed products, with the exception of beef, the projected increase in Bulgarian prices is 5% or less. The Bulgarian beef price is currently substantially lower than the EU key price, but the projected price transmission between EU and Bulgarian prices will be such that by the end of the projection period (2015) the existing price gap between EU and Bulgarian prices is assumed to be eliminated.

Following accession, most agricultural producer prices in Romania are also assumed to increase. At 28%, the most substantial price increase is for milk compared to the baseline of non-enlargement. This is followed in magnitude by price increases that are projected to occur for pork (9%) and wheat (6%). On the other hand, prices for sunflower and beef in Romania following accession are projected to decline by 5% and 7% respectively. According to Romanian expert opinions, only beef prices are expected to remain well below EU price levels.

3.3.3. Exchange Rate Change scenario (sensitivity analysis)

The exchange rate between the US dollar and the euro is an important factor in determining the influence of world prices of agricultural commodities on EU agricultural markets and the competitiveness of EU agricultural exports vis-à-vis world markets. Thus, using the AGMEMOD model, changes to the US dollar versus euro exchange rate that could emerge over the 10-year projection period have been simulated and their impact on agricultural markets analysed.

Under the baseline, the evolution of this exchange rate follows the path illustrated in Figure 3.2. Three alternative paths of the US dollar versus the euro have been analysed to evaluate the impact of changes in this key macroeconomic assumption. Two of these exchange rate projections involve a depreciation of the US dollar versus the euro to US\$1.30 and US\$ 1.40 per euro in 2007. The third alternative exchange rate projection examined is one under which the euro depreciates versus the dollar from the exchange rate in 2007 to a parity exchange rate of US\$ 1.00 per euro. The reason for this sensitivity analysis arises from the expectation that external imbalances in the US economy could in the future lead to large changes in the US dollar/euro exchange rate and hence would influence EU agriculture.

■ 4. EU-25 baseline and scenarios projections

This section sets out the results under the baseline, the Further CAP Reform and the Exchange Rate Change scenarios for the EU-25. As noted earlier, all of the individual EU-15 country results were generated using the AGMEMOD combined model, while the results for the EU-10 are based on stand-alone country models. Consequently, the EU-25 results should be interpreted as representing the output of the EU-25 hybrid model. Although not all 25 country models have been fully integrated yet, the aggregated hybrid results provide some insight into the general developments under both the baseline and the scenario impacts. This section also gives insight into the decomposition of the EU-25 aggregates into results of the old Member State group (EU-15) and the EU-10 respectively.

4.1. Crops

4.1.1. EU-25 - grains and oilseeds

The projections for the cereal markets of the EU-25, following implementation of the measures of the Luxembourg Agreement (the baseline), suggest that cereal production in the EU will expand at a very moderate pace. Due to world price and macroeconomic factors, the level of prices is projected to increase from 2005 onwards. This increase in prices, when combined with somewhat reduced feed demand for grains from the European livestock sectors, reduces overall domestic use of cereals in the EU-25 over the period 2005 to 2015. On the one hand, domestic use of soft wheat and durum wheat would expand under the baseline despite increases in prices. On the other hand, domestic use of barley and maize would reduce (Figure 4.1)

The degree to which arable aid payments were coupled under the baseline was the lowest across all commodity organisations of the CAP that had direct payments under the CAP prior to the Luxembourg Agreement. Thus, the *a priori*

expectation is that the Further CAP Reform scenario should only have minor impacts on the supply and use balance for cereals and oilseeds in the EU-25 and that price impacts when compared to the baseline should also be minimal.

Figure 4.1. shows that the production of cereals under the Further CAP Reform scenario indeed only changes marginally when compared to the baseline. On the one hand, rye and durum wheat production decreases, while maize production counter-intuitively increases. This result may be due to the fact that arable land previously used to grow durum wheat is shifting into maize.

Under the baseline, oilseed production and domestic use in the EU-25 is projected to expand strongly over the period 2005 to 2015. At 22%, domestic use of rapeseed would grow the most, with its production projected to increase by over 20 percent. Despite higher prices, domestic use would increase appreciably. Here, the growing demand for oil for bio-energy plays a role. The rising world price of soybeans and sunflower leads to a moderate growth in demand for these oilseeds and their associated meals and oils (see Figure 4.2.).

The full decoupling of arable aid payments would be expected to lead, *ceteris paribus*, to lower production of oilseeds. Both figures show that the production of oilseeds under the Further CAP Reform scenario only changes marginally when compared to the baseline.

Since prices of oilseeds and their associated meal and oils are exogenous to the AGMEMOD model, the Exchange Rate shocks examined in the scenario would be expected to have a bigger projected impact on the oilseed sectors than on the EU cereal sector where prices are endogenous, i.e. where EU-25 supply, demand and prices adjust so as to ensure market clearance in the EU in the event of an exogenous change

Figure 4.1 EU-25 soft wheat and maize projections under baseline and scenarios

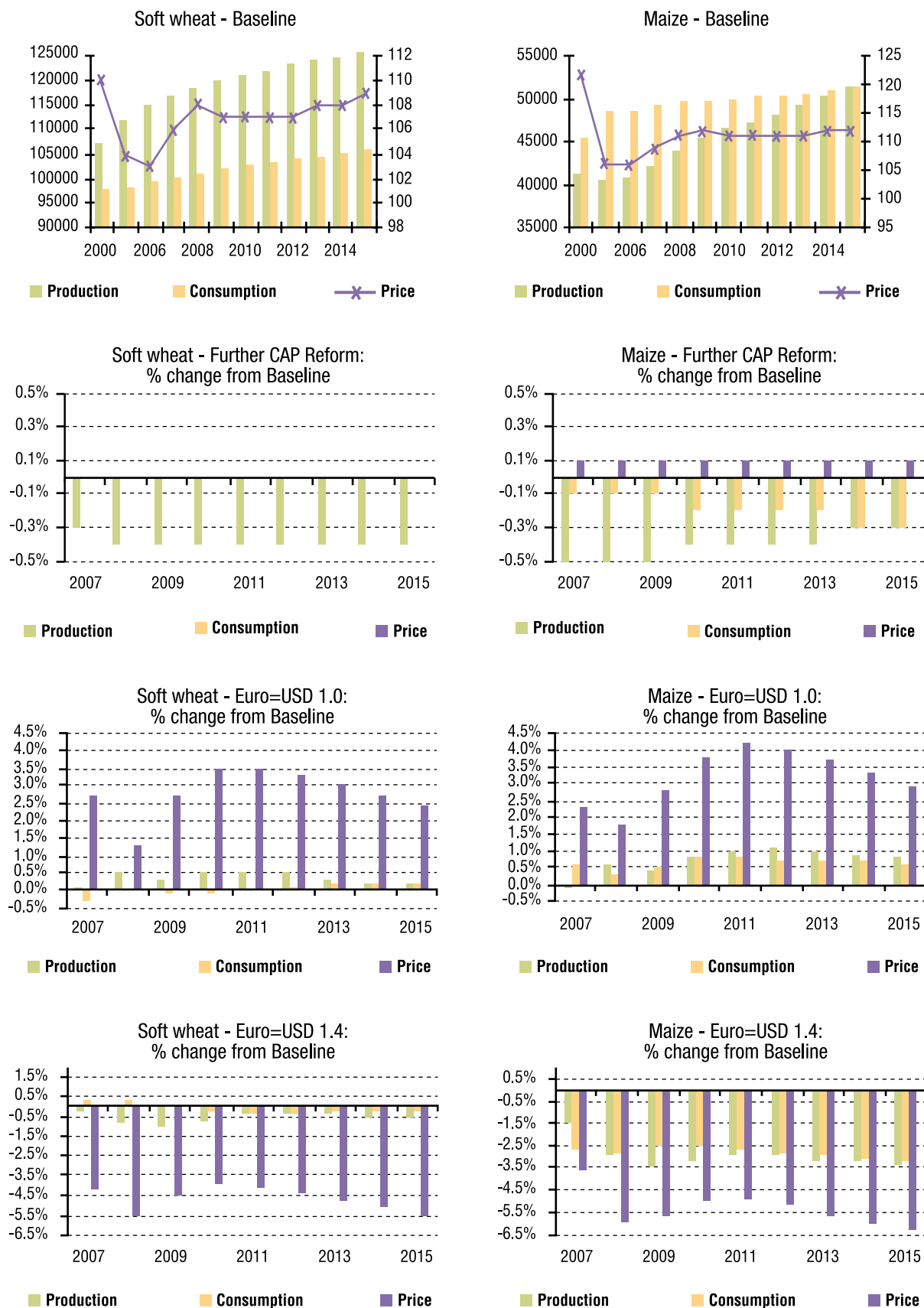

Source: AGMEMOD Country Models (2006)

Figure 4.2 EU-25 rapeseed and sunflower seed projections under baseline and scenarios

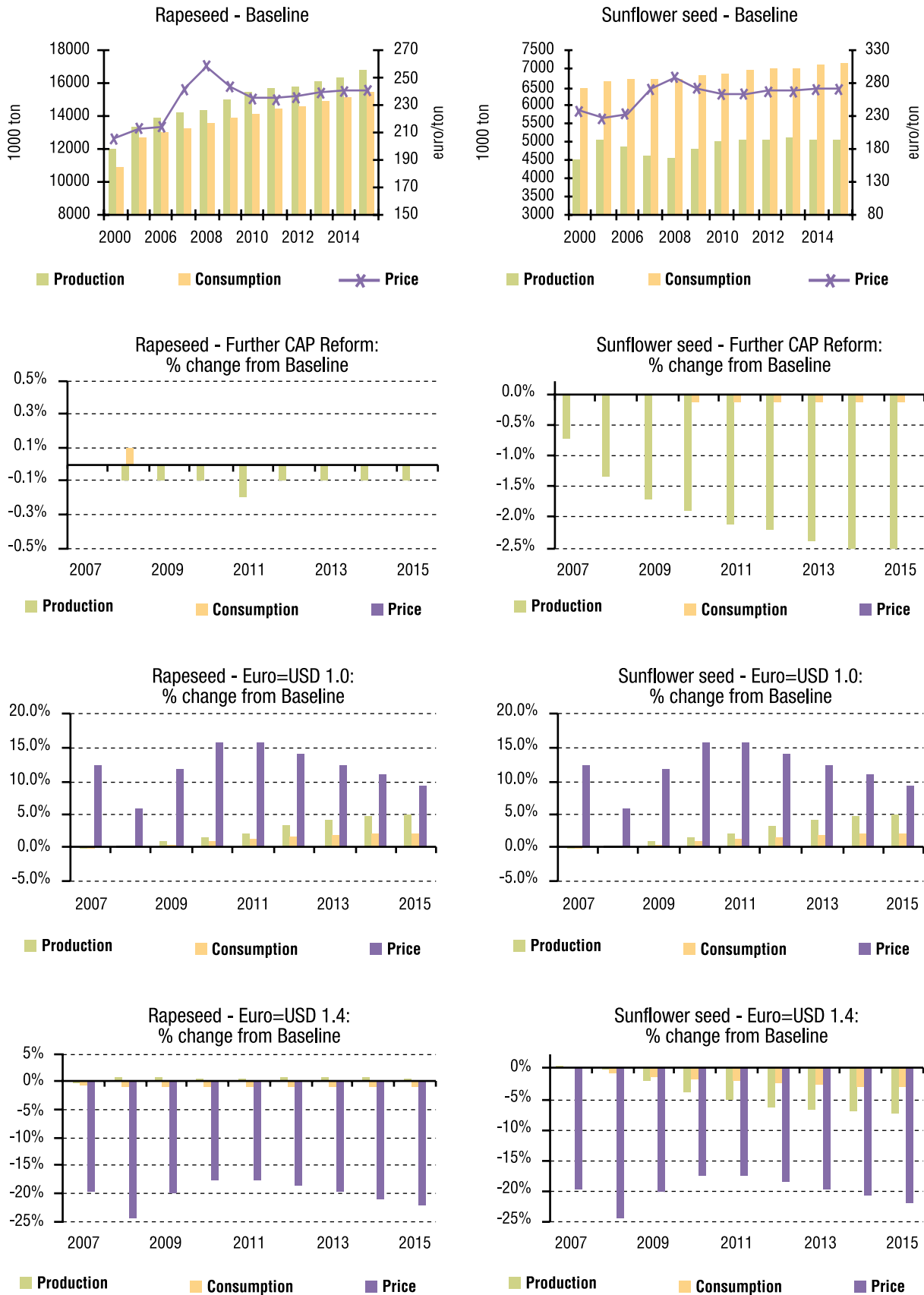

Source: AGMEMOD Country Models (2006)

in the exchange rate. The results of the scenario simulations tie in with these *a priori* expectations in terms of how prices, production and uses of cereals and oilseeds would adjust in the event of such a change occurring. As expected, due to the structure of the AGMEMOD model, the price impact and consequently the supply (production and imports) and use (domestic use and exports) impacts of the change are larger for oilseed and oilseed meal and oil markets.

Under the Euro=USD1.0 scenario, all crop product prices are higher than under the baseline and these are associated with greater production of all cereals and oilseeds when compared with the baseline. As expected, the percentage change in oilseed prices under the Euro=USD1.0 scenario is greater than the changes in other crops' market prices. Under the Euro=USD1.4 scenario, the euro appreciates against the US dollar, which results

in lower crop prices compared to the baseline. Again, the magnitude of the oilseed price changes projected is greater than the changes for cereals. In response to the lower prices, the production of all crops in the EU-25 aggregate is lower than under the baseline.

4.1.2. EU-15 and EU-10 - grains and oilseeds

Figure 4.3 decomposes the EU-25 projections for grain production and consumption under the baseline into results for the EU-15 and the EU-10 respectively. Between 2000 and 2015, the share of the EU-15 in EU-25 production and consumption would fall. In particular, production in Hungary and Poland will grow due to yield developments following accession. The EU-25 net export position will increase for soft wheat and barley, while the situation for maize will change

Figure 4.3 Grain production and consumption in the EU-15, EU-10 and EU-25 under baseline

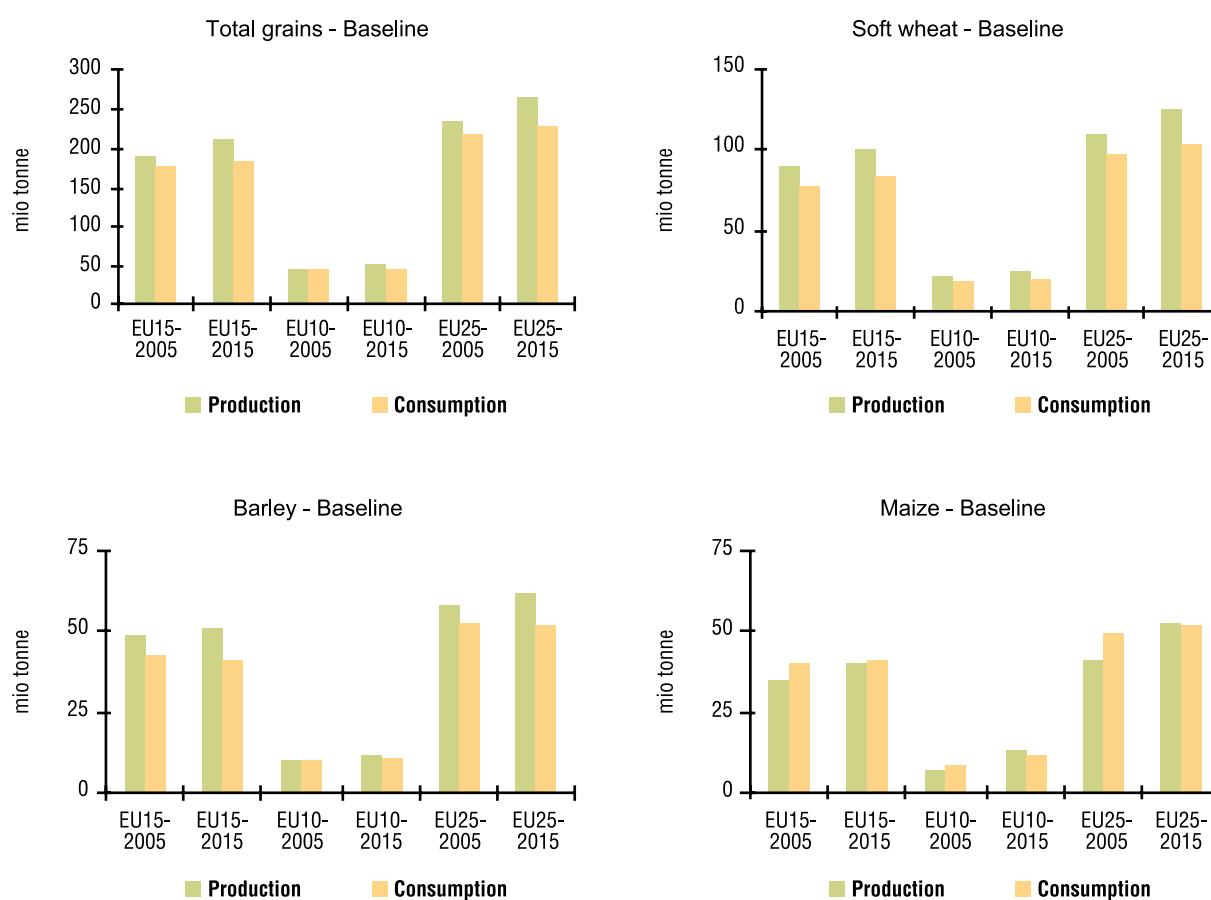

Source: AGMEMOD Country Models (2006)

from a net importer to a net exporter. Table 4.1 shows the self-sufficiency rates for the grain types considered.

Figure 4.4 decomposes the EU-25 projections for oilseed production and consumption under the baseline into EU-15 and EU-10 groups. Despite significant production growth in Italy, France

Table 4.1 Self-sufficiency rates for grains in the EU-15, EU-10 and EU-25 under baseline

Self-sufficiency rate	Group	2000	2005	2006	2007	2008	2009	2010	2011	2012	2013	2014	2015
Total grains	EU15	1.07	1.08	1.09	1.10	1.11	1.09	1.12	1.13	1.14	1.15	1.15	1.16
	EU10	0.94	1.01	1.01	1.04	1.07	1.09	1.10	1.11	1.12	1.14	1.13	1.14
	EU25	1.05	1.07	1.07	1.09	1.10	1.08	1.12	1.13	1.14	1.14	1.15	1.16
Soft wheat	EU15	1.12	1.15	1.16	1.16	1.18	1.18	1.18	1.18	1.18	1.19	1.19	1.20
	EU10	0.99	1.12	1.13	1.17	1.17	1.19	1.21	1.23	1.24	1.24	1.21	1.21
	EU25	1.09	1.14	1.15	1.17	1.17	1.18	1.18	1.19	1.19	1.20	1.20	1.20
Barley	EU15	1.12	1.14	1.15	1.15	1.16	1.18	1.18	1.19	1.21	1.22	1.23	1.25
	EU10	0.87	1.03	1.07	1.07	1.07	1.07	1.07	1.06	1.07	1.06	1.04	1.04
	EU25	1.08	1.12	1.13	1.14	1.14	1.16	1.16	1.17	1.18	1.19	1.19	1.21
Maize	EU15	0.90	0.86	0.88	0.88	0.89	0.91	0.92	0.93	0.96	0.95	0.96	0.97
	EU10	0.92	0.77	0.75	0.80	0.92	0.99	1.01	1.02	1.06	1.11	1.16	1.19
	EU25	0.90	0.84	0.85	0.86	0.90	0.93	0.94	0.95	0.98	0.98	1.00	1.01

Source: AGMEMOD Country Models (2006)

Figure 4.4 Oilseed production and consumption in the EU-15, EU-10 and EU-25 under baseline

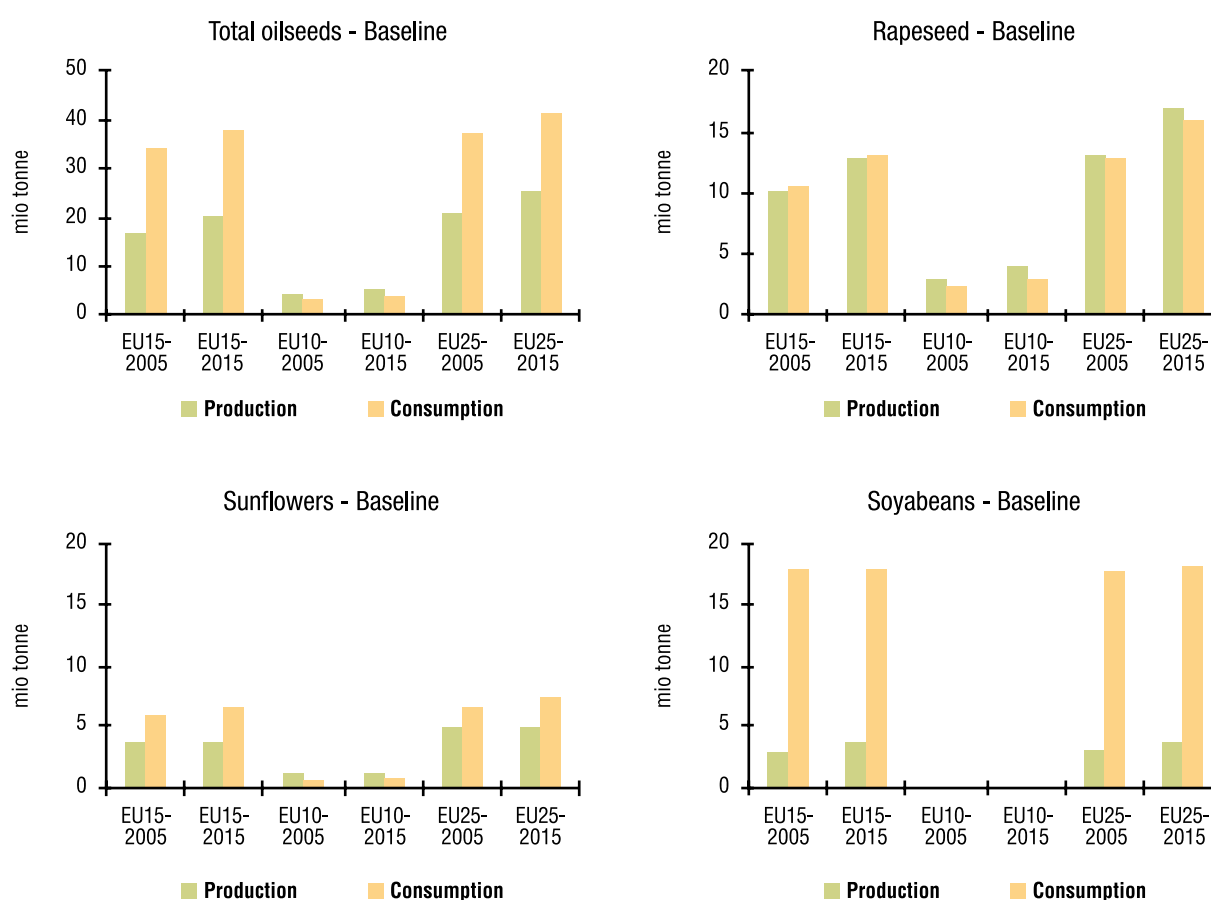

Source: AGMEMOD Country Models (2006)

Table 4.2 Self-sufficiency rates for oilseeds in the EU-15, EU-10 and EU-25 under baseline

Self-sufficiency rate	Group	2000	2005	2006	2007	2008	2009	2010	2011	2012	2013	2014	2015
Total oilseeds	EU15	0.48	0.48	0.49	0.49	0.48	0.50	0.51	0.51	0.52	0.53	0.53	0.54
	EU10	1.20	1.40	1.38	1.37	1.37	1.40	1.42	1.42	1.42	1.43	1.43	1.43
	EU25	0.54	0.55	0.56	0.56	0.56	0.57	0.59	0.59	0.60	0.61	0.61	0.62
Rapeseeds	EU15	1.07	0.95	0.98	0.97	0.94	0.96	0.97	0.98	0.99	0.99	0.99	0.99
	EU10	1.17	1.31	1.30	1.31	1.32	1.34	1.36	1.35	1.35	1.35	1.36	1.37
	EU25	1.08	1.02	1.04	1.03	1.01	1.03	1.04	1.05	1.05	1.05	1.06	1.06
Sunflowers	EU15	0.63	0.61	0.59	0.58	0.57	0.56	0.56	0.56	0.56	0.56	0.56	0.56
	EU10	1.37	1.69	1.68	1.59	1.55	1.59	1.64	1.68	1.71	1.72	1.69	1.65
	EU25	0.69	0.72	0.70	0.68	0.67	0.67	0.67	0.68	0.68	0.68	0.67	0.67
Soyabeans	EU15	0.12	0.16	0.16	0.16	0.16	0.17	0.17	0.18	0.19	0.19	0.20	0.20
	EU10	0.97	1.32	1.34	1.32	1.38	1.47	1.50	1.49	1.49	1.50	1.50	1.50
	EU25	0.12	0.16	0.16	0.16	0.17	0.17	0.18	0.18	0.19	0.19	0.20	0.21

Source: AGMEMOD Country Models (2006)

and Germany, the share of the EU-15 in EU-25 production is projected to fall somewhat. The EU-15 self-sufficiency rate of oilseeds is expected to increase over the period 2000 to 2015, but the EU-15 group will remain a net importer. On the other hand, the EU-10 is a net exporter of oilseeds in 2000 and its self-sufficiency rates will expand up to 2015. The whole EU-25 will remain a net importer of sunflower and soybeans and a net exporter of rapeseeds. Table 4.2 shows the development of the self-sufficiency rates for the oilseed types considered.

Appendix 1 presents figures with baseline results and scenario simulation impacts of crops in the EU-15 and EU-10 respectively.

4.2. Livestock and dairy products

4.2.1. EU-25 - livestock products

Under the baseline, the national level implementation of the Luxembourg Agreement that has occurred to date is assumed to continue unchanged until 2015. Member States have significant freedom with respect to the degree to which direct payments are fully or partially decoupled from production. Most Member States have chosen to retain at least some of their Agenda 2000 livestock direct payments in their production coupled form. EU-25 beef production is projected to decline by 2 percent in 2015 when compared with the level in 2005, while EU-25 prices will increase by 5 percent as a result of

this contraction in supply. With higher prices, domestic beef use will remain stable. EU lamb production will also decline over the baseline projection period by almost 10 percent compared to 2005, with a moderate increase in prices. Domestic use of pig meat and poultry meat are projected to increase due to the higher prices of beef and lamb. Furthermore, in response to projected higher prices, pig meat production will increase by 16 percent between 2005 and 2015. Prices of poultry meat are projected to continue to decline due to the continued strong technology-driven expansion of poultry production, which over the period 2005 and 2015 is set to increase by 12 percent (see Figure 4.5 and Figure 4.6).

Most Member States chose to retain some direct payments as coupled to production but the preponderance of livestock direct payments have been decoupled. Thus, the impact of the Further CAP Reform scenario can be expected to be of limited magnitude. With the full decoupling of direct payments that had remained coupled to production under the Luxembourg Agreement, beef production in the EU-25 is projected to decline compared to the baseline from 2007 onwards. With EU-25 prices also projected to increase compared to the baseline (increased imports moderate the price impact of the projected indigenous supply contraction), total domestic use of beef in the EU-25 is projected to be marginally lower. Given the absence of any change in policy with respect to the pig and

Figure 4.5 EU-25 beef and lamb meat projections under baseline and scenarios

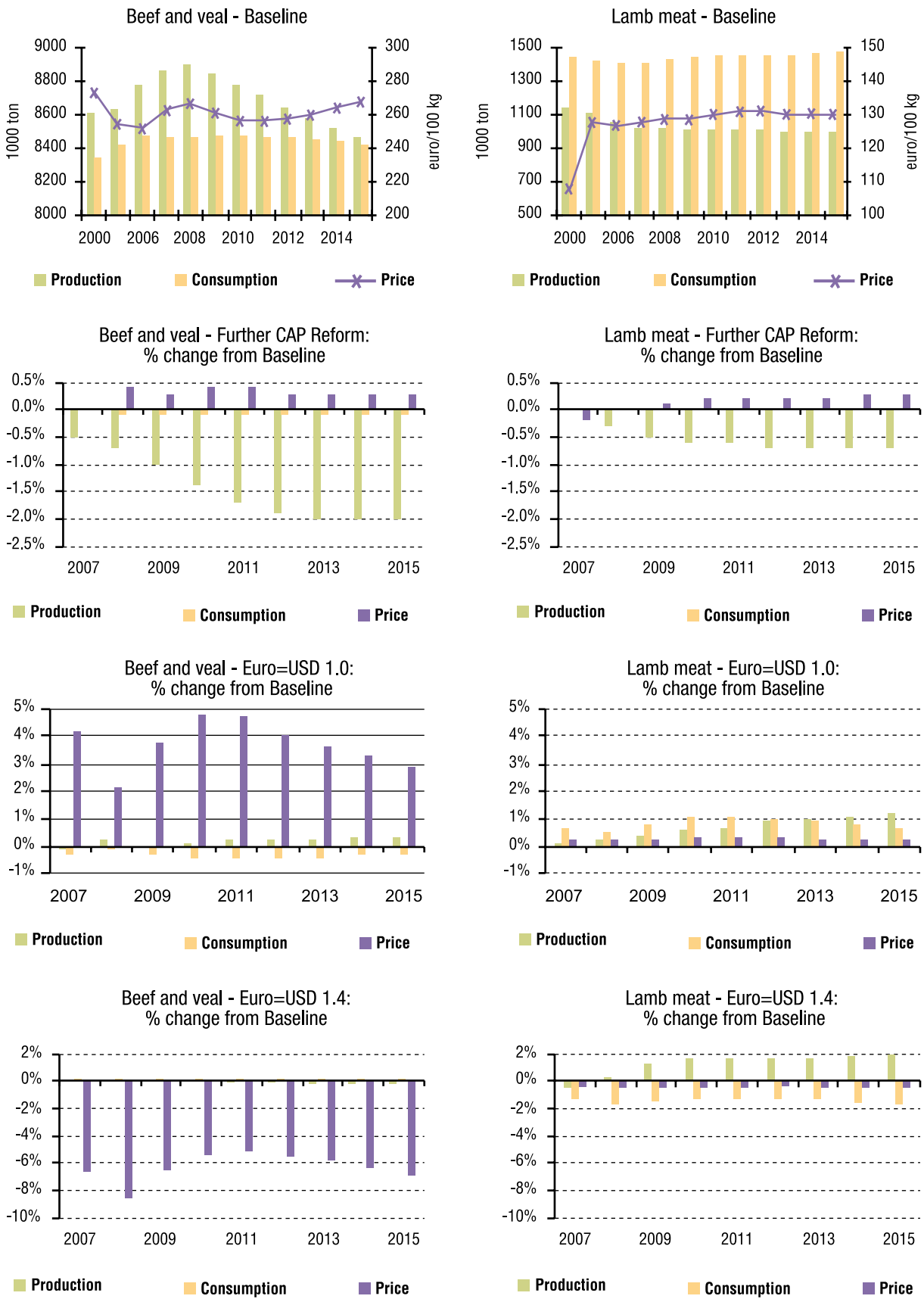

Source: AGMEMOD Country Models (2006)

Figure 4.6 EU-25 pig meat and poultry projections under baseline and scenarios

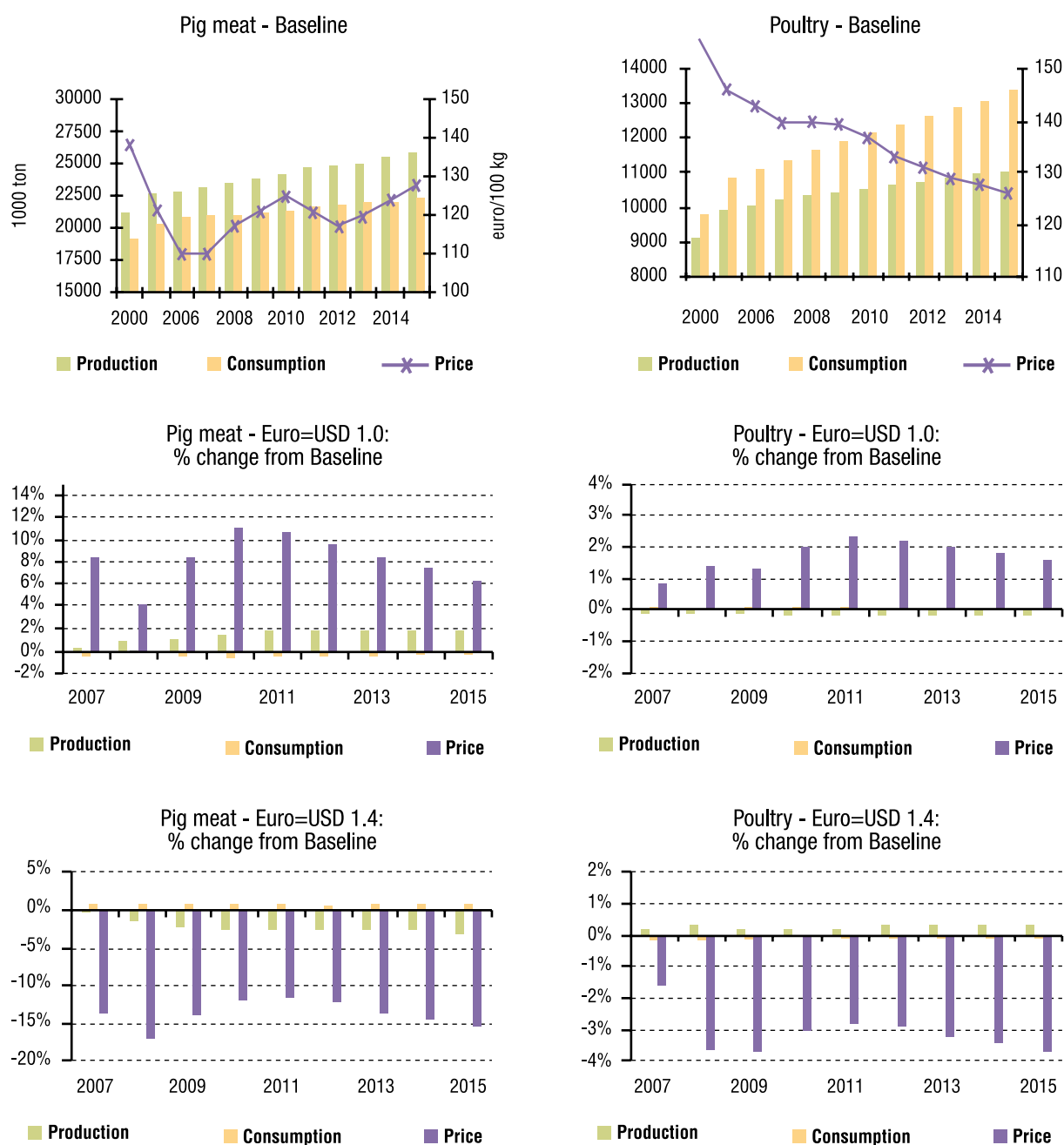

Source: AGMEMOD Country Models (2006)

poultry sectors, changes in these markets are negligible. Hence, these commodities are not included in Figure 4.6.

The results for livestock and livestock product markets of the Exchange Rate Change scenario simulations tie in with *a priori* expectations in terms of how prices, production and uses of meats would adjust in the event of such exogenous macroeconomic changes occurring. Under the

Euro=USD1.0 scenario, all meat product prices are higher than under the baseline from 2007 onwards. The higher EU prices under this scenario are generally associated with higher production and lower domestic of all use of meats. For some commodities, cross-price effects lead to small increases in domestic use when compared with the baseline. This is the case, for example, for sheep meat due to the large increase in beef

prices. As would be expected *a priori*, all meat prices under the Euro=USD1.4 scenario are lower than under the baseline. In response to these lower prices, the production of all meats in the EU-25 aggregate is lower than under the baseline and all domestic uses of meats are higher.

4.2.2. EU-25 - dairy products

The Luxembourg Agreement contained measures that affected the EU-25 dairy sector in a number of ways: intervention prices of skimmed milk powder and butter were reduced, milk quotas increased and dairy premiums decoupled via inclusion in the SFP. Due to the fact that the price difference between the domestic EU market and the world markets for skimmed milk powder is small, the projected price decline under the baseline is only reflected to a partial degree in EU-25 market prices (minus 7 percent). With a larger price differential between EU and world market prices for butter, the reduction in the intervention price is more or less completely reflected in lower domestic prices of butter (minus 10 percent in the period 2005 to 2015).

With lower butter prices, milk is reallocated within EU dairy processing industries from butter to cheese production. At EU-25 level, butter production is projected to be 6 percent lower in 2015 than in 2005, whereas cheese production will expand by about 8 percent. Over the same period, the reallocation of milk protein necessary to facilitate this increase in cheese production will affect skimmed milk powder production: EU-25 skimmed milk powder production will decline by over 28 percent. In addition to the impact of cuts in intervention on the allocation of milk fats and proteins, changed prices will also have an impact on EU-25 consumption of dairy products. Lower EU butter prices will increase domestic EU-25 butter use by almost 2 percent. Cheese consumption in the EU-25 will increase by almost 15 percent in the period 2005 to 2015. Although all dairy prices (with the exception of cheese) fall under the baseline, and as a consequence the producer prices for milk, the raw milk production will continue to be at quota levels.

The Further CAP Reform scenario has no specific reforms for dairy commodity market organisations and as a consequence the impact of the reforms on dairy markets is negligible.

Figure 4.7 and Figure 4.8 present the developments of the dairy commodity markets in AGMEMOD.

The results for dairy product markets of the Exchange Rate Change scenario simulations tie in with *a priori* expectations in terms of how prices, production and uses would adjust in the event of such exogenous macroeconomic changes occurring. Under the Euro=USD1.0 scenario, all dairy product prices are higher than under the baseline from 2007 onwards, while all product prices under the Euro=USD1.4 scenario are lower than under the baseline. In response to these lower prices, the production of butter and cheese in the EU-25 aggregate is lower than under the baseline and domestic uses of these products are higher.

4.2.3. EU-15 and EU-10 - livestock products

Figure 4.9 splits the EU-25 projections for livestock products production and consumption under the baseline into results for the EU-15 and the EU-10. Between 2000 and 2015, the share of the EU-15 in EU-25 beef and veal production and consumption is projected to fall as a result of the decoupling effect. On the other hand, EU-10 beef and veal production will increase following accession, which is mainly due to higher slaughtering weights in the EU-10 (technical progress of better beef breeds). Projections for consumption per head fall throughout the EU. In 2015, the EU-15 is expected to be a net beef importer, while the self-sufficiency rate of the whole EU-25 is set to reduce to a level just above 100%.

The share of EU-15 in the EU-25 pig meat and poultry meat production projections will decrease in the period 2005 to 2015. In particular, Hungary is set to experience significant production growth in both meat types. Pork and poultry consumption per head will increase throughout the EU, due to cross-price effects. The net export position is projected to rise for pig meat, but to decrease for poultry meat.

Figure 4.7 EU-25 butter and cheese projections under baseline and scenarios

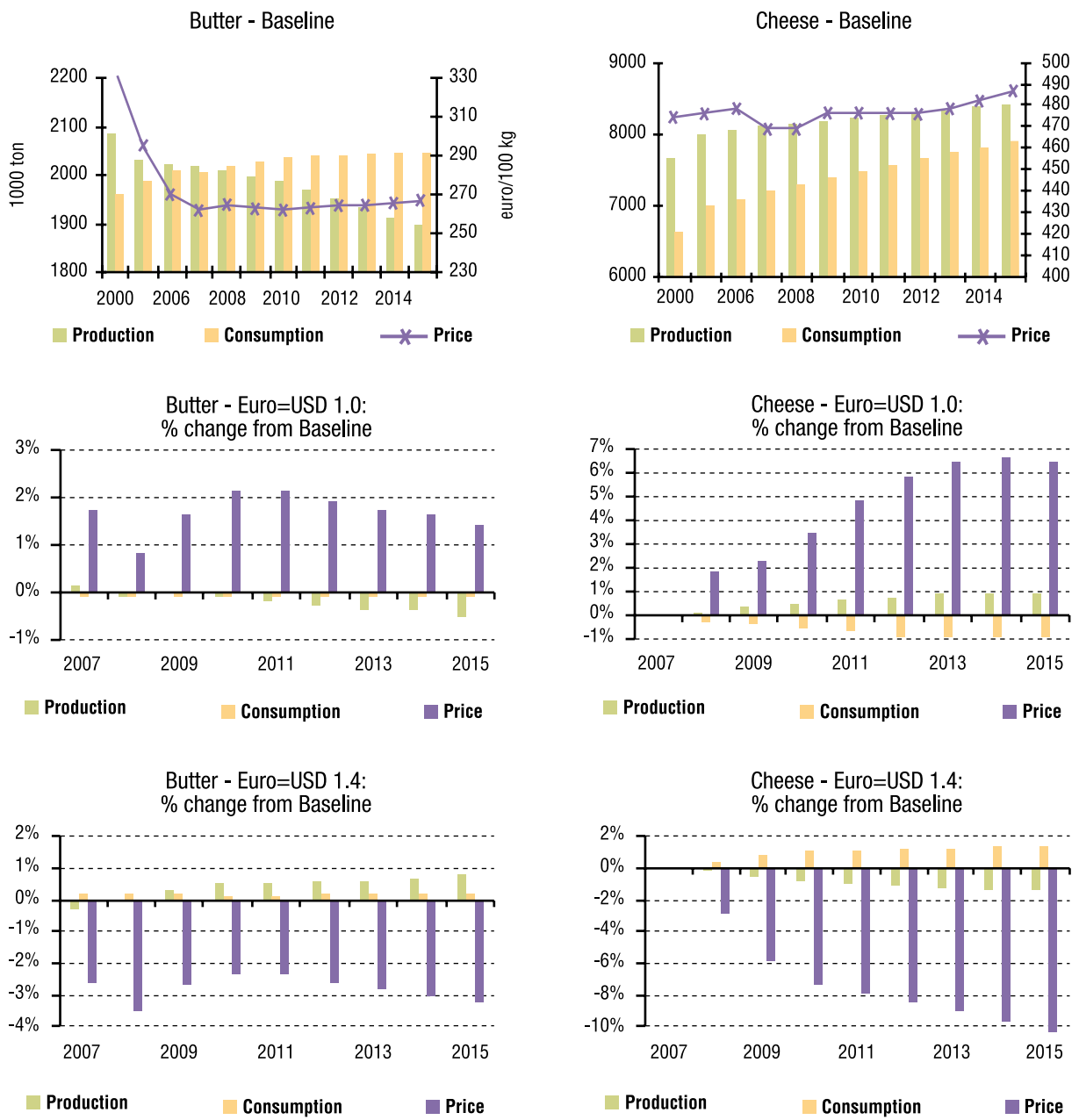

Source: AGMEMOD Country Models (2006)

Figure 4.8 EU-25 skimmed and whole milk powder projections under baseline and scenarios

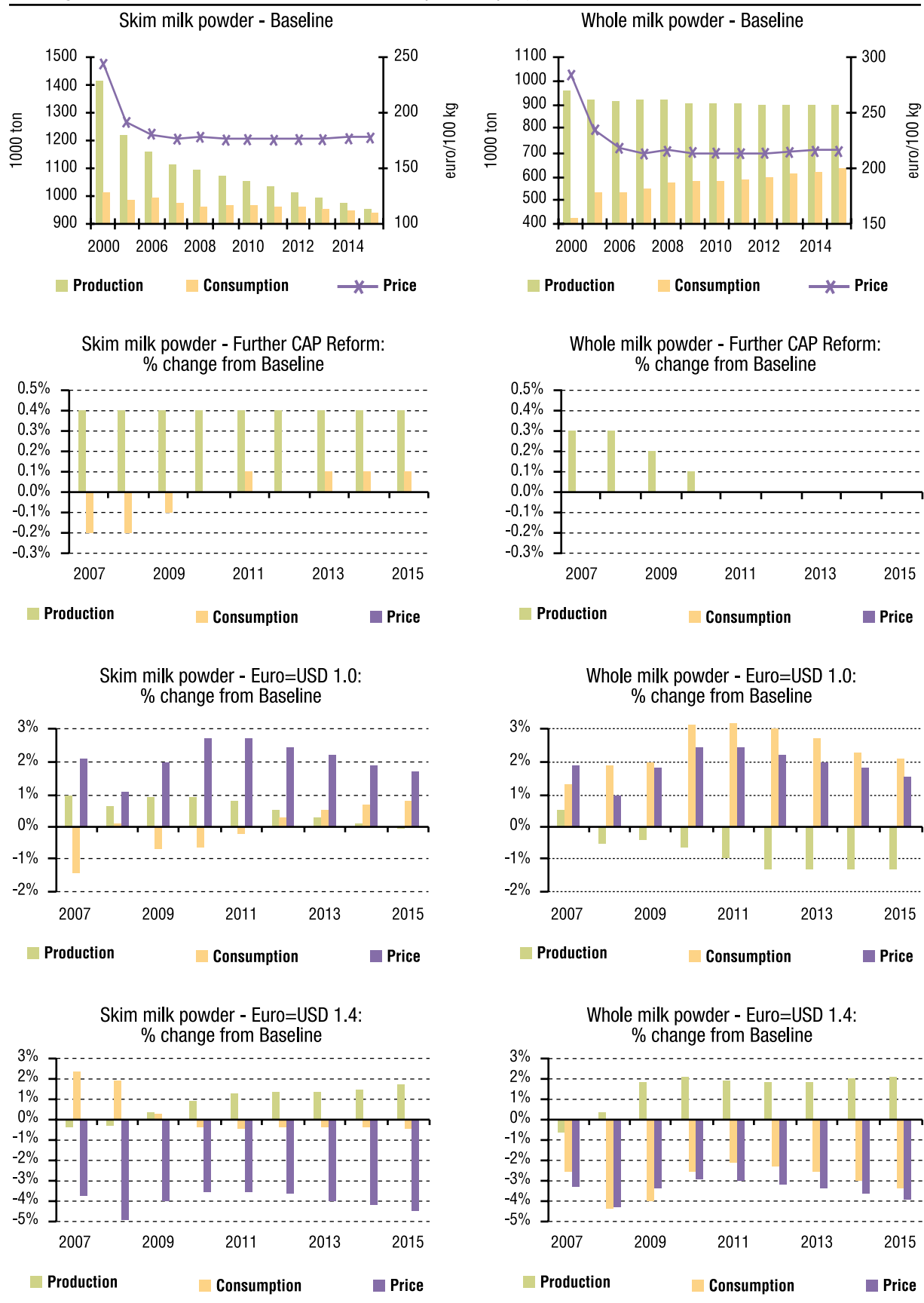

Source: AGMEMOD Country Models (2006)

Figure 4.9 Livestock products production and consumption in the EU-15, EU-10 and EU-25 under baseline

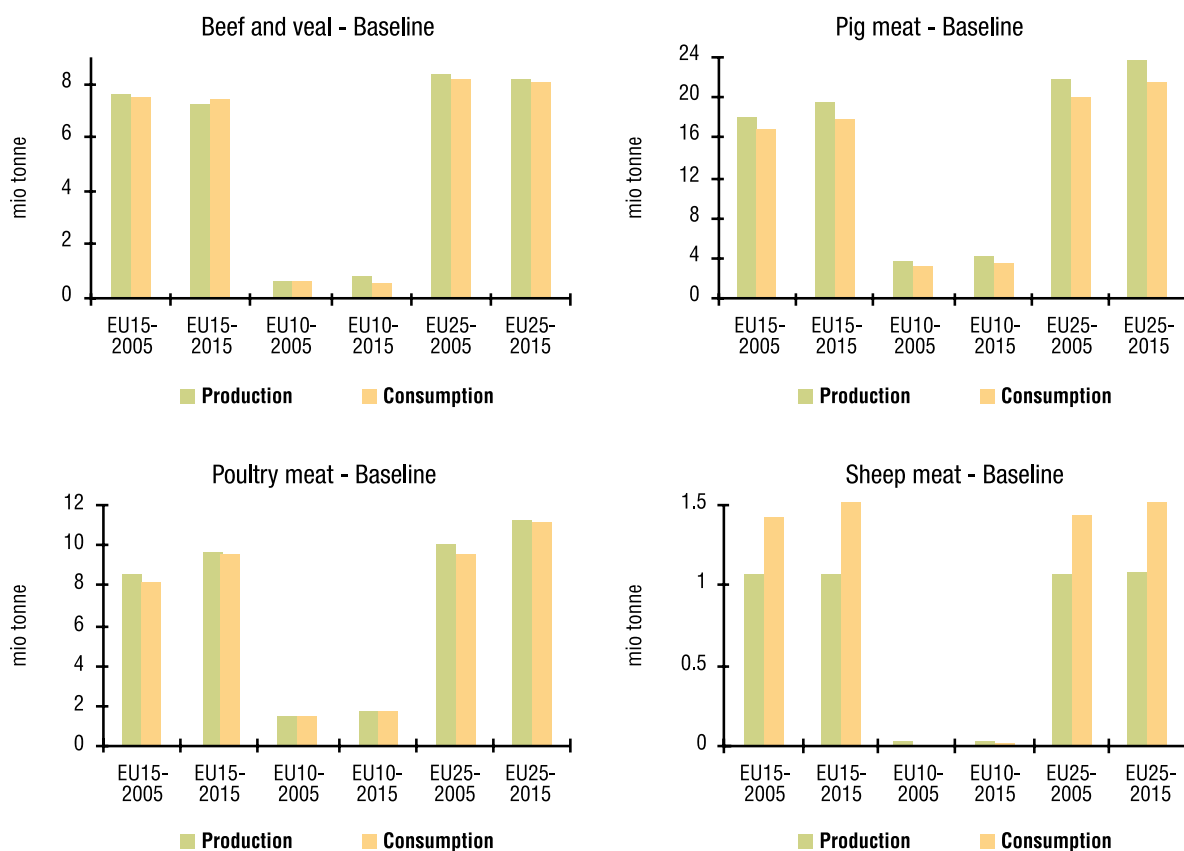

Source: AGMEMOD Country Models (2006)

Table 4.3 Self-sufficiency rates for livestock products in the EU-15, EU-10 and EU-25 under baseline

Self-sufficiency rate	Group	2000	2005	2006	2007	2008	2009	2010	2011	2012	2013	2014	2015
Beef and veal	EU15	1.03	1.02	1.02	1.03	1.03	1.01	1.00	1.00	0.99	0.99	0.98	0.98
	EU10	1.07	1.08	1.24	1.25	1.27	1.29	1.32	1.34	1.35	1.34	1.34	1.35
	EU25	1.04	1.02	1.04	1.05	1.05	1.04	1.03	1.03	1.02	1.01	1.01	1.01
Pig meat	EU15	1.11	1.09	1.07	1.06	1.06	1.07	1.08	1.08	1.08	1.08	1.08	1.09
	EU10	1.03	1.12	1.10	1.09	1.12	1.15	1.18	1.20	1.18	1.17	1.18	1.20
	EU25	1.10	1.09	1.08	1.07	1.07	1.08	1.09	1.10	1.10	1.10	1.10	1.11
Poultry meat	EU15	1.12	1.06	1.06	1.06	1.05	1.05	1.04	1.04	1.03	1.03	1.02	1.02
	EU10	1.02	1.01	1.03	1.04	1.04	1.03	1.03	1.02	1.02	1.02	1.02	1.01
	EU25	1.11	1.05	1.06	1.05	1.05	1.04	1.04	1.04	1.03	1.03	1.02	1.02
Sheep meat	EU15	0.80	0.74	0.74	0.75	0.74	0.73	0.72	0.72	0.72	0.71	0.70	0.70
	EU10	2.76	4.61	4.54	4.46	4.36	4.37	4.38	4.39	4.40	4.18	4.12	4.09
	EU25	0.81	0.75	0.76	0.76	0.76	0.74	0.73	0.73	0.73	0.73	0.72	0.71

Source: AGMEMOD Country Models (2006)

The EU-25 is expected to remain a net importer of sheep meat under the baseline, which is caused by a decreasing self-sufficiency rate (Table 4.3).

4.2.4. EU-15 and EU-10 - dairy products

Figure 4.10 divides the EU-25 projections for dairy products production and consumption under the baseline into an EU-15 and an EU-10 group. Butter production is projected to decline

Figure 4.10 Dairy products production and consumption in the EU-15, EU-10 and EU-25 under baseline

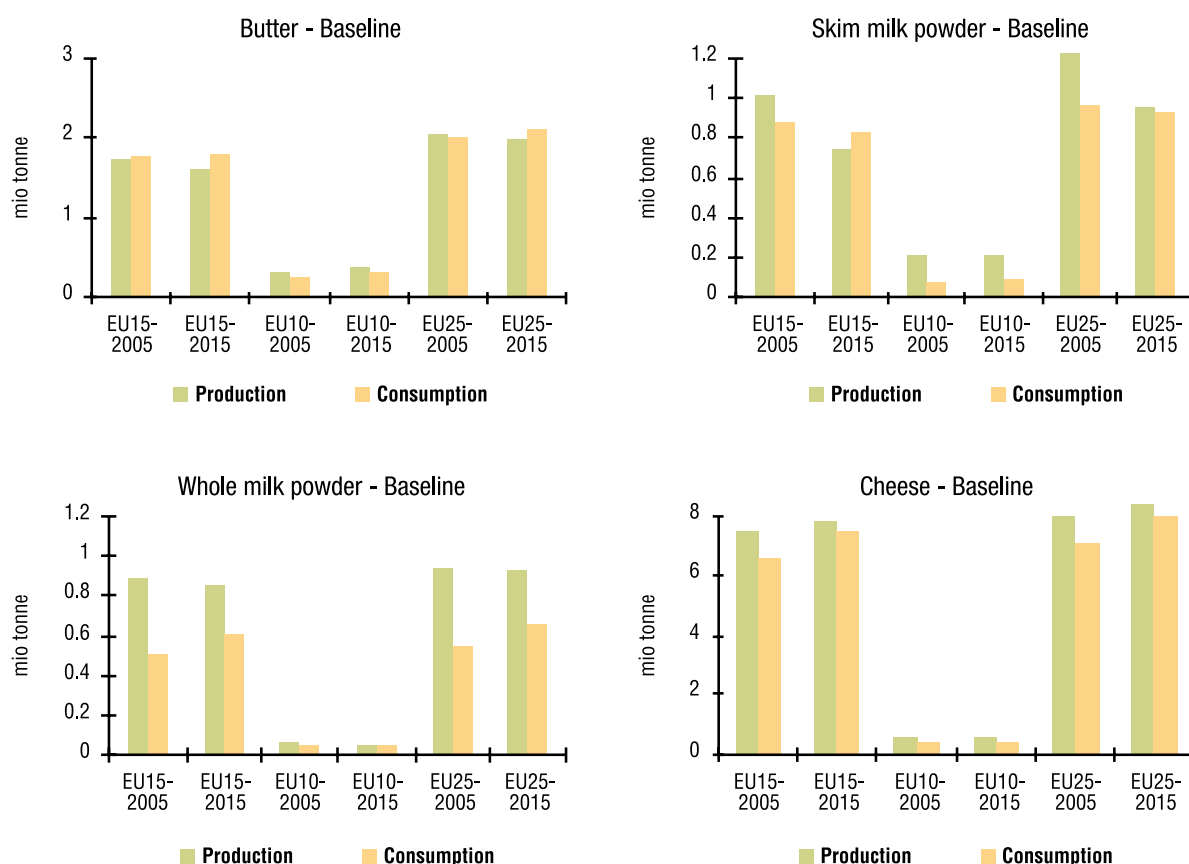

Source: AGMEMOD Country Models (2006)

Table 4.4 Self-sufficiency rates for dairy products in the EU-15, EU-10 and EU-25 under baseline

Self-sufficiency rate	Group	2000	2005	2006	2007	2008	2009	2010	2011	2012	2013	2014	2015
Butter	EU15	1.05	0.99	0.96	0.96	0.95	0.94	0.93	0.92	0.91	0.91	0.90	0.89
	EU10	1.18	1.25	1.23	1.23	1.24	1.23	1.23	1.24	1.24	1.25	1.25	1.26
	EU25	1.07	1.02	1.00	1.00	0.99	0.98	0.97	0.97	0.96	0.95	0.95	0.94
Skim milk powder	EU15	1.28	1.14	1.05	1.03	1.02	0.99	0.97	0.96	0.95	0.93	0.92	0.90
	EU10	2.77	2.42	2.58	2.60	2.57	2.51	2.46	2.40	2.35	2.29	2.24	2.19
	EU25	1.39	1.25	1.18	1.15	1.15	1.12	1.10	1.09	1.08	1.06	1.05	1.03
Whole milk powder	EU15	2.31	1.77	1.74	1.71	1.64	1.58	1.57	1.55	1.52	1.49	1.45	1.42
	EU10	1.64	1.50	1.37	1.39	1.38	1.37	1.36	1.34	1.33	1.32	1.31	1.30
	EU25	2.25	1.75	1.72	1.69	1.62	1.57	1.56	1.54	1.51	1.48	1.44	1.41
Cheese	EU15	1.16	1.13	1.12	1.11	1.09	1.08	1.07	1.07	1.06	1.05	1.04	1.04
	EU10	1.15	1.33	1.30	1.27	1.26	1.25	1.24	1.24	1.23	1.23	1.23	1.24
	EU25	1.16	1.14	1.13	1.12	1.10	1.09	1.08	1.08	1.07	1.06	1.05	1.05

Source: AGMEMOD Country Models (2006)

as a result of the impact of reduced intervention prices. The EU-25 self-sufficiency rate for butter will fall from 1.07 in 2000 to 0.94 in 2015, putting the EU in a net importer position. A similar development is seen with the self-sufficiency rate of milk powders and cheese, due to faster growth

in consumption levels than production levels (Table 4.4). The EU-25 net export situation for cheese is projected to decrease.

Appendix 1 presents figures with baseline results and scenario simulation impacts on livestock and dairy products in the EU-15 and EU-10 respectively.

Table 4.5 EU-25 output value, subsidies, feed costs and gross income in baseline¹⁾

	Unit	2000	2005	2006	2007	2008	2009	2010	2011	2012	2013	2014	2015
Agricultural output value	billion euro	136.8	131.8	129.0	131.9	136.2	137.2	138.3	137.7	137.4	139.3	141.4	143.7
Subsidies	billion euro	21.8	26.3	25.7	25.9	26.2	26.5	26.8	26.6	26.5	26.0	25.7	25.5
Feeding costs	billion euro	23.2	20.1	20.2	21.3	21.9	21.5	21.3	21.4	21.6	21.8	22.0	22.1
Gross agricultural income	billion euro	135.4	138.1	134.5	136.6	140.5	142.2	143.7	142.9	142.3	143.4	145.2	147.1

¹⁾ Only the commodities analysed in this study are taken into account (see list in section 1).

Source: AGMEMOD Country Models (2006)

Table 4.6 EU-25 output value, subsidies, feed costs and gross income in Further CAP Reform scenario (% change from baseline)

	2007	2008	2009	2010	2011	2012	2013	2014	2015
Agricultural output value	-0.1%	-0.1%	-0.2%	-0.2%	-0.3%	-0.3%	-0.3%	-0.4%	-0.4%
Subsidies	-8.7%	-8.4%	-8.4%	-8.4%	-8.5%	-8.9%	-9.9%	-10.1%	-10.4%
Feeding costs	4.8%	0.4%	0.1%	0.1%	0.0%	0.0%	-0.1%	-0.1%	-0.1%
Gross agricultural income	-2.5%	-1.7%	-1.8%	-1.8%	-1.9%	-2.0%	-2.1%	-2.1%	-2.1%

Source: AGMEMOD Country Models (2006)

4.3. Agricultural income

4.3.1. EU-25 – gross income

In general, the decoupling provisions of the Luxembourg Agreement lead to lower volumes of agricultural output, although the impacts of these projected developments on the agricultural output value are offset by price increases. Baseline projections show a 9 percent rise in agricultural output value between 2005 and 2015. Despite the phasing-in of the full value of the SFP supports in the EU-10, the amount of the EU-25 subsidies will reduce in value over the baseline projection period by 4 percent. The trend in gross agricultural income is upward, almost 7 percent higher in 2015 than in 2005 (see Table 4.5, in which only the agricultural output value, subsidies, feeding costs and gross agricultural income relating to the commodities in this study are covered).

The Further CAP Reform scenario would be expected to have a negative impact on the agricultural output value and agricultural income, since full decoupling of direct payments would lead to reductions in the volume of agricultural output produced. Furthermore, doubling the compulsory modulation rate will reduce the value of direct payments to farmers on account

of lower single farm payments (see Table 4.6). The output value falls as expected, although the magnitude of the decline compared to the baseline is quite small. The value of subsidies declines as the impact of the compulsory modulation of 10% from 2007 onwards is felt. By 2015, under the Further CAP Reform scenario the value of subsidies will be over 10 percent lower than under the baseline. Because of the only slight changes in the EU-25 livestock sectors, there are only minor changes in aggregate EU-25 expenditure on animal feeds. Overall, EU-25 gross agricultural income will be over 2 percent lower under the Further CAP Reform scenario than under the baseline by 2015.

Projections of gross agricultural income, agricultural output value, feeding costs and subsidy receipts under the Exchange Rate Change scenario fit with a priori expectations. The gross agricultural income for the EU-25 is higher under the Euro=USD1.0 scenario in which the exchange rate between euro and dollar is equal to the parity from 2007 onwards (see Figure 4.11).

The biggest driver of the change in income is the increased value of agricultural output when compared with the baseline between 2007 and 2015. The change in the exchange rate from

Figure 4.11 EU-25 output value, subsidies, feeding costs and gross income projections under exchange rate scenario

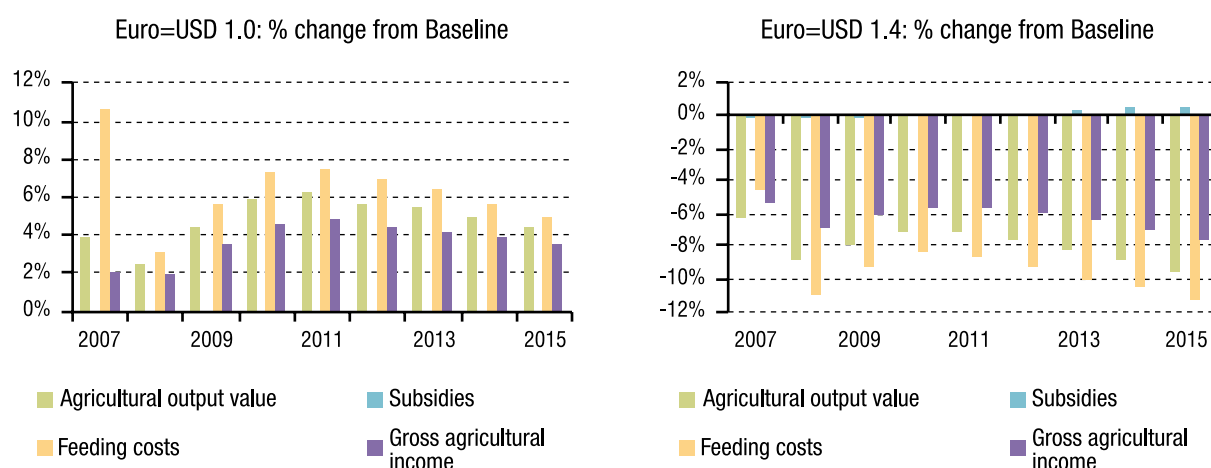

Source: AGMEMOD Country Models (2006)

Table 4.7 Agricultural output value, subsidies, feeding costs and agricultural income in the EU-15, EU-10 and EU-25 under baseline (2000=1)

	Group	2000	2005	2006	2007	2008	2009	2010	2011	2012	2013	2014	2015
Output value	EU15	1.00	0.94	0.91	0.93	0.95	0.96	0.96	0.96	0.96	0.97	0.99	1.00
	EU10	1.00	1.17	1.20	1.26	1.31	1.34	1.36	1.37	1.38	1.39	1.41	1.44
	EU25	1.00	0.95	0.93	0.95	0.98	0.98	0.99	0.99	0.99	1.00	1.01	1.03
Subsidies	EU15	1.00	1.09	1.05	1.04	1.03	1.02	1.01	1.01	1.00	0.99	0.98	0.97
	EU10	1.00	6.18	6.68	7.70	8.70	9.62	10.40	10.42	10.55	9.92	9.81	9.75
	EU25	1.00	1.21	1.18	1.19	1.20	1.21	1.22	1.22	1.21	1.19	1.18	1.17
Feeding costs	EU15	1.00	0.85	0.84	0.89	0.92	0.90	0.90	0.90	0.91	0.92	0.93	0.93
	EU10	1.00	1.00	1.08	1.14	1.17	1.16	1.16	1.18	1.19	1.20	1.21	1.23
	EU25	1.00	0.86	0.86	0.91	0.94	0.93	0.92	0.93	0.94	0.95	0.96	0.96
Agricultural income	EU15	1.00	0.98	0.95	0.96	0.97	0.98	0.98	0.98	0.97	0.98	0.99	1.01
	EU10	1.00	1.43	1.47	1.57	1.67	1.75	1.81	1.82	1.83	1.82	1.83	1.86
	EU25	1.00	1.01	0.98	0.99	1.02	1.03	1.04	1.03	1.03	1.04	1.05	1.06

Source: AGMEMOD Country Models (2006)

the baseline assumptions has no impact on the value of subsidies paid on products and only affects the expenditure on feed to the extent that the prices of cereals and oilseed products change, giving rise to a change in the demand for feed. The Euro=USD1.4 scenario simulation projections of total agricultural output value and gross agricultural income tie in with the *a priori* expectations in that the level of output value and gross agricultural income is lower than under the baseline.

4.3.2. EU-15 and EU-10 – gross income

The agricultural output values, subsidies, feeding costs and agricultural incomes only reflect the commodities included in this study. From 2005 to 2015, agricultural output value projections are expected to increase in the EU-15 (6%), EU-10 (27%) and EU-25 (8%). Due to the increase in the EU-10 subsidy level (by almost a factor four), the EU-25 agricultural income projection would increase by 5% in 2015 compared to 2005 (Figure 4.12 and Table 4.7).

■ Figure 4.12 Agricultural output value, subsidies, feeding costs and agricultural income in the EU-15, EU-10 and EU-25 under baseline

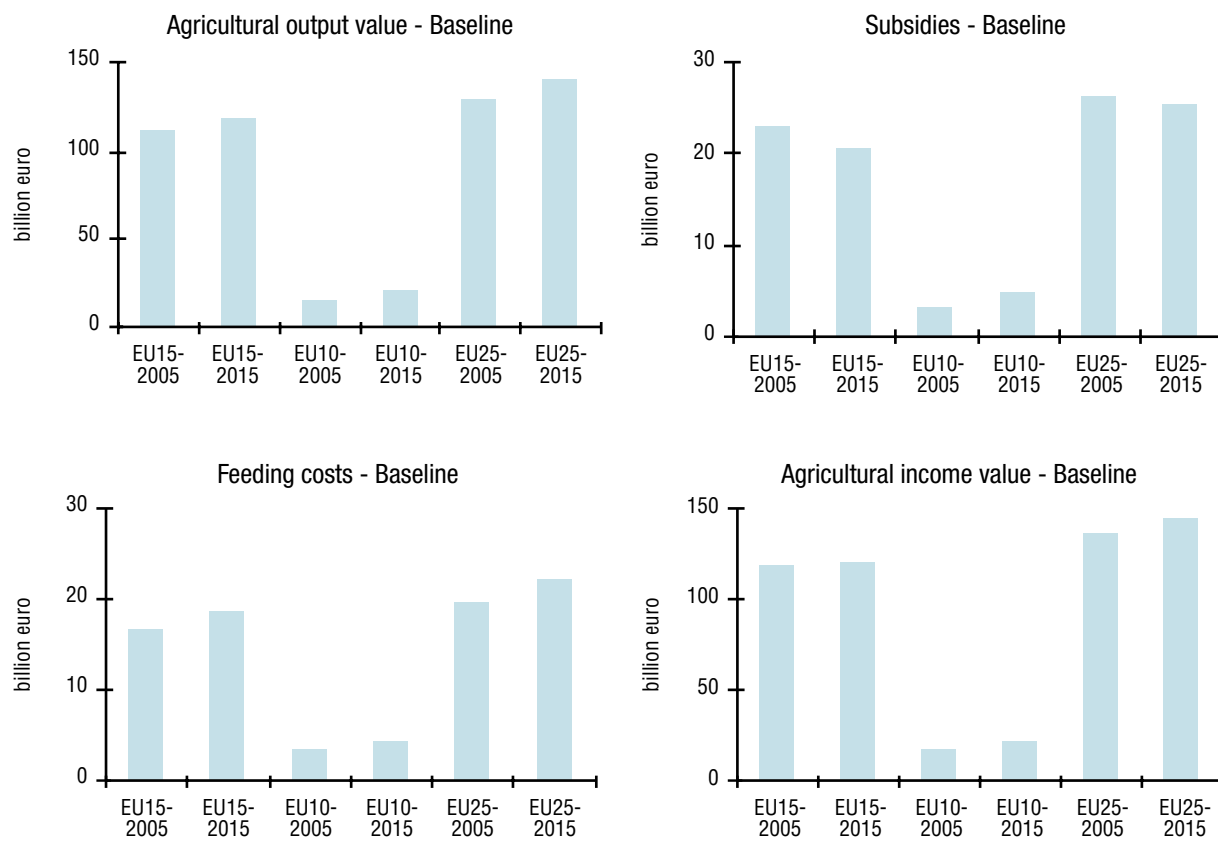

Source: AGMEMOD Country Models (2006)

■ 5. EU-27 baseline and scenarios projections

This section presents the results under the EU Enlargement scenario and a counterfactual Non-enlargement scenario. In contrast to the previous EU-25 section, attention is paid to the individual country results of Bulgaria and Romania. The availability of model results for all EU-27 countries facilitates the projection of the impact of the 2007 enlargement on the EU single market. The EU-25 baseline scenario results and the Bulgarian and Romanian Enlargement scenario results were combined to make a comparison between the EU-27 and the EU-25 baseline results. This gives insight into what EU-27 markets are likely to experience marked changes in supply and use.

5.1. Crops

5.1.1. Bulgaria and Romania – grains and oilseeds

Accession to the EU is projected to have a very positive effect on the Bulgarian crop sector. As a result of expected higher prices, and the significantly increased budgetary support that Bulgarian farmers will receive following accession, total grain production is projected to increase by nearly 11% when compared to the baseline for 2015. Within the grain sector, the increases under the Enlargement scenario are particularly notable for wheat and barley. In 2015, the production levels of these crops are expected to be 16% and 20% respectively above the baseline levels (see Figure 5.1). These growths in production result from both the increased area harvested and increased yields. Bulgarian maize production is projected to decline compared to the baseline, which is explained mainly by the negative relative change in the assumed maize price projections. Further technological developments in grains production, which are not fully integrated into the model, could improve the situation significantly.

Although the consumption of maize is projected to increase by 5%, the use of wheat

and barley is expected to fall by 2% and 3% respectively. The negative development in the domestic use of grains will increase the export potential of Bulgarian grain producers after accession. However, the likelihood of realising this potential is still limited by market deficiencies and high transport costs. Without changes in CAP policy, much of this production may be offered for sale into intervention.

Sunflower seed production is the prime Bulgarian oilseed culture. Under the Enlargement scenario strong growth in production is projected to occur (by 40% compared to the baseline). The main reason for this increase is the much higher support (although only 50% is considered coupled) offered to farmers compared to the baseline and the substantial price increase that is assumed to occur. The projected increase in Bulgarian oilseed production is a result of both increases in the area harvested (20%) and yields (2%). However, the higher production will also depend on the development and competitiveness of the Bulgarian processing industry. Investments and development in this sector will be necessary if the projected growth in oilseed production is to occur. On the other hand, Bulgaria is expected to strengthen its position as a net exporter of sunflower seeds following accession to the EU. The country could become at least a strong regional player in this sense. Furthermore, Bulgarian experts predict that, as a result of the projected price increases following accession, the per capita consumption of oilseeds will decline. Consequently, the total domestic use of oilseeds in Bulgaria is projected to be approximately 10% below the baseline level.

The higher prices and budgetary support for agriculture are projected to lead to an increase in Romanian grain production (+4%) and consumption (+6%). Wheat and barley production is expected to increase by 16% and 10% respectively when compared to the baseline

Figure 5.1 Crop production in Bulgaria and Romania under the Enlargement scenario (% change from baseline)

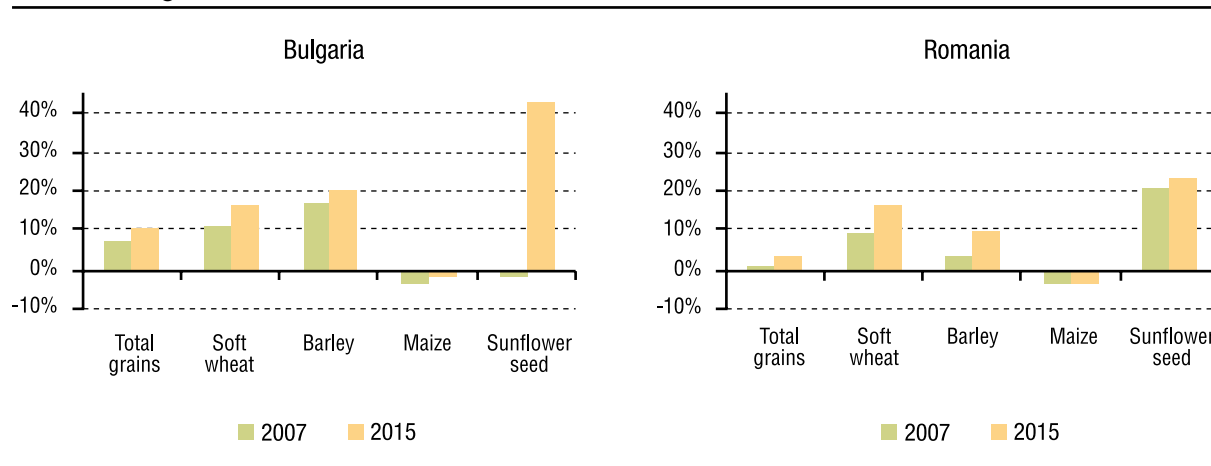

Source: Bulgarian and Romanian AGMEMOD Models (2006)

Table 5.1 Increase in EU-27 crop production (% change from EU-25 production)

	2007	2008	2009	2010	2011	2012	2013	2014	2015
Total grains	12.0	11.8	11.7	11.8	11.8	11.8	11.8	11.9	11.9
Soft wheat	9.7	9.5	9.6	9.6	9.7	9.6	9.7	9.8	9.9
Barley	6.5	6.6	6.6	6.6	6.7	6.7	6.7	6.8	6.8
Maize	31.7	30.5	29.8	29.6	29.3	29.0	28.7	28.4	28.1
Sunflower	49.5	57.9	57.6	57.6	59.3	61.5	61.6	62.9	64.0

Source: AGMEMOD Country Models (2006)

of non-enlargement. On the other hand, maize production could fall by 5% due to the impact of a projected negative relative price change for maize. Nevertheless, under the Enlargement scenario, Romania's maize production will still be 12% higher in 2015 than in 2004. The positive change projected in the domestic consumption of grains is linked to higher feed use of wheat and maize. These increases compensate for lower domestic use of barley. The growth in domestic consumption of grains in Romania (+25%) is due almost exclusively to increased feed use. Figure 5.1 presents the impact of enlargement on crop production in Bulgaria and Romania.

Under the Enlargement scenario, the largest increase projected to occur in Romania is in the production of sunflowers. Sunflowers are generally cultivated on fairly large farms that can afford better technology, certified seeds, mechanical operations and pesticide use. The 23% increase in production is mainly the result

of assumed technological development and is not due to any large change in the area of oilseeds harvested. Due to the large increase in the projected production, the prices of oilseeds in Romania are expected to decrease somewhat compared with the baseline. They will remain well below the international market price. Domestic consumption is expected to grow by 31%, due to increased demand for crushing, and sunflower oil exports will increase over the projection period.

5.1.2. EU-27 – grains and oilseeds

The accession of Romania and Bulgaria is projected to have a significant impact on the EU-27 single market in only a limited number of crop products (Table 5.1). One example of such a product is sunflower seed. With the accession of both countries, EU sunflower production could increase by two thirds. The EU-27 is projected to remain a net sunflower seed importer, although

the self-sufficiency rate is expected to increase (by 2015) from 67% in the case of no enlargement to 81% with the accession of Bulgaria and Romania. There should also be relevant changes in the grain sector, especially in maize production. The production of grains in the expanded EU-27 is projected to be almost 12% higher than in the EU-25 by 2015. However, the changes in the self-sufficiency rates are more limited since accession also increases EU domestic use and reduces exports (Table 5.2).

■ *Table 5.2 Self-sufficiency rates for crops in the EU-25 compared to the EU-27 in 2015*

	EU25	EU27
Total grains	1.16	1.17
Soft wheat	1.20	1.22
Barley	1.21	1.24
Maize	1.01	1.03
Sunflower	0.67	0.81

Source: AGMEMOD Country Models (2006)

5.2. Livestock and dairy products

5.2.1. Bulgaria and Romania – livestock products and milk

Bulgaria's accession to the EU is projected to lead to relatively unfavourable results in the livestock sectors compared to the baseline of non-enlargement. The only sector where positive developments are projected is the sheep sector. Specifically, country experts expect negative results for the Bulgarian milk sector, which would, given the production systems in Bulgaria, have strong negative consequences for beef production following accession to the EU.

The impact of accession on the Bulgarian sheep sector is positive in respect of both the number of breeding animals and the volume of projected lamb production. The projected growth in this sector is the result of the positive price change (+23% compared to the baseline) and a substantial increase in budgetary support for the sector. Sheep numbers are projected to be 28%

higher than in the baseline. A similar increase in the volume of lamb production is also expected. Generally, the domestic consumption of lamb is low (being mainly seasonal) and, accordingly, the price elasticity of lamb consumption is low. Due to this low own price elasticity, the price increase of lamb is not projected to have a significant impact on domestic consumption, and the growth in total domestic use under the Enlargement scenario is projected to be 5% higher than under the baseline.

The milk quota established in the accession negotiations undercut the Bulgarian dairy sector, and thus the potential for this relatively under-developed sector remains depressed. Under the Enlargement scenario, the Bulgarian milk production is projected to decline by 23% compared to the baseline. This drop is reflected in 28% lower cheese production than under the baseline. The negative changes are projected to occur in the first year following accession. Also, reductions in Bulgarian butter production are projected under the Enlargement scenario, although the level in 2015 is set to be only 1% less than under the baseline. There is little change expected in milk and dairy product consumption in Bulgaria. The milk production limitations associated with the imposition of the milk quota regime in Bulgaria following accession would lead to changes in the trade status of Bulgaria with respect to dairy commodities. From being a net exporter of cheese under the baseline, Bulgaria becomes a net importer of cheese under the Enlargement scenario.

Due to the dual purpose of beef production systems (i.e. beef is a joint product of milk production), the negative trends that are projected for the Bulgarian milk sector under the Enlargement scenario will also have a significant impact on beef production. As a result of the milk quota regime, the number of dairy cows will decline following accession, so that by 2015 the dairy cow stock in Bulgaria will be 24% lower than under the baseline. This reduction is reflected in falls in the total number of cattle (minus 13% by 2015). The impact of the milk quota system on Bulgarian beef

production is greater than the effect of the projected increase in cattle prices and the higher level of budgetary support for the beef sector. However, the increased slaughter weights projected under the Enlargement scenario (in response to higher cattle prices) moderate somewhat the negative impact of the milk quota system on beef and veal production. Bulgaria's beef production is projected to decline by only 4% compared with the baseline. The negative impact of the price increases on the per capita consumption of beef will be largely offset by increases in income. Nevertheless, the per capita beef consumption is projected under the Enlargement scenario to be 4% lower than under the baseline. As a result of the drop in production, the trade position of the Bulgarian beef sector will worsen and Bulgaria will remain a net importer of beef.

The Bulgarian pork and poultry sectors are less competitive and are expected to remain parts of the subsistence rural economy of Bulgaria following accession. As a consequence of the mainly subsistence nature of Bulgarian pig and poultry production, the impact of the Enlargement scenario compared to the baseline will be limited. Generally, pork and poultry production is lower under the Enlargement scenario than under the baseline (minus 4% and 1%). The higher increase in feed prices projected to occur compared to the prices of livestock output leads to projected drops in Bulgarian pork and poultry production. The subsistence nature means that the opportunities for increases in productivity to offset the negative impact of increased feed costs are limited. After an initial decline in domestic pork consumption due to price increases, the domestic consumption per capita will increase by 5% compared to the baseline. In contrast to pork, poultry price increases following accession will be higher than under the baseline, and thus domestic use of poultry in Bulgaria is projected to be 1% lower than under the baseline. Bulgaria will remain a net importer of pork and poultry.

Under the EU Enlargement scenario, the imposition of the EU milk quota system in

Romania is projected to have a strong negative impact on its dairy sector. Romania's 2006 production was almost double the agreed milk quota. As a consequence, milk production following accession to the EU will be 45% lower than under the baseline in 2015. Due to increases in yields and the milk quota system, dairy cow numbers are projected to decrease substantially over the period from 2005 to 2015. Approximately 47% of the 2006 dairy cow stock could produce the agreed milk quota at 2006 (relatively low) milk yields. Subsistence dairy farming will remain important and the commercialisation process will not happen rapidly. Since production is limited by quota, the projected price increase will not lead to any expansion in commercial milk production. Major investment is necessary in the sector in order to comply with the quality, hygiene and veterinary requirements for raw milk, which could further depress the economic position of the less developed parts of the dairy sector in Romania. The income growth projected for Romania after accession should lead to increased demand for dairy products. The decline in milk supply will push up imports of dairy commodities after accession.

Romania's accession to the EU is expected to lead to market specialisation in beef and dairy production systems. Higher subsidies will provide a strong incentive for increased investment in beef breeds, which will replace over time the current more dual-purpose breeds. This will increase Romanian beef production. The export potential for beef should also grow due to structural changes in slaughtering supported by EU rural development funds. Domestic beef consumption is projected to increase after accession. This favourable development scenario for Romanian beef is based on the hypothesis that, due to the restrictive milk quota, increased specialisation will occur in the dairy and beef sectors and that the overall cattle herd will not be reduced significantly.

The pork sector is very important in Romanian agriculture. The sector is recovering

Figure 5.2 Livestock production in Bulgaria and Romania under the Enlargement scenario (% change from baseline)

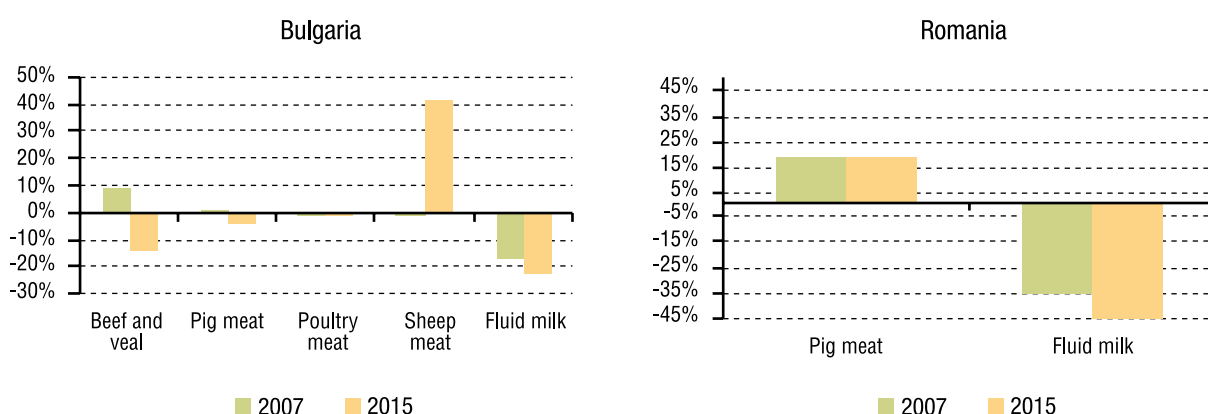

Source: Bulgarian and Romanian AGMEMOD Models (2006)

Table 5.3 Increase in EU-27 livestock production (% change from EU-25 production)

	2007	2008	2009	2010	2011	2012	2013	2014	2015
Beef and veal	4.2	4.3	4.3	4.5	4.6	4.7	4.9	5.0	5.1
Pig meat	3.2	3.2	3.1	3.1	3.0	3.0	3.0	3.0	3.0
Fluid milk	3.2	3.2	3.2	3.2	3.2	3.1	3.1	3.1	3.1

Source: AGMEMOD Country Models (2006)

from the closing of the former large collective farms. Thus, the country has since been a net pork meat importer. The production of pork is projected under the Enlargement scenario to increase significantly (+19%), as is domestic consumption. The increased demand and higher prices are expected to provide incentives for the expansion of pork production. Domestic supply will remain below demand, and thus Romania is projected to remain a net importer of pork.

Figure 5.2 presents the impact of enlargement on livestock production in Bulgaria and Romania. As the Romanian beef market model is still under development, no projection results are shown for this sector.

5.2.2. EU-27 – livestock products and milk

Compared to the projected impacts on the grain and oilseed markets, the accession of Bulgaria and Romania is projected to have only

limited impacts on the EU-27 livestock markets compared to what is expected to occur in the absence of accession. The changes in production at EU-27 level are limited to between almost 3% for pig meat and almost 5% in the beef and veal sector (Table 5.3). Due to the fact that Romania and Bulgaria are net food importers for pig meat and dairy products and due to the projected increase in domestic use in both countries, enlargement should decrease the self-sufficiency level by 3% for fluid milk and by 1% for pig meat (Table 5.4).

Table 5.4 Self-sufficiency rates for livestock products in the EU-25 compared to the EU-27 in 2015

	EU25	EU27
Beef and veal	1.01	1.01
Pig meat	1.11	1.10
Fluid milk	1.79	1.74

Source: AGMEMOD Country Models (2006)

Figure 5.3 Agricultural output, subsidies and income in Bulgaria and Romania under the Enlargement scenario (% change from baseline)

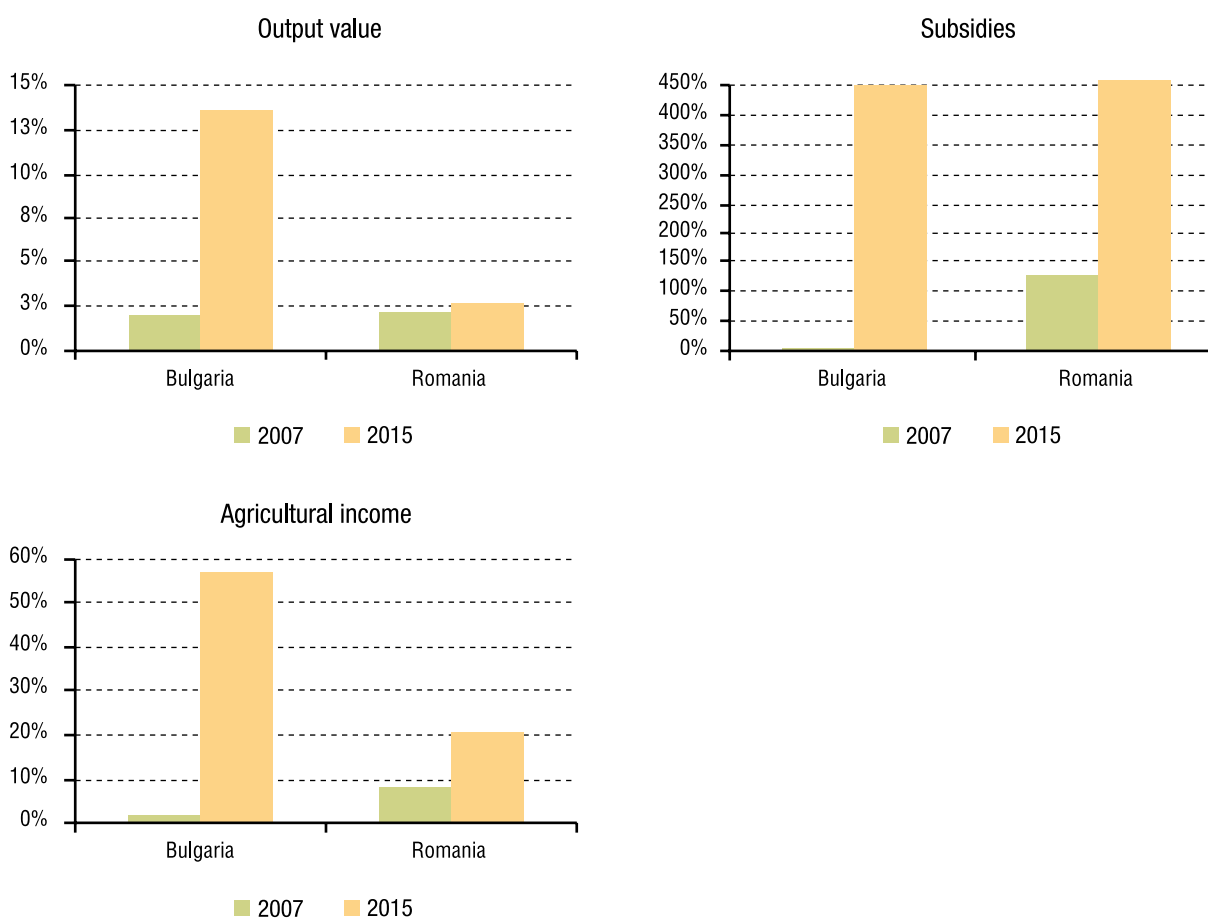

Source: Bulgarian and Romanian AGMEMOD Models (2006)

5.3. Agricultural income

5.3.1. Bulgaria and Romania – gross income

Under the EU Enlargement scenario, agricultural income is expected to be higher than under the baseline of non-enlargement. Bulgaria's gross agricultural income is projected to increase by 56% compared to the level projected under the baseline (see Figure 5.3). This projected increase in sectoral income is due mainly to the substantially higher subsidy receipts (by a factor of almost 4.5) and to a lesser extent to the projected increase in the value of agricultural output produced in Bulgaria, which increases by 13% when compared with the baseline.

An important benefit of accession to the EU for Romanian agriculture is an improvement in the economic situation for the majority of the

agricultural sectors. According to the Romanian modelling results, gross agricultural income is projected to increase after accession by 21%. This is largely due to the substantial increase in subsidy receipts (more than five-fold). Expected production and price increases for most products will also contribute to the expansion in sectoral income. The share of subsidies in output value doubles over the Enlargement scenario projection period (from 9% to 18%). Direct payment receipts by the Romanian agricultural sector in the first year of enlargement are almost double the equivalent subsidies received in 2004-2005. The increased payments subsidised agricultural products are not expected to have an immediate impact on production, but will contribute gradually to significant and necessary improvements in technology and farm efficiency.

Table 5.5 Agricultural output value, subsidies and agricultural income in the EU-25 and EU-27 (2007=1.0)

	group	2007	2008	2009	2010	2011	2012	2013	2014	2015
Output value	EU25	1.00	1.03	1.03	1.04	1.04	1.04	1.05	1.07	1.08
	EU27	1.00	1.03	1.04	1.04	1.04	1.04	1.05	1.07	1.09
Subsidies	EU25	1.00	1.01	1.02	1.03	1.03	1.02	1.00	0.99	0.98
	EU27	1.00	1.01	1.03	1.04	1.04	1.04	1.03	1.02	1.02
Agricultural income	EU25	1.00	1.02	1.03	1.04	1.04	1.04	1.04	1.06	1.07
	EU27	1.00	1.03	1.04	1.05	1.04	1.04	1.05	1.06	1.08

Source: AGMEMOD Country Models (2006)

5.3.2. EU-27 – gross income

As regards the EU-25, the agricultural output value, subsidies and agricultural income in Table 5.5 only reflect the commodities included in this study. For the EU-27, the commodity coverage of Bulgaria and Romania is even more limited.

Bulgaria and Romania entered the EU on 1 January 2007. In the period 2007-2015, EU-27 agricultural output value is projected to increase

by 9%, which is one percentage point more than growth in the EU-25. The subsidy level would rise from 26 billion euro in 2007 for the EU-25 to 28 billion euro in 2015 for the EU-27. Without Bulgaria and Romania the EU subsidy amount would decrease by 2% over that period. Due to the increase in the subsidy level in the EU-27, agricultural income is projected to be somewhat higher than the corresponding EU-25 level.

■ 6. Discussion and Conclusions

The main objective of the study ‘Impact analysis of CAP reform on the main agricultural commodities’ was to provide projections and simulations for individual EU Member States, the EU-10, the EU-15, the EU-25 and the EU-27 as a whole, with the emphasis on supply, demand, trade and prices for a set of commodities. In addition, impacts of selected scenarios regarding the further decoupling of direct payments, the enlargement of the EU and sensitivity analysis of exchange rate shocks were assessed. To this end, the AGMEMOD modelling approach has been improved, implemented in standard computer software and applied.

The baseline and scenario analyses up to 2015 were conducted with the participation of 22 country teams. In this final section we summarise conclusions with regard to the overall results for EU and their implications for the policy reforms examined and the model used.

Report II “AGMEMOD - Member States Results” provides detailed baseline projections and scenario impact analyses of agricultural commodity markets for individual EU Member State modelled from 2005 up to 2015.

The AGMEMOD baseline results indicate that – in spite of decoupling – EU production will grow in several sectors over the period 2005 to 2015. In the crop sector EU-25 production of wheat and maize will increase. This reflects a land use shift from barley to wheat, which will generate better gross margins. Increase in consumption will lead to a decline in net exports. A higher dynamics can be found in the oilseed sector, with demand propelling the markets and sustaining expanded supply to the effect that net imports are virtually unchanged throughout the projection period.

Under the baseline, the introduction of decoupling will induce a further decline in beef and lamb production. However, the price increases that result from contraction in

indigenous production within the EU-25 are likely to lessen the negative impact of decoupling on production. The other livestock sectors (pig meat and poultry) are largely unaffected by decoupling except in so far as changes in the prices of beef and lamb cause demand for other meats to increase and thereby lead to increases in prices. Pig and poultry production are both projected to expand in the aggregated EU-25. Growth in demand is sufficient to maintain pig meat prices, but poultry meat prices are projected to decline. The EU dairy production is expected to decline as a consequence of the reductions in intervention prices for dairy products, but milk quotas will be fulfilled. Butter and skimmed milk powder production will decrease and at the same time growth in the production of cheese is projected. The reduced wholesale and consumer prices and the higher economic growth in the EU-10 will help domestic consumption in the EU-25 to increase.

In general, the Further CAP Reform scenario results tie in with *a priori* expectations in that the impact of the scenario is very limited. This arises, at least in part, from the fact that many Member States had already chosen to largely decouple direct payments in implementing the Luxembourg Agreement at national level. However, it must be acknowledged that the limited impact of decoupling on EU agricultural production, both in the baseline and in the Further CAP Reform scenario, is also in part due to the method of implementing decoupled single farm and simplified area payments in the AGMEMOD country models. The method of implementing the SFP and the SAPS in each country model was to construct synthetic premiums that maintained some of the supply-inducing impact of the previously coupled direct payment systems, but also to try to capture the effects of the distributional shift of the payments. The reasons behind this approach were that, even with the

decoupling of direct payments, cross-compliance criteria and other “good farming practice” requirements, and the linking of the SFP and SAPS payments to land, would mean that the SFP and SAPS payments would still, *ceteris paribus*, maintain some incentive to produce even though they were decoupled from production. It could be argued that the synthetic premiums employed in the AGMEMOD country models at this point are too close (in value terms) to the previously coupled (Agenda 2000) direct payments, and that thus the impacts of decoupling in both the baseline and the Further CAP Reform scenario are understated.

The 2007 enlargement of the EU that occurred with the accession of Romania and Bulgaria is not expected to dramatically change the situation on most key agricultural markets. There are increases projected for the production of EU sunflower oil, soft wheat and maize. Due to low prices in Romania and Bulgaria and the ongoing logistics problems in getting arable crops to world and EU markets (i.e. large volumes of intervention purchases), problems are predictable if no further changes in the EU market organisation mechanisms are made. The 2007 accession is projected to have less of an impact on livestock and meat markets.

This study has made a considerable contribution to improving the AGMEMOD modelling approach, e.g. implementation of the decoupled payments system, combination of old Member States models into an EU-15 version and the provision of market projections for 25 EU Member State. Despite the series of new features, the AGMEMOD tool will be further improved in the future.

Future investigations will include:

- exploration of the impact of differing assumptions with respect to the supply-inducing impact of decoupling;
- incorporation of the feedback impact of changes in EU net trade on international markets; and
- exploration of the impact of biofuel production on EU agriculture.

In conclusion, it can be said that the achievements of this study contribute to the discussions relating to changes in EU and international agricultural and trade policies and their impact analysis at both the EU and the Member States level.

■ 8. References

- Agricultural Economics Research Institute (2005). "Impact analysis of CAP reform on the main agricultural commodities." Report 1a on Intended Research Techniques. First deliverable of contract No 150267-2005-FIED-NL.
- Agricultural Economics Research Institute (2006). "Impact analysis of CAP reform on the main agricultural commodities." Report 1b on Developed Research Techniques. Second deliverable of contract No 150267-2005-FIED-NL.
- Agricultural Economics Research Institute (2006). "Impact analysis of CAP reform on the main agricultural commodities." Report 2 on Assumptions and Baseline Results of Country and EU 25/27 Aggregate Models. Third deliverable of contract No 150267-2005-FIED-NL.
- Agricultural Economics Research Institute (2006). "Impact analysis of CAP reform on the main agricultural commodities." Report 3 on Scenarios to be Analysed. Fourth deliverable of contract No 150267-2005-FIED-NL.
- Agricultural Economics Research Institute (2006). "Impact analysis of CAP reform on the main agricultural commodities." Report 4 on Baseline and Scenario results of country and EU 25/27 aggregate models. Fifth deliverable of contract No 150267-2005-FIED-NL.
- Agricultural Economics Research Institute (2007). "Impact analysis of CAP reform on the main agricultural commodities." Final Report. Sixth deliverable of contract No 150267-2005-FIED-NL.
- DoI, W. (2006). "GSE Quick reference guide." LEI, The Hague.
- FAPRI (2006). "FAPRI 2006 US and World Outlook." Iowa State University and the University of Missouri-Columbia. Available for download from www.fapri.org.
- Hanrahan, K. F. (2001). "The EU GOLD MODEL 2.1." An introductory manual, Working Paper.
- Hennessy, T. C. and F. S. Thorne (2005). "How decoupled are decoupled payments? The evidence from Ireland." *EuroChoices* 4 (3), pp 30-35.

9. Appendix 1 Baseline projections and scenario impacts in EU-15 and EU-10

Figure A 1 EU-15 and EU-10 soft wheat projections under baseline and scenarios

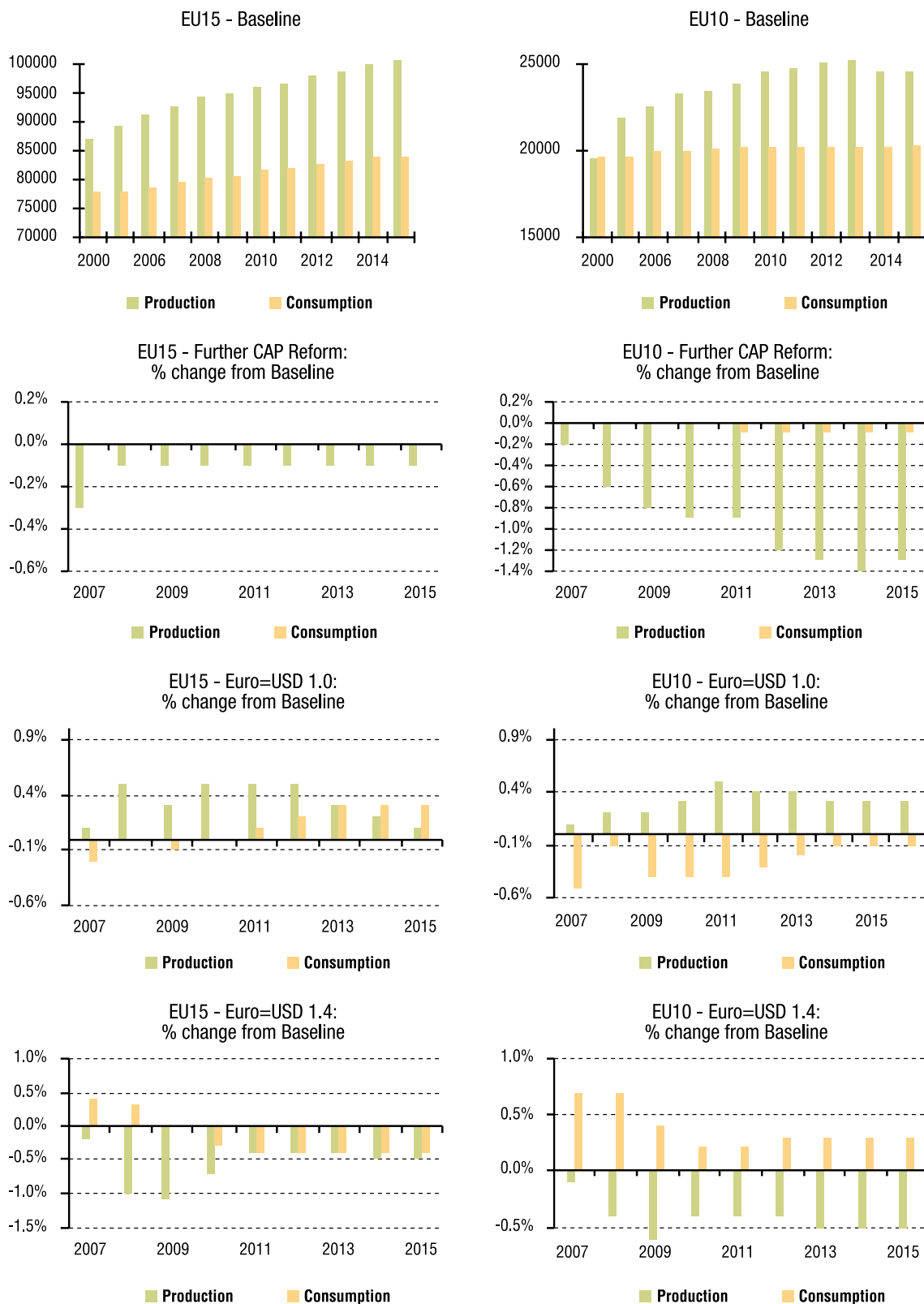

Source: AGMEMOD Country Models (2006)

Figure A 2 EU-15 and EU-10 barley projections under baseline and scenarios

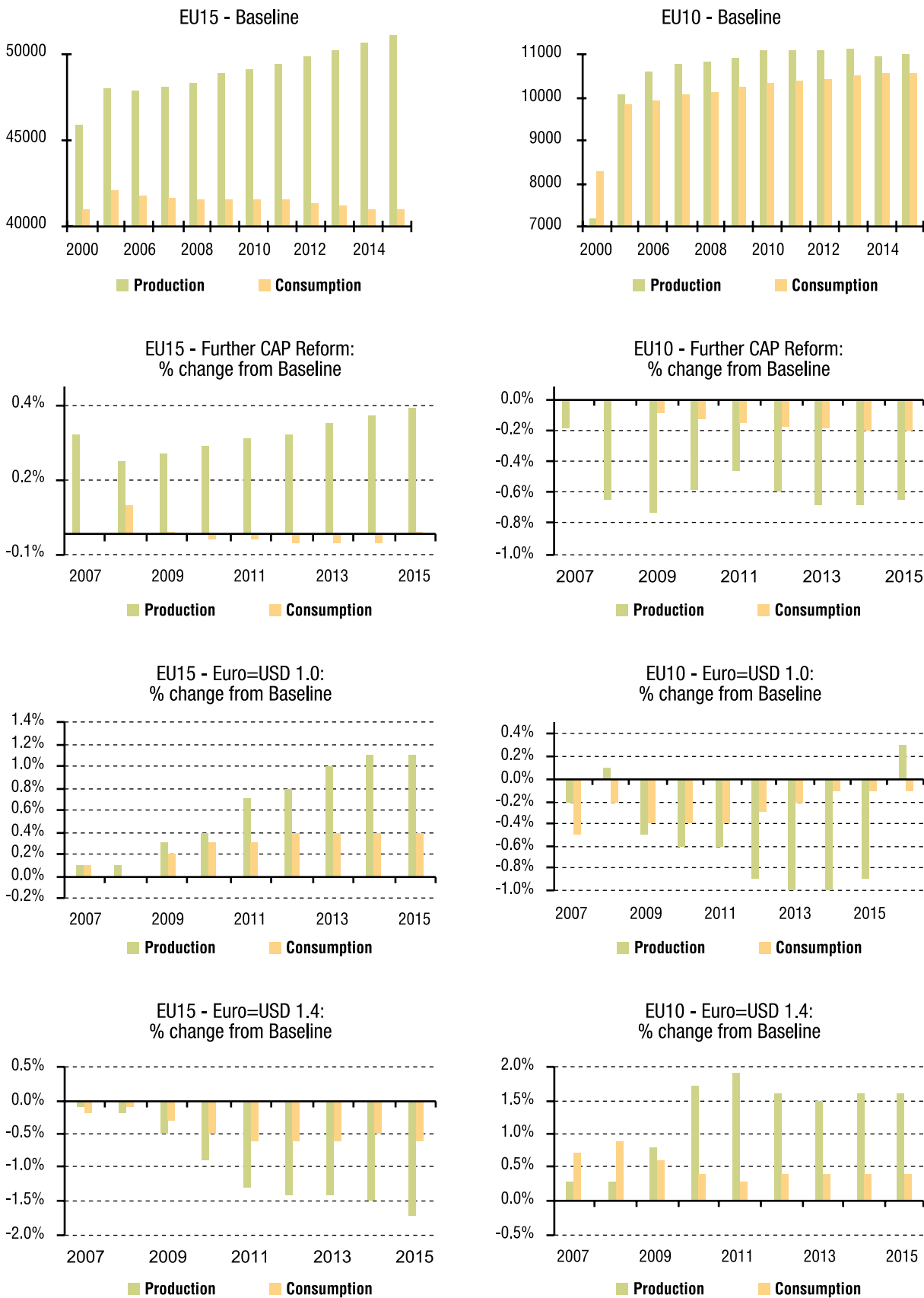

Source: AGMEMOD Country Models (2006)

Figure A 3 EU-15 and EU-10 maize projections under baseline and scenarios

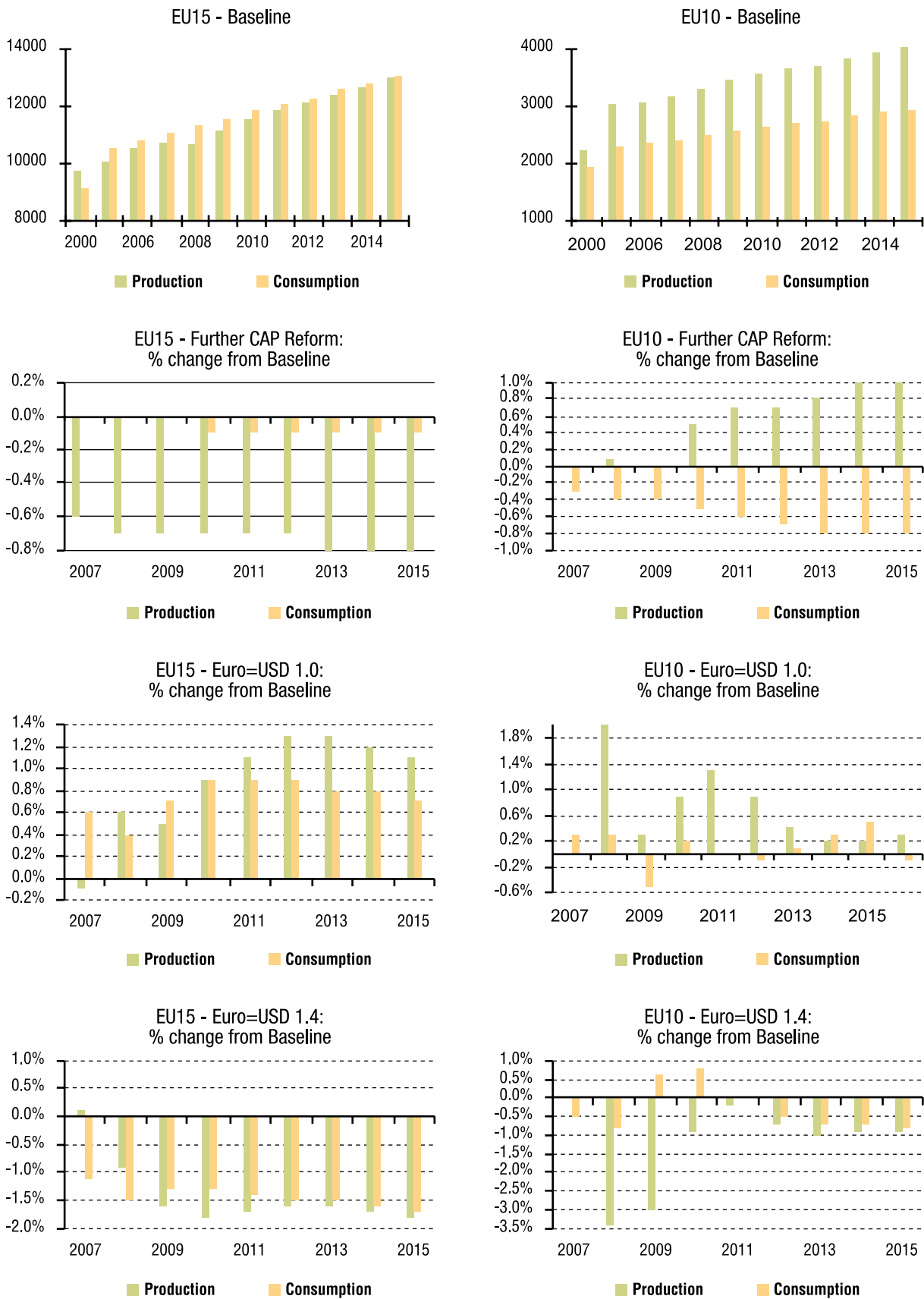

Source: AGMEMOD Country Models (2006)

Figure A 4 EU-15 and EU-10 rapeseed projections under baseline and scenarios

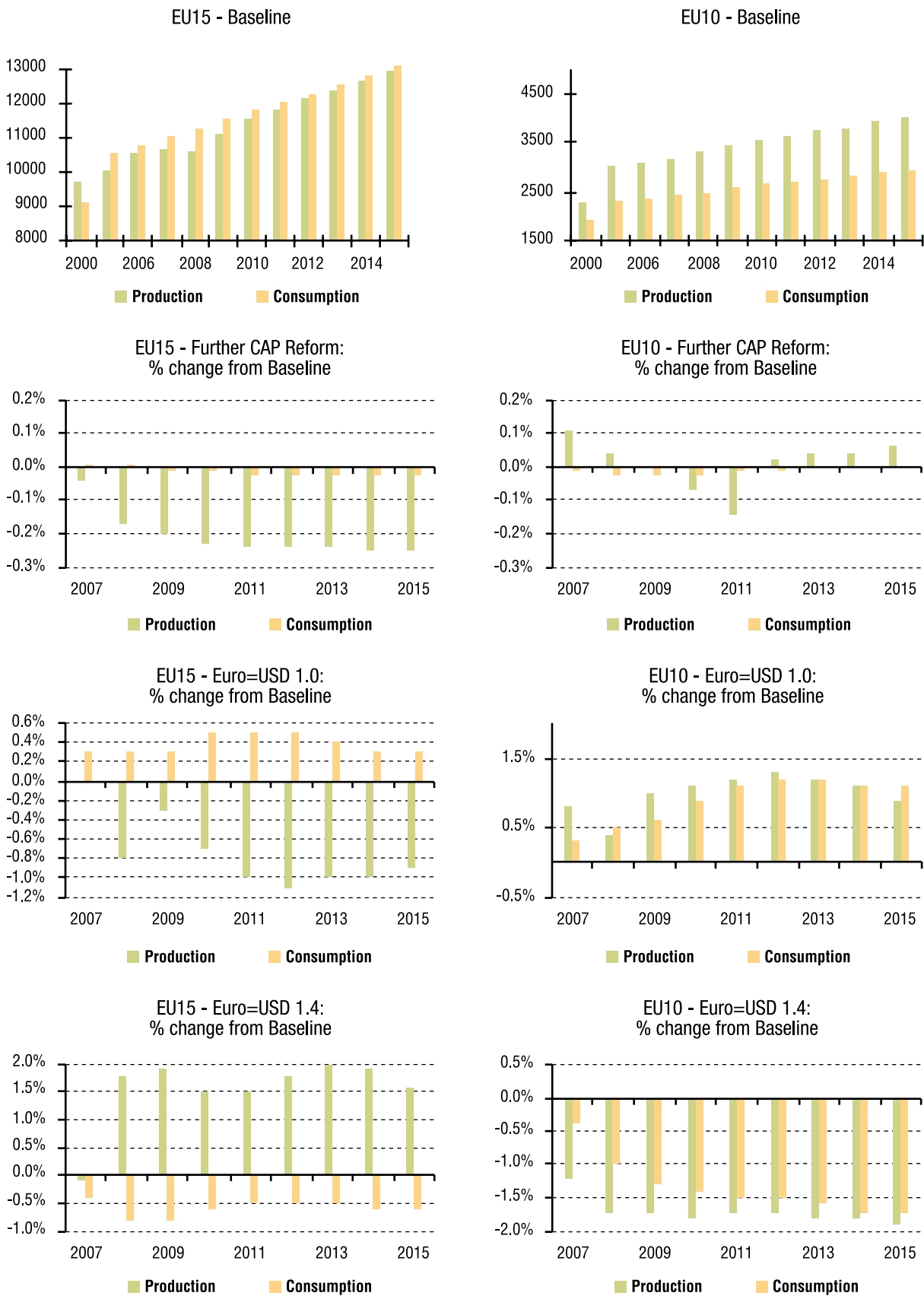

Source: AGMEMOD Country Models (2006)

Figure A 5 EU-15 and EU-10 sunflower projections under baseline and scenarios

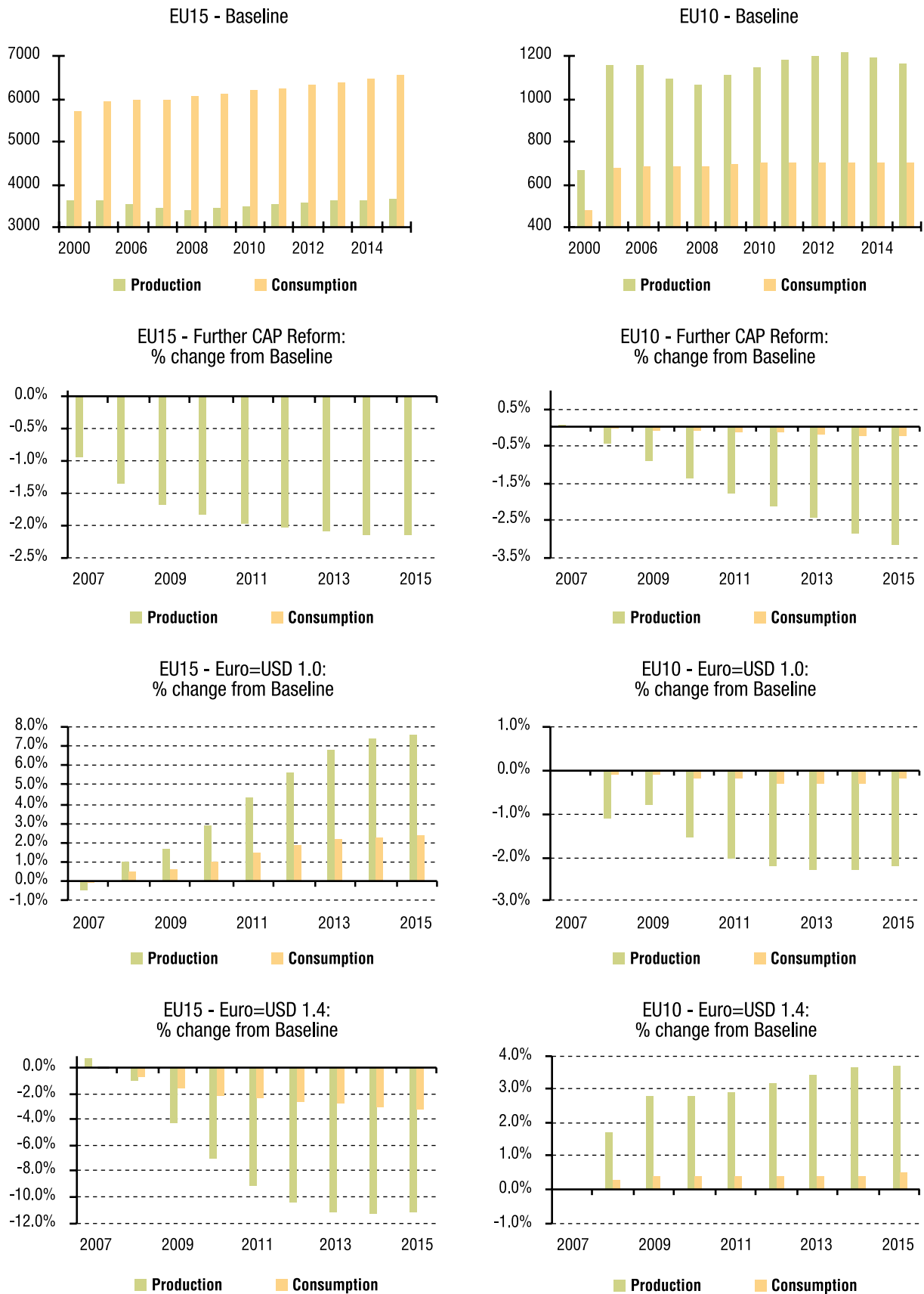

Source: AGMEMOD Country Models (2006)

Figure A 6 EU-15 and EU-10 soybean projections under baseline and scenarios

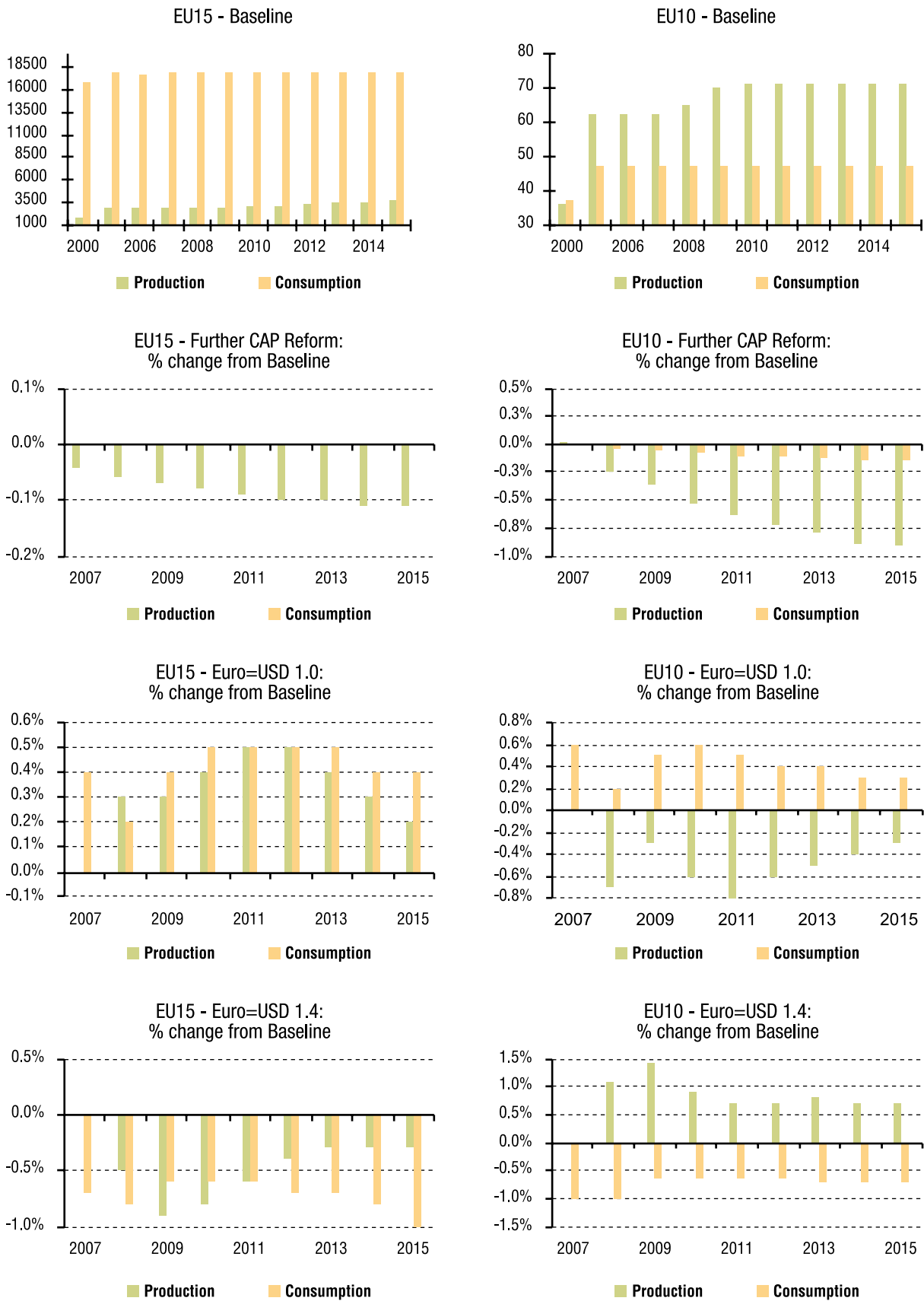

Source: AGMEMOD Country Models (2006)

Figure A 7 EU-15 and EU-10 beef and veal projections under baseline and scenarios

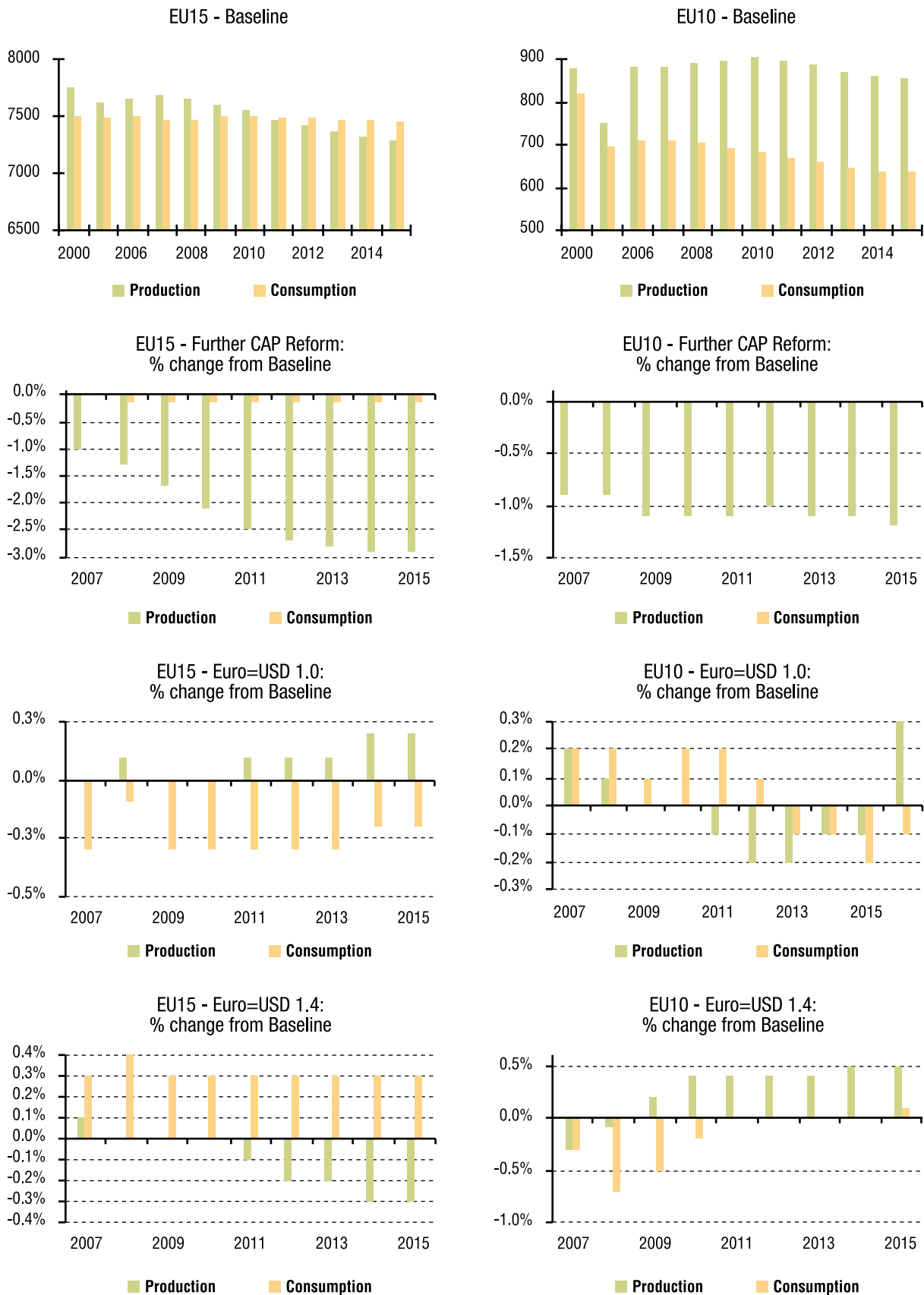

Source: AGMEMOD Country Models (2006)

Figure A 8 EU-15 and EU-10 pig meat projections under baseline and scenarios

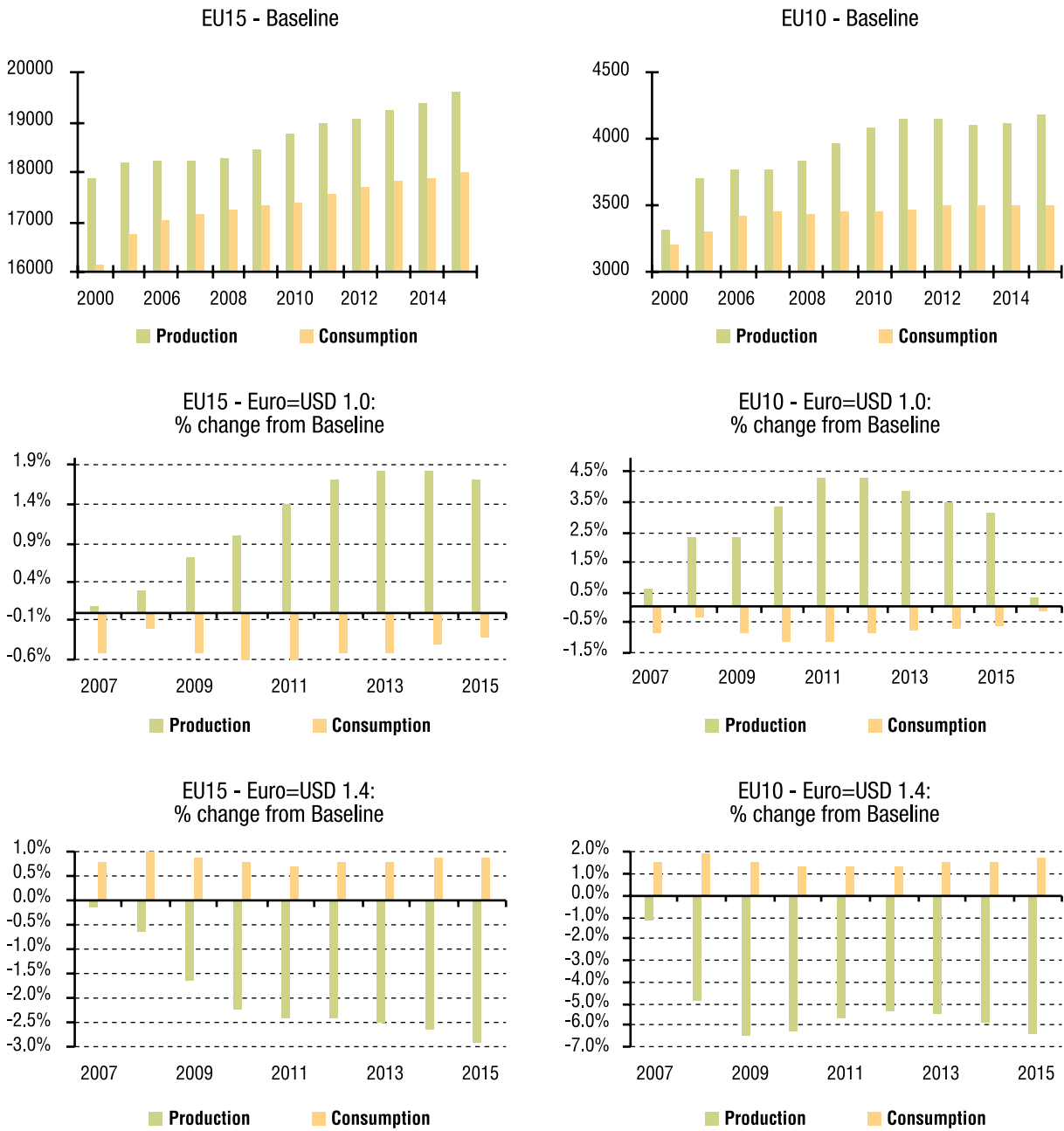

Source: AGMEMOD Country Models (2006)

Figure A 9 EU-15 and EU-10 poultry meat projections under baseline and scenarios

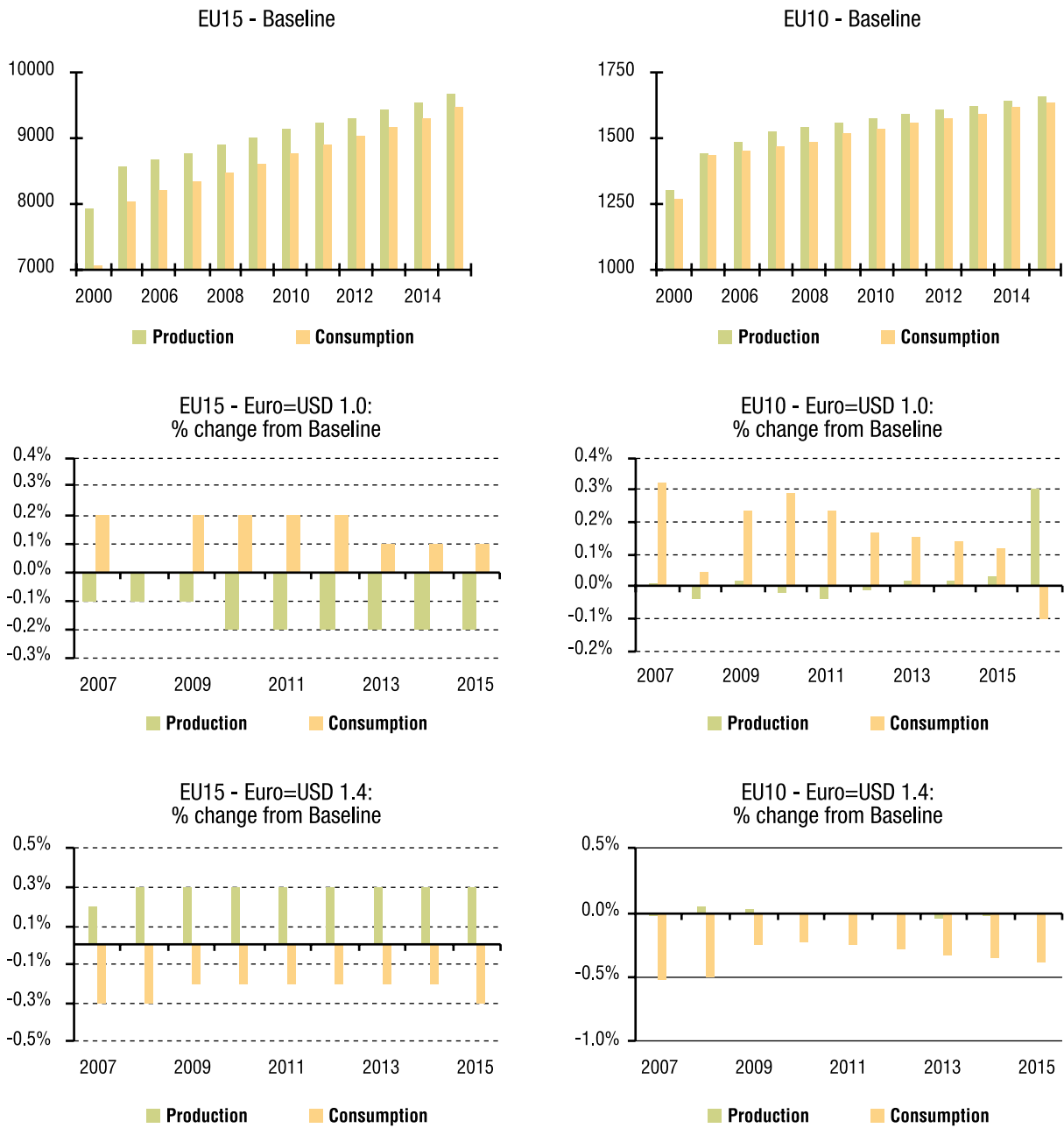

Source: AGMEMOD Country Models (2006)

Figure A 10 EU-15 and EU-10 sheep meat projections under baseline and scenarios

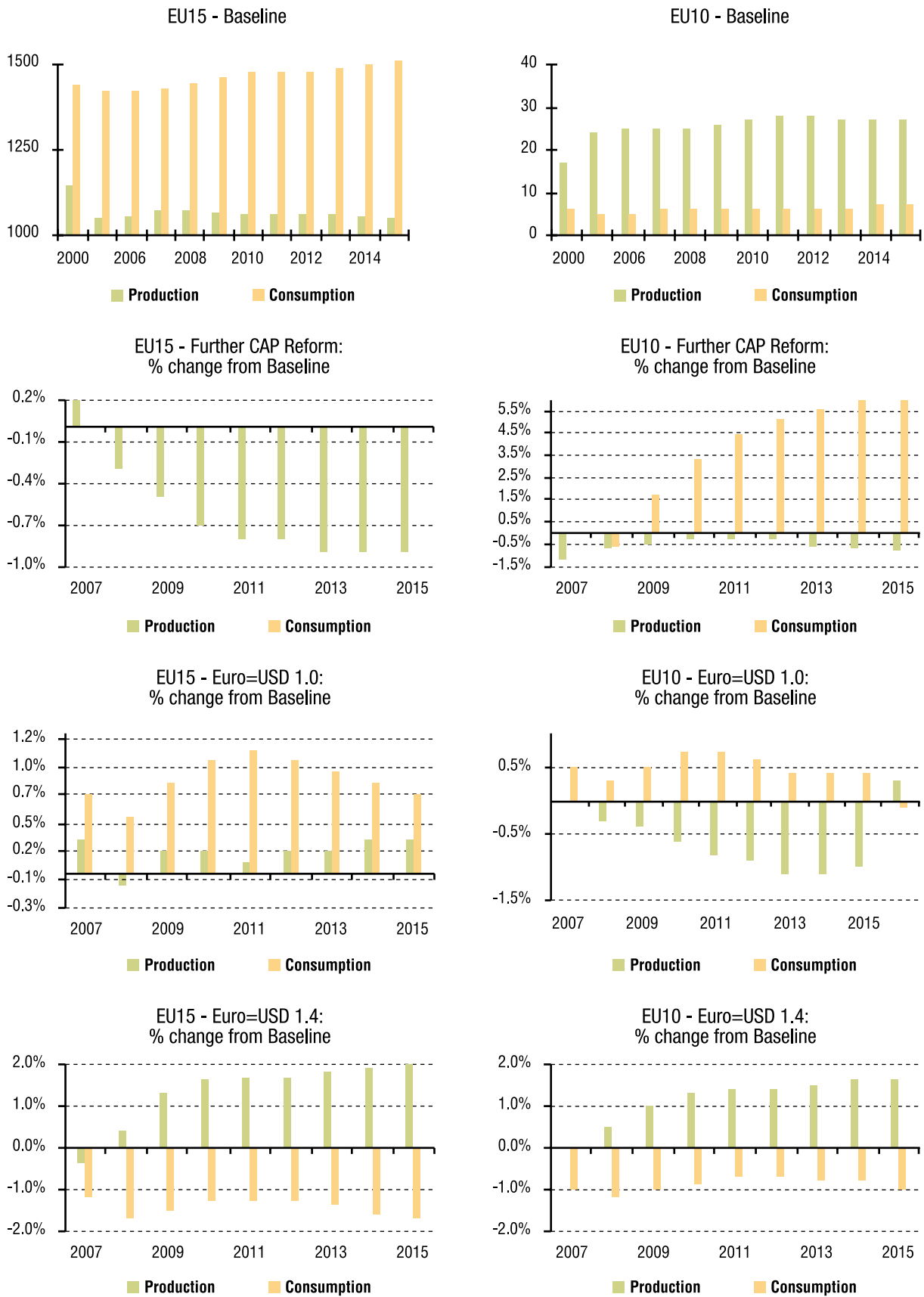

Source: AGMEMOD Country Models (2006)

Figure A 11 EU-15 and EU-10 butter projections under baseline and scenarios

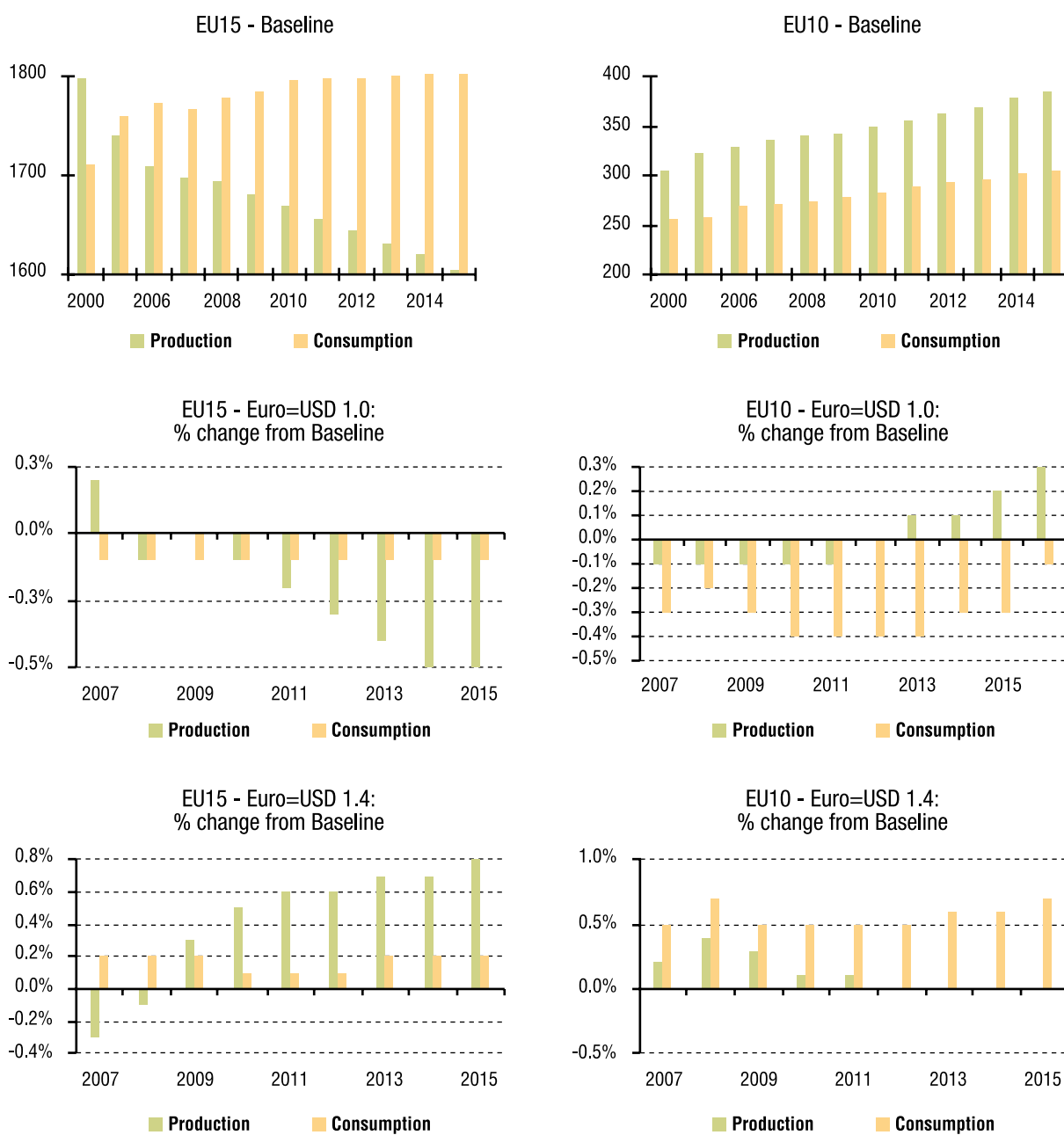

Source: AGMEMOD Country Models (2006)

Figure A 12 EU-15 and EU-10 skimmed milk powder projections under baseline and scenarios

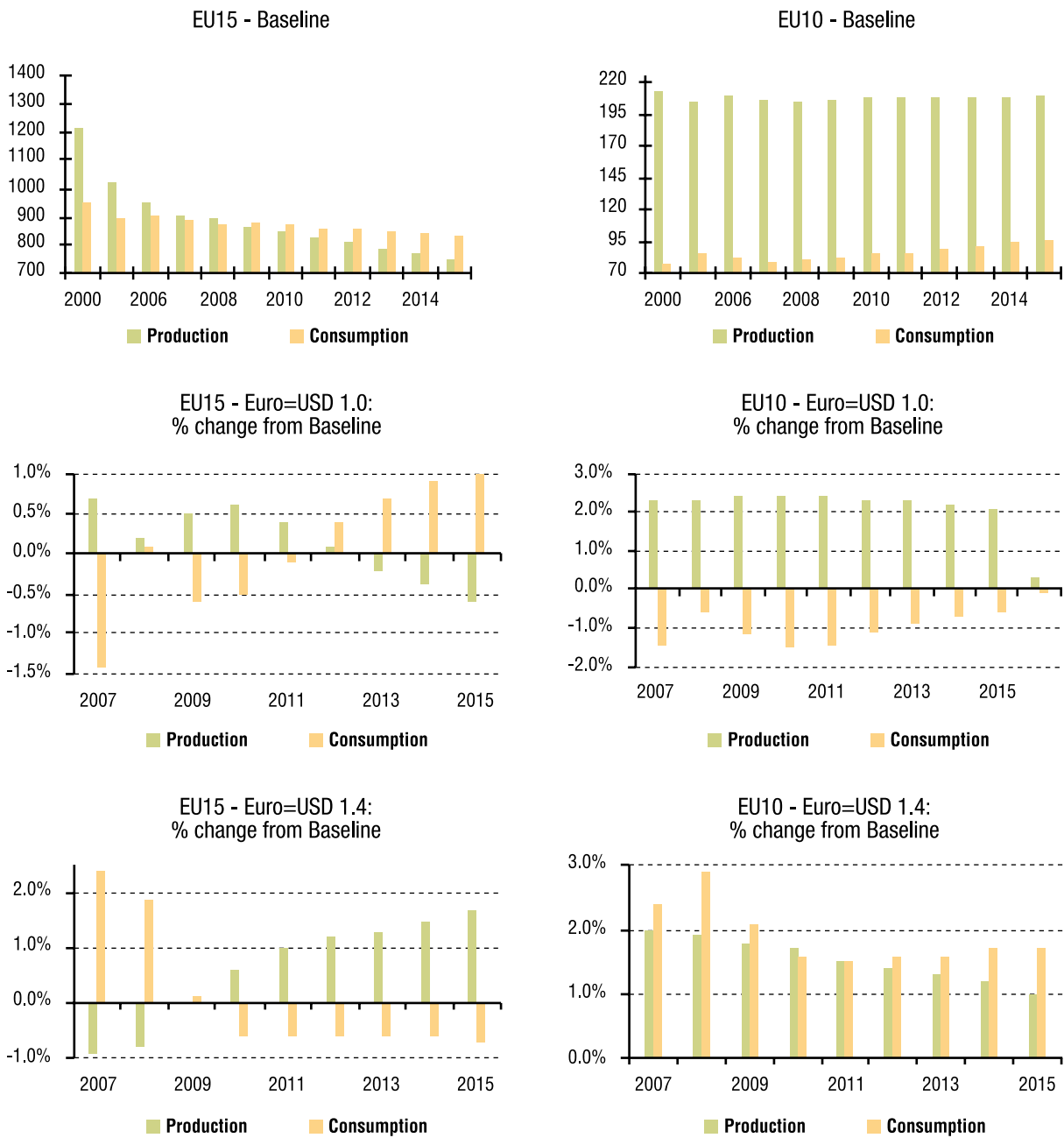

Source: AGMEMOD Country Models (2006)

Figure A 13 EU-15 and EU-10 cheese projections under baseline and scenarios

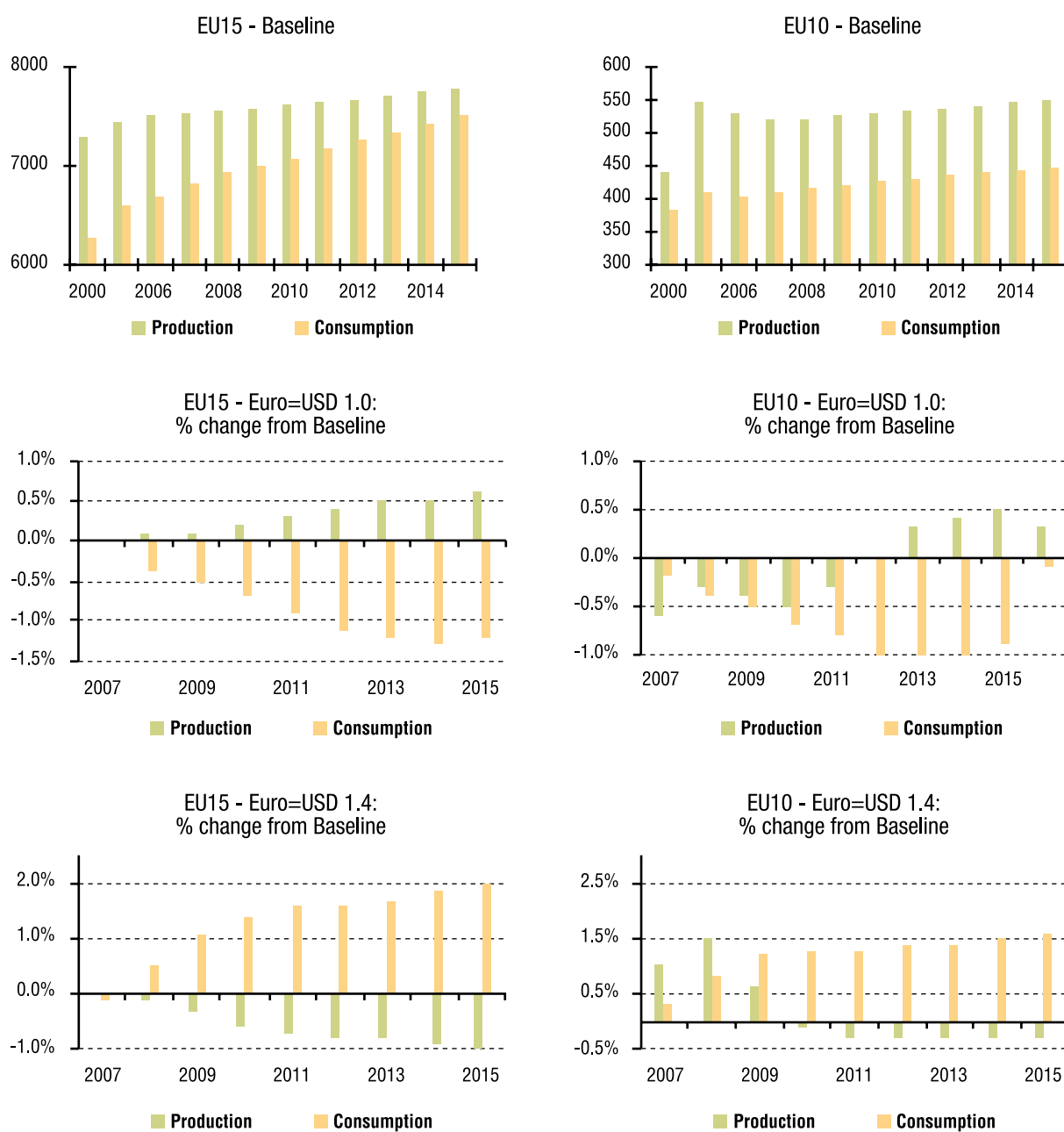

Source: AGMEMOD Country Models (2006)

European Commission

EUR 22940 EN/1 – Joint Research Centre – Institute for Prospective Technological Studies

Title: Impact Analysis of CAP Reform on the Main Agricultural Commodities. Report I. AGMEMOD - Summary Report

Authors: AGMEMOD Partnership

Editors: *Lubica Bartova, Robert M'barek*

Luxembourg: Office for Official Publications of the European Communities
2008

EUR – Scientific and Technical Research series

ISSN 1018-5593

ISBN 978-92-79-07623-7

Abstract

This summary report is based on the outcome of a study carried out by the AGMEMOD Partnership under the management of the Agricultural Economics Research Institute (LEI, in the Netherlands), in cooperation with the Joint Research Centre – Institute for Prospective Technological Studies (JRC-IPTS) to generate projections for the main agricultural commodity markets for each year from 2005 until 2015.

The report gives a general overview of the modelling approach, the description and implementation of the baseline, further CAP reform and exchange rate change scenarios. It outlines the main results for the aggregates EU-10, EU-15, EU-25 and EU-27, focusing in particular on the features implemented in this study, and addresses issues that need further attention.

Detailed documentation on the AGMEMOD modelling approach, along with the outcome of the study, is published in five reports in the JRC-IPTS Scientific and Technical Report Series under the heading “Impact analysis of Common Agricultural Policy reform on the main agricultural commodities”.

The mission of the JRC is to provide customer-driven scientific and technical support for the conception, development, implementation and monitoring of EU policies. As a service of the European Commission, the JRC functions as a reference centre of science and technology for the Union. Close to the policy-making process, it serves the common interest of the Member States, while being independent of special interests, whether private or national.



Impact Analysis of CAP Reform on the Main Agricultural Commodities Report I AGMEMOD – Summary Report

EN
LF-NA-22940-EN-C

FUR 22940 EN/1



INSTITUTE FOR PROSPECTIVE TECHNOLOGICAL STUDIES SEVILLE
ipts



Publications Office
Publications.eu.int

ISBN 978-92-79-07623-7



9 789279 076237