



HAL
open science

Influence of farming system on ground beetle communities at local and landscape scales

Maud Belhache, El Aziz Djoudi, Stéphanie Aviron, Julien Pétilion, Manuel Plantegenest

► To cite this version:

Maud Belhache, El Aziz Djoudi, Stéphanie Aviron, Julien Pétilion, Manuel Plantegenest. Influence of farming system on ground beetle communities at local and landscape scales. 17th European Carabidologists Meeting, Sep 2015, Primosten, Croatia. 48 p. hal-01458651

HAL Id: hal-01458651

<https://hal.science/hal-01458651v1>

Submitted on 3 Jun 2020

HAL is a multi-disciplinary open access archive for the deposit and dissemination of scientific research documents, whether they are published or not. The documents may come from teaching and research institutions in France or abroad, or from public or private research centers.

L'archive ouverte pluridisciplinaire **HAL**, est destinée au dépôt et à la diffusion de documents scientifiques de niveau recherche, publiés ou non, émanant des établissements d'enseignement et de recherche français ou étrangers, des laboratoires publics ou privés.

Influence of farming system on ground beetle communities at local and landscape scales



UMR 1349 INRA-Agrocampus Ouest-Université Rennes, IGEPP

Maud Belhache, El Aziz Djoudi, Stéphanie Aviron,
Julien Pétilion and Manuel Plantegenest

Context

- Needs for more **sustainable** and **healthy** agricultural systems
- **Development of Organic farming**
 - based on ecological processes
 - no petrochemical fertilizers and pesticides used



Context

- Needs for more **sustainable** and **healthy** agricultural systems
- **Development of Organic farming**
 - based on ecological processes
 - no petrochemical fertilizers and pesticides used

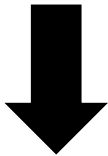

Beneficial effect on the **abundance** and **species richness** of **ground beetle communities**.



Context

- Needs for more **sustainable** and **healthy** agricultural systems
- **Development of Organic farming**
 - based on ecological processes
 - no petrochemical fertilizers and pesticides used

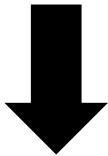

Beneficial effect on the **abundance** and **species richness** of **ground beetle communities**.



How does organic farming affect ground beetle communities at local and landscape scales ?

Context

- Differences in abundances and species composition (richness)



Organic farming

+ Abundance
Species richness -



Conventional farming

Context

- Differences in abundances and species composition (richness)
 - ↳ local scale processes

Environmental characteristics



Organic farming

Resources
Constraints

Reproduction
Survival



Conventional farming

Differences in species abundances and composition

Context

➤ Differences in abundances and species composition (richness)

↳ **landscape scale processes**

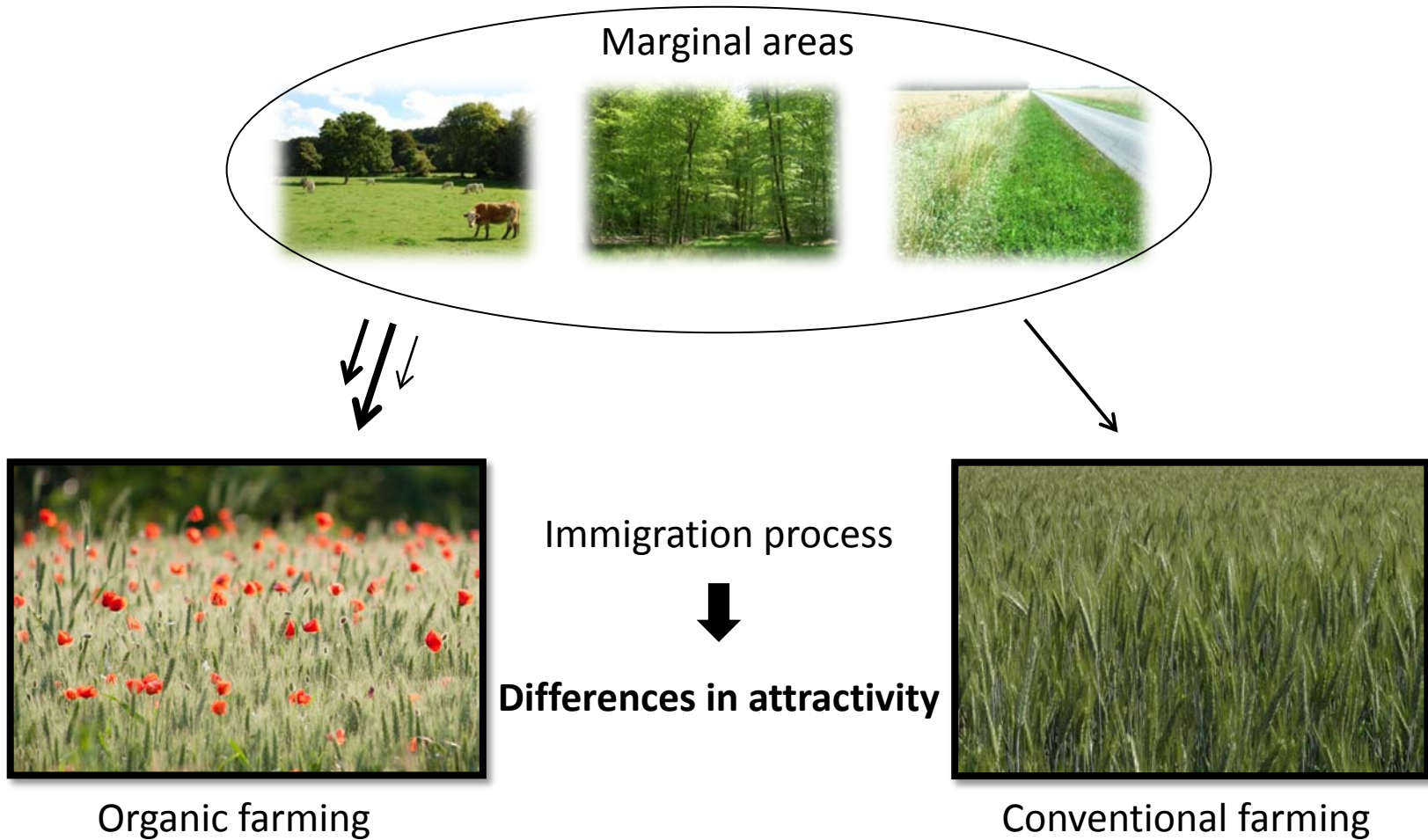

Context

- Differences in abundances and species composition (richness)
 - ↳ landscape scale processes : **coexistence of the two systems**



Context

- Differences in abundances and species composition (richness)
 - ↳ landscape scale processes : **Source/Sink dynamics ?**



Influence of the proportion of organic farming at landscape scale ?

How does organic farming affect ground beetle communities at local and landscape scales ?

- Contrasting assemblages in organic vs conventional farming
 - ↳ habitat characteristics differ between systems
- Contrasting emerging vs circulating communities
 - ↳ local vs landscape contribution
- Assessing landscape influence on local communities
 - ↳ source/sink dynamics

Method

❖ Study site

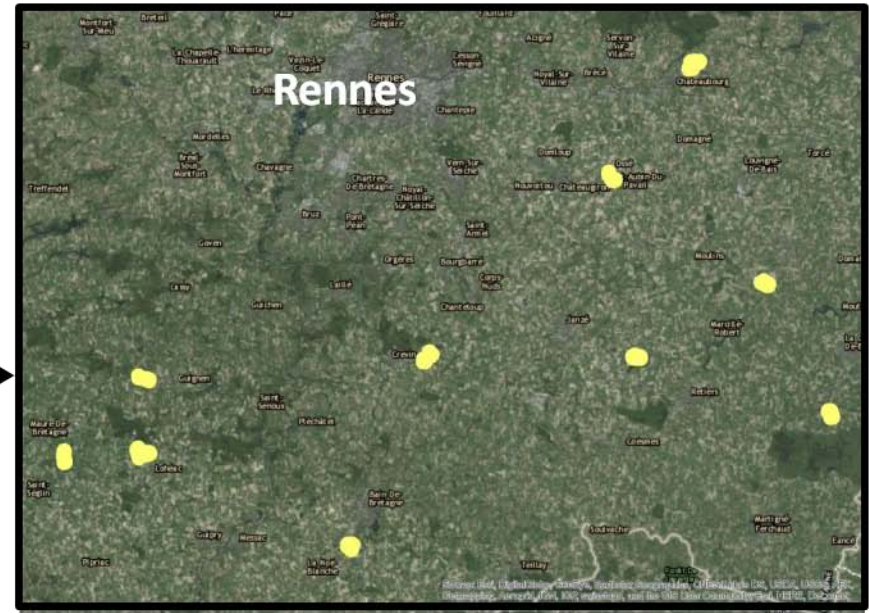

Selection of :

- 10 landscapes in Brittany
 - ↳ 20 wheat fields
 - 10 under organic farming
 - 10 under conventional farming

Method

❖ Experimental device

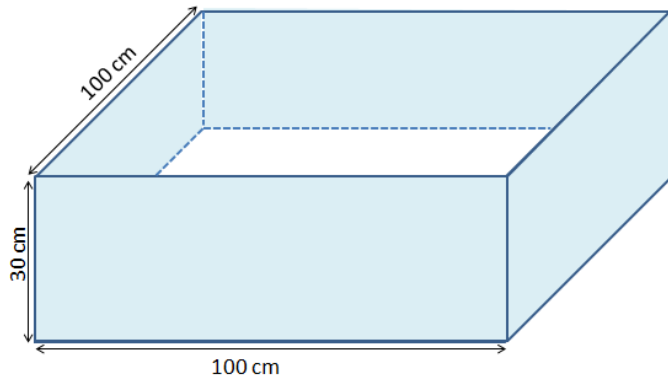

Emergence arena

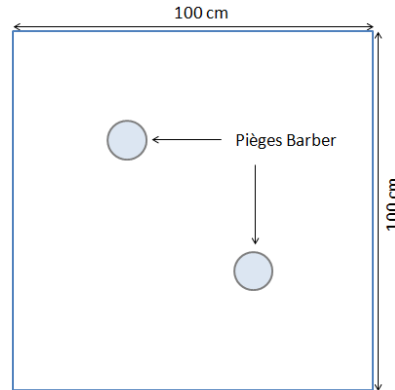

- In each sampled field :
 - ➔ 3 emergence arenas including two pitfall traps
 - ➔ 1 pitfall trap located in the vicinity of each emergence arena
- Samples collection every 2 weeks (april-may 2015).

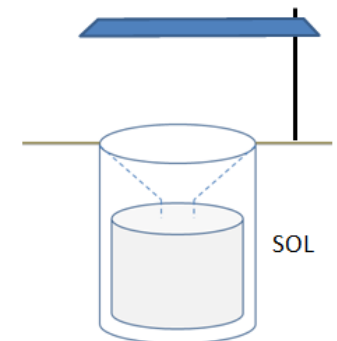

Pitfall trap

Results : Local scale

❖ Abundances

Higher abundances in OF :

→ attractive effect ?

→ differences in mortality rates ?

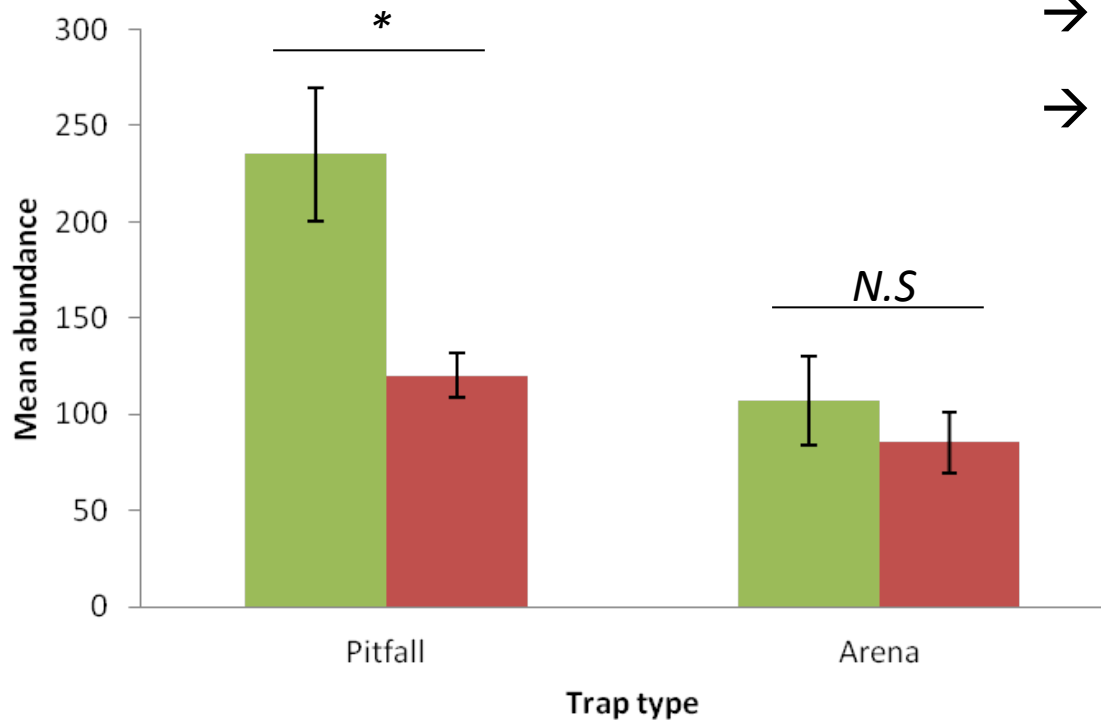

N.S : nonsignificant difference ; * : $P < 0.05$
green : OF and red: CF

Results : Local scale

❖ Species richness

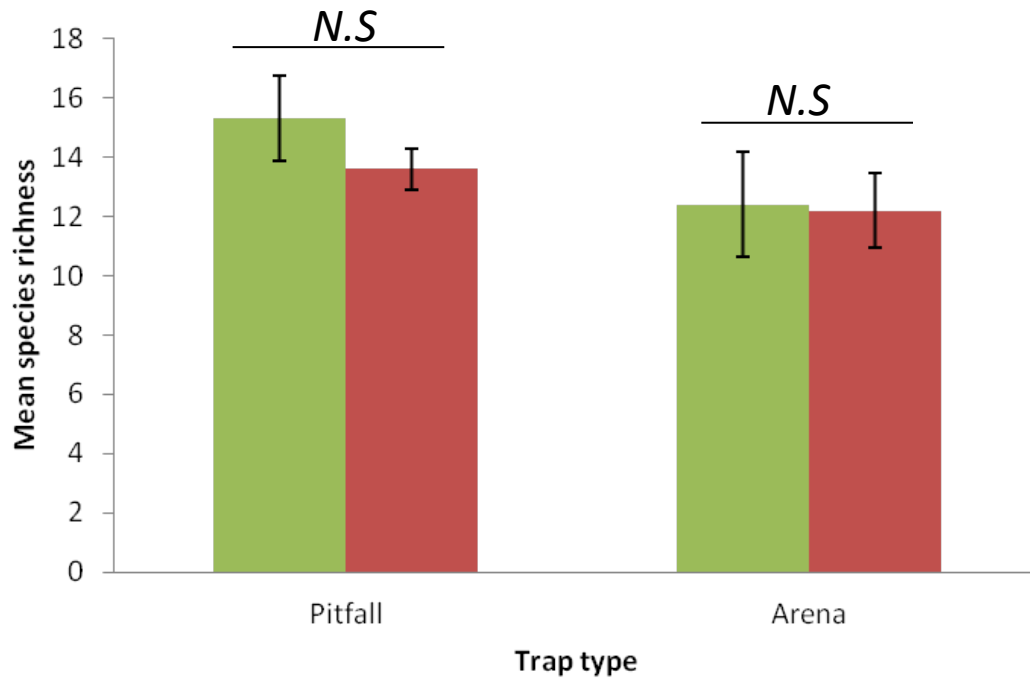

N.S : nonsignificant difference ; * : $P < 0.05$
green : OF and red: CF

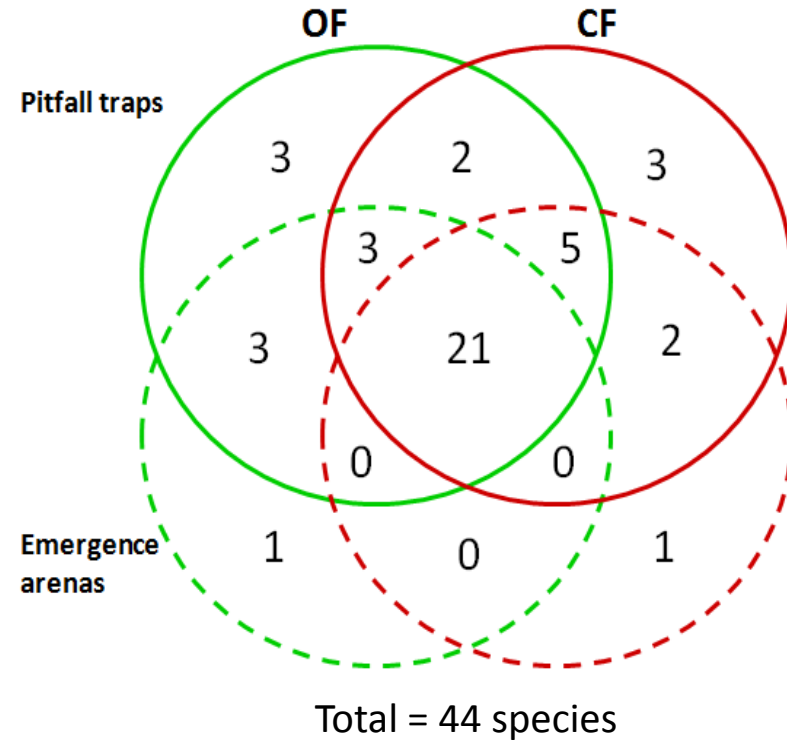

➤ Similar species richness in the two systems.

Results : Local scale

❖ Species richness

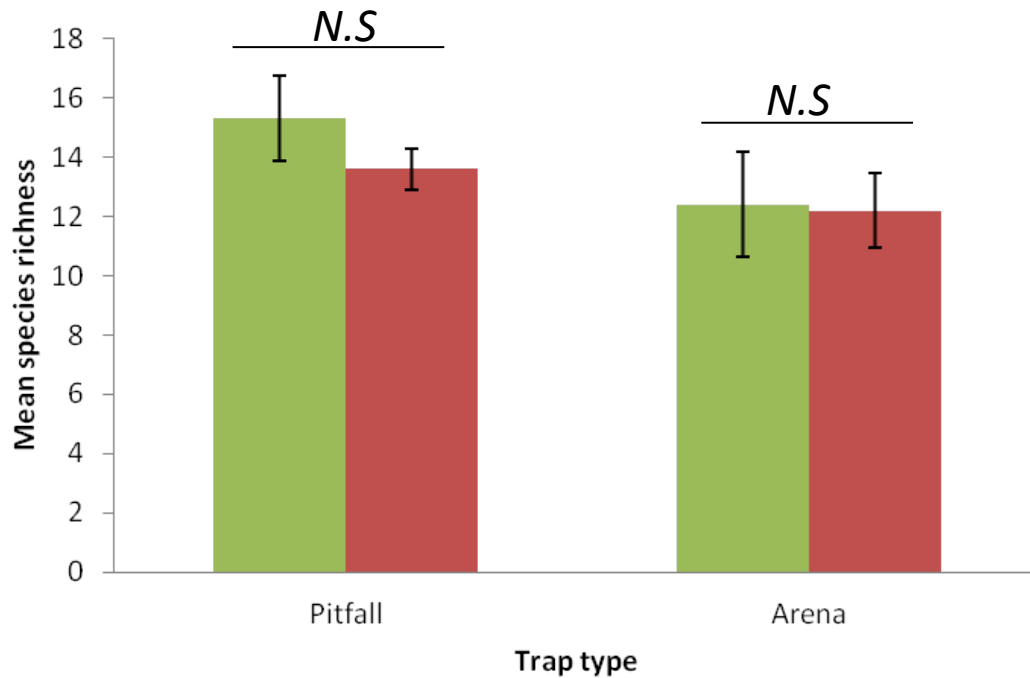

N.S : nonsignificant difference ; * : $P < 0.05$
green : OF and red: CF

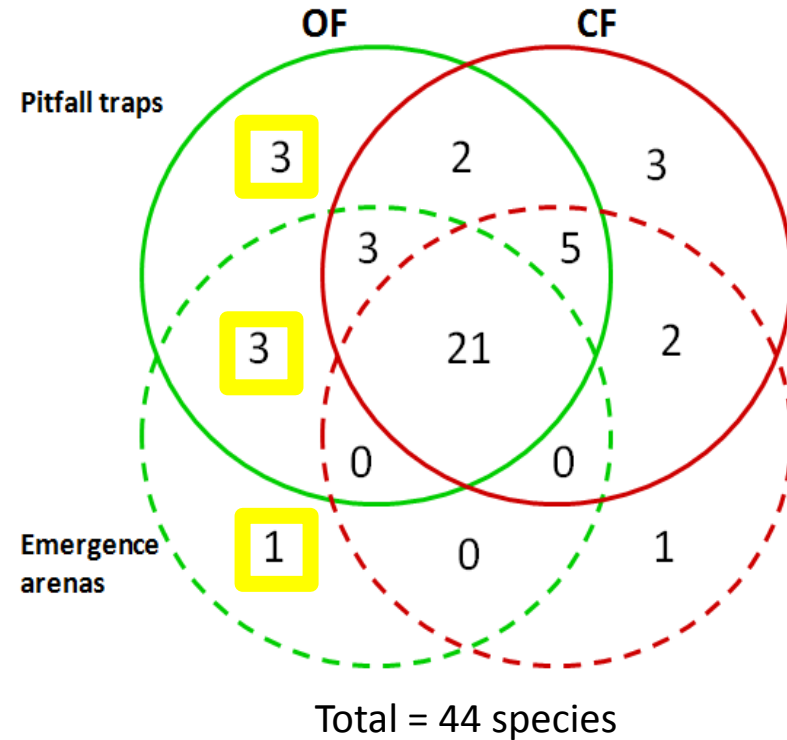

- Similar species richness between the two systems.
- Variation in communities composition.

Results : Local scale

❖ Species richness

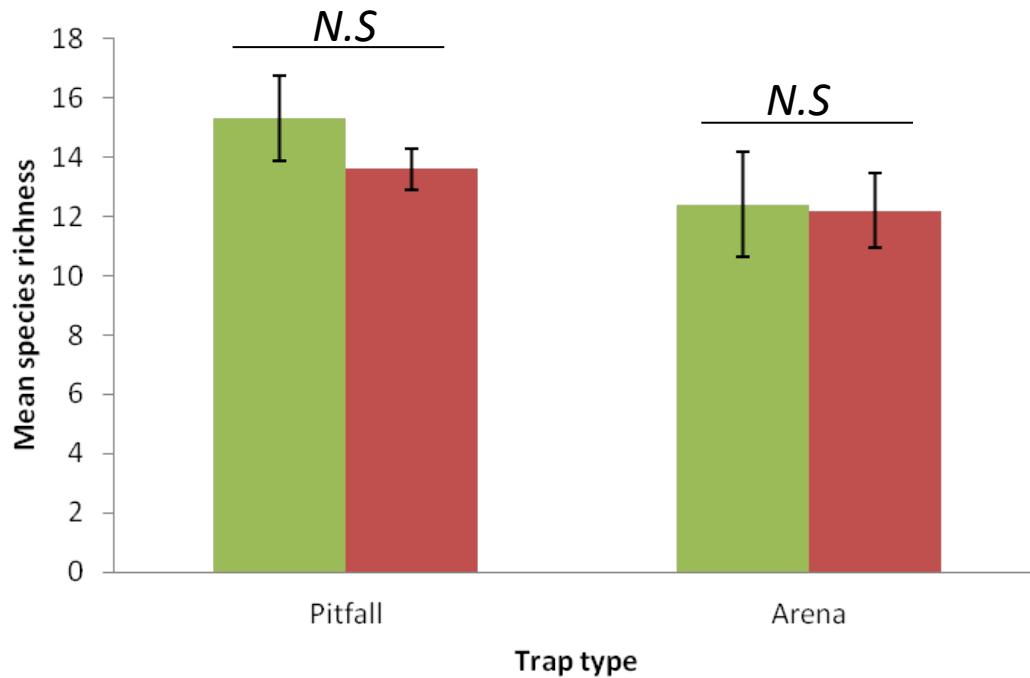

N.S : nonsignificant difference ; * : $P < 0.05$
green : OF and red: CF

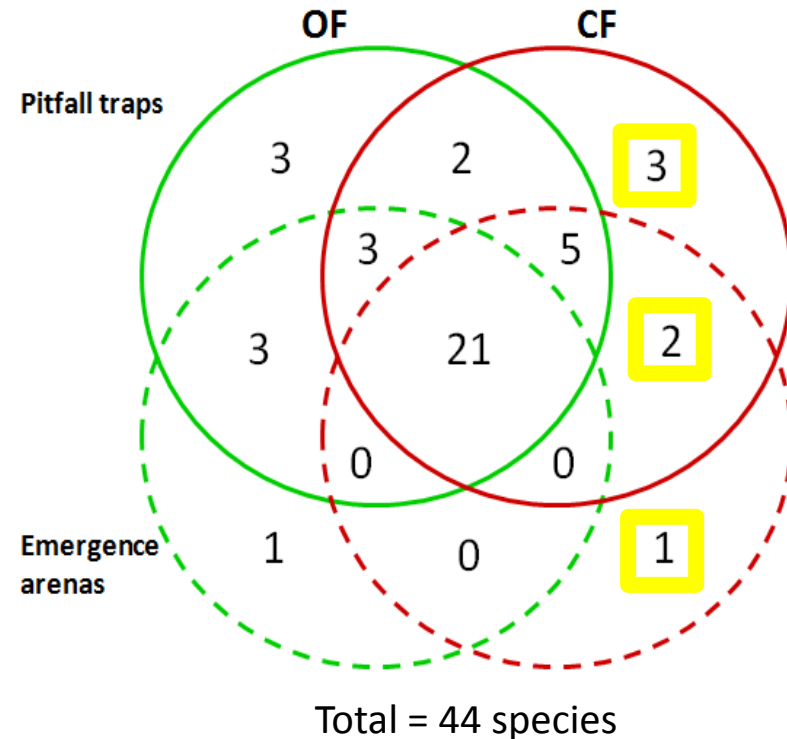

- Similar species richness between the two systems.
- Variation in communities composition.

Results : Local scale

❖ Species richness

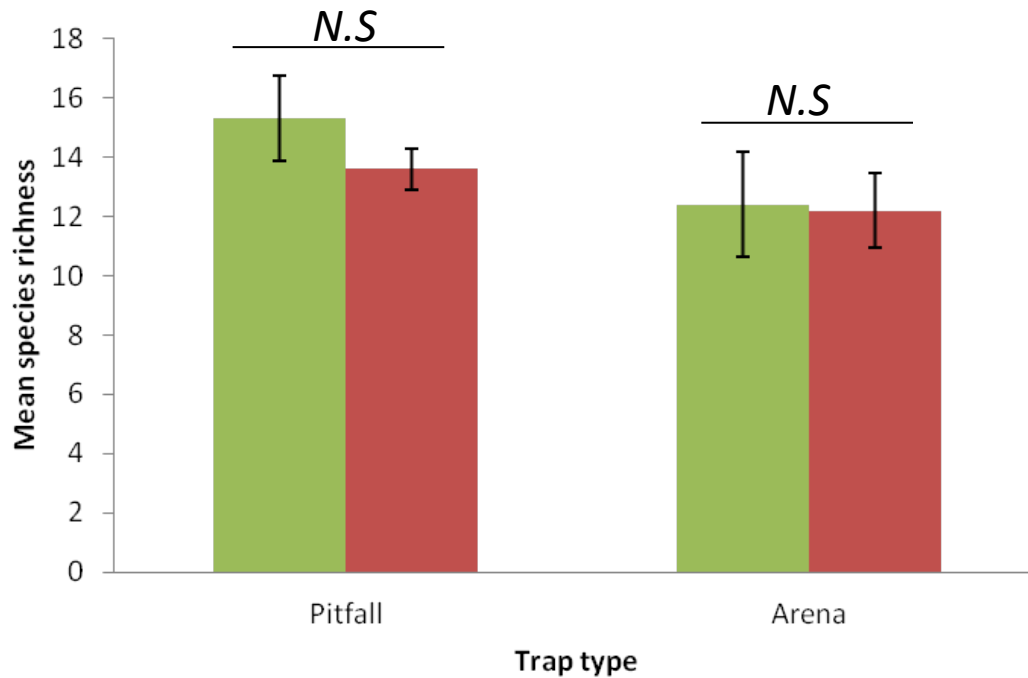

N.S : nonsignificant difference ; * : $P < 0.05$
green : OF and red: CF

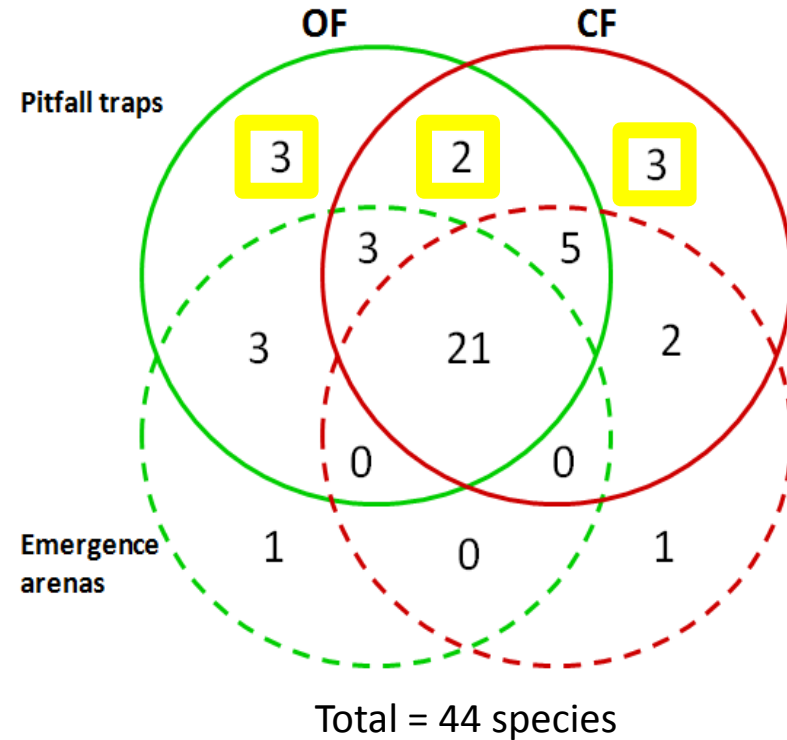

- Similar species richness between the two systems.
- Variation in communities composition.

Results : Local scale

❖ Species richness

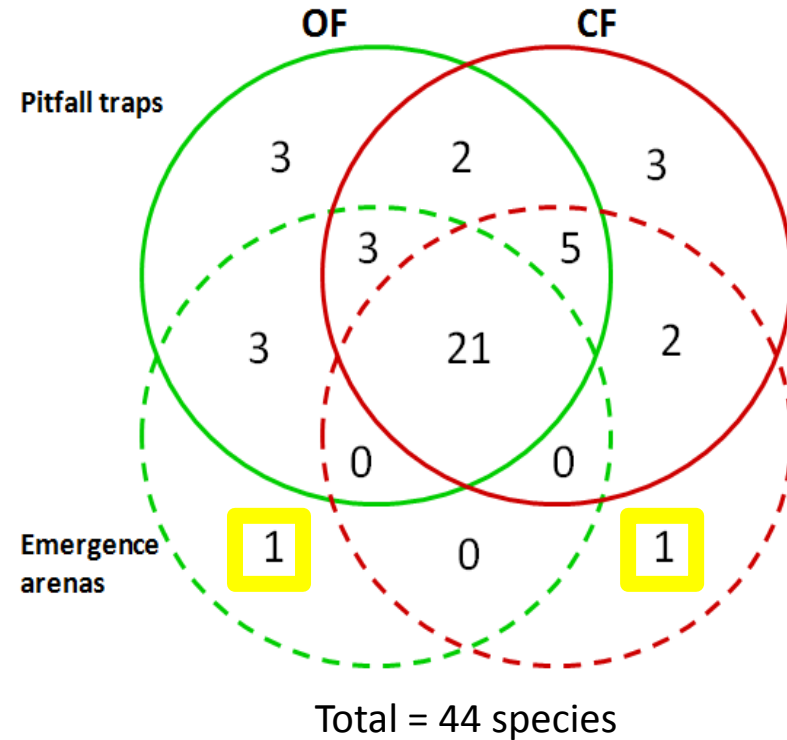
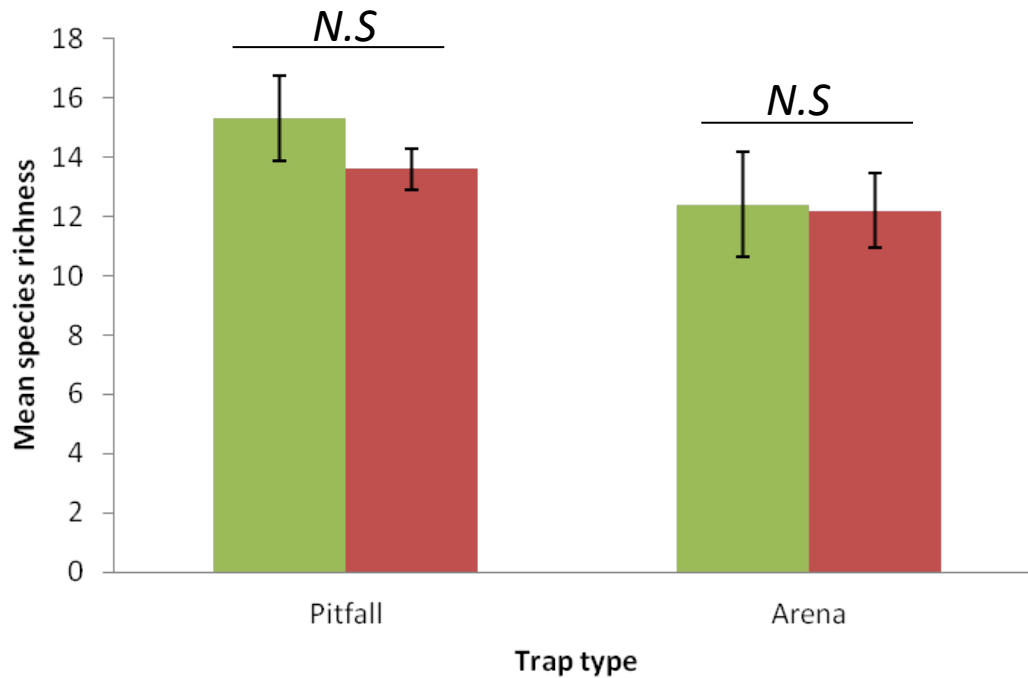

- Similar species richness between the two systems.
- Variation in communities composition.

Results : Local scale

❖ Species richness

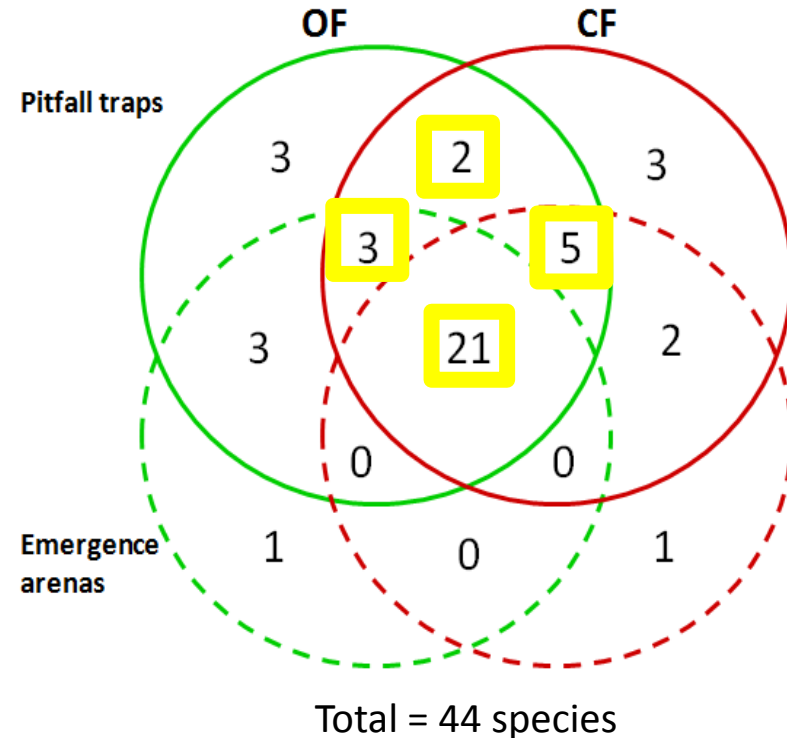
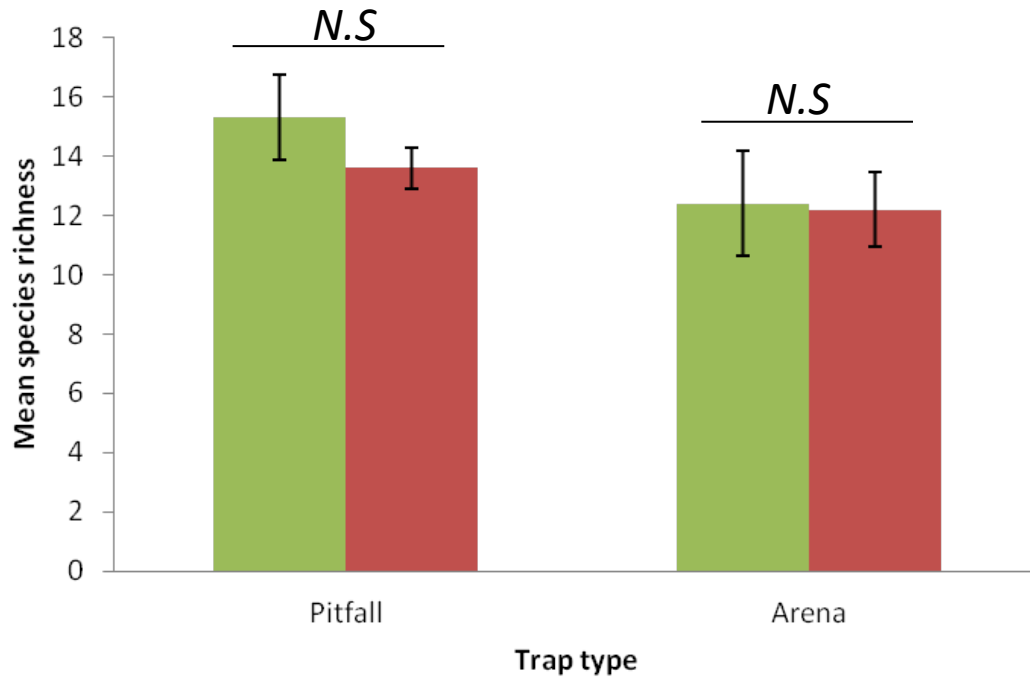

- Similar species richness between the two systems.
- Majority of species are present in the two systems.

Results : Local scale

❖ Specific composition of ground beetle communities

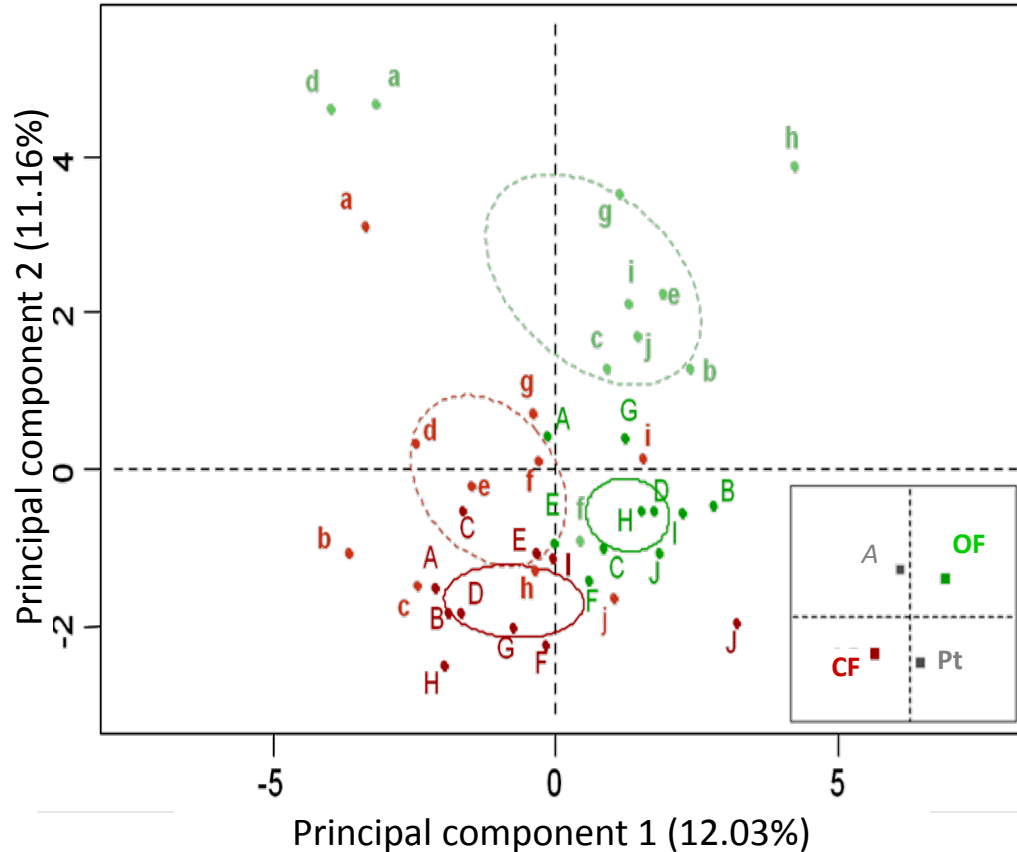

PCA : **species proportions** captured in both trap types during the entire sampling period.

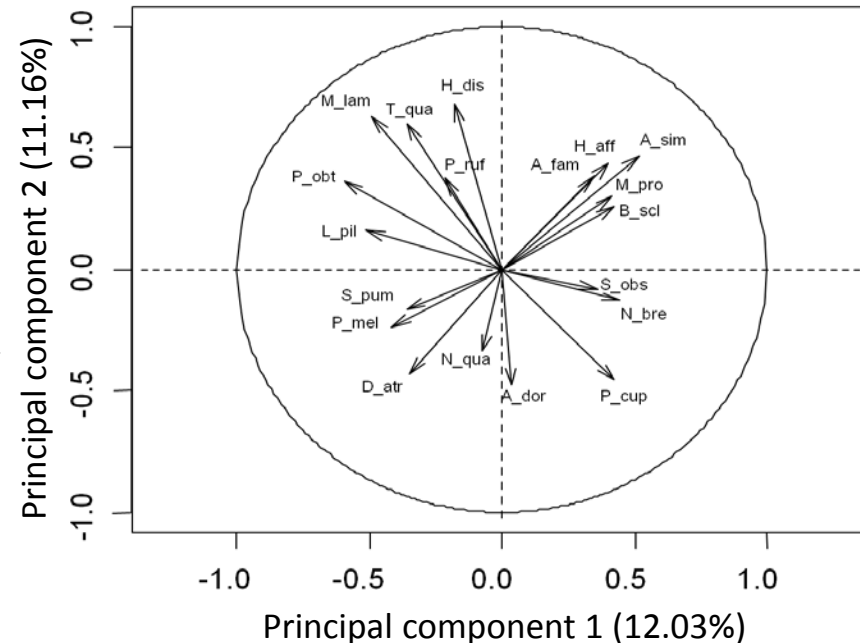

Results : Local scale

- ❖ Specific composition of ground beetle communities

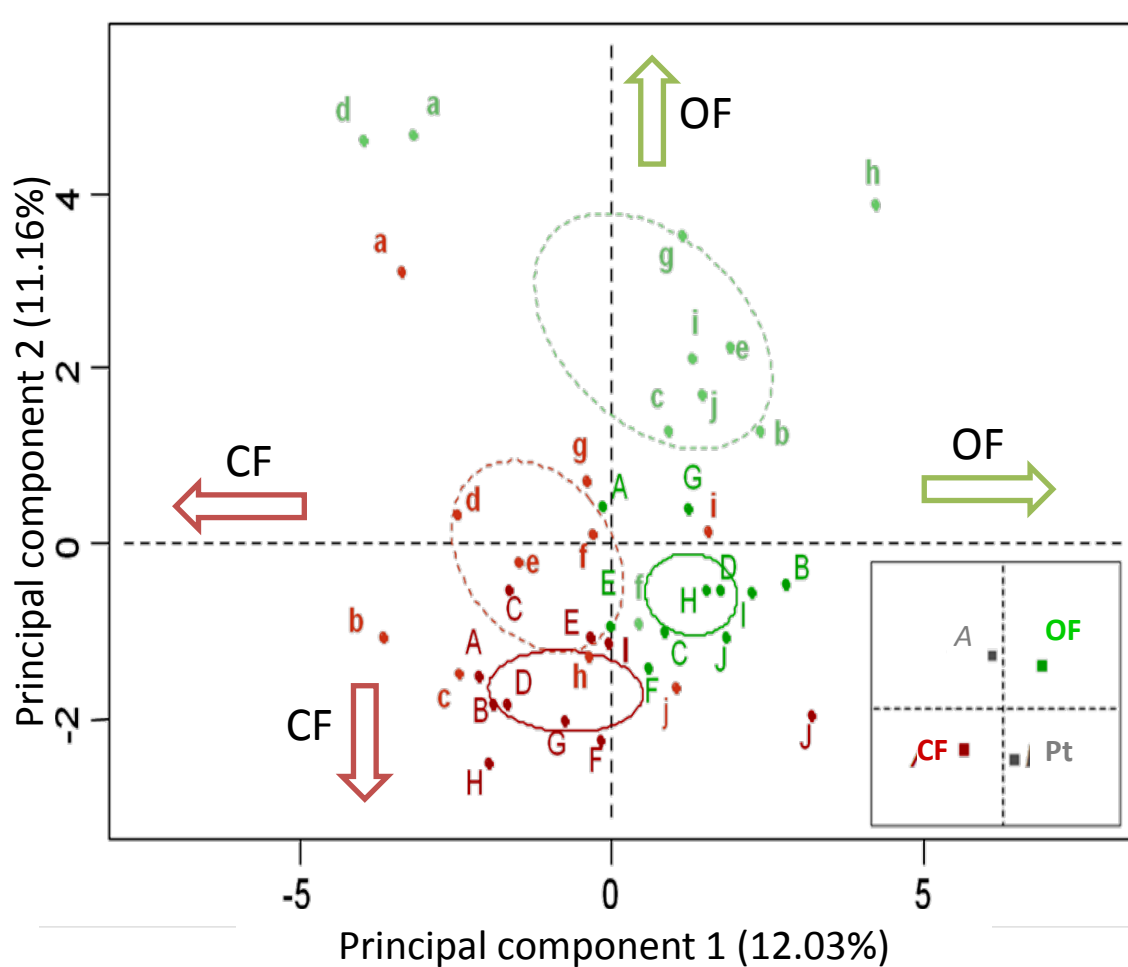

Axe 1 & 2 :
organic and conventional
communities differ

Results : Local scale

- ❖ Specific composition of ground beetle communities

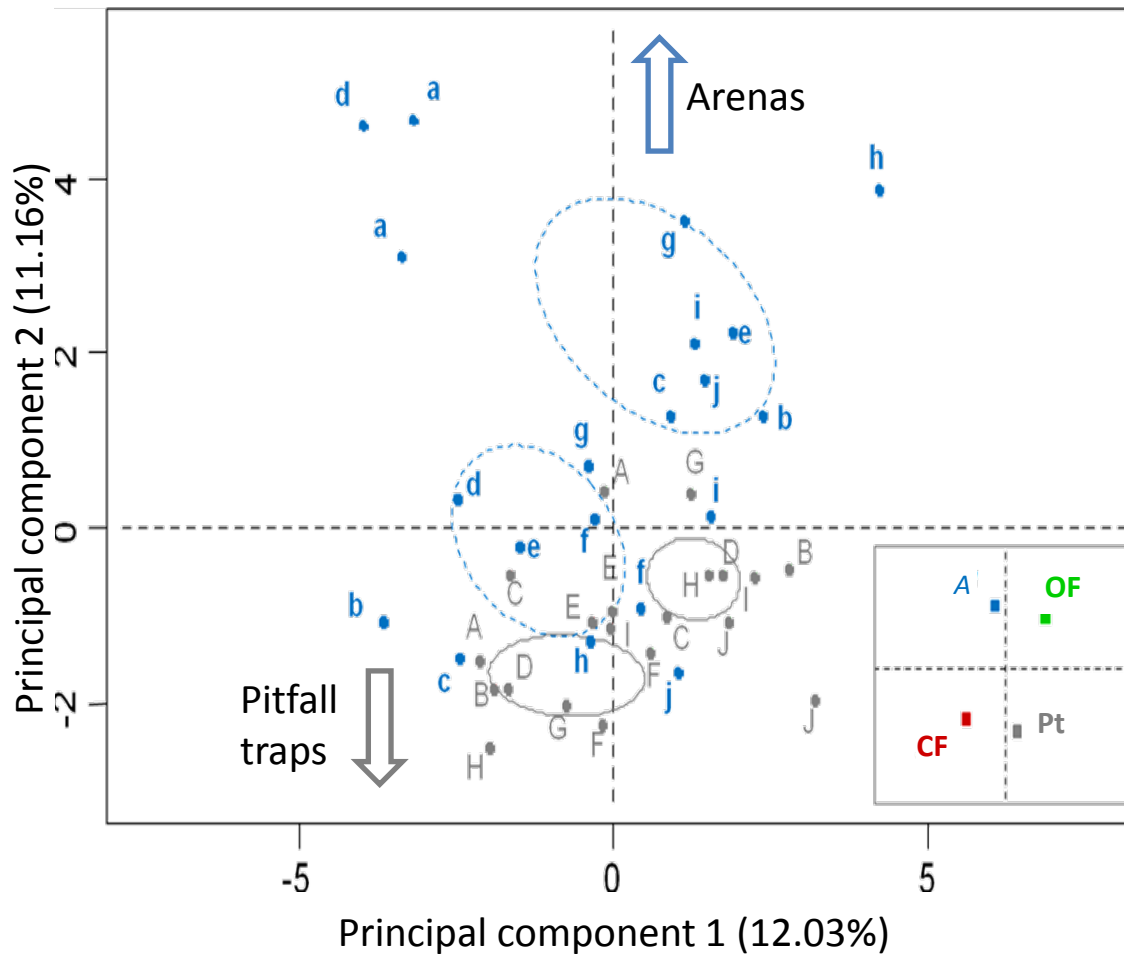

Axe 2 :
circulating and emerging
communities differ

Results : Local scale

- ❖ Specific composition of ground beetle communities

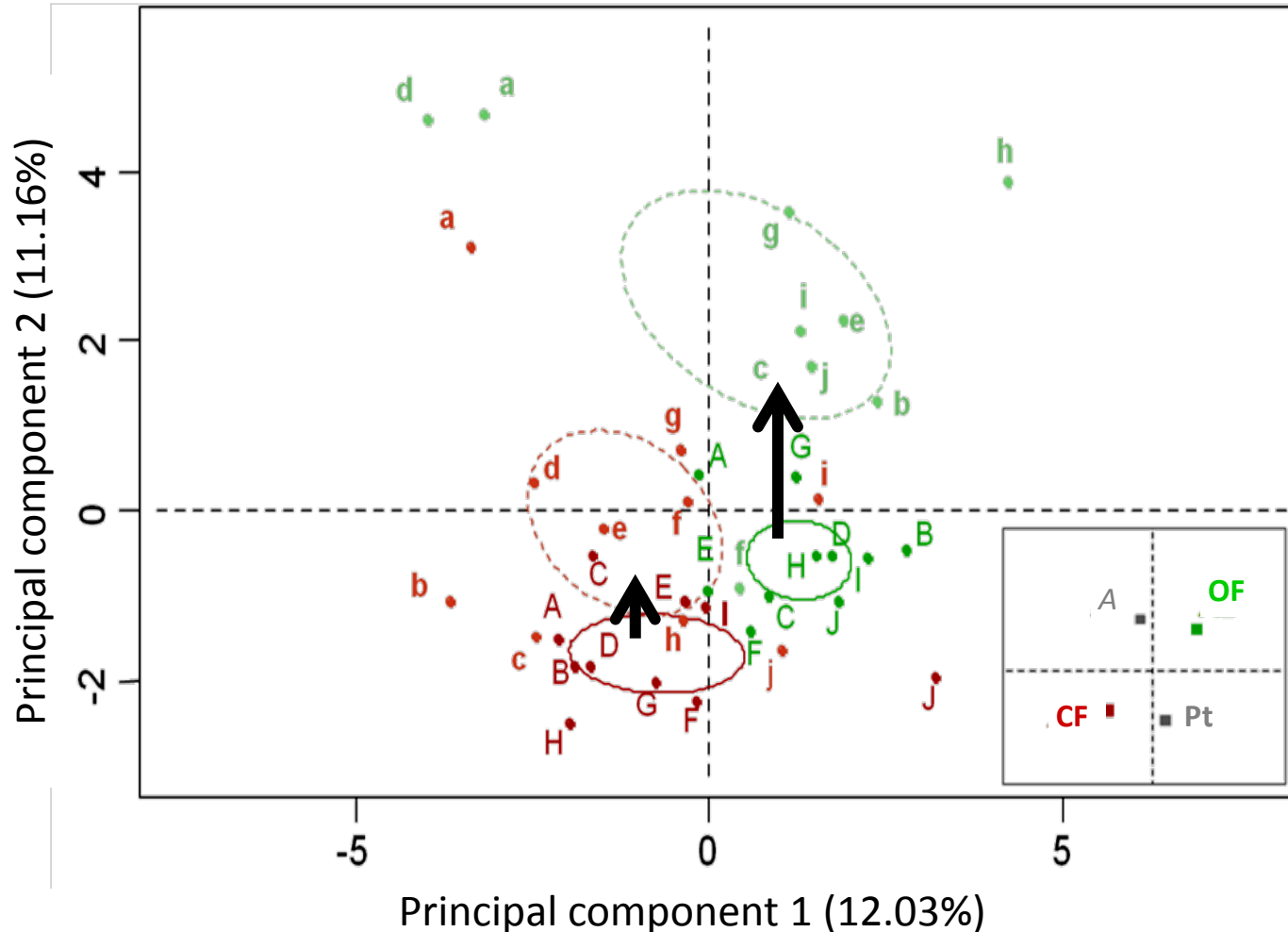

Results : Local scale

❖ Specific composition of ground beetle communities

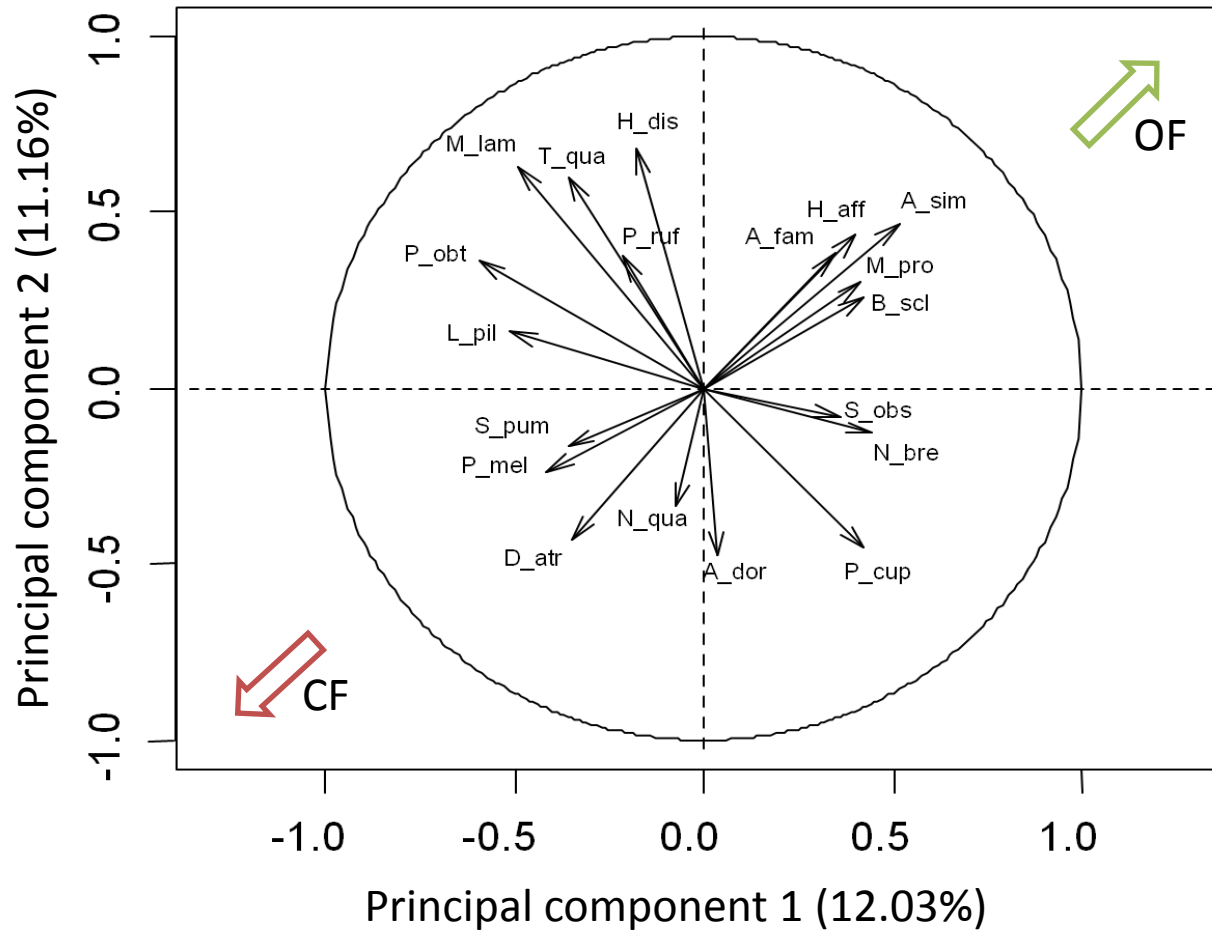

Organic farming :

- Rich vegetation cover

Results : Local scale

❖ Specific composition of ground beetle communities

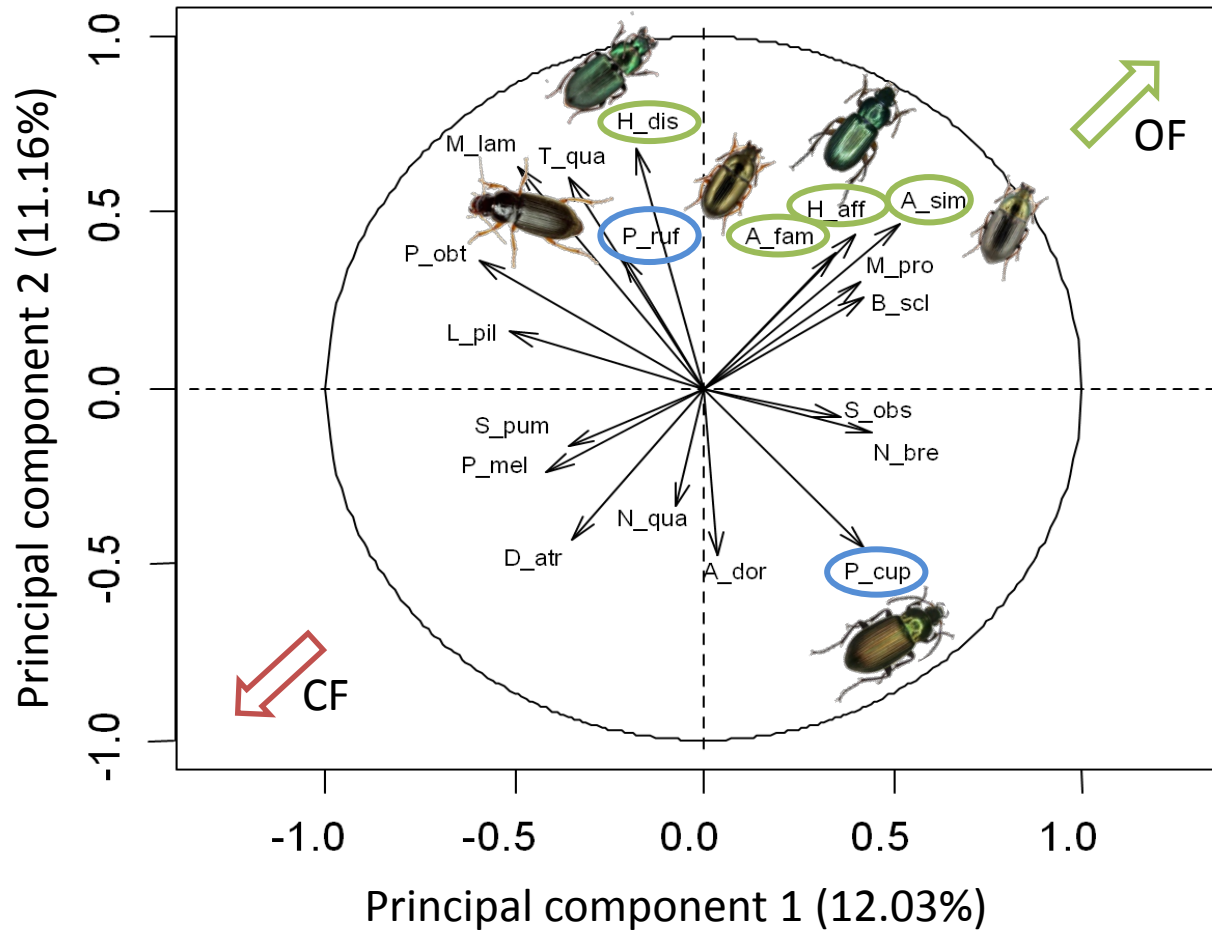

Organic farming :

- Rich vegetation cover

↳ phytophagous

Results : Local scale

❖ Specific composition of ground beetle communities

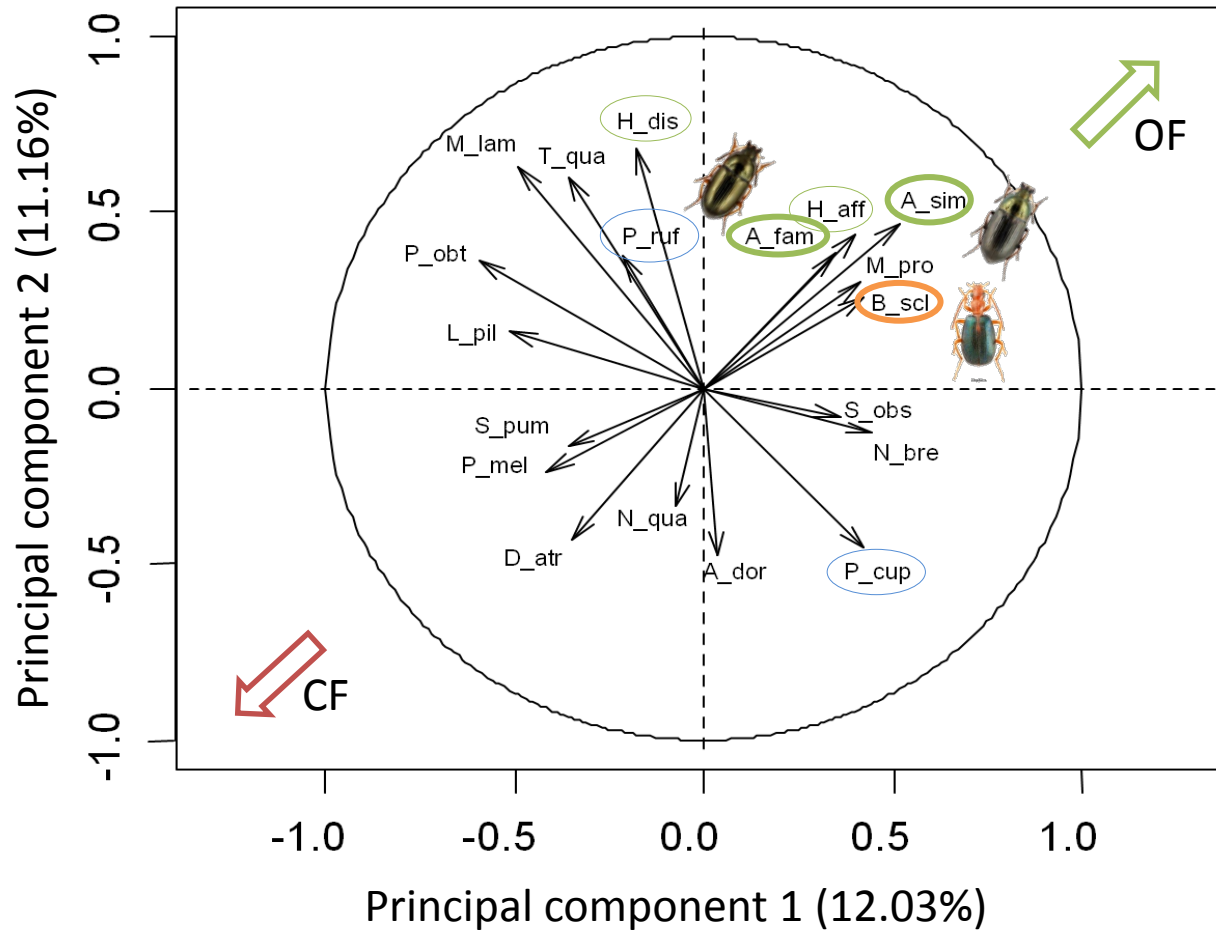

Organic farming :

- Rich vegetation cover

↳ phytophagous

- Genus *Amara*

↳ genus *Brachinus*

Results : Local scale

❖ Specific composition of ground beetle communities

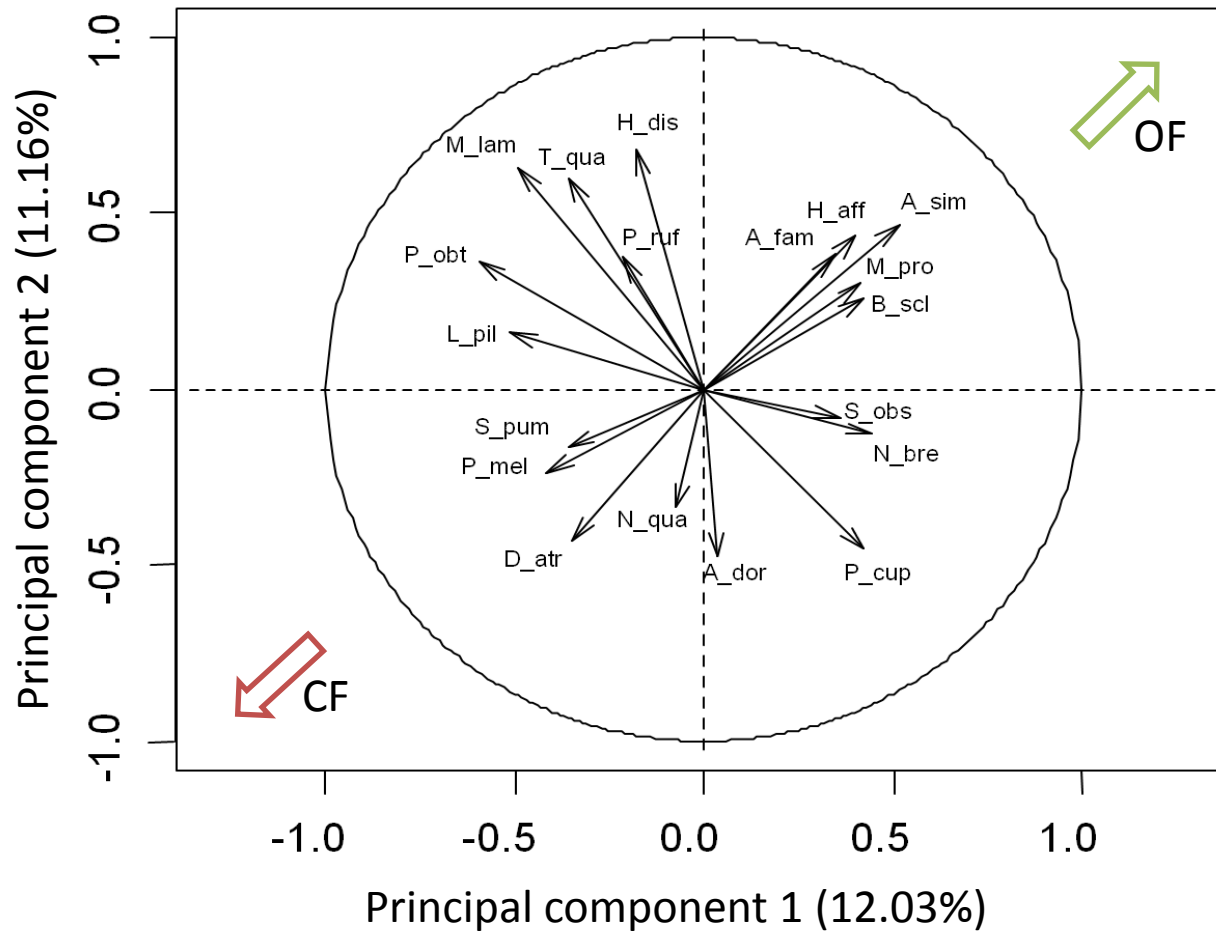

Conventional farming :
- less diverse resources

Results : Local scale

❖ Specific composition of ground beetle communities

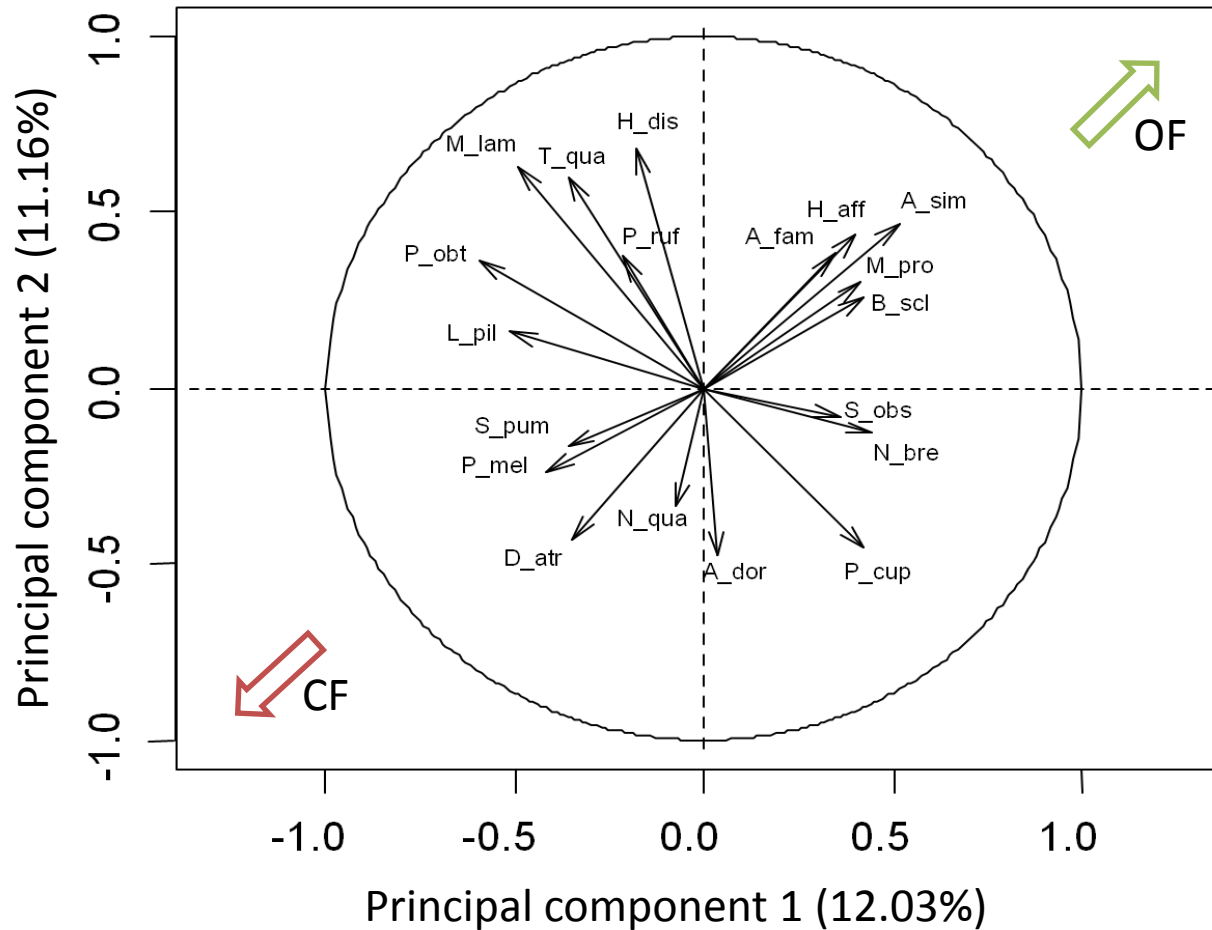

Conventional farming :

- less diverse resources

↳ collembola

↳ slugs

↳ aphids

Results : Local scale

❖ Specific composition of ground beetle communities

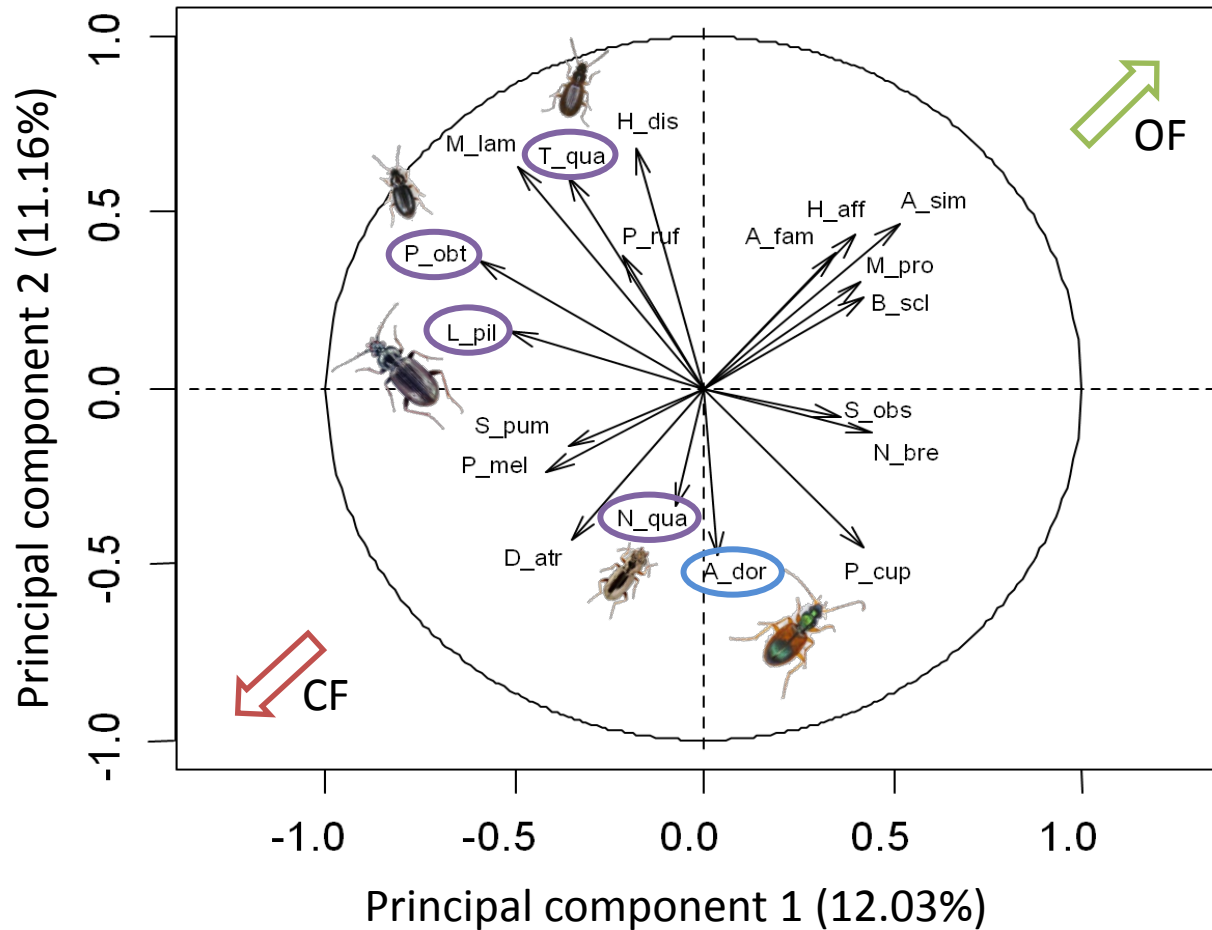

Conventional farming :

- less diverse resources

↳ collembola

↳ slugs

↳ aphids

Results : Local scale

❖ Specific composition of ground beetle communities

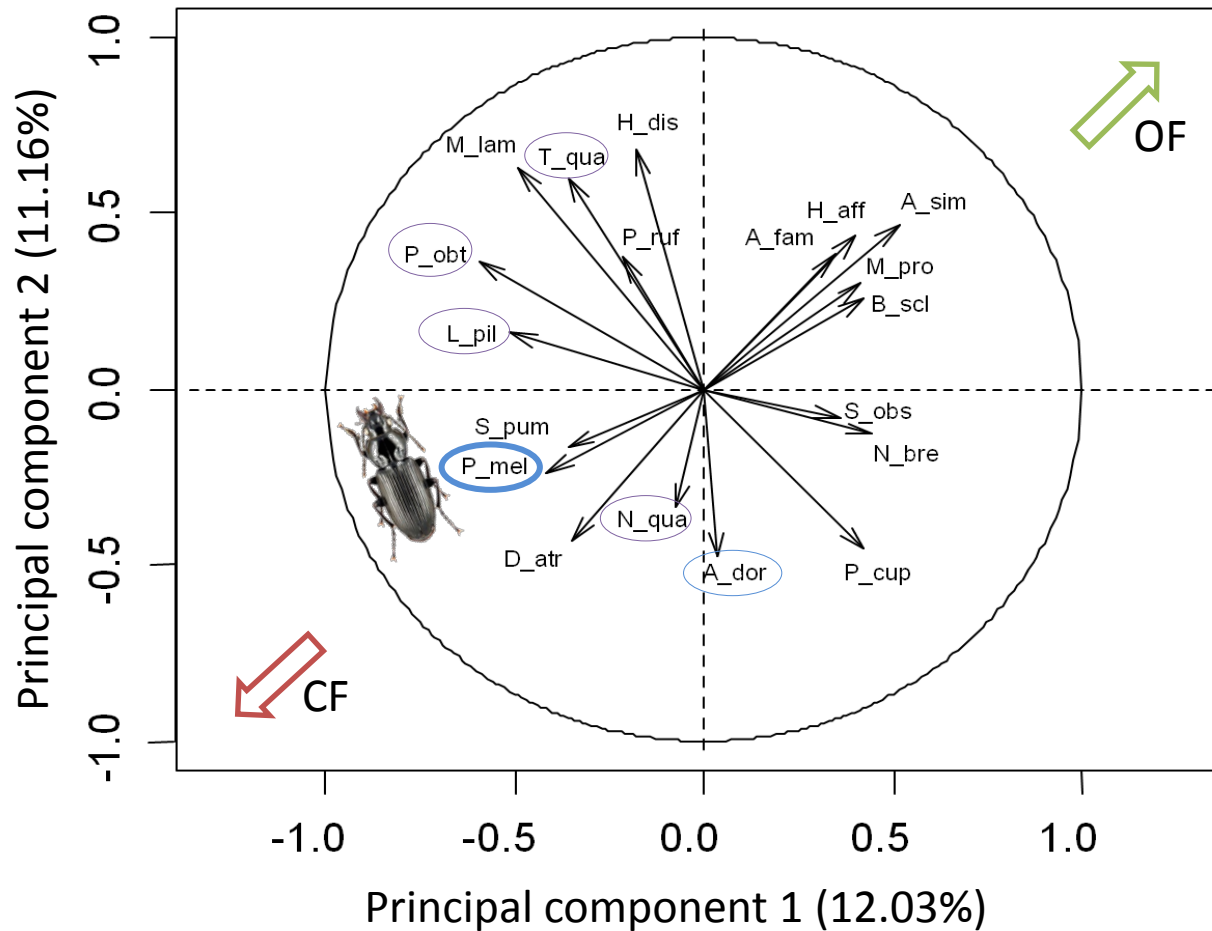

Conventional farming :

- less diverse resources

↳ collembola

↳ slugs

↳ aphids

Results : Local scale

❖ Specific composition of ground beetle communities

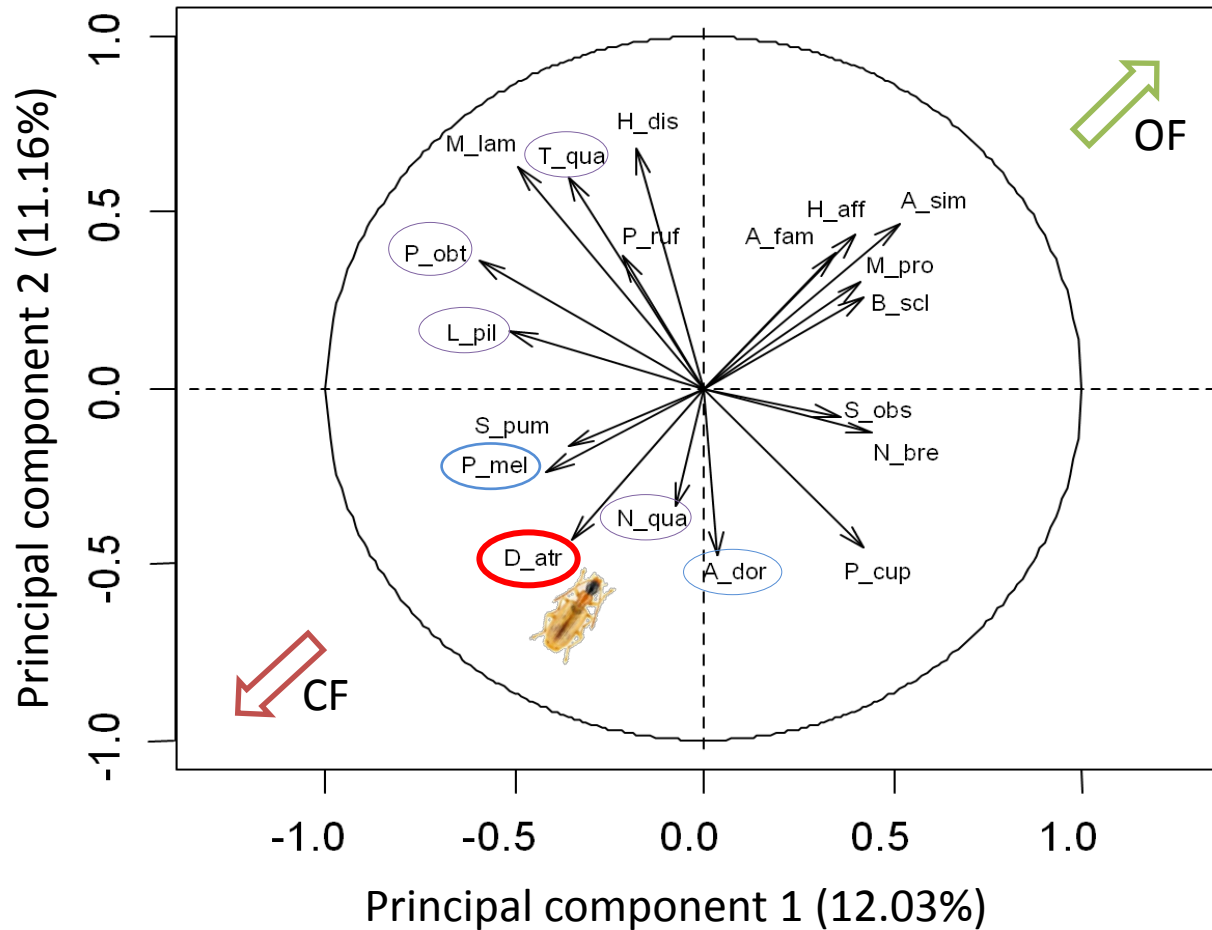

Conventional farming :

- less diverse resources

↳ collembola

↳ slugs

↳ aphids

Landscape scale

❖ Method

Cartography :

- Buffer of 500m around fields
- Information on crops management
 - ↳ OF gradient in the surroundings of sampling fields.

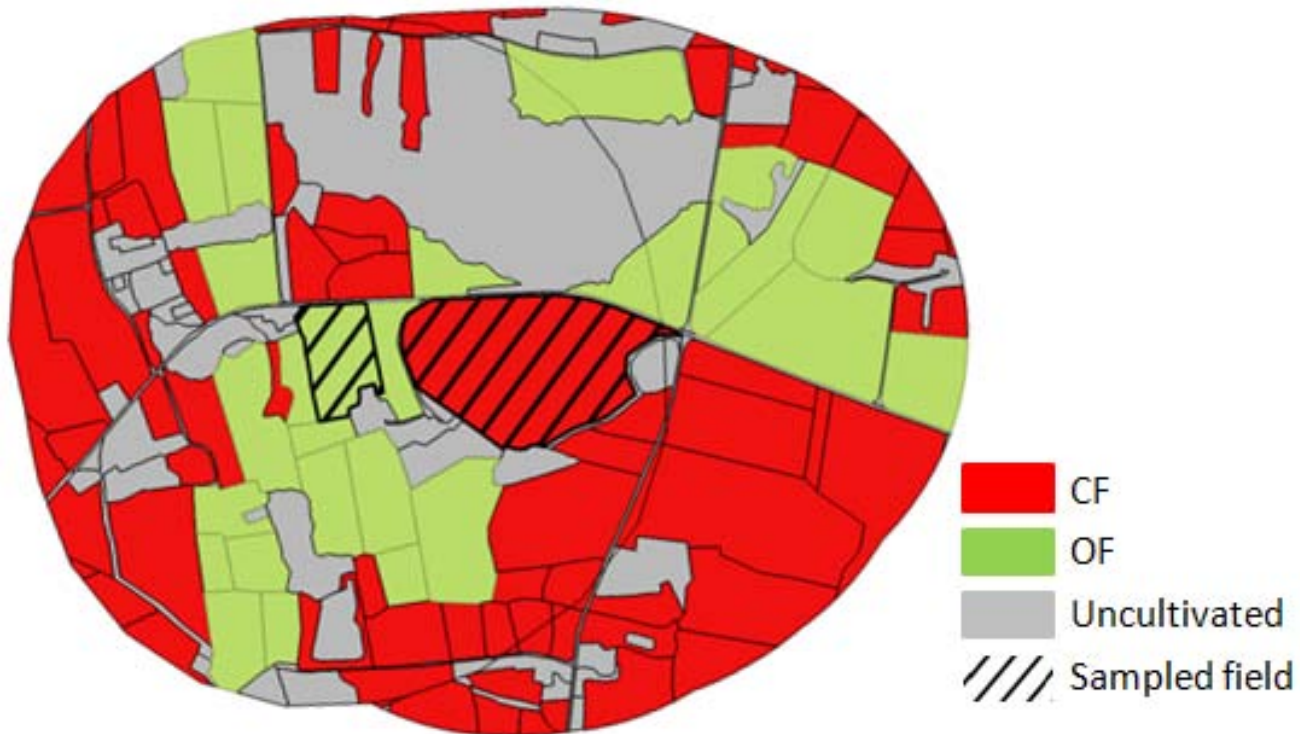

Results : Landscape scale

❖ Influence of OF percentage in **the** landscape

Total abundances in CF fields

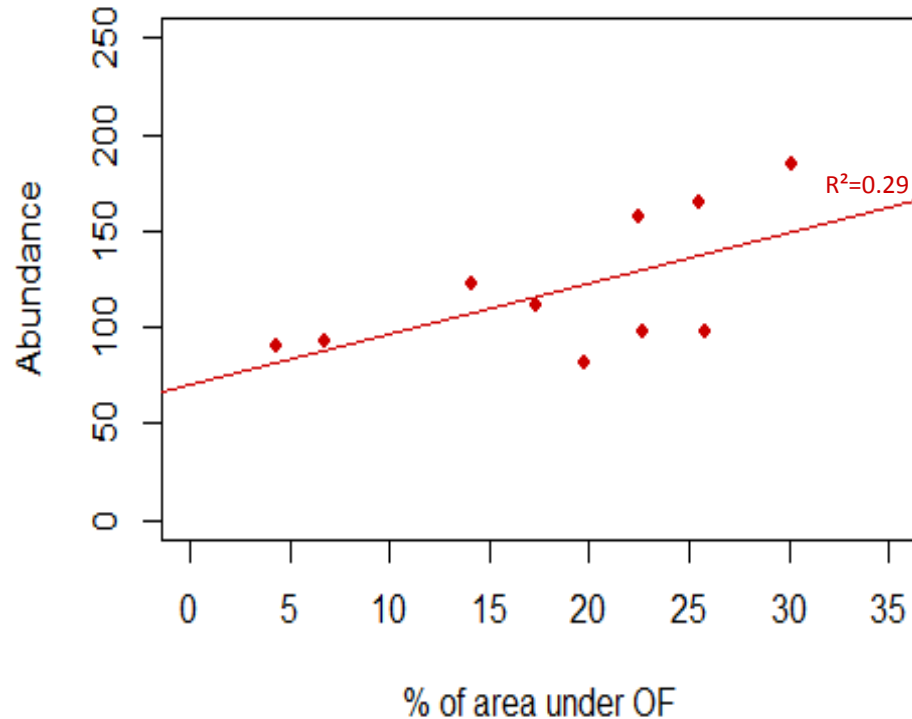

Abundances of phytophagous species in CF fields

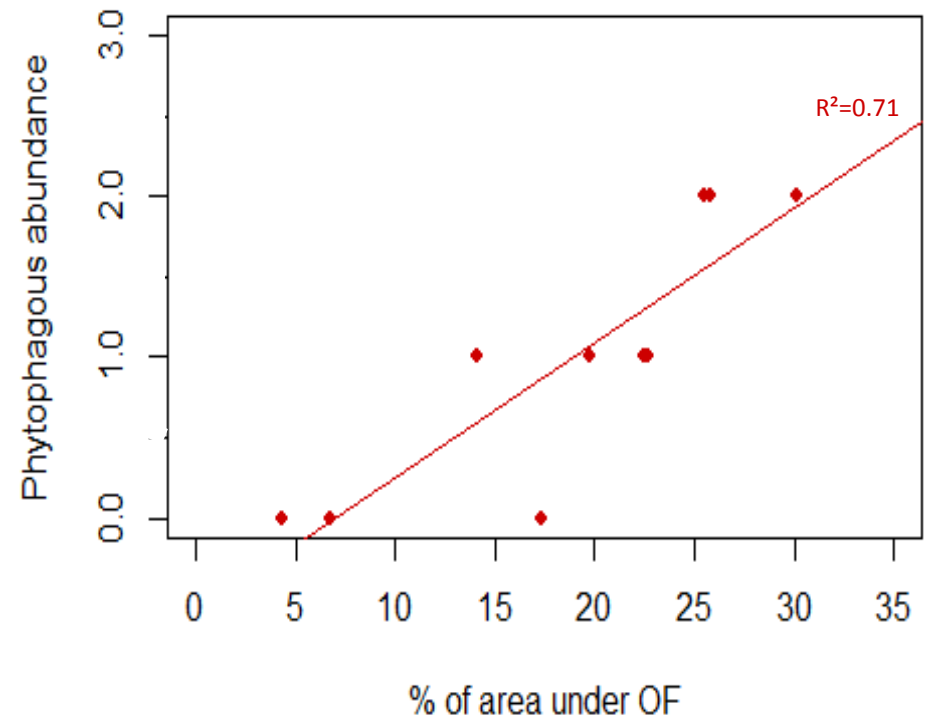

Increasing the percentage of organic farming in **the** landscape :

- ↗ abundance **of** circulating communities in CF
- ↗ abundance **of** circulating phytophagous species in CF

Conclusions

- Differences in species composition :
 - OF : phytophagous species
 - CF : collembola eaters
- ↳ Communities structure driven by **resources availability**.

Conclusions

➤ Differences in species composition :

- OF : phytophagous species
- CF : collembola eaters

↳ Communities structure driven by **resources availability.**



Organic farming



Conventional farming

Conclusions

- Differences in species composition :
 - OF : phytophagous species
 - CF : collembola eaters

↳ Communities structure driven by **resources availability**.



Organic farming

Conventional farming

- Abundances in circulating communities > in OF.
- Slight differences in abundances in emerging communities.
- Differences between circulating & emerging communities in OF.
 - ↳ OF acts as a **sink** → attractiveness of crops

Conclusions

➤ Differences in species composition :

- OF : phytophagous species
- CF : collembola eaters

↳ Communities structure driven by **resources availability**.



Organic farming

Conventional farming

➤ Abundances in circulating communities > in OF.

➤ Slight differences in abundances in emerging communities.

➤ Differences between circulating & emerging communities in OF.

↳ OF acts as a **sink** → attractiveness of crops

➤ Abundances increase in circulating communities in CF in relation with the augmentation of OF percentage in **the** landscape.

↳ OF acts as a **source** → dispersion/dynamics at landscape scale

To go further ...

Interactions between systems

To go further ...

Interactions between systems



Isotopic tool → identifying and quantifying migrant flows

To go further ...

Interactions between systems



Isotopic tool → identifying and quantifying migrant flows

- Changes in soil's isotopic labelling :
 - differences in fertilization methods
 - differences in organic matter origin

To go further ...

Interactions between systems



Isotopic tool → identifying and quantifying migrant flows

- Changes in soil's isotopic labelling :
 - differences in fertilization methods
 - differences in organic matter origin

- Isotopic labelling transmission from soils to ground beetle ?

First results : Isotopic labelling

❖ Isotopic labelling of emerging individuals

Metallina lampros pros

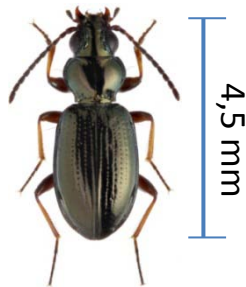
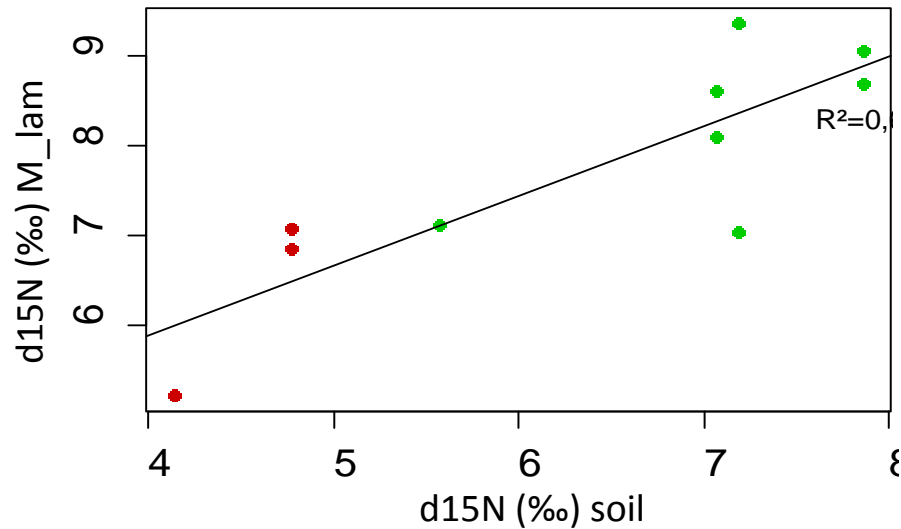

Anchomenus dorsalis alis

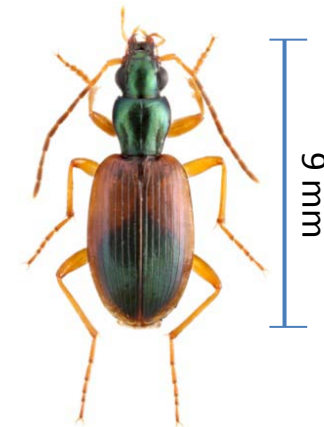
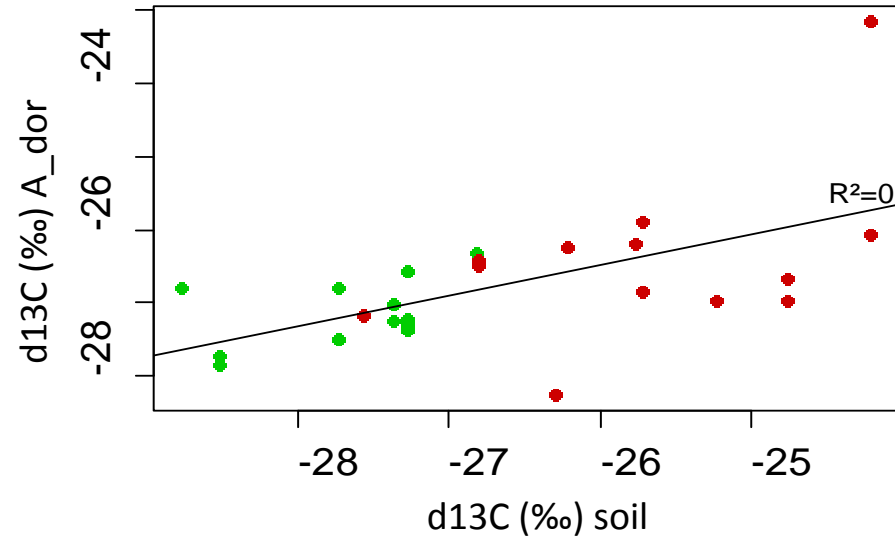

Isotopic labelling

❖ First conclusions

- Coherence soil / ground beetle isotopic labelling
 - ↳ confirms usefulness of the method
- High intraspecific variability → no individual assignment

Isotopic labelling

❖ First conclusions

➤ Coherence soil / ground beetle isotopic labelling

↳ confirms usefulness of the method

➤ High intraspecific variability → no individual assignment

➤ **The** method allows the evaluation of the contribution at populational scale.



importance and **temporality exchanges**
between both farming systems.

Prospects

➤ Organic farming :

- sink in spring → attractiveness of crops
- source at farm scale → management and type of marginal areas
- source at the scale of multiannual dynamics

Prospects

➤ Organic farming :

- sink in spring → attractiveness of crops
- source at farm scale → management and type of marginal areas
- source at the scale of multiannual dynamics

➤ Take into account:

- landscape features associated with **farming** systems
- temporal variability of habitats

to **assess** :

- relative contribution of **farming** systems for auxiliary production
- exchanges of migrants between **farming** systems

and thus **quantify** their influence in terms of biological control.

Prospects

➤ **Organic farming :**

- sink in spring → attractiveness of crops
- source at farm scale → management and type of marginal areas
- source at the scale of multiannual dynamics

➤ Take into account:

- landscape features associated with farming systems
- temporal variability of habitats

to assess :

- relative contribution of farming systems for auxiliary production
- exchanges of migrants between farming systems

and thus **quantify** their influence in terms of biological control.

➤ Utilization of **isotopic tool** to characterize the **migrant flows** between farming systems.

Thank you for your attention.

