



HAL
open science

Control of syntectonic erosion and sedimentation on kinematic evolution of a multidecollement thrust zone: Analogue modeling of folding in the southern subandean of Bolivia

Romain Darnault, Jean-Paul Callot, Jean-François Ballard, Guillaume Fraise, Jean-Marie Mengus, Jean-Claude Ringenbach

► To cite this version:

Romain Darnault, Jean-Paul Callot, Jean-François Ballard, Guillaume Fraise, Jean-Marie Mengus, et al.. Control of syntectonic erosion and sedimentation on kinematic evolution of a multidecollement thrust zone: Analogue modeling of folding in the southern subandean of Bolivia. *Journal of Structural Geology*, 2016, 89, pp.30-43. 10.1016/j.jsg.2016.05.009 . hal-01449660

HAL Id: hal-01449660

<https://hal.science/hal-01449660>

Submitted on 30 Jan 2017

HAL is a multi-disciplinary open access archive for the deposit and dissemination of scientific research documents, whether they are published or not. The documents may come from teaching and research institutions in France or abroad, or from public or private research centers.

L'archive ouverte pluridisciplinaire **HAL**, est destinée au dépôt et à la diffusion de documents scientifiques de niveau recherche, publiés ou non, émanant des établissements d'enseignement et de recherche français ou étrangers, des laboratoires publics ou privés.

1 **Control of syntectonic erosion and sedimentation on kinematic evolution of**
2 **a multidecollement thrust zone: Analogue modeling of folding in the**
3 **southern subandean of Bolivia..**

4
5 Romain Darnault¹, Jean-Paul Callot², Jean-François Ballard³, Guillaume Fraisse⁴, Jean-Marie
6 Mengus¹, Jean-Claude Ringenbach³

7 1 : IFP Energies nouvelles, 1-4 avenue de Bois Préau, Rueil Malmaison France

8 2 : LFCR UMR 5150, Université de Pau et des Pays de l'Adour, Avenue de l'Université,
9 64013, Pau France

10 3 : Total SA, CSTJF, Avenue Larribau, Pau, France

11 4 : ENSG, Avenue du Doyen Marcel Roubault, 54501, Vandoeuvre lès Nancy, France

12
13 **Abstract**

14 Several analogue modeling studies have been conducted during the past fifteen years with the
15 aim to discuss the effects of sedimentation and erosion on Foreland Fold and Thrust Belt,
16 among which a few have analyzed these processes at kilometric scale (Nalpas et al., 1999;
17 Barrier et al., 2002; Pichot and Nalpas, 2009). The influence of syn-deformation
18 sedimentation and erosion on the structural evolution of FFTB has been clearly demonstrated.
19 Here, we propose to go further in this approach by the study of a more complex system with a
20 double decollement level. The natural study case is the Bolivian sub-Andean thrust and fold
21 belt, which present all the required criteria, such as the double decollement level. A set of
22 analogue models performed under a CT-scan have been used to test the influence of several
23 parameters on a fold an thrust belt system, among which: (i) the spatial variation of the
24 sediment input, (ii) the spatial variation of the erosion rate, (iii) the relative distribution of

25 sedimentation between foreland and hinterland. These experiments led to the following
26 observations:

- 27 1. The upper decollement level acts as a decoupling level in case of increased
28 sedimentation rate: it results in the verticalization of the shallower part (above the
29 upper decollement level), while the deeper parts are not impacted;
- 30 2. Similarly, the increase of the erosion rate involves the uplift of the deeper part (below
31 the upper decollement level), whereas the shallower parts are not impacted;
- 32 3. A high sedimentation rate in the foreland involves an inversion of the vergence
33 followed by a back-thrusting of the shallower part.
- 34 4. A high sedimentation rate in the hinterland favors thrust development toward the
35 foreland in the shallower parts.

36

37 **1. Introduction**

38 Several studies have shown the influence of surface processes on the structural evolution of
39 fold and thrust belt systems, both at the scale of lithosphere and of thrust belt system, based on
40 analogue modelling (Cobbold et al., 1993; Malavieille et al., 1993; Baby et al., 1995; Storti et
41 McClay, 1995; Tondji Biyo, 1995; Mugnier et al., 1997; Chemenda et al., 2000; Diraison et
42 al., 2000; Koyi et al., 2000; Leturmy et al., 2000; Nieuwland et al., 2000; Storti et al., 2000;
43 Bonini, 2001, Smit et al., 2003). Among them, several studies already tried to analyze the
44 relative importance of controlling parameters such as erosion, sedimentation, decollement
45 coupling efficiency and dip, and ratio between ductile and brittle layer at the scale of unitary
46 compressive structures (Tondji Biyo, 1995; Nalpas et al., 1999; Casas et al., 2001; Barrier et
47 al., 2002; Nalpas et al., 2003; Gestain et al., 2004; Pichot and Nalpas., 2009; Vidal-Royo et
48 al., 2011; Barrier et al., 2013; Drieheaus et al., 2014). In particular, these studies demonstrated
49 the fundamental role played both by syn-kinematic sedimentation and erosion on the

50 evolution of geological structures during compression. However, single decollement system,
51 if already quite well understood, are quite rare: most of the time, the presence of several
52 decollement levels within the stratigraphic pile tends to isolate several systems that can or not
53 be decoupled from each other, depending of various parameters among which external factors
54 like sedimentation and/or erosion, deformation rate, a strong rheological contrast (e.g.
55 Couzens-Schultz et al., 2002). Only a few studies focused on the impact of these parameters if
56 the mechanical pile includes several prekinematic decollement level, namely two (e.g.
57 Couzens-Schultz et al., 2003; Pichot et al., 2009) or three (e.g. Driehaus et al., 2014), which is
58 nevertheless a quite common natural case, observed in the Zagros fold-and-thrust belt (Verges
59 et al., 2011), the bolivian subandean belt (Baby et al., 1999; Labaume and Moretti, 2001), or
60 else the Rocky Mountains (e.g. Lebel et al. 1996) for instances.

61 They showed that deformation is strongly dependent on sedimentation rate: (i) the structures
62 propagate forward with an overall asymmetric shape if the sedimentation is slower than the
63 uplift velocity, (ii) the structures grow vertically and can present vergence inversion at the
64 surface if the sedimentation rate is similar to the uplift velocity, and (iii) the structures grow
65 vertically with a double vergence at the surface and at depth if the sedimentation rate is higher
66 than the uplift velocity (Barrier et al., 2013; Driehaus et al., 2014); eventually, if the
67 sedimentation rate is much higher than the tectonic uplift rate, a symmetrical pop-up,
68 independent from the internal mechanical stratification, forms. These experiments showed
69 that the kinematic scenario of the fold development appears to be the first order element that
70 discriminate the various interferences between sedimentation and fold growth.

71 Following Driehaus et al. (2014), the present study aims at the characterization of the fold
72 kinematic scenario analysis, in order to properly constrain the relative importance of internal
73 factors such as rheological stratigraphy and kinematic boundaries, upon external forcing such
74 as sedimentation and erosion. To fulfill that goal, we propose a set of analogue models

75 imaged with an X-ray CT scanner (Colletta et al., 1991), which allows for a non destructive
76 3D, time repeated acquisition of the internal model geometry. It thus offers access to the
77 kinematic evolution of the geometries. These experiments aim at completing the previous
78 studies set in 2D, and to characterize both in 3D and through time the influence of external
79 factors (sedimentation and erosion) on a decoupled system known in the literature: the sub
80 Andean compressive system. This geological case is also a strategic petroleum basin
81 representing crucial economic issues that depends of the geological knowledge of the area.
82 The understanding of the 3D structural evolution is thus crucial for this area. However, due to
83 the geometric complexity of such geological systems, seismic imagery can't mostly provide
84 well-defined images of the deeper part of such folded systems (Figure 1). It is thus crucial to
85 understand the evolution of the superimposed structures of these areas to provide pertinent
86 interpretation and assessments of eventual HC resources. In a first approximation, analogue
87 modelling can bring elements to better understand these complex structural domains and some
88 relationships between shallow and deep-seated structures.

89

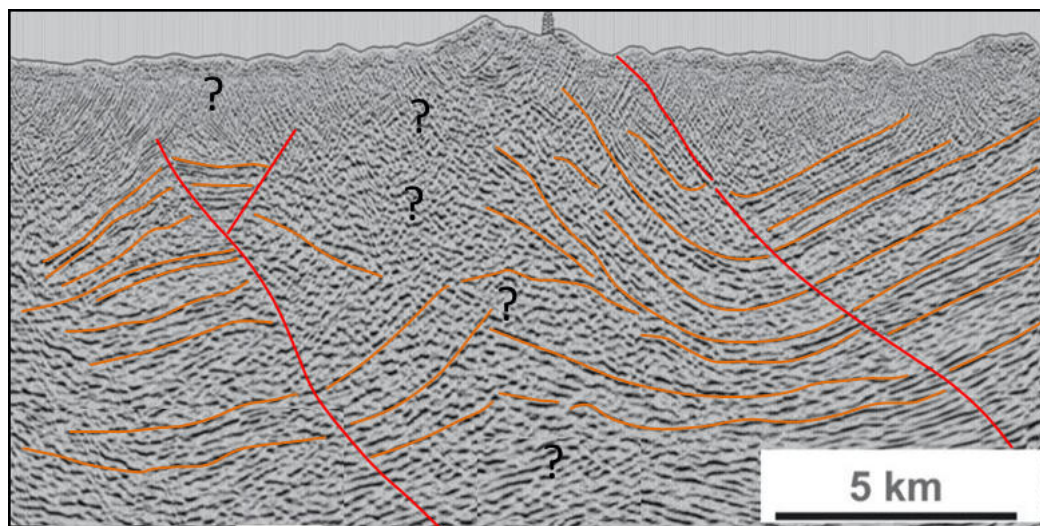

90

91 **Figure 1:** Example of seismic profile in sub-Andean zone. The geometrical complexity doesn't allow a well-
92 defined seismic imagery.

93

94 **2. Geological and geographical settings**

107 major decoupling levels (namely the Kirusillas, Icla and Los Monos formations) alternating
108 with sandstones levels (Tarabuco, Santa Rosa, Huamampampa and Iquiri formations; Moretti
109 et al., 2002). The Subandean Carboniferous-Early Permian cycle is characterized by the
110 deposition of marine to glacial sands and diamictites, indicating a periglacial environment.
111 The carboniferous deposits (Machareti and Mandiyuti groups) have a total thickness of about
112 2 km, composed mainly of sandstones (Tupambi, Chorro and Escarpment Fms).
113 The overlying sediments are mainly continental, with few hundred meters of Lower Permian
114 fluvial-eolian sandstones (Cangapi Formation), a few tens of meters of evaporitic Upper
115 Permian carbonates (Vitiacua Formations), Lower Triassic anhydrite/gypsum and about 1 km
116 of upper Triassic to Cretaceous fluvial and eolian sandstones (Tacuru Gr.). The Yecua
117 Formation presents lacustrine facies with locally marine influences (Marshall et al., 1993).
118 Above these units, the foreland sequences of Lower and Upper Chaco are composed of distal
119 clastic facies of fluvial plains (with anastomosed fluvial channels) evolving to more proximal
120 facies characterized by conglomeratic beds (Moretti et al., 2002).

121

122 **2.2 Structural setting**

123 The SAZ is a Neogene, east-verging, thrust system that constitutes the Eastern border of
124 Andes with a width of about 150 km. The main thrusts have an average spacing of 15 km with
125 a displacement of several km (Figure 2c). This thrust system involves the Upper Silurian to
126 Quaternary succession, which is about 10 km thick. The main basal decollement level has
127 been defined as located in the Silurian shales (Baby et al., 1993; Colletta et al., 1999), while
128 secondary decollements are located in the Middle Devonian (Icla and Los Monos Formations)
129 and locally in the Carboniferous diamictites (Moretti et al., 2002). Note that Devonian shaly
130 formations are also the source-rocks of the petroleum systems, the maturation of which could
131 have influenced the decollement localization and timing of activity (e.g. Cobbold et al. 2009).

132 Folds and thrusts geometries are mainly controlled by lithology and by these decollement
133 levels. Among the sub-andean structure, the Incahuasi trend has the particularity to be west
134 verging, and offset by at least 1 km to the East (DrieHaus et al., 2014). The shallow part of the
135 fold has a west vergence, while the other folds are oriented toward the East (Figure 2c).
136 DrieHaus et al. (2014) explained this difference of vergence by the effect of the sediment rate
137 variation.

138 The development of the structural system started during the Late Oligocene (27 Ma ago) and
139 implies a general eastward propagation of the thrust system (Baby et al., 1993; Gubbels et al.,
140 1993; Moretti et al., 1996), although deformation in the Eastern Cordillera may have started
141 earlier (Buttler et al., 1995).

142 Shortening in the sub-Andean zone is relatively recent and occurred mainly between the
143 Upper Miocene (6 Ma from apatite fission track and tuff intercalations; Moretti et al., 1996)
144 and present (Gubbels et al., 1993; Labaume et al., 2001), resulting in the uplift and erosion of
145 the anticlines.

146
147

148 **3. Experimental procedure**

149 **3.1. Experimental set-up:**

150 Analogue models were built in a 70 x 40 cm wood deformation box (Figure 3). The box
151 presents two free sides and two walls: the first one is fixed and the second one is mobile and
152 linked to a stepper motor allowing shortening. For this set of experiments, we choose to focus
153 on the modeling of one typical fold structure representing the evolution of the Incahuasi fold.
154 For this reason, a moving carpet is attached to the mobile wall generating a velocity
155 discontinuity in the middle of the box (Figure 3), which localizes the initiation of the structure
156 on the velocity discontinuity location that represents either a deep-seated fault or else the tip
157 line of the basal decollement level. In addition, this discontinuity allows studying the

158 evolution of a single fold avoiding the parasitic influence of neighboring structures. All the
159 experiments have been performed under an X-ray tomographer for a 3D imagery. The use of
160 this technology allows a non-destructive 3D-image acquisition at regular stages of evolution
161 of the model, with the possibility to reconstruct 3D geometries at different deformation stages
162 (Colletta et al., 1991).

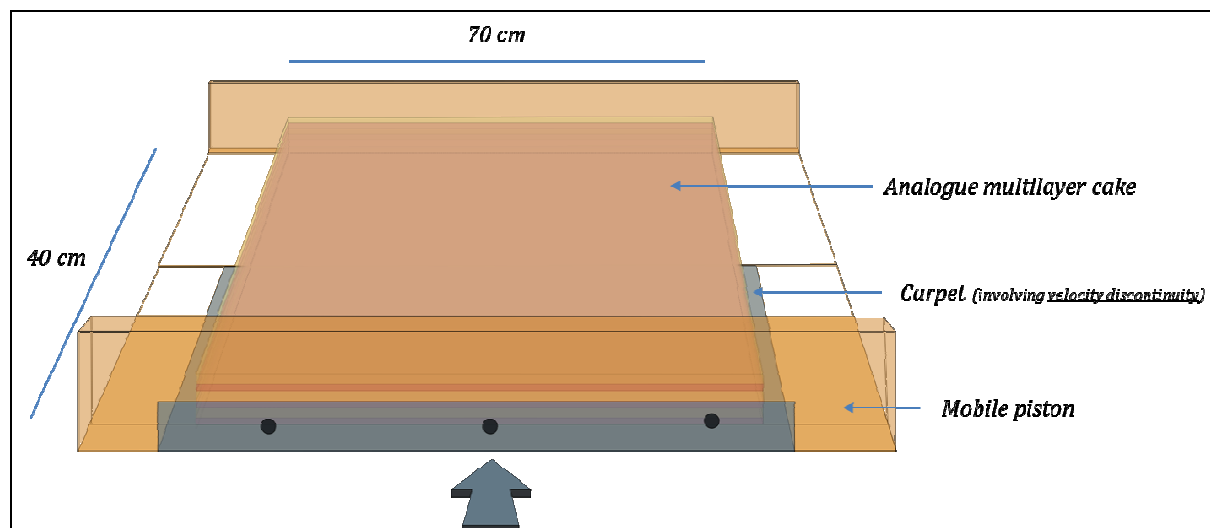

163
164 **Figure 3:** Illustration of the deformation box used for analogue model. The mobile wall is animated by a stepper
165 motor, which is set up to generate a constant shortening. A velocity discontinuity is generated by the carpet,
166 which is linked to the mobile wall.
167

168 The models were scaled for length, viscosity and time, following the basic principles,
169 discussed by Hubbert (1937) and Ramberg (1981). The length ratio between models and
170 natural examples is 10^{-5} (1 cm in the model represents 1 km in the nature). The viscosity ratio
171 is of the order of $2 \cdot 10^{-15}$ considering a 10^{16} Pa.s as a mean viscosity for mobile shales. The
172 time ratio equals thus to $1 \cdot 10^{-10}$. This analogue modeling protocol does not allow taking into
173 account some geological parameters such temperature gradient or rheological changes, among
174 others.

175

176 **3.2. Analogue material:**

177 Three types of analogue material were used to simulate different rheological behaviors:

- 178 - dry granular materials to simulate brittle sedimentary rocks, which obey to a Mohr-
179 Coulomb failure criterion;
- 180 - viscous Newtonian material to simulate ductile rocks such as shales, acting as
181 decollement levels;
- 182 - a mixture of viscous material (silicone putty) with granular material (sand) in order to
183 increase the viscosity of this layer and allowing a greater coupling between ductile and
184 brittle layer (see Callot et al., 2012 for the material scaling).

185 Sedimentary brittle rocks were simulated using sand, pyrex and microbeads with a grain size
186 of 100 μm . Sand has a negligible cohesion, an angle of internal friction of 30° and a density
187 close to 1600 kg/m^3 (depending on sieving procedures). Pyrex has approximately the same
188 brittle behavior than sand but a contrasted radiological density, which differentiates them on
189 tomographic images. Microbeads have a similar brittle behavior but an angle of internal
190 friction of 20° (Schreurs et al., 2006), which promotes low angle thrusting behavior in the
191 model. Layers of silicon putty (SGM36) simulate the ductile behavior of weak layers,
192 corresponding to the decollement levels in the sub-Andean case. Silicone behaves as a
193 Newtonian fluid, with a density close to 1 g.cm^{-3} and a viscosity of $2.5 \cdot 10^4 \text{ Pa.s}$ at room
194 temperature and strain rates below $3 \cdot 10^{-3} \text{ s}^{-1}$.

195

196 **3.3. Experimental design**

197 Each model is based on a single rheological and stratigraphic pile, defined by Driehaus et al.
198 (2014) (Figure 4): A 6 mm thick silicone layer models the main basal Silurian decollement
199 level. The Late Silurian to Devonian units (Tarabuco formation to Huamampampa formation)
200 are modelled by a 10mm-thick alternance of 3mm tick sand and microbeads. The decollement
201 of the Middle Devonian (Los Monos Formation) is represented by a 5-7 mm thick silicone
202 layer inside this unit. The top of the sequence corresponding to Carboniferous to Cretaceous

203 series is modeled by two couples of sand and pyrex layers (respectively 10 and 12 mm thick)
 204 separated by a 3 mm thick mixture of sand/silicone (50%/50% weight proportion). A thin
 205 layer, less than 1 mm thick, of pumice powder marks the boundary between pre-kinematic
 206 sedimentation and syn-kinematic sedimentation. A shortening rate between 1,5 and 1,7 cm/h
 207 is applied. During the experiment, syn-kinematic sedimentation is performed by sprinkling
 208 sand on top of the model. Syn-kinematic sedimentation is composed of alternating sand and
 209 pyrex layers. Amount of sedimentation and erosion are determined by ratios allowing the
 210 characterization of each model, as explained in Driehaus et al. (2014):

- 211 - The “R” ratio represents the amount of sedimentation with $R = \text{Velocity of sedimentation} / \text{Velocity of uplift}$.
- 212
- 213 - The “E” ratio represents the amount of erosion with $E = \text{Velocity of erosion} / \text{Velocity of uplift}$.
- 214

215 The X-ray tomographer allows the observation of the experiment state in real time, which is
 216 helpful for the estimation of the amounts of sediments that have to be added or removed.

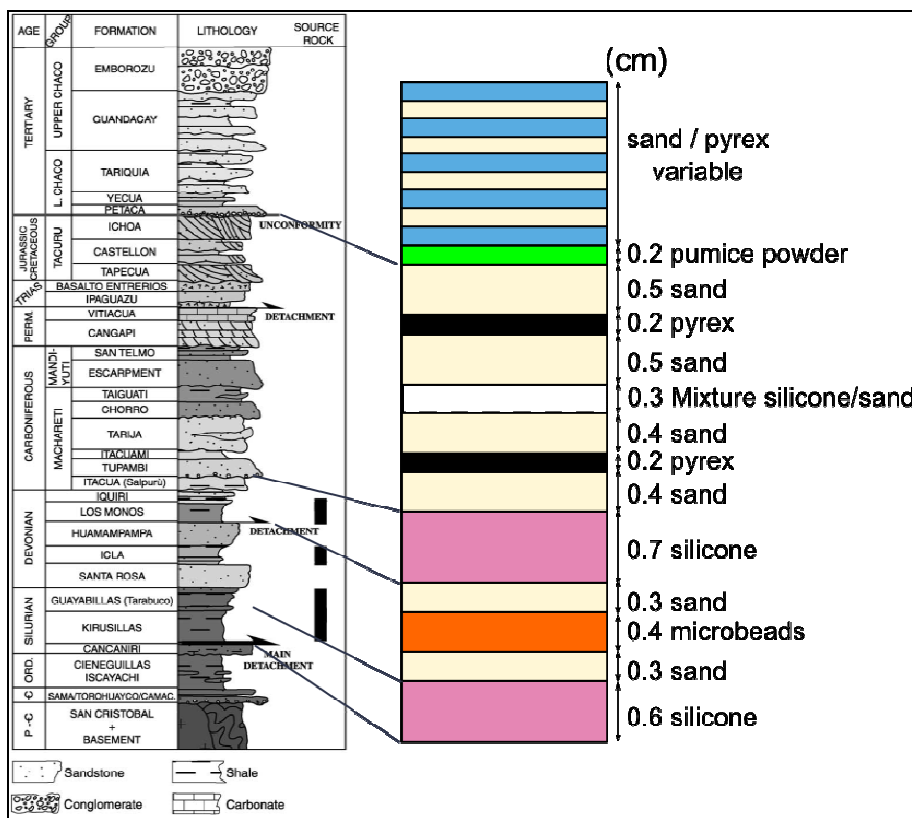

217

218 **Figure 4:** Analogue rheology used for experiments. The stratigraphic column is from Moretti et al.(1996).
219
220 3.4. Reproducibility of the results.

221 Numerous experiments have been performed since the initial presentation of the use of X-Ray
222 tomography technology for a sandbox model (Colletta et al., 1991). Their reproducibility
223 depends on the building precision of the layered sequence. The influence of subtle, wavy
224 undulations (relief less than 0.5 mm) that may occur in the silicone layer is always controlled
225 with the scanner imagery to be sure that the model is homogenous. If the cylindricity of the
226 structures is preserved above non-cylindrical irregularities, their effect is negligible and the
227 result considered reliable. This test is easily performed as (1) the deformation box is longer
228 along the strike direction than along the shortening direction, and (2) as the X-Ray scanner
229 gives a continuous 3D view with a spatial resolution better than 0.3 mm.

230

231 **4. Analogue model results**

232

233 **4.1 Preliminary calibration experiment**

234 A set of analogue experiments has been performed for this study to observe the spatial
235 influences (in 3D) of (i) sedimentation, (ii) erosion, (iii) localized sedimentation and (iv)
236 rheology, on syn-kinematic evolution of a Sub-Andean mono-structure type. Before realizing
237 this set of experiments, a preliminary test was been performed to scale and calibrate
238 experimental parameters with respect to already published analogue models (Driehaus et al.,
239 2014, Figure 5).

240 The lower structure behaves as a duplex for six and eight percent of shortening and wraps on
241 itself at higher shortening amount (24%). This geometry fit with the exploration data available
242 for the analogue natural case (e.g. Driehaus et al., 2014).

243 The upper structure behaves as an asymmetric fold, which as a fish-tail structure, the lower
 244 thrust grading upward as a flat in the upper decollement level, triggering a second, antithetic
 245 thrust ramp in the upper pre-tectonic and syn-tectonic sequences. (Figure 5, compression of
 246 6% and 8%). For higher shortening amount (24%), the fold vergence changes again,
 247 developing a thrust, synthetic to the lowermost one, and rooted along the fold limb in the
 248 upper decollement level. This thrust decapitates the tight fold's head. These results are in
 249 close agreement with the experiments of Driehaus et al (2014) and their 2D analyses.

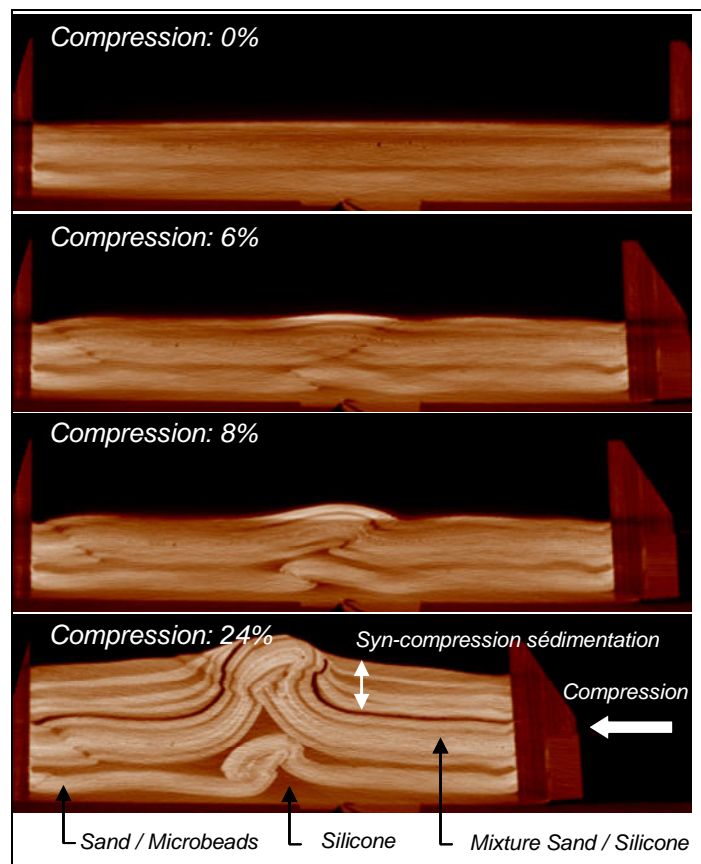

250

251 **Figure 5:** Results of the first experiment realized to test the mechanical behaviour of the model with scaled
 252 parameter (rate of compression is 1,7 cm/h; choice of material and thickness of layers: **Figure 4**). For this
 253 experiment, syn-kinematics sedimentation and erosion have been established following the results obtained by
 254 Pichot et Nalpas, 2009: For sedimentation, $R=1/2$. For erosion, $E=1/4$ (see section 3.3 for more details of R and
 255 E ratios).
 256

257 4.2. Influence of sedimentation

258 The aim of this experiment was to test the influence in 3D of sedimentation on the
 259 development of a folded structure.

260 4.2.1. Experimental set up

261 This experiment was set up using the rheology established previously (Figure 4) and the same
262 deformation rate. No erosion was performed for this experiment. Differential sedimentation
263 was applied during shortening along the deformation box in order to obtain a R ratio ranging
264 from 1/2 to 1 along strike of the growing structure.

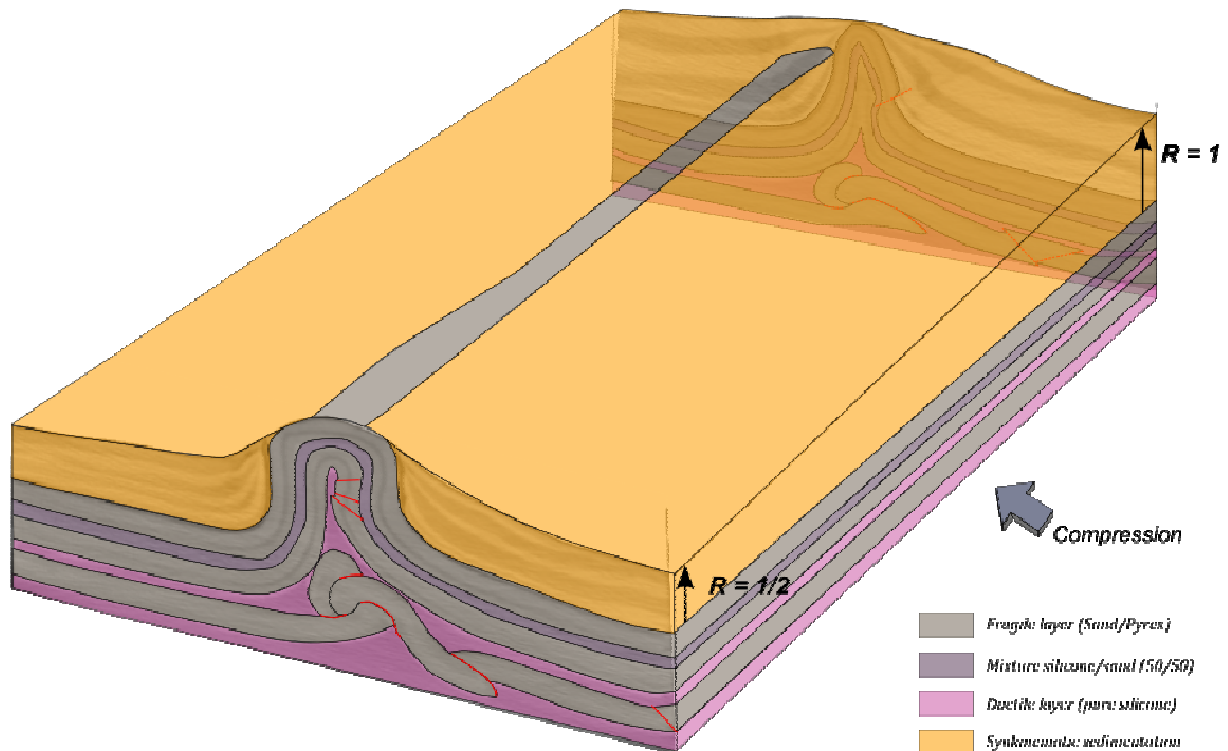

265
266 **Figure 6:** 3D sketch of the model performed to study the syn-kinematic impact of sedimentation in 3D. The
267 sedimentation rate vary along the deformation box, from R=1 to R=1/2. No erosion has been performed and a
268 compression rate of 1,7 cm/h was applied. Red sticks show faults generate during the deformation.
269
270

271 4.2.2. Impact of the sedimentation rate distribution

272 The topography is directly impacted by the increase of sedimentation rate during the
273 compression (Figure 7 and Figure 8): Raise up of the topography follows high sedimentation
274 rate (R=1, Figure 8). In this case, the syn-kinematic sedimentation progressively pinches the
275 folded structure, which rises vertically in response to shortening, and is less faulted than in the
276 lower sedimentation case (compare figures 7C and D). This modification of topography
277 involves also a variation of the vergence for shallow structures (Figure 7C and Figure 9). In

278 case of high sedimentation compared to tectonic uplift, the shallow structure is much more
 279 symmetric and evolves from the fish-tail backthrust to a large scale pop-up.
 280 The depth structures appear not to be impacted by the syn-deformation sedimentation (Figure
 281 7C and D). Their geometries stand relatively flat all along the deformation box without
 282 vergence variation nor topographical modification.
 283

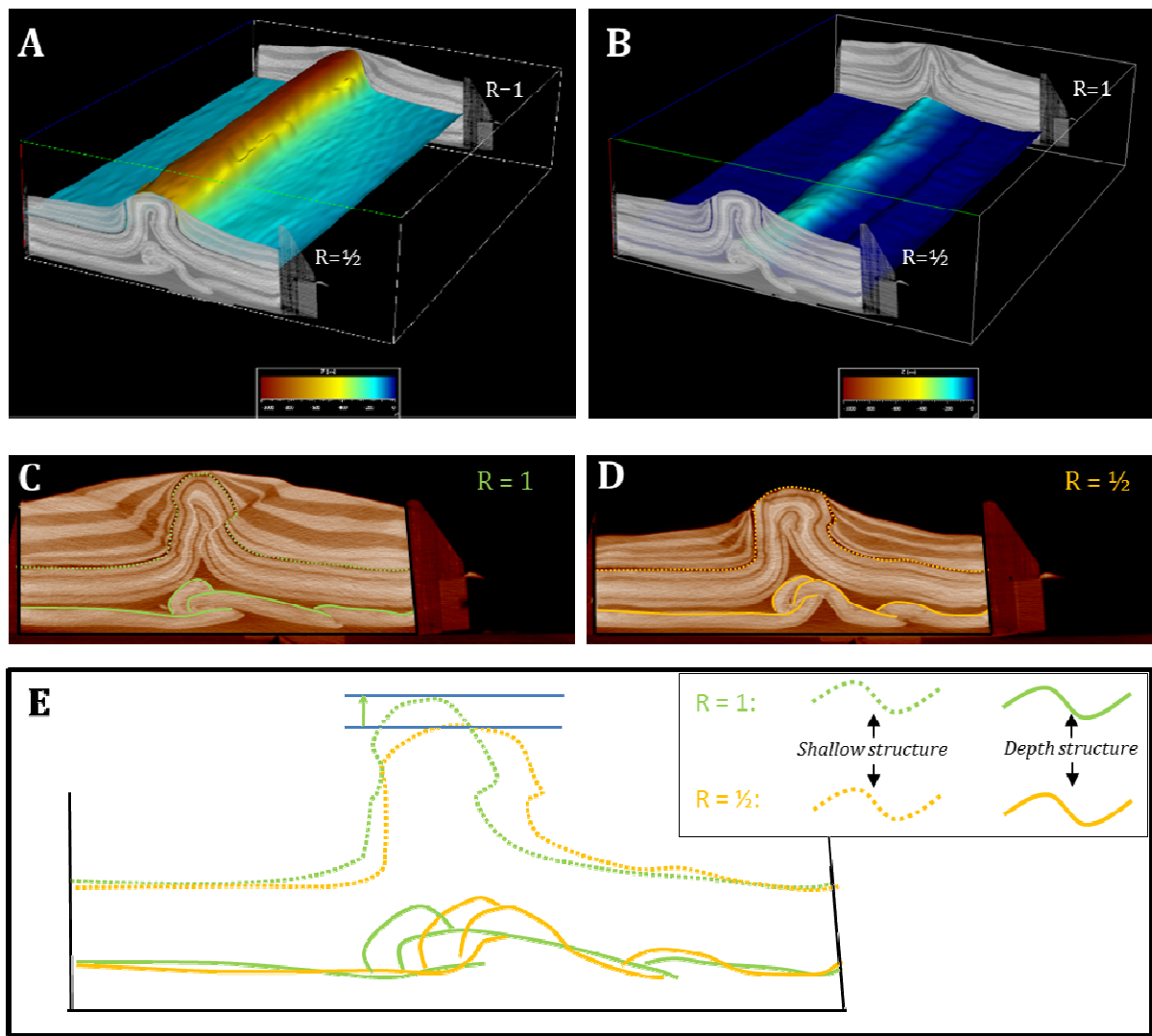

284

285 **Figure 7** : **A.** 3D bloc showing two inline sections bordering the elevation map of the shallow structure's top. It
 286 shows the uplift of the shallow structure for a high sedimentation rate (R=1). **B.** 3D bloc showing two inline
 287 sections bordering the elevation map of the depth structure's top. It shows the cylindricity of the depth structure,
 288 which is not impacted by the variation of the sedimentation rate. **C and D.** are Inlines corresponding to the high
 289 sedimentation rate (R=1) and low sedimentation rate (R=1/2), respectively. **E.** Superposition of the shallows
 290 (dashed lines) and depth horizons for a high sedimentation rate (in green) and a low sedimentation rate (in
 291 yellow); right part is the legend. It shows the delta between the elevation of the shallow structures subjected to a
 292 high sedimentation rate and the shallow structure subjected to a low sedimentation rate. In contrast, there is no
 293 delta for the depth structures.

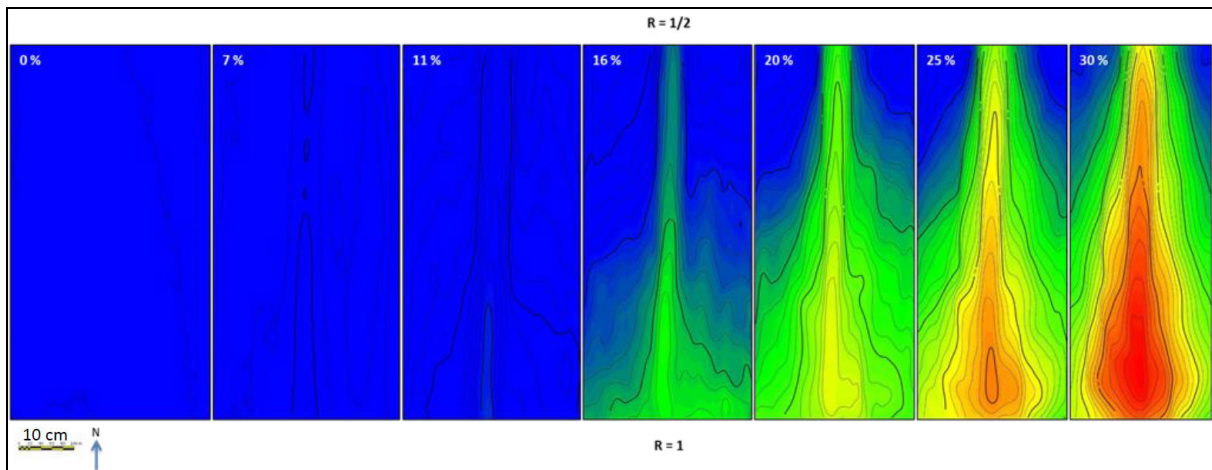

295
296
297
298
299
300
301
302

Figure 8: Map of the shallow structure (top of the model) illustrating the impact of the sedimentation on the model's topography with the increase of compression. Percentage in white corresponds to the amount of shortening. R ratio end members are located at both ends of the maps. The colour scale (from blue (0mm of elevation) and red (75 mm of elevation)) represents relative topography: It represents a different elevation of 9 mm between R=1 side and R=1/2 side.

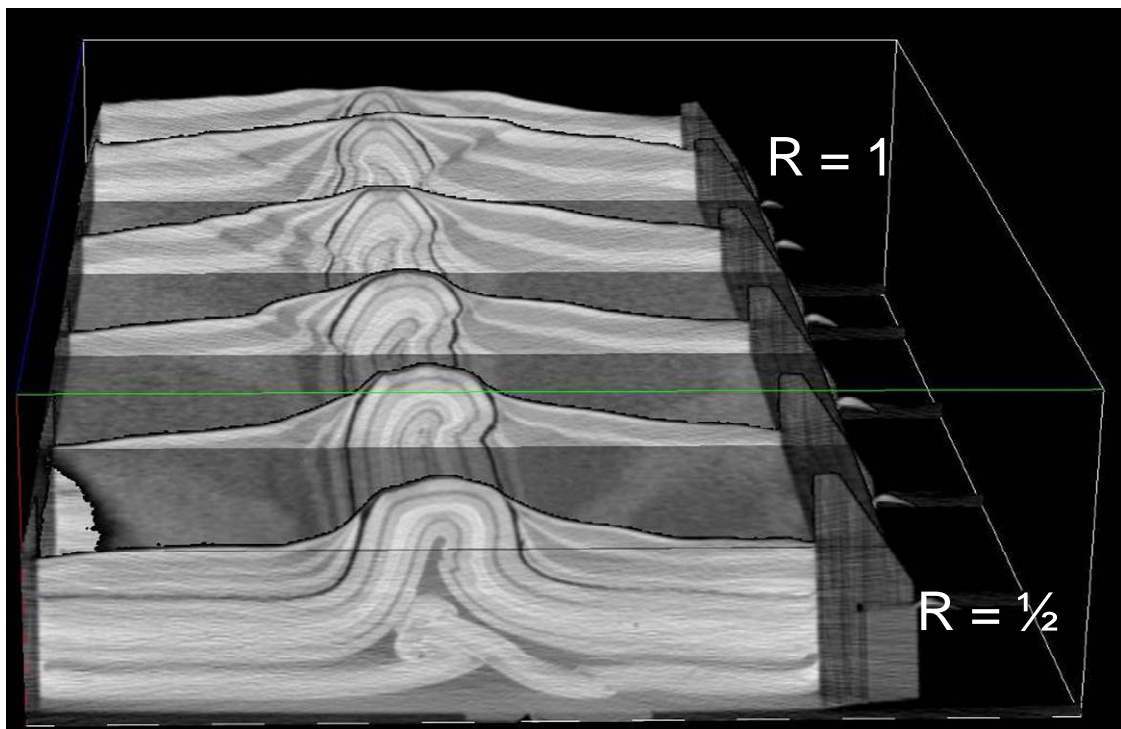

303
304
305
306
307
308

Figure 9: 3D view of the model showing the modification of shallow structure vergences: The background shallow structures (R=1) are verticals with a low left vergence, while foreground shallow structures (R=1/2) have a right vergence.

309 These observations, which are in agreement with the results of Driehaus et al (2014) show
310 that the system is highly decoupled because of (i) the ductile inter-bedded layer but also (ii)

311 by the syn-kinematic sedimentation. This 3D analysis brings new elements about the
312 geometrical variation in space induced by syn-compression sedimentation. This decoupling is
313 able to involve a vertical misfit between apexes of shallow and deep structures, despite a
314 general cylindrical aspect of the map view. Sedimentation impacts the shallow structure
315 evolution and constraints the deeper structure development, which appears more confined at
316 depth in the case of high sedimentation: high sedimentation forces the upright development of
317 the fold, and limits the elevation of the kink folds responsible for the fold development at
318 depth. The lower structure is thus pushed downward. On the contrary, for low sedimentation
319 rate, the propagation of the fish tail, and the formation of the second, synthetic, thrust
320 affecting the backlimb of the shallow fold, allows for a vertical growth of the deeper structure
321 below the upper ramp (figures 7C and 7D).

322
323

4.3. Erosion

324 The aim of this experiment was to test the influence of the 3D distribution of erosion on the
325 development of the folded structure.

326 4.3.1 Experimental setup

327 This experiment was set up using the rheology established previously (Figure 4) and the same
328 deformation rate (1,7 cm/h). We apply a constant sedimentation rate to reach $R = \frac{1}{2}$ over the
329 entire deformed model. Differential syn-compression erosion along strike of the deformation
330 box was applied to obtain a E ratio varying linearly from 0 to $\frac{1}{2}$ (Figure 10).

331

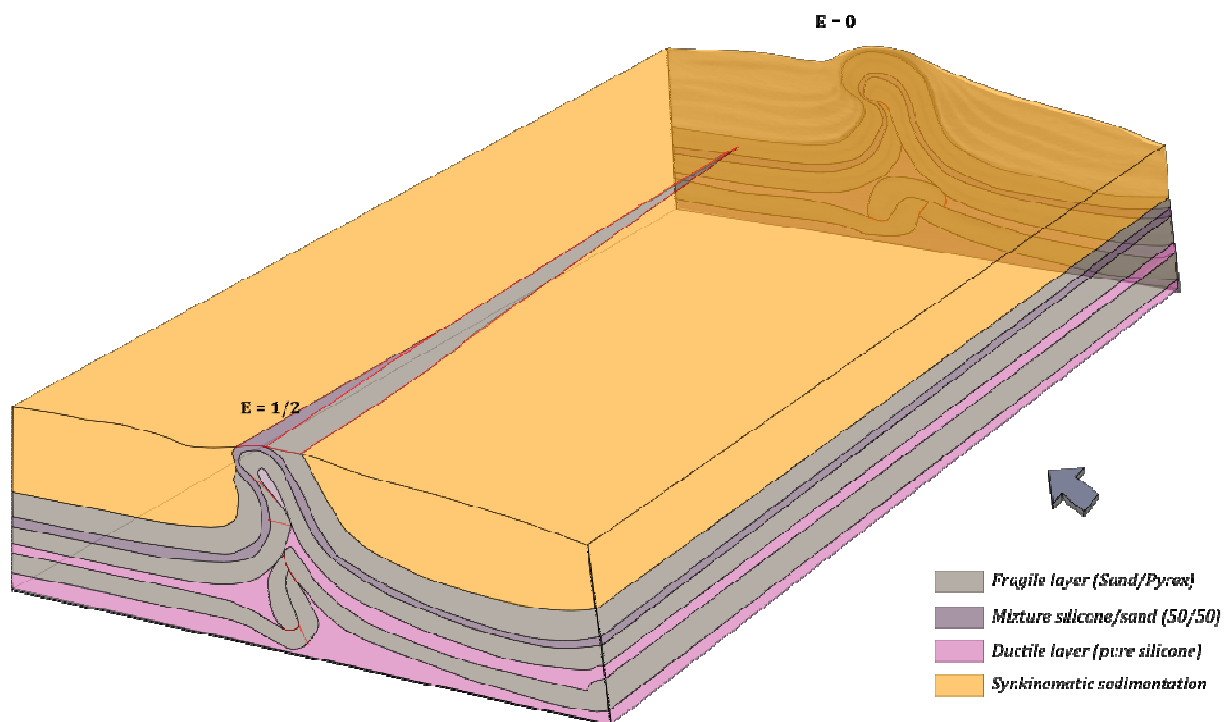

332

333 **Figure 10** : 3D sketch of the model performed to study the syn-kinematic impact of erosion in 3D. The
 334 sedimentation rate is constant along all along the model ($R=1/2$), while the erosion vary linearly along the
 335 deformation box, from $E=1/2$ to $E=0$. A compression rate of 1,7 cm/h was applied (thick arrow). Red sticks show
 336 faults generate during the deformation.

337

338

339

340

4.3.2 Observations of differences between low and high erosion rate

341 Several elements can be observed on Figure 11:

342 - Geometries of shallow structures are poorly impacted by erosion; these structures are
 343 principally controlled by compression and sedimentation rate as shown in previous sections.

344 Neither vergences nor topography appear impacted by the variation of erosion rate on shallow
 345 structures, apart from the direct effect of erosion. Nevertheless, the steep fold limb appears
 346 steeper and more folded if associated to erosion.

347 - Geometries of deep structures are strongly impacted by erosion. Topography of the apex of
 348 depth fold rise when erosion is high ($E=1/2$) (Figure 11C and Figure 12) and stands relatively
 349 flat when erosion is null (Figure 11D and E, and Figure 12).

350 The most impressive modification of the model behaviour, related to the increase of erosion
 351 with respect to tectonic topography, is the strong and localized uplift of the lowermost

352 structure. Contrarily to the previous model (figure 7) in which the upper fold kinks were fixed
 353 in space, enhanced unloading due to erosion allows for a vertical migration of the upper fold
 354 kinks, and thus for the space creation and the uplift of the lower structure.

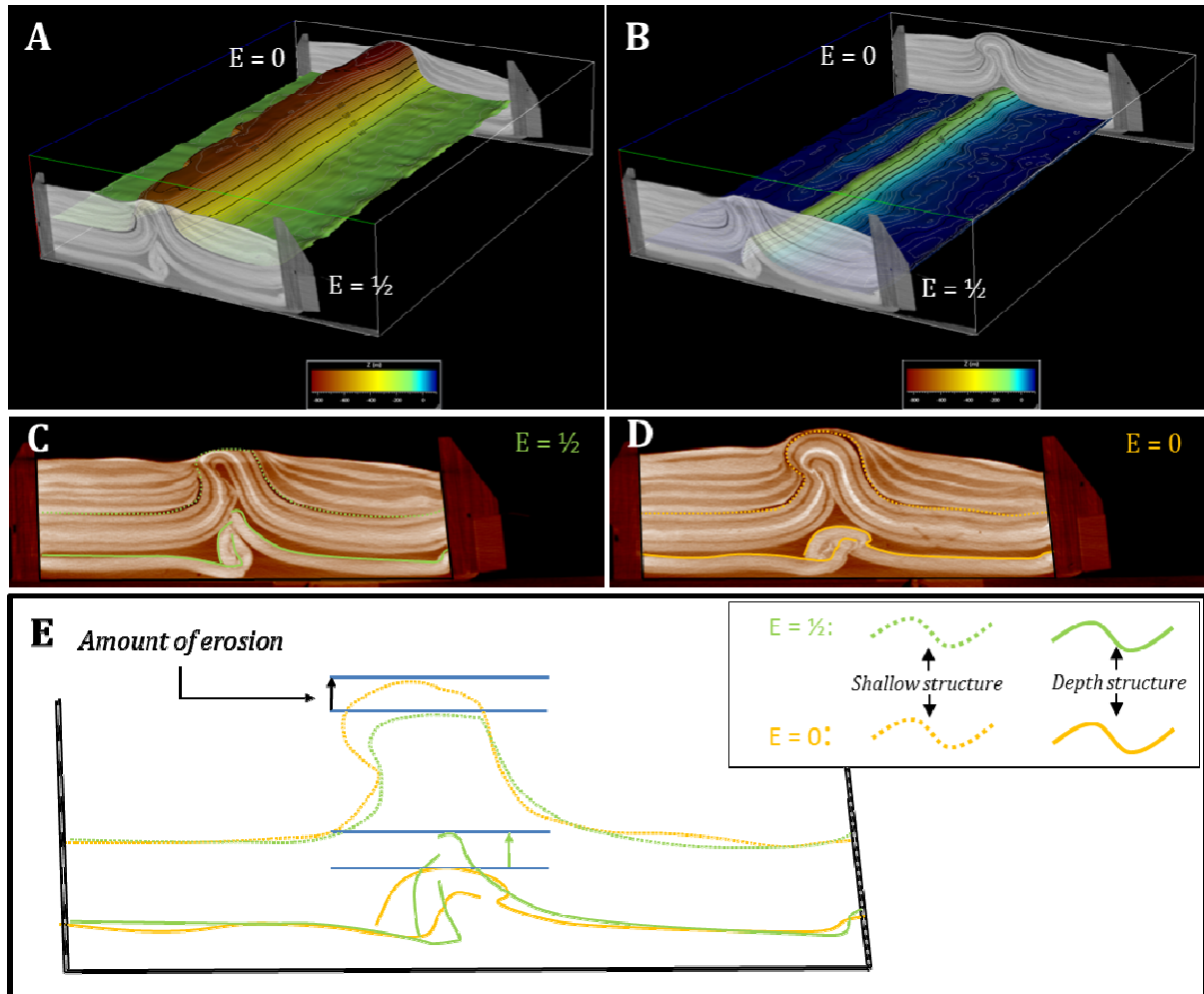

355
 356 **Figure 11:** **A.** 3D bloc showing two inline sections bordering the elevation map of the shallow structure's top.
 357 The shallow structure is not affected by syn-deformation erosion and is cylindrical all along the deformation box.
 358 **B.** 3D bloc showing two inline sections bordering the elevation map of the depth structure's top. The map shows
 359 an uplift of the depth structure in the high erosion part. **C and D.** Inlines corresponding to the high erosion rate
 360 ($E = \frac{1}{2}$) and no erosion ($E = 0$), respectively. **E.** Superposition of the shallows (dashed lines) and depth horizons for
 361 a high erosion rate (in green) and a low erosion rate (in yellow). It show the delta between the elevation of the
 362 depth structures subjected to a high erosion rate and the depth structures not affected by erosion. This delta is
 363 also present for the shallow structures and represents the amount of erosion of the surface

364
 365 On one hand, the interbedded layer of silicone generates a decoupling between
 366 shallow and deep structures. On the other hand, a high syn-kinematic erosion rate
 367 leads to a different behaviour between deep and shallow structures. The decoupling
 368 between deep and shallow structures is thus magnified by syn-kinematic erosion,

369 which involves a lateral misfit between apexes of shallow and deep structures (Figure
370 13). This misfit could have crucial implications in surface locations and trajectories of
371 exploration and production wells in such area..

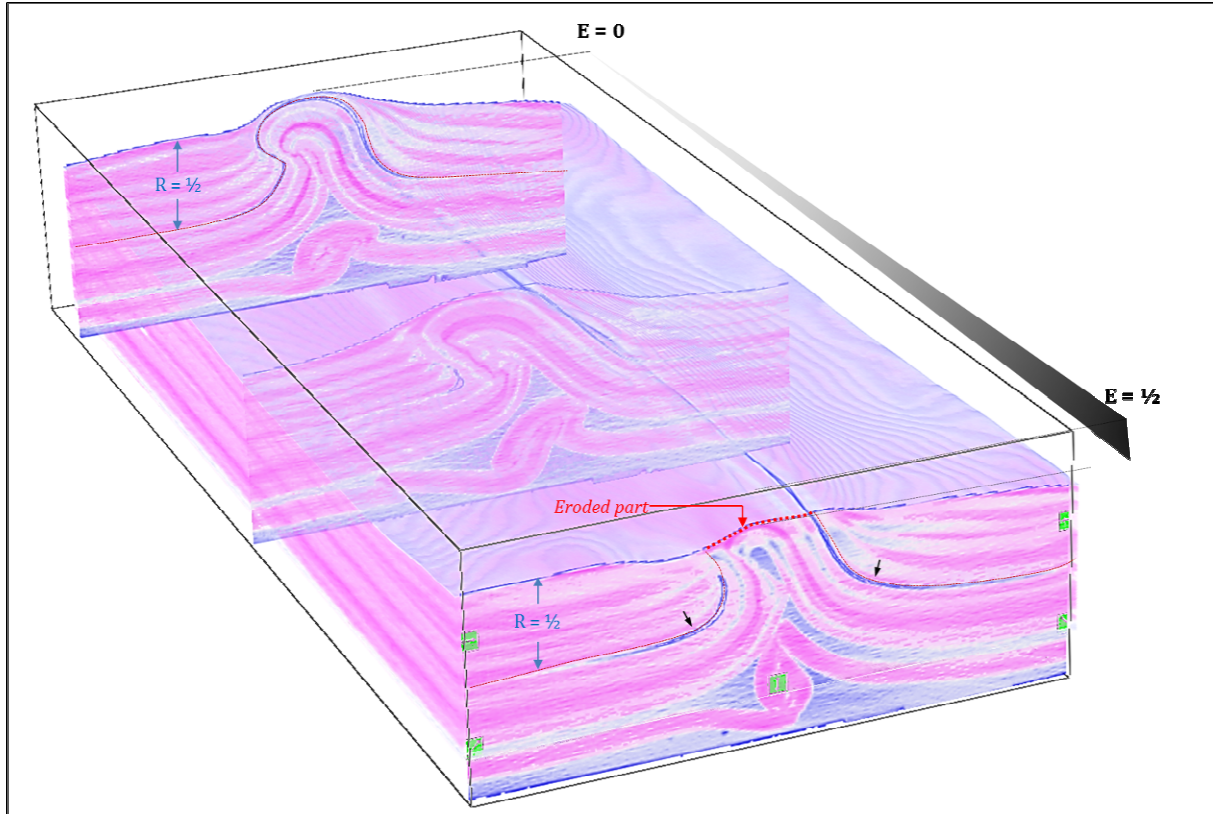

372

373 **Figure 12** : 3D view of the model performed to study the syn-kinematic impact of erosion. Sedimentation rate is
374 constant along the box ($R = \frac{1}{2}$; blue arrow) and erosion vary linearly along the deformation box from $E=0$ to
375 $E=\frac{1}{2}$. Black arrows show the thin pumice powder level in blue (less than 1mm), which marks the beginning of
376 syn-kinematic sedimentation.
377

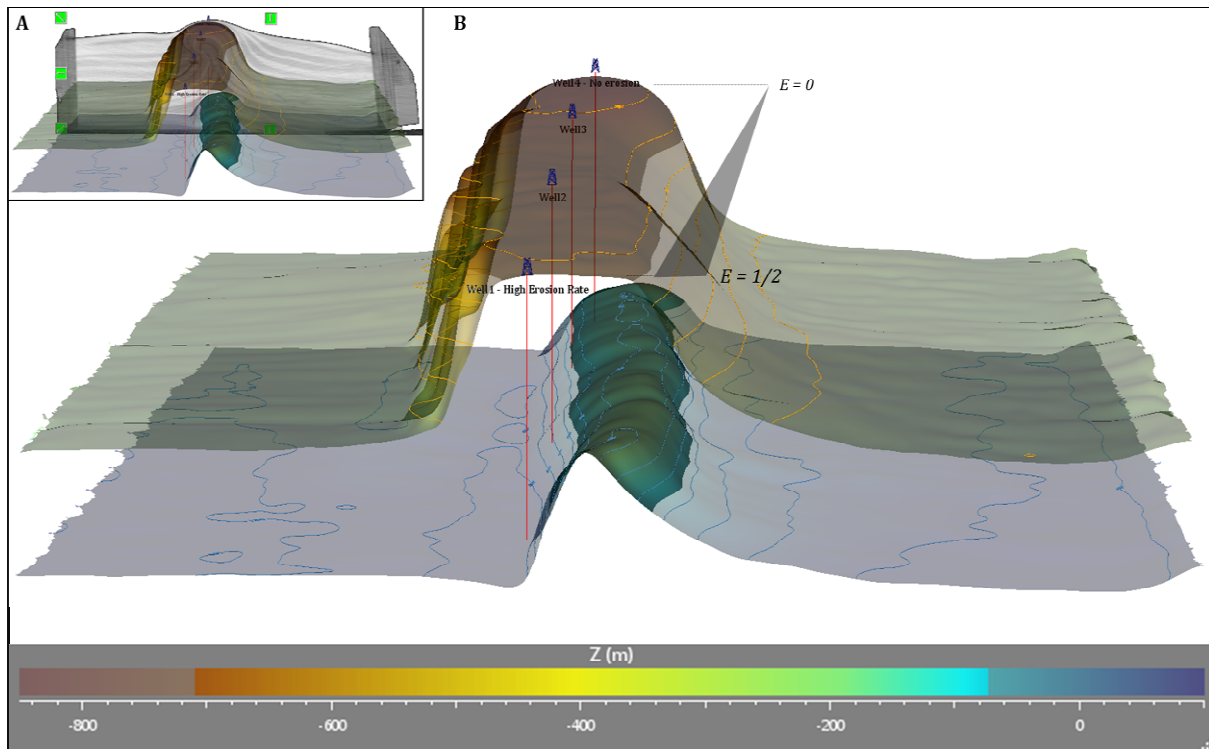

378

379 **Figure 13:** Maps of the two main superimposed folded structures in 3D. Erosion rate increases from background
 380 to foreground. Vertical lines (in red) represent virtual vertical well from the apex of topography to deep
 381 structures. High erosion rate leads to a lateral misfit between shallow and deep structures.
 382

383 4.4 Localized sedimentation

384 Two experiments with sedimentation localized either in the hinterland (figure 14A), or in the
 385 foreland (figure 14B) respectively, have been performed. The aim is to observe the evolution
 386 of two superimposed structures with an interbedded decollement layer separating two
 387 domains (hinterland and foreland) with different sedimentation rate for each one.
 388

388

389 4.4.1 Experimental setup

390 We used the rheology established previously (Figure 4) and the same deformation rate. In the
 391 first experiment, sedimentation ratio R was equal to $\frac{1}{2}$ in the hinterland and $\frac{1}{4}$ in the foreland,
 392 while R was equal to $\frac{1}{4}$ in the hinterland and $\frac{1}{2}$ in the foreland for the second experiment. For
 393 each experiment, erosion "E" varied from 0 to $\frac{1}{4}$ along the deformation box.

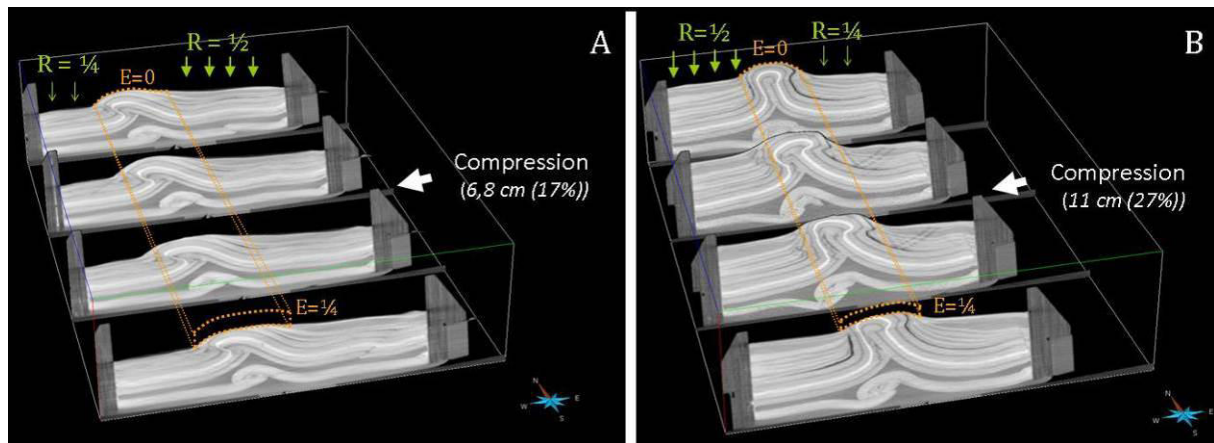

394

395 **Figure 14:** 3D views of two models with different sedimentation rate for hinterland and foreland domains. A.
 396 Sedimentation is more important in the hinterland ($R = \frac{1}{2}$ in hinterland vs $R = \frac{1}{4}$ in foreland). B. Sedimentation
 397 is more important in the foreland ($R = \frac{1}{4}$ in hinterland vs $R = \frac{1}{2}$ in foreland). For each experiment, erosion "E"
 398 varies linearly from 0 to $\frac{1}{4}$ along the deformation box.
 399

400 4.4.2 Results of localized sedimentation experiment

401 Figure 14 shows two models of two superimposed structures in a system subject to
 402 shortening. Some differences can be noticed in first order :

- 403 - The deep structures of the two models are quite similar. The thrust, verging toward the
 404 foreland is relatively flat in both models. A small uplift of the structure is observable
 405 when erosion E is equal to $\frac{1}{4}$. No significant differences can be attributed to
 406 sedimentation distribution for the deep structure evolution.
- 407 - The shallows structures of the two models are very different. Figure 14A shows a
 408 relatively flat folded structure developed on top of a thrust ramp breaching the early
 409 forelimb, and flattening while propagating upward, verging toward the foreland. On
 410 the contrary, Figure 14B displays a tight folded structure, similar to the previous
 411 experiments, verging toward the hinterland.

412 In both cases, there is no significant longitudinal variations along the box.

413 These observations are concordant with previous models: two superimposed structures in a
 414 compressional system with two decollement levels are strongly controlled by the external
 415 sedimentation and erosion factors. Depth structures are impacted by syn-kinematic erosion,

416 while shallow structures are strongly influenced by syn-kinematic sedimentation. The classic
417 foreland ward propagation of fold and thrust is as expected strongly modified when the
418 sedimentation along its front is consequent, whereas sedimentation at the rear only promotes a
419 long-lived activity of the thrust. The absence of foreland sedimentation is the key factor to
420 avoid the change of structure and tightening of the upper fold.

421

422

423 **5. Discussion**

424 New elements have been brought by the set of experiments performed for this study. We have
425 been able to (i) observe in 3D the impact of syn-kinematic erosion and sedimentation on a
426 decoupled sub Andean system analogue and, in particular, (ii) to identify which part of the
427 system is affected by sedimentation or erosion.

428

429 **5.1. Role of external syn-kinematic factors (erosion/sedimentation)**

430 We have seen that syn-kinematic sedimentation has a strong impact on the development of
431 shallow structures, which rise when sedimentation increases, but doesn't influence depth
432 structures significantly, especially the wavelength of deformation of deep systems are not
433 influenced by the sedimentation.

434 As previously stated (Driehaus et al., 2015) the initial mechanical stratigraphy is the
435 fundamental controlling factor. Fish tail like structures cannot develop without an interbedded
436 decollement level, within the pre-tectonic pile. This prerequisite is modulated first by the
437 sedimentation. In the absence of synkinematic sedimentary loading, the fish tail only develops
438 for small shortening rates, as it results in a decrease of the ductile layer viscous resistance and
439 thus in an increase of the decoupling efficiency (Couzens-Schultz et al., 2003). Intermediate
440 sedimentation rate (E roughly of the order of $\frac{1}{2}$ to 1) allows for the development of the
441 upright, tightened fold comparable to the Incahuasi target geometry. In such case, vergence

442 changes occur related to the fishtail propagation and related to asymmetric decoupling (figure
443 7). For high sedimentation rate, the influence of the deep decoupling levels is hidden, and a
444 more general symmetrical structure is developed, concealing the deep complexity.

445 Considering the impact of an uneven sedimentation, the models show that a contrast between
446 hinterland and foreland has strong consequences: the foreland sedimentation is necessary to
447 initiate the fold tightening, by preventing the classic foreland ward propagation of the frontal
448 ramp. On the contrary, the hinterland sedimentation simply helps to propagate the foreland
449 ward main thrust, by increasing the overall resistance of the moving sedimentary pile at the
450 rear.

451 However, these considerations are derived from 2D, cylindrical models. Here the experiments
452 were performed in 3D and point out to a potential modulation of these conclusions due to the
453 lateral, along strike modifications of the sedimentation and erosion rates. The figure 15
454 illustrates the link between the elevation of the main deep structure (figure 15B) and the basal
455 ductile layer thickness (figure 15C): the Northern side of the lower structure is more elevated
456 than its counterpart to the south of the model. The basal layer thickness is also more important
457 in the northern part of the model at the end of the shortening phase. This contrast between
458 northern and southern part increases with shortening and results from the sedimentation ratio
459 contrast, which vary from $R=1/2$ to $R=1$ (respectively from northern to southern part). The
460 difference in sediment's weight is responsible for a partial expulsion of the basal ductile
461 material from the southern domain (high sediment loading) to the northern domain (low
462 sediment loading). It thus helps amplifying the decoupling between the deep structure along
463 the decollement surface. However, although the depth structure wavelengths are not impacted
464 by this flowage of silicon due to variation of sedimentation rate, it appears that it helps
465 building more symmetrical box folds, as shown by the increase in both width of the folds, and
466 flow of silicon in the fold core.

467 As shown, the sedimentation (i) directly impacts shallow structures in the multi-decollement
468 configuration, involving a vergence variation and/or tightened structures, and (ii) indirectly
469 impacts depth structures if decollement levels are as ductile as salt or shale. But it seems that
470 the structural style at depth is not compacted by the sedimentation rate and distribution. In
471 contrast, we have shown that syn-kinematic erosion has a small impact on the upper
472 structures, apart from their disappearance, but largely modifies the deeper fishtail structures:
473 increased erosion favours an enlargement of the uppermost fold, with a progressive upward
474 migration of the kink fold limiting the anticline limbs at depth, and thus promoting the rise of
475 the deep fishtail. Contrarily to the case of simple sedimentation, when considering both
476 erosion of the upper structure and sedimentation on both sides, the higher is the
477 sedimentation, the less is developed the fishtail, as its development is precluded by its ascent
478 in the core of the fold.
479

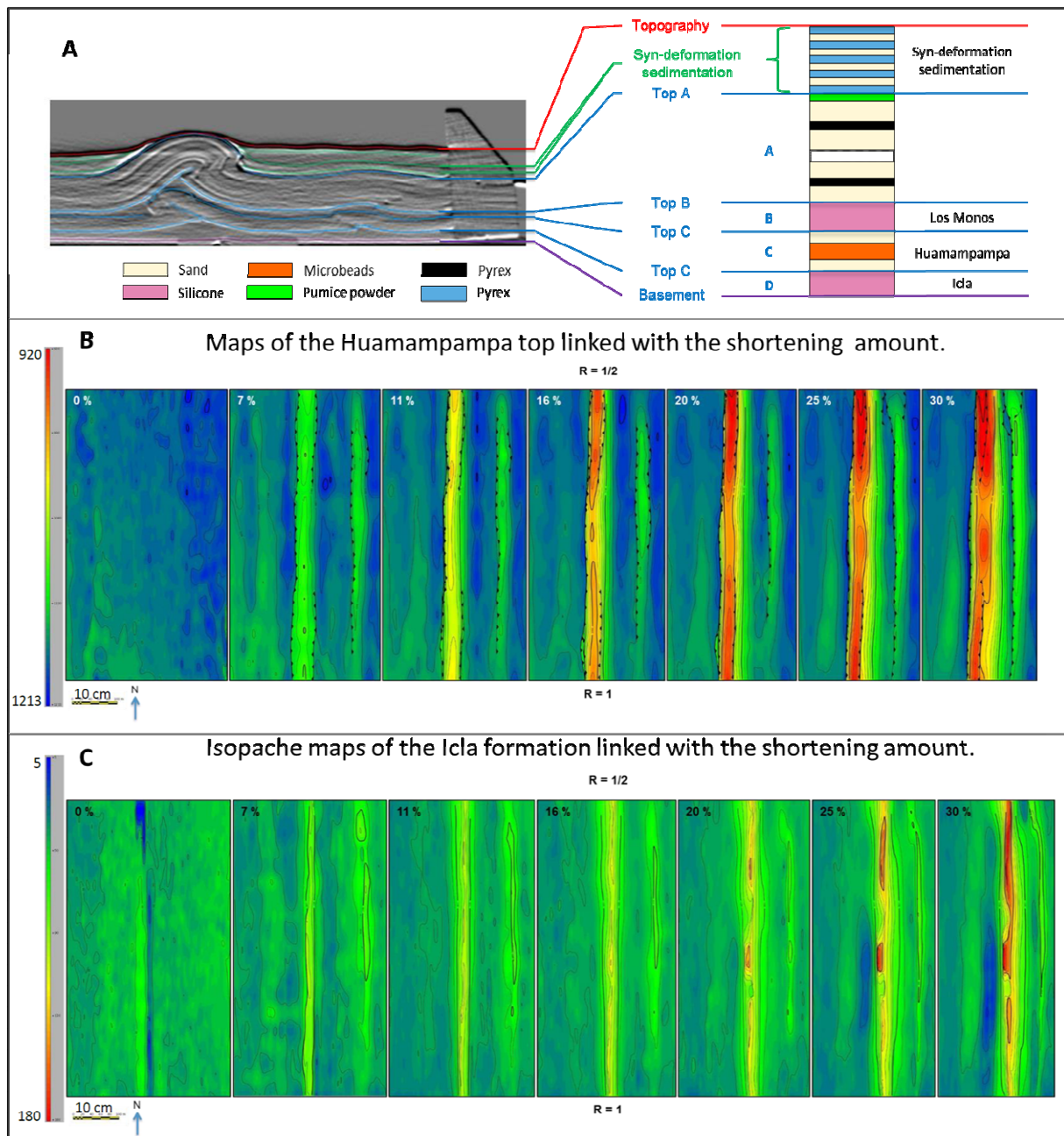

480

481 **Figure 15:** A. Result of the analogue model experiment testing the influence of the sedimentation. Main
 482 horizons are highlighted and correlated to the stratigraphy used. B. Maps of the “Huamampampa” equivalent top
 483 linked with the shortening rate. R ratio vary from 1 in the South side to $\frac{1}{2}$ in the North side. Hot colors show
 484 high elevations, while cold colors show low elevations. C. Isopach maps of the “Icla” equivalent linked with the
 485 shortening rate. R ratio vary from 1 in the South side to $\frac{1}{2}$ in the North side. Hot colors show thick thickness,
 486 while cold colors show thin thickness.

487

488

489 5.2. Implication for petroleum exploration

490 Seismic imaging in foreland fold and thrust belt remains nowadays a challenge, and often
 491 only the syncline geometry are properly characterized. But structural complexity in the fold

492 core is generally high, particularly if considering pre-tectonic sedimentary piles implying
493 successive decollement level such as in Bolivia. It is therefore crucial for petroleum
494 exploration to know and understand the mechanisms able to trigger the decoupling, and
495 particularly to better constrain the deeper part geometry and the associated kinematic. This
496 study highlights that external factors (sedimentation and erosion) have an important impact on
497 the decoupling of superimposed structures implying variable offset of the structural
498 culminations, both in cross section and along strike of the structure. The analogue models
499 offer therefore useful guides for structural interpretation but we have shown that it is crucial
500 to constrain the natural sediment/erosion rates variations in 3D Surface data of
501 erosion/sedimentation may then provide a qualitative guide for a better assessment of deep
502 seated structure. and through time.

503
504

505 **6. Conclusions**

506 A set of experiments have been performed to study, in 3D, the effects of external factors
507 (sedimentation and erosion) on a folded multi-decollement levels model, analogue to the fold
508 developed in the Subandean belt of Bolivia. For this case, two superimposed structures are
509 created by compression and separated by ductile decollement layers. Two structures partly
510 decoupled are formed: a deep fishtail like structures, situated below a more classic fold built
511 on a flat-ramp geometry. The role of the external forcing factors are the following:

- 512 (i) Sedimentation directly impacts the geometrical evolution of the shallow structures:
513 their elevation is increased and the vergences are modified when the sedimentation
514 rate is intermediate. Low sedimentation rates do not impact the foreland ward
515 propagation of the folded structure, and high sedimentation rates favour the
516 development of symmetrical pop-up.

517 (ii) Erosion directly impacts the evolution of deeper structures. High erosion rate, relative
518 to the rate of the tectonic relief creation, favors the rise of these objects in the core
519 of the upper folded structure..

520 The observation of these phenomenons in 3D brings new elements for the understanding of
521 rheologically layered folded sequence. We show that despite the rough cylindrical aspect of
522 the map view, external factors can generate misfits between the deep and shallow structural
523 culminations. In petroleum exploration of such areas (Bolivia, Zagros,...) it is thus crucial to
524 assess as precisely as possible syn-kinematic sedimentation and erosion rate to interpret
525 seismic profiles and/or to built geological section, that will integrate uncertainties on the
526 possible position of deep seated objectives. To do that, a multidisciplinary study involving (i)
527 classical structural and sedimentological studies to understand the geodynamic of the
528 considered system, and (ii) a dating campaign in the aim to know as much as possible the
529 timing of syn-kinematic sedimentation and erosion and the associated rates is mandatory.

530

531 5. Acknowledgements

532 Thanks to Elisabeth Rosenberg and Marie-Claude Lynch for their help in scanner analyze.
533 Thanks to Thierry Nalpas for his help and discussion about the modeling. Many thanks to
534 Jean Letouzey and Bernard Colletta for fruitfull discussions about worldwide examples of
535 fold and thrust belts.

536

537

538 6. References

539 Baby P., Guillier B., Oller J., Herail G., Montemurro G., Zubieta D., Specht M., 1993.
540 Structural synthesis of the Bolivian Sub-Andean zone. International Symposium on Andean
541 Geodynamics, ORSTOM, Série "Colloques et Séminaires", pp. 159-162.

542 Baby P., Colletta B., Zubieta D., 1995. Etude géométrique et expérimentale d'un bassin
543 transporté : exemple du synclinorium de l'Alto Beni (Andes centrales). *Bulletin de la Société*
544 *géologique de France* 166, 797-811.

545 Barrier L., Nalpas T., Gapais D., Proust J.N., Casas A., Bourquin s., 2002. Influence of
546 syntectonic sedimentation on thrust geometry. Field examples from the Iberian Chain (Spain)
547 and analogue modeling. *Sedimentary Geology* 146, 91-104.

548 Barrier L., Nalpas T., Gapais D., Proust J-N., 2013. Impact of synkinematic sedimentation on
549 the geometry and dynamics of compressive growth structures: Insights from analogue
550 modelling. *Tectonophysics*, 16p.

551 Bonini M., 2001. Passif roof thrusting and forelandward fold propagation in scaled brittle-
552 ductile physical models of thrust wedges. *Journal of Geophysical Research* 106, 2291-2311.

553 Buttler R., Richards D., Sempere T., Marshall L., 1995. Paleomagneti determinations of
554 vertical-axis rotations from Late Cretaceous and Paleocene strata of Bolivia. *Geology* 23, 799-
555 802.

556 Callot, J.P., J Letouzey, S. Jahani, S. Sherkati, 2012. Pre-existing salt structures and the
557 folding of the Zagros Mountain. From: Alsop, G. I., Archer, S. G., Hartley, A. J., Grant, N. T.
558 & Hodgkinson, R. (eds) 2012. Salt Tectonics, Sediments and Prospectivity, Geological
559 Society, London, Special Publications, 363, 545–561. <http://dx.doi.org/10.1144/SP363.27>

560 Casas A.M., Gapais D., Nalpas T., Besnard K., Roman Berdiel T., 2001. Analogue models of
561 transpressive systems. *Journal of Structural Geology* 23, 733-743.

562 Chemenda AI, Burg JP, Mattauer M. 2000. Evolutionary model of the Himalaya-Tibet
563 system: geopoembased on new modelling, geological and geophysical data. Earth and
564 Planetary Science Letters 174:397-409

565 Cobbold P.R., Davy P., Gapais D., Rossello E.A., Sadybakasov E., Thomas J.C., Tondji Biyo
566 J.J., de Urreiztieta M., 1993. Sedimentary basins and crustal thickening. *Sedimentary Geology*
567 86, 77-89.

568 Cobbold, P.R., Clarke, B.J., Løseth, H., 2009. Structural consequences of fluid overpressure
569 and seepage forces in the outer thrust belt of the Niger Delta. *Petroleum Geoscience* 15, 3-15.

570 Colletta B., Letouzey J., Pinedo R., Ballard J. F., Bale P., 1991. Computerized X-ray
571 tomography analysis of sand box models: examples of thin-skinned thrust system: *Geology*
572 19, 1063-1067.

573 Colletta B., Letouzey J., Soares J., Specht M., 1999. Detachment versus fault-propagation
574 folding: Insights from the Sub-Andean Ranges of southern Bolivia. *Thrust Tectonics*
575 *Conference, Royal Holloway, University of London, Abstracts*, 106-109.

576 Diraison M., Cobbold P. R., Gapais D., Rossello E.A., Le Corre C., 2000. Cenozoic crustal
577 thickening, wrenching and rifting in the foothills of the southernmost Andes. *Tectonophysics*
578 316, 91-119.

579 Driehaus L., Nalpas T., Ballard J. F., 2014. Interaction between deformation and
580 sedimentation in a multidecollement thrust zone: Analogue modelling and application to the
581 Sub-Andean thrust belt of Bolivia. *Journal of Structural Geology* 65, 59-68.

582 Gestain V., Nalpas T., Rouby D., Barrier L., 2004. Rôle des niveaux incompétents
583 synclinématiques sur l'évolution des structures chevauchantes. *Bulletin de la Société*
584 *Géologique de France* 175, 351-359.

585 Gubbels T.L., Isacks B.L., Farrar E., 1993. High-level surfaces, plateau uplift, and foreland
586 development, Bolivian central Andes. *Geology* 21, 695-698.

587 Hardy S., Duncan C., Masek J., Brown D., 1998. Minimum work, fault activity and the
588 growth of critical wedges in fold and thrust belts. *Basin Research* 10, 365-373.

589 Hounsfield G. N., 1973. Computerized transverse axial scanning (tomography). *British J.*
590 *Rad.* 46, 1016-1022.

591 Hubbert M. K., 1937. Theory of scale models as applied to the study of geologic structures.
592 *Geological Society of America* 48, 1459-1520.

593 Johnson M.R.W., 1981. The erosion factor in the emplacement of the keystone thrust sheet
594 (South East Nevada) across a land surface. *Geological Magazine* 118, 501-507.

595 Koyi H.A., Hessami K., Teixell A., 2000. Epicenter distribution and magnitude of
596 earthquakes in fold-thrust belts: Insights from sandbox models. *Geophysical Research Letters*
597 27, 237-276.

598 Labaume P., Simon M. F. Sheppard, Moretti, I., 2001. Fluid flow in cataclastic thrust fault
599 zones in sandstones, Sub-Andean Zone, Southern Bolivia. *Tectonophysics* 340, 141-172.

600 Lebel D., Langenberg W., Mountjoy E. W., 1996. Structure of the Central Canadian
601 Cordilleran Thrust-and-Fold Belt, Athabasca-Brazeau Area, Alberta: A Large, Complex
602 Intercutaneous Wedge. *Bulletin of Canadian Petroleum Geology*, Vol 44, N°2, p. 282-298.

603 Letouzey J., Colletta B., Vially R., Chermette J. C., 1995. Evolution of salt-related structures
604 in compressional settings. Salt tectonics: a global perspective. *American Association of*
605 *Petroleum Geologists Memoir*, 65, 41-60.

606 Leturmy P., Mugnier J.L., Vinour P., Baby P., Coletta B., Chabron E., 2000. Piggyback basin
607 development above a thin-skinned thrust belt with two detachments levels as a fonction of
608 interactions between tectonic and superficial mass transfer: the case of the Subandean Zone
609 (Bolivia). *Tectonophysics* 320, 45-67.

610 Liu H., McClay K.R., Powell D., 1992. Physical models of thrust wedges. *Thrust tectonics*.
611 McClay K. R. (ed), Chapman & Hall, London, 71-81

612 Malavieille J., Larroque C., Calassou S., 1993. Experimental modelling of
613 tectonic/sedimentation relationships between forearc basin and accretionary wedge. *Comptes*
614 *Rendus de l'Académie des Sciences de Paris, Série IIa*, 316, 1131-1137.

615 Mandl G., 1988. Mechanisms of Tectonic Faulting. *Elsevier, Amsterdam*.

616 Marshall L., Sempere T., Gayet M., 1993. The Petaca (Late Oligocene – Middle Miocene)
617 and Yecua (Late Miocene) formations of the Sub-Andean Chaco Basin, Bolivia, and their
618 tectonic significance. *Documents des Laboratoires de Geologie de la Faculté des Sciences de*
619 *Lyon* 125, 291-301.

620 Merle O., Abidi N., 1995. Approche expérimentale du fonctionnement des rampes
621 émergentes. *Bulletin de la Société Géologique de France* 166, 439-450.

622 Moretti I., Baby P., Mendez E., Zubieta D., 1996. Hydrocarbon generation in relation to
623 thrusting in the Sub Andean Zone from 18 to 22°S, Bolivia. *Petroleum Geosciences* 2, 17-28.

624 Moretti I., Labaume P., Sheppard S. M.F., Boulègue J., 2002. Compartmentalisation of fluid
625 migration pathways in the sub-Andean Zone, Bolivia. *Tectonophysics* 348, 5-24.

626 Mugnier J.L., Baby P., Coletta B., Vinour P., Balé P., Leturmy P., 1997. Thrust geometry
627 controlled by erosion and sedimentation: a view from analogue models. *Geology* 25: 427-430.

628 Nalpas T., Györfi I., Guillocheau F., Lafont F., Homewood P., 1999. Influence de la charge
629 sédimentaire sur le développement d'anticlinaux synsédimentaires. Modélisation analogique
630 et exemples de terrain (Bordure sud du bassin de Jaca). *Bulletin de la Société Géologique de*
631 *France* 170, 733-740.

632 Nalpas T., Gapais D., Verges J., Barrier L., Gestain G., Leroux G., Rouby D., Kermarrec J.J.,
633 2003. Effects of rate and nature of synkinematic sedimentation on the growth of compressive
634 structures constrained by analogue models and field examples. *Geological Society of London*
635 *Special Publication* 208, 307-319.

636 Nieuwland D.A., Leutscher J.H., Gast J., 2000. Wedge equilibrium in fold-and-thrust belts:
637 prediction of out-of-sequence thrusting based on sandbox experiments and natural examples.
638 *Geologie en Mijnbouw* 79, 81-91.

639 Pichot T., Nalpas T., 2009. Influence of synkinematic sedimentation in a thrust system with
640 two decollement levels; analogue modelling. *Tectonophysics* 473, 466-475.

641 Price N.J., Johnson M.R.W., 1982. A mechanical analysis of the Keystone-Muddy mountain
642 thrust sheet in the southeast Nevada. *Tectonophysics* 84, 131-150

643 Raleigh C.B., Griggs D.T., 1963. Effect of the toe in the mechanics of overthrust faulting.
644 *Geological Society of America Bulletin*, 74: 819-830

645 Ramberg H., 1981. Gravity, deformation and the Earth's crust. *Academic Press, New York.*

646 Richard P., Cobbold P. R., 1989. Structures en fleur positives et décrochements crustaux:
647 modélisation analogique et interprétation mécanique. *Compte rendu de l'Académie des*
648 *Sciences de Paris* 308, 553-560.

649 Schreurs G., Buitter S. J. H., Boutelier D., Corti G., Costa E., Cruden A. R., Daniel J. M., Hoth
650 S., Koyi H. A., Kukowski N., Lohrmann J., Ravaglia A., Schlische R. W., Withjack M. O.,
651 Yamada Y., CavoZZi C., Delventisette C., Elder Brady J. A., Hoffmann-Rothe A., Mengus J.-
652 M., Montanari D., Nilforoushan F., 2006. Analogue benchmarks of shortening and
653 extension experiments. *Geological Society, London, Special Publications* 253, 1-27.

654 Sempere T., Carlier G., Carlotto V., Jacay J., Jimenez N., Rosana S., Soler P., Cardenas J.,
655 Boudesseul N., 1999. Late Permian-Early Mesozoic rifts in Peru and Bolivia, and their
656 bearing on Andean-age tectonics. Fourth ISAG, Goettingen (Germany), Abstracts Volume,
657 pp. 680-685.

658 Couzens-Schultz B., Vendeville B., Wiltschko D., 2003. Duplex style and triangle zone
659 formation: insights from physical modeling. *Journal of Structural Geology* 25, 1623-1644.

660 Soler P., Sempere T., 1993. Stratigraphie, géochimie et signification paléotectonique des
661 roches volcaniques basiques mésozoïques des Andes Boliviennes. *Comptes Rendus de*
662 *l'Académie des Sciences, Paris, Série II* 316, 777-784.

663 Storti F. et McClay K., 1995. Influence of syntectonic sedimentation on thrust wedges in
664 analogue models. *Geology* 23, 999-1002.

665 Storti F., Salvini F., McClay K., 2000. Synchronous and velocity-partitioned thrusting and
666 thrust polarity reversal in experimentally produced, doubly-vergent thrust wedges: implication
667 for natural orogend. *Tectonics* 19, 378-396.

668 Tondji Biyo J.J., 1995. Chevauchements et bassins compressifs: influence de l'érosion et de la
669 sédimentation. *Thèse de doctorat de l'Université de Rennes I*, 406pp.

670 Twiss R.J., Moores E. M., 1992. Structural Geology. *Freeman, New-York*, 532p.

671 Uba, C.E., Heubeck, C., Hulka, C., 2005. Facies analysis and basin architecture of the
672 Neogene Subandean synorogenic wedge, southern Bolivia. *Sedimentary Geology* 180, 91-
673 123. doi: 10.1016/j.sedgeo.2005.06.013.

674 Uba, C.E., Heubeck, C., Hulka, C., 2006., Evolution of the late Cenozoic Chaco foreland 516
675 basin, southern Bolivia. *Basin Research* 18, 145-170, doi: 10.1111/j.1365-2117.2006.00291.x.

676 Verges, J., Goodarzi, M. G. H., Emami, H., Karpuz, R., Efstathiou, J., Gillespie, P., 2011.
677 Multiple detachment folding in Pusht-e Kuh arc, Zagros: Role of mechanical stratigraphy. In:
678 McClay, K., Shaw, J., Suppe, J. (Eds.), Thrust fault-related folding: AAPG Memoir 94, 69-
679 94.

680 Vidal-Royo O., Hardy S., Munoz J. A., 2011. The roles of complex mechanical stratigraphy
681 and syn-kinematic sedimentation in fold development: insights from discrete-element
682 modelling and application to the Pico del Aguila anticline (External Sierras, Southern
683 Pyrenees). *Geological Society of London, Special Publication* 349, 45-60.