



HAL
open science

Hellenism as an Analytical tool for Occidentrism (in Musicology) V2 (February 2017)

Amine Beyhom

► **To cite this version:**

Amine Beyhom. Hellenism as an Analytical tool for Occidentrism (in Musicology) V2 (February 2017). NEMO-Online, 2017, 3 (5), pp.53-275. hal-01447512v2

HAL Id: hal-01447512

<https://hal.science/hal-01447512v2>

Submitted on 21 Feb 2017

HAL is a multi-disciplinary open access archive for the deposit and dissemination of scientific research documents, whether they are published or not. The documents may come from teaching and research institutions in France or abroad, or from public or private research centers.

L'archive ouverte pluridisciplinaire **HAL**, est destinée au dépôt et à la diffusion de documents scientifiques de niveau recherche, publiés ou non, émanant des établissements d'enseignement et de recherche français ou étrangers, des laboratoires publics ou privés.



Distributed under a Creative Commons Attribution - NonCommercial - NoDerivatives 4.0 International License

Dossier: *Hellenism as an Analytical tool for Occidentism (in musicology)*

Amine Beyhom*

FOREWORD¹

It has been over twenty-five years since I have researched *maqām*² music³, notwithstanding research

* Amine Beyhom is redactor in chief of NEMO-Online and director of the CERMAA (Centre de Recherches sur les Musiques Arabes et Apparentées), a research center affiliated to the FOREDOFICO foundation in Lebanon.

¹ This is an emendated and slightly augmented version (V2) of the dossier published in November 2016. My heartfelt thanks go to Rosy Azar Beyhom and to Richard Dumbrell, the first and the last having emendated the original text and helped improving it. My thanks also to Jean During and fr. Romanos Joubran who gradually reviewed the chapters and appendices of the initial version, as well as to Martin Ralph Jaeger who got the first draft in the summer of 2016.

² I use the term *maqām* in this dossier in its wider, multifarious acceptance as defined for instance in [Bohlman, 2001, §IV]: “The modern term *maqām* refers to both the larger system of melodic practices in Arabic-, Persian- and Turkish-speaking cultures, and to the entity of a single mode itself. Despite its centrality in Middle Eastern music theories and its extensive history, *maqām* exhibits more conceptual flexibility and exists in more different forms than the other major modal systems. Interpretations of *maqām* differ from region to region in the Arab world and among individual performers. There is considerable flexibility and diversity in the identification of a single *maqām* – a scale with a full complement of notes within the span of an octave or more or a smaller unit, such as a tetrachord, or a melodic motif or a repertory-specific formal procedure – marks performing practice”. Moreover, the term *maqām* relates in this dossier, unless differently stated, with traditional *maqām* music, be it Popular or Artistic, *i.e.* (and roughly) before post-conference of Cairo (1932 “Congrès du Caire”) changes (Occidentalization) interfered massively with this music.

³ These include my pre-Academic research on (what I called then) “Arabian music”, noticeably with mentors like the late Bernard Moussalli who taught me to question musicological writings (and their authors), and whom I would like to thank posthumously here.

in other fields such as European traditional, particularly Breton music⁴. However, it is not until I probed deeply into Byzantine chant and its theories of the 19th century⁵ that I finally reached the conclusions put forward in this dossier.

Working on Byzantine chant was an eye-opener⁶ which explained the litany of misunderstandings, contradictions, obvious errors and allegations made in bad faith in *maqām* literature, some of which I have already mentioned in previous publications and papers⁷.

What remained inexplicable for me, for over two decades, was the *reason*⁸ why (and how) all of these errors could be made in the first place, in such a domain that is still⁹ today considered as the “science” of music¹⁰: the answer to this question is the main object of this dossier¹¹.

⁴ Although I have been interviewing, for more than two decades, prominent actors (musicians, singers, cultural “activists”) and attending many concerts and musical events, I never published extensively in this field of research; my contribution can be found in [Beyhom, 2008a] and, as an example of statistical processing of tonometric measures (pitch measurements), in [Beyhom, 2015b, p. 258–263].

⁵ See [Beyhom, 2015b].

⁶ And is intended as such in this dossier, which explains the extended length of the fourth chapter dedicated to Byzantinism.

⁷ See for instance [Beyhom, 2006a; 2007a; 2007b; 2007c; 2007e; 2009; 2010c; 2011; 2012; 2013; 2014b]: all the articles of the author and an emendated version of the book [Beyhom, 2010c] are available for free download at <http://foredofico.org/CERMAA/publications/publications-on-the-site/publications-amine-beyhom> and http://foredofico.org/CERMAA/?attachment_id=482.

⁸ “The reasons” would have been perhaps more relevant, here and in a general fashion, as different musicologists, musicians or music theoreticians may have different reasons for different opinions or beliefs, but the errors I pinpoint in this dossier have one single, general cause as explained below in the text.

⁹ And even more.

¹⁰ Although I felt, having read Edward Said’s *Orientalism* in my early twenties (in the French translated version [Said, 1980] that I still have in my personal library), that Orientalism could have played a role in this process, without knowing however how, exactly.

¹¹ Which is an extension of my preliminary exploration of the consequences of Romantic Hellenism and Musicological Orientalism on Byzantine chant and *maqām* music undertaken in [Beyhom, 2015b, p. 479–517] as well as, indirectly, in other publications or papers – cited in footnote 7 – dealing with such “errors”.

Prefatory remarks

This dossier is illustrated with Power Point slides¹² as audio examples and analyses. It is intended as a logical demonstration, the general scheme of which¹³:

1. A reminder on Ancient Greek music theories¹⁴ and their implementation in Occidental and Arabian musicological literature.
2. Music history (or “The History of Music[s]”) in the 19th-20th centuries.
3. “Musicological” theories on the formation of the scale. (Followed by a “Foreword on musicological Orientalism / Byzantinism – and transition”)
4. Musicological Byzantinism and its consequences. (Followed by an “Interlude”)
5. Orientalism in Music and Musicology and consequences.
6. Conclusions (with a General Scheme of the Hellenism / Orientalism process).

In addition to this main corpus¹⁵, for which limited knowledge of music theory and elemental musicology is needed, specialized appendices¹⁶ are provided at the end of the dossier:

1. How to produce Aristoxenos’ half-tone¹⁷.
2. The “28 quarter-tones (in the octave)” of the Harmonicists¹⁸.
3. The *genera* of Aristoxenos and developments by (al-) Fārābī¹⁹.

¹² Available for download at <http://nemo-online.org/?p=1460>.

¹³ This is (roughly) the scheme followed in previous public presentations of this paper, noticeably at the CREM (Centre de Recherche en Ethnomusicologie – under the French CNRS – referenced under [Beyhom, 2016b]) on March 7 2016, and partly at the Orient Institut Beirut (referenced as [Beyhom, 2016a]) on February 16 2016.

¹⁴ To be understood as “Ancient Greek theories and later Greco-Roman developments”.

¹⁵ (Note from the editors): due to the unusual length of this dossier, the redaction of NEMO-Online has added a table of contents at the end.

¹⁶ These are translations (from the French) of previously published or original materials, detailed explanations of particular points explored in the main text (some of which require a more extended musicological and/or mathematical background), whenever the last appendix (Orientalism) is meant for a better understanding of the issues at stake in the polemic between pro- and anti-Orientalists.

¹⁷ Ancient Greek music theory; translated and augmented from [Beyhom, 2010c].

¹⁸ Ancient Greek music theory; previously unpublished material.

¹⁹ Ancient Greek and Early Arabian music theory; translated from [Beyhom, 2010c] and [Beyhom, 2015c].

4. About the “Resonance” theory²⁰.
5. The myth of the organ(s) in Byzantine churches (before “The Fall”)²¹.
6. On the “Diatonic [ditonic] tonal system” as the prototype system for “Medieval” Byzantine chant²².
7. Basic understanding of Orientalism – and a little more²³.

Moreover, (at least) two terms used in the following pages may be new to some readers, these are “ditonism” and “Zalzalism”; “ditonism” (for “two – disjunctive²⁴ – tones in the fourth”) is used to differentiate “Occidental” *diatonism* (*i.e.* based on a semi-tonal division of the octave) from the variety of “other” *diatonism*(s) proposed by various Greek authors²⁵ through the many centuries long history of Ancient Greek music theory; these are frequently assimilated to *Zalzalian* divisions of the scale generally deduced from the existence, in a containing (or delineating²⁶) interval (*i.e.* a fourth, a fifth, an octave), of small(er) structuring intervals the values of which are frequently expressed as odd multiples of the (approximate) quarter-tone²⁷.

²⁰ Theories of the scale; translated and developed from (published) [Beyhom, 2010c] and (previously unpublished) [Beyhom, 2010b].

²¹ Byzantine chant history; translated and adapted from [Beyhom, 2015c].

²² Byzantine chant theory; translated and adapted from [Beyhom, 2015c].

²³ Definitions of Orientalism and re-Orientalism and clues, facts and opinions about Edward Said’s work(s) etc.

²⁴ Or “whole” tones, with frequencies ratio 9/8 in Pythagorean and neo-Pythagorean theories.

²⁵ To which we can add later “diatonism” as used in Byzantine chant theory.

²⁶ I explain the concept of “Container (but also ‘measuring’ and ‘quantifying’) intervals” in [Beyhom, 2010a, p.152–155] and [Beyhom, 2013]: for melodic music, Container interval are the larger intervals that delimitate a series of conjunct intervals characterizing parts of the melody; in other words, their (main) function is not melodic, but delimitative.

²⁷ “Zalzalian” {from Maṣūūr Zalzal a-ḍ-Ḍarīb, an 8th-9th-centuries *ūd*ist who was – supposedly – the first to introduce the fingerings of the *mujannab*(s) – *i.e.* the so-called “neutral” seconds and thirds – on the neck of the *ūd*} refers more generally to intervals (or musical systems which use them) using other subdivisions as the semi-(or “half-”)tone, noticeably all the varieties of *mujannab* seconds spreading from the exact half-tone to the disjunctive (Pythagorean) tone; the same applies to intermediate intervals between the (exact or Pythagorean) tone and the one-tone-and-half-tone interval (either equal-tempered or Pythagorean “augmented” second) etc. – see also, as an example of the

→

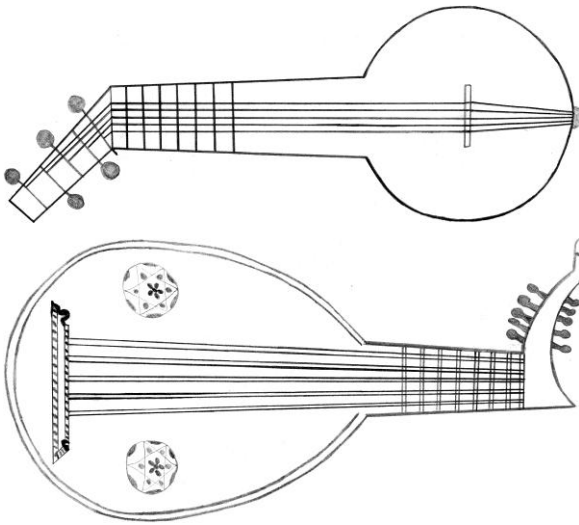

Fig. 1 Two sketches (duplicates from the originals) of so-called “fretted” *ūd(s)*, allegedly with gut (or silk) strings tied around the neck²⁸.

→ (mis)-use of the terms “fret” and “neutral” in musicological literature concerning *maqām* music, [Farmer, 2001] {for instance: “his name [Zalzal the *ūd* player] is associated with the neutral 3rd fret (*wustā Zalzal*) placed midway between the major and minor 3rd frets, which recognizes for the first time the existence of the neutral intervals still characteristic of Arab and Persian music today”} and [Farmer and Neubauer, 2002] {“His [Zalzal’s] name is also connected with the introduction of the middle, or neutral, third among the frets (*dasātūn*) of the lute”}, the second being more adequate for it uses the original term (*dastān-dasātūn*) and gives the “middle” alternative for the “neutral” third. I explain why, in [Beyhom, 2008b] and the appendix on the *ūd* and the *tunbūr* of [Beyhom, 2010c] (with a few additions in the chapter dedicated to Musicological Orientalism), the Early Arabian lute has most probably never been fretted, at least for performance needs. As for “neutral”, “middle” (and even “minor” and “major”) intervals, the terms are not adequate for describing the intervals of the Arabian, Persian etc. scales, as the main scale in those musics is not (and has most probably never been) “ditonic”.

²⁸ (These sketches have been drawn by Rosy Azar Beyhom, and were previously published in [Beyhom, 2010c]). Such sketches (above Fig. 84 in [Farmer et al., 1966] – taken from *Kanz a-t-Tuhaf*, unknown author, Iran, mid-14th-century, British Museum MS. Or. 2361, f^o 260v^o; below Fig. 81 in [Farmer et al., 1966] – taken from the *Kitāb al-Adwār* by Ṣafīyy-a-d-Dīn al-Urmawī, Bodleian Library Oxford, MS. Marsh 521, f^o 157v^o, 1333-1334) served as “proof” that *ūd(s)* from the Early Islamic Era were, like Occidental lutes in the Baroque and Renaissance periods, “fretted” – more on lutes, their history and their fabrication (but not including considerations about the Occidental lute’s ancestor, the *ūd*) in [van Edwards; Hellwig, 1970; Hellwig, 1974; Richmond et al., 1975; Huseby, Reidemeister, and Caffagni, 1975; Perret, 1976; Kottick, 1973; Anon. “Building a medieval lute, building early instruments”; Anon. “Building a Renaissance lute, building early instruments”; Anon. “The Lute | Thematic Essay | Heilbrunn Timeline of Art History | The Metropolitan Museum of Art”;

1. A REMINDER ON ANCIENT GREEK MUSIC THEORIES AND THEIR IMPLEMENTATION IN OCCIDENTAL AND ARABIAN MUSICOLOGICAL LITERATURE²⁹

“We could say that Greece has left us a
Global music”
[Maurice Emmanuel, “Grèce”]³⁰

It is generally well known³¹ that the existence of Pythagoras is probably mythical³², and that the Pythagorean “doctrine” is a later adjunction by many different authors³³ whose writings exist barely as

→ Anon. “The Lute Society: Building Lute Original Methods”; Wachsmann et al., 2007; Williams and Harwood, 1975].

²⁹ The following appendices relate to this first chapter: 1. How to produce Aristoxenos’ half-tone, 2. The “28 quarter-tones (in the octave)” of the Harmonicists, 3. The *genera* of Aristoxenos and developments by (al-) Fārābī, 6. On the “diatonic [ditonic] tonal system” as the prototype system for “Medieval” Byzantine chant. Most 19th to 21st centuries literature, for the parts of this dossier concerning Ancient Greek theories and Praxis, is referenced mainly in [Beyhom, 2010c] and [Beyhom, 2015b]. For a comprehensive bibliography on Ancient Greece see <http://nemo-online.org/bibliography/modality-bibliography/antiquity>.

³⁰ [Emmanuel, 1921, p. 378]: “La Grèce n’a légué à la postérité qu’une musique mondiale, pourrait-on dire”; by “Global” music Emmanuel means “Pythagorean ditonic” music.

³¹ In specialized musicological circles, although I have often had discussions with musicologists who believed in Pythagoreanism without real knowledge about Pythagoras and the Pythagorean myth; these musicologists follow as a rule the restricted semi-tonal approach of Greek Music theories.

³² More on Pythagoras and Pythagoreanism in [Huffman, 2006a; 2006b; 2008; 2011a; 2011b], and in the following footnote.

³³ “The familiar figure of Pythagoras, mystic, mathematician, philosopher and scientist, is almost entirely a construct of the Pythagorean revival of Roman times, though its creators found some of the material from which it was built in writings of the fourth century. Very little of the colourful information retailed by Nicomachus, Porphyry, Iamblichus and others can be taken at face value, and the amount of reliable evidence they offer to link Pythagoras with harmonic science is vanishingly small. Much the same is true of the accounts we possess of the work of Pythagoras’ followers down to the late fifth century, at least in point of detail. What we know, reasonably securely, about Pythagorean harmonics around 400 B.C. certainly presupposes an earlier tradition, which may go back to Pythagoras himself. But we are deceiving ourselves if we think that we can pin down its contents with any precision, let alone attribute specific ideas with justifiable confidence to particular individuals and dates” – in [Barker, 2007, p. 20].

copies dating, for the earliest, from the 11th century A.D.³⁴

Moreover, Modern Music theories and musicology use a terminology which is different from the terminology of their Ancient Greek counterparts³⁵, with Ancient Greek praxis and theories being as far apart as most theories of the *maqām*³⁶ from effective praxis³⁷. Nevertheless, interpretations of Ancient Greek

³⁴ Apart from the lately discovered Oxyrhynchus fragments (see for example [Hunt, 1922; Turner, 1952; Holleman, 1972; Barker, 1994]), which give no clue whatsoever about Ancient Greek intervals, there are no autographic texts of music theory. According to [Mathiesen, 1992, p. 9–10] “The earliest codex preserving ancient Greek music theory is Heidelbergensis Palatinus gr. 281. It was probably written in Seleucia on the west bank of the Tigris River, Mesopotamia (present day Iraq) by the scribe Nikolaos Kalligraphos, and completed on January 14, 1040. The manuscript is preserved at Heidelberg University Library. The scribe’s colophon states that ‘this book was assembled from many works among the private papers of Romanus, judge at Seleucia and my master. All you who read it, pray for him.’ The codex was conceived as a complete book; there are no blank leaves or sides. It preserves [Michael] Psellus’ complete *Syntagma* together with the preliminary *Logices*, and this is followed by his *Opiniones de anima*, a short excerpt from Leontinius on the hypostases, chapter 38 from Photius *Quaestiones ad Amphilocheum*, and ten short theological treatises by Theodore Abucara, an author represented in Arethas’ collection of books. It is surely no coincidence that this codex preserves these particular works, which point back to libraries of the ninth century, as well as the work of Psellus. After Theodore Abucara, the codex includes the *koine hormasia* and an accompanying canon; three sections from Theon of Smyrna’s treatise, here titled Μουσικὸν κανονοῦ κατὰ τὴν, or ‘Division of the Musical Canon’; a short explanation of the musical ratios and genera, part of which corresponds to section 103 of the so-called Bellermann’s Anonymous, and a series of excerpts from Bacchius’ treatise [...]”.

³⁵ For example for the terms “harmony” or “harmonia” (defined by Chailley and Viret for Ancient Greek music as “a coherent structuration of the intervals composing the scale” – in [Chailley and Viret, 1988, p. 75]); also from [Barker, 2007, p. 21]: “Just occasionally, a Greek writer speaks of notes as ‘above’ and ‘below’, *anō* and *katō*; but the usage is very rare. Where we would call a note ‘high’, a Greek would most commonly describe it as *oxys*; where we would call it ‘low’ it is *barys*. But *oxys* and *barys* do not mean ‘high’ and ‘low’; they mean ‘sharp’ and ‘heavy’. [...] The standard Greek word for ‘pitch’ is *tasis*, which literally means ‘tension’; and another, rather more erudite way of calling a note ‘high’ or ‘low’ was to describe it as *syntonos*, ‘tense’, or *aneimenos* (sometimes *chalaros*), ‘relaxed’ or ‘slack’”.

³⁶ “Oriental” in the restricted sense, *i.e.* which concerns modal music as practiced mainly by the people of Arabian countries, Iran, Turkey and Central Asia, but also Eastern Byzantine chant, all belonging to the same common core, and all based on modality and heptatonism.

³⁷ Or the difference between a tetrachord and a *genus*, or between the scale of a mode and the mode itself (a *maqām* for example).

music theories flourished in the 19th-20th centuries, with their somewhat eccentric understanding by Western “musicologists”³⁸.

I am far from being able to explain all the characteristics of Ancient Greek theories in this dossier³⁹; the following sections are merely a reminder of some of the main features of these theories, noticeably in what concerns the *genera*, or (restrictively)⁴⁰ the tetrachords and tetrachordal construction of the scale/octave, and how they were used in Occidental mainstream musicology (music theories and teaching).

In order to explain the importance of these theories and their impact on Modern musicology, the following remarks seem indispensable: the three main theoretical developments in Ancient Greek music, the Pythagorean mathematical approach, the Aristoxenian pragmatic argumentation and, to the extent of what we know about them, the Harmonicists and their close-packed diagrams and equal-divisions of the interval space(s), all three trends are surviving in music theory today, notably in theories of *maqām* music⁴¹.

Container intervals and means: the original tetrad and the tetraktys

Pythagorean mathematics and philosophy are based on the original *tetrad*⁴², a suite of four first

→

For differences between theoretical tetrachords and *genera* in Arabian music, please refer to Slide No. 17.

³⁸ All interpretations were not made by what we could call today “musicologists”, but philologists or Music theoreticians; whenever the first were needed for translations from Greek (or Latin) – but lacked presumably musicological knowledge, the latter (and some of the former) projected their preconceptions on the music (and theories) they interpreted. We shall see in this dossier that even “Music scientists” (or “musicologists”) could not avoid the bias of Occidental readings of Ancient Greek theories in the 19th century.

³⁹ Specialists in the domain have already detailed those, while I give in [Beyhom, 2010c] (and below in the text) a different insight on Arabian thought as expressed through Greek inspired theories.

⁴⁰ See footnote 37.

⁴¹ The Pythagorean and Harmonicists’ theories being prominently in use, in a very particular synthesis, in Turkish theories of the 20th and 21st centuries.

⁴² [Barbera, 1977, p. 294–295]: “Modern investigations into ancient Greek conceptions of numbers have often confused the meanings of *tetrad* and *tetraktys* [...]. The following distinction provided by Delatte will be of functional importance here. ‘Tetrad’ signifies the number 4 as well as the first four positive integers,

→

integers 1 2 3 4. Ancient Greeks somehow discovered that the relations between these four numbers corresponded to the acoustic main Container intervals in music (see Fig. 2), i.e. the octave (1/2 or 2/4), the fifth (2/3) and the fourth (3/4), but also the octave and the fifth (1/3) and the double octave (1/4).

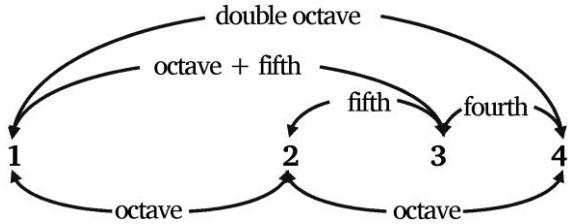

Fig. 2 The original *tetrad* and the resulting container intervals⁴³.

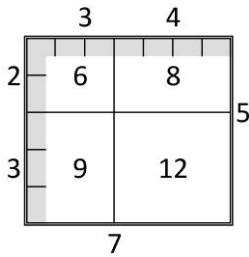

Fig. 3 Obtaining the *tetraktys* 6 8 9 12 on the basis of the *tetrad*⁴⁴.

whereas ‘tetraktys’ is defined as an ensemble of four things, a quaternary. Three well-known examples of the *tetraktys* are the four elements, the *quadrivium*, and the set of four numbers that can be arranged proportionally to define the consonant and structural intervals of the Pythagoreans ({12, 9, 8, 6}). By the fourth century B.C. the *tetraktys* was dually manifested in music as the intervals of {12, 9, 8, 6} and as the tetrachord, four strings or notes spanning a fourth. The distinction between multitude and magnitude is as ubiquitous as the *tetraktys* in Pythagorean writings; multitude is associated with the study of numbers in and of themselves (arithmetic) while magnitude is linked to the material display of numbers perceivable by the sense of sight (geometry). This distinction stands at the nexus of Pythagorean cosmologic theory. By number the Pythagoreans meant integer [...]”. More on “Pythagorean mathematics” in [Crocker, 1963, p. 192–193].

⁴³ The (ascending) octave has a (string lengths) ratio of 1/2 (or 2/4), the fifth a ratio of 2/3, the fourth a ratio of 3/4, the octave + the fifth a ratio of 1/3 and the double octave a ratio of 1/4 – see Slide No. 3 in the accompanying Power Point demo to listen to the different tones shown in this example. This figure, and the following in this chapter are lifted and translated from either of [Beyhom, 2010b; 2010c; 2015b].

⁴⁴ The elements 6 8 9 12 of the *tetraktys* are obtained by multiplying the three last elements of the *tetrad* (2, 3 and 4) paired as “2, 3” and “3, 4”; 5 and 7 (found to the right and lower sides of the square), being the first prime numbers after 3, are obtained by summing the elements of the two pairs. And an alternative

There are many ways for using extended or alternative *tetraktys*⁴⁵, one of which is shown on Fig. 3, for the particular example of the 6 8 9 12 *tetraktys*.

This particular *tetraktys* gives new relations between numbers which, while illustrating two of the most common means in Greek mathematics (see Fig. 4 and Plate 1⁴⁶ – or FHT 1⁴⁷ – for explanations on the three main means used noticeably in Greek Music theories) allow, when applied to music, for a symmetrical division of the octave in two (Just) fourths joined by the so-called “disjunctive” Pythagorean tone (ratio 8/9).

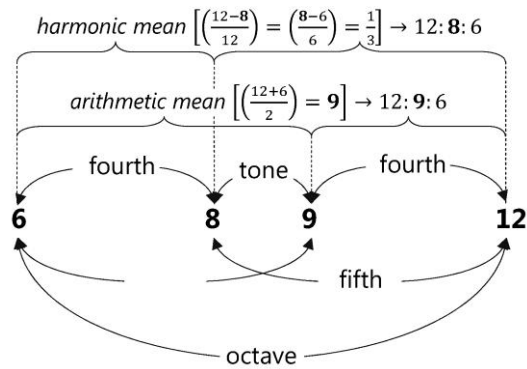

Fig. 4 Using the *tetraktys* 6 8 9 12 to explain the *arithmetic* and *geometric* means⁴⁸.

explanation: “A rectangle is constructed whose sides are to one another in length as 5 to 7. The area will then be 35. The author then divides the rectangle into four compartments by drawing two lines, one perpendicular to the shorter sides and dividing them each into two parts with lengths 2 and 3, and the other perpendicular to the longer sides and dividing them into parts with lengths 3 and 4. The areas of the four compartments will then be 6, 8, 9, and 12 (sum, 35): These numbers contain the arithmetical progression 6 9 12 and the harmonic progression 6 8 12; in the former we have the ratio of the fifth (2:3) followed by that of the fourth (3:4), in the latter, the order is reversed, while the ratio of the extremes is that of the octave (1:2), and the ratio of the two means is that of the Tone (8:9)” – in [Johnson, 1896, p. 55–56].

⁴⁵ See footnote 42: understand here as suites of four integers.

⁴⁶ “FHT” is used for plates, meaning (in French) “Figure Hors Texte”.

⁴⁷ P. 180.

⁴⁸ The elements of the *tetraktys* delineate two (Just, with ratio 3/4) fourths separated by a disjunctive tone (ratio = 8/9). The *harmonic mean* may be described as “y” in the formula $\frac{z-y}{z} = \frac{y-x}{x}$; the *arithmetic mean* can be deduced from $z - y = y - x \rightarrow y = \frac{z+x}{2}$; as for the *geometric mean*, the formula is $\frac{z}{y} = \frac{y}{x} \rightarrow y^2 = zx \rightarrow y = \sqrt{zx}$. See Slide No. 4 in the accompanying Power Point show to hear the different pitches, and FHT 1, p. 180.

In order to explain Melodic music (Greek music at that time), many procedures were used for various compositions of the tetrachordal structuring of the Container fourths, also called *genera* in modern interpretations⁴⁹, the most prominent in Pythagorean mathematics (in the Occidental-oriented reading of these theories) being the insertion of the Pythagorean 8/9 tone twice in the fourth with a remainder *leimma* 243/256 (see Fig. 5), a construct which (to the least restrictively) became the prototype of the “diatonic”⁵⁰ *genus* in Occidental literature.

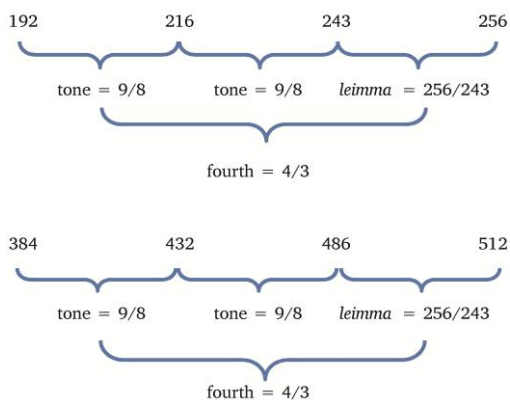

Fig. 5 Schemes illustrating the use of integer suites in two typical constructs of the “tense diatonic” tetrachord, the integer values of the lower scheme being doubled when compared with those of the upper scheme⁵¹.

Another procedure favored by the Ancient Greek (or later Roman) authors was the superparticular progression⁵² $n_i/n_i + 1$ (Fig. 6 and FHT 57⁵³) which is apparently very similar to the Pythagorean *tetrad* in what concerns the first members of the suite and gives, for the first three members of the progression, the

Container intervals of the octave, the fifth and the fourth.

Tetrad					
numerator	1	2	3	4	5
denominator	2	3	4	5	6
value in cents	1200	702	498	386	316
	8 ^{ve}	5 th	4 th	3 ^{rds}	

Fig. 6 Superparticular progression (for $n_i/n_i + 1$) with $n = 1$ to 5, with equivalent-values of the resulting intervals in cents⁵⁴.

Higher rank members of this progression give various thirds and seconds used in the (theoretical) composition of tetrachords; they are mainly characteristic of *zalzalism* and general *diatonism* (as opposed to “tense” *diatonism*, or *ditonism*)⁵⁵.

Genera (*tetrachords*)

Genera (or tetrachords, technically) are numerous in ancient Greek theories, depending on authors, time periods⁵⁶ and classifications. The main classification differentiates *diatonic*, *chromatic* and *enharmonic genera*, every class containing different quantitative expressions of the *genus*. Quantification *per se* can be expressed in length of strings (or frequency) ratios⁵⁷ – mainly a Pythagorean procedure, or in fractions of the

⁴⁹ I use the term “tetrachords” for the structured Container fourths, and *genus* or *genera* (*jins* or *ajnas* being their counterparts in Arabic) for the typical melodic interpretations of a tetrachord in a given repertoire – see also footnote 37.

⁵⁰ Or “tense diatonic” in some of the Ancient theories.

⁵¹ Adapted from [Beyhom, 2010c, v. 1, p. 55]. The computation of the ratio of the *leimma* is relatively easy to deduce as $3/4 \times 9/8 \times 9/8$, or the ratio of the fourth minus (divided by, in interval computation) two 8/9 tones (values in the figure are inverted, as they are here frequency – and not length – ratios (reminder: 8/9 in lengths of the string = 9/8 in frequencies – see also footnote 57).

⁵² The superparticular progression is closely related to the acoustical harmonics and their relations with one another (direct intra-harmonic intervals) – more details to be found in Chapter 3 and in Appendix 4.

⁵³ P. 221.

⁵⁴ Reminder: 1 cent = 1/100 of an equal-tempered half-tone – this figure is part of FHT 57, p. 221: the five members of this progression give the ratios of the octave (1/2), the fifth (2/3), the fourth (3/4), the so-called “harmonic third” (4/5) and the 5/6 third (or “augmented second?”); Ptolemaos “equal-diatonic” tetrachord shown further in the text is a direct sequel of this progression.

⁵⁵ See Appendix 4 for more details on this progression and its relation to the “Theory of Resonance”.

⁵⁶ It is possible that regions in which these theories were written, the influence of the milieu have affected the authors: I do not know yet of a detailed study on this subject, which seems to me worthy of research.

⁵⁷ Reminder: frequency ratios are equal to the inverted string lengths ratios; for example an ascending fourth frequency ratio 4/3 (the upper note is equal to four thirds of the frequency of the lower note; the fourth above would be equally higher, *i.e.* the ascending double fourth’s ratio is $4/3 \times 4/3 = 16/9$ – in frequencies) would be expressed 3/4 in string lengths (on an unfretted lute, for example, the ascending fourth is reached by shortening the string length to three fourths of the total length of the string, the upper fourth being reached by further shortening the remaining string length by the same proportion, the ascending double fourth having then the ratio 9/16 – in string lengths).

tone as expressed firstly by Aristoxenos⁵⁸ then by Cleonidēs⁵⁹.

As a prefatory remark, let us note that much was written on Aristoxenos' "doctrine" as opposing the senses⁶⁰ to mathematics⁶¹ or advocating equal-temperament against "just" intervals, authors mainly opposing it with the Pythagorean "doctrine" (or "philosophy"), and very few trying to reconcile both⁶²; however, Aristoxenos was not only aware of Pythagoreanism, but also used Pythagorean mathematics implicitly in his demonstrations⁶³.

In Aristoxenos' *Harmonic Elements*⁶⁴, the author describes (and quantifies) six typical *genera* of which two are *diatonic* (see Fig. 7 – *soft* and *tense* diatonic *genera*), three others being chromatic (*soft*, *hemiolic* or *tense*) with one single *enharmonic genus* the composition of which is a (descending) ditone and two quarter-tone intervals.

⁵⁸ I prefer the use of Greek names to Latinized ones, thus for "Aristoxenos" instead of the Latinized "Aristoxenus".

⁵⁹ Let us remind the reader here that Cleonidēs, and not Aristoxenos, introduced the 12th of tone measuring interval, whenever Aristoxenos acknowledged only the quarter-tone as the smallest element of the scale; the so-called "twelfth of the tone of Aristoxenos" is an invention based on the difference between 3/8th of a tone and the quarter-tone, but Aristoxenos did not consider the 3/8th of a tone as an interval *per se*, but as half of the *pycnon* of the hemiolic chromatic tetrachord, a three-quarter-tones interval – see Fig. 7 and Appendix 2; for Cleonidēs see the appendix of [Beyhom, 2010c].

⁶⁰ Or musical perception.

⁶¹ Understand as "Pythagorean mathematics" applied to music.

⁶² An example of the latter is Cazden's article [1958]; note also in [Mathiesen, 1975, p. 255–256 (footnote 34)]: "Indeed, the striking differences in procedure between Euclid's *Division* [the *Sectio canonis*] and Aristoxenos' *Harmonics* have been emphasized at the expense of noting their similarities. Several authors have treated the relationship between the Pythagoreans and Aristoxenos at some length, especially Richard L. Crocker, 'Aristoxenos and Greek Mathematics,' *Aspects of Medieval and Renaissance Music. A Birthday Offering to Gustave Reese*, ed. Jan La Rue (New York: W. W. Norton, 1966), pp. 96-110; Norman Cazden [referenced above]; and Reginald P. Winnington-Ingram, 'Aristoxenos and the Intervals of Greek Music'" [1932].

⁶³ Which I show – hopefully – in Appendices 1 and 3 for the sizes of the *pycnidium* for his typical tetrachords, or the determination of the "half-tone" by "the senses"...

⁶⁴ Reminder: [Aristoxenos and Ruelle, 1870] or [Aristoxenos and Macran, 1902]; this treatise is the only extant (as a copy, and almost) complete treatise on music among Ancient Greek writings (excluding later Greco-Roman – or Byzantine – additions or interpretations).

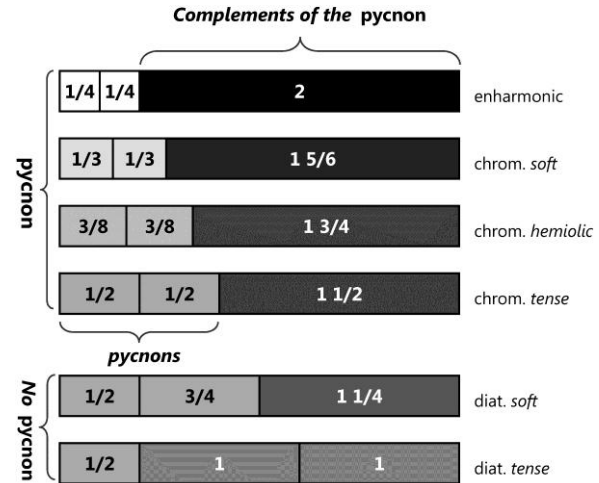

Fig. 7 Aristoxenos' typical tetrachords (interval values in fractions of the equal-tempered tone), including *pycnon* (the first four from top), and non-*pycnon* (the two below) tetrachords⁶⁵.

Aristoxenos' explanations⁶⁶ clearly show that these (from this point on) tetrachords are typical, but neither exclusive or of general use as quantitatively described by him, for there exists an infinity of *shades* (variants) for the composition of tetrachords in each class⁶⁷.

A very important feature of Aristoxenos' typical tetrachords are the *pycnidium*, or the reunion of the two smallest⁶⁸ intervals in the tetrachord (Fig. 7); the general rule is that the *pycnon* exists only if it is smaller than the largest interval in the tetrachord or, put in mathematical terms (with the biggest interval being I_3 ,

⁶⁵ The *soft diatonic* is the prototype of the Arabian *original hijāz* (1/2 tone, 3/4 tones and 5/4 tones) – see also FHT 48, p. 216 for Aristoxenos' use of the *tetrad* for the *pycnidium*, and FHT 2, p. 181, for a notated version by Weil and Reinach. Note also that Winnington-Ingram [1932, p. 198] mentions some other "shades" in Aristoxenos' explanations in the *Elementa harmonica*, namely a mixed chromatic 1/3 + 2/3 + 1/2, and two diatonics with chromatic *parhypate*: 1/3 + 1 1/6 + 1 and 3/8 + 1 1/8 + 1.

⁶⁶ Please see [Beyhom, 2010a; 2010b – Appendix on Greek Music theories; 2015, p. 135-142] for detailed information and references on this subject.

⁶⁷ With the exception of the *enharmonic* tetrachord which is unique in its class as well as a boundary case for all tetrachords: quarter-tones being the smallest intervals used in melody, the (clear) progression in Aristoxenos' tetrachords, from *tense diatonic* to *enharmonic* must stop at the *enharmonic* tetrachord. Note that this corresponds to *maqām* praxis as known to us in the last three centuries, with an almost infinite diversity in the use of various *diatonisms* and *chromatisms* in the music of the (extended, varied, Near, Middle, Far) Orient.

⁶⁸ And, by convention in most Ancient Greek theories, which occupy the "lowest" (in the modern musical sense of the term) part of the tetrachord.

and I_2 and I_1 the smaller intervals composing the pycnon), whenever $I_3 > I_2 + I_1$.

We can conclude from the former that diatonism is firmly rooted in the “non-pycnon” rule, or: “whenever there is no pycnon, the tetrachord is *diatonic*”.

Pythagoreans generally shared this concept and proposed, throughout the centuries, many formulations for different types of tetrachords⁶⁹ (see FHT 4, p. 181) from which the *diatonic* variants are detailed on FHT 2⁷⁰ and, for a later period,⁷¹ on Fig. 8.

However, Occidental musicologists in the 19th to 21st centuries have favored a restricted acceptance of the classes of tetrachords, conveyed by two Pythagorean oriented texts: the *Republic* of Plato (429?–347 B.C.)⁷² and the *Sectio canonis* ascribed to Euclidēs⁷³.

A third text, the *De Musica* of (Pseudo-)Plutarch (ca. 45–120 C.E.)⁷⁴, was mostly favored for its famous

⁶⁹ Some of the theoreticians – notably Ptolemaos (see FHT 3, p. 181) – describing simultaneously, as with Aristoxenos, different variants in one class of tetrachords.

⁷⁰ p. 181.

⁷¹ Greco-Roman then Byzantine.

⁷² Some useful general references for Plato’s *Republic* (and Plato’s philosophy and life): [Kraut, 2015; Plato, s.d.] and [Borthwick, 1963; McClain, 1977; McClain, 1978; Mountford, 1923; Plato; Théon de Smyrne and Dupuis, 1892].

⁷³ [Barbera, 1984; Barker, 1981], but also [Cléonide and Euclide, 1884; Euclid, Barbera, and Porphyry, 1991; Mathiesen, 1975; Tannery, 1904]. Mathiesen avoids in his 1975 article [p. 253, Footnote 1] the questions of authenticity and dating of the *Sectio canonis*, as does [Barker, 1981], whenever Barbera (in [Barbera, 1984; Euclid, Barbera, and Porphyry, 1991]) gives detailed discussions of these topics. In *Appolo’s Lyre* Mathiesen concludes: “The protracted evolution of the treatise, as well as a number of internal inconsistencies, make Euclid’s authorship quite unlikely. There is, however, some evidence in favor of Euclid: the shorter version of the *Sectio canonis* quoted by Porphyrius is attributed to Euclid, treatises on music and on the canon are ascribed to Euclid by Arabic scholars from the tenth century onward, and later Byzantine scholars such as Theodorus Metochites (1270-1332) refer to Euclid as an author who wrote on musical subjects. Porphyrius’s attribution is telling, but it is important to recall that it applies only to the shorter version of the *Sectio canonis*, which includes just the mathematical propositions and the musical corollaries; the introduction, enharmonic passage, and the canon itself do not appear, though they may already have been a part of the treatise. References after Porphyrius cannot be positively identified with the *Sectio canonis* and may simply derive from Porphyrius’s attribution [...] Although the authorship and date of the *Sectio canonis* must remain open, it probably had evolved into more or less its final form in late antiquity, that is, sometime between the fourth and sixth centuries C.E.” – [Mathiesen, 1999, p. 345–346].

⁷⁴ [Bromley, 1822; Karamanolis, 2010] (in English) and [Plutarque (0046?-0120?), 1900] (in French).

discussion between Soterichos and Lysias – two stage names for Aristoxenos and Pythagoras – and the arguments used in this discussion.

Diatonic <i>genera</i> of Pachymeros and Bryennius					
Type	diatonic: equal	diatonic: "syntonic" or "tense"	diatonic (P. "middle" or "tonic")	diatonic: "soft"	diatonic: "ditone"
1 st ratio	9/10	9/10	8/9	7/8	8/9
cents	182	182	204	231	204
2 nd ratio	10/11	8/9	7/8	9/10	8/9
cents	165	204	231	182	204
3 rd ratio	11/12	15/16	27/28	20/21	243/256
cents	151	112	63	84	90
Sum	498	498	498	498	498

Fig. 8 “Late diatonic” *genera* (tetrachords) of Pachymeros and Bryennius⁷⁵.

I try to show in the next paragraphs the arguments used to justify (or hide, eventually) this biased preference for a ditonic interpretation of Ancient Greek theories in Occidental music(ologic)al literature.

Restricted acceptance of Ancient Greek theories in Occidental musicological literature

As a foreword to this section let me stress that, among the numerous variants and infinite⁷⁶ shades of diatonism, Western musicology chose to keep only the tense diatonic tetrachord, mainly because of the influence of the Neo-Pythagoreans and of the *Sectio canonis*, bust mostly because of Occidentism.

⁷⁵ As noted from [Pachymeres and Bacchius l’Ancien, 1847, p. 508, 513, 515, 517, 520, 522, 524] and [Bryennius, 1970, p. 113, 115, 135, 137, 139, 141, 143] – both authors follow Ptolemaos.

⁷⁶ For example (in [Mathiesen, 1999, p. 104–105]): “Psellus [...] observes that Euripides was also known for using many different species and shades of the musical scales”, and [footnote 167]: “The ‘harmonia’ in its earliest sense was simple and unified [...], unlike the other *genera*, which had various shades”, and mostly, speaking of Aristoxenos’ *genera* ([Mathiesen, 1999, p. 313]): “After specifying the various positions for *lichanoi* and *parhypatai* [the ‘movable notes’], Aristoxenos is quick to dispel any implication that these might be six specific and fixed points. Rather, the positions are ranges within which the notes may fall according to the particular coloration of the music. Thus, the specific points on which *lichanoi* and *parhypatai* might fall are potentially unlimited in number” {cf. [Winnington-Ingram, 1932, p. 197]: “[...] Aristoxenos’ primary object is to delimit the spheres of enharmonic, chromatic and diatonic by defining the *loci* of the movable notes in each (a task, he says, never before attempted in theory: 35, 4); then within each of these to enumerate certain simple and intelligible types. He himself reveals that they do not represent all the genuinely melodious divisions, and in particular that equal division of the pycnon is not obligatory. Far less do they represent all conceivable divisions, which are infinite”}.

Owing to (Occidental) anthropomorphism, Western musicology tended to consider all Ancient Greek music as based on the tense diatonic (or simply “ditonic”) tetrachord, and extended the scope of this limited diatonism to all Ancient and modal non-Western music.

Moreover, the Arabic texts of the philosophers of the Golden Age of Muslim Civilization were either neglected or interpreted in such a way as to maintain tense diatonism as the basis of (the so-called “Medieval”)⁷⁷ Arabian theories (and music); this was also the case with Ancient Byzantine theories and music.

GENERA AND TETRACHORDS IN OCCIDENTAL THEORIES AND MUSIC LITERATURE

Apart from specialized literature (and even with the latter, as we shall see), Occidental representations of Ancient Greek *genera* are restricted to the semi-tonal (generally equal-tempered) representation of tetrachords, extended exceptionally (even though reluctantly as we shall see) to the equal-tempered *enharmonic* tetrachord (see Fig. 9 to Fig. 11).

One of the striking features of these representations is that they are often proposed or advocated by the

⁷⁷ I often wonder (and deplore) how Occidental scholars can use such ethnocentric terminology as to call “Medieval” what belongs to the Golden Age of Arabian thought and philosophy (the same critic applies to “Medieval” Byzantine chant); while Bernard Lewis uses the term in a similar fashion (for example in his article “The Islamic guilds in the middle ages” – [Lewis, 1940]), it should probably be considered as a trait of the Orientalism criticized by Said (see the introduction to Chapter 4 and Appendix 7). Moreover, the terms “Middle Ages” and “Medieval” seem to be an invention from the Renaissance, as puts it French journalist Pierre Barthélémy (quoting notably Joëlle Burnouf): “What are the Middle Ages and where does this name come from? Emeritus professor at the Paris-I-Panthéon-Sorbonne university, Joëlle Burnouf, summarizes the answer with her usual straight-talk thus: ‘it is a concept which was invented in the 16th century by communication experts, the people of the Renaissance which made their own promotion: they considered themselves as a comeback to Antiquity which, for them, was the climax of quality’. The millenary in between was then nothing more as an intermediate state...” (in French “Qu’est-ce que le Moyen Âge et d’où vient ce nom ? Comme le résume, avec le franc-parler qui la caractérise, Joëlle Burnouf, professeure émérite d’archéologie médiévale à l’université Paris-I-Panthéon-Sorbonne, ‘c’est un concept inventé au XVI^e siècle par des as de la com, les gens de la Renaissance, qui faisaient leur propre promotion: ils se considéraient comme un retour à l’Antique qui, pour eux, était le summum de la qualité’. Le millénaire qui s’était écoulé n’était donc qu’un état intermédiaire...” – in [Barthélémy, 2016]).

translators of Ancient Greek treatises such as Macron in the foreword of his edition of Aristoxenos’ *Elementa harmonica* (Fig. 11) or by Weil and Reinach in their French edition of Plutarch’s *De Musica* (see the section *Pro-ditonic arguments* below)⁷⁸.

	Lower register		Higher register	
	Hypate			Nete
<i>diatonic</i>	½ tone	1 tone		1 tone
<i>chromatic</i>	½ tone	½ tone	1 ½ tones	
<i>enharmonic</i>	¼ tone	¼ tone	2 tones	

Fig. 9 The three typical *genera* as exposed in (mainly) Occidental literature about Ancient Greek theories⁷⁹ – see also (and listen to the different pitches in) Slide No. 6.

Other “specialists” of Ancient Greek music seem to favor also this restricted presentation, such as Chailley (Fig. 12) and Vincent (Fig. 13), all being seemingly influenced by Boethius’ treatise *De Institutione Musica*⁸⁰

⁷⁸ Even Curt Sachs, a critic of philologists’ translations (including Reinach’s and other authors’ translations of Plutarch’s *De Musica* – see [Sachs, 1943, p. 201]) and well aware of the various shades of diatonism in Greek music (see [Sachs, 1943, p. 211]), restricted his discourse, when generally presenting *genera*, to the three “canonic” types – see [Sachs, 1943, p. 206].

⁷⁹ This representation and others, equivalent in their refusal of “intermediate” *genera*, may be seen (or read) in various writings on music; here is an example of the typical discourse on Greek tetrachords: “Pythagoras, the famous philosopher and social leader born in Samos in 582 B.C., educated by long residence in Egypt and extensive travel, and finally teaching in southern Italy was the chief pioneer. He laid the foundation of musical acoustics as a science, and started a school of investigators that lasted long after the Christian Era. His followers tended to regulate all musical procedure by mathematics, and the opposition long continued between them and the disciples of Aristoxenos, born about 354 B.C., who advocated taste and instinct as normative principles. [...] Three ‘*genera*,’ or ways of dividing the tetrachord, were used: (a) the diatonic, consisting of two whole steps or ‘tones’ and a half-step or hemitone, (b) the chromatic, consisting of an extra long step with two half-steps, and (c) the enharmonic, consisting of a double-step with two quarter-steps. [...] The diatonic genus was felt to be the most important of the three, and as it is the form that has had historic influence since, it will be the only one taken for further illustration here” – [Pratt, 1907, p. 53, 55]; similar discourses are to be found almost everywhere in music literature of the 19th-20th centuries, and were translated from one Occidental language to another as in [Stafford, 1832, p. 142–145].

⁸⁰ See [Boethius, 2004, p. 258–259] and, for instance, [Sachs, 1943, p. 200]: “King Theodoric’s unfortunate chancellor Boethius, who concluded musical antiquity with a presentation in five books *De Musica* which, for a thousand years, was considered the musical bible of the West”.

and the *Sectio canonicis*⁸¹ of the Pseudo-Euclidēs which hold the core of restricted Pythagoreism.

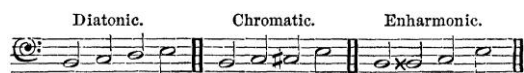

Fig. 10 “The Greek tetrachords” as notated in [Lunn, 1866, p. 262].

TABLE 1.
SCHEME OF THE ENHARMONIC TETRACHORD SCALE OF THE TONIC A.



SCHEME OF THE CHROMATIC TETRACHORD SCALE OF THE TONIC A.



SCHEME OF THE DIATONIC TETRACHORD SCALE OF THE TONIC A.



Fig. 11 Typical Occidental representation of the Greek genera (tetrachords), here by Macran for his general introduction on Ancient Greek music in his edition of Aristoxenos’ *Elementa harmonica*⁸².

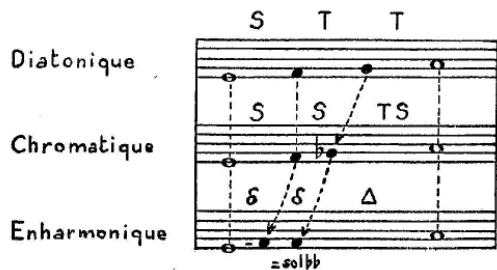

Fig. 12 Notation of typical Greek tetrachords by Chailley⁸³ – see also Slide No. 6.

This representation is also extended to scales (“modes”, “tones”) as shown in Fig. 15 and in the more recent re-edition of the *Histoire de la Musique* by the prestigious *Encyclopédie de la Pléiade* (Fig. 16).

Typically, the *enharmonic* quarter-tones are (more or less) acceptable in these representations⁸⁴, but not

the dazzling⁸⁵ third of the tone (*soft chromatic*), and even less the 3/8 of the tone (*hemiotic chromatic*), not to mention the 3/4 and the 5/4 tones of the *soft diatonic* tetrachord, the prototype of Zalzalian chromatism⁸⁶.

	Nète.	Aigu.	Indicatrice.	Grave.	Hypate.
Diatonique.....		1 ton		1 ton	1/2 ton
Chromatique.....		1 1/2 ton		1/2 t.	1/2 ton
Enharmonique.....		2 tons		1/4	1/4

Fig. 13 Typical restricted presentation of Greek tetrachords by Vincent⁸⁷.

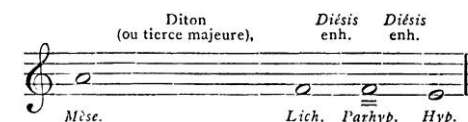
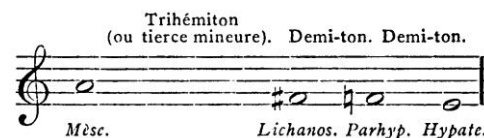
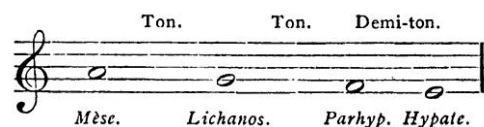

Fig. 14 The three “typical” tetrachords as notated by Gevaert⁸⁸.

Although exceptions existed, and albeit full reports on tetrachords are more and more present in specialized studies on Greek music, arguments against

⁸¹ Apart from Mathiesen’s article/translation cited above, see [Barbera, 1984; Barker, 1981; Cléonide and Euclide, 1884; Euclid, Barbera, and Porphyry, 1991; Euclide, 1884; Tannery, 1904].

⁸² [Aristoxenos and Macran, 1902, p. 8].

⁸³ [Chailley, 1960, p. 12].

⁸⁴ These are a “logical” sequel of dividing the “tones” by two, here twice.

⁸⁵ And which can not be transcribed in classical Occidental notation: modified accidentals are used mainly for quarter-tones, as in Fig. 11, Fig. 12 and Fig. 15.

⁸⁶ When the 5/4 tones interval is central to the tetrachord, along with the “equal-diatonic” of Ptolemaos for Zalzalian diatonicism.

⁸⁷ In [Pachymeres et Bacchius l’Ancien, 1847, p. 392]; Vincent comments: “Archytas, Eratosthenos and Didymus are the first musicians from whom theories have reached us; they differentiated only those three genera whose formulas they calculated each to his convenience; subsequently, these genera were subdivided in various colors or shades” – in the French original: “Archytas, Eratosthène et Didyme, les plus anciens musiciens dont nous connaissons d’une manière précise les théories musicales, ne distinguaient que ces trois genres dont chacun d’eux calculait les formules à sa manière; mais, postérieurement, on subdivisa ces genres en diverses couleurs ou nuances”.

⁸⁸ [Gevaert, 1875a, v. 1, p. 272].

generalized (i.e. Zalzalian) diatonism and against enharmonism, if not excluding chromatism, prevail in the 19th-20th centuries⁸⁹.

HEPTACHORD SCALES IN THE THREE GENERA WITH
THE NAMES OF THE INDIVIDUAL NOTES

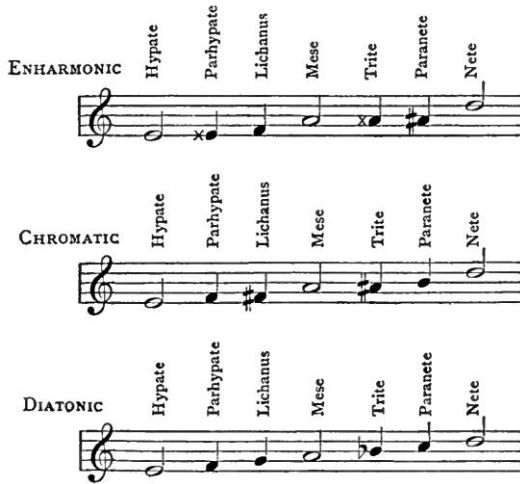

Fig. 15 Typical Occidental representation of the Greek heptachord scales, here by Macran for his general introduction on Ancient Greek music in his edition of Aristoxenos' *Elementa harmonica*⁹⁰.

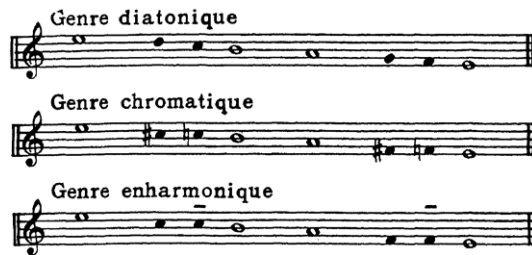

Fig. 16 The “three” types of “genera” as notated in the French *Histoire de la Musique / Encyclopédie de la Pléiade*⁹¹.

⁸⁹ And prevail today, as a majority of (more or less) specialists in Ancient Greek music still (as before – for example by the Abbé Roussier [Roussier, 1770]) focus on Pythagoreanism and diatonism in their writings – this phenomenon, as we will see in Chapter 5, is even more significant in Archeomusicology.

⁹⁰ [Aristoxenos and Macran, 1902, p. 14].

⁹¹ [Tiby, 2001, p. 381]; Tiby's explanations [2001, p. 380–381] are even more centered on classical tonal music (although the chapter is entitled “The music of Greco-Roman civilizations”): “The Greeks acknowledged the possibility of altering some of the degrees of the Modal octave [?]. Thus were obtained the *genera*, which were three in number: *diatonic*, *chromatic* and *enharmonic*. The first of the *genera* consisted in simple, unaltered sounds which correspond to the white keys of our keyboard. In the chromatic *genus*, the 2nd and the 6th degrees of the descending scale were altered – as if adding two of the black keys of our keyboard. Finally, in the third case, the enharmonic *genus*, certain sounds – namely the 3rd and the 7th of the descending scale – were given intermediate values – [the] quarter-tone – that our keyboard is

Pro-ditonic (and pro-Hellenistic) arguments – And their refutal

Pro-ditonic arguments, i.e. against the use by Ancient Greeks of anything else than tense diatonism in their “effective” music, are varied but can be summarized in three main propositions:

1. Ancient Greek music is not oriental (and enharmonism is oriental).
2. Anything else than diatonism (or tense chromatism) is too subtle to be correctly heard, or too difficult to perform effectively.
3. Diatonism is superior to other possibilities in Greek music, and represents the highest stage of evolution for this music; the corollary to this utmost surprising statement says that diatonism, being “natural”, must have predated all other forms of music⁹².

None of these arguments, however, is supported by compelling or solid proofs in the explanations provided by our “musicologists”... but let us first review some of these explanations in detail.

“ANCIENT GREECE IS NOT ORIENTAL”

Although Asiatic, and generally “Oriental”, influences are documented in Ancient Greek writings⁹³, the musical and musicological Occidental discourse tended to dismiss these influences and credited the Greeks with being a strong, independent “race” whose “homogeneous”⁹⁴ music (and theory) was handed down to Europe through the Romans:

– unable to reproduce” (in the original: “les Grecs reconnaissent la possibilité d’altérer certains degrés de l’octave modale. On obtenait ainsi les *genres*, qui étaient au nombre de trois: *diatonique*, *chromatique* et *enharmonique*. Le premier de ces genres était constitué de sons simples, sans altérations, correspondant aux touches blanches de notre clavier. Dans le genre chromatique, le 2^e et le 6^e degré de l’échelle descendante étaient altérés – comme si nous ajoutions deux touches noires de notre clavier. Dans le troisième cas enfin, le genre enharmonique, certains sons – à savoir le 3^e et le 7^e de l’échelle descendante – étaient affectés de valeurs intermédiaires – quart de ton – que notre clavier est impuissant à reproduire”).

⁹² These two statements have in common the alleged superiority of diatonism over other forms of music.

⁹³ Almost all commentators cite these influences, sometimes to dispel them immediately afterwards as below with Emmanuel.

⁹⁴ Understand “Pythagorean”, ditonic.

“Whenever it is true that Appolo came from the banks of the Nile and that Orpheus brought Phrygian Art to the Occident, Dorians, who established [“did”] Greece, shook these opposite influences [from Egypt and Asia] off. Their vigorous race has, up till its end, drawn from its teachers fruitful lessons, but it has never accepted to live under their yoke. Thus educated, it escaped [these influences] and submitted traditions from far away to new laws, and adapted to its own taste all alien musics. **Greece has given itself thus its own music, whose principles it maintained unchanged for five or six centuries, and that it handed down, through the Romans, to Medieval artists**”⁹⁵.

Such statements, which constitute the foundations of Musical Hellenism, remained practically unchanged in their substance, in mainstream musicology, throughout the 20th century:

“My entry point remains unchanged: the extraordinary conservatism of the Greek people, along with its ability for assimilation”⁹⁶.

These statements are however completely contradicted by all we know about Ancient Greek music, as expressed for instance by Jon Solomon in his introduction to Ptolemaos’ *Harmonics*:

“At the outset let me attempt to clarify why we do not have and could never have a completely unified, consistent, coherent accounting of ancient Greek music and music theory [...] ‘Ancient Greek music’ encompasses over 1200 years or more of different musics and 700 years or more of different musical theories. Complicating the matter further is what has been traditionally understood to be **a lack of interchange between those who made ancient music and those who wrote about it [...] the correspondence between ancient Greek music and ancient Greek theory seems to be far from total**, and this must be attributed for the most part to the first two factors described above, namely, that we are dealing with theoreticians and musicians who geographically

⁹⁵ All quotes in bold in this dossier, unless otherwise mentioned, are mine. This quote is translated from [Emmanuel, 1921, p. 383]: “S’il est donc vrai qu’Apollon soit venu des bords du Nil et qu’Orphée ait apporté à l’Occident l’art de la Phrygie, les Doriens, qui firent la Grèce, secouèrent ces influences opposées [de l’Égypte et de l’Asie], qui s’exerçaient sur eux. Leur race vigoureuse a su, jusqu’à la fin de ses destinées, tirer de ses précepteurs de fécondes leçons, mais elle n’a point consenti à en subir le joug. Instruite, elle s’est évadée, trouvant dans son génie la force de faire plier à des lois nouvelles les traditions venues de loin et d’adapter à son goût toutes les musiques du dehors. **La Grèce s’est ainsi donné une musique propre dont elle a jalousement maintenu les principes pendant cinq ou six siècles, et qu’elle a léguée, par l’intermédiaire des Romains, aux artistes médiévaux**”.

⁹⁶ [Baud-Bovy, 1978, p.153]: “Mon point de départ demeure inchangé: l’extraordinaire conservatisme du peuple grec, en même temps que son pouvoir d’assimilation”.

span the entire Mediterranean basin from Ptolemy’s Alexandria to Aristoxenos’ Italy to Nicomachus’ Gerasa and who temporally span a period from the time of Homer’s predecessors to the time of Boethius—more than one millennium”⁹⁷.

“Ancient Greek music” is thus a synonym for “Ancient Mediterranean music”⁹⁸, explained by Ancient Greek-speaking theoreticians and performed and influenced variously⁹⁹, locally or from neighboring realms, for at least one millennium...

“ENHARMONISM AND OTHER NON-DITONIC FORMS ARE UNATTRACTIVE, DIFFICULT (IMPOSSIBLE TO SING), IF NOT PERVERTED MUSIC”

Let me first here explain that I am not a keen supporter of enharmonism: I do not think that singing a ditone (falling or rising) followed by two quarter-tones or so, in either direction, is very melodic¹⁰⁰. I believe however that some chromatic *genera*, like the Byzantine chromatic *genus*¹⁰¹, can use (notably in

⁹⁷ [Solomon, 1984, p. 242, 243, 244].

⁹⁸ cf. [Sachs, 1943, p. 197]: “Though Greece was geographically a part of Europe, its music was largely Asiatic. The Greeks themselves admitted, indeed emphasized, this fact. They credited Egypt, Assyria, Asia Minor, and Phoenicia with the invention of the instruments they used, named two of their main tonalities after the Asiatic countries Phrygia and Lydia, referred to Egypt as the source of their musico-pædagogic ideas, and attributed the creation of Greek music to Olympos, the son of Marsyas the Phrygian. With the rise of comparative musicology, it has dawned on us that music historians of earlier generations were doomed by their ignorance of Oriental music to misinterpret the sources” – and [Sachs, 1943, p.214]: “Modern musicians, spoiled by the ready-made distances on equal-tempered keyboards, could hardly be blamed for sneering at an overrefinement that to them meant decadence and snobbishness. Still, the Greeks would have stopped their ears had they heard our piano scales, just as, vice versa, modern music lovers unfamiliar with the different principles of Oriental scales would be utterly disgusted by Greek melodies. For Greek melodies were indeed ‘Oriental,’ and their next of kin have lived in the Middle-East to this day, not in the West. [...] The Oriental warning suggests a reconsideration of what norm and exception are”. Also from [Baud-Bovy, 1986, p. 17]: “[...] music in Antiquity had no other basis as monophonic music in all the Near and Middle East” (“[...] la musique de l’Antiquité grecque ne reposait pas sur d’autres bases que la musique monophonique de tout le Proche et Moyen-Orient”).

⁹⁹ And alternatively.

¹⁰⁰ And this is a very ethnocentric notice, in which I deliberately imitate Reinach and Tiby (whose quotes are proposed in the following paragraphs), and the purpose of which is (also) to remind that one should be aware of one’s limitations.

¹⁰¹ Chrysanthos Madytos’ *chromatic genus* (Byzantine music has meanings for *chromatism*, *enharmonism*, etc. differing from Ancient

praxis) very small (mostly bordering¹⁰²) intervals with a great tone in the middle, knowing that the exact values of the small intervals are not the most important characteristic of the chromatic scale¹⁰³, as it is their relative values¹⁰⁴ that allow us to identify the *genus*.

The objections against enharmonism did not, however, concentrate on the actual variations of the chromatic enharmonic tetrachord in use in most *maqām* music¹⁰⁵, *i.e.* the *hijāz* tetrachord/*genus* in all its variations, but on the impossibility to sing such “too small, un-esthetical” intervals, here in Reinach’s formulation for his introduction of Plutarch’s *De Musica* in 1900:

“The introduction, in the threnody, of these small intervals, [which are] impossible to identify exactly or to sing, seems to be due to the influence of Oriental music, in which these are still in use today in the form of *glissandi*¹⁰⁶; the Greeks, being concerned with reason and subtle thinkers, wanted to apply

→

Greek theories) would be an ascending “7 18 3” *minutes* tetrachord, for example, theoretically a “small” tone (about three quarter-tones) followed by an expanded tone (nearly 1 ½ tones), then by a quarter-tone (Fig. 64, p. 132, the three scales to the right); other representations of chromatic *genera* include bordering third and half tones (see Plate 2 *recto* and Tableau Hors Texte 11 on Plate 4 *recto* in [Beyhom, 2015b]).

¹⁰² The tetrachord.

¹⁰³ Theory and praxis allow for a great variety of small bordering intervals in chromatism – see [Beyhom, 2014a] and the accompanying Power Point examples, as well as FHT 8, p. 183.

¹⁰⁴ *i.e.* their values as related to one another: in the case of the *hijāz* tetrachordal type (“chromatic” with a “great tone” in the middle), both boundary intervals are structurally smaller (roughly 1/4 to 3/4 of the tone) than the central interval (roughly 5/4 to 7/4 of the tone) – more on Eastern chromatism (including in Byzantine chant) and its varying intervals in the dossier [Beyhom, 2014a].

¹⁰⁵ Eastern Byzantine chant being a major component of this music.

¹⁰⁶ Ethnomusicologist Jean During reported to me in a personal communication that Uyghur musicologists claim for the existence of “quarter tones” (*chōrak parde*) in their modal system, marked by special “half-flat” accidental on their transcriptions. However their lutes (*tanbur*, *satar*, *rawap*, *dutar*) are fretted semi-tonally in equal-temperament; various techniques, which are instrument-dependent, are used for the variations in intonations (including a slight *portamento* in singing), but the so-called “neutral” tones are not an integral part of the modal system (in this particular case); the particular technique used by some of these musicians (pressing the string towards the board with high frets – see a detailed description in [During, 2008, p. 81]) allows for variations which are not clearly distinguishable as “quarter-tones”, while clearly different from the semi-tonal equal-tempered scale – see also, about the techniques and instruments used by Farhōd Qōri Halimov and Saydullōh Ubaydullōev, [During, 2011, p. 59].

precise rules and a mathematical evaluation for these “transitional sounds”; they were attracted by the very difficulty of the perception and the performance of these intervals. But this was only, in reality, a perversion of [good] taste and the 4th century reaction against the enharmonic *genus* marks the comeback of the real Greek genius, *i.e.* European¹⁰⁷.

“Oriental microtones are used in the form of *glissandi*”, “transitional sounds”, “difficult to perceive and perform”, “perversion of [good] taste”, “Greek genius is European”; we have here a real concentrate of Occidental musical biases from the 19th to the 20th centuries¹⁰⁸, from which I choose the following example by renowned ethnomusicologist Samuel Baud-Bovy¹⁰⁹:

“What would have thought Aristotle of this disciple who pretended to rely on the sense of hearing and classified in two ‘essentially’ different types tetrachords whose intervals produce a difference that the sharpest hearing could barely perceive? The difference between the *enharmonic diesis*, the quarter-tone (50 cents), and the smallest *diesis* of the chromatic *genus*, the third of the tone (66.6 cents), is barely 16.6 cents”¹¹⁰,

¹⁰⁷ [Plutarque (0046?-0120?), 1900, p. xvi-xvii]: “L’introduction, dans la mélodie, de ces petits intervalles, impossibles à déterminer exactement et à chanter juste, paraît être due à l’influence de la musique orientale, où ils sont encore employés en ‘glissade’ de nos jours ; les Grecs, avec leur esprit raisonneur et subtil, voulurent appliquer à ces ‘sons de passage’ des règles précises et une évaluation mathématique ; ils trouvèrent un charme dans la difficulté même qu’en présentaient la perception et l’exécution. Il y avait là, en réalité, une perversion du goût, et la réaction du IV^e siècle contre le genre enharmonique marque un retour au véritable génie hellénique, c’est-à-dire européen”.

¹⁰⁸ One of my former teachers of musicology used to tell me that he could not perceive the “quarter-tones” (*i.e.* the differences between equal-tempered intervals and the “middle”, or “small tones” of Arabian music); I still ask myself today if this musicologist, who notably taught “Medieval Arabian” musical systems and has directed numerous Ph.D. theses on Arabian music, was just pretending: a “coquetterie” of some sort...

¹⁰⁹ The article is entitled: “Did the enharmonic *genus* really exist?” – “Le ‘genre enharmonique’ a-t-il existé ?”.

¹¹⁰ [Baud-Bovy, 1986, p. 12]: “Qu’aurait pensé Aristote de ce disciple qui prétendait s’en remettre au jugement de l’oreille et classait dans deux genres ‘essentiellement’ différents des tétracordes dont les intervalles présentent une différence que l’ouïe la plus fine serait à peine capable de percevoir? L’écart entre la *diesis* du genre enharmonique, le quart de ton (50 cents), et la plus petite *diesis* du genre chromatique, le tiers de ton (66,6 cents), n’est en effet que de 16,6 cents”; Baud-Bovy was in this article particularly critical of Aristoxenos’ writings, and tried to foster his “pentatonic anhemitonic [Ancient Greek] scale”, as shown in the

→

adding¹¹¹ that Aristoxenos introduces even an intermediate interval between the *diesis* of the *soft chromatic* and the *tense chromatic*, the $3/8^{\text{th}}$ of the tone of the *hemiotic chromatic*. The latter interval would amount to 75 cents, a difference of eight cents with the smallest *chromatic diesis*...

Apart from the fact that Aristoxenos had other, theoretical and practical considerations in mind when choosing his values for the *pycnidium*¹¹², Baud-Bovy's notice shows that he was not¹¹³ really aware of the possibilities of pitch perception, which are discussed in a dedicated section below¹¹⁴. I find it however quite possible to agree with him that the difference between the *dieseis* of the enharmonic, and the *soft* and *hemiotic* chromatic tetrachords would be difficult to perceive in *performance* for an untrained ear. This is however not defensible in the case of attentive listening, as explained by Alexandre Joseph Hidulpe Vincent, a French mathematician¹¹⁵ who, 70 years ago already, addressed Reinach's questions and others:

"We find, amongst the *genera*, the enharmonic *genus* which is essentially characterized by the use of the quarter-tone. We think it is necessary to correct some common places about this *genus*. First, it is a great error to think that the quarter-tone cannot be perceived; experience shows that we can distinguish perfectly well an interval 8-to-10 times smaller. Moreover, we must avoid considering the division of the semi-tone as being done by a sort of 'slip' [glissando?]. On the contrary, continuous movements of the voice were avoided as a chant could only be above reproach if its intonations were very precise, clearly distinct and well detached"¹¹⁶.

→ summary of the article ([p. 20-21], in English) – for the "pentatonic *dorian* scale", see [Baud-Bovy, 1978].

¹¹¹ In a footnote on the same page.

¹¹² See Appendix 3, and the paragraph "On Greek and Arabian tetrachords" below.

¹¹³ Still at the end of the 20th century!

¹¹⁴ "On Pitch perception", with accompanying Slides Nos. 15-25 and 39: different *dieseis* can be listened to on the last slide, under "The differences between the *pycnon* intervals (*dieseis*) in Aristoxenos' typical tetrachords".

¹¹⁵ See [Anon. "Alexandre Joseph Hidulpe Vincent", 2015].

¹¹⁶ [Pachymeres and Bacchius l'Ancien, 1847, p. 397]: "Au nombre des genres [...] se trouve [...] le genre enharmonique, genre essentiellement caractérisé par l'emploi du quart de ton. Or à cet égard, nous croyons, pour rectifier quelques idées qui nous paraissent généralement admises aujourd'hui, devoir faire plusieurs observations. D'abord, ce serait une grande erreur de croire que le quart de ton soit inappréciable; l'expérience démontre que nous distinguons très-bien un intervalle huit ou dix

About one century after Vincent, Curt Sachs sets the record straight:

"Scholars of the nineteenth century were unable to understand how Greek singers could have caught and reproduced differences so tiny, and some of them suggested that the so-called quarter tones might merely have been symbols to indicate *portamento*. This is untrue, for, unlike India, Greece tabooed *portamento*; Aristoxenos stresses the fact that the singers avoided sliding and tried to poise every note as much as possible. Perfect singing depended on precise and sustained intonation. And Ptolemy briefly states 'Sliding tones are the enemies of melody'.¹¹⁷

In Reinach's case¹¹⁸, however, bad faith is obvious as he is the editor / translator of Plutarch's *De Musica*¹¹⁹, in which Soterichos (*i.e.* Aristoxenos staged by the Pseudo-Plutarch for the needs of his book) concludes the discussion with Lysias (Pythagoras) by first listing Pythagorean (ditonic) arguments:

"The most beautiful of the musical *genera*, which on account of its grave and solemn character was formerly most in esteem, is now however fully laid aside; and there are few persons in the present day, who appear capable of discerning the interval, which is its characteristic. So obtuse are become the perceptive faculties of the generality, that the Enharmonic *Diesis* (1/4 tone) is affirmed to be absolutely undistinguishable; and on this assumption it is not only denied a place in the musical scale, but brings on all, who favor the use of it, the name of triflers. Yet the most formidable argument of its opponents amount to no more than this, that because their

→ fois moindre que celui-là. Ensuite, il faut bien se garder de considérer le partage du demi-ton comme devant s'effectuer par une sorte de glissement. On évitait, au contraire, les mouvements de voix continus, ne regardant un chant comme irréprouvable, qu'autant que les intonations en étaient bien précises, bien distinctes, bien tranchées". It is noteworthy that Vincent, unlike most musicologists and ethnomusicologists (who usually stress the role of the fifth), considered [*idem*, p. 397] the fourth and the octave to be the common characteristics of musical systems "either for various folks, or in different times, or still simultaneously for a given folk" ("soit chez divers peuples, soit en différents temps, soit encore simultanément chez un même peuple").

¹¹⁷ [Sachs, 1943, p. 207].

¹¹⁸ And in many others it would be fastidious to cite (and quote), with one exception here, for [Tanner, 1961] (especially his first chapter entitled "What we know about [Ancient] Greek Music") who is admiring of Reinach's work whom he considers as one of the three major references for Greek music, with Riemann and Emmanuel...

¹¹⁹ Also a "Pseudo-?" See for example [SALAPPA-ELIOPOULOU, 2012].

auditory organs are unable to discriminate the minute divisions of the tone which the *genus* admits, there is therefore no foundation for it in nature; and it consequently ought not to be allowed in practice. Another argument, also, urged by them, is the incompatibility of the *Diesis* with symphony¹²⁰; which is not the case, they say, with the other intervals, viz. the semitone, tone, etc.”¹²¹.

Then he opposes these arguments, stressing music praxis by the same Pythagoreans:

“But they forget that they ought, for the same reason, to discard from practice the third, fifth, and seventh intervals which consist respectively of three, five, and seven [enharmonic] *diese[is]*. And indeed all the uneven intervals (or those which contain the smallest *diesis* an uneven number of times) ought on the same ground to be rejected, since none of them can be used in symphony. It is, in fact, a necessary result of their doctrine, that no divisions of the scale are applicable to practice except those, in which the intervals are expressed by even numbers¹²²; the intense diatonic, for instance, and the tonic chromatic. But what is singular in the supporters of these opinions is, that they not only contravene the evidence of fact, but are also inconsistent in the maintenance of their own principles. For we find among them an extraordinary attachment to those divisions of the tetrachords, in which many of the intervals are either uneven or incommensurable¹²³. They invariably flatten the *lichani* and *paranete*; and do so even with some of the fixed tones, to which they accommodate the *trite* and *paranete* by

incommensurable intervals. This practice they justify, and hold up to imitation; though it is evident (as has been already observed, and the effect indeed is easily discernable to a good ear) that many of the intervals are thus made irrational, not only of those sounds, which are in their nature variable, but of some of the fixed tones likewise, which they diminish in order to suit their system”¹²⁴.

It seems difficult for me to add anything to this striking summary of arguments and counter-arguments which applies plainly to *maqām* music, as well as to Greek music, and the constituents of which (mainly of Pythagorean source) would be used by generations of musicologists in the 19th-20th centuries, concerning “Arabian” music.

Let us here simply note the true divorce between (Pythagorean?) theory and music praxis, which begins with Greek Antiquity and still survives today...

“DITONISM IS THE MOST ADVANCED STAGE OF EVOLUTION OF ANCIENT GREEK MUSIC, I.E. SUPERIOR TO ALL OTHER FORMS”

Another example of pro-ditonic argumentation is Fétis’ explanations about the Greek *genera* in his monumental *Histoire de la musique*.

While dividing music around the world through Racial affiliation¹²⁵, Fétis expounds the Aristoxenian

¹²⁰ Understand “not consonant” in the restricted Pythagorean acceptance, i.e. (not) ditonic – cf. Reinach’s translation in the next footnote.

¹²¹ [Plutarch, 1865, p.101, 103], with the French version by Reinach [Plutarque (0046?-0120?), 1900, p.151, 153]: “Mais voyez les musiciens d’aujourd’hui: le plus beau des genres, celui que les anciens cultivaient de préférence à cause de sa gravité, ils l’ont complètement abandonné, à tel point que chez la plupart on ne trouve plus même la moindre compréhension des intervalles enharmoniques. Ils poussent si loin l’inertie et la nonchalance que, à les entendre, la diesis enharmonique n’offre même pas l’apparence d’un phénomène perceptible aux sens, qu’ils la bannissent de la mélodie et prétendent que ceux qui ont raisonné de cet intervalle et employé ce genre n’ont fait que divaguer. La preuve la plus solide qu’ils croient apporter de la vérité de leur dire, c’est d’abord leur propre insensibilité comme si tout ce qui leur échappait devait être nécessairement inexistant et impraticable! Puis, que l’intervalle en question ne peut être obtenu par une chaîne de consonances, comme le sont le demiton, le ton et les autres intervalles semblables”.

¹²² Intervals were represented by the Harmonicists on a grid of quarter-tones, the enharmonic *diesis* being the smallest elementary interval which supposedly served as a measuring interval (one tone = 4 quarter-tones, one semitone = 2 quarter-tones, etc.) – see also Appendix 2. The “28 quarter-tones (in the octave)” of the Harmonicists.

¹²³ Understand “which cannot be expressed as ratios of integers”.

¹²⁴ [Plutarch, 1865, p.103, 105], with the French version by Reinach [Plutarque (0046?-0120?), 1900, p.153, 155]: “Ils ignorent qu’à ce compte il faudrait rejeter aussi le troisième intervalle, le cinquième et le septième qui se composent respectivement de trois, cinq et sept diésis; et, en général, tous les intervalles dits ‘impairs’ devraient être écartés comme impraticables, puisqu’aucun d’eux ne peut s’obtenir par une chaîne de consonances: ces intervalles sont tous ceux qui ont pour mesure un nombre impair de diésis enharmoniques. Il résulterait encore de là qu’aucune des divisions du tétracorde ne pourrait être utilisée, excepté celles qui font uniquement usage d’intervalles ‘pairs’: à savoir le diatonique synton et le chromatique tonié. Mais dire et imaginer cela, ce n’est pas seulement se mettre en contradiction avec les faits, mais encore avec soi-même. Nous voyons, en effet, ces mêmes gens employer avec prédilection celles des divisions du tétracorde où la plupart des intervalles sont ou impairs ou irrationnels, car ils abaissent toujours les médiantes et les sensibles; bien plus, ils vont jusqu’à relâcher certains des sons fixes d’un intervalle irrationnel, et en rapprochent par un relâchement correspondant les sixtes et les secondes. Ainsi ils estiment par dessus tout l’emploi de gammes où la plupart des intervalles sont irrationnels, par suite du relâchement non seulement des sons mobiles, mais encore de certains sons fixes, comme il est clair pour quiconque est capable de percevoir ces choses”.

¹²⁵ Fétis (see also the quote of Maurice Emmanuel above) speaks notably of the “Hellenistic race” – a noteworthy reading is also the

and Pythagorean doctrines of *genera*, and arguments extensively¹²⁶ the “superiority” of ditonism, reversing the “usual” chronology in his time and summarizing his *exposé*:

“Some will be probably surprised to see that I reverse the order adopted by Greek theoreticians and Modern music historians alike: they have all dealt with the diatonic *genus* first, then with the chromatic and, finally, with the enharmonic (or harmonic). I choose the reverse order [...] because [...] incomplete scales and the use of quarter-tones, *i.e.* enharmony, were the basis of the most Ancient populations of Asia Minor and Greece, therefore, complete scales, composed of tones and semitones or, in other terms, the diatonic order disposed in a regular system, was the last stage of progress for tonality, for one cannot refuse to admit that the imperfections of enharmony are the beginning, and [that] the diatonic *genus* [is] the conclusion”¹²⁷ [!].

→

(uncredible, but true) article of Émile Haraszi “Fétis fondateur de la musicologie comparée. Son étude sur un nouveau mode de classification des races humaines d’après leurs systèmes musicaux, Contribution à l’œuvre de Fétis” (“Fétis [as the] Founder of comparative musicology. His study about a new classification mode for Human races after their musical systems. Contribution to the work of Fétis” – with the following quote [Haraszi, 1932, p. 99]: “The long-running studies by Mr. Fétis about the music of the ‘Ancients’ taught him that races had [their own] music, the same way they had their particular language [...] (al-) Fārābī, who wrote his treatise on music, in the 9th century, says that [the *tunbūr*] was [a] very old [instrument] in Persia and could be found all over. The neck was divided in the octave, in quarter-tones, in such a way that there were twenty-four of these intervals in the octave” (“Les longues études de M. Fétis relatives à la musique des anciens lui ont appris que les races avaient une musique, comme elles ont une langue particulière [...] El Farabi, qui écrivit son traité de musique, au IX^e siècle, dit que [le *tanbur*] était très ancien en Perse et répandu partout. Le manche en était divisé dans l’octave, en quarts de tons, de sorte qu’il y avait vingt-quatre de ces intervalles dans l’octave”). To my knowledge, Fārābī never wrote about dividing the neck of the *tunbūr* (of Baghdad – see [Beyhom, 2010c, v. 1, p. 313, Figure 109]) in “24 quarter-tones in the octave”. As for the “music of races”, I have no comments...

¹²⁶ [Fétis, 1869a, v. 3, p. 82 sq.].

¹²⁷ [Fétis, 1869a, v. 3, p. 90]: “On sera probablement étonné de me voir intervertir l’ordre adopté par les théoriciens grecs aussi bien que par les historiens modernes de la musique: tous ont traité d’abord du genre diatonique, puis du chromatique, et, en dernier lieu, de l’ enharmonique (ou harmonique). Je prends l’ordre inverse [...] parce [...] que les gammes incomplètes et l’usage des intervalles de quarts de ton, c’est-à-dire l’ enharmonie, ont été les bases de la musique des populations les plus anciennes de l’Asie Mineure et de la Grèce, et qu’en conséquence les gammes complètes, composées de tons et de demi-tons, ou, en d’autres termes, l’ordre diatonique disposé dans un système régulier, fut le

→

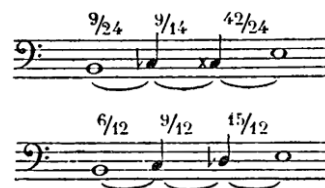

Fig. 17 Notation of the *hemiolic chromatic* (above) and *soft diatonic* (below) tetrachords by Fétis¹²⁸.

The contradictory hypothesis is thus explained:

“The Greek notations, being particularly adapted to the enharmonic *genus*, failed the diatonic *genus* in its particular needs. A simple scale, like the one in which Seikilos wrote his famous little *Skolion*, had to leap from the sixth to the ninth, tenth, fifteenth, eighteenth, and twenty-second letters of the alphabet. Does this imply that the enharmonion was older not only than the chromatic but the diatonic *genus* as well? ‘Plausibility,’ the foe of science, could not readily accept such a hypothesis, for is not the diatonic much more ‘natural’ and therefore necessarily earlier than the ‘sophisticated’ enharmonion?”¹²⁹.

“Natural”, “normal”, “superior”, “perfect” and “imperfect”¹³⁰, all these adjectives do not sound very musicological... and the origins of music, as well as generative theories for melodic music are no simple matters that can be resolved with biased arguments; this problematic is investigated in the chapter entitled “‘Musicological’ theories on the formation of the scale”.

Further refutation of (some) pro-ditonic arguments and misconceptions about Ancient Greek music

Further arguments for or against Pythagorean ditonism can be summarized by objections to Aristoxenos’ “equal-temperament”, mobility of pitches and inadequacy of non-ditonic systems for choir singing. I shall examine these, along with a digression on pitch perception, in the following sections.

→

dernier terme des progrès dans la tonalité, on ne peut se refuser à reconnaître que les imperfections de l’ enharmonie sont le commencement, et le genre diatonique la conclusion”.

¹²⁸ [Fétis, 1869a, v. 3, p. 89, 90]: the central interval of the *hemiolic chromatic* should have 9/24, like the first interval, and the suite of intervals in the tetrachord could be more simply described as 3/8, 3/8, 7/8 (of the tone), with the common denominator “8” – see also footnote 131.

¹²⁹ [Sachs, 1943, p. 206].

¹³⁰ As esthetical, or biased, qualifiers.

ON GREEK AND ARABIAN TETRACHORDS AND *GENERA* (AND ARISTOXENOS' "EQUAL-TEMPERAMENT")

One of the common places in mainstream musicology is that Aristoxenos "invented equal-temperament", either on a twelfth of the tone¹³¹ basis or an even smaller equal-divider of the (equal-tempered) tone.

The fact that Aristoxenos never even cites the 12th of the tone (or anything less than the quarter-tone *diesis*) as an elementary interval, and that he did not really seem pleased with the harmonicists and their "quarter-tone" grids (see Appendix 2) doesn't appear to be enough to stop the spreading of this myth¹³², mainly because Cleonidēs¹³³, a later theoretician, explained Aristoxenos' ideas with the help of such a small measuring interval.

Note that although the intervals composing the *pycnidium* of his typical tetrachords are presented as equal, Aristoxenos' musical conception goes far beyond this limited presentation as explained by Mathiesen in *Apollo's Lyre* (Fig. 18 for a tetrachordal representation with the note names and locations):

"With the 'infinite magnitudes of intervals' in mind, Aristoxenos attempts to generalize the three *genera* by considering the number of possible different intervals in each when the tone of disjunction is added to the generic tetrachord.¹³⁴ In its highest shade¹³⁵, the diatonic *genus* might have only two different intervals, tone and half-tone, but as the *parhypate* moves downwards, there would be three

intervals, two equal and two unequal. When the *lichanos*¹³⁶ moves downwards, four unequal intervals would result. Only in the diatonic can there be three consecutive simple intervals—the whole-tone—thus only the diatonic can have as few as two different intervals. The chromatic and the enharmonic *genera* would always have at least three different intervals: the tone, the interval larger than a tone that exists between the upper note of the tetrachord and the upper note of the *pycnon*, and the intervals within the *pycnon*. They could, however, have four different intervals if the intervals in the *pycnon* were unequal. On the surface, this section of the *Elementa* seems to stress and belabor the obvious, but in fact Aristoxenos is developing a very sophisticated point. **In a piece of music, the character of the *genera* is not perceived in a particular order of specific intervals arranged sequentially in a static scale; it is perceived in characteristic dynamic progressions of intervals, or 'roads,' that differ in ascent and descent. These dynamic progressions are readily recognizable, regardless of the notes that unfold them and even though the exact sizes of the intervals may vary from piece to piece¹³⁷. In order to convey the characteristic quality of the *genera*, the theorist does not need to specify every possible note and interval but rather the relative sizes of intervals and their typical patterns of succession.** So, Aristoxenos is able to reduce the infinite number of possible arrangements to a manageable series of archetypal *genera*¹³⁸.

This is a most interesting description that applies readily to Arabian *genera* (or inversely)¹³⁹, as the difference between theoretical representations of the tetrachords in Arabian music (Fig. 19 and Fig. 20) and their effective performance by trained musicians (Slide No. 17 for audio examples and Fig. 21) is a well-known fact for Arabian music performers, and fits perfectly well with Mathiesen's explanations about Ancient Greek music.

¹³¹ The twelfth of the tone is the common divider of the quarter-tone and the third of the tone, which Aristoxenos used in his *pycnidium* – he did not use, however, the 12th of the tone either as a structural or as a measuring interval. The 24th of the tone is the common divider of all the small intervals used by Aristoxenos in his explanations, notably of the 3/8^{ths} of the tone and the third of the tone. This small interval was used by Fétis, for example, for his explanations of Aristoxenos' doctrines (Fig. 17 and footnote 128) – see [Mathiesen, 1999] for more details.

¹³² Seemingly common in Western music literature – see for instance [Schlesinger, 1933, p. 88], in which assertions about Aristoxenos' use of the 12th of the tone, or of a Pythagorean tone, together with the assertion that the "the monochord alone [...] afforded an avenue to the scientific determination of intervals".

¹³³ Likely around the 1st century B.C. – see [Solomon, 2001].

¹³⁴ Here, footnote 91 from Mathiesen: "Figure 51 [Fig. 7 in this dossier, limited to the tetrachord] provides a clear illustration of the sizes of the intervals in the six basic shades. At this point, however, Aristoxenos goes beyond these six shades in considering the notes of the *pycnon* as infinitely variable".

¹³⁵ The lowest in Fig. 6, to the utmost right in Fig. 7.

¹³⁶ The upper internal note of the tetrachords – see also FHT 21, p. 86 in this dossier.

¹³⁷ This is what I have tried to explain, over and again, through teaching, articles, books, seminars etc., applied to modality in general and to *maqām* music in particular.

¹³⁸ [Mathiesen, 1999, p. 332–333]: bold font mine.

¹³⁹ See (and listen to) Slide No. 17 in the accompanying Power Point show; for small differences in pitch / intervals see the tonometric analysis of *jins hijāz* (performed by Hamdi Makhlouf) in the Power Point animations accompanying [Beyhom, 2014a]; for Byzantine chant, see for instance [Konstantinidis, 2011, p. 296–300] explaining that theory follows praxis and tries to describe it in this chant.

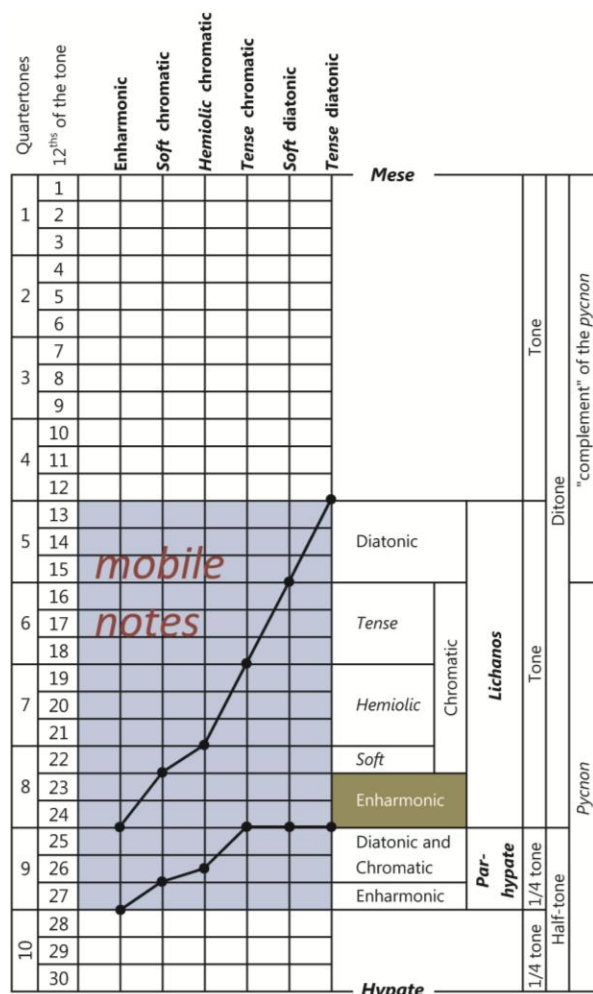

Fig. 18 Aristoxenus' typical tetrachords, with the different locations of the intermediate (between *hypate* and *mese*) "movable notes" (*lichanos* and *parhypate*)¹⁴⁰; the "location" of the "Enharmonic *lichanos*" is uncertain, as the only description of the *enharmonic genus* by Aristoxenus is the $2 \times \frac{1}{4}$ tone version.

From which we may conclude that Aristoxenus' "equal-temperament" was merely a "musicological fantasy", and that his theory and thought have long remained unclear for Greek music "specialists"…¹⁴¹

¹⁴⁰ Based on similar diagrams by A. Barbera and Th. Mathiesen.
¹⁴¹ It is probably worth quoting Litchfield's conclusion of his discussion of "Aristoxenus' equal-temperament" [Litchfield, 1988, p. 58–60]: "A close examination of Aristoxenus' theories offers no evidence to support the notion of an equal-tempered octave. It has been shown that Aristoxenus referred only to the fourth in discussing the *genera*. No attempt was made to expand this to the octave. No consonant interval was shown or implied to be tempered. Moreover, no ancient author has described Aristoxenus's ideas in such a way that they seem to indicate equal temperament. Not until the Renaissance was the false connection with equal temperament made".

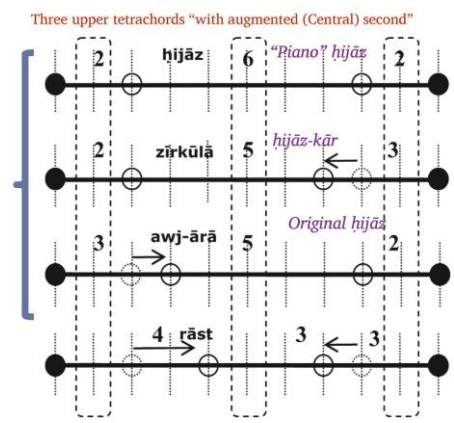

Fig. 19 The tetrachords in generic Arabian theories and the positioning of the internal notes on a schematic equal-length basis – Part I¹⁴².

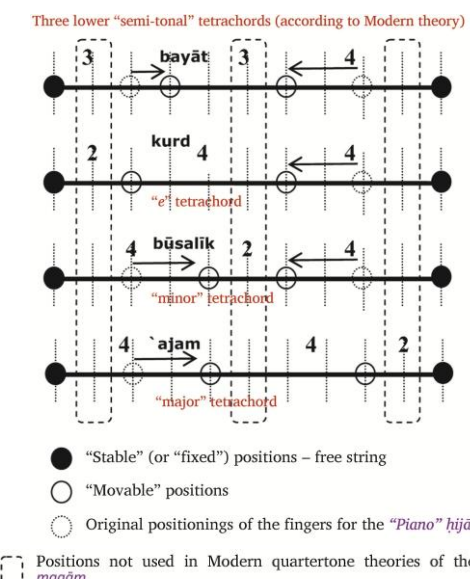

Fig. 20 The tetrachords in generic Arabian theories and the positioning of the internal notes on a schematic equal-length basis – Part II.

¹⁴² Ascending tetrachords from the left to the right; arrows show the differences between positions of the fingers (here equalized for equal intervals) on the string with the positions for the "Piano" *hijaz* tetrachord (first above) taken as a reference; digits show the numbers of quarter-tones in Modern *maqām* theory. Adapted from previous presentations and seminars, and from [Beyhom, 2005b]; names of tetrachords in black are older names found in various literature in Arabic language, with updated denominations (see for example [Beyhom, 2014a] for the various *hijaz* variants) in purple – see also FHT 7, p. 183 and listen to excerpts in Slide No. 17.

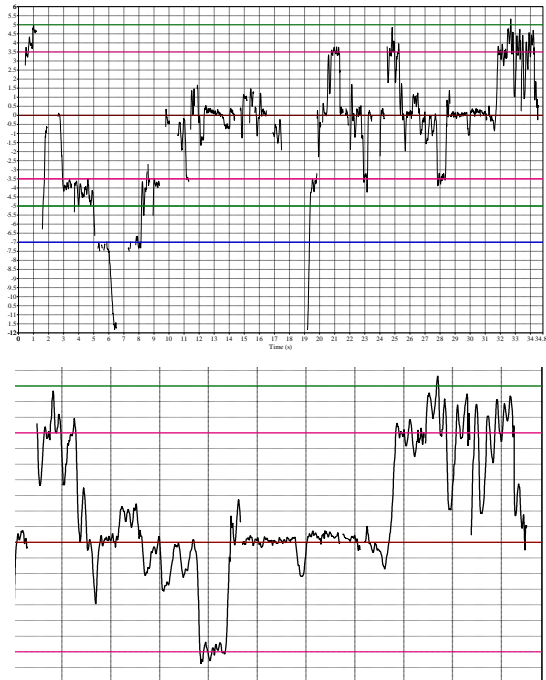

Fig. 21 Pitch analysis of the performance by Sheikh 'Ali Maḥmūd of *Yā Nasīma-ṣ-Ṣabā* (above), with the detailed analysis of the *ḥijāz jins* below¹⁴³.

ON PITCH PERCEPTION

Pitch perception is not a simple matter to analyze¹⁴⁴, and 19th-20th-centuries “musicologists” may well have been discouraged by the very small differences between Aristoxenos’ various small intervals (*dieseis*) composing the *pycnon*.

I would like to address here first the smallest differences between various positions of the “movable”

¹⁴³ Excerpt from [Maḥmūd and Shawwā (a-sh-), s.d.]; analysis by the author using *Praat* ([Boersma and Weenink, 2012], [Beyhom, 2007d], and [Miramon-Bonhoure and Beyhom, 2010] for scale analysis) – see Slides Nos. 40-41.

¹⁴⁴ Literature on the subject is so vast and numerous that I will only cite the “classics”: all books of acoustics, beginning with Sauveur’s *Rapport des sons...* [Sauveur, 1716] or Helmholtz’ *On the sensations of tone...* [Helmholtz, 1895] and (never) ending with Pierce’s *Science of Musical sound* [Pierce, 1983], discuss the subject, with physiological, psychological and other factors to have in mind whenever trying to differentiate pitches and intervals. Note also that pitch differentiation can depend on organological and musical factors such as the type of instrument played (voice, fretted or unfretted lute, wind instruments such as the *nāy*) and the technique of playing, the use of a drone or the timbre of the instrument, but also cultural and societal, whenever subtle differences in one performer’s playing are not necessarily identified by other musicians performing with him simultaneously. Our discussion here concerns, however, one single problematic: the perception of small intervals by trained, attentive ears.

SĪKĀ degree of the *maqām* scale, otherwise known as *segah*, or “*e^{half-flat}*”. The changing position of this degree, according to different theories and praxis, may place it anywhere (vertically) between *e^{flat}* and *e* natural (FHT 5, p. 182). The reader may listen to the various pitches on Slide No. 15 in the accompanying Power Point file, and carefully listen to the interval “from *e^{bf}* to *e* - 45 c.”, i.e. an interval of five cents only: the difference is clearly perceptible to trained ears¹⁴⁵. On Slide No. 39, a similar experimentation is proposed to the reader, based on the perception of the various *dieseis* of Aristoxenos’ tetrachords; listening to the sounds entitled “The upper notes of the four *dieseis* one after the other” is particularly enlightening for pitch differences perception.

In my own experience, trained ears (of music instruments makers for instance) can easily perceive differences in pitch down to 2 cents or, exceptionally, slightly less (between 1 and 2 cents). Moreover, and as Mathiesen explains above (in the quote of section “On Greek and Arabian tetrachords”), pitch perception and interval identification are two very different processes. To put it differently, small differences between intervals do not suffice to change the function of the interval within the scale, or in performance, whenever the relative sizes of intervals (for instance between the small¹⁴⁶ intervals of any “chromatic” – or *ḥijāz* – *genus* and the central, much greater, interval) play a major role in *genus* (or simply interval) identification. These intervals may vary slightly in the course of performance, with no incidence on the perception of the *genus* by trained listeners¹⁴⁷ although the latter would perceive these variations.

¹⁴⁵ This slide was shown in various seminars and papers, in which the audience all seemed to perceive the differences between various pitches; it is based on the theoretical and practical illustration of the variability of the degree *SĪKĀ* (*e*) in *maqām* music previously published by ICONEA (see FHT 6, p. 182). The limit of perception in normal hearing conditions (vibrations around 400-500 hz) can go, according to Alexander Ellis as low as 1 cent (see [Ellis, 1876, p. 9–11], notably the table of “Dr. Preyer” [p. 11] – a “mil” is a tenth of a cent); in my own experience with instrument makers and musicians (and as stated in the main text), whenever trying to tune instruments or differentiate (close) pitches, a limit of 1-2 cents is shared by most professionals of music.

¹⁴⁶ These small intervals are, in *maqām* music, used as bordering intervals of the tetrachord with a central great tone.

¹⁴⁷ Musical culture and training play a major role in this process.

ON “MOBILE, STABLE, FLUCTUANT” NOTES AND “GLISSANDI”

As for “Oriental intervals” being played *portamento*, *maqām* music, specifically, uses generally stable pitches, although fluctuant, as shown for instance on Fig. 22 and Fig. 23 (Slide No. 16) in which two successive, and very short musical phrases on the *nāy* are performed by Muhammad Musavi (Iran), with remarkably stable pitches (compare with Erguner’s performance – FHT 8, p. 183 and Slide No. 18)¹⁴⁸.

“Mobile” notes, on the other hand, are another fantasy of *maqām* and (some) Greek music “specialists”; all the notes in a *maqām* performed by a competent Arabian *ūd* player are mobile, even the tonic; the same applies to other non-tempered instruments like the *lyra* (Fikret Karakaya, Turkey – Slide No. 19).

Whenever tetrachordal (and other, trichordal, pentachordal, etc.) entities, in the context of performance, will highlight the role of “internal” mobile notes (Fig. 19, Slide No. 17), even fretted instruments like the *tār* may show small temporary variations of (the same stable) pitches due to the musician’s playing technique (for instance Malik Mansurov – Azerbaijan, Slide No. 21)¹⁴⁹.

But, above all considerations, *maqām* music, when performed by a competent traditional musician or singer, and even when accompanied by tempered instruments, is versatile and changing: such an example is provided on Slides Nos. 22 and 23 (see also FHT 11 p. 185), showing the tonometric analysis of the beginning of the song *Ḥawwīl Yā Ghannām*¹⁵⁰,

performed by Najāḥ Salām, an outstanding singer, also well trained in *maqām* religious chanting¹⁵¹.

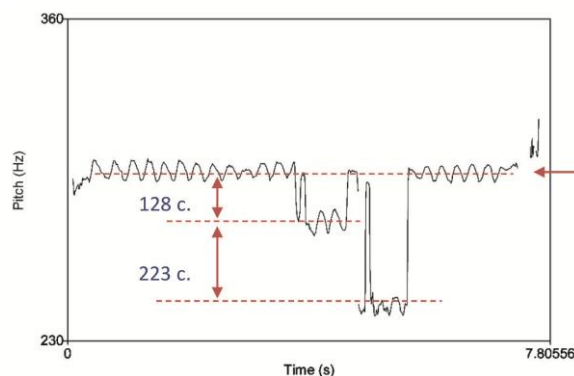

Fig. 22 Tonometric analysis of the first of two (successive) excerpts by Mohammad Musavi on the *nāy* – Tehran (IFRI - Institut Français de Recherche en Iran) 2005: Introduction to *maqām Segāh*.

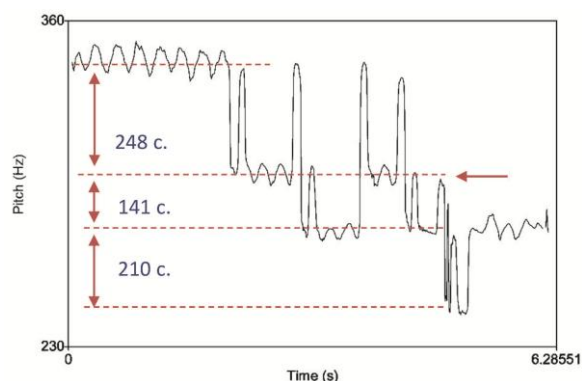

Fig. 23 Tonometric analysis of the second of two (successive) excerpts by Mohammad Musavi on the *nāy* – Tehran (IFRI - Institut Français de Recherche en Iran) 2005: Introduction to *maqām Segāh*¹⁵².

The song is theoretically in *maqām Nakrīz*, with the ascending scale, in Modern *maqām* theories in 24 quarter-tones to the octave, shown on Fig. 24 i.e. $c d e^{flat} f^{\#} g a b^{flat} C$ (shown to the left of the graphic, with Latin note names, on both slides), with a variant for b^{flat} which becomes $b^{half-flat}$ in the lower octave.

¹⁴⁸ Jean During, in a personal communication, points out the use of subtle differences in the pitch of *Segāh* which could affect the perception of the mode (firstly by the performer, and possibly secondly) by the listener, provided that the music is improvised and contains developments highlighting these changes for the audience.

¹⁴⁹ Please note that (according to Jean During) performers on the *setar* often use a left hand technique by offsetting the string (the string is strongly pressed on the neck and forced towards the bottom or the top sides of the neck) to correct an eventual “untuned” fret (generally for the central string) – see [During, 2011] for more information.

¹⁵⁰ A very popular song in Arabian countries since its first edition (in Salām’s interpretation) in the 1940s, and today still.

¹⁵¹ Her father was a religious sheikh in Lebanon, and taught her Koranic cantillation in her childhood – see [almessa-tessgilette-zemenen; Anon. 2012, *حوّل يا غنّام لنجاح سلام ضمن أهم 100 أغنية عربية*; Anon. “نجاح سلام تروي لـ المستقبل سيرتها منذ الطفولة حتى اليوم: أنا صاحبة الفضل في نشر “ [”نجاح سلام... غنت للحب وغنت للوطن“].

¹⁵² The arrows point to the tonic pitch: degrees and pitches performed by Musavi, notwithstanding the vibrato of the *nāy*, are remarkably stable, although fluctuant: the pitch of e^{fl} (e “half-flat” in modern theories, or *SĪKĀ/Segāh*) is stable throughout, whenever the pitch of the “ d ” varies. Recorded in Tehran (IFRI) 17th of January 2005, tonometric analysis with *Praat* – Slide No. 16.

then non-ditonic diatonism) in choirs, taking as an excuse the common assumption that “flimsy” voices cannot be used in choir singing, the latter being effective only when ditonic.

The biases lying at the base of such a statement are evident, and amount to (at least) two:

1. Non-ditonic singing can only be flimsy.
2. Ditonic singing is self-confident¹⁶⁰ and fits particularly choir singing.
3. Additionally, choir singing should be majestic.

The main response to such an assertion¹⁶¹ can only be a musical counter-example, which is obvious for anybody familiar with “Eastern” Byzantine chanting, namely the Byzantine choirs. Nowadays, choir singing in Byzantine churches¹⁶² is far from being ditonic, particularly, if not uniquely, majestic, definitely not “flimsy” and fully self-confident.

→
 changement essentiel, pendant les cinq siècles qui vont d’Aristoxène à Ptolémée. Il est naturel qu’un peuple dont la finesse d’oreille était proverbiale dans l’antiquité, ait cherché à utiliser des nuances, peu sensibles pour nous autres modernes”} – [Gevaert, 1875a, v. 1, p. 35]. Gevaert asserts the “ditonic” preference for Choral singing once again (and in similar terms) in [Gevaert, 1875a, v. 1, p. 295], contradicting himself a few pages further [Gevaert, 1875a, v. 1, p. 301] while excluding chromatism (not very revered by the Ancients) from choir singing, as a difference with enharmonism, of “nearly sacred character”!

¹⁶⁰ As a counter-example, Jean DURING pinpoints (personal communication) the difficulties for amateur Iranian singers to sing “in tune” in *Māhur* (a mode with a scale mostly similar to the “major” scale) whenever he noticed no such problems for *Shur* (with a scale similar to the Arabian *Bayāt* scale, *i.e.* Zalzalian). Moreover, and in my personal experience, choir singers in a Lebanese Music school, and whenever well trained in Occidental Classical singing, adapted so well their singing to Zalzalian intonations that they later had tuning problems for ditonic choir singing as their choir director (and director of the – renowned in Lebanon – school) explained (*ca* 2007). There are however (DURING – personal communication) ethnic groups in Iranian “folklore”, such as Azeris and Balutchs, who seem at ease with ditonic singing, whenever the Lurs play in a pseudo-major scale on the fiddle (*kamānche*) close to, but distinct from, *Māhur* intonations.

¹⁶¹ Which displays above all the lack of knowledge of this author, a common feature, alas, in music encyclopedias (but this would be no news for many researchers in the field).

¹⁶² Mainly in the patriarchates of Antioch (*i.e.* including Lebanon, Syria, Jordan, etc.), Jerusalem and Constantinople, Russian Byzantine choirs being (as one example) obviously not included within this consideration.

These features of Byzantine choir singing are easily explained by another major characteristic of this chant, its underlying, but omnipresent, heterophony...

* *

In my recent book on Byzantine chant¹⁶³, I made numerous tonometric (pitch) analyses of (excerpts from) Byzantine chanting to verify their conformity with theory, and tried to understand and explain the obvious differences that I eventually found between, on one side, theory and praxis and, on the other side, one cantor and the others.

To reduce the possible discrepancies, I analyzed as a first step the scales of the “eight”¹⁶⁴ modes as enunciated by four prominent choir directors and soloists of Byzantine chant in Lebanon.

The scale of the first mode, in Modern Byzantine music theory¹⁶⁵, is a *d*-based scale with lowered ascending *e* and *b*, whenever *b* is flat in the descending scale (Fig. 25), readily comparable to the scale of *maqām Bayāt*¹⁶⁶ in Arabian Modern music theories (Fig. 26).

Upon establishing the profound differences in interval measurements and singing techniques (see Slides Nos. 30-33), I decided to extract the first two notes of the scale as performed by the four cantors and compare them together (Fig. 27). The differences here seemed irremediably inconsistent as I could not, at first, imagine how such discrepancies could be reconciled in choir singing.

I subsequently decided to undertake an experiment, by transposing¹⁶⁷ first the four dual-notes to the same approximate tonic¹⁶⁸ (Fig. 28 and Slide No. 34), then

¹⁶³ [Beyhom, 2015b].

¹⁶⁴ The eight Canonical modes underwent so many variations in scale and music composition that the *Oktōēchos* must be considered as a view of the mind, at least in Modern Byzantine chant – see [Beyhom, 2015b] for more details.

¹⁶⁵ *i.e.* resulting from the Second Reform (19th century) – see Chapter 4.

¹⁶⁶ And acknowledged as thus, by the local cantors.

¹⁶⁷ With Audition, the successor of Cool Edit, a software which uses very reliable algorithms as I demonstrate in [Beyhom, 2007d].

¹⁶⁸ The transposition was made “by the senses”, *i.e.* by listening, comparing, then estimating the differences and transposing accordingly; the basis for comparison was the lowest dual-note,

→

by separating the two dual-notes for one cantor and aligning their beginning with the corresponding notes for the other cantors (approximately still – see Fig. 29 and Slide No. 34).

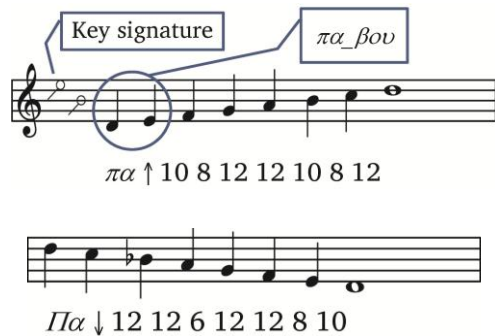

Fig. 25 Ascending and descending scales of the First mode in Byzantine chant in the theory of the Second Reform of the 19th century¹⁶⁹.



Fig. 26 Theoretical scale of *maqām Bayāt(i)* in Modern Arabian theories (in quarter-tone divisions of the scale – ♭ stands for “one-quarter-tone flat”, or “half-flat”); in (Traditional) praxis, the ascending *b* is frequently *b^{half-flat}*, or *b^b*.

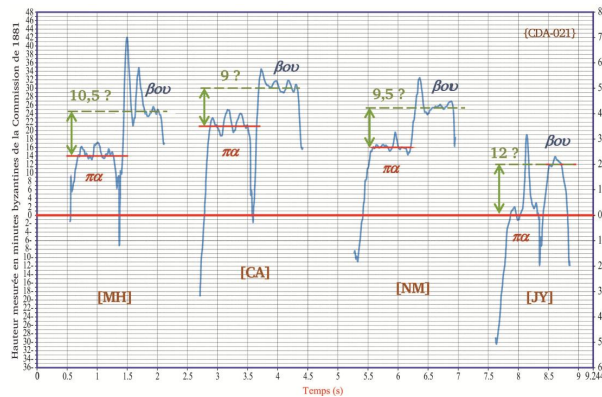

Fig. 27 Tonometric analysis of the first two notes of the scale of the First Byzantine mode, sung by four prominent choir directors and soloists in Lebanon¹⁷⁰.

sung by cantor Joseph Yazbeck (details provided in the footnote of FHT 12, p. 185).

¹⁶⁹ The key signature shows that the degrees *e* and *b* are lowered by two *minutes*, the equivalent of a sixth of a tempered tone in the Byzantine chant theory resulting from the Second Reform in the 19th century (with 72 equal *minutes* as a total in one octave, 12 in one – equal-tempered – tone); in the descending scale, *e* is equally lowered (two *minutes*) while *b* is flat – see Slide No. 27.

¹⁷⁰ See also FHT 12, p. 185, and Slides Nos. 28-31 for the animated analyses of the complete scales as sung by the four

The result was stunning¹⁷¹, with differences already beginning to fade after transpositions of the (three out of four) voices, and seamlessly integrating together as a choir after the mix.

To imitate the usual auditory conditions of Byzantine chant, I finally added a reverberation effect to the mix with the audio result proposed on Slide No. 34¹⁷².

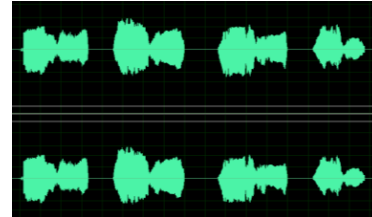

Fig. 28 The four dual notes with intervals transposed to the same (approximate) tonic¹⁷³.

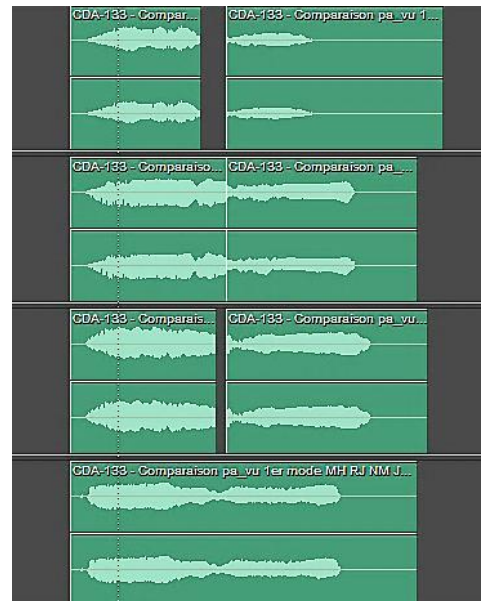

Fig. 29 Mixing of the four voices after an approximate alignment of the beginnings of the notes¹⁷⁴.

cantors, and Slides Nos. 32-33 for the animated analyses of the two notes as shown on this figure.

¹⁷¹ At least for me, and for every person that I had the chance to produce the audio file to for this experiment, including the cantors themselves and numerous participants to seminars that I delivered; as for the audio results, listen in sequence to the “Original excerpts”, then “Transposed to the same (approximate) tonic”, then “Simple mix” in Slide No. 34.

¹⁷² “Mixed in parallel [...] with ‘Cathedral’ reverberation” (effect) in Slide No. 34.

¹⁷³ After the equivalent figure in [Beyhom, 2015b, p. 420] – Slide No. 34.

¹⁷⁴ Taken from [Beyhom, 2015b, p. 421] – Slide No. 34.

Despite of objections that may be raised by classical musicology to the use of such unusual a procedure¹⁷⁵, this experiment shows how heterophony works in choir singing, and the bare existence of these Byzantine choirs with their confident, majestic singing is a clear denial of the common-place belief that this type of singing can only be undertaken on a ditonic basis, the latter statement being supported by nothing except biases about choir music and ignorance of its techniques.

In conclusion of which, I propose the following definition¹⁷⁶ of heterophony¹⁷⁷:

¹⁷⁵ For example: that ethnomusicologists are not supposed to experiment, but barely to analyze existing music and repertoires as such; I cannot concur with such a potential objection, my strong belief being that we have today at our disposal tools which allow us to go beyond, as with this “experiment”, traditional analyses of music.

¹⁷⁶ Compare with [Sachs, 1943, p.48]: “When in musical ensembles several singers or players perform the same melody, either successively or simultaneously, they actually claim the freedom of varying in minor details. Repetition of a melody seldom agrees with its first form, nor do the voices of a chorus or the parts of an accompanied song agree with each other. Each participant realizes the melodic idea according to personal taste and ability and to the special conditions of voices and instruments. Nobody minds the chance collisions that result from such discrepancies, nor is anybody concerned about their consonant, or at least pregnant, character. An agile singer would dissolve his partner’s slower third steps into faster seconds, a less-well-trained voice might replace excessively high or low notes by some bend or break, a premature need for breath would cause an unseasonable cadence among the parts. Such **heterophony is certainly a rather negative form of co-operation—neither polyphonic nor harmonic**, and seemingly anarchic. But the willful **maladjustment** often has a particular charm, and nobody who has heard the rich and colorful symphonies of Balinese and Javanese orchestras can deny that, once more, freedom is a good root of organization in art”. Whatever Sachs approach is, I would say, “compassionate” to heterophony, his worship of polyphony is tangible in this quote, as it is in the whole chapter from which it is taken (entitled “Polyphony”). It is a real wonder how prominent 20th-century musicologists such as Sachs and Schaeffner (see below) could show so clearly their disdain and lack of understanding of the essence of heterophony, while seemingly trying to rehabilitate: see Schaeffner’s chapter entitled “Variations sur deux mots: polyphonie; hétérophonie” – why should “polyphony” come before “heterophony”, I wonder? – in [Schaeffner, 1998, p. 147–175] (in fact an article for the *Revue belge de musicologie*), in which heterophony is scarcely mentioned on the first page then on four other pages, whenever polyphony and other “harmonies” and chords are mentioned between 5 and 10 mentions on each page.

¹⁷⁷ In the definition(s) below, Arabic equivalents have been added for the use of Arabian researchers. Furthermore, the term “heterophony” is not, from my point of view, the most adequate

1. Heterophony may include a group of rhythmical, intonation, temperament, or temporal references which may be formulary. This is often characteristic of modality: it is an integral part of living melodic music.
2. Heterophonic musics share some, if not all, characteristics, which together define Generalized heterophony; these principal characteristics are:
 - Restricted pitch and beat variations within melodic or rhythmical phrases either by means of spontaneous variations of intonation and register (whether consciously or unconsciously), or by fluctuations of its degrees and of the tonic – (“*localized pitch heterophony*” – تراكم مُحدّد (للارتفاعات) or of rhythmic components (“*localized beat heterophony*” – تراكم مُحدّد للأزمنة).
 - Modulations which initiate variations in the size of the intervals or of the relative or absolute position of the degrees, notably by means of tuning methods (temperament) or differences of intonation dependent either on the voice or on the instrument or the musician (“*generalized pitch heterophony*” – تراكم عام للأصوات), of regular or irregular accelerations, variations, lags or superimpositions and transformations of rhythmical elements, used as compositional means either consciously or unconsciously – (“*tempo or rhythm generalized heterophony*” – تراكم (عام للأزمنة – أو للإيقاع)¹⁷⁸.
3. Moreover, heterophony may have secondary (or additional) characteristics such as:
 - The use of a drone or of a melodic / rhythmic ostinato – (“*reference heterophony*”), a compositional means (partially or totally improvised from a pre-defined pattern) in which the musician uses variations within the formulation of the melodic phrase, of a given

→

for the description of its constitutive phenomena: while still searching for a better denomination, I am compelled to use it here as is. The Arabic equivalent that I use means “accumulation (buildup) of (the) voices”.

¹⁷⁸ Note that the accompaniment or “*supporting heterophony*” (تراكم الأصوات الموكبة) practiced in *maqām* music may use a number of methods with one or more secondary voices supporting the principal melody, by means of lagging in tempo, pitch, in variations (see “secondary characteristics”) or by reference.

scalar element (a polychord) – (“*formular or variational heterophony*”).

- A narrowing or expanding (variation) of the dimension of interval components within the scalar reference (usually a tetrachord or a pentachord – “*homothetic heterophony*”).
- A progressive evolution (evolution strata are generally smaller than the smallest structural interval in the chosen scale) in time of the reference tonic (or reference degree) which provokes a corresponding series of transpositions, fluctuations, etc., more or less homothetic (“*tonal [or ‘tonic’] heterophony*”)¹⁷⁹.

CONCLUSIONS ON GREEK THEORIES IN THEIR RESTRICTED APPLICATION BY OCCIDENTAL SCHOLARS

We have had an overview of various arguments and counter-arguments used by 19th-20th-centuries musicologists and music theoreticians, trying to substantiate the use of ditonism as the most important, if not unique, legacy of the Greeks to Europe, and the Occident. It would be however more accurate to conclude that Occidental (musical?) culture has, through this process, adapted the legacy of Greek Antiquity to its needs, distorting it when necessary.

Whenever ditonism is part of this legacy, generalized diatonism (including *zalzalism*) seems to be the norm, and not the exception. This is even more striking when it comes to *maqām* music or, Traditional European music.

The tendency to construe European¹⁸⁰ traditional music in the light of pseudo-Greek (or “Ecclesiastical”) modes is a side effect of the denial of generalized diatonism, while ditonic axioms prevent scholars from correctly understanding and analyzing this music, including in non-tempered (or unequal-tempered) traditional music of Brittany and the Limousin in

France, in Scottish and “Celtic”¹⁸¹ music as a whole, or in Bulgaria, Hungary, Slovenia, etc.¹⁸²

Whenever some timid reactions to this limited vision, coming mostly from Peripheral Europe¹⁸³, have been published in the last decades¹⁸⁴, Occidental musicology still misses the point by maintaining an artificial division between “ditonic” European traditional music and other Mediterranean musics, as if what is asked is not the truth about the nature of music, but the confirmation that the Tonal (Occidental, Classical) model remains predominant, if not undisputed.

Still, this is not the core of our current discussion, and my main focus remains on answering the following question:

¹⁸¹ Richard Dumbrill explains (Personal communication): “‘Celtic’ comes from the Greek ‘*Keltoi*’ meaning the ‘cock’ while ‘Gaul’ means the ‘cock’ in Latin. Therefore the difference between Gauls and Celts is mainly a British artificially induced difference for political reasons”.

¹⁸² Apart from a very rich literature on these subjects, these remarks come from my own experience in the field, interviews with musicians and musicologists, listening to various European recorded musics, etc. An example of the former is a discussion we had during the ICONEA Conference of 2011 (November 1, 2, 3) with Barnaby Brown (and Richard Dumbrill), about Ancient flutes he was using (see <http://www.hunter.cuny.edu/physics/faculty/lawergren/repository/files/Silver%20Pipes%20from%20Ur%20-Lawergren.pdf>, <http://pibroch.net/articles/bjb/2009-1.pdf> and watch <https://youtu.be/LvgtAHV4mzw>), agreeing that “theory” (i.e. Pythagorean theory) cannot dictate the boring of holes in Early flutes – see also [Sachs, 1936, p. 23–24] in which the author reminds the reader of the wealth of European traditional music and “the generalized leveling which, for a long time now, could and should have matched Folk singing of various [European] regions”; strangely enough, Gypsy music is completely disregarded in Sachs’ article, perhaps because it was deemed by the author too complex to be “Popular”, or “Folk”, or because of the particular position of this music in Europe, “otherized” even in Hungary (according to [Piotrowska, 2013]).

¹⁸³ i.e. not from the German-French-English (and probably Italian) core.

¹⁸⁴ See for example Rytis Ambrazevičius, “Pseudo-Greek modes in traditional music as result of misperception” (on Southern Lithuanian vocal tradition), referenced [Ambrazevičius, 2006], and Georgios Sthathis’ “An analysis...” [Sthathis, 1979] or Eustachio Makris’ “Chromatic Scales...” ([Makris, 2005] and further discussions with him on the *diphonos* of Chrysanthos Madytos – as reported in [Beyhom, 2015b]) on Byzantine chant... while possible similarities and contacts with Turkish music or others are explored in [Zannos, 1990; 1994] and [Mohafez and During].

¹⁷⁹ This definition is translated and adapted from [Beyhom, 2007c, p. 78], [Beyhom, 2015b, p. 422–423] and [Beyhom, 2015a].

¹⁸⁰ And perhaps Native American? (But I lack here both knowledge and experience on the subject...).

“After having reduced Greek music (theory and praxis) to the ditonic aspect of Greek musical culture (which is a process of legitimation of Occidental culture and music), and having claimed thus this legacy for the Occident alone, what were then the consequences with the Great European-Occidental Outburst – the colonization of most of the planet in the 19th-20th centuries – on the ‘scientific’ study of the colonized or dominated peoples, and on their own Hellenistic legacies?”.

Before I begin addressing this topic in Chapter 2, a short overview on implementations by Arabs of Greek theories in their writings on music is necessary.

Greek theories in Arabian writings

In one of his first articles on Arabian music in the early stages of Islam¹⁸⁵, the 1930 “Greek Theorists of Music in Arabic Translation”, Henry George Farmer summarizes Greek influence on Arabian theories thus:

“Following the Greeks, Pythagoras was venerated by the Arab theorists as the founder of the theory of music”¹⁸⁶.

“Euclid appears to have had two works on music attached to his name in Arabic. In the *Fihrist* and Ibn Al-Qifī these are called a *Kitāb al-nagham* and a *Kitāb al-qānūn*. The former is probably the Pseudo-Euclidian tract known as the *Εἰσαγωγή ἁρμονικῆ* attributed to Cleonidēs. The second treatise is evidently the *Κατατομὴ κανόνος*. Here an interesting point arises. It appears that in no ancient Greek codex are these works ascribed to Euclid, and, apparently, no writer earlier than Porphyry credits Euclid with the authorship of the former. The *Fihrist* shows however, that the sources of the Arabic versions must have carried Euclid’s name, or else that the translator or the author of the *Fihrist*, must have known of the Porphyry reference in one case”¹⁸⁷.

Most surprisingly, Farmer does not mention Aristoxenos as a possible reference for Arabian theoreticians, but stresses the influence of Euclidēs and Ptolemaos¹⁸⁸ and, exceptionally for Fārābī, Themistios¹⁸⁹.

¹⁸⁵ The culture: I refer mainly to the Muslim religion as “islam”, with a non-capitalized initial “I”.

¹⁸⁶ [Farmer, 1930b, p. 325].

¹⁸⁷ [Farmer, 1930b, p. 327].

¹⁸⁸ Villoteau, in the footnote of his *De l’Art musical en Égypte* [Villoteau, 1809, p. 10(-11)], thought that Arabian philosophers were influenced by Ptolemaos to such an extent that their music springs from his treatise: “Ptolemaos composed his *Harmonics* in

Here, it should be underlined here that, despite¹⁹⁰ Farmer’s shortcomings¹⁹¹ and biases¹⁹² in his prolific “scientific” production about Arabian music, his writings have become a reference for all researchers on *maqām* music, and have greatly contributed in spreading errors and misinterpretations, notably about Arabian music history and theoretical system(s).

* * *

→
imitation of Aristoxenos; as he was born in Pelusium in Egypt, at the outer reaches of Arabia, his writings were necessarily known to the Arabs and served as a model for the treatises they composed on music. His system was the type the Arabs adopted; the affinity between the two systems eliminate the last shadow of a doubt” (in French: “Ptolémée, à l’imitation d’Aristoxène, composa son traité des *Harmoniques*; et comme il était natif de Péluse, en Égypte, sur les confins de l’Arabie, ses ouvrages furent nécessairement connus des Arabes, et servirent de modèle aux traités que ceux-ci composèrent sur la musique. Ainsi son système fut le type de celui que les Arabes ont adopté; l’affinité qui existe entre l’un et l’autre système, fait disparaître jusqu’à l’ombre du doute”); Ptolemaos’ influence remains however a conjecture concerning early Arabian theoreticians, as we may conclude from Farmer’s hypothesis in the footnote below; furthermore Arabian theoreticians, whenever adapting Greek theories for centuries, did not impact praxis directly before the “Systematist school” (beginning with Urmawī in the 13th century): this was however a very long process (see for example [Olley, 2012], and more generally [Feldman, 1996]) which accelerates (with the growing European influence) in the 19th-20th centuries, and culminates in the 21st century (see [Beyhom, 2018] – to be published).

¹⁸⁹ [Farmer, 1930b, p. 328]: “Ptolemy, although ignored as a musical theorist in the *Fihrist*, and by Ibn al-Qifī and Ibn Abī Usaibī’a, is mentioned by Ibn ‘Abd Rabbīhi (d. 940), al-Mas‘ūdī (d. ca. 956), and the Ikhwān a-ṣ-Ṣafā’ (10th cent.)”; [Farmer, 1930b, p. 329]: “al-Kindī (d. ca. 874) openly acknowledged that he followed the ‘Ancients’ i.e. the Greeks, in the speculative theory of music [...] He was evidently [p. 330] acquainted with Euclid and apparently with Ptolemy [...] al-Fārābī (d. ca. 950) depended on sources that were clearly different from those consulted by al-Kindī. Indeed, al-Fārābī wrote his famous *Kitāb al-mūsīqī al-kabīr* because he was dissatisfied with what had been handed down from the Greek theorists in Arabic translation. He found lacunae as well as obscurities in the latter, and as he thought too much of the ‘Ancients’ to blame them for these shortcomings, he attributed the blemishes to the copyists. Al-Fārābī’s chief authorities were Euclid, Ptolemy, and Themistius”.

¹⁹⁰ Or because of...

¹⁹¹ Notably in his understanding of Arabic and Persian languages – see [Bouterse, 1979; Farmer, 1939] and [Beyhom and Makhlof, 2009; 2010c].

¹⁹² I address some of these in the next chapter.

THE ‘*ūd* AS THE “MONOCHORD” OF THE EARLY AND MIDDLE ISLAMIC THEORETICIANS¹⁹³

Most, if not all¹⁹⁴, Early Islamic speculations on music theory used the *ūd* as the main vector for their explanations. In turn, as inheritors of the Greek tradition through the translation enterprise set by the Caliph al-Manṣūr in the 9th century, Arabian philosophers and theoreticians adapted Greek theories for this instrument (notably used as a “poly-chord” – as compared to a “monochord” – with strings tuned in successive fourths), which became thus the main vector of *Maqām* genus theory.



Fig. 30 Bear playing on a lute: detail from a fresco of the Umayyad Period in Qusayr ‘Amrā, 7th-8th centuries¹⁹⁵.

¹⁹³ The main references for this section are [Beyhom, 2010c; Beyhom and Makhoulouf, 2009].

¹⁹⁴ See section “Re-Orientalism” in Chapter V of this dossier for the use of the *tunbūr* by Early *maqām* theoreticians in theoretical demonstrations.

¹⁹⁵ “Lautenspielerdarstellung in den Fresken des umayyadischen ‘Wüstenschlosses’ Quseir ‘Amra (‘restaurierte’ Fassung mit Hervorhebung des lautenspielenden Bären, von A. Brunn)”, as commented in http://www.archaeologie-online.de/magazin/thema/musik/archaeologie/koptische_lauten, accessed and downloaded 23/02/2008.

Theoreticians of Early Islam (8th-9th centuries) till the 13th century¹⁹⁶ used three main procedures for the divisions of tetrachords, namely:

1. The classical Pythagorean ditonic division, in ascending and descending directions (FHT 13, p. 186).
2. Equal-divisions in 12, 24, equal segments of the string (applied to the first third of the string, *i.e.* including the Just Fifth – see FHT 14 p. 186), or between two specific positions on the neck of the instrument (see FHT 17 p. 188 for a mixed example).
3. The “Harmonic” division, or using selected superparticular ratios to divide the fourth beginning with the open side of the strings (the “nut” – FHT 15 p. 187 and FHT 29 p. 195).

However, and from the very beginning of those attempts to apply Greek theories to the music of the peoples included in the Arabian caliphate then, those theories seemed a little bit too... theoretical.

The first Arabian theoretician to explain explicitly the tetrachordal divisions on the fingerboard, the “Philosopher of the Arabs” Abū Yūsuf Ya‘qūb Ibn Ishāq al-Kindī¹⁹⁷, used alternatively an ascending Pythagorean (ditonic) division and a “Harmonic” division of the tetrachords, both divisions failing to reproduce the praxis in his days.

¹⁹⁶ Mainly philosophers: a musician such as ibn a-ṭ-Ṭaḥḥān (11th century) did not even find it necessary (or useful) to describe a precise mesh of the fingerboard of the *ūd*, and simply named the “ties” in succession (see [Beyhom, 2010c, v. 1, p. 504–505]); later still, and since the 13th-century theory of Ṣafiyīy-a-d-Dīn al-Urmawī expounded in his *Kitāb al-Adwār* [Urmawī (d. 1294), 1980; Urmawī (d. 1294), 1984; Urmawī (d. 1294), 2001], meshings of the fingerboard (from the so-called Systematist school) became mainly Pythagorean, and mostly duplicating Urmawī’s; note, however, that the latter, in a later work (*a-sh-Sharafiyya* [Qrī‘a (Kriaa), 2009; Urmawī (d. 1294), 1982; Urmawī (d. 1294), 2005; Urmawī (d. 1294) and [Jurjānī (al-), 1938; Urmawī (d. 1294) and [Jurjānī (al-), 2001]), uses also a mixed procedure (Pythagorean + equal-division of the strings).

¹⁹⁷ “Abū Yūsuf Ya‘qūb ibn Ishāq Al-Kindī (ca. 800–870 CE) was the first self-identified philosopher in the Arabic tradition [and probably one of the “copyists” blamed by Fārābī for their shortcomings (see footnote 189)]. He worked with a group of translators who rendered works of Aristotle, the Neoplatonists, and Greek mathematicians and scientists into Arabic. Al-Kindī’s own treatises, many of them epistles addressed to members of the caliphal family, depended heavily on these translations” – in [Adamson, 2011].

He was therefore compelled to add approximate descriptions for the positioning of the fingers on the fingerboard to the latter division (“Harmonic”) in order to complete his depiction (compare FHT 15, p. 187 with FHT 29 p. 195).

This clear discrepancy between theory and praxis led subsequent theoreticians to use mixed procedures in order to approximate practical performance, which led to somewhat complex meshings of the fingerboard (see Fārābī’s division in FHT 17, p. 188)¹⁹⁸.

Ptolemaeus			
numerator	9	10	11
denominator	10	11	12
value in cents	182	165	151
Total =	498		

Fig. 31 Ptolemaos’ “equal-diatonic” tetrachord, part of the superparticular progression, was well-known to Arabian (Persian, and other) theoreticians of the Golden Age of Islam.

SHORT CONCLUSION ON GREEK THEORIES IN ARABIAN THOUGHT

Later (still) theoreticians of *maqām* music used either of the procedures explained above, always swinging between pure theoretical formulations and compromises with music praxis.

I have however personally not found so far, in the whole *maqām* literature¹⁹⁹ of the pre-19th-century period, a clear understanding of the difference between theory and praxis²⁰⁰, and of the role of theory in music, *i.e.* setting guidelines for the sake of making praxis easier²⁰¹.

¹⁹⁸ Other main applications of Greek music theories in the Golden Age of Islam are (Ibn) Sinā’s divisions of the tetrachord, and later Ṣafīyy-a-d-Dīn al-Urmawī’s Homogeneous and Integral Pythagorean division of the *ūd*’s fingerboard and of the octave. The latter division became a prototype for what came to be called (see footnote 196) the “Systematist school” by Western music theoreticians.

¹⁹⁹ Written by local theoreticians.

²⁰⁰ As understood and enunciated by Aristoxenos, according to Mathiesen’s quote above.

²⁰¹ Although philosophers like Fārābī did stress, for all matters concerning “the Art” (practical and technical details), on the superiority of the instrumentalist over the theoretician.

On the other side, theoreticians did try to adapt the existing theories to the reality of music performance, notably for Aristoxenos’ *genera* which were expounded, and further developed, by Fārābī (see Fig. 32 and Appendix 3)²⁰².

All in all, Greek theories were an integral part of Arabian thought in the Golden Age of Islam, and went through a series of modification, adaptations and developments, either theoretical or practical, which compose a substantial, distinct, corpus, difficult for Occidental musicologists to ignore...

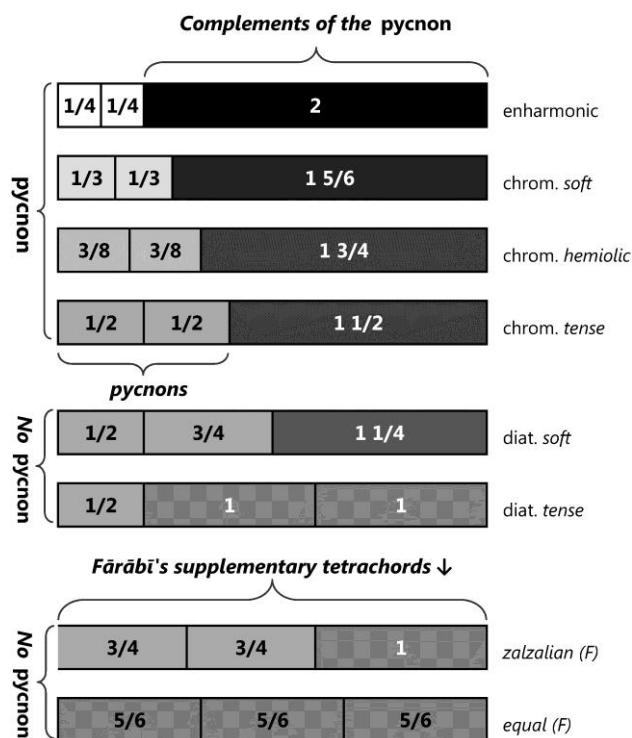

Fig. 32 The typical *genera* of Aristoxenos with Fārābī’s additions (intervals values in fractions of the equal-tempered tone) – see also FHT 45 sq.

**

²⁰² Which shows that Aristoxenian theories were known to Arabian writers, either directly or through later writings expounding his theories (Cleonidēs for example), notwithstanding Farmer’s shortcomings in mentioning Aristoxenos as a possible, if not probable reference for Fārābī and others. Please note here that Fārābī, for instance, discusses other points of Aristoxenos’ theories as I explain in [Beyhom, 2010c].

2. MUSIC HISTORY (OR “THE HISTORY OF MUSIC[S]”) IN THE 19TH-20TH CENTURIES

“We would not like being treated thus by those, whom we call Barbarians; and if Barbary exists in us, it consists in our fear to see other people reason the way we do. [...] With such a pure language, stylish clothing, refined morality, fine laws and white faces we remain Barbarians in the eyes of some”
[La Bruyère, *Caractères*]²⁰³

“[F]or forty thousand years music has been in existence and developing without interruption to become what it is today”
[Jacques Chailley, *40,000 Years of Music*]²⁰⁴

When looking at World history of the last two centuries, I have always wondered where the Age of Enlightenment has gone. However, and if History be considered as linear, it would be normal that this age had a beginning, a Golden period, then an end...

Whereas (some?) recent Music history books still ignore the bare existence of any music other than Occidental²⁰⁵, the growing contacts between

“Westerners” and “Easterners” or “Southerners” made the inclusion of those “Near” and “Middle”, when not “Far”, Easts more and more indispensable if the Occident was to construct a coherent image of the history of the world, a world which was to become its dominion, or which at least would soon stand in its sphere of influence.

*How the West saw the East before (near-) World domination*²⁰⁶

The relation between East and West has never been easy, although the understanding of what is East and what is West is even, sometimes, more difficult to apprehend.

In my search for sources on East-West relations, I noticed that, with the end of World War II and the beginning of de-colonization, the reflection on how the West interacted (or reacted), and would be further interacting, with what was becoming the former colonies was beginning to fall into place.

It was thus for me fortuitous to find, besides classical references as Abu-Lughod’s *Arab rediscovery of Europe*²⁰⁷ and Abdel-Malek’s “Orientalism in crisis”²⁰⁸, a most interesting article²⁰⁹ by Ignacy Sachs²¹⁰ which summarizes, it seems to me, very efficiently the Western view of the East²¹¹ in the period preceding the 19th century. Here follow some excerpts, notably...

²⁰⁶ Or:

“OH, East is East, and West is West, and never the twain shall meet,
Till Earth and Sky stand presently at God’s great Judgment Seat;
But there is neither East nor West, Border, nor Breed, nor Birth,
When two strong men stand face to face, tho’ they come from the ends of the earth!”

Rudyard Kipling, *The Ballad of East and West* (verses 1 to 4).

²⁰⁷ [Abu-Lughod, 1963], reprinted as [Lughod and Khalidi, 2011].

²⁰⁸ [Abdel-Malek, 1963a].

²⁰⁹ Entitled “From Medieval times to today: Europeocentrism and discovery of the Third World” (in French: “Du Moyen Âge à nos jours : européo-centrisme et découverte du Tiers Monde”) – [Sachs, 1966].

²¹⁰ The author’s most interesting book on the same subject, *The Discovery of the Third World* [Sachs, 1976] (originally in French as [Sachs, 1971]), is clearly worth noting (see also [Taylor, 1978]); I know not however of an English translation of the 1966 article, which is an additional reason for quoting it in this dossier.

²¹¹ For an idea on Arabs’ views of the West, see, apart from aforementioned Lughod and E. Said’s *Orientalism* (details in Appendix 7), [Gabrieli, 1977] for the Crusades, and the quotes from B. Lewis’ book (and others) in the Foreword of Appendix 7.

²⁰³ Translated from [Bruyère, Theophrastus, and Schweighaeuser, 1847, p. 285], with the following extended quote (in French): “Si les ambassadeurs des princes étrangers étaient des singes instruits à marcher sur leurs pieds de derrière, et à se faire entendre par interprète, nous ne pourrions pas marquer un plus grand étonnement que celui que nous donnons la justesse de leurs réponses, et le bon sens qui paraît quelquefois dans leurs discours. La prévention du pays, jointe à l’orgueil de la nation, nous fait oublier que la raison est de tous les climats, et que l’on pense juste partout où il y a des hommes. Nous n’aimerions pas à être traités ainsi de ceux que nous appelons barbares; et s’il y a en nous quelque barbarie, elle consiste à être épouvantés de voir d’autres peuples raisonner comme nous [...] Avec un langage si pur, une si grande recherche dans nos habits, des mœurs si cultivées, de si belles lois et un visage blanc, nous sommes barbares pour quelques peuples”.

²⁰⁴ [Chailley, 1964], quoted in [Solie, 1982, p. 300].

²⁰⁵ See for example [Beltrando-Patier, 1998] whose generic title (“Music history”) infers a global history of music, whenever addressing for over 1200 pages Occidental music exclusively (beginning here with the Middle Ages, which allows avoiding the dazzling Greek-Roman period and skipping the uncomfortable Byzantine and Arabian eras, not to mention extra-European and extra-Mediterranean realms). Bohlman explains that with the replacement of comparative musicology by ethnomusicology, the studies of what was called before “foreign music” were taken over by the latter, resulting in a separation of the two disciplinary fields (which did not go without discussion – see the quote in the last section of this chapter and footnote 56 in [Bohlman, 1987, p. 162]).

➤ about the opposition between Greeks and Barbarians:

“Grousset²¹², Chabod²¹³ and more recently Baudet²¹⁴ place the beginning of Europeocentrism in the antinomy Greeks-Barbarians [...] Besides that, a theory was elaborated on the basis of a few remarks by Herodotus and some pages of Aristotle²¹⁵ which, putting aside the cultural links between the Mediterranean civilization and the civilizations of Asia Minor, pretended to oppose the Democratic genius of European populations to the natural tendency to submit to the despotism which characterizes Asians. However, the geographical bases of these pre-European cultures did not coincide with what was to become Europe. Tacitus, for example, evaluated living conditions in the Germanic world as being too harsh for Asians, Africans or Romans²¹⁶. And *Heart of Darkness*²¹⁷, by J. Conrad, begins with an astounding reconstruction of the anguish instilled in Roman Legionnaires by the thick forests in the surroundings of London”²¹⁸,

➤ the emergence of the religious aspects:

“In the Middle Ages²¹⁹, the Civilized-Barbarian antinomy took up a religious dimension: it opposed Christendom to the infidels, noticeably Muslims but also, to a lesser extent, the Occident and Byzantium. [...] A certain historiography, inspired by Catholicism[,] [...] endeavored to prove that,

²¹² Citing “R. Grousset, *Bilan de l'histoire*, Paris, 1962”.

²¹³ Citing “F. Chabod, *Storia dell'idea d'Europa*, Bari, 1964”.

²¹⁴ Citing “H. Baudet, *Paradise on Earth. Some Thoughts on European Images of Non-European Man*, London, 1965”.

²¹⁵ Citing “Aristote, *Politique*, Book III, 1285”.

²¹⁶ Citing “Tacitus, *De Germania*”.

²¹⁷ Conrad's well-known novella (first published 1899) did not need an introduction (or a reference) by the author; for readers not familiarized with it, see the first pages of [Conrad, 2012] (see also, for the controversy raised by the novella and its influence on Francis Ford Coppola's *Apocalypse Now*, [Anon. “*Heart of Darkness*”, 2016]).

²¹⁸ [Sachs, 1966, p.467–468]: “Grousset, Chabod et plus récemment Baudet voient dans l'antinomie Grecs-Barbares le point de départ de l'euro-péo-centrisme [...] On avait d'autre part élaboré, à partir de quelques remarques d'Hérodote et de quelques pages d'Aristote, une théorie qui, négligeant les liens culturels existant entre les civilisations de la Méditerranée et de l'Asie Mineure, prétendait opposer le génie démocratique des peuples européens à la tendance naturelle à se soumettre au despotisme qui aurait caractérisé les asiatiques. Cependant, les bases géographiques de ces cultures pré-européennes ne coïncidaient pas avec ce qui sera plus tard l'Europe. Tacite, par exemple, estimait que la vie dans le monde germanique était trop sévère pour attirer des Asiatiques, des Africains ou des Romains. Et *Heart of Darkness*, de J. Conrad, débute par une étonnante reconstruction de l'angoisse que devaient inspirer aux légionnaires romains les épaisses forêts des alentours de Londres”.

²¹⁹ See footnote 79, p. 61, about the denomination of this time period.

since the Middle Ages, European awareness began to form on the triple basis of the Greco-Latin tradition, Christianity and the Imperial concept. But such interpretations are contested [...]. The 13th century was not only the century of cathedrals; it was also the century of the rebirth of secularism. [...] J. le Goff opposes²²⁰, to the mirage of a society marked by the splendor of the cathedrals, the image of a world continuously on the brink of starvation and dominated by fear and anguish. In this Medieval Occident, [...] the legendary splendor and material culture of the Orient are admired and coveted, but in the same time Gothic hell was populated with monsters from Oriental Asia, [...] while] scarce traveller's relations nourished legends about the fantastic fauns and semi-human monsters in India or Ethiopia^{221 »222},

➤ the discovery of America and the emergence of colonialism (and the changing status of non-European nations and peoples until the 18th century):

“But these [two] attitudes are more latent than clearly expressed and it is only in the 16th century, after the discovery of America, that Europe finally experienced the need to define itself *vis-à-vis* the previously unseen [unsuspected] worlds that were then brutally uncovered. [...] Admiration and dread yield to lust and the feeling of superiority, leading in turn to brutal and heroic dreams. At the same time, the contact with hitherto unknown civilizations generates new reflections amongst Humanists. The theme of the Noble savage emerges in the thought of Europeans and make them discover the relativism of cultures²²³. Two conflicting theories begin to

²²⁰ In “J. le Goff, *La Civilisation de l'Occident médiéval*, Paris, 1964”.

²²¹ Which is not far from Umberto Eco's view in *The Name of the Rose*, set by the author in 14th-century North-Italy.

²²² [Sachs, 1966, p.468–469]: “Au Moyen Âge l'antinomie civilisé-barbare prend une dimension religieuse : elle oppose la chrétienté aux infidèles, plus particulièrement aux musulmans et aussi, mais avec beaucoup moins de force, l'Occident et Byzance. [...] Une certaine historiographie d'inspiration catholique[,] [...] s'attache à démontrer que dès le Moyen Âge une conscience européenne avait commencé à se former sur la triple base de la tradition gréco-latine, du christianisme et de l'idée impériale. [...] Le XIII^e siècle n'a pas seulement été le siècle des cathédrales, il a été aussi celui d'une renaissance de conceptions laïques. [...] J. le Goff oppose, au mirage d'une société marquée par la splendeur des cathédrales, l'image d'un monde toujours aux limites de la famine et qui est dominé par la peur et l'angoisse. Dans cet Occident médiéval [...], [o]n admire et on convoite la culture matérielle et le faste légendaire de l'Orient, mais en même temps on peuple l'enfer gothique de monstres d'Asie orientale [...] cependant que les rares récits des voyageurs [...] nourrissent les légendes sur les faunes fantasmagoriques et les monstres à demi-humains qu'on situe aux Indes ou en Éthiopie”.

²²³ This emergence does not seem to have had a noticeable effect on “exotic” European music of the 18th century: “The emergence of the ‘noble savage’ as a symbol of rebellion against the growing sophistication of the ruling court circles brought little or no

take shape. [...] The Philosophers of the 18th century understood perfectly that the discovery of the Americas resulted in ‘joining Asia and Africa to Europe’. [...] Meanwhile, and despite the Turkish attacks on Austria, the military superiority of the Europeans strengthens: the times during which the Portuguese fought Africans with spears has long gone²²⁴,²²⁵

➤ and, finally, with the discourse of Power:

“At the same time he affirms the premise of Universal history, Voltaire remains convinced of the progress accomplished in Europe since the Middle Ages and of the superiority of the Europeans on peoples which were discovered, conquered and colonized by them: ‘In all matters, our occidental peoples have overblown their spiritual and fearless superiority over Oriental nations. We became established in their houses, and very often against their resistance. We have learned their languages, we have taught them some of our arts [crafts]’²²⁶. This feeling of superiority went hand in hand, for many thinkers of the Age of Enlightenment, with a clear notion of the unity of Europe[:] ‘ein bewunderwürdiges Ganze’ says Adlung²²⁷. Gibbon formulates a current notion of his times when he considers Europe ‘as a great republic, whose inhabitants have attained almost the same level of politeness and cultivation’²²⁸. This Europe, he judges, fears no more a

Tatar invasion because Barbarians are now hindered by the impassable fortifications and the canon²²⁹/²³⁰.

The stage was thus set, on the brink of the 19th century, for a new history of the New and the Old worlds, for us in this dossier in respect of music...

*The clash of cultures*²³¹

Berlioz’ (1803-1869) alleged reaction to Chinese music, in which he states that the Chinese people

“have a music which we find abominable, excruciating, [they] sing like dogs yawn, or like cats when they have swallowed a fishbone”,

frequently quoted out of context²³², would greatly gain by being read in its entirety, as the French composer

²²⁹ Such a discourse of “fear and power” is not the privilege of 18th (or 19th) century intellectuals, as is clearly shown by Bernard Lewis’ opening statements for his *History of the Middle East* (see the beginning of Appendix 7). As a further note on this matter: it seems that the only concern that the Europeans should have had in the 18th century was about themselves (meaning here the French Revolutionary Wars and the Napoleonic Wars; not forgetting to mention also two world wars in the 20th century...).

²³⁰ [Sachs, 1966, p. 476–477]: “[...] en même temps qu’il postule une histoire universelle, Voltaire reste convaincu des progrès accomplis en Europe depuis le Moyen Âge et de la supériorité des Européens sur les peuples découverts, conquis et colonisés : ‘Nos peuples occidentaux ont fait éclater dans toutes ces découvertes une grande supériorité d’esprit et de courage sur les nations orientales. Nous nous sommes établis chez elles, et très souvent malgré leur résistance. Nous avons appris leurs langues, nous leur avons enseigné quelques-uns de nos arts’. Ce sentiment de supériorité s’accompagne chez beaucoup de penseurs du siècle des Lumières d’une claire notion de l’unité de l’Europe ‘ein bewunderwürdiges Ganze’ dit Adlung. Gibbon exprime une idée courante à son époque lorsqu’il considère l’Europe ‘as a great republic, whose various inhabitants have attained almost the same level of politeness and cultivation’. Cette Europe, estime-t-il, n’a plus à craindre une invasion tatar parce que le canon et les fortifications opposent désormais un obstacle infranchissable aux barbares”.

²³¹ The main references for the following sections of this chapter are the two Philip Bohlman articles [Bohlman, 1987 ; 1988].

²³² By, for instance, André Schaeffner in [Schaeffner, 1994, p. 309], who also cites the same passage (without quoting it) in [Schaeffner, 1998, p. 39]. Another passage from Berlioz proposed by Schaeffner is also interesting: “I conclude that the Chinese and the Indians would have had music comparable to ours, *if only they had one*; but they are still in this regard immersed deep in the darkness of barbarity and in childish ignorance in which one can barely detect some vague and helpless instincts; moreover, Orientals call *music* what we name *racket* [*charivar*], and for them as for the witches of Macbeth, *Foul is Fair*” – (in French: “Je conclus pour finir, que les Chinois et les Indiens auraient une musique semblable à la nôtre, *s’ils en avaient une*; mais qu’ils sont

→ change in [exotic] operatic practice. But the wave of anthropological and sociological activity generated by the Enlightenment did produce several publications which contained also welcome samples of non-European music” – in [Ringer, 1965, p. 115].

²²⁴ Citing “Montesquieu, *L’Esprit des lois*, XXI, 21 (éd. Garnier), Paris, 1922, vol. II, p. 37”.

²²⁵ [Sachs, 1966, p. 470 sq.]: “Mais ces attitudes sont plus latentes que manifestes et c’est seulement au XVI^e siècle, après la découverte de l’Amérique, que l’Europe éprouvera vraiment le besoin de se définir par rapport aux univers insoupçonnés dont on a alors la révélation brutale. [...] L’admiration et l’effroi cèdent à la convoitise et au sentiment de supériorité, qui font naître des rêves brutaux et héroïques. En même temps, le contact avec les civilisations jusque-là ignorées suscite de nouvelles réflexions parmi les humanistes. Le thème du bon sauvage apparaît dans la pensée des Européens et leur fait découvrir le relativisme des cultures. Deux théories opposées commencent à se dessiner. [...] Les philosophes du XVIII^e siècle avaient parfaitement compris que la découverte de l’Amérique avait eu pour effet de ‘relier à l’Europe, l’Asie et l’Afrique’. [...] Par ailleurs, malgré les offensives que les Turcs poussent jusqu’en Autriche, la supériorité militaire de l’Europe s’affirme : le temps où les Portugais affrontaient les Africains à la lance est à jamais révolu”.

²²⁶ Citing “Voltaire, *Essai sur les moeurs*, CXLIII, t. II, p. 325”.

²²⁷ Citing “J. Ch. Adlung, *Pragmatische Staatsgeschichte Europens*, Gotha, 1762, cité par Paul Hazard, *La Pensée Européenne au XVIII^e siècle: de Montesquieu à Lessing*. Paris, 1946”.

²²⁸ Citing “E. Gibbon, *Decline and Fall of the Roman Empire*, IV, London, 1921, p. 163”.

was in fact somewhat appreciative of the respect of the Chinese for their own music²³³.

Not appreciating Chinese (or other non-European) music seemed however a trait shared by many musicians or historians of music including Burney with a remark in his *General History of Music* which is typical in opposing “one-fourth of the globe” to the remaining population²³⁴:

“Music being the object of a sense common to all mankind, if genius alone could invent and bring it to perfection, why is China, which has been so long civilized, still without great composers and performers? And why are the inhabitants of three-fourths of the globe still content, and even delighted with attempts at such music as Europeans would qualify with no better title than noise and jargon?”²³⁵.

Burney did clearly consider no music other than European classical music as worthy of appreciation²³⁶,

→

encore à cet égard plongés dans les ténèbres les plus profondes de la barbarie et dans une ignorance enfantine où se décèlent à peine quelques vagues et impuissants instincts; que, de plus, les Orientaux appellent *musique* ce que nous nommons *charivari*, et que pour eux, comme pour les sorcières de Macbeth, *l’horrible est le beau*”).

²³³ Here is the complete quote in French: “Pourtant il a du bon, le peuple chinois, beaucoup de bon, et ce n’est pas tout à fait sans raison qu’il nous appelle, nous autres Européens, les diables rouges, les barbares. [...] Il a une musique que nous trouvons abominable, atroce, il chante comme les chiens bâillent, comme les chats vomissent quand ils ont avalé une arête; les instruments dont il se sert pour accompagner les voix nous semblent de véritables instruments de torture. Mais il respecte au moins sa musique, telle quelle, il protège les œuvres remarquables que le génie chinois a produites; tandis que nous n’avons pas plus de protection pour nos chefs-d’œuvre que d’horreur pour les monstruosité, et que chez nous le beau et l’horrible sont également abandonnés à l’indifférence publique” – [Berlioz, 1862, p. 252–253].

²³⁴ Jean-Paul Sartre pinpoints the expression as a common place in his time, as reported by Ignacy Sachs [1966, p.467]: “The World population was composed, till recently, of one-fourth Humans and three-fourths indigenous. ‘The first disposed of the Word, the others borrowed it’” (the complete quote in French is slightly different: “Il n’y a pas si longtemps, la terre comptait deux milliards d’habitants, soit cinq cents millions d’hommes et un milliard cinq cents millions d’indigènes. Les premiers disposaient du Verbe, les autres l’empruntaient” – Jean-Paul Sartre, Preface to *Les damnés de la Terre* [Fanon, 2011, p. 17]).

²³⁵ [Burney, 1789, v. 1, p.703]; the quote is taken from [Bohlman, 1987, p. 147].

²³⁶ And this continued for a while: “Harmony is ‘music’ in the absolute sense of the term... Melody is, on the contrary, the most elementary musical artifice of mankind... monody invariably represents an ingenuous conception of music, being preferred by primitive peoples and by the least civilized, most vulgar and

→

a judgment which applies even to Ancient Greek music and its subtleties as may be inferred from the following quote:

“The ancients attributed peculiar effects to each *genus*, and speak of many characteristic distinctions of *genera*, which now appear to be wholly fanciful and imaginary. These, if they ever had existence, were, perhaps, destroyed by modern harmony”²³⁷.

CONTENTS of the HISTORY, beginning	P. 195.
Of EGYPTIAN Music,	P. 198.
Of HEBREW Music,	P. 217.
Of GREEK Music.	
CHAP.	
I. Of Music in Greece during the Residence of Pagan Divinities of the first Order upon Earth,	P. 253.
	II. Of
II. Of the Terrestrial, or DEMI-GODS,	P. 301.
III. Concerning the Music of HEROES and Heroic Times,	P. 311.
IV. Of the Music of Greece from the Time of HOMER, till that Country was subdued by the Romans, including the Musical Contests at the PUBLIC GAMES,	P. 357. OLYMPIC, 370. PYTHIC, 380. NEMEAN, 403. ISTHMIAN, 412. PANATHENÆAN Games, 414.
V. Of ancient MUSICAL SECTS, and Theories of Sound,	P. 439.
VI. Of the SCOLIA, or SONGS, of the ancient Greeks,	P. 464.
Of the Music of the ROMANS,	P. 473.
Additional Notes.	P. 497.
Reflections upon the Construction and Use of some particular Musical Instruments of Antiquity,	P. 508.
A List and Description of the Plates,	P. 517.

Fig. 33 Excerpts from the Contents of Burney’s *General History of Music*²³⁸.

Whereas this hypothesis may well be a valid explanation for the evolution of most European traditional music until equal (semi-tonal) temperament became generalized²³⁹, Philip Bohlman comments Burney’s *History*:

→

ignorant section of more advanced humanity – Alfredo Casella, *The Evolution of Music*” [1924, p. xix–xx], quoted in [Solie, 1982, p. 297] which adds: “Developmental history was dominant for a long time, and has not disappeared by any means even today”.

²³⁷ [Burney and Mercer, 1935, v. 1, p. 42].

²³⁸ [Burney, 1776, not numbered – last two pages before p. 1].

²³⁹ A process which has begun in the 17th century and was (almost) completed in the 19th-20th centuries {see [Lindley, 2001a; 2001b]; literature on temperaments is so abundant that the reader will easily find suitable readings on the subject, including (Curt) Sachs’ seemingly hasty assertion in [Sachs, 1943, p. 213] that “after 1700, equal temperament was generally adopted”, contradicted by the above cited references and by, for instance, [Lloyd, 1939; 1940]}.

“Statements alluding to that music now generally called non-Western issued only rarely from Burney’s pen, even in a work that turned considerable attention to other ‘barbarous times and more barbarous Music.’²⁴⁰ Yet in their paucity and contempt Burney’s queries stand in dramatic contrast to the attitudes espoused by the compilers of music history in the subsequent century, who instead recognized in non-Western music a means of extending the history of music far beyond the temporal and cultural bounds imposed by eighteenth-century music historians, indeed equating the inception of music history with the very origins of music at a moment coeval with the birth of civilization. Unlike their predecessors, many nineteenth-century music historians accorded non-Western music extensive—at times, even voluminous—treatment, and in so doing they tendered a vision of music history reflective of the fundamental intellectual and scientific spirit of their era, thus an historical conceptualization essential to the birth of modern musicology”²⁴¹.

Musicologists of the end of the 18th and the beginning of the 19th centuries were indeed, for the first time, massively confronted to musics of other cultures, either through world fairs or through their direct contacts with these cultures “in their homes”.

Whenever Chinese, Indian, Arabian, Turkish²⁴² or Persian, or Native American²⁴³, Aboriginal from Australia etc., cultures became more familiar, some of these cultures were already beginning to fade and vanish²⁴⁴, which even strengthened more the urge for a museographical study of these musics, on one hand, and the careful examination of the principles underlying them on the other hand.

Of course, scarce travel relations of such musics²⁴⁵ and a few manuscripts²⁴⁶ fell between the hands

of previous researchers (or dilettantes) in the field (see for instance Fig. 34), notably in the 17th and 18th centuries²⁴⁷, but the evidence was too scattered for erudites and theoreticians to be able to draw a coherent picture of (about) all the music in the World²⁴⁸.

<i>Notes Arabes.</i>	<i>Intervalles.</i>	<i>Notes Européenes.</i>	<i>Intervalles.</i>
Rafd.....	ur
Douga..... 4	re 2
Seiga..... 3	mi 2
..... 3	fa 1
Charga..... 4	fol 2
Naoua..... 4	la 2
Hnffeinin... 3	fi 2
Aouch..... 3	ur 1
..... 3		
Maour.....		
	24		12

Fig. 34 “Arabian scale” in quarter-tones compared to the European scale (as shown in [Laborde (de), 1780a, v. 1, p. 439]); the provenance of this scale, probably the first known quarter-tone division attributed to the Arabs, is unknown²⁴⁹.

Let us note that such relatively early research had in fact a triple aim: finding the sources of Greek and

Scientific data, including them sometimes in broad schemes of universal knowledge (e.g., [Kircher, 1650])” – in [Bohlman, 1988, p. 27]; according to [Lortat-Jacob, 1975], Harrison describes the authors of the excerpts he proposes as “Christian professionals and proselytes”, or exceptionally “non-professionals”, or further “travellers with diplomatic, commercial or colonization concerns”; all these travellers have another common characteristic, as they “all assert – with disturbing clear conscience – that they are merely relating the ‘strict truth’ in their accounts”.

²⁴⁶ See for example for a-ş-Şaydāwī’s treatise (addressed in [Laborde (de), 1780a, v. 1, p. 179 sq.]) Shiloah’s article with Berthier [1985].

²⁴⁷ For example [Laborde (de), 1780a] (more on this author in [Fend, 2001]).

²⁴⁸ Which was not called, then, World music.

²⁴⁹ Villoteau cites the quarter-tone division (and even the eighth of the tone division) as one of the Arabian divisions of the scale in [Villoteau, 1809, p. 14], along with the (17 – see footnotes 270-273) thirds of the tone division (which he considers as the most adequate and generalized, both for theory and praxis).

²⁴⁰ Found in [Burney and Mercer, 1935, v. 1, p. 1024].

²⁴¹ [Bohlman, 1987, p. 147–148].

²⁴² Not to forget the siege of Vienna and the *mehter*(s) of the Janissaries – see [Bowles, 2006].

²⁴³ In all the Americas.

²⁴⁴ Most of these traditional cultures undergoing the combined effects of colonization, imported technology and forced modernization, be it technological or cultural, or limited, or oriented.

²⁴⁵ Often written by missionaries, and sometimes being a complete musicological study like Amiot’s *Mémoire sur la musique des Chinois* ([Amiot, 1779], published as part of [Amiot, Bourgeois, and Poirot, 1779], sixth volume of a series of fifteen published 1771-1791; it seems that two other volumes were added in 1814 – see <http://www.chineancienne.fr/17e-18e-s/mémoires-concernant-les-chinois/>). Note also: “Early missionary records and traveler’s accounts, [...] include observations of music in non-European cultures (see [Harrison, 1973]). More systematic studies of music, such as organological works, also treat non-Western instrument as

Christian musics²⁵⁰, and/or try to understand better European music through comparative studies²⁵¹.

The two trends of European thought pinpointed by Ignacy Sachs (above), emphatic and exclusive, were to be found in those 19th-century attempts, a dichotomy which would last till the present days.

Three stages (?) of the History of (World's) Music in the 19th century

The aims of musicians and theoreticians writing about Arabian music seem to evolve after the 18th century, although some of those remain: Salvador-Daniel²⁵², for example, clearly expresses his desire of finding the roots of Christian and/or Greek musics in “primitive” *maqām* music²⁵³, whenever others (and

²⁵⁰ See for example [Menestrier, 1685, p. 8–9, 35–37] for whom the origins of Greek and Egyptian music were Hebrew, with a continuity in European music.

²⁵¹ [Laborde, *op. cit.*]; this trend continued in the 20th century, for instance with Curt Sachs who stated at the Congrès du Caire of 1932: “each new information on Oriental music increases our knowledge on Occidental music of the Middle Ages” (quoted from [Vigreux and Hassan, 1992, p. 117]).

²⁵² For all this period and Colonial French relations with Arabian music see [Pasler, 2012], which addresses “piano[!]/vocal transcriptions of African melodies by Salvador Daniel, Jules Rouanet and Edmund Yafil in Algiers, Antoine Laffage and Baron Rudolph d’Erlanger in Tunis, and Alexis Chottin in Morocco; orchestral music which incorporates African melodies, rhythms, and timbres by Camille Saint-Saëns; and marches by Africans as well as French composers”, with this remark [p. 30]: “The most compromising aspect of musical acclimatization derived from the transcription of melodies into conventional western notation. Even the transcribers themselves were frustrated with their inability to indicate microtones and subtle timbres. To make matters worse, to facilitate performances on western instruments like the piano, many transcribers often added harmony, cadences, and other accoutrements of western art song, including instrumental introductions, interludes, and codas”.

²⁵³ See for example [Salvador-Daniel, 1862a; 1862b], entitled *La musique arabe: ses rapports avec la musique grecque et le chant grégorien* (*Arabian music: its relation with Greek music and Gregorian chant*). [Pasler, 2012, p. 28] comments: “Jules Rouanet too claimed that Arab music had its roots in ancient Greece, as did Alexis Chottin in his 1928 study of Moroccan music [...]. Such theories suggested that, although Daniel provided more affirmations than proof, North African music seemed a potential source of knowledge about ancient Greek music: knowledge of the Other was capable of enhancing knowledge of the Self”, and [Pasler, 2012, p. 29]: “Émile Masqueray, who ran the École Supérieure de Lettres in Alger (1872-1894) and produced the only scholarly work on the Kabyles in those years, compared Kabyle villages to the primitive villages of both classical Rome and Greece as well as Auvergne and Savoy in France. He was convinced that

sometimes the same) searched for exotic ways for music expression²⁵⁴.

As for the inclusion of this “primitive” art in Music history, Bohlman divides the 19th-century research in two periods, spanning roughly its first and second halves:

“The first half of the [19th] century was characterized best by discovery itself, that is by initial and objective encounter with non-Western music and culture. Music historians in the second half transcended the first²⁵⁵ by endeavoring to integrate the music of non-Western cultures into the science of history. The considerable significance of the music histories [...] suggests furthermore that too little account has been taken of nineteenth-century contributions to a nascent ethnomusicological literature. [...] both musicology and ethnomusicology were rooted in similar conceptual soils during the past century, so much so that the two disciplines were dependent upon one another for a scientific unity necessary to secure a place for them in the intellectual institutions of the present century”²⁵⁶.

The role played by *maqām* music²⁵⁷ in this process is highlighted, from the very beginning, by the author:

→ studying these ‘small republics’ would shed light on the ‘institutional origins of Western civilization’. Common racial origins offered justification for French occupation and colonialism”. Bohlman explains on the other side the importance of the search for the origin of all music for 19th-century researchers: “Early nineteenth-century discoveries in linguistics had spawned a more intense interest in and understanding of the origins of languages. The search for ‘beginnings’ became also a clear motivation for the inclusion of non-Western music in a general history of music. The discussion of non-Western music most often appeared in that section designated in some way as a study of origins. Thus, it is not surprising to find increasing numbers of histories devoting attention to the *Anfänge der Tonkunst*, by which their authors meant to discuss non-Western music in terms of the origin of all music” – [Bohlman, 1987, p. 159-160].

²⁵⁴ This topic is further addressed in section “Musical Orientalism” (Chapter 5) below.

²⁵⁵ We shall see that this stage was never transcended, with its consequences persisting until the present days.

²⁵⁶ [Bohlman, 1987, p. 148].

²⁵⁷ Whenever Arabian countries were supposed to be a key link between the Ancient Greeks and Europe, they were also an “easy prey” in the French/English colonizing enterprises as expressed in [Bohlman, 1987, p. 149]: “The nations most actively engaged in military expansion at the end of the eighteenth century were France and England, and it was accordingly in French and English academies that Orientalist scholarship acquired its initial impetus. Even though their colonial goals were literally boundless, one very special prize of both nations was the geographic region stretching from northwest Africa to Central Asia, an area occupied largely by Islamic cultures. Not only did the proximity of the Middle East

“Although multifarious musics became the objects of the new musical scholarship in the nineteenth century, none played a more significant role than music in the Middle East. This role may justifiably be criticized because of the diverse garb its players sometimes donned, but it was nevertheless a role vital to a new understanding of music and history both in the culture of ‘the Other’—that is, the non-European world—and in Europe itself”²⁵⁸.

Bohlman identifies the first stage of Arabian music inclusion in European research as an ethnographical stage, which started with Villoteau’s²⁵⁹ *De l’État actuel de l’art musical en Égypte*²⁶⁰ and Lane’s *Account of the Manners and Customs of the Modern Egyptians*²⁶¹. These descriptive writings, mainly museographic for Villoteau²⁶² and ethnomusicological (field research on music life and society) for Lane, became major

references for subsequent research on Arabian music²⁶³.

The second stage is represented by Georg Kiesewetter’s²⁶⁴ *Die Musik der Araber nach Originalquellen dargestellt*²⁶⁵, which relies on the former (especially Villoteau) and on a few Arabian manuscripts including (al-) Fārābī’s *Kitāb al-Mūsīqī al-Kabīr*²⁶⁶ (*The Great Book on Music*) and (al-) Urmawī’s *Kitāb al-Adwār* (*The Book of Cycles*)²⁶⁷.

While crediting (al-) Fārābī with adapting Greek theories to Arabian music²⁶⁸ Kiesewetter devised, with the help of Austrian orientalist and philologist Joseph Freiherr von Hammer-Purgstall²⁶⁹, an original theory of the Arabian scale based on a third-of-the-tone division (for the “tones” of the Pythagorean scale) with the adjunction of two *leimmata* as complementary intervals filling the *e-f* and *a-b* needs (Fig. 35)²⁷⁰.

→

make it fairly easy prey, but European nations had historically viewed the region as both the source for their own classical civilization and the site for its decline. It therefore became the charge of Orientalist scholarship to search out and preserve the past. Military ventures in the Middle East were frequently accompanied by cultural expeditions, whose goal it was to rescue cultural artifacts for European scientific establishments, wherein they would presumably be preserved for the good of all mankind”.

²⁵⁸ [Bohlman, 1987, p. 147–148].

²⁵⁹ [Bohlman, 1987, p. 149].

²⁶⁰ [Villoteau, 1826] (available on gallica.org), part of [France. Commission des sciences et arts d’Égypte, 1809].

²⁶¹ [Lane, 1836], with numerous other editions available on the internet. The small monography [Christianowitsch, 1863] is also worth citing as an example of ethnological (and social) study, coupled in this case with excerpts from the *Kitāb al-Aghānī* by Aṣṣfahānī [1990, الأصفهاني].

²⁶² Although Villoteau tried to understand the theoretical system of Arabian music of his time, and used extant manuscripts in his research including [Anonyme, 1983]; his main position remained however Pythagorean (ditonic), as he considered Arabian music as a “corruption” of “Ancient Greek and Ancient Asiatic musics”: “[Whether] the divisions and subdivisions of the tones of Arabian music in so small and unnatural intervals that the ear can never perceive them with precision, [or] the multiplicity of the modes and cycles or various scales which result from the combination of these intervals [together], everything shows that this sort of music is born from the corruption of Ancient Greek and Asiatic musics” (in French “Les divisions et subdivision des tons de la musique arabe en intervalles si petits et si peu naturels, que l’ouïe ne peut jamais les saisir avec une précision très exacte, ni la voix les entonner avec une parfaite justesse ; la multitude des modes et des circulations ou gammes différentes qui résultent de la combinaison de ces sortes d’intervalles ; tout annonce que cette espèce de musique est née de la corruption de l’ancienne musique grecque et de l’ancienne musique asiatique”) – see [Villoteau, 1809, p. 10–11].

²⁶³ [Bohlman, 1987, p. 150].

²⁶⁴ The insertion of German *Musikwissenschaft* in this process is explained in [Bohlman, 1987, p. 149] thus: “During the nineteenth century other nations entered the colonial race, thereby challenging French and English domination and loosening their grip on the attendant scholarly activity. The primary venue for scientific interpretation of ‘the Orient’ shifted also, from France and England to Central Europe, primarily to the German academy, there becoming a fundamental impetus for the burgeoning German *Wissenschaften*”.

²⁶⁵ [Kiesewetter, 1842; 1988].

²⁶⁶ A manuscript of Fārābī’s *Great Book* was recently edited by Eckhard Neubauer as [1998, الفارابي]; a French translation [Fārābī (al-), 1930; Fārābī (al-) et al., 1935] by Erlanger was re-edited as [Erlanger, 2001a; Fārābī (al-), 2001], and an edition in arabic [أبو نصر محمد بن محمد بن ترخان الفارابي, 1967] is available.

²⁶⁷ A copy of (Ṣafīyy-a-d-Dīn al-) Urmawī’s writings on music (including the *Risāla a-sh-Sharafīyya*) was edited by Neubauer as [Urmawī (d. 1294), 1984]; a French translation from a commentary on the *Book of Cycles* (including the text of the latter) together with the *Sharafīyya* was edited by Erlanger as [Urmawī (d. 1294) and [Jurjānī (al-), 1938], with numerous Arabic editions (for instance [Ṣafīyy-a-d-Dīn ‘Abd-al-Mu’min ibn Yūsuf ibn (ab-i-l-Ma)Fākhīr (al-) Ṣafī al-Dīn al-Urmawī (d. 1294), 1980]), not forgetting Wright’s seminal work on Urmawī and his followers (the so-called “Systematist school”) [Wright, 1978].

²⁶⁸ See Appendix 3 for one example of such developments.

²⁶⁹ And probably following Villoteau’s lead as this author also addresses a third-of-the-tone division in [Villoteau, 1809, p. 13–16] – see also footnote 272.

²⁷⁰ With 17 intervals in the octave, of which 15 thirds of the tone (5 tones), the two *leimmata* being necessary for the completion of the (Pythagorean) octave. This scale (sustained in [Fétis, 1869b, v. 2, p. 28]) was derived, however, from Ṣafīyy-a-d-Dīn al-Urmawī’s “Pythagorean” scale in 17 intervals, these being either *leimmata* or *commata*. Wallascheck [1893, p. 154–155] gives an interesting

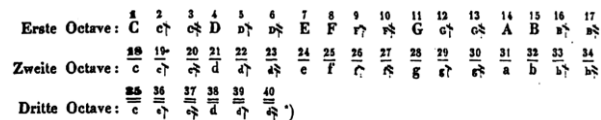

Fig. 35 Division of the Arabian octave in thirds of the tone and *leimma(s)* according to Kiesewetter²⁷¹.

This was²⁷² the beginning of the multifarious, chronic and endless speculations about the (“perfect”) Arabian scale. It was also the beginning of the inclusion of the music of the Arabs, although a

summary of the state of the art knowledge (and biases) about the “Arabian” scale towards the end of the 19th century:

“The Arabs seem to be still more particular in distinguishing sharps and flats than we are. The equal third and quarter tones of the Arabs, Villoteau mentions, are no doubt a mistake. Kosegarten affirms that Villoteau constantly mixes up the Arabian and Persian musical system [possibly influenced by Laborde – see Fig. 34, p. 85 and FHT 18, p. 188], and so does Kiesewetter in his treatise on Arabian music. According to [Fleischer, 1886] [i.e. a review of Land – see below], however, the Persian and Arabic music systems cannot possibly be separated, while Arabic and Egyptian music have nothing in common. All these questions were at last settled by Land ([Land and Fārābī (al-), 1884]). He says Arab lutenists had seventeen notes within the octave, strictly distinguishing between flats and sharps. Out of this mass of tones they formed diatonic scales according to our principle with flats only or with sharps only; thus they distinguished the C sharp major scale from the D flat major scale in practice, while we distinguish it merely in theory. The equal division of equal quarter tones (twenty-four altogether) is of later date and still to be met with”.

Apart from the facts that 1) the Early Arabian scale (including the Systematist scale) was in fact a Zalzalian (“diatonic” in the Oriental sense of the word) scale (Owen Wright clearly avoids this mistake in [Wright, 1978]) and, 2) that Arabs (Persians, etc.) do not seem to have considered “equal” thirds or quarters of the tone and, 3) that there is no reason why “the Arabs” would form scales “with flats only or with sharps only” (there was no concept of “sharp” or “flat” at the time of Fārābī), this text explains more or less correctly the known results of (Western) research in the field to those times (more about the author in [Graziano and Johnson, 2006]). See also the introductory section of [Land and Fārābī (al-), 1884] for a review of the various hypotheses on the “Arabian scale” to that time.

²⁷¹ [Kiesewetter, 1842, p. 21]: such a division would be nowadays unthinkable for most acculturated Arabian music practitioners, for whom the quarter-tone division is the only “traditional” division possible.

²⁷² Preceded by isolated propositions as for instance Laborde’s (see notably FHT 21, p. 189) and Villoteau’s [1809, p. 13–16] in which the latter introduces the “third-of-the-tone scale”, presumably adopted largely by Arabian authors and “in conformity with their instruments”. Villoteau’s scale, however, is based on 17 thirds of the tone, the two “small half-tones” of the ditonic scale being equated with a third of the tone each.

“declining” one “since medieval Islam”²⁷³, in the course of (Pythagorean, semi-tonal) World History:

“Kiesewetter’s historical discussion²⁷⁴ bears evidence of several models for historical thought prevalent in the nineteenth century. Clear organization according to progressive epochs is obvious. The development of music passes from simple to complex forms, with the simplest also possessing a quality of naturalness that was in essence universal. His adherence to these models at times caused Kiesewetter to overstate his case, for example when urging his readers to turn a sympathetic ear to Arabic music and recognize its basic similarity to Western music:

“The scale of the Arabs, in its simplest diatonic form, is the same as that on which all civilized people have built the system of their music: it must be based on the external laws of nature, for it arises just as well from the sense of hearing as from the most comprehensible numerical relationships; once Man conceives this and abandons his simple prejudices against other musics, then he will find himself easily attracted to them.”²⁷⁵²⁷⁶.

(World-Wide) Evolutionary(?) Music History

Never before as in the 19th century²⁷⁷ was the need to include Arabian music in a unified history of Music so necessary, mainly to prove that music was evolutionary, and that Western civilization was the culmination of this evolution²⁷⁸. However, this

²⁷³ As expressed in [Bohlman, 1987, p. 152].

²⁷⁴ Bohlman published an article [1986] dedicated to Kiesewetter’s book.

²⁷⁵ Citing [Kiesewetter, 1842, p. 72].

²⁷⁶ [Bohlman, 1987, p. 152].

²⁷⁷ A period of conquests and colonization all over.

²⁷⁸ The evolutionary theory of music history is addressed, and strongly criticized, by Curt Sachs in the closing chapter of his posthumous *The Wellsprings of Music* (edited by Jaap Kunst), notably: “The picture this book has endeavored to draw is strange enough. All over the world, from the Eskimo to the Fuegians, from the Lapps to the Bushmen, people sing and shout and bleat with voices wild or monotonous; they scream and mumble, nasalize and yodel; they squeak and howl; they rattle, clapper, and drum. Their tonal range is limited, their intervals are foreign, their forms short-winded, their inventive capacities, it seems, rather deficient, their traditional shackles all powerful. Is it permissible to call these noises music, if the word denotes the sacred art of Bach and of Mozart? And if it is music – how many steps were needed to lead from the humble, anonymous inventor of palaeolithic songs through untold thousands of years to the divinized genius of the Later Ages with his boundless imagination and master technique, how many steps to climb from an ever repeated, unassuming scrap of melody to modern music dramas and symphonies? Beholding these steps, these numberless changes in style, ideas, craftsmanship, and social connotations, the reader must have had the dangerous slogan ‘progress’ in mind. But was it actually

Hegelian²⁷⁹ approach to Music history²⁸⁰ was implemented neither smoothly, nor totally or permanently.

→ progress that marked the long peregrination through ages and cultures? Not long ago, the answer would have been a wholehearted Yes. The dominant theory of ethnology at the time Boas entered anthropology was that culture – or society, as it was variously phrased – had evolved, and was evolving from simple to complex forms, from lower to higher modes of life. It was, like all theories, a product of its times. It is commonly assumed to have been an offshoot of the Darwinian hypothesis... We no longer believe in a neat evolution from low to high, a constant development from unassuming simplicity towards an ever growing complication, from infancy through boyhood and maturity to a dotting old age – and to what next? Those were the days when ancient Egyptian art was disdainfully judged as a not yet matured precursor of Greek and Roman classicism, and Romanesque architecture as a somewhat lowly preparatory step towards the dizzying Gothic cathedrals, which in due time led the way to the noble perfection of Renaissance building. There occurred a few mishaps, however: evolution from poor to better had a number of disturbing flaws. In the official, classicistic mentality of the nineteenth century, the arts of Greece and the High Renaissance were perfect. The Romans ranked not quite as high; the Middle Ages acquired in Italy the disreputable name of Gothic or barbarian; and the Baroque was repellent to classicistically refined tastes. Neither did Frank Lloyd Wright evolve from Phidias, or Picasso from Zeuxis. There were connections and disconnections, attractions and repulsions; in short, there were fluctuations but no evolution to an ever greater perfection. The evolutionists found themselves on an artificial flight of stairs, on which they climbed up from step to step while the landing of highest perfection should be at the upper end but actually was, according to their own aesthetics, two thousand five hundred years behind and below the step on which they were climbing” – in [Sachs, 1962a, p. 210–211].

²⁷⁹ But also “Darwinian”, according to C. Sachs (see previous footnote) and to Bohlman himself in [Bohlman, 1987, p. 160]: “History thereby acquired attributes according to an organismic metaphor; historical progress was marked by a response of complex and diverse parts, together constituting a whole. [The] elaborate schemes of classification in all scientific areas [that] followed suit from the work of Charles Darwin and Herbert Spencer. The specific contributions of evolutionary theory to the writing of more comprehensive music history may be more difficult to pinpoint, but I would submit that their entrance into musical scholarship was facilitated by the growing acceptance of non-Western music as inseparable from music history”, with Solie explaining that “Two aspects of the doctrine of evolution loom especially large in the writing of history: first, the progressive development from simple to complex or from homogeneity to heterogeneity as put forth by Herbert Spencer; and second, the growth of the new from the old as each new species displaces its predecessor, according to the writings of Darwin” – [Solie, 1982, p. 297–298]; note that Spencer preceded Darwin shortly with his evolution theory, based on the transmission of acquired changes through generations; his contribution to music evolution theory is part of his Essays [Spencer, 1858a], entitled “The origin and

ERRATIC INCLUSIONS (OR EXCLUSIONS) OF “FOREIGN MUSICS”

Whenever Wilhelm Ambros’ *Geschichte der Musik*, for instance, proposes a chronology including the “Music of the Arabs” with “Primitive musics” such as Chinese and Indian, which precede the musics of (Ancient) Egypt and of Asian civilizations such as Assyrian, Babylonian, Persian, Phoenician, Phrygian, Lydian, Hebraic, which give way to (Ancient) Greek (then Roman) music followed by the music of Byzantium and, finally, by the music of the European Middle ages etc.²⁸¹, other music histories of the 19th and beginning of the 20th centuries propose different chronologies²⁸². Most “mainstream” histories of music continue, like Burney, to consider only the Egyptian, Hebrew and Greek musics before proceeding to “Christian” music²⁸³, or divide “Ancient” music in three

→ function of music” [Spencer, 1858b]; other specificities differentiate those two theoreticians of evolution (see the well documented article [Anon. “Herbert Spencer”, 2016]).

²⁸⁰ “In this grand scheme a full presentation of music in the Islamic world was necessary for several reasons. First, the historical hiatus separating the Classical civilizations of Greece and Rome, as well as those of ancient Egypt and Israel, from the Latin Middle Ages was filled; [...] Second, the Middle East was strategically located between Asia and Europe, hence making its culture and music also catalysts for the grand migration of civilization from Asia to the West, the monolithic design of human history claimed by Hegel and espoused by many nineteenth-century historians. Finally, the contemporary practice of Middle Eastern music took place in that part of the world in which Christian musical traditions had presumably originated. Though not itself Christian, the music of Islamic cultures might serve as further evidence for the religious antecedents of European music” – in [Bohlman, 1987, p. 153–154].

²⁸¹ See [Ambros, 1862, v. 1, p. xxi–xxii] and [Ambros et al., 1881, v. 2, p. xxvii–xxviii].

²⁸² Ambros’ *History of Music* represents however an evolution from former histories and essays, such as Burney’s (seen above) who only addresses Egyptian, Hebrew, Greek and Roman music before proceeding to European music, or the chevalier de Laborde’s eclectic *Essai sur la musique ancienne et moderne* [Laborde (de), 1780b] which swings across periods and regions or countries, from “Jews” to “Chaldeans [Chaldéens] and other Orientals” to the “Egyptians”, “Greeks”, “Romans”, “In Italy”, “The Gauls till the present day”, the “Chinese”, not forgetting the musical instruments of the “Negroes”, the “Chinese” and the “Arabs” or the “Music of the Russians”.

²⁸³ See for instance [Higgins, 1838, p. vii–viii] where “Music among the early Christians” follows “Grecian music” and precedes “Introduction of Music with Christianity[!] into Britain” and “The Troubadours and Minstrels”; note that some “historians of music” did not even bother to include Egypt in their accounts, as for instance [Kalkbrenner, 1802a; 1802b] who addresses directly the

parts: “Primitive or savage music”, “Semi-civilized music” and “Greek and Roman music” while including “Mohammedan music” in the “Semi-civilized part”²⁸⁴, when not writing a “*General History of Music*” which begins with Greece, then the Early Christians before proceeding to Occidental music²⁸⁵...

INTRODUCTION	
THE HISTORY OF MUSIC IN GENERAL	PAGE 17
PART I. UNCIVILIZED AND ANCIENT MUSIC	
CHAPTER	
I. PRIMITIVE OR SAVAGE MUSIC	25
II. SEMI-CIVILIZED MUSIC	32
III. GREEK AND ROMAN MUSIC	50
PART II. MEDLÆVAL MUSIC	
IV. THE RISE OF CHRISTIAN MUSIC	63
V. POLYPHONY AND SECULAR SONG	77
VI. THE FIFTEENTH CENTURY	93

Fig. 36 Pratt’s division of Ancient music in “Primitive”, “Semi-civilized”, then “Greek and Roman” before proceeding to “Christian music”²⁸⁶.

As a further example, the monumental *American History and Encyclopedia of Music* edited by W. L. Hubbard does not even mention, in the

→

“Music of the Hebrews”, then “the Greeks”, “the Romans”, and finally “the Music of the Christians”, while acknowledging (however) that “the Hebrews [...] took their instruments from the Egyptians and other neighboring peoples” – [Kalkbrenner, 1802a, p. 40].

²⁸⁴ See [Pratt, 1907, p. 9], and notably the following explanation of “Semi-civilized music” in [Pratt, 1907, p. 32]: “Music enters the semi-civilized stage along with the other activities of developing society. When a people emerges from the heedless and irregular habits of savagery, its music usually attracts enough reasoning and skill to make it in some sense artistic. [...] Among existing systems, those of China, India and the Mohammedans will be emphasized, and among ancient systems, those of Mesopotamia, the Hebrews and Egypt the latter being probably rather more than ‘semi-civilized,’ though decisive data are lacking”. Note that Curt Sachs draws sometimes parallels between Arabian music and “primitive musics”, for instance: “Transcription into Western notation depends not merely on gifted and well-trained ears, but also on a special technique of symbolizing the peculiarities of primitive and Oriental music” – in [Sachs, 1943, p. 26]. The most peremptory statements I could find, however, are [Tapper and Goetschius, 1914, p. 2, 3]: “It may be safely assumed that none of the so-called music of ancient and of primitive races was elevated very far above the purely physical or animal utterance”, and “Up to the beginning of the Christian era there exists no positive evidence of any, even the most primitive, systems of tone combination”.

²⁸⁵ See for instance [Rockstro, 1886, p. xi] on Fig. 37.

²⁸⁶ Excerpt from [Pratt, 1927, p. 9].

3rd volume dedicated to “Foreign music”²⁸⁷, the Arabs apart from short notices²⁸⁸, and in the article “Persia” thus:

“The Arabs, through their ignorance or prejudice, destroyed or disfigured all the libraries or works they found at the time of their conquest²⁸⁹. It is now generally believed, however, by

²⁸⁷ With the following contents: Music of Primitive Peoples, China, Japan, Korea, Malaysia, Persia, Turkey, Mexico, Italy, Troubadours, Germany, France, Russia, Eastern Europe (Austria, Bohemia, Hungary, Poland), Scandinavia (Norway, Sweden, Denmark, Finland), England, Ireland, Scotland, Wales, Canada and Spain – in the first pages of [Hubbard et al., 1908, vol. 3], not numbered.

²⁸⁸ For instance for their influence on “primitive peoples” in the Upper Congo – see [Hubbard et al., 1908, vol. 3, p. 11].

²⁸⁹ It seems that the author had a strong prejudice against Arabs; in a note to Gibbon’s *The decline and fall of the roman empire*, Henry Milman explains, commenting about the presumed destruction of the library of Alexandria by caliph ‘Umar’s [‘Umar Ibn al-Khaṭṭāb] lieutenant ‘Amr [‘Amrū Ibn al-‘Āṣ], that the only books to be destroyed in Persia were religious books contradicting the doctrine of islam:

“The silence of the early authorities, both Greek and Arabic, is the main argument for Gibbon’s scepticism as to the burning of the Alexandrian ‘library’ by Omar’s [‘Umar’s] orders. The silence of the chronicles of Theophanes and Nicephorus does not count for much, as they are capricious and unaccountable in their selection of facts. The silence of Tabari and Ibn Abd al Hakam is more important, but not decisive. Of far greater weight is the silence of the contemporary John of Nikiu, who gives a very full account of the conquest of Egypt. Weil supports Gibbon, while St. Martin, among others, has defended the statement of Abulfaragius. [...] — The origin of the story is perhaps to be sought in the actual destruction of religious books in Persia. Ibn Khaldun, as quoted by Hajji Khalifa [...], states that Omar authorised some Persian books to be thrown into the water, basing his decision on the same dilemma, which, according to Abulfaragius, he enunciated to Amr. It is quite credible that books of the Fire-worshippers were destroyed by Omar’s orders; and this incident might have originated legends of the destruction of books elsewhere” – in [Gibbon, 1872, v. IX, p. 185, footnote 141] (more about the conquest of Persia by the Arabs in [Gibbon, 1872, v. IX, p. 120 sq.]).

Whatever was the “cultural” (or religious) policy of the conquering Arabs at that time, they were soon assimilated in the Persian and Byzantine cultures, as for what concerns books and libraries: “The royal library of the Fatimites consisted of one hundred thousand manuscripts, elegantly transcribed and splendidly bound, which were lent, with jealousy or avarice, to the students of Cairo. Yet this collection must appear moderate, if we can believe that the Omniades of Spain had formed a library of six hundred thousand volumes, forty-four of which were employed in the mere catalogue” – [Gibbon, 1872, v. IX, p. 271]; see also Butler’s account on “The Library of Alexandria” [Butler, 1902, p. 401–426] and his final statement [Butler, 1902, p. 425–426]: “The conclusion of the whole matter can be no longer doubtful. The suspicion of Renaudot and the scepticism of Gibbon are more than justified. One must pronounce that Abū-l-Faraj’s

→

→ story is a mere fable, totally destitute of historical foundation”, with the following footnote: “My only concern in this matter has been to establish the truth, not to defend the Arabs. No defence is necessary: were it needful, it would not be difficult to find something in the nature of an apology. For the Arabs in later times certainly set great store by all the classical and other books which fell into their hands, and had them carefully preserved and in many cases translated. Indeed they set an example which modern conquerors might well have followed [...]”; note that the thesis of the burning of the Royal library of Alexandria seems to have been fueled by Bar-Hebraeus (Abū-l-Faraj in Arabic):

“The manuscripts were then gathered together and used as fuel for the 4,000 bathhouses in the city. In fact there were so many scrolls that they kept the bathhouses of Alexandria heated for six months. These incredible facts were written down 300 years after the supposed event by Christian polymath Gregory Bar Hebraeus (1226-1286 CE). However, while the Arabs may have destroyed a Christian library at Alexandria, it is almost certain that by the mid 7th century CE the Royal Library no longer existed. This is made clear by the fact that no mention is made of such a catastrophic event by contemporary writers such as Christian chronicler John of Nikiou, Byzantine monk and writer John Moschus and Sophronius, Patriarch of Jerusalem” – [Haughton, 2011]; see also [El-Abbadi, Fathallah, and Serageldin, 2008, p. 210–211] and “The story of the Arab burning of the Library is legend” in [MacLeod, 2004, p. 210] and, mostly, [Delia, 1992, p. 1465–1466] with the followings excerpts from her rather complete account on this matter:

“In contrast to the classical tradition, which attributed the destruction of the Ptolemaic library to accident, Arab historians ‘Abd-al-Latif al-Baghdādi, Ibn al-Qifti, and Abu-l-Faraj credited the dashing Muslim general ‘Amr with its deliberate ruin during the Arab conquest of Egypt in A.D. 642” {with here footnote 78: “Abd-al-Latif al-Baghdādi composed his history of Egypt in Cairo at the beginning of the thirteenth century; *Kitāb al-Ifāda wa-l-Fitbār*, J. White, ed. (Oxford, 1800), 114; see also Silvestre de Sacy, trans., *Relation de l’Égypte par Abd-al-Latif* [Baghdādi (al-) and Sacy (de), 1810, p. 183]. [Jamāl-a-d-Dīn Abū-l-Ḥasan ‘Alī Ibn Yūsuf] al-Qifti wrote his history of wise men *circa* 1227; *Tārīkh al-Ḥukamā*, [Qifti (Ibn al-), Müller, and Lippert, 1903, p. 355–356]. Abū-l-Faraj, also known as Bar Hebraeus (A.D. 1226-89), reproduced Ibn al-Qifti’s account in his *Al-Mukhtaṣar fi-d-Duwal*, in *Historia compendiosa dynastiarum*, Pococke, ed., 181-82; on the problems associated with his account, see Butler, *Arab Conquest of Egypt*, [Butler, 1902, p. 405–406][...]”, and:

“But several considerations render the Islamic tradition suspect. It is scarcely likely that many pagan manuscripts from the main library and annexes survived the depredations of Christian zealots during late antiquity. Also, this story suddenly surfaced in the thirteenth century after five and a half centuries of silence. And precisely the same response of ‘Umar is recorded by Ibn Khaldūn in connection with the destruction of another library in Persia. Romanticism combined with nationalistic fervor to fabricate an utterly fantastic legend about the destruction of the great Alexandrian library—not by the Romans but by the most recent subjugators of Egypt. ‘Listen and wonder,’ Ibn al-Qifti skeptically concluded, as well one might! Though clearly apocryphal, the tale nevertheless reflects an older, reactionary tradition concerning the well-attested reluctance of ‘Umar and his successors officially to

the best authorities, that the Persians derived their science of music from India and that it was similar to that of the Assyrians and Babylonians. It is certain that later they communicated it not only to the Arabs but also to the Turks, [...] and it would not be surprising if it should be found that the Dorians borrowed from the Greek colonies of Asia Minor, who, in turn, borrowed their music from the Persians. Both were of Aryan stock”²⁹⁰.

The most striking example of historical, chronological and geographical inconsistency remains, however, the French *Encyclopédie de la musique et dictionnaire du conservatoire* of which the first volume (1.1) addresses music from Antiquity to the Middle Ages.

In the prefatory presentation of this (other) monumental work, we are informed that 130

→ acknowledge any book other than the *Qur’ān* and the early controversy concerning the authority of the *Ḥadīth*, the collection of sayings and deeds of the Prophet and his immediate followers. Moreover, the Arab historians who recorded this tradition flourished during the late twelfth and early thirteenth centuries, when the celebrated exploits of Salāh-a-d-Dīn, especially the spectacular recovery of Jerusalem from the Christian crusaders in 1187, reminded Arabs of an earlier age when the fledgling forces of Islam had originally embarked on a holy war against Christendom. Accordingly, ‘Umar’s rejection of pagan and Christian wisdom may have been devised and exploited by conservative authorities as a moral exemplum for Muslims to follow in later, uncertain times, when the devotion of the faithful was once again tested by proximity to non-believers”.

²⁹⁰ [Finkelstein, 1908, p. 53]; the next pages are not disappointing either, for example [Finkelstein, 1908, p. 55–56]: “When the Arabs conquered Persia (A. D. 641) the Persians already had attained a higher degree of civilization than their conquerors. The latter found in Persia the cultivation of music considerably in advance of their own, and the musical instruments there superior to any they themselves possessed. They soon adopted the Persian instruments, and there can be no doubt that the musical system exhibited by the earliest Arab writer whose works on the theory of music have been preserved, was based upon an older system of the Persians. In these works, the octave is divided into seventeen tones, so that the work of the reformers was in actuality a return to original theories. This division of the octave still obtains in Persia and this despite the fact that certain theorists, who labored toward the end of the Thirteenth Century, formulated and adopted a system in which twelve intervals were made to constitute the octave, a division corresponding to that found in our own music”. When I tried to reach for the references of this article (“the best authorities” cited by Finkelstein), all I could find under “Persia” was the following: “Ouseley, Sir William *Travels in Various Countries of the East, more particularly Persia*” and “Pocock, Ebenezer *Flowers of the East, with an Introductory Sketch of Oriental Poetry and Music*”, two very specific references on Persian and Arabian music indeed...

“musicians, musicographs, scientists, scholars, archaeologists, men of letters”, French as well as foreign and being all of them “undisputed authorities” in their fields, were involved in writing the various articles of this “*vast synthesis*”, the first part of which is devoted to Music history. Then it goes to methodology:

“Beginning with the most Ancient civilizations known in Antiquity, we study each of them separately in its [own] development and in its filiations until the Middle Ages. For these [civilizations], we had to adopt an exclusively *chronological order*²⁹¹. [...] Then it goes to 2nd order or younger civilizations, then extra-european nations from the East and the Far-East, the New World [...]”²⁹².

BOOK THE FIRST.	
MUSIC IN THE EARLY AGES.	
CHAPTER I. The Music of the Greeks	PAGE 3
„ II. The Music of the Early Christians	14
BOOK THE SECOND.	
MUSIC IN THE MIDDLE AGES.	
CHAPTER III. The condition of Music in the Early Middle Ages. Notation. Discant. The Invention of the Time-Table	23
„ IV. Concerning the Troubadours, the Minstrels, and the Minnesingers	37
„ V. The Invention of Counterpoint	43

Fig. 37 Beginning of the contents of *A general history of music from the infancy of the Greek drama to the present period*, showing the direct continuity between Greek and Early Christian music, then the Occidental Middle Ages²⁹³.

²⁹¹ Italics in the original French text.

²⁹² [Lavignac, 1921, v. 1, p. vi, vii]: “Commençant par les plus anciennes civilisations connues de l’antiquité la plus reculée, nous étudions chacune d’elles séparément dans son développement et dans ses filiations jusqu’au Moyen Âge. Pour celles-là, *l’ordre chronologique* a dû être exclusivement adopté. [...] Viennent ensuite les civilisations de deuxième plan ou les plus jeunes, puis les nations extra-européennes de l’Orient et de l’extrême Orient, du Nouveau Monde, et jusqu’à certaines peuplades insoupçonnées, encore à l’état rudimentaire”.

²⁹³ [Rockstro, 1886, p. xi], with the following enlightening quote: “whatever the Egyptians may have known of Music, it was, quite certainly, first openly cultivated, as an Art, among the Greeks; who taught it to their children, as the strongest incentive to virtue with which they were acquainted” – [Rockstro, 1886, p. 4–5]; the rest can be summarized by a quote from Kalbrenner’s *Histoire de la musique*: “we could say that music, while softening the mores of the Greeks, became the source of the civilization of Europe” (in French: “et l’on pourroit dire que la musique, en adoucissant les mœurs des Grecs, devint la source de la civilisation de l’Europe” – [Kalbrenner, 1802, p. 60].

The logical “exclusively chronological” progression for this encyclopedia stands hence: Egypt, Assyria-Chaldea, (the) Syrians-Persians-Hittites-Phrygians²⁹⁴, (the) Hebrews, China-Korea, Japan, India, Greece, (the) Middle Ages (including Byzantine music), then various European countries and (the) Gypsies, (the) Arabs, Turkey, Persia (once more, but “modern”), (the) Tibet, Ethiopia than various Far-Eastern countries such as Burma-Cambodia-Laos-Siam, Annam-Tongking-Cochin China and islands like (Insulindia [Indochina]) Java-Borneo-Sumatra, Madagascar and the Canary, then “America” and, finally, the “Redskin-Indians”²⁹⁵.

An ingenious chronology (and geography) indeed, in which Ancient Greece is the direct heir of previous Antique civilizations and transmitted in turn its legacy²⁹⁶, exclusively, to the Europeans...²⁹⁷

The “ethnomusicological” approach

Whatever were the means of including “Foreign nations” (and cultures) in World History²⁹⁸, the music of the Near-Middle-Far-Edasts became one of the centers of interests of Occidental scholars. François-Joseph Fétis, one of the prominent “musicologists” of the second half of the 19th century and, according to Bohlman, representative of the “third stage” of Music history writing, distinguished himself from Kiesewetter’s approach²⁹⁹ by highlighting the

²⁹⁴ Persia and Persians are only casually cited in this chapter, devoted in reality to “Syrians and Phrygians”.

²⁹⁵ Or “Native Americans” – [Lavignac, 1921, v. 1, p. viii].

²⁹⁶ Steamedlined from its “Asiatic” components.

²⁹⁷ Note that Byzantine music is in this Encyclopedia included, with “Gregorian chant”, under the generic title “Middle Ages”.

²⁹⁸ Other examples for inclusion of Foreign musics in the histories of music can be found in the first pages of *The wellsprings of music* [Sachs, 1962, p. 5 sq.].

²⁹⁹ Stressing on the “Great Men” of Music: “Another impediment to the full historical integration of non-Western music was the ‘great-man’ determination of musical epochs. Non-Western traditions *ipso facto* belied analysis according to great composers or theorists and thus did not fall neatly into schemes of periodization. Kiesewetter, one of the most notable exponents of this approach, did, in fact, attempt to extend it to his history of Middle Eastern music by dubbing Safī al-Dīn [i.e. Šafīyy-a-d-Dīn al-Urmawī] ‘the Zarlino of the Orient,’ a title that subsequent generations continued to give to the thirteenth-century Arabic writer” – in [Bohlman, 1987, p. 155].

differences between musics³⁰⁰, and by classifying them on a racial basis³⁰¹.

Bohlman stresses Ambros' and Fétis' approaches (the first relegating Arabian music to "Primitive musics" and the second considering that there is no Art music except tonal European music³⁰²) as being

³⁰⁰ "It was to François-Joseph Fétis that the music historians of the second half of the nineteenth century were indebted for debunking the 'great-man' approach. [...] Fétis concerned himself primarily with the ways wherein the different musics of non-Western cultures were unique and distinct. [...] Thus, his descriptions were less likely to stress the links among different musical cultures, which further caused him to minimize any relations between European and Middle Eastern music" – in [Bohlman, 1987, p. 156].

³⁰¹ And excluding thus, through the "ditonic nature" of "the Greek [or 'Hellenic'] race", all musics other than Occidental from the Greek legacy. Fétis' thesis (notably expounded by him in the foreword of [Fétis, 1869b], but primarily formulated in his paper for the Société d'anthropologie de Paris [Fétis, 1867]) was either highly praised (see [Haraszti, 1932, p. 98–99]) or quickly dismissed (although in an argumentative form), as in [Wallaschek, 1893, p. 4–5]: "In any attempt to turn the musico-ethnological material to account by systematising and classifying it perfectly, I do not think myself bound to search out laws and all that bears upon the matter of music, race, climate, etc., because I do not think any such necessity has arisen out of the nature of the subject itself. Nevertheless I cannot refrain from stating that some such attempts have been made. Fétis in his day had the idea of calling ethnological studies in music to his aid in determining the race of a people. For this purpose he specially used the musical system, or rather the musical scale, but I am afraid this method can lead to no exact results. Far from it in fact, for if two races have the same scale there follows nothing to show its common derivation. Correctly enough at the time when Fétis declared his idea, Gaussin had promulgated the notion that the music of a nation developed as civilisation increased, and might very soon assume a totally different form from that of a branch of the same race which has stagnated. Among quite primitive people the idea of a systematic 'scale' is useless. At any moment they may be able to systematically arrange and retain a succession of notes, and to this extent differ from others of the same race; or they can even adopt the system of civilised people. It is true that Broca and Topinard seem to have declared for Fétis, and there are certain cases in which the community of musical systems along with many other characteristics coincides with the community of origin; but none are productive of more satisfactory results than are skull measurements or divisions according to the colour of the skin or hair. It is quite as difficult a matter to scientifically establish a pure musical type as the purity of a race". Curt Sachs was even more explicit in [Sachs, 1962, p. 47 footnote 99]: "The venerable sire of a none too brilliant family of musical racists is Francois-Joseph F[étis], 'Sur un nouveau mode de classification des races humaines d'après leurs systèmes musicaux', in *Bulletins de la Société d'Anthropologie*, n.s., vol. 2, Paris, 1867".

³⁰² [Fétis, 1869b, v. 2, p. vi]: "let us accept, while preserving our racial pride, the fact that there have existed, and there still exist, peoples conformed in another way, which were not deprived

representative of the two forms of comparative musicology in Music history during the 19th century:

"The scientific study of history was undergirded by discoveries and advances in several disciplines, and all of these attained a more concerted impact because of the comparative method, pervasively applied by intellectuals and scientists during the nineteenth century. Music historians too were wont to employ comparative frameworks. The composite methodology of Ambros illustrates one form of the comparative method in music history; the more individualized, quasi-ethnographic examinations of Fétis another form"³⁰³,

while reminding us that:

"special functions were ascribed to the music of the Middle East, both before the civilization of classical Greece and during that of medieval Islam: in effect, it acquired the potential of being interpreted as 'missing links' in a world music history. The discovery of that missing link by scholars earlier in the century made possible the evolutionary treatment of music, replete with laws of classification and objective comparison of one music to another. **The study of music had clearly been converted into a science by the final decades of the nineteenth century, and non-Western music was unquestionably within the purview of that science**"³⁰⁴.

Although the "missing link theory" was addressed by many scholars before the 20th century, none of them was as prolific and engaged in proving this thesis as Henry George Farmer, the T. E. Lawrence of Arabian music³⁰⁵, who for decades tried to prove that it was the Arabs who brought Harmony to the Europeans:

"In the history of music, the Mediaeval Arabian art occupies a position between that of Byzantium and that of the

—
because of this from the enjoyment that music provides. There is no doubt [, however,] that our music is a nobler art; that it is the only Art" (in French: "consentons à reconnaître, tout en conservant notre orgueil de race, qu'il y a eu et qu'il y a encore des peuples conformés d'une autre manière, lesquels n'ont pas été pour cela privés des jouissances que procure la musique. Que la nôtre soit un art plus élevé; que même elle seule soit un art, cela n'est pas douteux").

³⁰³ [Bohlman, 1987, p. 159].

³⁰⁴ [Bohlman, 1987, p. 160–161].

³⁰⁵ Farmer's bibliography on the subject of Arabian music on the European music is extended (see [Cowl and Craik, 1999] for a complete survey of his life and works, and <http://special.lib.gla.ac.uk/exhibns/month/dec2005.html>), of which I may cite [Farmer, 1919; 1925a; 1925b; 1930a]. His major contribution in the field of Arabian music is his *History of Arabian Music to the XIIIth Century* [Farmer, 1929].

Renaissance of Western Europe. In this Arabian art we can discern the logical development of the homophony of the older Semitic peoples, the Greeks, and the Byzantines. Homophonic music possibly received its highest form of organization at the hands of the Arabs of the Middle Ages, and it is not improbable that the prompting towards the harmonic system of Western Europe came from the Arabs³⁰⁶.

Obviously, such a thesis aroused the objections of Occidental scholars³⁰⁷, while Arabian scholars of the 20th century welcomed it and tried to elaborate further and surf the wave³⁰⁸. Today, Farmer's thesis, a development of former speculations on the origins and evolution of Arabian music³⁰⁹, is still an object of polemics³¹⁰.

In parallel, comparative musicology slowly faded during the 20th century, and was replaced by what we call today "ethnomusicology":

"whereas the nineteenth century had produced more and more works of musical scholarship that chronicled an expansive history of music in a concerted way, the twentieth century experienced growing specialization, in which the music of non-Western cultures was examined within numerous disciplinary venues until the 1950s, when comparative musicology was largely supplanted by the

modern field of ethnomusicology with its diverse components from both the humanities and the social sciences. The myriad disciplinary paths of the present century notwithstanding, ethnomusicological thought in the nineteenth century was inseparable from the work of that century's foremost musical scholars³¹¹.

So the question that remains to be answered is now more or less clear: how did ethnomusicology, which is rooted in 19th (and early 20th) century musicology and comparative musicology, *i.e.* in two disciplinary fields based on the Evolutionary theory and Occidental supremacy, resolve the question of the "missing link" between the Ancient Greeks and its exclusive heir (18th-19th-centuries Europe), and which analytical tools were used in order to solve the problem of the "Arabian scale" and to which ends?

The following two chapters, addressing, for the first, the theories of scale generation, and, for the second, inclusive Hellenism³¹² in the 19th century, will be necessary to gather more data for the final discussion on generalized Orientalism and Hellenism in 20th-century musicology.

³⁰⁶ [Farmer, 1940, p. 3–4], cited in [Bohlman, 1987, p. 154].

³⁰⁷ The so-called "Arabian influence" (on European music in the Middle Ages) thesis was strongly advocated by Farmer, but even more refused by pro-Hellenist Scholars, especially Kathleen Schlesinger who went into a public academic dispute with the former (see for instance [Schlesinger and Farmer, 1925]). Whenever reciprocal influences between the two musics may not be denied, inserting Arabian music in an evolutionary process leading to Occidental polyphony (then harmony) is hazardous due to many factors, the least of which being our ignorance about both Arabian and European popular musics in those times (for the latter [Lang, 1953, p. 11]: "When probing into the music of the Middle Ages the first thing that strikes the student is the absence of folk and popular music. Until about 1300 such music is not even mentioned in any known document and we must advance well into the 14th century before we encounter more than traces of it. Curiously enough, the appearance of this folk art coincides with the rise of secular art music").

³⁰⁸ This re-Orientalizing trend is discussed in Chapter 5.

³⁰⁹ For instance by Lane in the 19th century, as explained in [Bohlman, 1987, p.150]: "Lane recognized [...] that the influences bearing upon Arabic music were extremely eclectic and could not be judged simply as stemming from the Greeks. By conjecturing instead that such influences may have originated in Central or South Asia, Lane suggested a line of historical reasoning that successive music historians would pursue and relate to the larger picture of universal history advanced by other disciplines".

³¹⁰ For a (fairly) recent survey and discussion of this thesis, see [Burstyn, 1990].

**

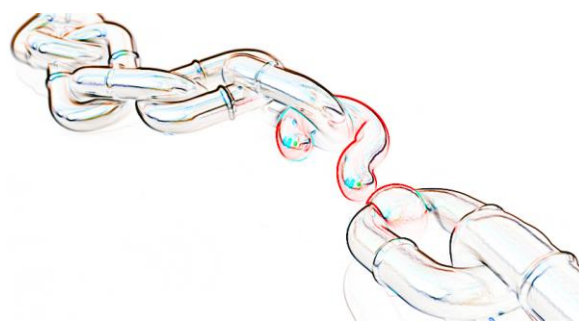

Fig. 38 The "Missing Link", adapted from the original³¹³.

³¹¹ [Bohlman, 1987, p. 162–163].

³¹² *i.e.* Byzantinism.

³¹³ Downloaded from [Mazza, 2013] (http://www.halogensoftware.com/uploads/blog/finding-the-missing-link-in-the-talent-gap/_thumb/848x450/the-missing-link-in-the-talent-gap.png).

3. “MUSICOLOGICAL” THEORIES ON THE FORMATION OF THE SCALE³¹⁴

“Music is a science which must have clear rules: these rules must result from a clear principle, and this principle can only be known to us through mathematics”
[Jean-Philippe Rameau, *Traité de l’harmonie*]³¹⁵

“Do you remember, sir, the story of the Silesian child who was born with a golden tooth, told by M. de Fontenelle? All the doctors of Germany burned themselves out in learned dissertations on how someone could be born with a golden tooth; the last thing that anyone thought of was to verify the fact; and it was found that the tooth was not golden”
[Jean-Jacques Rousseau, *Lettre sur la musique française*]³¹⁶

Music³¹⁷ is a privileged domain of arbitrariness, a trait most discernable in Occidental music theory, and even more in its applications for non-Occidental musics.

The first music theoreticians who tried to solve the “Oriental Enigma” of the scale had limited tools at

³¹⁴ The following appendices relate to this third chapter: 2. The “28 quarter-tones (in the octave)” of the Harmonicists, 4. About the “Resonance” theory.

³¹⁵ [Rameau, 1722, p. v]: “La Musique est une science qui doit avoir des règles certaines ; ces règles doivent être tirées d’un principe évident, et ce principe ne peut guère nous être connu sans le secours des Mathématiques”.

³¹⁶ [Rousseau, 1753, p. 1]: “Vous souvenez-vous, Monsieur, de l’histoire de cet enfant de Silésie dont parle M. de Fontenelle, & qui était né avec une dent d’or ? Tous les savants de l’Allemagne s’épuisèrent d’abord en savantes dissertations, pour savoir comment on pouvait naître avec une dent en or : la dernière chose dont on s’avisait fut de vérifier le fait, et il se trouva que la dent n’était pas d’or” – an English equivalent of this story would be: “One is reminded of King James and the Royal Society. He desired an explanation of the curious circumstance that when a fish is dropped into a pail of water it does not increase the weight. Various thinkers advanced ingenious theories, but it transpired that no one had made a preliminary test. In their zeal to please the august questioner the professors fulfilled his cynical hopes, and for once rose to the heights on which musical theorists habitually move” – from Bernard van Dieren’s *Down among the Dead Men* quoted in [Lloyd, 1945, p. 102].

³¹⁷ Along with music history and music theories.

their disposal. Later theoreticians developed a measuring procedure based on equal-temperament divisions; this allowed for better quantifications of intervals of scales and melodies, but the conceptual tools seemed to evolve with little satisfaction, as no unified solutions could emerge for, for instance, the “Indian” or the “Arabian” scales.

The reason for this deficiency lies partly in the heart of the tools used to analyze (and understand) such “Foreign” scales, *i.e.* in their inadequacy for the generation of melodic intervals, and partly in the failure – or in the unwillingness – to adapt these tools³¹⁸ to concepts differing from Occidental ditonism.

Thus, Occidental theoreticians³¹⁹ have spent most of their time like the German doctors, and found ditonism in the remotest places in the world, even where it had never existed before...

Equal-temperament and Pythagoreism, two struggling creeds of 18th-20th-centuries music in the West

There are two main theories for the musical scale, divisive or cyclical. The divisive theory can be used in two ways, either dividing the whole string³²⁰ in equal string parts (superparticular division), or using intervals with specific string (or frequency) ratios³²¹. Both procedures have been used by Ancient Greeks, together with the octave construction in two tetrachords plus a disjunctive (or “joining”) tone (Fig. 39).

Configuration	Distribution		
1 st config.	tetrachord (3/4)	disj.	tetrachord (3/4)
2 nd config.	tetrachord (3/4)	tetrachord (3/4)	disj.
3 rd config.	disj.	tetrachord (3/4)	tetrachord (3/4)

Fig. 39 The three typical configurations resulting from Ancient Greek concepts of the (octaval) scale³²².

³¹⁸ Whenever they could be adapted.

³¹⁹ And, later, their local followers – see Chapter 5 in this dossier.

³²⁰ Or pipe, etc.

³²¹ Most Early Arabian theoreticians used Pythagorean ratios along with the division of parts of the string, *i.e.* different string divisions at the same time – see Chapter 1 and FHT 16, p. 187.

³²² The first configuration, *i.e.* tetrachord + disjunctive tone + tetrachord, results from the 6 8 9 12 *tetraktys* (see Chapter 1).

Whenever it may be thought that Boethian Pythagoreanism prevailed in the Middle Ages³²³, the divisive process (in equal string – or pipe – parts) was also in use³²⁴, as well as the tetrachordal construction of the scale³²⁵.

Beginning with the seventeenth century, two “new” procedures came into light; the first, a cyclic procedure based on the Just fifth³²⁶, was thought of for Occidental Tonal music and became the basis of Western music theories and notations. This first procedure is a direct heir to Pythagorean ditonism. The second procedure was the result of scientific progress, and created a small revolution in music theories of the scale: it is the theory of Acoustic resonance³²⁷ with its

³²³ See Chapter 1.

³²⁴ See for instance [Sachs, 1949].

³²⁵ Most Middle Age constructions {beginning with Hucbald of Saint-Amand’s (c. 850-930) *De Harmonica Institutione* – translated in [Wingell and Hucbald (of Saint-Amand), 1971]} are heirs to the Pythagorean and, more generally, Greek musical tradition. Atkinson [2008, p. 118] points the connection between older treatises such as the *Musica enchiradiis* (see for example [Erickson and Palisca, 1995; Holladay, 1977]) and the oldest Medieval treatise, the *Musica disciplina* [Ponte and Aurelian (of Reome), 1961] or with the Byzantine *Papadikai*. Note also that Medieval authors such as Guido of Arezzo described modes with scales extending more than one octave (Guido of Arezzo is associated with innovations of the 11th century such as the notation staff, the Guidonian hand and the solmization syllables – see, notably, [Anon. “Guido d’Arezzo”, 2015; Bent et al., 2001; Gui d’Arezzo, 1993; Guido and Hermesdorff, 1876; Hughes and Gerson-Kiwi, 2001; Kiesewetter, 1840; Meyer, 1997; Seebass, 2000]); other theoreticians extended the scale up to two octaves, which was already the case in Boethius’ *De institutione musica* – for a digest on “modes” and Medieval theory, see [Powers et al., 2001].

³²⁶ Also called the “spiral of fifths”, or in a more restrictive way the “circle of fifths” when it is applied in an equal-tempered context (or when the fifths are adjusted in some locations to fit – Occidental – enharmonism, *i.e.* equality between $c^\#$ and d^\flat – for instance); the circle of fifth was described by Heinichen in *Der General-Baß* [Heinichen, 1728] (see [Drabkin, 2001]), and intended as an explanation of tonal relations in Occidental classical music (possibly influenced by Athanasius Kircher’s *Musurgia universalis* [Kircher and Viva, 1650] and Jean-Philippe Rameau’s *Génération harmonique* [Rameau, 1737], although the latter was published in 1737 – see [Buelow, 1966, p. 277]); its first appearance in Occidental literature may however be traced to Diletski’s *Grammatika* (written in the late 1670s – see [Jensen, 1992]). Lastly, the cycle of fifth may well have originated in China, where its existence is attested in the 4th century B.C. – see [Abramont et al., 2001, p. 512] and [Kuttner, 1964; 1965].

³²⁷ The theory went through a long string of adjustments beginning with (Descartes, Mersenne, then) Joseph Sauveur (see [Auger, 1948], notably [p. 326, footnote 1] – Sauveur probably introduced terms such as “Acoustics”, “Harmonic sounds” etc., as explained in [Truesdell and Campbell, 2001]) and Jean-Philippe

musical application, the Harmonic series³²⁸. This explanation of the Acoustical characteristics of sound was integrated in Music theories as a preliminary *exposé* on scale generation, although it contradicts the first procedure, the cycle of fifths. Both theories were used by Occidental music theoreticians to explain the process of scale formation.

The 17th century witnessed further a major³²⁹ advance in mathematics, the invention of logarithms³³⁰; applying this invention to music, it became possible to compute intervals on the basis of one very small interval, used as a unit of measurement³³¹. Whenever Pythagorean mathematics were based on interval ratios, logarithms allowed for an easier computation of intervals in equal-temperament³³², a completely “irrational” (in the Pythagorean sense) temperament which conflicted

→

Rameau (who made it the basis of his system – see his first eleven propositions, notably Propositions IV-XI, in [Rameau, 1737, p. 2–7]), before being reworked in the most elaborate form proposed by Hermann (von) Helmholtz in his *Lehre von den Tonempfindungen* (first edition in 1863 – the English version, translated, annotated and augmented by Alexander John Ellis, has been reedited a number of times, for instance [Helmholtz, 1895]).

³²⁸ A good introduction for these two topics may be found in Wikipedia [Anon. “Acoustic resonance”, 2016; Anon. “Harmonic series (music)”, 2016]; a short *exposé* of these and other procedures useful for the understanding of scale theories is proposed (in French) in the preliminary chapter of [Beyhom, 2010c].

³²⁹ At least for equal-temperament and tuning purposes, or for musicological research.

³³⁰ The process began in the Early 17th century (or even some time before) – for further details, see the well documented [Anon. “History of logarithms”, 2016].

³³¹ Beginning with Sauveur’s *heptameride* (301 *heptamerides* in one octave) till the cent (1200 cents in an octave) of Ellis’ *On the musical scales of various nations* [Ellis, 1885] {see also [Anon. “Cent (music)”, 2016], and [Ellis, 1876] in which the author introduces the cent, but also the “mil”, the “sem”, etc., and the appendix by the same author in [Helmholtz, 1895, p. 446–451]}; many other measuring intervals have been proposed (see for instance the “savart”, the “jot”, etc. in [Anon. “Savart”, 2016]), the cent being today the predominant unit of measurement of intervals.

³³² Equal temperament was already mathematically established by Chu Tsai-yü in 1584 in China, and for the first time in Western musical theory by Flemish mathematician Simon Stevin roughly (and, most probably, independently though inaccurately – see [Anon. “Simon Stevin”, 2016]) at the same time; the latter’s division of the octave remained however unpublished (and unknown) until 1884 – see [Kuttner, 1975], and [Anon. “Equal temperament”, 2016] for a historical retrospective of the establishment of equal-temperament.

frequently with Pythagoreanism and its sequels³³³. This conflict between (multiple³³⁴) temperaments was never really resolved, although equal-temperament seemed to have won the battle towards the second half of the 20th century³³⁵; its effects on music praxis had however started two centuries ago...³³⁶

Lastly, an Evolutionary theory of the scale, sometimes based on the Acoustic resonance theory and sometimes on different criteria (including the cycle of fifth), was also applied to “Primitive musics” to explain the process of the formation of the scale³³⁷.

The following sections will focus on demonstrating the shortcomings of these theories in what concerns melodic pitch generation, notably for “Oriental” scales³³⁸.

*The “superior structuring role” of the octave – Or do we really need it?*³³⁹

The octave, the “first concord” of the Greeks, plays a major role in music theories in the West, which is quite understandable considering the acoustic role of this interval. I have noticed however how the concept of non-octavial scales may in itself be disturbing for

³³³ See the section on Acoustic resonance below: this is one main reason for the invention of the so-called *Mercatorian* (later *Holderian*) *comma* (see [Holder and Keller, 1731, p.78–80] or [Beyhom, 2010c, v. 1, p.483]), which divides the Pythagorean tone in approximately 9 Holderian commas (and the Pythagorean *leimma* in 4), and the octave in 53 Holderian commas; this division, a convenient way for computing additive Pythagorean intervals, was notably used for the 19th-century Turkish theories of the scale.

³³⁴ During the Renaissance a number of different temperaments were in use – see for instance [Lindley, 2001a; 2001b], or Ellis’ appendix on temperament in [Helmholtz, 1895, p.430–441].

³³⁵ The appearance of electro-acoustical, then standardized electronic instruments (based on the MIDI interface) and computer music (composition) contributed greatly to the acceleration of the phenomenon.

³³⁶ [Lindley, 2001b, §8. “Equal temperament from 1735”].

³³⁷ The theory of Acoustic resonance was also used as an Evolutionary theory of the scale – I address this topic a little further in this chapter.

³³⁸ Alternatives to these theories have been highlighted in previous publications such as [Beyhom, 2010a] (“The principle of economy” – see the synthesis of the article) and [Beyhom, 2012] (the divisive principle applied to the *tunbūr* and to the *vīna* – determination of the scales of Shihāb-a-d-Dīn al-Ḥijāzī and Bharata Muni).

³³⁹ This discussion is an extension of [Beyhom, 2013, p.10 footnote 58].

some scholars, for the simple reason that a scale can be inconceivable without the presence of the octave³⁴⁰.

Whenever Western music of “Common practice” favors the (“just”) fifth and the (“major”) third as the most important features in this music, the (“Just”) fourth is mostly considered as a remnant of Ancient Greek theories, and of the “Middle Ages”.

All Western theories stress the role of the (“Just”) fifth as the “first concord”, a concept inherited from the pseudo-Pythagoreans, and most Western (and now Arabian and other) theoreticians and ethnomusicologists consider it as a prerequisite for any scale.

The fourth is considered to be less “consonant” and, even when this is completely out of context (for oriental melodies for example), as an inversion of the fifth.

Whenever the fourth is probably the key component of most maqām scales, in most complex (and notably zalzalian) melodic music the three main “concord”, the fourth, the fifth and the octave, play a guiding role for the performer. Not only are they not prerequisites for the scale or the melody, but seasoned performers often use strategies to circumvent these intervals to create original or simply pleasing variations in their music.

Moreover, the fourth/fifth construct triggers semi-tonal structures of the scale to the expenses of zalzalism (*i.e.* to the expenses of melodic expressivity)³⁴¹.

Whenever the octave may not be part of a scale, for example in a “Foreign” scale, an explanation must be found, one having been proposed by Curt Sachs in *The wellsprings of music*³⁴²:

³⁴⁰ See for instance [Higgins, 1838, p.168]: “A scale is a regular succession of notes which may be repeated to any number of octaves higher and lower, only limited by the compass of the instrument and the capability of hearing”.

³⁴¹ This and the former paragraphs are extensively explored in [Beyhom, 2010a].

³⁴² In the first chapter of *The Rise of Music* Sachs elaborates an Evolutionary theory of the scale based on a successive two-tones, three-tones, etc. basis for the melody, for instance [Sachs, 1943, p.31–32, 36]: “To the evolutionist, one-tone melodies as a first step before the use of two- and three-tone melodies would almost be too good to be true. But the question whether a primeval one-tone melody existed in pure form cannot yet be answered [...] *The earliest melodies traceable have two tones*. The two-tone style, in its narrowest form, comprises melodies pendulating between two

→

“Double fourths, usually descending³⁴³, can be paired in two different ways, either by ‘disjunction’ or by ‘conjunction’. In conjunction, the two fourths share one central note, which thus becomes at once the final of the upper and the starter of the lower fourth. The total range of the double fourth is a seventh or heptad. In disjunction, the two fourths are separated by a wholetone, and the total range is an octave. [...] In view of historical evidence³⁴⁴, especially from the Far East, India, and ancient Greece³⁴⁵, we can hardly doubt that conjunction marks an earlier phase of development than disjunction. Besides, conjunction shows a more limited planning: the performer considers one tetrachord at a time; and when the urge for enlargement creates another tetrachord, the new one starts where the first has left off³⁴⁶, without a dividing space between itself and the older fourth [...]. The two fourths are simply added, not integrated in any higher organization; [...] Disjunction acts in a very different way. The two tetrachords are placed a wholetone apart [...] because this distance integrates the two fourths in a higher organization: the octave”³⁴⁷.

Sachs had already expressed his views on tetrachordal/pentachordal construction in *The Rise of Music in the Ancient World, East and West*³⁴⁸:

“The logogenic³⁴⁹ melodies of two tones, and even of three tones, discussed in the first part of this section, were still

→

notes of a medium level, the distance of which is a second or less. [...] However,] two-tone melodies often exceed the distance of a second to reach a third or even a fourth”; he develops further this theory in *The wellsprings of music*: the criteria for this evolution are explained, in the quote *in texto* from *The wellsprings of music*, for the tetrachordal and pentachordal polychords.

³⁴³ Why should “double fourths” be “usually descending”? In *maqām* music, for instance, double-fourths are “usually ascending” in the beginning of a performance, reach a climax then return to the tonic (or “finalis” or whatever name should be more appropriate). While this is not a rule for all musics, Sachs’ use of the term “usually” while, as we shall see a little further, ruling out Middle Eastern music from a generalized theory of the formation of the scale is, to the least, surprising.

³⁴⁴ This evidence seems to be lacking, as Sachs does not provide a full survey of heptatonic music, far from that.

³⁴⁵ It is interesting that Sachs does not include Arabian (or “Middle Eastern”) music with these “Eastern” (and Greek) musics.

³⁴⁶ This is a purely theoretical (and unjustified) assertion by Sachs, as explained lower in the text.

³⁴⁷ [Sachs, 1962, p. 159–160]: this quote is taken from the beginning of Chapter 5, entitled “The Fate of Quartal and Quintal patterns”.

³⁴⁸ In the first chapter addressing the “Origins of Music”.

³⁴⁹ [Sachs, 1943, p. 41]: “The music considered so far is *logogenic* or word-born”; Sachs compares *logogenic* music to *pathogenic* and *melogenic* music thus: “But this is only one side of primitive music. For music is often due to an irresistible stimulus that releases the singer’s utmost possibilities. Not yet able to shape such pathogenic

→

beyond the notion of rational intervals. The singer, starting from an initial note, arbitrarily proceeded to the following one, much as a walker takes his steps without conforming to any rule except his ease. The space in between is a *distance*, which, though measurable in terms of Cents, does not obey any law of nature³⁵⁰. Most melodies exceeding the range of a third, on the contrary, tend to crystallize in certain intervals, that is, spaces determined by simple proportions of vibration numbers: the ratio 2 1, which we call the octave, 3 2, the fifth, 4 3, the fourth. The strongest magnetic power emanates from the fourth—for physiological reasons it is here best to accept without attempting discretionary explanations³⁵¹. Such magnetic attraction appears in two forms. In the first, notes approximately and unintentionally a fourth or a fifth apart spontaneously adjust themselves (with more or less success); four notes in a series of irrational seconds³⁵² submit to the law

→

music in premeditated longer patterns with the climax in the middle or at the end [...] Melogenic music represents the wide middle area between the extremes of logogenic and pathogenic music. Here, cantillation of words has sufficiently increased in range to reflect the pathos of the words themselves in a flexible melodic line...” – [Sachs, 1943, p. 41, 42]. In the *Wellsprings of music*, Sachs reconsiders the definition of *logogenic*: “I once coined the term ‘pathogenic’ or ‘passion-born’. The name is still to the point and has generally been understood. But I hesitate to continue calling the usual horizontal melody ‘logogenic’ or ‘word-born’” – [Sachs, 1962, p. 68].

³⁵⁰ Sachs could have added “as for today”: *emmelic* intervals follow definitively a logic in their succession and distribution, as well as in their relative sizes, as shown in [Beyhom, 2003a] and [Beyhom, 2010a].

³⁵¹ The theory of Acoustic resonance contradicts profoundly this statement, and I would surely have liked to have more explanations on this subject: why should the fifth, the first harmonic after the unison (fundamental sound) and the octave, be considered as less “magnetizing” as the fourth, and for which “physiological reasons”? This question is further addressed in the section “The Acoustic resonance theory”.

³⁵² This is a clear error in Sachs formulation, common in Occidental musicological literature and showing a profound bias in his treatment of music; in my first book on Arabian music I include a preliminary section explaining various mathematical procedures used in musicology, of which I propose here the following paragraphs (translated from [Beyhom, 2010c, v. 1, p. 37]) on “rational” and “irrational” numbers: “The definition of a ‘rational’ interval consists in the use of Integer numbers for the ratio expressing the interval (both terms of the ratio must be Integer numbers – see [Houzel, 1999]); [Crocker, 1963, p. 192] explains this thus: ‘Not all intervals can be [...] expressed [as fractions being ratios of integers]; many intervals, including all those drawn from our modern scale of 12 equal semitones to the octave, are « irrational » quantities having no exact expression in the realm of integers.’ Some musicologists qualify however Zalzalian intervals as being ‘irrational’ which is an outrageous position created, generally, by a fascination for Pythagorean mathematics or by *Just intonation*: as a matter of fact, all the intervals addressed by Early Arabian theoreticians (excluding

→

of the fourth and become a tetrachord; a melody of two consecutive thirds, the outer notes of which originally refer only to their common middle note but not to one another, turns into a pentachord, shaped to the size of a perfect fifth³⁵³.

I have published, a few years ago, a hypothesis about the formation of the heptatonic scale³⁵⁴, notably for modal and *maqām* music, in which similarities exist with Sachs' Evolutionary description³⁵⁵. My acquaintance with the latter music (and its theories) led me however to avoid some of the components of Sachs' proposition, which I address in the following³⁵⁶.

*
* *

There exists one main shortcoming in Sachs' theory³⁵⁷, which is the non-inclusion of *maqām* music in his proposition³⁵⁸.

Apart from this main lacuna, the specifically musicological problems I find in this theory are of two types, terminological and purely scientific. The scientific shortcoming is the failure to include the fifth

→ however Fārābī's formulation of Aristoxenos' divisions of the tetrachord) are defined by ratios of Integer numbers as for instance the 22/27 ratio (approx. 355 cents) or the 11/12 ratio (approx. 151 – the famous 'three-quarter-tones' interval). Note that Alexander Ellis, in his translation of Helmholtz' *On the sensations of tone*, defines 'irrational intervals' thus: '[Irrational intervals are intervals], strictly, having a ratio not expressible by whole numbers' – [Helmholtz (von), 1954, p.264]. The term 'irrational' is [however] sometimes used, in an abusive way, as a synonym for 'not part of the ditonic system': it seems that some authors do not hesitate to use this expression to underline the *alterity* (in relation to the Occidental Tonal system) of non-ditonic musics" – the quote in French is available in the book, downloadable at the address shown in the bibliography; see also [Perrett, 1931, p. 87–90] for a discussion on "irrational intervals" (and the intervals of Ancient Greek music).

³⁵³ [Sachs, 1943, p. 42–43].

³⁵⁴ [Beyhom, 2010a], notably in the Synthesis [p. 170-173].

³⁵⁵ Of which I was not aware at the time.

³⁵⁶ The *principle of economy*, my main theoretical contribution on the formation of heptatonic scales, is addressed notably in the aforementioned synthesis of [Beyhom, 2010a].

³⁵⁷ I am addressing here this theory as a "generative" theory of modal scales, and not pretending to propose a "general theory" of the origins of music of my own.

³⁵⁸ In fact, no mention of the Arabian system of *maqāmāt* is made by Sachs in *The wellsprings of music*, not to mention Arabian, Persian or Turkish musics, seldom cited concerning, mainly, instruments or rhythms.

as a "magnetizing agent" in the scale³⁵⁹; the terminology in question consists in the use of terms including "the superior structuring role of the octave"³⁶⁰ or "irrational intervals".

I also address below other, auxiliary issues which result from the above stated inventory.

*
* *

In *The wellsprings of music* Curt Sachs says:

"In describing non-western music, be it oriental or primitive, one must strictly refrain from misusing incongruous concepts of western music. The terminology that has been learned in music school applies to a harmonic structure of music and is inappropriate, indeed misleading and distorting in descriptions of non-harmonic, non-western music"³⁶¹.

Whenever I fully concur with this statement, it is difficult not to note the use of a specific terminology by the author when writing about "rational" or "irrational" intervals³⁶², a Pythagorean terminology related for the latter term to any interval that cannot be expressed as a ratio of two integers. Whenever such an opposition may be used in theories inspired from Ancient Greeks, other cultures, or more simply music praxis, impose on us to avoid this terminology when dealing with a theory of the origins of music, moreover when this theory is supposed to apply to all musics, and even more when it fails to include prominent characteristics of *maqām* music as addressed below³⁶³.

On the other side, considering that the inclusion of two disjunct tetrachords results in a "higher organization" of the scale, along with avoiding mentioning *maqām* music as an example for his theory, is a simplistic statement, significant of the bias of Sachs. In Sachs' thought, "higher organization" must be understood as "more complex", like in "a more complex life form"; the octave "organizes" its contents

³⁵⁹ Although I can be critical of too predominant a role for this interval in relation to non-Occidental modal music.

³⁶⁰ The quote is here slightly approximate, but helps summarize Sachs' thought in his theory.

³⁶¹ [Sachs, 1962, p. 49].

³⁶² And this, not forgetting that (almost) all intervals of second defined by Early Arabian theoreticians are presented as resulting from (or corresponding to) ratios of integer numbers – see [Beyhom, 2010c], Chapter I and footnote 352.

³⁶³ This terminological point is addressed and developed in [Beyhom, 2010c, v. 1, p. 37–38].

by structuring it in two tetrachords and a disjunctive (here central) tone³⁶⁴. Moreover, stating that “conjunction shows a more limited planning” and that, in this case, “the two fourths are simply added, not integrated in any higher organization” shows either a real ignorance of Middle Eastern modal music, *i.e.* *maqām* music, or the desire to ignore this music for the sake of his demonstration.

This statement disregards also the concepts of modulation and micro-modulations within a polychord or unlimited by the latter, of interwoven polychords, and many other characteristics of modal music, being structural characteristics or refinements of *maqām* music. Furthermore, the “spontaneous” adjustment of series of notes in a tetrachord³⁶⁵ excludes other possibilities as trichords³⁶⁶.

Moreover, by lessening the role of the fifth as a “magnetizing element” in the scale and, in the same sentence stressing the role of the fourth³⁶⁷, and amplifying the role of the disjunct tetrachords construct, Sachs favors³⁶⁸ the role of ditonism in the process of scale formation³⁶⁹.

³⁶⁴ Belgian musicologist Nicolas Meeùs, in his course of Medieval modality at the university of the Sorbonne (Paris – France) concurs with Sachs’ thesis and adds a purely Evolutionary statement: “During all of the Middle Ages, and until the Renaissance, the theory of musical systems is inhabited by a tension between the tetrachordal point of view, on which the modal system leant strongly, and the octavial point of view which became predominant in the 17th century” (in French: “Durant tout le Moyen Âge et jusqu’à la Renaissance, la théorie du système musical est habitée par une tension entre le point de vue tétracordal, sur lequel le système modal s’appuie fortement, et le point de vue de l’octave qui deviendra prédominant au XVII^e siècle”) – [Meeùs, 2005, p.18]. Meeùs avoids in this course (intended for “beginners”, *i.e.* not detailed) any mention of a possible connection between (Occidental) Medieval music theory and Byzantine treatises, and bases his explanations on the transmission of Ptolemaic-Pythagorean Greek theories through Boethius directly to Medieval Europe.

³⁶⁵ “[F]our notes in a series of [...] seconds submit to the law of the fourth and become a tetrachord”.

³⁶⁶ I could not find any mention of trichords in both here cited Sachs’ books.

³⁶⁷ In many modes of *maqām* music, the criteria of “Just” fourth or fifth (or octave) are not applicable, although these intervals play a guiding role for the musician – see “The principle of economy” in [Beyhom, 2010a].

³⁶⁸ Perhaps unconsciously.

³⁶⁹ For the simple reason that such an inclusion is a factor of amplification of ditonism – see for instance the results of the inclusion of a disjunctive tone on the composition of the fifth in

There are multiple examples in Middle Eastern modality which do not conform to Sachs’ theory – including trichordal and pentachordal polychords – of which I chose to present two in this dossier, the (particular case of the) scale(s) of *maqām Ṣabā* (Fig. 40 and Fig. 41)³⁷⁰ and (more generally) the variety of non-octavial scales in Arabian music³⁷¹.

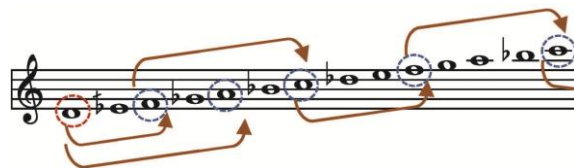

Fig. 40 The ascending scale of *maqām Ṣabā* according to modern theories of the scale (here in Erlanger’s), showing the polychordal structure and rest notes³⁷².

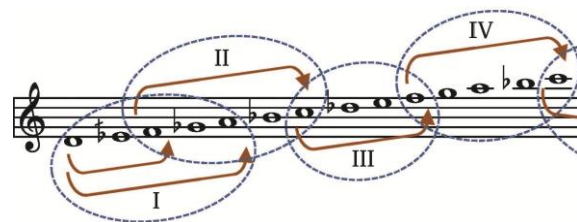

Fig. 41 The ascending scale of *maqām Ṣabā* according to modern theories of the scale, showing the polychordal structure and chronological execution³⁷³.

The (theoretical) ascending scale of *maqām Ṣabā*³⁷⁴ includes a starting trichord *bayā*³⁷⁵ $d e^{1/2} f$, chronologically followed by a *ṣabā* pentachord $d e^{1/2} f g^b a$.

Lebanese theoretician Salim al-Ḥilū proposes a slightly different version with a structure made of interwoven tetrachords and disjunctive tones. This

→ [Beyhom, 2010a, p. 196, Fig. 35], and explanations in the text of the same article.

³⁷⁰ See the complete scale in FHT 19 and FHT 20, p. 189.

³⁷¹ Of which the scales of *maqām Ṣabā* are an integral part.

³⁷² Excerpt from the complete FHT 19.

³⁷³ Excerpt from the complete FHT 20.

³⁷⁴ *Maqām Ṣabā* is a popular mode in both Art and Popular musics of the Middle East. Many traditional tunes such as *Skābā*, *Marmar Zamānī*, are based on this *maqām*, one of the ten most used *maqām*(s) in the repertoire. Another such popular *maqām* with similar properties (but octavial) is *maqām Sīkā-Huzam* (or *Sīkā-Khuzām*) with the ascending scale $e^{1/2} f g a b^{1/2} c d e^{1/2}$.

³⁷⁵ I use capitalized first letters for *maqāmāt* (Middle Eastern modes), and no capital letters for the *ajnās* (*genera*, with *genus* = *jins*) and other polychords; names for degrees of the scale are fully capitalized.

shows the complexity of this *maqām* for the (Art) performer, and the difficulty in theorizing it³⁷⁶.

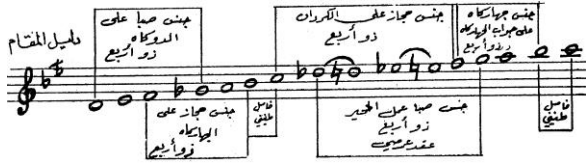

Fig. 42 (Al-) Ḥilū's notation of *maqām Ṣabāʾ*'s ascending scale, with a tetrachordal *jins hijāz* in lieu of a pentachordal *hijāz* based on *f*³⁷⁷.

The acknowledged characteristic formula for this *maqām* follows the latter notation, as it uses the following suite of notes³⁷⁸: $d e^{♭} f g^b f e^{♭} g^b f e^{♭} f, g^b f e^{♭} d$, in which the first d is the starting point of the formula, f (in bold) before the comma a resting point, and the final d a provisional finalis. The reader will note that this formula, which comprises a series of four successive notes (from d to g^b), does not span a Just fourth, but what Occidental music theory calls a “diminished” fourth. Neither does the Just fourth appear at any moment between d and g^b ³⁷⁹.

Furthermore, the “next” polychord to be performed is a pentachord $f g^b a b^b c$ based on a *hijāz* (chromatic) tetrachord $f g^b a b^b$ and which, whether in theory or in praxis, is never (the pentachord) conceived as a succession of “consecutive thirds” centered on “their middle tone”.

³⁷⁶ But also the (probable) influence of Occidental musicology (the disjunctive tone between a and b) on later theoreticians such as Ḥilū; there are other still, alternative and contemporary notations (beginning generally with the 1990s) of this *maqām*'s scale(s) which, influenced by the Occidental stress on the octave, have replaced the upper d^b with a plain d . The following notation, taken from [Ghulmiyya, Kīrbāj, and Farāḥ, 1996, v. 5, p. 22] and with “tetrachords” separated by a “disjunctive one-and-a-half-tone” interval, is probably the most extreme example of acculturation (and, in this particular case, of incompetence) of Arabian theoreticians up to the present time:



³⁷⁷ [Ḥilū (al-), 1972, p. 122].

³⁷⁸ Note that this is a formula stripped from all ornamentation, fluctuations, and modulations: even in such a short span, most good musicians (and singers) of *maqām* use multiple procedures in order to personalize their performance or style – listen to two examples of *maqām Ṣabā* on Slide No. 39: the typical formula (by Jihad Chemali, example No. 11) and the complete *maqām* development by Saad Saab (example No. 12).

³⁷⁹ Except perhaps in non-traditional modulations.

Moreover, the complete ascending scale of this *maqām* does not include a Just octave³⁸⁰, neither is it structured with a disjunctive tone, and is very complex in its correct interpretation while requiring a full comprehension of the repertoire in its performance.

To summarize the inventory above: no tetrachordal structure with a disjunctive tone, no Just fourth or Just octave, overlapping polychords, unbalanced pentachords, to which we may add numerous other examples of *maqām*(s) comprising one or more of these features, modal complexity and “superior” organization in time despite the above stated characteristics (by Sachs), and, additionally, a total of 20 non-octavial *maqām* scales³⁸¹, namely: ‘*Ajam-Ushayrān* [E14], *Ṭarḥ-Jadīd* [E15], *Shawq-Afzā* [E16], *ʿIrāq* [E18], *Awj* [E19], *Farāḥnāk* [E20], *Dīlkash-Ḥawrān* [E21], *Bastā-Isfahān* [E22], *Rāḥat-al-Arwāḥ* [E23], *Bastā-Nikār* [E24], *Rawnaq-Numā* [E25], *Dūkā* [E52], *Ṣabā* [E78], *Ṣabā-Zamzamā* [E80], *Ṣabā-Kurdī* [E87], *Shiʿār* [E115], *Ṣabā-Būsālīk* [E104], *Huzām* [E109], *Ramal* [E112], and *Wajh-ʿArḍībār* [E113]³⁸², all these show plainly why Sachs, a musicologist familiar with Middle Eastern musics³⁸³, did not include the latter in his theoretical thought...

³⁸⁰ The octave appears generally when modulating near the octave (upper d) and using again the *jins ṣabā* there.

³⁸¹ Out of 119 described by Erlanger alone, and not including other non-octavial *maqāmāt* described by other theoreticians.

³⁸² With a few other examples by other theoreticians shown in [Beyhom, 2003b, p. 61–64] – the code between square brackets follows Erlanger's nomenclature and description of the modes in [Erlanger, 1949; 2001b].

³⁸³ Curt Sachs and Béla Bartók were participants in the 1932 Congrès du Caire for Arabian music, in which they had a conservative attitude as to the inclination of some Arabian composers towards the “modernization” (understand occidentalization) of Arabian music. It is for this conference that Erlanger and his team prepared the analytical notation of scales which were published, firstly in the Book of the conference, in Arabic [Collectif, 1933] and in French [Collectif, 1934], and secondly in [Erlanger, 1949]. Sachs presided the “Commission for music Instruments” (he was also a member of the “Commission for music Education”) and published an article about the conference in 1933; other musicologists like Erich (von) Hornbostel, Robert Lachmann (president of the “Commission for Recordings”) and Egon Wellesz, Henry George Farmer, Carra (de) Vaux, Alexis Chottin and Alois Hába took also part in the conference; Paul Hindemith was invited as an observer – see [Vigreux and Hassan, 1992, p. 26–27, 32, 45, 49], and the same reference [p. 279–281] (and more specifically [p. 281]) in which the well-known Egyptian composer (and modernist – see [Anon. “Dāwūd Ḥusnī”, 2016; Anon. “Dāwūd Ḥusnī (1870–1937)”, 2016]) Dāwūd Ḥusnī criticizes Sachs for not having had an

The least we can say in conclusion is that this theory has many *lacunae*, and cannot apply as is to *maqām* music, which makes it unsuitable as a theory of the origins of music(s), or as a generalized theory of the formation of the scale³⁸⁴.

The cycle of fifths

First introduced in European theory in 1679 by Nikolay Diletsky (Fig. 43), the cycle of fifths³⁸⁵, a well-known procedure in Ancient China (Fig. 45)³⁸⁶, is used in Western music literature as an auxiliary for key correspondences in music notation, but also as a generative procedure for the (Occidental – ditonic based) scale.



Fig. 43 Diletsky's circle of fifths³⁸⁷.

European musicologists, especially French-speaking theoreticians of the scale and historians of music such as François-Auguste Gevaert, aimed in the 19th century to use this theory as a “Universal” generative theory of the scale (see Fig. 44):

→ interest in Arabian “Art music” during his stay and in his technical report.

³⁸⁴ Moreover: note that Sachs did not consider, in this theory, the alternation of scalar melodic elements (for example *genera*) around the “tonic” (or “finalis”); in such case, “closing” the octave would emphasize the role of the fifth, either upwards or downwards (see for instance [Beyhom, 2010a] in which I expound this procedure as a possible component of heptatonic scale elaboration).

³⁸⁵ See footnote 326 for the gradual introduction of the “Cycle” (or “Spiral”, or “Circle”) of fifths in Western music theories.

³⁸⁶ See [Kuttner, 1964 ; 1965].

³⁸⁷ Detail; source: [Anon. “Diletsky_circle.jpg (Image JPEG, 857 × 1143 pixels) - Redimensionnée (44%)”].

“This type of scale generation [the Cycle of fifths], characteristic of all known musical systems, does not imply an exact determination of the numerical ratios of the intervals”³⁸⁸.

† Tous les sons employés dans notre système musical sont les chaînons d’une progression de trente quintes. Si l’on dispose en échelle sept sons consécutifs de cette progression, on voit se former l’ordre diatonique dans lequel les demi-tons sont alternativement séparés par deux et trois sons. Les éléments d’une gamme chromatique se tirent d’une série de onze quintes, où la tonique peut tenir la 6^e, la 5^e, la 4^e, la 3^e ou la 2^e place. Pour le ton d’ut, par exemple, on aura le choix entre une des cinq séries :

- 1) ré ♮ la ♭ mi ♭ si ♭ fa ut sol ré la mi si fa ♯ ut ♯
- 2) la ♭ mi ♭ si ♭ fa ut sol ré la mi si fa ♯ ut ♯
- 3) mi ♭ si ♭ fa ut sol ré la mi si fa ♯ ut ♯ sol ♯
- 4) si ♭ fa ut sol ré la mi si fa ♯ ut ♯ sol ♯ ré ♯
- 5) fa ut sol ré la mi si fa ♯ ut ♯ sol ♯ ré ♯ la ♯

Cl. BARBEREAU, *Études sur l’origine du système musical*. Paris et Metz, 1864. — Ce mode de génération des échelles, propre à tous les systèmes musicaux connus, n’implique pas la détermination exacte des rapports numériques des intervalles.

Fig. 44 The cycle (circle) of fifths as proposed in a note by Gevaert³⁸⁹.

Jacques Chailley, a 20th-century theoretician of the scale and an influential and prominent French musicologist³⁹⁰, patched together an Evolutionary theory of the formation of the scale³⁹¹ also based on

³⁸⁸ Translation of the final note in Fig. 44.

³⁸⁹ [Gevaert, 1875a, v. 1, p. 270]: the whole construct needs “a progression of 30 fifths”. The initial construct comes from [Barbureau, 1864] (a complemented edition of the initial [Barbureau, 1852], in which the author never uses the terms “cycle”, “spiral” or “circle”, but often “series of fifths”).

³⁹⁰ Notably in the fields of the music of Antiquity and of the Middle Ages (see [Chailley, 1950 ; 1956 ; 1960 ; 1979 ; 1985a]); the current research addresses other writings from this author, who was the head (and the founder in 1969-1970) of the Faculty of music and musicology in the université Paris-Sorbonne from 1969 to 1973, and taught there until 1979 (more in [Anon. “Jacques Chailley”, 2016 ; Universalis, 2016]). There has been recently a controversy about Chailley’s presumed role at the Conservatoire de Paris during the German occupation in the Second World War (see for instance [Anon. “Jacques Chailley (1910-1999)” ; LA LETTRE DU MUSICIEN 401, 2016]).

³⁹¹ Chailley’s theories, based on typical Occidental biases about the Western scale, have influenced generations of (European and Foreign) French speaking musicologists till the present day. This particular theory was still used in the late 20th century by eminent musicologists such as Annie Labussière in her theory of “*geste mélodique*” (“melodic gesture”), or in his teaching of “Arabian(!) music” (as I was informed by him in person during a stay in Cairo in 2007 for a conference on Arabian music) by fr. Elie Keserwani, former head of the Faculty of musicology of Notre-Dame university (NDU) in Louaizeh (Lebanon) and a graduate (with a Ph.D. thesis) from the Paris-Sorbonne university (former Paris-IV). Labussière notably uses Chailley’s theory of successive “ditonic”, “tritone”, etc., scale degrees generation (explained below in the text) in [Labussière, 1997] (see [p. 85]) in which she also, states (in [Labussière, 1997, p. 86]), for instance, that “With regard to melody the fourth, unstable on its upper boundary, resolves on its lower boundary” (in French “*Méлодиquement, la quarte, instable sur sa borne supérieure, trouve sa résolution sur sa borne grave*”, which agrees with Curt Sachs’ scheme of the “falling fourths” in his theory expounded in the previous section of this chapter.

the cycle of fifths, and pursued its development for decades³⁹².

The main elements of Chailley's theory are explained in his article "Essai sur les structures mélodiques"³⁹³, from which I retain the following quotes for our discussion:

"The formation of musical scales, which organize themselves progressively and spontaneously in systems, then in modes³⁹⁴, seems to be subject to the interferences of two essential and conflicting principles:

1° a principle of stability, *consonance*, expressed by the well-known table of harmonics. [...] [This table] intervenes however, **undoubtedly and**, at the beginning, **unconsciously**, through the *cycle of fifths*³⁹⁵ [...].

2° a principle of dynamism and mobility, the *attraction*, which expresses itself by *displacement of degrees* in the direction of the melodic slope and by *the attraction of the weaker degrees by the stronger degrees* (the strength of the degrees depending mainly on [the phenomenon of] consonance).

[...] To the interaction between these two fundamental principles add themselves secondary phenomena[:]

3° *tolerance*, which admits, in various ways depending on society and people, the subjective assimilation of approximate sounds to [equivalent] strictly exact sounds. Furthermore, tolerance is subject to external influences [... such as]: pitch, timbre, sound dynamic, etc.

4° *equalization*, fostered by tolerance. [Equalization of intervals] can be either instinctive, or on the contrary the result of the rationalism of higher civilizations; [the latter] will readily apply corrections to real facts to make them coincide with rational diagrams"³⁹⁶.

³⁹² See for instance [Chailley, 1959; 1967; 1985b].

³⁹³ "Essay on Melodic structures".

³⁹⁴ Should we understand here that scalar modality preceded formular modality? That mathematical ratios imposed intervallic structures and exact measures before a "primitive" singer hummed a few notes?

³⁹⁵ Note that, although the scientific principle, the Acoustic Resonance Theory, is cited first, it is already in this first paragraph subordinated "undoubtedly and unconsciously" to the "Cycle of Fifths" with which it has nearly nothing in common.

³⁹⁶ [Chailley, 1959, p. 139–140]; the complete French quote is the following: "La formation des échelles, qui s'organisent progressivement et spontanément en systèmes, puis en modes, semble soumise aux interférences de deux principes essentiels et contradictoires: 1° Un principe de stabilité, la *consonance*, qui s'exprime par le tableau bien connu de la résonance (harmoniques). Mais ce tableau n'est que très exceptionnellement utilisé sous sa forme brute. Il n'intervient, au début du moins, et sans doute de manière non raisonnée, que dans ses manifestations premières, qui, ne mettant en action que les rapports fournis par ses deux premières tranches, se traduisent essentiellement, pour la mélodie du moins, par le *cycle des quintes*. La tierce, en tant qu'harmonique 5, ne s'y intègre que tardivement et c'est plus

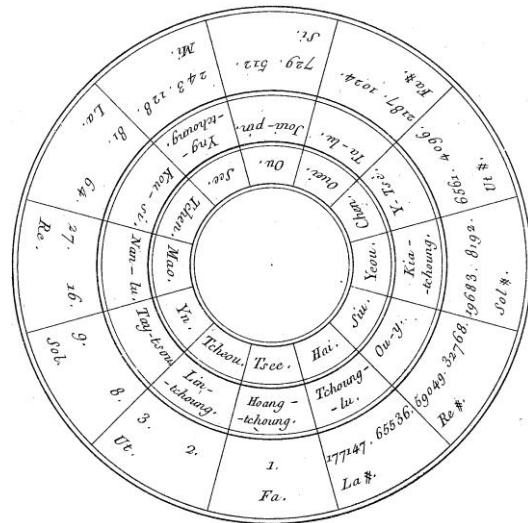

Fig. 45 The chinese circle of fifths showing the generation (and ratios) of the successive twelve *liu*(s) according to Amiot³⁹⁷.

We have here, in short, all the ingredients of Chailley's theory: the Acoustic resonance and Pythagorean mathematics as (conflicting) scientific "truths", and the ingenious *tolerance* and *equalization* processes which arbitrarily "correct" the lacunae and discrepancies between those two theories, forcing thus praxis to comply with theoretical "science"³⁹⁸.

tardivement encore qu'interviennent parfois, sous des réserves très strictes, les harmoniques suivants. 2° un principe de dynamisme et de mobilité, *l'attraction*, qui s'exprime par des *déplacements de degrés* dans le sens de la pente mélodique et par *l'attraction des degrés faibles par les degrés forts* voisins (la force des degrés dépendant principalement de la consonance). C'est parce que n'entre pas en jeu un principe unique, mais deux au moins, que, sur des bases de départ identiques, ont pu se développer dans le temps et dans l'espace les langages les plus différenciés, dont cependant les lois peuvent être réduites à des principes communs. Au jeu des multiples réactions entre ces deux principes fondamentaux vient se mêler celui de phénomènes secondaires. 3° la *tolérance*, qui admet, d'une manière variable selon les sociétés et les individus, l'assimilation subjective de sons approximatifs aux sons rigoureusement exacts. La tolérance est en outre influencée par des facteurs externes que l'on commence à étudier méthodiquement: hauteur, timbre, intensité etc. 4° *l'égalisation*, favorisée par la tolérance. Elle peut être soit instinctive, soit au contraire issue du rationalisme dans les hautes civilisations; celles-ci n'hésitent pas en effet à corriger des faits réels pour les faire coïncider avec des diagrammes rationnels".

³⁹⁷ Plate XV in [Amiot, 1779].

³⁹⁸ As Rameau once stated: "Music is a physic-mathematical science: sound is its physical object, ratios found between sounds make them its mathematical object" – [Rameau, 1737, p. 30]; but what about the "equalization" process, should it also be considered as part of the "science of music"? This is an ongoing discussion since the Aristoxenian-Pythagorean quarrel, but

* * *

Before addressing separately³⁹⁹ the “Acoustic resonance” theory, I propose here to pursue our examination of Chailley’s generative theory:

“Any [musical] structure predating the three-sound Harmony invasion is the result [...] of a series of interfering together forces, of which one of the most powerful is the cycle of fifths:



Fig. 46 Chailley’s illustration of the ditonic scale as a result of a cycle of fifths (“Table 1”)⁴⁰⁰.

resulting exclusively from group 1-4 of [Acoustic] resonance

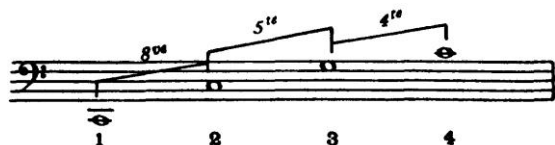

Fig. 47 Chailley’s illustration of “group 1-4 of [Acoustic] resonance (“Table 2”)⁴⁰¹.

through the use of its three elements: 8^{ves} (1-2) 5th (2-3) and 4th (3-4). Limited, until further notice, to the first 7 sounds⁴⁰², it gives birth to the *diatonic* [ditonic] *genus*. The table of fifths [“Table 2” above] follows the same degressive principle in [the] structure formation [scheme] as the table of [Acoustic] resonance [...]. Depending on whether groups 1-2, then 1-3, then 1-4 etc., are used, the results are successive structures of the octave in which intervals shaped earlier maintain a supremacy proportional to their anteriority. At every stage of this formation [process], we get a different system [...] the degrees of which lean on the formerly shaped ones⁴⁰³.

→ distorting physical and mathematical facts with *tolerance* and *equalization* just to fit them in the ditonic system cannot lead us to a better understanding of the formation of the (melodic) scale.

³⁹⁹ In the next section.

⁴⁰⁰ [Chailley, 1959, p. 141].

⁴⁰¹ [Chailley, 1959, p. 141].

⁴⁰² An interesting limitation, whenever the cycle of fifths is extended well above this boundary (for “chromatic” degree of the scale).

⁴⁰³ [Chailley, 1959, p. 141]; the original French quote is: “Toute structure antérieure à l’envahissement de l’harmonie à 3 sons est issue, selon un processus que nous avons essayé ailleurs d’expliquer, d’une série de forces interférentes dont l’une des plus puissantes est, on l’a dit, le cycle des quintes: [here “Table 1” – Fig. 46] issu exclusivement de la tranche 1-4 de la résonance [“Table 2” – Fig. 47] par utilisation de ses trois éléments: 8^{ves} (1-2) 5^{ie} (2-3) et 4^{ie} (3-4). Limité jusqu’à nouvel ordre aux 7 premiers sons, il donnera naissance au genre diatonique. Le tableau des

Chailley proceeds then⁴⁰⁴ to illustrate each of the successive “scales”, namely the “ditonic”, “tritonic”, “tetratonic”, “pentatonic”, etc., scales⁴⁰⁵ which I shall not detail here (see Fig. 48 for the first generations of tones)⁴⁰⁶.

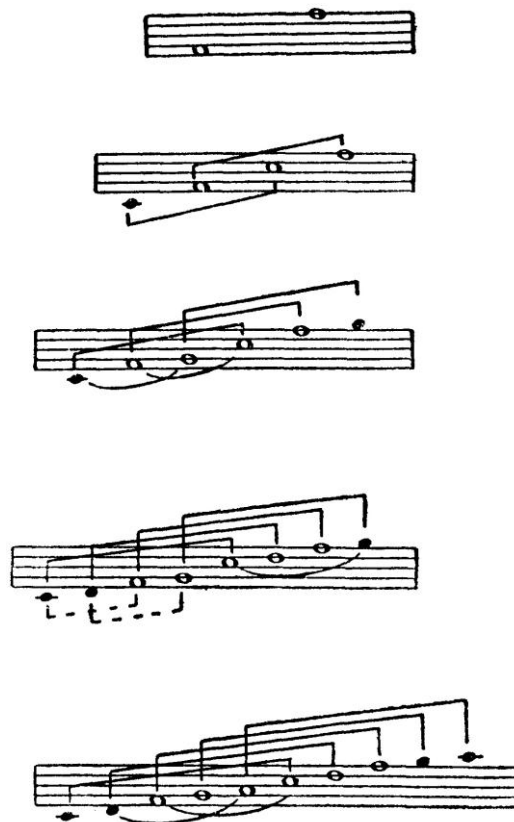

Fig. 48 Detail from Chailley’s “Tableau 3”⁴⁰⁷ explaining his generative theory⁴⁰⁸.

→ quintes obéit au même principe de dégression dans la formation des structures que le tableau de la résonance dans l’évolution de la consonance [...] Selon que l’on utilise ses tranches 1-2, puis 1-3, puis 1-4 etc., on obtient des structures successives de l’octave dans lesquels les intervalles les plus tôt formés conservent une suprématie proportionnelle à leur antériorité. À chaque stade de cette formation, on obtient un système différent [...] dont les degrés nouveaux s’appuient sur les degrés antérieurs”.

⁴⁰⁴ [*idem*, p. 142].

⁴⁰⁵ The reader can deduce these scales from phases 2, 3, 4, 5, etc., of Chailley’s “Table 1” (Fig. 46).

⁴⁰⁶ The remaining part of Chailley’s article addresses the inclusion of Western harmony in his scheme and various other elements, mainly how his theory “explains” the evolution of Occidental music, an evolution from which he excludes [p. 173-174] dodecaphonism and serialism.

⁴⁰⁷ [Chailley, 1959, p. 142].

⁴⁰⁸ The first staff gives the octave, the second “ditonic” staff reproduces “two aspects (with three pitches) of the octave”, the

As a generative theory based on the Pythagorean (or the Acoustic resonance) fifth⁴⁰⁹, the cycle of fifth gives an ingenious explanation of the Occidental ditonic scale, but fails, when scrutinized for consistency, as both a particular or a general theory of the scale in a number of crucial points.

SHORTCOMINGS OF THE THEORY OF THE CYCLE OF FIFTHS AS A PARTICULAR THEORY OF THE FORMATION OF THE OCCIDENTAL TONAL SCALE⁴¹⁰

Firstly, the cycle of fifths as is (i.e. without the “conflicting interference”⁴¹¹ of the theory of Acoustic resonance, or of equal-temperament) never closes up on the octave of the first generative sound (Fig. 49)⁴¹², with a generating sound arbitrarily chosen as *f* (as in most explanations of this “circle”) the series of the first 12 ascending fifths would be the following:

f → (1) *c* → § (2) *g* → (3) *d* → § (4) *a* → (5) *e* → § (6) *b* → § (7) *f*[#] → (8) *c*[#] → § (9) *g*[#] → (10) *d*[#] → § (11) *e*[#] (*f*?) → § (12) *b*[#] (*c*?)⁴¹³,

in which *e*[#], generated by the 11th fifth (and after 6 ascending octaves) will never be equal to *f* (six octaves higher than the original generator *f*)⁴¹⁴, or any of the following generated sounds be equivalent to one of the seven degrees of the ditonic scale generated by the first 7 ascending fifths⁴¹⁵.

→ third “tritone” staff “3 aspects of the octave” and “2 aspects of the fifth” while “2 aspects of the fourth” are additionally generated in the fourth “tetra-tonic staff”, etc., till the “hepta-tonic staff” – the “octo-tonic generation” (with *f*[#]) is, with further generations and according to the author (in [Chailley, 1959, p. 144]), not to be found in music as “the cycle of fifths ends after [generation] No. 7”

⁴⁰⁹ The initial choice is irrelevant to the following explanations.

⁴¹⁰ This section is here extended from Version 1 of the dossier.

⁴¹¹ According to Chailley as quoted above.

⁴¹² And this is obviously why the presence of the theory of Acoustic resonance and of the “equalizing” procedure is essential in Chailley’s theory.

⁴¹³ In which 1) “§” marks an (ascending) octave change (with *f* as the reference note), and 2) octaves background colours are alternated – the successive sounds are reproduced as sine waves (with 4 harmonics with decreasing intensities per steps of approx. 20 dBs) in Slide No. 43.

⁴¹⁴ The difference is one Pythagorean *comma*, about 23.5 cents, with ratio 531441:524288. Note also that the last fifth generates a sound (*b*[#] above) with pitch (if the first *f* is chosen per convention at 100 hz, a reasonable bass sound) at 19461.95 hz, completely inaudible for the author.

⁴¹⁵ All these remarks also apply in the case of a cycle of alternation of fifths and fourths (or a scheme of successive ascending fifth

In other terms, the fifth of ratio 2/3 (whether Pythagorean or resonantial, “Just” or “Pure”) and measuring (approximately) 702 cents, when added to itself (her ratio being multiplied by itself) any number of times will never be equal to a power of the ratio 1/2;⁴¹⁶ the only possibility for closing this cycle (which becomes a circle) requires the use of equal-temperament (Fig. 50), or the adjustment (tempering) of a number of fifths composing the cycle⁴¹⁷.

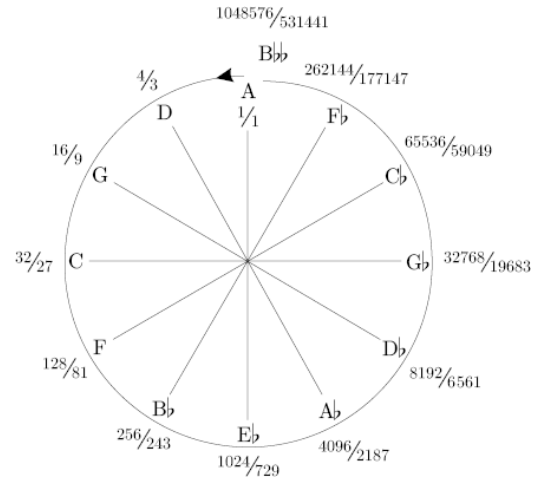

Fig. 49 Descending spiral of fifths⁴¹⁸.

Secondly, and in order to create the Occidental ditonic scale based on *c*⁴¹⁹, this theory must begin with a generating sound arbitrarily (and necessarily) chosen as *f* (Fig. 50), generating thus an *f* ditonic scale (or *f g a b c d e*) with a just fifth between the tonic *f* and the fifth degree *c*, but with a tritone *f-b* instead of a just fourth. This compels theoreticians to “subtleties” in notating the cycle of fifths (Fig. 51), which do not, however, resolve the conflict.

→ followed by a descending fourth – or *vice versa*) which I shall not address here.

⁴¹⁶ The mathematics for such a demonstration are relatively simple: an integer power “n” of the fifth (i.e. $(\frac{2}{3})^n$) can never be equal to an integer power “m” of the octave (i.e. $(\frac{1}{2})^m$) as shown by the following: $(\frac{2}{3})^n = (\frac{1}{2})^m \rightarrow \frac{2^n}{3^n} = \frac{1^m}{2^m} \rightarrow 2^{n+m} = 3^n$ which is impossible (in classical mathematics) because $3^n \neq 2^{n+m}$ as 3^n (or any integer power of 3) will always be an odd integer whenever 2^{n+m} (or any integer power of 2) will always be an even integer.

⁴¹⁷ See [Drabkin, 2001].

⁴¹⁸ Source: [Anon. “Chrysalis Foundation – Musical Mathematics: Safi Al-Din and Bartolomeo Ramis”].

⁴¹⁹ i.e. *c d e f g a b*.

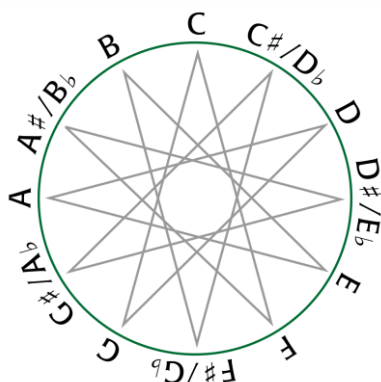

Fig. 50 The circle of equal-tempered fifths represented with a “star” configuration⁴²⁰.



Fig. 51 12 alternated ascending fifths and descending fourths within the ambitus of one octave⁴²¹.

Extending the series up and down (see Fig. 44) is an ingenious procedure, but this would then state that the main Occidental scale generated by the cycle of fifths is a plagal *f* scale⁴²² which is far remote from Western tonal theory⁴²³.

ADDITIONALLY: COMPLETE INADEQUACY OF THE THEORY OF THE CYCLE OF FIFTHS AS A GENERALIZED THEORY OF THE FORMATION OF THE SCALE

Apart from the fact that, as a generalized generative procedure for the scale, the cycle of fifths would require a significant number of successive fifths in order to generate a differential enharmonic *diesis*⁴²⁴ (around 25 fifths for a differential quarter-tone⁴²⁵), there is no single example of a melody which would

⁴²⁰ Source: [Anon. “File:Pitch class space star.svg”]. To reproduce the progression beginning with *f* (here “F”), take the first line from “F” to “C” then follow the broken line to “G”, “D”, etc. Beginning with “C” gives for the sixth generation “F[#]” (generated from “B” and equated with “G^b”) which fails in reproducing the notes of the *c* major scale (itches are equivalent to those of a generation beginning with *f*, but notes must be altered when beginning with *c*).

⁴²¹ Source: [Anon. “File:Circle of fifths ascending within octave.png”].

⁴²² *i.e.* centered on a “tonic” *f* but beginning with the lower *c*.

⁴²³ But not from other theories such as Ancient Greek or Byzantine chant theories.

⁴²⁴ A *sine qua non* condition for “Oriental” *maqām* scales.

⁴²⁵ Simply computed as the ratio of the quarter-tone in cents on the difference (in cents also) between a just fifth and a tempered fifth, *i.e.* 50/(701.955-700) = 25.6.

ascend for 6 octaves to close the (octavial) scale⁴²⁶, *i.e.* to enunciate the complete set of degrees of the (here ditonic) scale, neither is there any single example of traditional, melodic or not, music with singers (or even instruments) capable of such a prowess⁴²⁷, moreover with a continuous series of fifths.

Furthermore, using container intervals, here the fifth (and the octave, or even the fourth) as paradigms for melodic music is simply the negation of all we know about the progression of melody in traditional *maqām* music (be it Popular, or of “Art”), where leaps of fourths or fifths⁴²⁸ are simply a way of underlining the structure of the melodic progression with intervals of (sometimes alternated⁴²⁹) seconds.

And, as a conclusive note: there is also not a single example of any traditional music that would alternate ascending fifths with descending fourths 12 times (or 6 times, if paired) in a row⁴³⁰, which is one alternative scheme proposed by most Occidental theoreticians.

*The theory of Acoustic resonance*⁴³¹

The theory of Acoustic resonance is the most challenging theory in the field of music, and the most misunderstood as it seems.

Initially a simple theory *breaking down* a “natural” (or “compound”) sound in a series of *increasing* “harmonics” (from here on “partials”, as for “partial component” of the “complete” sound) the frequencies of which are ideally equal to integer multiples of the “fundamental frequency” (of the original sound), it is complicated by many physical characteristics of the

⁴²⁶ In equal-temperament for instance.

⁴²⁷ The ambitus of Early Arabian renowned singers would not reach, for instance, much further than 3 octaves (see [Beyhom, 2010c, v. 1, p. 117] for a short biography of Ibrāhīm Abū Ishāq al-Mahdī, younger – half – brother of Caliph Hārūn a-r-Rāshīd and himself shortly Caliph in 817) and the ambitus of traditional melodic instruments rarely reaches more than 2 octaves and a fifth (the Turkish *tunbūr* being a notable – for Art music – exception, with a playing range of 3 octaves + one fifth – see [Anon. “Turkish tambur”, 2016]).

⁴²⁸ Or any other non-second interval.

⁴²⁹ *i.e.* ascending then descending or *vice versa*.

⁴³⁰ The scheme would be, if beginning with *f*, the following: $f \uparrow c \downarrow g \uparrow d \downarrow a \uparrow e \downarrow b \uparrow f^{\#} \downarrow c^{\#} \uparrow g^{\#} \downarrow d^{\#} \uparrow a^{\#} \downarrow e^{\#} = (?)f$.

⁴³¹ This section expounds only the basics of the Acoustic resonance theory and presents results of my previous research in this field. For more details, it is recommended to read Appendix 4 (on the same subject).

vibrating bodies that need not be addressed in this dossier.

While remaining however within this simplified theoretical context, and knowing that the sound dynamic of frequencies of higher harmonics diminishes according to their distance from the fundamental sound, and considering the frequency of the latter be N , the suite (“progression”) of frequencies of the *simultaneous*⁴³² harmonics which compose a complex sound would be the following:

$N, 2N, 3N, 4N, 5N, 6N, 7N, 8N, 9N, 10N, 11N$, etc. (unending series and diminishing sound dynamics – in theory).

As Chailley explains above (Fig. 47), the first “partial”, of frequency $2N$, is the octave above the fundamental sound with frequency ratio 2 (*i.e.* with string lengths ratio $1/2$), and the second partial has a frequency $3N$, an octave + a fifth higher than the fundamental sound (see FHT 50 p. 219), then the double-octave ($4N$) and the double-octave + a (so-called) “harmonic” third. The third partial with a frequency $4N$ is the double octave, and so forth until reaching higher multipliers where intervallic differences between “successive” (in fact simultaneous chronologically, but successive in the arithmetical series) partials lessen till they become imperceptible, for example for the neighboring $1600N$ and $1601N$ the ratio of which, being $1600/1601$, would give an (inaudible⁴³³ and) approximate cent⁴³⁴...

Concurrently, it must be noted that this theory originally does not produce small intervals, but pitches with increasing values (beginning with the octave) which quickly become inaudible; beginning with a fairly low pitched fundamental sound with 100 hz frequency, the frequencies of the partials would be:

100, 200, 300, 400, 500, ..., 20 000, ..., (hz)

i.e. would require (about) 200 partials to reach the (approximate) upper limit of hearing, whenever starting with a middle sound at 500 hz would give:

⁴³² This term, with the combined terms “broken down”, suffice for removing the Acoustic resonance theory, at least in music, from the field of generative theories of the scale, in particular of “melodic” scales as Chailley pretends his theory is intended for (diphonic singing – Tuvu, Khosa tribes, etc. – is a notable exception to this statement, but limited in its applications).

⁴³³ Because of the diminishing sound dynamics of successive partials in the series.

⁴³⁴ More precisely 1.082 cents.

500, 1000, 1500, 2000, 2500, ..., 20 000, ..., (hz)

i.e. closing much quicker to the 20 000 hz limit (about 40 partials), whenever a 1 000 hz fundamental sound would be limited to 10 partials (or so) in the hearing range.

The wish of Western music actors (musicians, composers and musicologists⁴³⁵ alike) to include such a thrilling theory of sound in their music led some of them to consider this theory as a generative one⁴³⁶, which it is not⁴³⁷.

However, and should we consider this theory as a generative theory of the scale, it is then possible to consider that relations between harmonics could occur between, on one side, the fundamental or its octaves and, on the other side and keeping an ascending coherence⁴³⁸, the partials above them; for example, the $3N$ frequency would be in relation with the highest octave below it of the “generative sound” N , which is $2N$. The ratio of the 2nd partial ($3N$) over the octave ($2N$) would now be $2/3$ (FHT 51 p. 219), or a just fifth, a very convenient ratio for Pythagoreans and Neo-Pythagoreans. By continuing this progression until the 4th partial ($5N$), a new ratio appears, the $4/5$ ratio which corresponds to the “harmonic” third⁴³⁹, and so forth⁴⁴⁰.

However, one very disturbing property of the Acoustic progression expounded above, and within these limitations, is that the interval of the fourth, an interval of major importance in modal theories of the scale, never appears in the progression, either in direct generation (partial frequencies are related with the

⁴³⁵ Such as Chailley.

⁴³⁶ *i.e.* a theory which “creates” sounds.

⁴³⁷ With the exception of diphonic music, a rare phenomenon in music as stated above.

⁴³⁸ The fundamental sound has the lowest frequency, whenever the partials have all higher frequencies; the direction of the generative process (if it be considered as such) is an ascending one. By equating the octavial multiples (powers of 2 multipliers of the fundamental frequency, *i.e.* $2N, 4N, 8N, 16N$, etc., these become in turn replacements for the fundamental sound, which “generates” sounds upwards. The partials being related to the fundamental, they would relate only, in such case, with the lower octaves.

⁴³⁹ A very important interval in “Just Intonation” – see for instance [Lindley, 2001c] –, a theory that I shall not explore here for reasons that will become obvious further in the text.

⁴⁴⁰ The figures are for illustration purposes and show only the first four partials, but this process could be continued indefinitely.

fundamental sound only) or in equivalent octaves (partial frequencies are related with the nearest lower octave)⁴⁴¹. This was one among other reasons why Occidental theoreticians of music buoyantly stepped over this limitation and considered that intra-harmonic relations would be considered independently from the octaves⁴⁴², in which case new ratios appear (still) between partials (which now can be called “harmonics” as no distinction between the function of the components is made anymore), for instance (and for the first 5 “harmonics”⁴⁴³), the intervals of one octave + one “harmonic third” (with ratio 2/5 – see FHT 52 p. 219), the “harmonic sixth” (3/5)⁴⁴⁴ and the “just” fourth (3/4).

As stressed above, however, such a “vertical” arrangement of “harmonic” simultaneous sounds⁴⁴⁵ is inadequate in a context of “scale” generation, but most convenient for tuning instruments with “pure” or “just” (acoustically speaking) intervals, should they be simultaneous or successive⁴⁴⁶.

Nevertheless, and when this theory is considered as a theory of the scale, its properties conflict with both Pythagoreanism and ditonism, as explained below.

DISCREPANCIES BETWEEN THEORIES

The implementation of the theory of Acoustic resonance in tonal music was a difficult task for Occidental theoreticians of the scale, as observed in the example of Chailley’s theory expounded above⁴⁴⁷. These difficulties are however best explained on the

⁴⁴¹ For more details about this particular point (and how Acoustic resonance may explain the importance of the interval of Just fourth) and others, please read the specialized Appendix 4.

⁴⁴² *i.e.* with no more hierarchical relations between the fundamental sound and its partials; in other words, the fundamental sound and the partials interact together not taking into consideration the physics underlying the process, but as if they were different “pure” sounds (with one single component each) sounded together simultaneously; this is equivalent to a forced inclusion of polyphony in the theory of Acoustic resonance.

⁴⁴³ *i.e.* for the fundamental and the first 4 partials.

⁴⁴⁴ Also a most important interval in “Just Intonation”.

⁴⁴⁵ Which is the basis of “Just Intonation”.

⁴⁴⁶ I detail in Appendix 4 a generalized procedure allowing for a consonance table of “harmonic” intervals.

⁴⁴⁷ The real problem (with Chailley’s theory) results from harmonics in the “Zalzalian zone” (see below), which is the main reason why Chailley limited his “Acoustic” generation to 7 tones only.

example(s) of the notation of the successive harmonics on a Western musical staff.

Let us first note that, although the first direct intervals resulting from the harmonic series, the octave, the octave + the fifth and the double octave, correspond completely with Pythagorean equivalents (same frequency ratios), difficulties begin to appear with the 5th harmonic⁴⁴⁸ as the difference with the neighboring octaves (or 5/4, which is approx. equivalent to 386 cents) is more than 20 cents apart from the ditonic Pythagorean corresponding interval (approx. 408 cents).

Whenever such a discrepancy remains well within the limits of one semitone (100 cents), further discrepancies appear for higher rank harmonics. In the example of notation of the 14th first harmonics shown in Fig. 52, the 7th, 11th and 13th harmonics (labelled b_3^b , $f_4^\#$ and a_4^b)⁴⁵⁰ differ consistently from their Pythagorean or equal-temperament “equivalents” on the staff (from their notation), a difference which nearly reaches one (tempered) half-tone⁴⁵¹.



Or, notre oreille tend instinctivement à substituer aux sons harmoniques 7, 11, 13, déroutants, les sons chromatiques tempérés si ♭, fa ♯, la ♭; mais cette habitude ou cet instinct procèdent d'une raison scientifique.

Fig. 52 Notation of the harmonics in A. Dommel-Diény's *L'harmonie tonale*⁴⁵².

These discrepancies result in differences of notations (see for instance an alternative notation in Fig. 53, with the 13th harmonic notated $g^\#$) depending on the explanations of each theoretician for this phenomenon⁴⁵³.

⁴⁴⁸ This is the 4th partial sound: as long as we are addressing more particularly, in this section, the harmonic theory of the scale (the Western musical application of the Acoustic resonance to Occidental tonal music and scale), I shall be using here the term “harmonics” instead of partials, the “first harmonic” (sound) being (reminder) the fundamental sound.

⁴⁴⁹ This is a reasonable number, as the difficulty in labeling the harmonics increases with their rank (intra-harmonic intervals diminish beyond the semi-tone).

⁴⁵⁰ b_3^b = the b^b in the 3rd octave (from c_3 to c_4), the numbering of which begins with the fundamental (c_1), and so forth (see Fig. 54).

⁴⁵¹ See Appendix 4 and, in FHT 59, p. 223, the last two sets of interval discrepancies computations.

⁴⁵² [Dommel-Diény, 1986, p. 31].

⁴⁵³ More about the notation of harmonics in Appendix 4.

Dommel-Diény explains for instance, in his *L'harmonie tonale*⁴⁵⁴, the following:

“Our ear instinctively tends to replace the confusing harmonic sounds 7, 11 and 13 with the chromatic [equal-]tempered sounds b^b , $fa^\#$ and a^b ; but this habit or this instinct has a scientific reason to it”⁴⁵⁵.

The “scientific reason” Dommel-Diény invokes on the next page of his book can be summarized in three words: “cycle of fifths”⁴⁵⁶.

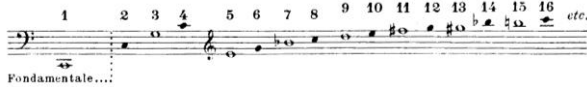

Fig. 53 Notation of the harmonics in Jacques Chailley & H. Challan’s *Théorie complète de la musique*⁴⁵⁷.

The author concludes however his explanations by this quote from Lavignac:

“The diatonic [ditonic] scale can be considered as a rational result of [Acoustic] resonance, with its origin being a unique sound which is the basis of the system”⁴⁵⁸,

and comments lastly:

“The arrangement of sounds which satisfies the human ear finds itself in agreement with Logic. Theory justifies usage”⁴⁵⁹.

As for Chailley, he already uses in this early work the concept of tolerance to explain the “adjustment of the ear”, then proceeds by expounding the evolutionary inclusion of these successive harmonics in the tonal musical language, in chords⁴⁶⁰.

The result of this rapid intrusion in the domain of harmonics notation⁴⁶¹ shows, above all, that though it

⁴⁵⁴ “Tonal harmony”, from which Fig. 41 is taken.

⁴⁵⁵ [Dommel-Diény, 1986, p. 31].

⁴⁵⁶ The cycle of fifths is a major component in this theoretician’s thought: “The formation of melodic scales, based since the Antiquity on the Pythagorean fifths, was confirmed [!?] in the 17th century by the discovery of the [Acoustical] Resonance phenomenon” – [Dommel-Diény, 1986, p. 21].

⁴⁵⁷ [Chailley, Challan, and Delvincourt, 1947, p. 6].

⁴⁵⁸ Translated from [Dommel-Diény, 1986, p. 33].

⁴⁵⁹ [*ibid.*].

⁴⁶⁰ [Chailley, Challan, and Delvincourt, 1947, p. 7].

⁴⁶¹ Numerous notations have been proposed for non-ditonic music consisting mainly in additional accidentals to Western notation, either for quarter-tones (for the notation of the enharmonic tetrachord as an example) or for other subdivisions of the tone (literature on the subject is readily available and accessible, with the entry “Notation” in the *New Grove* [Bent et al., 2001] being an extended reference on the subject); this is however not the issue addressed here, where standardized Western notation is used to label harmonics that do not fit in the (standard) staff, because of the willingness to implement this theory as a legitimization of Tonal

is (very) tempting to include the “natural” phenomenon of resonance in the Western scale, this implementation creates problems which are “tempered” by using concurrently other theories like the cycle of fifth, or the “equalization” of intervals.

This problematic is however not limited to the notation of harmonics or of intervallic discrepancies for if, as Lavignac says, the origin of the ditonic scale is a unique resonating sound, the result of the full application of this theory is, to the least, unexpected.

WHY THE ACOUSTIC RESONANCE THEORY CANNOT BE A GENERATIVE THEORY OF THE DITONIC SCALE

If the theory of Acoustic resonance is deemed to be a generative theory, and if we consider that a series of 16 harmonics is sufficient to characterize the scale, it should be normal that the ditonic *genus* appeared somewhere in this resulting scale.

In Fig. 54⁴⁶², in which I reproduce a standard Western notation of the 16 first harmonics, intervals between successive harmonics (“Intra-harmonics”) are shown on the second row.

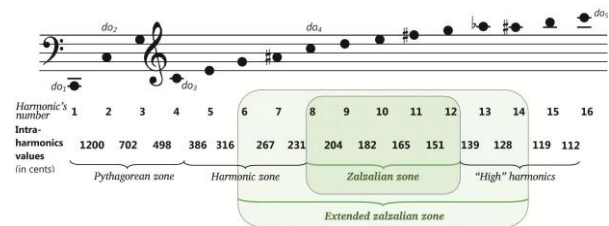

Fig. 54 Typical Occidental notation of the Harmonic progression (with the intra-harmonic intervals added and computed in cents, and functional zones shown) – see also FHT 51 p. 220⁴⁶³.

music. Note that “tonogramms”, such as those shown in FHT 8 (p. 183) to FHT 12 (p. 185), are in fact a precise (and continuous) reproduction of sound pitch (here melodic lines), and result from actual music: these cannot however be considered as notations *per se*, as they represent neither a simplification of actual praxis, nor an *aide-mémoire* for performers (which was the original aim of notation) nor a tool for composition (because they show results of actual recorded music, but do not aim to foretell them); tonometric analysis remains however a very handy tool for a *posteriori* pitch analyses of homophonic music.

⁴⁶² Which is a reduced presentation taken from the more complete FHT 58, p. 222.

⁴⁶³ do_1 (“ c_1 ”) is here per convention the fundamental sound; the progression may be divided in four parts, the first four harmonics compose what I call the “Pythagorean zone” with the intervals of the octave, the fifth and the fourth; the second part I call the

The progression of these intervals shows successive zones of, firstly, container intervals such as the octave, the fifth and the fourth (“Pythagorean zone” with harmonics 1 2 3 4), then a succession of diminishing thirds (“Harmonic zone” with harmonics 4 5 6 7) followed by a succession of tones, beginning with the “Pythagorean” tone and continuing with the “harmonic” tone, and two medium tones the value of which is approximately 3 quarter-tones each (“Zalzalian zone” with harmonics 8 9 10 11 12)⁴⁶⁴. Further generated sounds are closer to the semitone than to the tone (“High harmonics zone” with harmonics 12 13 14 15 16).

These functional zones show that the role of Pythagoreism (in this theory) is limited to Container intervals, whenever the “Harmonic zone” is a transitional zone leading to the *emmelic* intervals (seconds), with various “semitones”⁴⁶⁵ completing the series in the upper frequencies.

The 9 10 11 12 series of harmonics (starting with $c_4 = do_4$ on the figure) forms a perfect equal-diatonic tetrachord of Ptolemaos (see FHT 3, p. 181) with successive ratios 9/10, 10/11 and 11/12, a prototype of the Zalzalian⁴⁶⁶ *rāst* tetrachord. Whenever the first second in the series, the 8/9 disjunctive tone is added to this tetrachord we obtain a *rāst* pentachord whose first interval is a disjunctive tone; by using the same equal-diatonic tetrachord again we obtain the ascending scale of *maqām Rāst*, the most prominent mode in modern *maqām* music, as shown in Fig. 55.

By inverting the progression and beginning with the smallest ratio (11/12), we obtain the Zalzalian *bayāt* tetrachord. Adding a disjunctive tone then another *bayāt* tetrachord we obtain (Fig. 56) the ascending scale of *maqām Bayāt*, the second (if not

first) most important mode⁴⁶⁷ in Middle Eastern music⁴⁶⁸.

	rāst tetrachord			disj.	rāst tetrachord		
numerator	9	10	11	8	9	10	11
denominator	10	11	12	9	10	11	12
value in cents	182	165	151	204	182	165	151
Total =	498			204	498		

Fig. 55 The ascending scale of *maqām Rāst* configured as two disjunct Ptolemaos’ *equal-diatonic* tetrachords.

	bayāt tetrachord			disj.	bayāt tetrachord		
numerator	11	10	9	8	11	10	9
denominator	12	11	10	9	12	11	10
value in cents	151	165	182	204	151	165	182
Total =	498			204	498		

Fig. 56 The ascending scale of *maqām Bayāt* (and *maqām Ḥusaynī*) configured as two disjunct Ptolemaos’ inverted *equal-diatonic* tetrachords (equivalent to the descending scale of *maqām Rāst* in the previous figure)⁴⁶⁹.

It is thus no wonder that Chailley and other theoreticians needed to “correct” the theory of Acoustic resonance with the cycle of fifths or the *tolerance* and *equalization* procedures: otherwise, this “generative” theory would have produced an “Oriental”, Zalzalian scale...

⁴⁶⁷ And probably the most performed in the whole Middle East, which is a common fact but the reader can refer to [Kokkonis and Skoulios, 2005], or to [During, 2008, p.75–76]: “in Karaqalpakistan almost all the melodic material stems from the mode of *Bayātī*, *Hoseynī*, which is the basis of Anatolian music. The same mode is also wide spread in all Iran, Afghanistan and central Asia, in such a way that the ethnic and linguistic boundaries seems to loose some of their relevance”.

⁴⁶⁸ And the prototype of the 1st (and the most important – and *diatonic*) mode in Byzantine chant.

⁴⁶⁹ Jean During (personal communication) comments that this *maqām* is very common, and probably the most important mode “from Anatolia to Herat, and more Eastwards if considering melodic attractions with resulting *e natural* and *e moll*”, and reports this quote of Seyyed Hoseyn Meysami, *Musiqi-e asr-e Safavi* [Meysami, 2010, p. 202]: “According to many works in the 10th century [*hijrī*, c. 17th century C.E. – Safavid period], [...] it can be inferred that *maqām Hoseynī* [*Ḥusaynī*] was probably more important than other [*maqāmāt*]”; Maysami cites then the following authors: 1) Kawkabi (from Bukhara) p.63 of his treatise: “*Hoseynī*, which is a superior (*bartar*) *maqām*”, 2) Sadeddin (Persian): “It [*Hoseynī*] is superior to all others”, and 3) Nasimi who has the same judgment.

→
 “Harmonic zone” with the so-called “Harmonic third” and various “augmented” seconds; the third part is the *Zalzalian* zone with the progression 8 9 10 11 12 (or 8:9:10:11:12), a prototype (in its upper part 9:10:11:12) of Ptolemaos’ “equal-diatonic” tetrachord, and of the Arabian-Persian-Turkish *jīns rāst* – see FHT 59, p. 223 for various notational approximations of the harmonics, and Slide No. 20 to hear various pitches and intervals of the progression.

⁴⁶⁴ The 7th harmonic could be included in the “Zalzalian zone” as the discrepancy with a Pythagorean tone is less than a quarter-tone.

⁴⁶⁵ Never a *leimma* with ratio 243/256.

⁴⁶⁶ Understand Middle Eastern.

FOREWORD ON MUSICOLOGICAL ORIENTALISM / BYZANTINISM – AND TRANSITION

Now has come the time to come back to the genesis of modern musicology and World Music history.

*
* *

In the 19th century, Occidental scholars had a number of analytical and conceptual tools to help them study the world their Nation-states had begun to conquer and divide amongst themselves⁴⁷⁰, apparently with the best intentions towards the conquered peoples⁴⁷¹.

Alongside an Evolutionary theory of History, Evolutionary analytical tools such as the tetrachordal (and ditonic) construct of the octavial scale, the generative cycle of fifths and the equally generative theory of Acoustic [musical] resonance gave musicologists and music historians the possibility to include, exclude, accept, deny whatever characteristic in musics of the world, as long as they had science on

⁴⁷⁰ Bonaparte's conquest (variously – and preferably – called “campaign” or “expedition”, and rarely “conquest” in French literature) of Egypt had started in 1798 mainly as a way to cut off the road to India from Great-Britain. The main territorial repartition between the French and the British took place more than a century later, initiated by the Sykes-Picot negotiations (between November 1915 and March 1916 – see [Anon. “Sykes-Picot Agreement”, 2016]) and concluded (after the collapse of the Ottoman Empire) in the San Remo conference (19 to 26 April 1920 – see [Anon. “San Remo conference”, 2016]).

⁴⁷¹ Bonaparte's proclamation, on the “morrow of his occupation of Alexandria [...] began with the traditional Muslim invocation—‘In the name of God, the Merciful, the Compassionate; there is no god but God, He has no offspring and no partner.’ But the next phrase invoked a new principle: this proclamation, it declared, was issued by the French Government, which was ‘built on the basis of freedom and equality’. It then proceeded to apply these principles to Egypt” – in [Hourani, 1970, p. 49]; see also [Pérès, 1957] which suggests Bonaparte's intentions were effectively positive towards the Egyptian people(s) – and islam –, and proposes excerpts from two Arabian contemporaries, apologetic of Bonaparte's Power for the first, by the Lebanese – at that time “Syrian” – Greek-Catholic Niqūlā a-t-Turk who was sent to Egypt by the Druze emir Bashir Shihāb to enquire about the “projects of the French” in the region and, for the second, appreciative of the “Civilizational role” of the French in Egypt, by ‘Abd-a-r-Rahmān al-Jabartī – son of an Egyptian sheikh – which, Pérès (himself apologetic of Bonaparte in this article) suggests, was influenced through direct contact with the French occupying – or expeditionary? – army.

their side. Whatever frictions these theories produced, either by contradicting themselves or by contradicting Western musical dogmas (including ditonism and musicological semantics), they were backed up by centuries of evolution of Tonal music “science”, philharmonic expansion, and Lyrical and instrumental virtuosity, which made most Music historians and musicologists feel that the only legitimate music was their music, a creed with which they seemed to have convinced themselves.

Having established themselves as the only legitimate heirs of Ancient Greek culture that they had reincorporated in their civilization⁴⁷², their task was now to convince themselves first of this legitimacy, and then to convince the conquered peoples⁴⁷³ of their

⁴⁷² Although at the cost of most of its (Oriental) features *and* at the cost of historical truth.

⁴⁷³ To whom they were supposed to bring civilization and prosperity, and rid them of their tyrants: “The *mission civilisatrice*, the French for ‘civilizing mission’ (Portuguese: *Missão civilizadora*, also French: *œuvre civilisatrice*), is a rationale for intervention or colonization, proposing to contribute to the spread of civilization, mostly in reference to the Westernization of indigenous peoples. It was notably the underlying principle of French and Portuguese colonial rule in the late 19th and early 20th centuries. It was influential in the French colonies of Algeria, French West Africa, and Indochina, and in the Portuguese colonies of Angola, Guinea, Mozambique and Timor. The European colonial powers felt it was their duty to bring Western civilization to what they perceived as backward peoples. Rather than merely govern colonial peoples, the Europeans would attempt to westernize them in accordance with a colonial ideology known as ‘assimilation’. [...] Civilizing missions, while viewed in a historical context, are also capable of being viewed as values reflected and emphasized by large-scale corporations and highly popularized outlets. Looking at the civilizing mission within a historical context, it [is] essentially a concept in which a person or a group of people are forcing their personal beliefs and values onto another group of people, with the mindset that their belief is the ultimate belief. Within this context, civilizing missions would consist of highly perpetuated ideals and beliefs that are reflected onto a large audience, with the unintentional or intentional objective being to mold their characteristics and mindsets in favor of the outlet projecting their ideals” – see more in this interesting Wikipedia article [Anon. “Civilizing mission”, 2016], and more about Colonialist politics and their reasons in [Anon. “Jules Ferry”, 2016]. The following two examples may also be of interest for the reader; the first example (“tyranny”) is the continuation of the quote in footnote 471 from [Hourani, 1970, p. 49–50], expressing the intentions of the French towards conquered peoples, and here how they described the ruling Mamluks in Egypt: “The Mamluks had neither intelligence nor virtue, and therefore had no right to rule Egypt and control all that is good in it. They had ruined ‘this best of countries’, destroyed the great cities and canals for which it was once famous. Now their rule was over, and henceforth nobody among the people of Egypt would be excluded from high position.

→

superiority and of the universality and supremacy of their culture – here, their music.

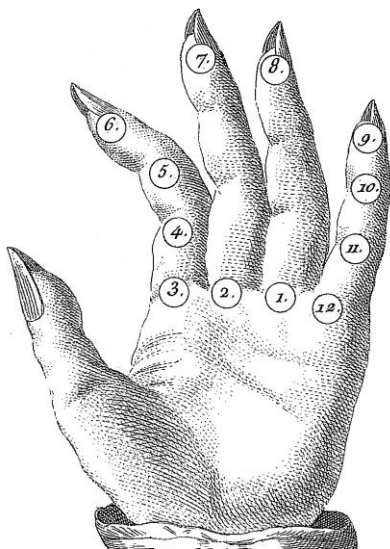

Fig. 57 The “Harmonic hand on which is found the circulation of the fundamental sound by each of the twelve *lii(s)*” by Amiot⁴⁷⁴.

* * *

→
The men of virtue and learning among them would direct affairs and the state of the *umma* be improved. The proclamation ends with a rousing peroration: ‘God curse the Mamluks and improve the condition of the Egyptian *umma*’. As for Occidental nations’ “civilizing mission” in their colonies, and besides “*The White man’s Burden*”, here is a small example from a French history textbook for children in 1916, in which the author summarizes his 22nd chapter entitled “The conquests of France”: “1. In 1830 the French took *Algier*. They conquered afterwards Algeria. Many battles took place: in *Mazagan*, one hundred twenty-three Frenchmen vanquished twelve thousand Arabs. 2. The French created schools in Algeria, in which *Arabian children are taught together with French children*. 3. A Frenchman, *Brazza*, conquered without fight vast territories in *Congo*. He freed slaves and did much good in the country. 4. France possesses nowadays, in Africa, *Algeria, Tunisia, Morocco*, and other territories. It possesses in *Asia* much of Indo-China. [France] is proud of conquering such a large empire” (in French: “1. En 1830, les Français ont pris *Algier*. Ensuite, ils firent la conquête de l’*Algérie*. Il y eut beaucoup de batailles. À *Mazagan*, cent-vingt-trois Français ont été vainqueurs de douze mille Arabes. 2. Les Français ont créé en *Algérie* des écoles où les *petits Arabes sont instruits avec les petits Français*. 3. Un Français, *Brazza*, a conquis sans batailles de grands territoires au *Congo*. Il a délivré des esclaves et fait beaucoup de bien dans le pays. 4. La France possède aujourd’hui, en Afrique, l’*Algérie*, la *Tunisie*, le *Maroc*, et d’autres territoires encore. Elle possède en *Asie* une grande partie de l’*Indo-Chine*. Elle est fière d’avoir conquis un si grand empire”) – in [Lavis, 1913, p. 170–171].

⁴⁷⁴ Plate XVII in [Amiot, 1779].

While studying “Foreign musics” and trying to analyze them, Western musicologists had no problems when confronted with “primitive” (“Oral”) musics, as Occidental superiority seemed evident and difficult to call into question, even in case of discrepancies in temperaments and concepts which all could be accommodated to the ear (or to equal-temperament) and to the mind, in the same way this was done for Tonal music⁴⁷⁵; who would know anyway, or even care?

However, and when confronted with civilizations possessing written testimony to their sometimes complex theories of music (and of the scale, temperaments, etc.) such as Chinese, Indian and *maqām* (“Art”) musics, things became somewhat more complicated.

Two main attitudes of European scholars towards Foreign Art musics can be differentiated, strongly correlated with both distance from Europe and differences between musical systems⁴⁷⁶.

1. The first attitude was one of contempt or of⁴⁷⁷ polite interest:
 - With what concerns China, there existed no special difficulties as the cycle of fifths seemed to have been originally invented there, and the 12 *lii(s)* of ancient Chinese theories of the scale could be considered as equivalent to the

⁴⁷⁵ Whenever real breakthroughs (like Alexander Ellis’ works) could have allowed for more sincere approaches of “Foreign” musics” (see also for instance [Gilman, 1909, p. 535]: “It is our own ears that are oftenest at fault when we hear in exotic music only a strident monotony or a dismal uproar to be avoided and forgotten. To most non-Europeans their music is as passionate and sacred as ours to us and among many it is an equally elaborate and all-pervading art”), the general point of view of mainstream musicology was the one described in the text of the dossier, whose aim is to show the way in which Hellenism became an integral part of an Orientalist enterprise, *i.e.* an enterprise of “othering” the so-called Orient and, most importantly, of lessening its civilizational impact in World history and culture. It is also possible to word this differently: the aim of this Orientalist enterprise was simply to maintain Western civilizational supremacy.

⁴⁷⁶ Geographical distance made it for example easier to deal with musics from China or India, these two countries being remote from Europe and creating no threat for European / Occidental supremacy, whenever the Middle East represented a direct threat for centuries, before becoming an easy prey for the European nations (see Chapter 2 and Appendix 7).

⁴⁷⁷ More or less, depending on scholars and time periods.

Western chromatic scale⁴⁷⁸. Furthermore, most Chinese music, including Art music, is pentatonic, i.e. “inferior”(?)⁴⁷⁹ to Tonal heptatonic music.

- Moreover, Amiot’s hypothesis about music originating in the Far-East then moving towards Europe⁴⁸⁰ could readily be included in an Evolutionary history, showing that the Occident, having the same scale structure as the Chinese *plus* heptatonism *plus* harmony, etc., was the pinnacle of civilization.
- As for India, and despite all the richness of its modal (and heptatonic) musical system, its music seemed to be also of chromatic structure and based on heptatonism⁴⁸¹, and presented thus no direct threat to Tonal music...⁴⁸²

⁴⁷⁸ [Kuttner, 1965].

⁴⁷⁹ This is obviously a matter of point of view.

⁴⁸⁰ Amiot’s hypothesis about a transmission of Music theory from the East to the West is stated in the beginning of his *Mémoire sur la musique des Chinois*: “The Chinese are *this Ancient nation from which not only the Greeks, but even the Egyptians drew the elements of Science and Arts, which were subsequently transmitted to the Barbarian peoples of the Occident*” (in French: “les Chinois sont cette nation ancienne, chez laquelle, non-seulement les Grecs, mais la nation Égyptienne elle-même, ont puisé les éléments des Sciences & des Arts, qui ont été transmis ensuite aux peuples barbares de l’Occident” – [Amiot, 1779, p. 16]). Amiot substantiates his claim further in his “Mémoire” [p. 122-137 for instance] then concludes [p. 172-175] namely that Pythagoras could have travelled to China and learned there the Science of music, then went back to Greece to teach there.

⁴⁸¹ It is difficult to ascertain a “Persian influence” on Indian music, although this is common belief in Musicological literature – see for instance [Brown, 2006].

⁴⁸² My conviction, expressed partly in [Beyhom, 2012], is that Indian music was structurally very close to Middle Eastern non-tempered musics and changed (became semi-tonal) under the influence of English colonialism (or even before for – to me – unknown reasons, perhaps influences from neighboring countries). The Ancient scale, the 22 *śrutis* in Bharata Muni’s *Nāṭyaśāstra*, could never have been semi-tonal, although (as shown in [Beyhom, 2012]) Western musicologists tried using all their analytical tools (Pythagoreanism, Just Intonation, cycle of fifths, etc.) in their attempts to prove the contrary; see also [Bose, 1959, p. 47], notably: “in recent times in the civilised states of south and east Asia, partially new national styles have arisen in which Western and Eastern cultural heritages have undergone amalgamation. A good example of this is furnished by India, where side by side with the continuation of old traditions in music and musical theory, a new national music has emerged which has been evolved by the poet and composer, Rabindranath Tagore, in conscious imitation of Western music, from stylistic elements of classical Indian music. The music of the Rabindranath Tagore school is an amalgamation of the principles of the European art

2. The second attitude was one of denial, notably and above all with regard to *maqām* music of the Middle East, including Eastern Byzantine chant. The reasons for such a denial of the legitimacy of “Oriental” characteristics in both Byzantine chant and, more generally, *maqām* music are complex:

- Whenever peoples from China and India, two distant countries, were easy to differentiate from Occidentals due to the color of their skin and other physical peculiarities, Arabs and Greeks, and more generally Non-European Mediterraneans and Middle-Easterners, had a (more or less) white skin for the most, especially in the Levantine countries: any similarity between them and Europeans (for instance) could threaten the supremacy of the latter⁴⁸³.

→ song with the traditions of the Indian art of singing. From the standpoint of the European the Indian elements make the dominating impression, whereas the Indians are more aware of the European model”.

⁴⁸³ French policy towards the Arabs was complex: to the question whether or not the Arabs were “White”, one of the (relatively early) answers was that “no”, the Arabs were not “White” people; they were part of the “Yellow” race with other “Semitic” peoples. Another example is when United States president Woodrow Wilson, (according to French historian Henry Laurens) while opposing French and Great-Britain’s policy about the future of Middle Eastern peoples previously ruled by the Ottomans, had difficulties in positioning the United States with regard to the Arabs: “What is important [in the context of post-war negotiations on the Middle East] is the position of president [Woodrow] Wilson. When he speaks about the right of peoples to self-determination, he means White peoples. He is a racist. He is one of the worst segregationist presidents of the history of the United States. This is why Arabs are a problem [for him] because he doesn’t know whether they are white or not” – in [Laurens, 2016] (taken from an interview by Antoine Ajoury in French: “Ce qui est toutefois important, c’est la position du président américain Wilson. Quand il appelle au droit des peuples à disposer d’eux-mêmes, il parle des peuples blancs. C’est quelqu’un de raciste. Un des pires présidents ségrégationnistes de l’histoire des États-Unis. Donc les Arabes poseront problème parce qu’il ne sait pas s’ils sont blancs ou pas”). Lastly, with the “civilizing mission” of Colonialism, (more or less?) white-skinned peoples are considered as whites for example in Lavissee’s History textbook [1913, p. 170]: “The countries that we possess are twenty times larger than France. In them dwell fifty million people. White men like us in North Africa, Black men in other parts of Africa, Yellow men in Indo-China” (in French: “Les pays que nous possédons sont vingt fois plus vastes que la France. Ils sont habités par cinquante millions d’hommes. Des hommes blancs comme nous dans l’Afrique du nord, des hommes noirs dans d’autres parties d’Afrique, des hommes jaunes en Indo-Chine”); in the

- Middle-Eastern music was mainly heptatonic, non-tempered, highly ornamented⁴⁸⁴, mostly complex in its (micro-)modulations, practically impossible to grasp⁴⁸⁵.

But, most of all, the Arabs had, at an early stage of Islamic civilization, invaded parts of the Byzantine empire⁴⁸⁶ while translating most of Ancient Greek writings on music and adapting them in order to create their own, sometimes sophisticated theories of the scale⁴⁸⁷, whenever Eastern Byzantine chant was considered as the natural heir and continuator of the liturgical music of the same empire.

The real challenge, indeed, was (and still is) *maqām* music which, despite continuous Occidental attempts at ignoring Zalzalism by belittling it⁴⁸⁸, had at its disposal a series of Early treatises⁴⁸⁹ which

contradicted Occidental supremacy and “science”⁴⁹⁰, and questioned the fundamental dogma in Tonal music: the ditonic scale.

* *

The relation of the Occident with Byzantine chant in the 19th century marked the beginning of the attempts at rewriting the history of music in the Middle East⁴⁹¹.

Besides the reasons listed above for *maqām* music in general, Byzantine musical tradition relied in particular on a complex diastematic notation and Byzantine chant, together with Greek popular music and chant⁴⁹², was considered the main vector of Greek musical identity.

And, above all and in the eyes of Western scholars, Byzantine chant was not only Christian, but it was most of all Greek... therefore, Byzantine chant had to be unquestionably integrated in the system of Tonal music (and Greece integrated in the “Choir of European nations”), in such a way that Europeans would be able to retain the founding myth of the legacy of Ancient Greece.

* *

→ intermediate period between the last two quotes, a more elaborated discourse can be found in the *Dictionnaire de pédagogie* [Buisson, 1882, v. 2, p. 202]: “*Other Aryan races – Semitic races – The Afghans, the Baloch, the Persians, the Armenians in Asia Minor still belong to the White Aryan or Indo-European race, while the Arabs and the Jews are representatives of another White race, the Semitic race, today a fallen race [...]*” (in French “*Autres races ariennes – Races sémitiques – Les Afghans, les Béloutchis, les Persans, les Arméniens de l’Asie Mineure appartiennent encore à la race blanche aryenne ou indo-européenne, tandis que les Arabes et les Juifs sont les représentants d’une autre race blanche, la race sémitique, aujourd’hui déchue [...]*”).

⁴⁸⁴ Which created difficulties for European ears, a complaint often found in travel relations for example.

⁴⁸⁵ This is a well-known fact since Villoteau’s research on Middle Eastern music in Egypt – see also the quote from Gilman in footnote 475, p. 112.

⁴⁸⁶ And became a threat to Europe itself with the Arab invasion of (notably) Spain and of part of France. A sense of historical, sweet revenge has obviously played a role in Western Scholars’ attitude towards Arabian countries, and towards the Ottoman Empire.

⁴⁸⁷ As we saw in Chapter 2, the Arabs had to be integrated in World (music) History; their geographic and chronologic positioning in this World History make them heirs to Ancient Greece, but this fact has created a real problem for Western scholars. This problematic is detailed further in Chapter 5.

⁴⁸⁸ Remember the discourse on “non-structural variations” and other “mobile” or “passing” notes in Chapter 1.

⁴⁸⁹ By Fārābī, Kindī, Ibn Sīnā, Urmawī and others from the 9th to the 13th century: these treatises seem to have been more or less forgotten to the beginning of the 20th century and replaced by alternative and later treatises, but were still used as references by Middle Eastern theoreticians, including in Byzantine chant, in the early 19th century – see Chapter 3 in [Beyhom, 2015b]; it is only afterwards that this situation changed.

⁴⁹⁰ “Western European chauvinism is virtually a necessary outcome of the comparative method if it is carried to its logical conclusions: that is, the steady developmental stream appears to lead inevitably and directly to the music of nineteenth- or twentieth-century Europe, as musics which do not fit the hypothesis are gradually eliminated from the study. [...] embarrassed by this blatancy, [later authors] attempted to justify it objectively; for example, a textbook for children, *How Music Grew*, is introduced by W. J. Henderson, who praises the authors because ‘they have shown how the supreme art forms and the greatest art works developed among the western European peoples who, it is interesting to note, produced also the metaphysical and philosophical bases of the world’s scientific thought’” – [Solie, 1982, p. 307].

⁴⁹¹ Occidental scholars and musicologists tried even to change the foundations of Byzantine chant, and succeeded partly in this attempt as will be shown in the next chapter.

⁴⁹² Because the Greeks had no “classical” music or better, as explained in [Angelopoulos, 2005, p. 43], because Byzantine music was the “classical and learned music of Greece” – see also [Erol, 2015, p. 33 sq.] for the construction of Greek national (and musical) identity based on Folk music and Byzantine chant.

4. MUSICOLOGICAL BYZANTINISM AND ITS CONSEQUENCES

“Of that Byzantine Empire the universal verdict of history is that it constitutes, without a single exception, the most thoroughly base and despicable form that civilisation has yet assumed. Though very cruel and very sensual, there have been times when cruelty assumed more ruthless, and sensuality more extravagant aspects; but there has been no other enduring civilisation so absolutely destitute of all the forms and elements of greatness, and none to which the epithet mean may be so emphatically applied. The Byzantine Empire was preeminently the age of treachery. Its vices were the vices of men who had ceased to be brave without learning to be virtuous. Without patriotism, without the fruition or desire of liberty, after the first paroxysms of religious agitation, without genius or intellectual activity; slaves, and willing slaves, in both their actions and their thoughts immersed in sensuality and in the most frivolous pleasures, the people only emerged from their listlessness when some theological subtlety, or some rivalry in the chariot races, stimulated them into frantic riots. They exhibited all the externals of advanced civilisation. They possessed knowledge; they had continually before them the noble literature of ancient Greece, instinct with the loftiest heroism; but that literature, which afterwards did so much to revivify Europe, could fire the degenerate Greeks with no spark or semblance of nobility”
[William Lecky, *History of European morals*]⁴⁹³

⁴⁹³ [Lecky, 1869, v. II, p. 13–14]. This chapter relies mainly on my book [Beyhom, 2015b], in which detailed discussions of the theories of Byzantine chant and the problematic of “the ditonic Byzantine chant of the origins” are proposed in chapters 2 and 3 as well as in the specialized appendix about the origins of Byzantine chant, with however a somewhat more detailed discussion of Romantic Hellenism in this dossier; the references for the latter are included together with specific, mostly additional references quoted in the text, whereas other references used for these (very) summarized explanations may be found in the above mentioned book. Moreover, the following appendices relate to this fourth chapter: 4. About the “Resonance” theory, 5. The myth of the organ(s) in byzantine churches (before “The Fall”), 6. On the “Diatonic [ditonic] tonal system” as the prototype system of “Medieval” Byzantine chant, and, more generally, Appendix 7. Basic understanding of Orientalism – and a little more.

Greece being the cradle, for the Europeans, of European civilization⁴⁹⁴, the contrast between the idealized Ancient Greek “simplicity”⁴⁹⁵ and the exuberance of the court life of the Byzantine empire was the apparent reason for the long-running denial campaign launched by Occidental scholars⁴⁹⁶.

The still longer-running conflicting relation of the Ecumenical Patriarchate of Constantinople⁴⁹⁷ with the patriarchate of Rome did not help either, as Constantinople could (and did) pretend to rule the whole Christian world⁴⁹⁸.

Thus, the manner in which (Eastern) Byzantine Chant has been dealt with by Western musicology⁴⁹⁹ is unique for four main reasons:

- Byzantine chant is Church music (and liturgy).

⁴⁹⁴ Note that, in the 19th century, the rooting of the genealogies of Europe’s ruling families, and of National histories, in mythological Greece came to a climax, notably in France – see [Burguière, 2003].

⁴⁹⁵ I wonder whether Alexander III of Macedon and the generals who inherited his empire after him did maintain this “simple” life style after they conquered Persia and most of the known (“civilized”) world...

⁴⁹⁶ It seems that this campaign has started with Gibbon who thought, “like all typical educated Englishmen in the 18th century, that Byzantium was the betrayal of all the greatest features in Greek and Roman antiquity” [Norwich, 1999, p. 11]; Gibbon’s main work remains *The History of the Decline and Fall of the Roman Empire*, originally published 1776–1788, in which he notably writes [Gibbon, 1872, v. IX, p. 372]: “the Greeks of Constantinople, after purging away the impurities of their vulgar speech, acquired the free use of their ancient language, the most happy composition of human art, and a familiar knowledge of the sublime masters who had pleased or instructed the first of nations. But these advantages only tend to aggravate the reproach and shame of a degenerate people. They held in their lifeless hands the riches of their fathers, without inheriting the spirit which had created and improved that sacred patrimony: they read, they praised, they compiled, but their languid souls seemed alike incapable of thought and action. In the revolution of ten centuries, not a single discovery was made to exalt the dignity or promote the happiness of mankind” (but Gibbon was a little bit skeptical about the goods of religions – see for instance [Anon. “Edward Gibbon”, 2016]).

⁴⁹⁷ Which came under Ottoman rule in 1453, after the “Fall” (the conquest of Constantinople by Ottoman sultan Muhammad II).

⁴⁹⁸ “Above all, Byzantinism was the belief in a single Christian, Roman Empire. This Empire embraced, ideally speaking, the entire Christian community, in other words, the civilized world. Its government was the reflection of the heavenly autocracy—or should we say that the heavenly government was patterned after the one on earth? It matters little” – [Mango, 1965, p. 30].

⁴⁹⁹ And often by the Greeks themselves as shall be explained further in the text.

- Byzantine chant has been considered, till late in the 19th century (and still today by some Greeks) as “Oriental”⁵⁰⁰.
- Byzantine chant is further connected, through the *Oktōēchos*, with Gregorian Western chant.
- And most of all, Byzantine chant is, in the eyes of Hellenophiles of the 19th and 20th centuries, Greek.⁵⁰¹

In parallel to the fact that Eastern and Western Churches have had antagonistic relations for centuries⁵⁰², the relation with (Eastern) Byzantine chant was different in that Greece *had* to be integrated in the European world⁵⁰³, for if not the cultural heritage of Ancient Greece would elude the Europeans⁵⁰⁴; moreover, and while Byzantine chant

⁵⁰⁰ In the 1883 booklet explaining the Second reform of Byzantine chant in the 19th century, Byzantine music is referred to as “Our Oriental music” (see the section on the Second (19th-century) Reform of Byzantine music); another, closer in time example is this statement by Baud-Bovy [1968a, p. 39]: “When airplanes did not yet remove the distance obstacle, a Greek which would leave Athens for Vienna or Paris would say he was departing ‘for Europe’, stressing thus rightly that Greece, while belonging geographically to Europe, is also part of another culture, Oriental or to the least Mediterranean” (in French “Lorsque l’avion n’avait pas encore aboli les distances, le Grec qui quittait Athènes pour Vienne ou Paris disait se rendre ‘en Europe,’ soulignant ainsi à bon droit que la Grèce, quoique appartenant géographiquement à l’Europe, participe aussi d’une autre culture, orientale ou tout au moins méditerranéenne”); a similar statement was made to me recently (in september 2015) by Cypriot friends, stressing their “Mediterranean culture” as opposed to their European (political, social, geographical?) affiliation.

⁵⁰¹ Another peculiarity of Greece is its ability to be included in the expanded process of Orientalism, as explained in [Fleming, 2000, p. 1224–1225]: “Greece, alone among the Balkan territories, has as a region of study long been a mainstay of the Western academy, a fact that, incidentally, makes the ‘metaphoric colonialism’ thesis more applicable to Greece than to the rest of the Balkans. The West’s fondness for Greece is intimately connected to the common tendency to consider Greece not truly ‘Balkan,’ at least not in the full connotative sense of the term (a difference of status once underscored by Greece’s lack of ties to the Eastern Bloc during the Cold War era and now by its membership in the European Union, among other geopolitical and cultural factors)”. As for Byzantine chant, having understood a while ago that its field of interaction is much wider than Greece (the country) and clearly different from Hellenistic influence, I prefer calling the Occidental readings of this chant as “Musical Byzantinism”, as a counterpart for “Musical (or musicological) Orientalism”.

⁵⁰² For a retrospective on “Oriental” Christianity and on the relation between the Catholic and the Byzantine Churches, see *Vie et mort des Chrétiens d’Orient* [Valognes, 1994].

⁵⁰³ Which resulted in what I call further “Inclusive Hellenism”.

⁵⁰⁴ And the Occident in general.

was considered to be the only “authentic Greek” music available in that period⁵⁰⁵, its peculiarities had to be, in one way or the other, embedded in the Occidental remit.

For all these reasons, the relationship with Greece and Byzantine chant was much more straightforward, (to the least) with regard to the music, as with other *maqām* countries, and European/Occidental interventionism in the culture of this country is, as shown in this chapter, much easier to depict in the extant literature as with the other *maqām* countries.

*
* *

Whenever earlier 19th-century studies on Byzantine chant tried to integrate the theoretical system of Byzantine⁵⁰⁶ chant in Western musicology, later theoreticians simply refused this theory. Their main argument was that today’s (then) Byzantine chant was “corrupted” by Ottoman music, as the center of Orthodoxy remained in Constantinople, now Istanbul.

Yet, in the absence of direct proof for their assertions⁵⁰⁷, Western musicologists’ “demonstrations” focused, for decades, on two main objects or courses:

1. Firstly on the so-called “Byzantine organs”, supposedly used in Byzantine churches before “The (1453) Fall”⁵⁰⁸.
2. Secondly on trying to prove analytically that “Original” Byzantine chant could only be ditonic⁵⁰⁹.

⁵⁰⁵ For instance Kiesewetter, when he wrote *About the music of Modern Greeks* (“Über die Musik der neueren Griechen” [Kiesewetter, 1858]) addressed exclusively Byzantine liturgical chant and theories; Mikhā’il Mashāqa, the well-known introducer of the quarter-tone theory in Modern Arabian musicology (see below in the text), also referred to “the scale of the Modern Greeks” when addressing Chrysanthos Madytos’ scale.

⁵⁰⁶ Mainly the Chrysantine system discussed a little further.

⁵⁰⁷ Not only is there no proof for such statements by Wellesz and Tillyard (see for instance [Tillyard, 1937, p. 201–202] and [Wellesz, 1932, p. 14] for their thesis, and more generally [Beyhom, 2015b] for a discussion of the latter), but most historical facts seem to show that it was much more Byzantine chant, along with Arabian and Persian musics, which influenced Ottoman music; I make a first demonstration of this hypothesis in my book (in French – cited above), which I hope to expand and publish as a separate article (in English) soon.

⁵⁰⁸ With the implicit assumption that organs can only be tuned in the semi-tonal Occidental tone system.

The first “proof” (“organs”) happened to be, as explained in Appendix 5, a sheer forgery which was pursued for decades without questioning.

The second “proof” was based on a mathematical demonstration which used a limited scope of Ancient Greek theories⁵¹⁰: whenever, as expounded in Appendix 6, this “demonstration” simply failed to use the “Oriental” music systems⁵¹¹, the latter prove to be equally, if not more adequate for the demonstration⁵¹².

However, Western musicologists still pretend nowadays, for obvious reasons I expound lower, that this “proof” exists.

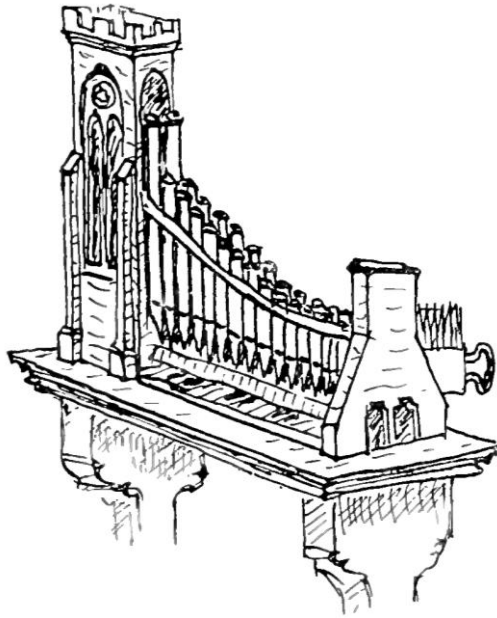

Fig. 58 A “positif” (portable organ) – between the 12th and the 14th centuries⁵¹³.

In the following pages, the status of Byzantine chant under Ottoman rule⁵¹⁴ is addressed after a parenthesis on 19th and 20th-centuries Philhellenism,

whenever the rest of the chapter explains the two reforms undergone by Byzantine chant theory in the 19th century, and how Occidental Byzantinism pushed to transform the asymmetric, Zalzalian Byzantine chant theory of Chrysanthos Madytos into a symmetric theory, compatible with the Occidental ditonic theory.

Romantic Hellenism and Philhellenism in the 19th-20th centuries

As the Ottoman advance in Europe was stopped in front of Vienna in the late 17th century, and the ability of the Empire to challenge Europe was ended⁵¹⁵, the following 18th century was a period of territorial losses to the Russian and Austrian armies, whenever areas like Egypt and Algeria became semi-independent and later came under British or French influence⁵¹⁶.

Poverty-stricken Greece⁵¹⁷ was still then part of the Ottoman empire, although the French “expedition into the eastern Mediterranean” seemed for some time on the brink of “[overthrowing] the autocratic regime of

⁵¹⁵ “[With] the [...] Treaty of Karlowitz (26 January 1699), which ended the Great Turkish War [...], the Ottoman Empire surrendered control of significant European territories (many permanently), including Ottoman Hungary. The Empire had reached the end of its ability to effectively conduct an assertive, expansionist policy against its European rivals and it was to be forced from this point to adopt an essentially defensive strategy within this theatre” – [Anon. “History of the Ottoman Empire”, 2016].

⁵¹⁶ Most of the historical events and political trends cited in this section are, unless otherwise stated, referenced in two encyclopedia articles on the Ottoman Empire [Anon. “History of the Ottoman Empire”, 2016; Mantran, 2012]; more detailed information on the Ottoman Empire and its history till the mid 19th century are available in *The History of the Ottoman Empire* by Von Hammer-Purgstall (first volume in French translation [Hammer-Purgstall (von), 1835]), originally in German and adapted in English in [Creasy and Hammer-Purgstall (von), 1854; 1856].

⁵¹⁷ Two entries in Wikipédia (the French version, the entries in English having some issues at the time I consulted them) explain for instance how Greek agriculture and industry were using at that time archaic technologies implying the use of “wretched workforce”, whenever other economical activities such as naval armament or finance did not bring profit to the majority of the population – see [Anon. “Histoire de la Grèce”, 2016; Anon. “Histoire de la Grèce aux Dix-neuvième et Vingtième siècles”, 2016], the first of which relies mainly on [Delorme, 2013]. Compare this situation with the status of the Phanariots in the 19th century as described in [Erol, 2015, p.24–25]: more on Byzantine chant and the status of Orthodoxy under (late) Ottoman rule in this book and in (notably) the synthesis of [Beyhom, 2015b].

⁵⁰⁹ The same procedure was used for Arabian music, as explained in Chapter 5.

⁵¹⁰ The same used to legitimate European music.

⁵¹¹ As well as Ancient Greek real “diatonism”.

⁵¹² *i.e.* using Ancient Greek *diatonism* (and not “ditonism”) or Zalzalism shows that Oriental theories fit best (or at least as well as ditonism) the theoretical needs for the “Original” Byzantine chant according to Oliver Strunk (Appendix 6).

⁵¹³ [Gastoué, 1921, excerpt from Pl. VII inserted p. 50-51].

⁵¹⁴ And – incidentally – of the privileged position of the Ecumenical Patriarchate as the sole responsible for the “Christian millet” under the Ottomans, as well as the situation of the Greek, Armenian, Jew, etc., minorities.

the Ottoman Empire and liberate, among others, [the] Greeks”⁵¹⁸.

Greek independence did not officially take place until 1830⁵¹⁹, supported ardently by zealous European Hellenophiles⁵²⁰; at that time, however, most of the Greek population lived outside of the territory allotted to Greece by the Treaty of Constantinople (1832)⁵²¹, and was still integrated in the Ottoman Empire.

It was not before 1945, and after various acts of war between previously Ottoman Greece and its former ruler, the Ottoman Empire (and its successor the Turkish state), that the Greek state recovered its current territories and most of its population⁵²².

In the meantime, the center of Byzantine chant slowly moved from Constantinople to Greece, while the autocephalous Orthodox Church of Greece was established in 1833-1850 (see Fig. 59).

This shift was preceded by an increasing disinterest of the Greeks in Byzantinism⁵²³, whereas massive

support of Greece in this period was made possible through the Hellenic oriented trend in Europe, what came to be called “Romantic Hellenism”⁵²⁴:

[...] effectively cushioned against the march of ideas in Western Europe, the bulk of the Greek people retained their Byzantine mentality right up to 1800, and even later. Now we move into another world. **A new myth, this time a myth manufactured in Western Europe, was about to usurp the place of Byzantinism as the guiding ideal of the Greek people: it was the myth of romantic hellenism**⁵²⁵. Formed largely in the second half of the eighteenth century, this hellenism had its serious side: academic classicism, antiquarianism spurred on by Winckelmann and the excavations of Herculaneum, Philosophy with a capital P⁵²⁶.

→ representations of Greeks, were very receptive to these claims. As progeny of the ur-Europeans, they argued, modern Greeks were more Western than the Europeans themselves and hence were entitled to membership in Europe emotionally, culturally, militarily and, finally, economically. This ‘more-royal-than-the-king’ rhetoric has succeeded to this day in putting the concerns of Greece, a minor player, on the major stage of Europe, a strategy employed also by Jews. In the global competition for cultural prestige and recognition, the Greeks could win a place in the limelight by acting as the offspring of Hellas and, hence, as the rightful owners of its treasures, myths, and language” – [Jusdanis, 1996, p. 192–193].

⁵²⁴ As apologetic of Ancient Greece as it was, eventually, paternalistic, if not depreciative of “Modern” Greece: see for instance a typical Western judgment (in the light of the Greek past) in [Dingelstedt, 1914] or, for French-speaking readers, the Ph.D. thesis [Kouzini, 2012] about 20th-century French travellers to Greece.

⁵²⁵ cf. [Stobart and Hopper, 1915, p. 260]: “Whosoever from the beginning of his action already contemplates its final end and adapts his means thereto in earnest simplicity, whosoever knows that pride and vain ostentation will assuredly bring its own punishment, of whatever land or age he may be, he is a Greek. [...] Losing Hellas, Europe sank into ages of darkness: recovering her, the European nations began to think again”.

⁵²⁶ [Mango, 1965, p. 36]; the continuation of this quote may also be of interest for the reader: “More influential in terms of popular appeal was the escape to a golden never-never land, to a simple rusticity which ancient Greece seemed to offer: everyone wanted to be a shepherd in Arcady. The fashion for all things Grecian knew no bounds: Grecian odes, Grecian plays, Grecian costumes, Grecian wigs, Grecian pictures, Grecian furniture. For the sub-literary public a stream of insipid Grecian romances poured from the presses [...]. But the work that reflected most fully what the eighteenth century imagined about ancient Greece is that laborious masterpiece, *The Travels of the Younger Anacharsis* by the not very religious *abbé* Jean-Jacques Barthélemy. The fictional Anacharsis was a Scythian youth (hence a noble savage) who toured Greece between 363 and 338 B.C. He had a genius for meeting famous people: Plato, Aristotle, Isocrates, Xenophon, Demosthenes, Euclid—everybody who was anybody—vied with one another to talk to the Younger Anacharsis. And what splendid

⁵¹⁸ [Beaton, 1991, p. 2].

⁵¹⁹ The rebellion against the Ottoman Empire can be traced back to 1821, whenever the first Hellenic republic (the Greek modern state) existed *de facto* beginning 1822 (with six successive heads of the state) until the Kingdom of Greece, supported by France, Great-Britain and Russia, was officially established in 1832 – for more details see [Wikipedia Contributors, 2013a; Wikipedia Contributors, 2013b] and, for a rapid account of the situation in Europe at that time, [Wikipedia Contributors, 2013c].

⁵²⁰ It seems that the European governments were not as zealous as the individual Hellenophiles: “The Greek Revolution [...] was fought, as everyone knows, with the enthusiastic support of all liberal-minded Europeans. [...] The European governments were somewhat less enthusiastic, but then they had to reckon with prosaic things like the balance of power and the fate of the Ottoman Empire” – [Mango, 1965, p. 38].

⁵²¹ See [Anon. “Traité de Constantinople (1832)”, 2015].

⁵²² See [Anon. “Greco-Turkish War”, 2015] and [Anon. “Greco-Turkish War (1919–22)”, 2016].

⁵²³ “Even before the founding of the [Greek] nation-state in 1830, th[e] question [of continuity] became an urgent political concern as Greek intellectuals debated the issue of whether modern Greeks were the direct descendants from, and hence legitimate heirs of, classical civilization. In a sense, Europeans themselves had been comparing the modern and ancient Greeks for some time, with the modern Greeks the usual losers. Travelers, for instance, and their readers often denounced the inhabitants of Greece as degenerate Orientals, whose squalid culture was a debasement of antiquity. On the other hand, many philhellenes, roused by the clamor for nationalism and democracy at home and convinced of the direct connections between modern Greeks and ancient Hellenes, rushed to realize their Byronic dreams in the Greek revolution. Greek scholars of the time, themselves excited by the possibility of overthrowing both Ottoman rule and orientaling

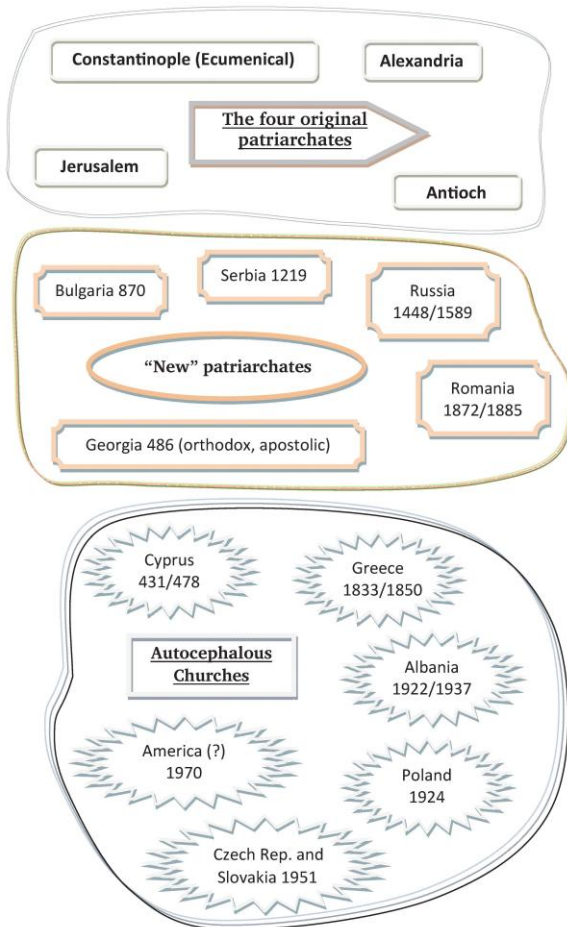

Fig. 59 Jurisdictions of the Orthodox Church⁵²⁷.

While interest in Byzantium sank in parallel to the rise of Romantic Hellenism, Byzantine studies came to a new light a few decades later⁵²⁸. However, European

conversationalists they all were! What sublime, coruscating ideas they all expressed, how delicate were their manners, how simply and frugally they all lived! For twenty-five years Anacharsis went on interviewing famous Grecians, taking copious notes on history, religion, art and manners”.

⁵²⁷ Source: [Wikipedia contributors, 2012a; 2012c]; see also [OrthodoxWiki, 2012]. Autocephaly is the administrative independence of a Church (Orthodox in this case – see for instance [OrthodoxWiki, 2010b]); Lebanese fr. Romanos Joubbran, a well-known musicologist of Byzantine chant, and who tirelessly helped me in deciphering Greek writings or decrypting particulars of Byzantine chant theory, informed me (in 2012) that the Czech and Slovakian Churches were still not autocephalous, whenever other, “Autonomous” Orthodox Churches exist, which must however still be acknowledged and confirmed by a patriarch (see also [OrthodoxWiki, 2010a]).

⁵²⁸ [Mango, 1965, p. 39–40]: “Behind this misunderstanding there lurked a deeper cause which neither side understood at the time. A symptom of it is that the Travels of Anacharsis fell into oblivion

interest in Greece, besides its importance as the “Cradle of Europe” and it being one of the most important Christian countries in the (former) Near East⁵²⁹, was not necessarily as disinterested as it would seem:

“In the case of eighteenth and nineteenth-century Greece, the argument for the link between European philhellenism and some sort of metaphoric or pseudo-imperialism has been voiced by a number of scholars. Olga Augustinos has demonstrated that Greek travel literature of the period is directly tied to Europe’s claim on the ancient Greek past and shows that this claim ‘made [Greece] seem closer to the West’ and somehow under its control.⁵³⁰ Artemis Leontis notes that, while the ‘Greeks, former subjects of a powerful Eastern Empire, may be said to have gained the status of modern independent nation-state without having passed through administrative colonialization by the West,’ it nevertheless ‘could be argued that modern Greece endured a ‘colonialization of the mind,’ given that its system of education was imported directly from Germany.’⁵³¹ I myself have argued elsewhere that in the case of Greece the mechanisms of romantic philhellenism and the cultivation of the belief in Greece as the fount of Western civilization functioned as the underpinnings for a sort of ‘surrogate’ colonialism, whereby Greece was brought into the intellectual and cultural penumbra of the West, particularly Britain and France”⁵³².

Whatever continuity between Ancient Greece, Byzantium and Modern Greece was sought by Hellenophiles or by the Greeks themselves⁵³³, the fact

around 1850. Travellers now confessed that the Acropolis, in all its perfection, left them cold, that Greek sculpture appealed to their intellect and not to their emotions [... p. 40] This new preoccupation with the Middle Ages and feudal gloom had an important side-effect, for it led, via the Crusades, to the rediscovery of Byzantium. Chateaubriand set the fashion by going to the East ‘en pèlerin et en chevalier, la Bible, l’Évangile et les Croisades à la main’. Starting in the thirties, i.e. simultaneously with the appearance of Victor Hugo’s Notre-Dame de Paris, Byzantine studies picked up again in Europe, having lain dormant since the seventeenth century”.

⁵²⁹ For the changing acceptations of the terms “Near East”, see Appendix 7.

⁵³⁰ Citing [Augustinos, 1994, p. ix].

⁵³¹ Citing [Leontis, 1995, p. 68, 68 n. 2].

⁵³² Citing [Fleming, 1999, p. 151–152], reprint [Fleming, 2014], ref. [Fleming, 2000, p. 1221].

⁵³³ [Mango, 1965, p. 29]: “Since the Koraës Professor [Cyril Mango wrote this article after being appointed Chairman of the Koraës Chair in Modern Greek and Byzantine History, Language and Literature at King’s College, London] is expected to study both Byzantine and Modern Greek civilization, the first question he has

remains that Byzantium, a Christian empire, had little in common with Ancient Greece:

“[W]hat was the golden age that the Byzantines strove to perpetuate? Clearly, it was the age of the early Christian Empire, the age of Constantine, Theodosius and Justinian, in other words, the *Spätantike* [“Late Antiquity” in German]. This was only logical since the period of Late Antiquity had coincided with the greatest extension of the Christian Empire: to reconquer the patrimony of Constantine the Great was the objective of every ambitious Byzantine emperor down to the twelfth century. But in addition to the political motive, there was also an unbroken intellectual continuity between the period of Late Antiquity and the Byzantine Middle Ages. [...] Conversely, the Byzantines in general did not evince the slightest interest in what we understand by classical Greece. This is a truth that has been blurred by much loose talk about ‘Byzantine humanism’ and ‘Byzantine hellenism’. If you open a Byzantine compendium of universal history you will be surprised to note that Pericles, Themistocles, Leonidas are not even mentioned; that Xerxes and the Persian Wars are dismissed in one sentence, and this in connection with Daniel’s prophecy of the Four Beasts”⁵³⁴.

Whereas the trend, today⁵³⁵, is to reintegrate Classical Greek culture in Modern Greek musicology⁵³⁶,

→

to decide in his own mind is what these two civilizations have in common. It is not a new question, nor, alas, is it a safe one. Much of the claim of modern Greece upon the sympathy of Western Europe has been based on the assumption of a direct historical continuity reaching back three thousand years: from modern Greece to Byzantium, from Byzantium to the Hellenistic world and thence to ancient Greece”. {Koraës was “an expatriate Greek nationalist and classical scholar[...] a philologist, linguistic reformer and political pamphleteer, almost all of whose work is devoted to Greece”, born in Smyrna in 1748, supporter of the French 1789 revolution and, at least at his beginnings, of Napoleon Bonaparte; he wrote for instance about “the regeneration of modern Greece as the direct descendant of classical Greece [and the] reform of modern Greek language” – more on him and on the struggle for the independence of Greece in [Beaton, 1991] (for these quotes and facts [p. 1, 3])}.

⁵³⁴ [Mango, 1965, p. 32].

⁵³⁵ But also at the time of the Chrysantine reform, and at least in music.

⁵³⁶ Two examples are significant of this trend. The first is represented by a series of articles by Samuel Baud-Bovy in which the latter tries to prove that Ancient Greek music survives in the Popular (Folk?) music of Modern Greece (see for instance [Baud-Bovy, 1967; 1968b; 1983; 1984]) and which he concludes notably (in [Baud-Bovy, 1988, p. 77, 85]) by these statements: “Whenever scientists of the previous century, either to please Hellenophiles or to counter Fall[mer]ayer’s theory on the slavization of Greece in the Middle Ages, used all possible means in order to prove that Modern Greeks were direct descendants of Ancient Greeks, the following generations grew tired of this

→

the Byzantine Ecumenical Patriarchate tried to withstand the influence of Philhellenism and westernization in the 19th century, as well as it tried to preserve and promote Byzantine chant under Ottoman rule, a rule which has not been as catastrophic for Greeks and Byzantine chant, it seems, as post (Greek) independence historical narrations may have described it⁵³⁷.

More specifically, the Ecumenical Patriarchate authorized and encouraged two successive reforms of Byzantine chant theory⁵³⁸ in the 19th century, the purpose of which can only be understood through a recapitulation of the history of this chant in Greece at that time.

→

exclusive Ancestor worship. [...] But today, when a Greek self-sufficient culture is acknowledged in all domains, we have no more reasons not to accept that some elements of the Antique world remained vivid in Modern Greece” and “To conclude, I think that the best way of approaching the music of Antiquity, which remains mysterious in many regards, is to study the [Modern Greek] authentic popular singing” (in French: “Alors que les savants grecs du siècle dernier, que ce soit pour faire plaisir aux philhellènes ou pour combattre la théorie de Fall[mer]ayer sur la slavisation de la Grèce au Moyen Âge, mettaient tout en œuvre pour prouver que les Grecs modernes étaient les descendants directs des Grecs anciens, les générations suivantes se lassèrent de ce culte exclusif voué aux ancêtres. [...] Mais aujourd’hui, où l’existence d’une civilisation grecque se suffisant à elle-même est reconnue dans tous les domaines, nous n’avons plus la moindre raison de ne point admettre que certains éléments du monde antique sont restés vivaces dans la Grèce moderne” and “Je pense en conclusion que pour approcher la musique antique, restée si mystérieuse à tant d’égards, la meilleure manière est d’étudier la chanson populaire authentique”); for Fallmerayer’s “Slavonic” theory see for instance [Latham, 1851, p. 30] (for more information on Greek history, including the change of trends from Philhellenism to “Ancient Greekness”, see [Beaton and Ricks, 2009], notably the introduction; see also Fallermayer’s book – in German – [Fallmerayer, 1857] or, for the construction of Greek Nationalism and identity on the basis of the Orthodoxy, the relations between the Byzantine Church and the Greek state and the present problems in education and internal or external politics, see for instance [Molokotos-Liederman, 2003; Efstathiou, Georgiadis, and Zisimos, 2008]).

The second example is represented by Simon Karas’ work on Greek popular folk (rural) songs as the basis of Byzantine chant, and his implementation of Pythagorean theories in his rewriting of the theories of this chant (see the section on “Re-Byzantinism” lower).

⁵³⁷ This topic is addressed in the synthesis of [Beyhom, 2015b].

⁵³⁸ Which had remained unchanged for centuries.

→

Byzantine chant under Ottoman rule and its transformations in Greece in the 19th century and the Early 20th century – A short overview

Strangely enough for Western foreigners travelling to Greece, Byzantine chant flourished in the Ottoman 19th century, although most of its characteristics seemed inexplicable, if not unbearable, for them; the bare existence of Chrysanthos Madytos⁵³⁹ theory, a complex, sophisticated representation of the scale and diastematic notation built on sources and principles distinct from Western dogmas at that time, while widely and freely based on principles which had predominated in Oriental music theories for the last centuries, provoked various (very) negative reactions from Occidental theoreticians⁵⁴⁰, whenever Byzantine chant itself was rejected by most Western musicians and composers⁵⁴¹. This refusal of Byzantine chant was however counter-productive with regard to the Philhellenic tendency of the latter, which sought to “reconcile” this chant with their own music, a process the results of which would eventually bring up a complete transformation of this chant.

*
**

Whenever the actual lecture by Byzantine chant historians and “relators” (such as Angelopoulos for instance) of its history still defines the conquest of Constantinople by Muḥammad II as “The Fall”, the same authors readily acknowledge that Byzantine chant under the Ottomans eventually reached a state of maturity and inflorescence which was probably never achieved before⁵⁴².

⁵³⁹ The theoretician of the First Reform of the 19th century.

⁵⁴⁰ These include various musicians, theoreticians or composers which wrote about and discussed Byzantine theories in the 19th century, notably [Villoteau, 1826; Bourgault-Ducoudray, 1877; Bourgault-Ducoudray and Lauzières, 1876; Kiesewetter, 1858; Thibault (fr.), 1898].

⁵⁴¹ See for instance below the reactions of Bourgault-Ducoudray to the *ison* (a drone used in Byzantine chant, giving the fundamental degree of the mode) and to the nasal timbre of the cantors.

⁵⁴² Note that Byzantino-Turkish antagonism prior to “the Fall” has mostly been exaggerated, and the conflict between Eastern and Western Christianity under-estimated; it suffices to remind here of “the well-known dictum of Lucas Notaras, the last emperor’s chief counselor, ‘It is preferable for us to see the Turkish turban

Dimitri Conomos and Lykourgos Angelopoulos⁵⁴³, for instance, split the Ottoman period in five “great moments”⁵⁴⁴:

- 1453-1580: survival of tradition after the Fall;
- 1580-1650: preparation for a renaissance;
- 1650-1720: first great peak;
- 1720-1770: stabilization and resumption;
- 1770-1820: second great peak”.

Then it seems that Byzantine chant in the Ottoman empire had reached a peak (and maybe its climax), immediately before the independence of Greece⁵⁴⁵: the

→ prevailing in the midst of the City rather than the tiara of the Latin cardinal” – in [Arnakis, 1952, p. 236].

⁵⁴³ Following Manolis Hadjigiakoumis’ Ph.D. thesis (according to Angelopoulos).

⁵⁴⁴ [Conomos, 2012] and [Angelopoulos, 2005, p. 66–67], from which is taken the quote: Dragoumis [1968, p.170], in the *Encyclopédie de la Musique Sacrée*, combines the last 4 periods in one period of “enrichment” of Byzantine chant. Please note that Conomos would be considered as a mainstream musicologist following Wellesz and Tillyard’s lead (he took over for instance the publication of the *Studies in Eastern chant*, a leading review of the Wellesz-Tillyard trend, after the first three issues edited by Wellesz and Miloš Velimirović – another active promoter of Western byzantine musicology theses), but he tries in fact to hold a balanced stance in the above cited reference which makes his opinion on the subject even more interesting, namely: “(a) 1453-1580 - a time of renewed interest in traditional forms, the growth of important scribal workshops beyond the capital, and a new interest in theoretical discussions; (b) 1580-1650 - a period of innovation and experimentation, the influence of foreign musical traditions, the emergence of the *kalophonic* (or embellished) chants as a dominant genre, and the conception of sacred chants as independently composed art-objects; (c) 1650-1720 - when extensive musical training was available in many centres and when elegantly written music books appear as artistic monuments in their own right. Musicians of this age were subjecting older chants to highly sophisticated embellishments and their performance demanded virtuosic skills on the part of the singers. In addition, the first attempts at simplifying the increasingly complex neumatic notation were being made; (d) 1720-1770 - a period of further experimentation in notational forms, a renewed interest in older, Byzantine hymn settings, the systematic production of music manuscripts and of voluminous Anthologies that incorporated several centuries of musical settings; (e) 1770-1820 - a time of great flowering in church music composition and the supremacy of Constantinople as a centre where professional musicians controlled initiatives in the spheres of composition, theory and performance. Among these initiatives were: further notational reforms, new genres of chant, the reordering of the old music books, **the more prominent intrusion of external or foreign musical elements**, and, finally, by 1820, the termination of the hand-copied manuscript tradition”.

⁵⁴⁵ More detailed information on this subject can be found in Angelopoulos’ cited work, and in my book on Byzantine chant; it

following period in Greece would mark however the beginning of a new process of deculturation of this chant.

BYZANTINE CHANT TRANSFORMATIONS IN GREECE IN THE 19TH AND THE BEGINNING OF THE 20TH CENTURIES

As a prelude for the understanding of the profound changes that Byzantine chant underwent in the 19th century, it is necessary to remember that this was the time of rising nationalism all over the Orient (including Greece⁵⁴⁶) with averted antagonisms between the non-Turkish subjects of the Ottoman empire and their rulers, but also between different peoples of the empire, notably in Bilād a-sh-Shām⁵⁴⁷ where these antagonisms culminated in the civil (and confessional) war of 1860⁵⁴⁸.

Needless to say, Occidental colonialist nations, notably England, France and Russia, had a prominent role to play in the uprisings and various conflicts which arose then, with the stated purpose of defending the Christians of the empire and eventually free them from the Ottoman yoke⁵⁴⁹.

→

is also of interest to note that the first Reform took place during the conclusive stage of this second peak.

⁵⁴⁶ For Greek nationalism [Beaton, 2007, p. 76]: “Nations and nationalism, according to the most influential modern approaches to the subject, are no older than the late eighteenth century at the earliest. In Greek public discourse, on the other hand, ever since at least the mid-nineteenth century, it has been a cherished axiom that the *Greek* nation has been in existence for some three thousand years”, with footnote 1 “The *locus classicus* for what has become an orthodoxy of modern political theory is E. Kedourie, *Nationalism* (London 1960) 1, which describes its subject as ‘a doctrine invented in Europe at the beginning of the nineteenth century’”; for the beginnings of Hellenism in Cyprus, for instance and around 1 000 B.C., see [Iacovou, 1999]; for the “Classical” Hellenistic period beginning with Alexander the Great’s crossing of the Hellespont in 334 B.C., see [Jones, 1964]; lastly, for the connections of French and English nationalisms with (racial) Hellenism, see notably [Leoussi, 1997].

⁵⁴⁷ Today’s – but perhaps not tomorrow’s? – Lebanon and Syria.

⁵⁴⁸ Mikhā’īl Mashāqa, mainly a historian, and a musicologist of Arabian music cited in the next sections, documents largely, and in an exceptionally balanced manner, the “Events” of the Civil war of the 19th-century Bilād a-sh-Shām in [Mashāqa, 2008] – see also, for a more recent reference on the subject, the extremely well documented [Ismail, 1958] and more generally about Mashāqa [Zachs, 2005], the History and (Historians) of the region in the 19th century [Philipp, 1984, p. 165], and more in [Rogan, 2009].

⁵⁴⁹ Concerning Greece, see for instance [Holland, 2008, p. 384–385], namely: “The roots of a specifically British ‘protection’ of Greek-speaking lands go back to the appearance of political agents

Whenever this historical burgeoning cauldron explains most of the changes addressed in the following paragraphs, we should, as musicologists and scientists, keep a clear sense of proportions when examining recent manifestations of these antagonisms (or at least exacerbated nationalisms), notably for musics of the Middle-East region⁵⁵⁰, and replace the latter in the general context of the history of this region.

* * *

Western influence in Greece was obviously not only political, but also social and cultural, with a clear reaction against the Orthodox Church⁵⁵¹. These contradicting trends in Greek society urged the

→

from London in the southern Balkans after 1806. The presence of the latter encouraged local Christians who, perceiving the first glimmering of an opportunity to escape Ottoman rule, called openly for British intervention on their behalf’. For the civil war in Lebanon (culminating in 1860), see the aforementioned [Ismail, 1958] which, while relying on Western consular and diplomatic archives, describes in details the role of Western diplomatic representations in supporting one or another of the confessional populations in Lebanon before and during the conflict.

⁵⁵⁰ This topic is addressed in Chapter 5.

⁵⁵¹ [Kitromilides, 2010, p. 46]: “The best known exponents of the later and most mature phase of the Greek Enlightenment, Rhigas Velestinlis and Adamantios Korais [Koraës in the quote from Mango in footnote 533], in their very different ways represent this revolutionary classicism in Greek thought. Radical activism on the part of Rhigas and liberal scholarship in the case of Korais combined in infusing a section of Greek culture with a new identity. It was an identity premised on the espousal of the classical heritage but directed this time against the Orthodox tradition that had nurtured that heritage for so long. In short it was a modern secular identity premised on a reconnection of Modern Greek society with classical republican hellenism. Faced with these unexpected developments the official Church eventually saw what some fundamentalists had been claiming all along: that Orthodoxy could tolerate the classics only at its peril. But when the Patriarchate of Constantinople opened its campaign against classicism during the third patriarchate of Gregory V in 1818–1821, it was too late. The temper of revolution was in the air. The Enlightenment had done its work. This was the cultural context of the emergence of a new age in Greek history at the beginning of the nineteenth century. From the traditional syncretism of cultural pluralism to the osmosis of a new synthesis the stage had been set for the emergence of a modern literary tradition and the political aspiration of freedom: these were precisely the critical elements that defined the new nation about to appear as an active participant in the drama of European history in 1821”.

→

Ecumenical Patriarchate (in Constantinople) to reform Byzantine chant theory and teaching, while secular music in Greece, influenced by Occidental classical music, deeply affected the praxis of this chant which became (partly) harmonized or polyphonized to the like of its Western counterparts⁵⁵².

Greece had been, since 1833, ruled by a Bavarian prince who became king of Greece (under the name Othon the First) until George the First, from the reigning family in Denmark, took his place on the throne in 1862. It is not before 1909 that George the First called on Eleftheros Venizelos (who became Prime minister in 1910), a partisan of a Greco-Turkish federation; Greece found itself in the meanwhile in the middle of a power game played by England, France and Russia, which explains the strong influence of Western music in the recently independent country.

The Bavarian rule nearly imposed⁵⁵³ polyphonic (and contemporary to that time) music in the prominent churches of Athens, until Cantor and musician Ioannis Sakellaridis, in the beginning of the 20th century, developed a limited polyphonic system (two voices) which he used for the “musical arrangement” (and adaptation to the Western classical system) of traditional melodies, notably by changing their rhythmical and modal feeling. This new style spread very quickly, due to its simplicity, and it was

⁵⁵² Most of the events described in this section are taken (and freely translated) from [Angelopoulos, 2005, p. 77–78]: “[I] ne faut pas oublier que depuis 1833 la Grèce est dominée par la ‘bavarocratie’. C’est en 1862 seulement qu’Othon I^{er} (prince de la famille de Bavière devenu roi en 1833) quitte la Grèce et que Georges I^{er}, issu de la famille régnante du Danemark, le remplace sur le trône. Lequel Georges I^{er}, en 1909, fera appel à Eleftheros Venizelos. Après la domination ottomane, la Grèce se trouve donc au centre d’un jeu d’influences entre les grandes puissances occidentales : l’Angleterre, la France et la Russie. Ce qui explique que le système musical occidental ait pu s’y imposer aussi fortement. La domination bavaroise a favorisé – pour ne pas dire imposé – un genre de musique polyphonique, et plus spécialement celle du XIX^e siècle, dans les principales églises de la ville d’Athènes. Mais ce n’est pas tout. Aux influences musicales de l’Occident viendra s’ajouter le travail du psalte et musicien Ioannis Sakellaridis qui, au début du XX^e siècle, va développer un système musical à deux voix très naïf (*primo-secundo*). L’œuvre de Ioannis Sakellaridis fut particulièrement néfaste parce qu’il utilisait des mélodies traditionnelles en les ‘arrangeant’, c’est-à-dire en faussant leur rythme, en supprimant leur caractère modal, et en les adaptant au système musical occidental. Et son style se répandit très vite car ses compositions simplifiées paraissaient à nombre de musiciens plus faciles à exécuter”.

⁵⁵³ And to the least favored.

not until the Conservatory of Athens called on Constantinos Psachos, a cantor and theoretician from Constantinople⁵⁵⁴, that monophonic Byzantine chant retrieved its rights in Greece.⁵⁵⁵

It is in such a complicated context that the two reforms of Byzantine chant took place in the 19th century, and that European scholars later convinced themselves, while trying to convince the Greeks, that the Byzantine chant of the origins was ditonic.

* *
* *

Needless to say, the declining Ottoman Empire itself had not been spared by the Occidentalizing process in the 18th and the 19th centuries; European nations growing power led to commercial, then diplomatic relations with the Sublime Porte⁵⁵⁶,

⁵⁵⁴ “In 1903, the Athens Conservatory of Music decided to cooperate with the Church of Constantinople in founding a school of Byzantine music in Athens. The director of the conservatory, G. Nazos, travelled to Constantinople in order to find a suitable person to undertake the teaching of Byzantine music. On the recommendation of the Ecumenical Patriarch he selected C. Psachos, a distinguished singer and an author of several articles on Byzantine music. Psachos delivered his opening lecture in Athens on 23 September 1904” – [Römanou, 1990, p. 100].

⁵⁵⁵ [Römanou, 1990, p. 100]: “Owing to the energetic activity of Psachos, traditional monophonic chanting gradually gained in popularity over four-part singing and interest in the New Method grew. In 1911, after the publication of several chapters of the [Θεωρητικόν Μέγα της Μουσικής – *Theōrētikon mega tēs mousikēs*] in [a] periodical [...], the whole book was produced by the printing house of Koussoulinos in Athens. {here, a footnote by the author: ‘The [*Introduction to the Theory and Practice of Ecclesiastical Music*] published in 1821 –proposing the most prominent features of the First Reform] was re-edited only in 1940 by C. Papademetriou in Athens. An abridged version of it, translated into French, is in L.-A. Bourgault-Ducoudray, *Études sur la musique ecclésiastique grecque* [...]’} From that time the teaching of Church Music has been carried out in Greece according to the New Method, as adjusted by the committee of 1881 [Second Reform]” – [Römanou, 1990, p. 100]. Note however that the teaching of the “Three Masters” (see the section on the First Reform below in the text) had begun (at least) as soon as 1830 in Greece {see [Angelopoulos, 2005, p. 75] – see also footnote 573 p. 126 for an even earlier date (1814-1815) for the beginning of this teaching}. Note also that the teaching at the Conservatory of Athens (obviously a hotspot of Western music teaching) soon began to influence Byzantine chant teaching (as it did for Arabian music in the Middle-East) notably through the use of the piano (!) for this teaching at some time (see [Angelopoulos, 2005, p. 76]).

⁵⁵⁶ See Appendix 7 and [Anon. “History of the Ottoman Empire”, 2016, “Modernization period”].

whenever the Ottoman sultans' love of Europe created a trend of westernization in Ottoman music itself, notably at the sultans' court, and was confronted to similar "needs" for reform as those expressed in the next section for Byzantine chant⁵⁵⁷.

This was a major change in Constantinople / Istanbul⁵⁵⁸, where the Ecumenical Patriarchate has had its siege since the beginning of the Byzantine Empire...

The reasons underlying the reforms of Byzantine chant in the 19th century

In the 19th century, and in a context of infighting in the Byzantine Church⁵⁵⁹, two reforms modified Byzantine chant theory⁵⁶⁰: the First reform (1814-1818, then 1831) was led by Chrysanthos Madytos (see Fig. 60); the Second reform was the brainchild of Germanos Aphonidēs and... Louis-Albert Bourgauld-Ducoudray.

THE REASONS FOR THE FIRST REFORM

In the beginning of the 19th century, the continuously growing repertoire of Byzantine chant was becoming more and more difficult to memorize.

⁵⁵⁷ For Ottoman music changes in the 19th century, see [Feldman, 1996, p. 498–503; 2001]; for the decline of this music during the same period, the introduction of the Hamparsum notation instigated by Sultan Selim in the late 18th century and the creation of the first opera house in Istanbul under the reign of the same, the abolition of the Janissary corps and the replacement of the *mehter* (the music band of the Janissaries, closely associated with the Ottoman sultans – see [Signell, 1988]) by the Imperial Band (or Orchestra) under Giuseppe Donizetti's direction during the reign of Mahmut II (Selim's successor) in the first half of the 19th century, see for instance [Signell, 1976, p. 72–76].

⁵⁵⁸ See also [Erol, 2015, p. 29 sq.], in which the author describes the influence of Western music on the Ottoman (including Greek Orthodox) elite.

⁵⁵⁹ "In the nineteenth century [...] Constantinople maintained its moral power and prestige among all Orthodox peoples, with the exception of schismatic Bulgaria. At the same time, the establishment of national churches, appearing as an inevitable consequence of nationalism, saved the venerable institution from political entanglements which it could hardly sustain. Yet the transfer of ecclesiastical authority to the new churches did not occur without psychological tension. The Patriarchate was loathed to part with its jurisdiction over the Christian kingdoms. In the case of Greece, for example, it recognized the autonomy of the archbishop of Athens only as late as 1850, and in the early 1880's, it opposed all efforts of the Tricoups government to take over the school system of the Greek communities in European Turkey" – [Amakis, 1952, p. 248].

⁵⁶⁰ And the notation, for the First (Chrysantine) Reform.

Thus, cantors had to develop an efficient musical notation⁵⁶¹ much needed for a better teaching of this music. Indeed, Byzantine diastematic notation in those days was the result of successive additions of signs describing the performed music with complementary indications allowing for an appropriate performance of the chant. However, this notation involved the memorization of many signs which required years of apprenticeship before it could be mastered⁵⁶².

period	name	lived
The " Three Masters " (beg. 1814)	Chrysanthos Madytos	1770(?)–1846
	Gregorios Prōtopsaltēs ("Levitos ")	1778(?)–1821
	Chourmouzios (Georgiou) Chartophylax	1770(?)–1840
Music Committee 1881	Germanos Aphonidēs	19 th century

Fig. 60 Prominent Greek actors of the two reforms of Byzantine chant in the 19th century⁵⁶³.

Katy Rōmanou, whose 1973 Masters dissertation⁵⁶⁴ consists in a translation and commentary of Chrysanthos Madytos' *Theōrētikon mega tēs mousikēs* [Great theoretical book of music]⁵⁶⁵, explains how some other attempts at reforming Byzantine notation took place before the two "official" reforms of the 19th century:

"The earliest reference to the need of characters for the music of the Greeks is made in the mid-sixteenth century in a treatise of a student of Zarlino, a Greek-Cypriot named Hieronymos. Realizing that his fellow countrymen have some time since started to misunderstand their notation and confuse the neumes with one another, he invented a system of his own, drawing from both Byzantine and European

⁵⁶¹ Originally intended as an *aide-mémoire*, a fact that should be systematically reminded in musicological research on the music of the Orient.

⁵⁶² See also [Conomos, 2012], notably: "The medieval neumatic notation had now become so complex and technical that only highly skilled cantors were able to interpret the symbols accurately".

⁵⁶³ I could not find reliable information on Aphonidēs' dates of birth and death, which seems surprising compared to the numerous information found on the Three Masters in the literature.

⁵⁶⁴ [Chrysanthos (de Madytos) and Rōmanou, 1973], later published as a book (but with many – mainly typographical – errors and stripped of most of the commentary part, while including a new introduction with more recent information on Chrysanthos and his book) as [Chrysanthos (de Madytos), 2010].

⁵⁶⁵ [Chrysanthos (de Madytos) and Pelopidēs, 1832].

notation⁵⁶⁶ [...] At about the middle of the seventeenth century several of the older music books start to be interpreted on the basis that the Great Signs are stenographic symbols and represent more or less lengthy groups of notes or extended melismas. The interpretation given to these neumes, however, was not uniform all over Greece [...] Every teacher of the same art invented his own 'method of interpretation', improving the system he had learned from his teacher. The imperfection of these improvements was so clear that the Patriarch Gregory V showed great interest in the radical reformations proposed in 1797 by Agapios Paliermos. He recommended the introduction of the European staff notation in the Greek Church. The Patriarchate—conservative and hostile to the West, as usual⁵⁶⁷—rejected this proposal.

⁵⁶⁶ Here, the author cites [Strunk, 1962, p.101–103] as a reference.

⁵⁶⁷ We shall disregard this biased commentary by Rōmanou, as she writes above that "Patriarch Gregory V showed great interest in the radical reformations proposed in 1797 by Agapios Paliermos"; moreover, staff notation would have most probably led to an accelerated Westernization (generally equated with "Modernization") of Byzantine chant and, at a time when no recording means existed, to an extinction of this chant. This bias is the more inexplicable when reading Chrysanthos' report on the same subject (translated by Rōmanou in [Chrysanthos (de Madytos) and Rōmanou, 1973, p.251-253]): "§78. Jacob the Protopsaltes, the successor of Daniel preserved what was delivered to him accurately, advancing persistently on the footsteps of his teacher and did not enjoy innovations that much. When Agapios Paliermos from Chios, who was sufficiently educated in European music, came to Constantinople and presented himself to the patriarch Gregory, he mentioned to his very holiness and the entire holy Synod that it would be advantageous if the cantors of the Great Church were taught a musical system composed by him [here, footnote 119 by Chrysanthos: 'He travelled through Europe in purpose, in order to be perfectly taught the music of the Europeans and then, returning to Greece to benefit his compatriots. So, after he became sufficiently strong in the music mentioned, he came to the Sacred Mount, but as he did not fulfill his aim there, he went to Ephesos. As he failed there too, he came to Constantinople during the first time that Gregory Peloponnesian from Smyrna was the patriarch and was teaching music with the notes of the Europeans. Failing again, he altered the system and when he came to Constantinople for a second and third time, he was using the alphabet. He died in Bucarest in the year 1815'] which was endowed with the gifts of the European system but did not participate in its defects and if they looked either to correct the ecclesiastical system, giving it the proper analogies, or to create another more up-to-date, or keep the one offered by Agapios himself and transcribe with this all the ecclesiastical chants known to them. **With such words he wholly convinced his very holiness** but was not able to attract Jacob completely. So, it was ordered that Agapios would teach in the Patriarchate and that the *domestikoi*, among others, would be taught by him [footnote 120 (here abridged): The right first cantor has the office called *protopsaltes*; the left first cantor has the office called *lampadarios*; the second cantors of the left and right choirs are surnamed *domestikoi*. The patriarchs in the course of time were greatly concerned with the preservation of ecclesiastical music.

Agapios proposed then the adoption of an alphabetical system of his own invention, which was given more consideration but was rejected all the same"⁵⁶⁸.

The Ecumenical Patriarchate was even more cautious about "innovations" because of previous attempts at introducing harmony⁵⁶⁹ in Byzantine chant:

"One highly controversial figure was the Cretan poet, theologian, calligrapher, singer, diplomat, scribe and priest Ioannes Plousiadenos (born around 1429) who later became Joseph, Bishop of Methone. After 1454, he was one of twelve Byzantine priests who officially supported the union of the Eastern and Western Churches ratified by the Ferrara-Florence Council of 1438 and 1439. [...] Very recently, evidence has been discovered of Plousiadenos's involvement in musical composition to serve the same end. In an attempt to introduce Western polyphony into the Greek Church, Plousiadenos wrote at least one, or possibly two, communion verses (*koinonika*) in a primitive kind of two-voice discant. Apart from these isolated examples, the experiment with Latin polyphony in the East had run its course, and inevitably so. It was not until several decades later that the choral *ison* or drone-singing was introduced into Greek church music, marking a fundamental change from the centuries-old monophonic tradition. The earliest notification of the custom appears to have been made in 1584 by the German traveller, Martin Crusius"⁵⁷⁰.

Whenever

"all previous attempts to achieve a reform had failed [...] because they all adhered to either of two extremely contrasted lines: one was a complete break with tradition, while the other displayed the traditional complexity and lack of clarity [...]. The Three Teachers secured the success of the New Method by following a middle line. They endowed their

→ Evidence of this is given here and in many other instances, but mostly in one document made at the time of the patriarch Neophytos [...]. However, because of the unpersuasion of the protopsaltes Jacob and his ironies on the pronunciation and the manner of teaching of Agapios, this attempt did not bear fruit. So, Jacob, the zealot of the ancient tradition of ecclesiastical music, set to music a *doxastikarion* in which he tried to include all the old *theseis* of the *sticherarion*, leaving not even the most commonly used among the later *theseis*. He wanted the old *theseis* to be pronounced according to the tradition of the old teachers and not to be altered with abridgements or other adornments. When he wished to use any of them in the new way, he was writing it explanatorily. In spite of that, he himself abridged—with embellishment, as he said—the great *kekragararia*, the *eothina* and the *polyeleos* of Daniel".

⁵⁶⁸ Rōmanou in [Chrysanthos (de Madytos) and Rōmanou, 1973, p. xviii and xx-xxi].

⁵⁶⁹ Initially in the form of Latin polyphony.

⁵⁷⁰ [Conomos, 2012].

system both with the simplicity, clarity and economy which permitted musical printing and with the adherence to tradition—no matter whether substantial or just formal—that permitted the adoption of the Method by the conservative Patriarchate⁵⁷¹.

The Three Masters introduced novelties such as the *πα βου γα δι κε ζω νη Πα* solmization (see Table 1), approximately equivalent to the *d e⁻ f g a b⁻ c d⁺*⁵⁷² degrees of the Western scale; they also introduced a new method for the quantification of the intervals composing the scale, based on a Zalzalian division of the Container intervals, which was the main cause why this theory was very rapidly rejected by Occidental musicians, composers and theoreticians.

Byzantine	<i>πα</i>	<i>βου</i>	<i>γα</i>	<i>δι</i>	<i>κε</i>	<i>ζω</i>	<i>νη</i>	(<i>Πα</i>)
transliterated	<i>pa</i>	<i>vu</i>	<i>gha</i>	<i>dhi</i>	<i>ke</i>	<i>zo</i>	<i>ni</i>	<i>Pa</i>
Western	<i>d</i>	<i>e⁻</i>	<i>f</i>	<i>g</i>	<i>a</i>	<i>b⁻</i>	<i>c</i>	(<i>d⁺</i>)

Table 1 Byzantine solmization and Western equivalents.

Being approved by the Ecumenical Patriarchate, however, the “New Method” spread quickly in the realm of Byzantine chant, and became the standard theory for this chant⁵⁷³ while allowing for the safeguarding of the Ancient repertoire⁵⁷⁴.

⁵⁷¹ [Chrysanthos (de Madytos) and Rōmanou, 1973, p. xxvi] – see also [Morgan, 1971, p. 90], notably: “These three musicians are said to have developed their new method of music theory and to have presented it in 1814 to their superiors. Patriarch Cyril VI and the Holy Synod, after being at first suspicious about the motives of these three men, finally became convinced of the worthiness of their efforts. As a result of these deliberations, Gregory was promoted to the position of a *lampadarios* and he and Chourmouziou were then appointed as instructors in the practice of music, while Chrysanthos was appointed an instructor in theory of music”.

⁵⁷² The minus signs of *e⁻* and *b⁻* mean that these notes must be lowered by an approximate quarter-tone.

⁵⁷³ [Morgan, 1971, p. 90-91]: “In a special school, founded in 1815 and later called the Third Patriarchal Music School [which lasted from 1815 to 1821, according to the author], knowledge of the new method was disseminated. Letters were sent from the Patriarchate to all the provinces urging promising students to come to Constantinople. Even those without financial resources were admitted for two years’ free study of music. At the end of this period a certificate was issued to each student stating that he was now qualified to teach the necessary foundations of the new theory of music. In this way the new approach to ecclesiastical music reached a nearly maximum exposure in a minimum of time”. See also for instance [Schartau et Troelsgård, 1997, p. 134], notably: “In the years 1814-15 a Patriarchal school of music was established in Constantinople with commission to reform the old Byzantine neumatic notation and increase the educational level of

Strangely enough, the Ecumenical Patriarchate initiated nevertheless a few decades later a second, sheer theoretical reform of Byzantine chant, which soon came to replace the Chrysantine theory of the scale...

THE REASONS FOR THE SECOND REFORM⁵⁷⁵

Despite the success of the “New Method”, the Ecumenical Patriarchate commissioned in 1881 a “Musical Committee” for the reform of Chrysantine theory⁵⁷⁶, presided by Archimandrite Germanos Aphtonidēs.

The official reasons for the Second Reform are listed in the introduction to the small booklet published by the Ecumenical Patriarchate⁵⁷⁷, and may be summarized thus⁵⁷⁸:

→ Greek Orthodox church singers. Under the guidance of the ‘Three Teachers’, a great number of *psaltai* were trained according to the notation and theory of the ‘*Nea Methodos*’, which reduced the stock of both interval signs (*fōnetika*) and phrasing or group signs (*hypostaseis*) in relation to the old notation. At the same time some of the rhythmical, intonational, and ornamental, or ‘exegetic’, practices of the period were explicated. Joasaph, a monk from the Pantokrator monastery on Mount Athos, was probably among the students of this school, which functioned until about 1821”.

⁵⁷⁴ [Levy and Troelsgård, 2001, article “Byzantine music” (iii) The New Method (‘Reformed’ or ‘Chrysantine’ notation)]: “A vast project of transcribing the Byzantine repertoires as practised in the 18th and 19th centuries, including ornamented versions of the late medieval repertory, was undertaken as part of the reform (e.g. the monumental series of autograph manuscripts by Chourmouziou the Archivist in GR-An)”.

⁵⁷⁵ For a thorough (though abridged) and classical *exposé* of the characteristics of the “New Method”, including information about the Second Reform, see [Skoulios, 2012].

⁵⁷⁶ [Morgan, 1971, p. 91]: “For more than fifty years the musical theories and practices of Chrysanthos remained unchallenged. The changeover to his method of learning Church Music was complete. The obvious simplicity of the new method of musical notation, as opposed to the excessively complex old system, encouraged the success of Chrysanthos’ teachings. However, in 1881 a Patriarchal Commission was founded by Patriarch Joakeim III to correct what were simply termed ‘mathematical errors’”.

⁵⁷⁷ *The Elementary teachings of ecclesiastical music elaborated on the basis of the psalter by the musical committee of the Ecumenical Patriarchate in the year 1883*, [Commission musicale de (Musical Committee of) 1881, Aphtonidēs, and al., 1888].

⁵⁷⁸ The following explanations are taken from a synthesis (with an exhaustive translation of the part dedicated to the reasons of the Second Reform) of the document of the Music Committee established by fr. Romanos Joubran (Lebanon).

“The Committee considered three reasons leading to the undertaken research, the first being the Historical importance of Liturgical music and the need for its reform.

The second reason was the infiltration of Occidental music in the daily life of the believers, through the musical and theatrical scene, the concerts, the music institutes; its results were an ever-growing influence of Occidental music which rapidly became overwhelming.

The third reason was the incapacity of many cantors to interpret the liturgical chants correctly.

To these three main reasons must be added the attempts of composers of Liturgical chants to associate their own compositions [notably polyphonic and westernized] with Traditional chanting [...]

It is [here...] reminded that the work of the Three Masters was substantial but did not fill [all] the gaps of Oriental music, in general, and of liturgical music, in particular, because of the lack of technological means, at the time, which would have allowed for scientific measurements of Musical intervals”.

As for the intervals proposed by Chrysanthos in the First Reform, the Music Committee states that “they were incomplete”, which would have driven him to “divide the scale [the octave] in 68 parts, and to quantify the intervals by following this division”.

The first “reason” cited above is a simple assessment of the importance of Liturgical music; the second reason (Western influence on Byzantine society, notably in Greece – although this is not stated explicitly in the document at this point) was of a more urgent nature⁵⁷⁹ whenever the third reason is a simple repetition of the reasons for the First Reform, and sounds more, in the light of the success of the New Method highlighted in the previous section, as a mere justification⁵⁸⁰ rather than a real reason for (a second) reform.

The only reasons which remained then⁵⁸¹ were the need to counter Occidental influence on Byzantine chant, and to “correct” the Chrysantine division of the octave and the resulting intervals.

⁵⁷⁹ Confirmed in the text of the Committee by “the attempts of composers of Liturgical chants to associate their own compositions with Traditional chanting”.

⁵⁸⁰ We will see that this reason justified the introduction of indications about the “attractions” in Byzantine chant theory.

⁵⁸¹ Regarding the “the incapacity of many cantors to interpret the liturgical chants correctly”, we shall see that these difficulties had a completely different source than the difficulties of cantors in the time of Chrysanthos.

These reasons may however, and eventually, only be understood through the investigation of the so-called “errors” in the intervals of Chrysanthos, a task which requires a (short) reminder about Oriental theories of the scale⁵⁸² prior or contemporary to the two Byzantine reforms...

*The theory of the First Reform*⁵⁸³

Addressing Oriental or “Eastern”⁵⁸⁴ theories of the scale (or the structuring of the Containing intervals with intervals of seconds) in the 19th-20th centuries can only be made through a meticulous understanding of the (theoretical) divisive process(es), generally based on the splitting of (parts of) the string(s) of an instrument, mainly a “poly-chord”, namely a lute type instrument⁵⁸⁵.

The typical scheme for dividing a tetrachord in “Arabian” theories of the scale implied the use of 7, unequal small intervals⁵⁸⁶, of which three were used to form a so-called (by Western musicologists) “major” tone, two for a *mujannab* (or “medium” tone) and one for the “half-tone”, expressed through various ratios or fractions of the tone as shown, for the most

⁵⁸² Of which Byzantine theories from the two reforms of the 19th century are a major component, albeit strongly underestimated in Arabian, Persian or even Turkish literature, mainly because of nationalistic concerns.

⁵⁸³ This section and the following contain limited mathematical material which I tried to simplify as much as was possible; Oriental theories of the scale cannot be scrutinized, however, without the recourse to the simple arithmetical procedures and explanations provided here; see also the section “The ‘small’ Indian tones and Urmawi’s *mujannabāt*” in [Beyhom, 2012, p. 74–75].

⁵⁸⁴ In the realm of *maqām* music.

⁵⁸⁵ The neck makes it easier to reproduce or project the theoretical mesh visually, by marking it; various ways of marking the neck of the ‘ūd have been used by Early Arabian theoreticians, for instance.

⁵⁸⁶ Beginning with (al-) Kindi’s pseudo-Pythagorean (“ditonic”) mesh on the neck of the ‘ūd which reproduces 7 intervals in the tetrachord (FHT 29, p. 195), then Fārābī’s mesh, based on a mixed ditonic-harmonic procedure (FHT 30, p. 195) and culminating in Urmawi’s highly sophisticated (but purely theoretical – I hope to be able to publish soon an article on the subject) Pythagorean mesh based on Pythagorean *leimata* and *commata* (not reproduced in this dossier but easily accessible in Musicological literature, including the seminal [Wright, 1969]). For an overall description of the transformations of the intervals of the Arabian (theoretical) scale prior to the 14th century, see [Beyhom, 2010c].

representative theories, in Table 3 (Green background).

Timeframe	Division of the tetrachord	Basis
< 14 th century	7 different intervals	mixed divisive procedures
Urmawī	7 intervals combining either of <i>L</i> (s) (<i>leimmata</i>) and <i>C</i> (<i>comma</i>)	theoretically pythag./divisive
pre 19 th century	10 intervals, equal or unequal	either equal-length or equal divisions
1 st Byzantine reform (1814)	28 (= 7 × 4) intervals, various (mixed divisive procedures)	<i>different values of internal intervals</i>
mid-19 th century (Hijāzi)	12 unequal intervals	equal-divisions of the strings
2 nd Byzantine reform (1881)	30 (= 10 × 3) equal intervals	equal-division of the octave
Turkish stand. division (20 th)	22 equal intervals	Pyth.-like division in Hold. commas

Table 2 Main procedures for the division of the tetrachord used in Oriental musics until the (Early) 20th century⁵⁸⁷.

These resulted in the 17-intervals division of the octave (Table 3 – Blue background) which predominated in the first centuries of Islam, and was perpetuated (in Urmawī’s formulation in his *Book of cycles*⁵⁸⁸) in Ottoman-Turkish later theories.

Whenever these (Earlier) formulations, were mostly prescriptive⁵⁸⁹, various reasons, including the growth of the repertoire, contact with the Occident and its notated music, etc., led to the need for a more

⁵⁸⁷ “< 14th century” = Arabian theoreticians of the scale including Kindī (9th century), Fārābī and till (Ibn) Zayla (included) and the Systematists (beginning in the late 13th century with Urmawī): this time period and division continues till the late 18th century (when it had to face the competition of other theories such as the 24 – or 28 – quarter-tones in the octave), and was still used in the 19th and the beginning of the 20th centuries; it survives, integrated in Yekta Bey’s division of the octave, in today’s Turkish (standard) theory of the scale (for the latter see FHT 24 to FHT 33 in [Beyhom, 2014a, p. 135–139], notably the last two figures) – see also Jean-Claude Chabrier in [Rashed, 2002] for detailed reports on the meshing of the fingerboard by various *maqām* theoreticians, for instance [p. 580] for the system of (Ibn) Sīnā.

⁵⁸⁸ For Urmawī and later Systematists, see [Wright, 1969].

⁵⁸⁹ Understand as “indicative”, i.e. giving only indications and approximate proportions for the Intervallic structures of Container intervals, either as guidance for the musician or as theoretical extrapolation of praxis. Note that Urmawī’s scale is completely prescriptive in this acceptation (more about prescriptive / descriptive notations in, evidently, [Seeger, 1958] but also the discussion in [Beyhom, 2015b, p. 499–508]).

descriptive formulation, with more subdivisions in the octave including the scales of the two byzantine reforms, but also the 24-quarter-tones “Modern” theory of the “Arabian” scale⁵⁹⁰ or the 28 *maqāmāt* (degrees of the general division of the octave) of Shihāb-a-d-Dīn al-Hijāzī⁵⁹¹.

Timeframe	Division of the octave	Basis
< 14 th century	17 different intervals	mixed divisive procedures
Urmawī	17 intervals combining either of <i>L</i> (s) (<i>leimmata</i>) and <i>C</i> (<i>comma</i>)	theoretically pythag./divisive
pre 19 th century	24 intervals, equal or unequal	either equal-length or equal divisions
1 st Byzantine reform (1814)	68 (= 17 × 4) intervals, various (mixed divisive procedures)	<i>different values of internal intervals</i>
mid-19 th century (Hijāzi)	24 unequal intervals	equal-divisions of the strings
2 nd Byzantine reform (1881)	72 (= 24 × 3) equal intervals	equal-division of the octave
Turkish stand. division (20 th)	53 equal intervals	Pyth.-like division in Hold. commas

Table 3 Main procedures for the division of the scale (octave) – (as for Table 3)⁵⁹².

Post-Ottoman Turkey chose a mixed procedure for the typical, today’s (so-called Yekta-Ezgi-Arel⁵⁹³) Turkish scale⁵⁹⁴, using a Pythagorean equal-division equivalent of the octave already addressed in the 18th century by Mercator⁵⁹⁵, namely the Holderian commas⁵⁹⁶. In the case of Turkish theories, however, the scale is based on an unequal, but symmetrical, 24-intervals division of the octave⁵⁹⁷.

The difficulties for these divisions (“General scales”) were found, however, not in the tetrachordal

⁵⁹⁰ See the next sub-section on Mikhā’il Mashāqa.

⁵⁹¹ See [Beyhom, 2012].

⁵⁹² The concepts of the Byzantine scale(s) as resulting (for the First Reform) from 17 × 4 or (for the Second Reform) 24 × 3 (or 12 × 6) intervals is explained in the following sub-sections.

⁵⁹³ Besides the passages addressing this theory in [Beyhom, 2014a] (and in French), see the seminal [Signell, 2004].

⁵⁹⁴ Still taught in conservatories and the basis of “Classical” Turkish music.

⁵⁹⁵ See footnote 333, p. 97.

⁵⁹⁶ As a reminder: 53 Holderian commas to the octave, 9 to the “whole” tone, and 4 for the “semi-tone” (*leimma*).

⁵⁹⁷ See FHT 33 illustrating Signell’s explanations of the Ezgi-Arel scale in [Beyhom, 2014a, p. 139]: the small elementary intervals (1 or 3 Holderian commas) amount to 24 intervals in the octave.

or octavial divisions, but in the tuning of the intervals of seconds that compose them (Table 4 and Table 5), especially the “medium tones” or *mujannab(s)*.

Timeframe	Division of the "disjunctive" (or "conjunction") tone	Basis
< 14 th century	3 different intervals	mixed divisive procedures
Urmawī	Combinations of 2 <i>L</i> (<i>leimma</i>) and 1 <i>C</i> (<i>comma</i>)	theoretically pythagorean
pre 19 th century	4 intervals, equal or unequal	either equal-length or equal divisions
1 st Byzantine reform (1814)	12 intervals, equal and unequal (mixed divisive procedures)	<i>different values of internal intervals</i>
mid-19 th century (Hijāzī)	4 unequal intervals – tones and <i>mujannab(s)</i> alike	equal-divisions of the strings
2 nd Byzantine reform (1881)	12 equal intervals	equal-division of the octave
Turkish stand. division (20 th)	9 equal intervals	Pyth.-like division in Hold. commas

Table 4 Main procedures for the division of the tone (as for Table 2)⁵⁹⁸.

Timeframe	Division of the <i>mujannab</i> (existence of the half-tone)	Basis
< 14 th century	different intervals (<i>leimma</i> , or <i>apotome</i> ?)	2 out of 3 in the tone, diff. values
Urmawī	2 <i>L</i> , or 1 <i>L</i> and 1 <i>C</i> combined either way (<i>leimma</i>)	no functional difference (theory)
pre 19 th century	3 intervals, equal or unequal (2 intervals)	"¼-tone division", 3 out of 4
1 st Byzantine reform (1814)	9 or 7 intervals, equal and unequal (no ½-tone, but ¼-tone)	<i>different values of internal intervals</i>
mid-19 th century (Hijāzī)	4 unequal intervals – tones and <i>mujannab(s)</i> alike – (2 intervals)	equal-divisions of the strings
2 nd Byzantine reform (1881)	10 or 8 equal intervals (6 = ½-tone, 4 = 1/3-tone but no ¼-tone)	equal-division of the octave
Turkish stand. division (20 th)	8 eq. interv. – " <i>dī-leimma</i> " – or (?) 5 – <i>apotome</i> – (<i>leimma</i>)	Pyth.-like division in Hold. commas

Table 5 Main procedures for the division of the *mujannab(s)* – (as for Table 3)⁵⁹⁹.

⁵⁹⁸ This table addresses the divisions of the Pythagorean, or of the equal-tempered tone.

⁵⁹⁹ The *mujannab* is a “medium” tone, and holds generally (and theoretically since Urmawī) 2 qualities: “greater” or “lesser” – see FHT 6 p. 182 for the different positions of *e* in the Arabian scale, and consider that the *mujannab(s)* are limited by the degrees *d e* and the degrees *e f* of the scale; whenever the lower *mujannab* (*d e*) becomes smaller, the higher *mujannab* (*e f*) becomes greater and *vice-versa*. Note that, in Traditional *maqām* music, the two

The existence of various formulations for these many-sided intervals, coupled with the desire for a descriptive notation led theoreticians in the Middle East to increase the numbers of smaller divisions of the scale in order to better approximate them. This tendency, concurrently with the influence of the Occidental equal-tempered concept of the scale predominating in the 19th century, led however to deep changes of the fundamental Oriental scale, while Oriental theoreticians passed on a double-edged sword to posterity.

MĪKHĀ'IL MASHĀQA'S EPISTLE AND THE “BYZANTINE DIVISION OF THE OCTAVE” (AS COMPARED TO THE “ARABIAN” 24-QUARTER-TONES DIVISION)

In 1847 (or 1849), the *Journal of Oriental and Asiatic Studies* published an article by Eli Smith⁶⁰⁰ entitled “A Treatise on Arab Music, Chiefly from a Work by Michail Meschakah of Damascus”.

Mikhā'il Mashāqa' *Epistle to the Emir Shihāb*⁶⁰¹, a small treatise on Arabian music at that time, is the first study of the Modern period on the Arabian scale and music and laid the foundation of Modern Arabian musicology⁶⁰².

→ (here successive) *mujannab(s)* were never equal one to the other, *i.e.* were never equal to an exact three-quarter-tones interval; in “Modern” *maqām* music, however, the trend leads – notably in Arabian countries, through the use of “Oriental Keyboards or quarter-tone-tuned *qānūn(s)* – to the equalization of these intervals: the term *mujannab* is anyhow hardly known to Conservatoire musicians today (who use the “three-quarters-of-the-tone” – or the “*bemol*-and-one-half” – terminology).

⁶⁰⁰ [Mashāqa and Smith, 1849].

⁶⁰¹ *A-r-Risāla a-sh-Shihābiyya fi-ṣ-Ṣinā'a al-Mūsiqīyya* – first publication (translated and augmented with limited excerpts from Fārābī – mainly concerning rhythm and metrics) in English ([Mashāqa and Smith, 1849]. There have been since some other publications in (the original) Arabic language ([Mashāqa, 1899; Mashāqa, 1996]), and a translation in French by Ronzevalle [Mashāqa, 1913]. The only known extant (probable) autograph [Mashāqa, s.d. (xix^e siècle)] is kept in the convent of Dayr al-Mukhallis in Joun - Lebanon.

⁶⁰² Although, according to Ronzevalle in [Mashāqa, 1899, p. 5], it was not well-known to musicians in the late 19th century, it was however known by theoreticians of the scale and musicians such as Kāmil al-Khulā'ī who freely copied, almost verbatim and in his *Kitāb al-Mūsiqī a-sh-Sharqīyy* [The book of oriental music] [Khulā'ī (al-), 1904], entire pages from Mashāqa's epistle (see also [Beyhom, 2014a, p. 89]).

Most importantly for our research however, is the fact that Mashāqa compares the 24-intervals scale he claims was followed by musicians at that time with what he calls the “scale of the Modern Greeks”⁶⁰⁷, i.e. the (as we shall see) Chrysantine division of the octave in 68, according to him, equal divisions he calls “minutes” (see Fig. 62); he further describes the differences between the intervals of the two systems as the Arabian scale having two types of intervals, the four-quarter-tones and the three-quarter-tones intervals, while the “Modern Greek” system uses three types of tones, the 12-, 9- and 7-minutes tones.

Whenever comparing the two octave scales (see Fig. 63), Mashāqa found no matches (convergences) between them except for the unison and the octaves.

It must be reported at this stage, however, that the Chrysantine scale is everything but based on an equal division of the octave⁶⁰⁸, which shows the deep misinterpretation by this author of Chrysanthos’ theory, a trait that he shared with most of his contemporaries and successors.

CHRYSANTINE THEORY OF THE SCALE EXPLAINED FROM AN OCCIDENTAL / ORIENTAL POINT OF VIEW

In 1821 a small booklet entitled (*An*) *Introduction to the Theory and Practice of Ecclesiastical Music*⁶⁰⁹ was published in Paris by the Kultura publishing house. It contained the essence of the New Method which Chrysanthos Karamellēs (“of Madytos”)⁶¹⁰ would expand and complete in his 1832 *Great theoretical book of music*⁶¹¹.

Whenever keeping a close connection with the previous notation, the theory of Chrysanthos reconnected Byzantine chant with Ancient Greek theories⁶¹², a fact which contradicts the alleged Patriarchal resistance to “Classical” Greek culture⁶¹³.

⁶⁰⁷ A confirmation of the fact that Byzantine chant was the reference “Greek” music at that time.

⁶⁰⁸ A fact discussed in the next sub-section.

⁶⁰⁹ [Chrysanthos (de Madytos), 1821].

⁶¹⁰ [Conomos, 2012]: “Chrysanthos of Madytos (ca. 1770- ca. 1840), an uncommonly well-educated and highly cultured hierarch, was primarily responsible for the [First] reform”.

⁶¹¹ [Chrysanthos (de Madytos) and Pelopidēs, 1832].

⁶¹² [Levy and Troelsgård, 2001, article “Byzantine music” (iii) The New Method (‘Reformed’ or ‘Chrysantine’ notation)]: “Most important was a theory recognizing the presence of more than one

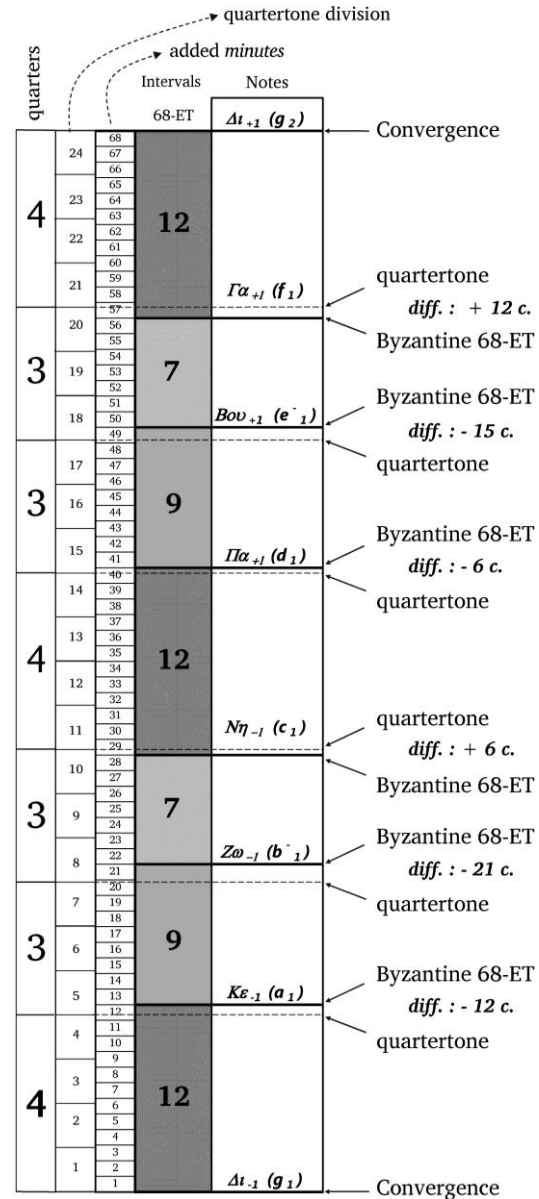

Fig. 63 Differences between the alleged Byzantine 68-ET system and the alleged (theoretical) “Arabian” division of the octave in 24 quarter-tones⁶¹⁴.

type of mode, based on the ancient division into diatonic, chromatic and enharmonic modes”.

⁶¹³ See the quote of footnote 534, p. 120; note also that most Ancient Greek treatises were reproduced in the various and successive editions of the *Suda*, as well as in other compendiums – see for instance [Mathiesen, 1999, p. 609–669 (Chapter VII - The tradition in the Middle Ages: Survival and Transmission)].

⁶¹⁴ Adapted and translated from [Beyhom, 2015b], with the “Arabian typical scale” (of *maqām Rāst*) to the left, in quarter-tones, and the “Modern Greek” scale on gray background, in “equal” minutes: the two systems converge only at the limits (unison and octave).

A more striking feature of the Chrysantine theory was however the complexity and (mostly) the subtlety in its formulation of the Byzantine “systems” (see Fig. 64 for an example of the *Chromatic*⁶¹⁵ systems), which provoked indignant reactions coming, mainly, from Occidental Hellenophiles⁶¹⁶ who busied themselves, in the late 19th century and the beginning of the 20th century⁶¹⁷, with Byzantine chant⁶¹⁸.

⁶¹⁵ Moreover, the classification of musical systems in Byzantine chant differs from the classifications of Western scholars, with Byzantine *diatonism* meaning “Zalzalian”, and *enharmonic* corresponding (more or less) to Western “diatonism”, i.e. to ditonism, but with the necessary inclusion (in Chrysantine theory – this changed with the Second Reform as explained in the next section) of one quarter-tone division in the tetrachord: it is easy to see that this adapted terminology seemed, at least, strange to Occidental theoreticians (refer to Chapter I), particularly the fact that the Chrysantine *enharmonic* systems (for example in a tetrachord with 12 13 3 minutes intervals, with the 3-minutes “quarter-tone” instead of the “half-tone”, seldom used in Chrysantine theory) changed completely the sense of “diatonism” as these theoreticians understood it. Byzantine terminology is discussed in detail in [Beyhom, 2015b], Chapter III.

⁶¹⁶ Or simply theoreticians.

⁶¹⁷ See for instance [Thibault (fr.), 1898, p. 246], notably: “we establish [in this article] that the work of Chrysanthos, from what we can judge after the thorough examination of Ancient manuscripts and of his [*Theōrētikon Mega*], is prejudicial to Byzantine music. This large didactic book has no respect whatsoever for the Ancient theory; [...] it pulled away, for half a century, any truly scientific research [on the true nature of Byzantine chant]” (in French: “nous établissons que l’oeuvre de Chrysanthos, telle que nous pouvons la juger après un examen sérieux des anciens manuscrits et de son [*Theōrētikon Mega*], a été très préjudiciable à la musique byzantine. Ce grand ouvrage didactique est sans égard ni respect pour l’ancienne théorie ; [...] pendant l’espace d’un demi-siècle, il en a écarté toute étude spéciale véritablement scientifique [sur la véritable nature du chant byzantin]”). Also [p. 269] in which the author compares Chrysanthos’ work with the destruction of the Parthenon by “a man who could not understand the real meaning” of Byzantine chant, which fr. Thibault obviously understood better than Chrysanthos and all the Byzantine cantors and theoreticians together... As another example, fr. Rebours managed in his *Treatise of Psaltic* (Byzantine liturgical chant) to rewrite a complete theory of Byzantine chant, notably modified for interval values, and otherwise completely based on the Chrysantine theory, without even mentioning Chrysanthos’ name before p. 126 (out of 289) of his book!

⁶¹⁸ A general feature of the studies on Eastern and Oriental musics is that 19th- and 20th-centuries Occidental scholars had little respect for the existing manuscripts and theoretical works, quickly dismissing any characteristics in those musics which did not fit their preconceived ideas as ridiculous or inappropriate – see for instance the reactions of Western musicologists to the “28 *maqāmāt*” of Shihāb-a-d-Dīn al-Ḥijāzī in [Beyhom, 2012].

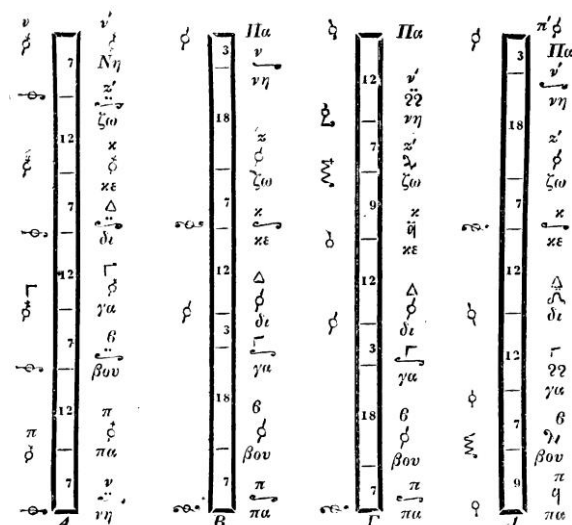

Fig. 64 Chromatic systems according to Chrysanthos Madytos, including the diphonic system (left)⁶¹⁹.

The backbone of Chrysantine theory remains however the *diatonic system* (Fig. 62) which reproduces the ascending scale of the First mode from $\pi\alpha$ to $\Pi\alpha$, or 9 7 12 12 9 7 12 (in Chrysantine “minutes”), a highly Zalzalian scale with a 12-minutes tone, a 9-minutes “medium tone” and a 7-minutes “small tone”⁶²⁰.

Whenever it is (and was) very tempting for inattentive readers⁶²¹ of Chrysanthos’ publications to consider the “minutes” of his intervals as equal-divisions of the octave⁶²², our author’s theory of the scale is clearly explained in the beginning of his book, on the example of a *tumbūr* (“tambour”, “pandouris” in various translations or transliterations⁶²³) – as shown

⁶¹⁹ [Chrysanthos (de Madytos) and Pelopidēs, 1832, p. 106-107, §245]; English equivalents in [Chrysanthos (de Madytos) and Rōmanou, 1973, p. 99].

⁶²⁰ Byzantine theoreticians understand “diatonism” as “the use of tones of different values in the tetrachord”, thus the “small tones”, “medium tones” and “complete” (or ‘grand’) tones” of Chrysantine theory.

⁶²¹ Or for theoreticians willing to overlook the implications of Chrysanthos’ theory.

⁶²² Such would have been the case of Mashāqa, for example, but only if he wrote his epistle having read only the 1814 booklet by Chrysanthos, as most of the information about the internal structuring of the Chrysantine scale is to be found only in the 1832 *Great theoretical book*; though most Western theoreticians did have access to the latter (while some of them seem to have had access exclusively to this 1832 treatise), they still deemed the Chrysantine scale as based on an equal-tempered division of the octave.

⁶²³ And obviously a long-necked lute.

in Fig. 65 and further explained in FHT 62, p. 233 – and following a procedure which could be summarized thus⁶²⁴: “take a *tunbūr* and apply then a series of additions and subtractions of string parts in order to obtain the scale of the *diatonic system* of Byzantine chant”.

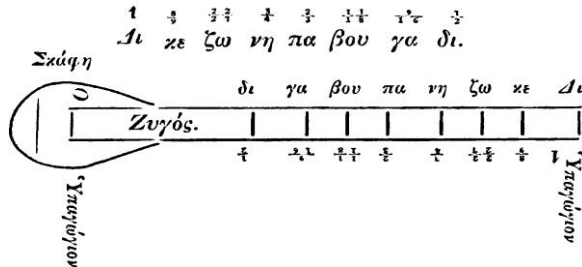

Fig. 65 Division of the strings on the *pandouris*⁶²⁵ according to Chrysanthos Madytos⁶²⁶.

	degrees							
	Δι	γα	βου	πα	νη	ζω	κε	Δι
Cumulative ratios	$\frac{1}{2}$	$\frac{9}{16}$	$\frac{11}{18}$	$\frac{2}{3}$	$\frac{3}{4}$	$\frac{22}{27}$	$\frac{8}{9}$	1
Cumulative intervals:	1200	996	852	702	498	355	204	0
Differential ratios	$\frac{8}{9}$	$\frac{81}{88}$	$\frac{11}{12}$	$\frac{8}{9}$	$\frac{81}{88}$	$\frac{11}{12}$	$\frac{8}{9}$	
Differential intervals:	204	143	151	204	143	151	204	

Fig. 66 Chrysanthos’ division of the strings of the *tunbūr* for the *diatonic system* uses ratios 8/9, 11/12 and 81/88, and is readily applicable to the Arabian *zalzalian system*⁶²⁷.

The result of this division is a *Zalzalian scale*⁶²⁸ with two *mujannab(s)* amounting to 151 cents

⁶²⁴ I am compelled to summarize considerably, in this section, the results of some 10 years of research published in [Beyhom, 2015b] (notably in Chapter 3), to which the reader can refer to for more substantial information on the two 19th-century reforms of Byzantine theories and their scales.

⁶²⁵ [Chrysanthos (de Madytos) and Pelopidēs, 1832, p. 28].

⁶²⁶ With the following caption (in [Chrysanthos (de Madytos) and Rōmanou, 1973, p. 24]): “The *diatonic scale* on the *diapason system*, on which the beginners are taught the quantity of melody”.

⁶²⁷ The use of the renowned “*Zalzalian wustā*” of Fārābī (in his *Kitāb al-Mūsīqī al-Kabīr* – see [Beyhom, 2010c, v. 1, p. 205, Figure 75]) with ratio 22/27 show that Chrysanthos was familiar with Arabian and Greek theories of the scale alike – see also the more detailed FHT 22, p. 190 in this dossier. This *Zalzalian* “third” (*wustā*) is also used by (al-) Khawārizmī and (al-) Ḥasan al-Kātīb (see [Beyhom, 2010c, v. 1, p. 193 & 224, Figures 72 et 80]).

⁶²⁸ Largely, if not completely occluded in Western reports on Chrysantine theory, and probably unknown to Mashāḩa at the

(9 minutes) and 143 cents (7 minutes) each, or quasi-exact matches of the three-quarter-tones interval. As for the internal composition of the intervals of the scale, a footnote⁶²⁹ in the *Great theoretical book* gives the clue for unequal minutes composing each “tone” interval (as shown in FHT 24, p. 191).

Whenever subtleties such as the composition⁶³⁰ of the *diphonic system* (see Fig. 64 – Left) remained unresolved for most despisers of Chrysantine theory⁶³¹, seemingly singular novelties such as accidentals for intervals⁶³² (in lieu of degrees of the scale – see Fig. 67) introduced even more discouraging elements for Western scholars, which raced in dismissing such an absurd theory.

An important characteristic of Chrysanthos’ *diatonic scale* is the existence of these three different “tones”, two of which (the 9-minutes and the 7-minutes intervals) are evident conceptual equivalents of the *mujannab(s)* of Ṣafīyy-a-d-Dīn al-Urmawī and earlier Arabian theories⁶³³.

Moreover, the division of the Chrysantine scale is an attempt at making the 17-intervals scale of the Arabian theoreticians of the Golden Age more descriptive, by dividing each interval into four small divisions which would result in the (17 × 4 =) 68 intervals composing the former scale, and by using specific intervals of second (see Fig. 68) for different types of scales (“*enharmonic*”, “*chromatic*” and “*diatonic*”).

time he redacted his epistle as the *Great theoretical book* of Chryshanthos was published first in 1832.

⁶²⁹ Which reminds me to remind the reader to “read the (foot- or end-) notes!”, in which he is due to find the clues for the author’s thought.

⁶³⁰ 64 divisions in the octave (instead of the 68 subdivisions common to other Chrysantine scalar systems) with an exclusive 12- and 7-minutes intervals scale.

⁶³¹ But are plainly explained in [Beyhom, 2015b]; the *diphonic system* is moreover the key to the full understanding of Chrysantine theory.

⁶³² A well-established procedure in Arabian treatises in the period preceding and following Chrysanthos’ theory, including in Mashāḩa’s and Khulaḩī’s theoretical books (cited above).

⁶³³ I explain in my book on Byzantine chant how Chrysanthos, in his *Great theoretical book of music*, often refers to Arabian music theory (not citing any theoretician however), and explains characteristics of Byzantine chant (notably the names of the *apechemata* – the introducing formulae of Byzantine modes) through Arabian terms (here the *tanīn*, or disjunctive tone, and the *baḩīyya*, the Arabian name for the “half-tone” or *leimma*).

Πλεονεξία μὲν Μειονεξία δὲ
 τὸ μὲν εἶ ἐνὸς τεταρτημορίου ¼ τὸ μὲν ζ' ἐνὸς τεταρτημορίου ¼
 τὸ δὲ ς' δύο τεταρτημορίων ½ τὸ δὲ η' δύο τεταρτημορίων ½
 τὸ δὲ ε' τριῶν τεταρτημορ. ¾ τὸ δὲ θ' τριῶν τεταρτημορ. ¾
 τὸ δὲ ς' ἐνὸς τριτημορίου ⅓ τὸ δὲ ζ' ἐνὸς τριτημορίου ⅓
 τὸ δὲ ξ' δύο τριτημορίων ⅔ τὸ δὲ ϑ' δύο τριτημορίων ⅔

Fig. 67 “Accidentals” (Interval modifiers) as explained in Chrysanthos’ *Great theoretical book of music*⁶³⁴; diminishing accidentals to the left, augmenting accidentals to the right (in fractions of the tone)⁶³⁵.

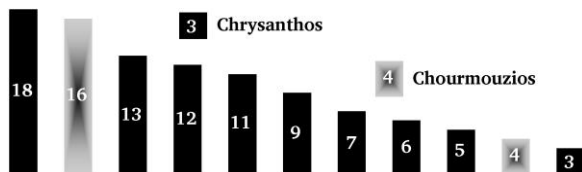

Fig. 68 Intervals of second explicitly used in Chrysanthos’ and Chourmouziotis’ “systems” and polychords⁶³⁶.

Concerning the general scale, and when accepting a theoretical equal-division of the octave as being representative not of the exact values of intervals but of their relative proportions⁶³⁷, the scale of Chrysanthos becomes thus a perfect match for the Zalzalian⁶³⁸ 17-intervals scale (see Fig. 69), regardless of minor⁶³⁹ discrepancies for the *mujannab*(s) bordering degrees (*e* and *b*).

Needless to say, all of these “Oriental” characteristics became rapidly disturbing in the context of frantic westernization of both Greece and Constantinople, and seemed irreconcilable with the Western theory of the scale for Occidentals and Byzantines alike, which led to considering Chrysantine theory as “faulty” (for the intervals) and “unscientific”

⁶³⁴ [Chrysanthos (de Madytos) and Pelopidēs, 1832, p. 101].

⁶³⁵ Accidentals are applied to *intervals* and diminish or augment them, successively in this figure and from top to bottom, by 1/4, 2/4, 3/4, 1/3 and 2/3 parts of the “disjunctive” tone.

⁶³⁶ As deduced from [Chrysanthos (de Madytos), 1821; Chrysanthos (de Madytos) and Pelopidēs, 1832] and from [Chrysanthos (de Madytos) and Chourmouziotis (Chartophylax), 2012]: the 6-minutes interval (“half-tone”) is seldom used, whenever the 3-minutes “enharmonic quarter-tone” exists in all “enharmonic” scales.

⁶³⁷ As “elementary intervals”: see [Beyhom, 2010a; 2013] for the difference between “elementary”, “measuring” and “conceptual” intervals, along with footnotes 26 (p. 54) and 331 (p. 96). The 17-(equal-)intervals “Arabian” scale is a theoretical development I have introduced in my publications 10 years ago, and will be expanded in (hopefully) my next book on Arabian music theories of the scale (Tome 2).

⁶³⁸ And theoretical, as deduced from my researches on the subject.

⁶³⁹ Because both “scales” are here a conceptual representation of the structure of the general scale for each music.

(i.e. ignoring recent European theoretical developments) which was however far from being the case.

minutes	17-ET	Name of the Arabian degree of the scale	intervals (17 th ET)	intervals (68 th ET)	Byzantine	Western eq.
68		NAWĀ (1)			Δι'	g'
67						
66		HĪJĀZ (1)				
65						
64						
63						
62		SĀBĀ (7 ⁺)	3	12		
61						
60						
59						
58		JAHĀRKĀ (7)			Γα	f
57						
56						
55						
54		BŪSĀLĪK (6 ⁺)	2	7		
53						
52						
51						
50					Bov	e ⁻
49						
48		SĪKĀ (6)				
47						
46						
45		KURD(Ī) (6)	2	9		
44						
43						
42		DŪKĀ (5)			Πα	d
41						
40						
39						
38						
37		ZĪRKŪLĀ (5)				
36						
35						
34						
33		KUNNĀZ ₋₁ (4 ⁺)	3	12		
32						
31						
30		RĀST (4)			Nη	c
29						
28						
27						
26						
25		KAWASHT (3 ⁺)	2	7		
24						
23						
22					Zω	b ⁻
21		IRĀQ (3)				
20						
19						
18						
17		'AJAM ₋₁ (3)	2	9		
16						
15						
14						
13		'USHAYRĀN (2)			Kε	a
12						
11						
10						
9		SHŪRĪ ₋₁ (2)				
8						
7						
6						
5						
4						
3						
2		HĪṢĀR ₋₁ (1 ⁺)	3	12		
1						
1		YĀKĀ (1)			Δι	g'

Fig. 69 Comparing pseudo-Byzantine 68-ET and pseudo-Arabian 17-ET divisions⁶⁴⁰: the degrees of the two scales match together except for a one-minute division between the “neutral” notes (*Zω* = *b⁻* and *Bov* = *e*).

* *

Chrysanthos Madytos was well aware of both (for instance) the theory of Acoustic resonance and of the Western representations of the scale at that time. With

⁶⁴⁰ Adapted and translated from [Beyhom, 2015b]; “17-ET” = “octavial 17-divisions equal-temperament”.

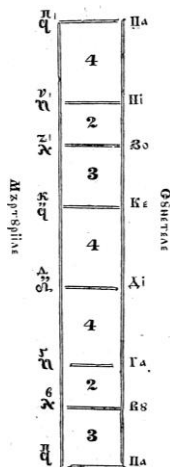

Fig. 72 Division of the Byzantine octave as shown in [Pann, 1846, p. 8].

Whenever such efforts still remained in the realm of the “Orient”, the Second Reform of Byzantine chant, which was prepared years before Aphtonidēs was appointed president of the “Music Committee”⁶⁴⁹, ostensibly aimed at the safeguarding of “Byzantine Oriental music”.

This was a very interesting allegation as we shall see in the maturation process of this Second reform, namely in the correspondence between Aphtonidēs and Bourgault-Ducoudray prior to the reform, but also in the writings of the two protagonists, namely in the “Music Committee” booklet of 1883 for the latter.

BOURGault-DUCOUDRAY AND GERMANOS APHTONIDĒS – OR AN INSIGHT OF BYZANTINISM IN OPERATION⁶⁵⁰

It should be noted here that although Louis-Albert Bourgault-Ducoudray played a major role, through his discussions with Germanos Aphtonidēs, in the Second Reform of Byzantine chant (theory), this role was only circumstantial (and symptomatic) whenever the social and historical backgrounds of Byzantine chant⁶⁵¹ at that time represent the main factors which led the

⁶⁴⁹ The 1881 Music Committee for Byzantine music created by the Ecumenical Patriarchate.

⁶⁵⁰ Most of the information listed in this sub-section (and unless otherwise stated) come from the article [Baud-Bovy, 1982] (dedicated to this subject – large excerpts are proposed in Chapter III of [Beyhom, 2015b]), in which the author explains how Bourgault-Ducoudray became involved in Byzantine chant and later connected with Tantalidēs and Aphtonidēs, and provides various excerpts from their correspondence in the years prior to the Second Reform.

⁶⁵¹ Whether in the Ottoman Empire or Greece, if not in other countries of the Orthodox realm.

Ecumenical Patriarchate to commission another formulation of Chrysantine theory⁶⁵², more compatible with the urge for⁶⁵³ Western culture⁶⁵⁴.

Bourgault-Ducoudray’s approach to Byzantine chant and his plea for a (second) reform are however typical, in both his judgments on Byzantine chant and its theory⁶⁵⁵ as well as through his reckless interventionism in the maturation process of the Second Reform, of Occidental composers and theoreticians at that time⁶⁵⁶. His discussions with the (soon to be) most influential scholar of Byzantine chant in the second half of the 19th century provide also a privileged insight on musicological Orientalism and Hellenism in operation, with the declared purpose of changing a “Foreign” music.

*
* *

In 1874 Louis-Albert Bourgault-Ducoudray⁶⁵⁷ left Paris for a trip to Greece during which he acquired knowledge of Byzantine chant. He went back to Greece in 1875, sent by the French government to study (further) Greek music, and stayed for a while in Athens where he became acquainted with the Chrysantine theory, then in Smyrna and Constantinople (Istanbul)

⁶⁵² Which, it seems, rapidly became “foreign” or incomprehensible to his nearly immediate successors, or simply discarded by a pseudo-scientific argumentation as will be shown in this section.

⁶⁵³ Or the strain of.

⁶⁵⁴ Note that the Ottoman empire itself underwent a series of reforms (namely the *Tanzimat*) in the period preceding the Second Reform of Byzantine chant (see for instance, about this largely documented fact, [Anon. “History of the Ottoman Empire”, 2016] “Decline and modernization (1828–1908)” or [Reinhard and Reinhard, 1996, p. 47].

⁶⁵⁵ He published, notably, an abridged translation of Chrysantine theory in [Bourgault-Ducoudray, 1877]; note that in a later work in which he publishes “30 melodies from Lower Bretagne, collected and harmonized”, the author, while notating all these “harmonized” melodies semi-tonally, stresses [Bourgault-Ducoudray and Coppée, 1885, p. 6] the relation of both musics, Byzantine and Breton, with the music of “Antiquity” (“la musique antique”).

⁶⁵⁶ The question that will arise is whether this behavioral pattern has ever changed since.

⁶⁵⁷ Bourgault-Ducoudray was a French conductor and composer (of notably exotic music) and a native of Bretagne – see [Brody and Smith, 2001; Anon. “Louis-Albert Bourgault-Ducoudray”, 2016].

where⁶⁵⁸ he met two blind Greek musicians which happened to be no less than Ilias Tantalidēs, a well-known teacher, poet and composer, and archimandrite Germanios Aphtonidēs⁶⁵⁹, who had recently left England to Greece⁶⁶⁰, and who was also a poet, a music teacher⁶⁶¹, and a polyglot notably at ease in the French language.

Both musicians were acquainted with European music and expressed, during their discussions with our traveller, their appreciation of it in parallel to their fears that the Greek craze for Occidental civilization be at some point fatal for traditional Byzantine chant.

While Bourgault-Ducoudray admired Aphtonidēs and considered him as “the last of the Byzantine men of learning”⁶⁶², he maintained a steady relation with the latter and corresponded with him about Byzantine chant for the next few years: the correspondence between these three men⁶⁶³ provides the researcher with privileged information about the genesis⁶⁶⁴ of the Second Reform of this chant.

*
* *

In order to understand the pace and changes in Aphtonidēs’ thoughts on Byzantine chant, we may want to start with a letter⁶⁶⁵ addressed by him to Tantalidēs (prior to the death of the latter on the 31st of July 1876), in which he states his concerns about the

future of Byzantine chant and “Foreign influences”⁶⁶⁶, and complains about the lack of ability of most cantors due to the Chrysantine theory, “which notably facilitated the teaching method but differs as much from the Earlier system as letters of the Alphabet differ from the meaning of a sentence”. The ease with which the new generations of cantors learned the theory dispensed them from a thorough apprenticeship of the subtleties⁶⁶⁷ of the chant itself, he added, expressing thus a general truth for musics moving from oral to written forms⁶⁶⁸ and losing through notation part of their (melodic or rhythmic) complexity.

Moreover, Aphtonidēs criticizes the distinction between *diatonic*, *chromatic* and *enharmonic genera* as being obsolete⁶⁶⁹, as well as he rejects the octavial formulations of the scale in Chrysantine theory, arguing that “the Old system was based on tetrachords and pentachords only”⁶⁷⁰.

But most of all, the future president of the Music Committee of 1881 acknowledges in this letter the possibility of using the Occidental staff for notating Byzantine chant, while insisting on adding special accidentals for the quarter-tones and the three-quarter-tones intervals (and considered the introduction of a “quarter-tones organ”), even if this meant the disuse of thirds of the tone delineated by some frets of the *tunbūr*.

Note that Bourgault-Ducoudray had previously⁶⁷¹ urged Aphtonidēs to *keep* the quarter-tones in Byzantine chant but to let go of the thirds of the tone:

⁶⁵⁸ And in the neighboring island of Chalki, in which Tantalidēs taught and where he was often met by Aphtonidēs.

⁶⁵⁹ Also a composer.

⁶⁶⁰ Aphtonidēs was until 1874 the head of the Orthodox community in London, which he was compelled to leave after he was suddenly stricken blind while celebrating a marriage.

⁶⁶¹ Notably in flute, violin and guitar.

⁶⁶² Bourgault-Ducoudray, in his *Souvenirs d'une mission musicale en Grèce et en Orient* [*Memorabilia of a musical mission in Greece and the Orient*] describes (notably in [Bourgault-Ducoudray, 1878, p. 18–20]) his encounter with Aphtonidēs and Tantalidēs and expresses his admiration for, amongst other qualities, the mastery of European music and vast knowledge of the first, and for the outstanding memory of the second which allowed him to reproduce all the chants of Byzantine repertoire by heart.

⁶⁶³ And the two works of Bourgault-Ducoudray on Byzantine chant, cited below.

⁶⁶⁴ And the reasons.

⁶⁶⁵ Probably dictated, and posterior to his first discussions in 1875 with Bourgault-Ducoudray and to the latter’s letter of March 1876 cited below.

⁶⁶⁶ From European music but also from Arabian-Persian music (according to Baud-Bovy who does not cite Turkish or Ottoman music).

⁶⁶⁷ Generally taught orally in Oriental musics.

⁶⁶⁸ Although Byzantine music was transcribed prior to the New Method, this notation was so complex that, as we have seen above, it prevented the cantors from assimilating the repertoire before long and arduous years of learning of both notation and chant; whenever easier means of teaching were provided, cantors could rapidly learn the new notation but did not take the time then to learn the subtleties of the repertoire itself, mostly by discerning the specific shades of each mode and chant (were they rhythmic or melodic) and by being able to reproduce them. The same process took place in other *maqām* musics as explained in the next chapter.

⁶⁶⁹ “Fictitious” according to Baud-Bovy.

⁶⁷⁰ See the discussion on “The ‘superior structuring role of the octave’” in Chapter 3.

⁶⁷¹ In a letter dated 29th March 1876: this letter is mentioned in Aphtonidēs letter to Tantalidēs.

“Believe me, do not be so scrupulous regarding the thirds of the tone. I understand your scruples, but you must lose something if you do not want to lose everything. **You can only save your Ecclesiastic music by regularizing it:** the only practical way is to consecrate and endorse its performance on the quarter-tone⁶⁷² organ. If this organ is acknowledged by the majority, your chances of convincing everybody augment, whenever if it is rejected everything is lost, you fall back into elusiveness, into arbitrariness, into musical mess⁶⁷³”.

Whenever this quote shows the rejection of melodic subtleties in Byzantine chant by the author, let us cite here, among the many other things⁶⁷⁴ that Bourgault-Ducoudray loathed in this chant, the nasal vocal style of the cantors at that time⁶⁷⁵, the use of the *ison*⁶⁷⁶, and finally the lack of polyphony, notably in

⁶⁷² Compare this statement with the quote from the same author in footnote 810, p. 155.

⁶⁷³ “Croyez-moi, ne soyez pas si scrupuleux, à l’endroit des tiers de ton. Vos scrupules, je les comprends. Mais il faut savoir sacrifier quelque chose pour ne pas tout perdre. Vous ne pouvez pas sauver votre musique ecclésiastique, qu’en la régularisant (*sic*): le seul moyen pratique est d’en consacrer et d’en sanctionner l’exécution sur l’orgue à quarts de ton. Si cet orgue est reconnu apte à contenter la majorité, vous avez de fortes chances d’amener à vous tous les esprits, s’il est repoussé, tout est perdu, vous retombez dans le vague, dans l’arbitraire, dans le *gâchis musical*...” – quoted from [Baud-Bovy, 1982, p. 157].

⁶⁷⁴ And based on his own writings.

⁶⁷⁵ Also in the Bretagne as he relates in his *Trente mélodies populaires de Basse-Bretagne* [Bourgault-Ducoudray and Coppée, 1885, p. 7]; as quoted further in the main text, this style is, for Bourgault-Ducoudray, an “abnormality” in music.

⁶⁷⁶ In [Bourgault-Ducoudray, 1877, p. 5] the author reproves “this monotonous, this tasteless, this ruthless *ison* which has, on an expressive melody, the effect of a pale driven through a human body” (see also [Bourgault-Ducoudray, 1878, p. 18]); according to [Baud-Bovy, 1982, p. 158], “it is certainly to [Bourgault-Ducoudray] that refers Aphonidēs when he mentions to Tantalidēs those who, ‘not having deepened the character of Sacred music, cannot stand continuous *ison* as a Harmonic element’”. Bourgault-Ducoudray’s position is not unique among Westerners, some of them having however eventually made their peace with this technique: “The idea is to keep the singer in the key. When I first had to make myself sufficiently acquainted with this music to be able to transcribe it and perform it, I could not understand why so much stress was laid upon the *Ison* and the key; but when I heard a good Arab singer attempt to sing the ‘Grand Doxology’ [a particularly complex composition which uses all 8 modes of Byzantine chant] I realised very vividly the use of the *Ison*, and the difficulty there was in keeping the singer in his key. The Oriental ear being much more subtle than ours in certain respects, I have no doubt he was very often in the key when one thought he was not. The necessity of these *Ison*[s] therefore became all the more apparent” – [Terry, 1908, p. 58] (see also the explanations of [Papachristopoulos, 2009, p. 307] – in German).

the version of this chant promoted by the Ecumenical Patriarchate; in the same way as he tried to influence Aphonidēs to let go of the “thirds-of-the-tones”, our Hellenophile endeavored to convince him to harmonize Byzantine chant:

“I played for Mr Aphonidēs a few attempts at harmonization applied to Religious chants, while taking care of reducing the chords to the smallest possible number and simplifying them as much as possible. Despite his instinctive reluctance for what he saw as a profanation, I succeeded in making him accept two harmonizations that we named, euphemistically in the light of their primitive simplicity, double *ison*. This experiment proved to me that one and the same person can understand and feel both Byzantine chant and European music, something that I thought until then impossible. **It should not be inferred from this fact an argument in favor of the conservation of Byzantine art as is.** General opinion in the Orient⁶⁷⁷ is that a musical reform has become a necessity⁶⁷⁸”.

While this and other attempts by the French composer did not seem to convince Aphonidēs of the necessity of harmonizing Byzantine chant⁶⁷⁹, Bourgault-Ducoudray eventually delivered a synthesis of his views on the future of Byzantine chant⁶⁸⁰:

“We have already described the state of decadence in which Greek ecclesiastic music has fallen, concerning both theory and praxis. **We think nevertheless that it would not be wise to destroy this music:** - Because it is a National cultural heritage and represents a tradition both religious and

⁶⁷⁷ This is a really large consensus that Bourgault-Ducoudray invokes in this sentence.

⁶⁷⁸ “Je jouai à M. Aphonidēs quelques essais d’harmonisation appliquée à des chants religieux, et j’eus soin de réduire les accords au plus petit nombre et à la plus grande simplicité possible. Malgré sa répugnance instinctive pour ce qu’il regarde comme une profanation, je réussis à lui faire accepter deux harmonisations que nous baptisâmes par euphémisme, vu leur simplicité primitive, du nom de double *ison*. Ces conversations m’ont prouvé que la même personne peut comprendre et sentir la musique byzantine et la musique européenne, chose que je croyais jusqu’alors impossible. **Il ne faudrait pas tirer de ce fait un argument en faveur de la conservation de l’art byzantin tel qu’il est.** L’opinion générale en Orient, c’est qu’une réforme musicale est devenue nécessaire” – [Bourgault-Ducoudray, 1878, p. 21].

⁶⁷⁹ “With regard to harmony, I am in the opinion that it was never in use in Sacred music” (in French: “Pour ce qui est de l’harmonie, je suis de ceux qui pensent qu’elle n’a jamais été usitée dans la musique sacrée” – Aphonidēs as quoted in [Baud-Bovy, 1982, p. 158]).

⁶⁸⁰ In which he disapproves even of the “quarter-tones” but, as the quote shows, only in unaccompanied singing – see also footnote 810, p. 155.

political; - Because it can only be replaced by the music of the Russian Church, an art which is appropriate, but banal and characterless; - Because religious music, when *reformed*⁶⁸¹ and *improved*, can be used as a starting point for the creation of a truly original musical language, proper to the Nations of the Orient. Above all, Ecclesiastic chant should be reformed in its *performance*. As long as cantors keep on singing nasally, bleating and quavering, and small children keep on screaming and shrieking, we should not be surprised of the discontent and the disgust of the audience, provided the latter is not completely deprived from education and musical sense. There may have been a time when ideal beauty in music, for Orientals, consisted in the capacity to sing nasally. Today, the predominance of the European taste rejects this oddity as the abnormality that it really is, and requires most emphatically a natural vocal emission. The abuse of grace notes, which cripples the most expressive melodies, could easily disappear. The contemporary style would be readily [advantageously] replaced with a simpler, larger execution, less fraught with *fioritura*. Lastly, and mostly, Byzantine chant should be *in tune*. Unfortunately, the use of the *three-quarter-tones* and *five-quarter-tones* intervals adds a nearly insurmountable difficulty to the interpretation of a music with no instruments whatsoever⁶⁸².

⁶⁸¹ As a reminder: I use bold font in quotations to draw the attention of the reader on particular points, while italics in quotes are by the authors of the cited works.

⁶⁸² “Nous avons dit [...] dans quel état complet de décadence est tombée la musique ecclésiastique grecque, au double point de vue de la théorie et de la pratique ; malgré cela, nous pensons qu’il ne serait pas sage de détruire cette musique : - Parce qu’elle constitue un patrimoine national et représente une tradition à la fois religieuse et politique ; - Parce qu’on ne peut la remplacer que par la musique de l’Église russe, art correct, mais banal et sans caractère ; - Parce que la musique religieuse, *réformée* et *améliorée*, peut servir de point de départ à la création d’une langue musicale originale et véritablement propre aux nations de l’Orient. D’abord, il faudrait réformer le chant ecclésiastique *dans son exécution*. Tant qu’on entendra des chœurs nasiller, chevrotter et bêler, des enfants hurler et glapir, on ne devra point s’étonner si cela provoque de l’humeur et du dégoût dans l’assistance, pour peu qu’elle ne soit pas tout à fait dénuée d’éducation et de sentiment musical. Il a pu y avoir une époque où le beau idéal en musique consistait, pour les Orientaux, à savoir chanter du nez. Aujourd’hui, la prédominance du goût européen rejette cette bizarrerie comme une monstruosité et réclame énergiquement une émission vocale naturelle. L’abus des notes d’agrément, qui défigure les mélodies les plus expressives, pourrait facilement disparaître ; le style actuel serait avantageusement remplacé par une exécution plus simple, plus large et moins hérissée de fioritures. Enfin, et surtout, il faudrait *chanter juste*. Malheureusement, l’emploi des intervalles de *trois quarts* et de *cinq quarts de ton* ajoute une difficulté presque insurmontable à l’interprétation d’une musique qui ne comporte l’emploi d’aucun instrument” – [Bourgault-Ducoudray, 1877, p. 65–66].

Finally, and while, in the opinion of Bourgault-Ducoudray, “Pure archeology” could be of importance for the retrieval of Ancient characteristics of Byzantine chant, its final salvation stands however with polyphony:

“Greece needs *living* music and not *mummified* music. [...] Dead art cannot be revived. [...] We think that the equally legitimate interests, which create two opposite trends in the opinion, would be satisfied by the introduction of *polyphony* (which is the prime example for modernity) in Ecclesiastic music while safeguarding the *modes* (which represent the National and traditional element)”⁶⁸³.

There can be no doubt that such a line of thought influenced the decision-makers in Byzantine chant⁶⁸⁴ and urged them for another, Second reform, although the changes were not formulated in the way prescribed by Bourgault-Ducoudray.

*The Second Reform – A radical change in the conception of Byzantine chant theory*⁶⁸⁵

In the light of the historical and social developments of Byzantine society in the 19th century, it is no wonder that the Ecumenical patriarch Joakeim III would establish a Music Committee in charge of researching “the ameliorations and rectifications needed in the theory and praxis of Byzantine music”, and that he would summon Aptonidēs to preside it⁶⁸⁶.

⁶⁸³ “La Grèce a besoin d’une musique *vivante* et non d’une musique *momie*. On [...] ne saurait ressusciter un art quand il est mort. [...] Suivant nous, les intérêts également légitimes qui créent dans l’opinion deux courants contraires, pourraient être satisfaits, si l’on introduisait dans la musique ecclésiastique la *polyphonie* (qui représente l’élément moderne par excellence), tout en sauvegardant les *modes* (qui représentent l’élément traditionnel et national)” – [Bourgault-Ducoudray, 1877, p. 66].

⁶⁸⁴ Bourgault-Ducoudray had much faith in Aptonidēs reforming “mission” and hoped ([Bourgault-Ducoudray, 1878, p. 20]) that he (Aptonidēs) would end up writing a book on the subject.

⁶⁸⁵ For a summary (in French) of the text and information of the booklet of the Music Committee of 1881, see [Borrel, 1950]; for detailed explanations on the scales (and theory) of the Second Reform as compared to Chrysantine scales and scales in Arabian Byzantine chant, see [Beyhom, 2015b] (in French too).

⁶⁸⁶ [Baud-Bovy, 1982, p. 154–155]: far from being trivial, the assignment of the post of president of the Music Committee shows that the Ecumenical patriarch wanted a man with such vast culture as Aptonidēs at this position, having extended knowledge of Occidental music as well as a staunch defender of “Oriental” Byzantine chant.

Let us note from the outset that, of the impressive number of innovations listed in Aptonidēs' letter to Tantalidēs, none was kept in the results of the works of the Second Reform except the "Ecclesial Psaltery" which was eventually constructed (see Fig. 73) but tuned, however, in sixths of the tone, excluding thus the quarter-tone and the three-quarter-tones intervals⁶⁸⁷.

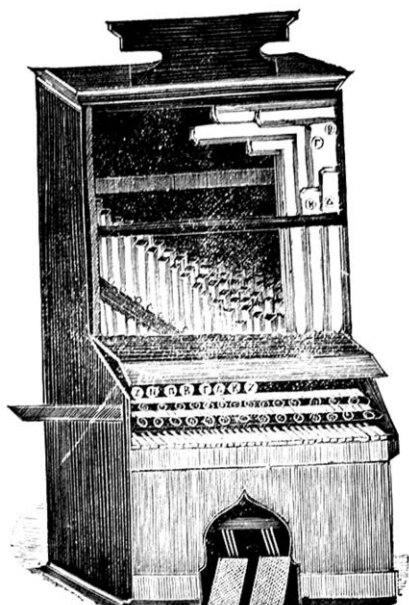

ΕΚΚΛΗΣΙΑΣΤΙΚΟΝ ΨΑΛΤΗΡΙΟΝ

Fig. 73 The "Ecclesial Psaltery" built specially for the "Music Committee" of 1881, in sixths of the tone and with three keyboards⁶⁸⁸.

⁶⁸⁷ As well as all odd multiples of the quarter-tone, a fact that Baud-Bovy seems to have overlooked when stating that the "Ioakimion Psalterion [inaugurated in the summer of 1882 by Aptonidēs] was a harmonium with the octave divided not only in 24 quarter-tones, but in 36 intervals" – [Baud-Bovy, 1982, p. 157]; the 36 intervals cited by the author result from the sixth of the tone division: it may have been that Baud-Bovy confused it with the theoretical division intended by the Music Committee, conceived as a 72-ET division (1/12 – of the tone – is a common divider of 1/3 and 1/4, whenever 1/6 is not), but building a psaltery in 12^{ths} of the tone seemed too difficult then (see [Beyhom, 2015b, p. 278]), as it would have required four keyboards instead of three (see [Beyhom, 2015, p. 503 – footnote 3237] for more details on microtonal keyboard instruments and their usage).

⁶⁸⁸ [Commission musicale de (Musical Committee of) 1881, Aptonidēs, and al., 1978, p. 30]: the three keyboards are needed because of the sixth of the tone division; a quarter-tone division would have required only one additional (with twelve notes per octave) keyboard (see previous footnote). Note also: "with an instrument like the harmonium or the organ we are not only sure that the accompaniment is in tune (a quality frequently missing for non-accompanied voices), but still it suffices for one person to

Whenever one other proposition of Aptonidēs in this letter, namely the inclusion of the phenomenon of the "attraction"⁶⁸⁹ was implemented in the reform, the only changes that eventually really mattered were the modification of the scale, and of the "emmelic" intervals (of second).

I shall demonstrate, in the following pages how and why Aptonidēs, despite his (alleged?) aim at safeguarding "Oriental" Byzantine chant, and despite his refusal of Occidental novelties he may have envisioned formerly, brought about however a major change in Byzantine theory by making it compatible with Western theories of the scale.

THE THEORETICAL SYSTEM OF THE SECOND REFORM

The scale and theory issued from the Second Reform are, at first glance (see Fig. 74), only slightly different from Chrysantine theory with the intervals composing the *diatonic* (Zalzalian?) scale holding the values (in multiples⁶⁹⁰ of the smallest division of the octave) 12 for the tone, 10 for the medium tone⁶⁹¹ and 8 for the small tone⁶⁹².

Moreover, *enharmonic* scales in this theory, notably one of the scales of the 3rd mode (shown in Fig. 75 – Left), use exact (equal-tempered as a matter of fact) tones and half-tones, a fact which underlines the compatibility of this theory with the Western ditonic formulation, while *chromatic* scales have a mixed configuration resembling Chrysantine, but still use half-tones and third of the tones instead of *mujannab*

→
sing and another to accompany her (him) to produce a complete polyphonic impression, whenever Vocal polyphony requires the gathering of several experienced singers" – in [Bourgault-Ducoudray, 1877, p. 68] {and the original quote: "Avec un instrument comme l'harmonium ou l'orgue, non-seulement on est assuré de la justesse de l'accompagnement (qualité qui fait souvent défaut aux voix seules), mais encore il suffit d'une personne qui chante et d'une autre qui joue pour produire un effet de polyphonie complet, tandis que la polyphonie vocale exige la réunion de plusieurs chanteurs exercés"}.

⁶⁸⁹ Intervals in a mode change in accordance with the direction of the melody.

⁶⁹⁰ Note that all intervals in the theory of the Second Reform are expressed, for practical use, with even integers (minutes), *i.e.* in sixths of the tone.

⁶⁹¹ The theoretical formulation in the [Commission musicale de (Musical Committee of) 1881, Aptonidēs, and al., 1888] booklet is $800/729$, approx. 161 cents.

⁶⁹² With a theoretical ratio $27/25$, approx. 133 cents.

intervals⁶⁹³ (see an example in Fig. 75 – scale of the 6th mode).

12
8
10
12
12
8
10

Πα

Fig. 74 The diatonic scale of the Second reform.

12	4
6	20
12	6
12	12
6	4
12	20
12	6

Nη
Πα

Fig. 75 Enharmonic scale of the 3rd mode (left) and chromatic scale of the 6th mode (right) in Standard Second Reform theory.

The intervals of the Second Reform have originally, however, a theoretical, sometimes complex⁶⁹⁴,

⁶⁹³ Whereas Chrysantine theory uses quarter-tone and *mujannab* intervals for such scales – see [Beyhom, 2014a] for the various formulations of the “chromatic” tetrachord, and how the original Arabian *chromatic* tetrachord, most probably influenced by Occidental music and theories of the scale, evolved from a Zalzalian formulation to a semi-tonal formulation.

⁶⁹⁴ See [Beyhom, 2015, p. 503 – footnote 3237]: while the formulation of the Second Reform was originally intended to be more descriptive, it is explained in the booklet of the reform that the sixth of the tone limitation, which results in a 36-intervals division of the octave, was imposed for practical considerations (mainly the difficulties for constructing a “psaltery” in 12^{ths} of the tone); it is possible that the final theoretical formulation of the committee would then have been different: there are however no (known) records of the discussions of the Music Committee (apart from the committee’s small booklet), which would have helped in a better understanding of this process.

“Harmonic” formulation (see an example in Fig. 76) which differs slightly from the equal-tempered equivalents as shown in Table 6 in which the *diatonic* intervals of second in the two reforms are compared together, in both “Equal-temperament” and theoretical (expressed as frequency/length ratios) formulations.

<p style="text-align: center;">Διὰ τεσσάρων</p> $\frac{\Gamma\alpha_1}{N\eta_1} = \frac{4}{3}$ $\frac{\Delta\iota_1}{\Pi\alpha_1} = \frac{\Gamma\alpha_1}{N\eta_1}$ $\frac{K\epsilon_1}{B\omicron\upsilon_1} = \frac{4}{3} \left(\frac{81}{80}\right)^2$ $\frac{Z\omega_1}{\Gamma\alpha_1} = \frac{4}{3} \cdot \frac{25}{24}$ $\frac{N\eta_2}{\Gamma\alpha_1} = \frac{\Gamma\alpha_1}{N\eta_1}$ $\frac{\Delta\iota_2}{\Pi\alpha_1} = \frac{\Gamma\alpha_1}{N\eta_1}$ $\frac{K\epsilon_1}{B\omicron\upsilon_1} = \frac{\Gamma\alpha_1}{N\eta_1}$ $\frac{Z\omega_1}{N\eta_1} = \frac{\Gamma\alpha_1}{N\eta_1}$ <p style="text-align: center;">Διὰ ἑξῆς</p> $\frac{K\epsilon_1}{N\eta_1} = \frac{5}{3} \times \frac{81}{80}$ $\frac{Z\omega_1}{\Pi\alpha_1} = \frac{5}{3} \times \frac{80}{81}$ $\frac{N\eta_2}{B\omicron\upsilon_1} = \frac{5}{3} \times \frac{81}{80} \times \frac{24}{25}$ $\frac{\Pi\alpha_2}{\Gamma\alpha_1} = \frac{K\epsilon_1}{N\eta_1}$ $\frac{B\omicron\upsilon_2}{Z\omega_1} = \frac{Z\omega_1}{\Pi\alpha_1}$ $\frac{\Delta\iota_2}{\Gamma\alpha_2} = \frac{5}{3} \times \frac{24}{25} \times \frac{80}{21}$ $\frac{K\epsilon_1}{\Delta\iota_2} = \frac{N\eta_2}{\Pi\alpha_1}$ $\frac{Z\omega_1}{\Gamma\alpha_1} = \frac{N\eta_2}{B\omicron\upsilon_1}$	<p style="text-align: center;">Διὰ πέντε</p> $\frac{\Delta\iota_1}{N\eta_1} = \frac{3}{2}$ $\frac{K\epsilon_1}{\Pi\alpha_1} = \text{»}$ $\frac{Z\omega_1}{B\omicron\upsilon_1} = \text{»}$ $\frac{N\eta_2}{\Gamma\alpha_1} = \text{»}$ $\frac{\Pi\alpha_2}{\Delta\iota_1} = \text{»}$ $\frac{B\omicron\upsilon_2}{K\epsilon_1} = \frac{3}{2} \left(\frac{80}{81}\right)^2$ $\frac{\Gamma\alpha_2}{Z\omega_1} = \frac{3}{2} \times \frac{24}{25}$ <p style="text-align: center;">Διὰ ἑπτὰ</p> $\frac{Z\omega_1}{N\eta_1} = \frac{15}{8} \cdot \frac{80}{81}$ $\frac{N\eta_2}{\Pi\alpha_1} = \frac{15}{8} \cdot \frac{80}{81} \cdot \frac{24}{25}$ $\frac{\Pi\alpha_2}{B\omicron\upsilon_1} = \frac{15}{8} \cdot \frac{81}{80} \cdot \frac{24}{25}$ $\frac{B\omicron\upsilon_2}{\Gamma\alpha_1} = \frac{Z\omega_1}{N\eta_1}$ $\frac{\Gamma\alpha_2}{\Delta\iota_1} = \frac{N\eta_2}{\Pi\alpha_1}$ $\frac{\Delta\iota_2}{K\epsilon_1} = \frac{N\eta_2}{\Pi\alpha_1}$ $\frac{K\epsilon_2}{Z\omega_1} = \frac{\Pi\alpha_2}{B\omicron\upsilon_1}$
---	---

Fig. 76 Part of the theoretical formulation of the diatonic intervals in the booklet of the Second Reform⁶⁹⁵.

This table is of interest for us for many reasons:

1. It shows firstly that the differences between the theoretical and indicative (numbered as 12, 10 and 8) intervals of the Second Reform are limited to 6 cents for the 10-minutes interval which carries the most discrepancy. This means that the

⁶⁹⁵ [Commission musicale de (Musical Committee of) 1881, Aphtonidēs, and al., 1888, p. 14, 15]: note an error for the ratio of $\gamma\alpha_2/\kappa\epsilon_1$ (1st column, 2nd line from bottom) given as $5/3 \times 24/25 \times 80/21$, which should be: $\gamma\alpha_2/\kappa\epsilon_1 = (5/3) \times (24/25) \times 80/81 = 128/81$; note also that the elementary intervals used (in combination – added or subtracted) for the *diatonic* scale by the Music Committee are the disjunctive tone (8/9), the “Major” (or “Harmonic”) third (4/5), the fourth (3/4), the Just fifth (2/3) and the “Major” (or “Harmonic”) sixth (3/5), combined with the 24/25 *diesis* and the 80/81 *comma*, mostly “Harmonic” intervals – see [Beyhom, 2015b, p. 228] for more details.

Music Committee most probably conceived its theoretical division as compatible with equal-temperament.

First Reform			
Interval	Theoretical		Equal-temp.
	ratio	in cents	in cents
12	9 / 8	203,91	211,76
9	12 / 11	150,64	158,82
7	88 / 81	143,50	123,53

Second Reform			
Interval	Theoretical		Equal-temp.
	ratio	in cents	in cents
12	9 / 8	203,91	200,00
10	800 / 729	160,90	166,67
8	27 / 25	133,24	133,33

Table 6 Intervals of second composing the *diatonic* scale in the two reforms of the 19th century⁶⁹⁶.

- Secondly, the discrepancies between the First and Second reforms theoretical intervals occur for the “medium” and “small” tones, with (however limited) 10-cents differences⁶⁹⁷, which shows that the scale of the Second Reform maintained some compatibility, with regard to interval values, with the scale of the First Reform.
- Thirdly, and whenever comparing theoretical and “equal-temperament” values for the intervals of the First Reform, discrepancies for the same interval in the two formulations are accented, reaching 20 cents for the 7-minutes interval, from which we may conclude that Chrysantine theory was never intended as an equal-tempered division of the scale.

The main characteristic of the Second Reform scale, however and for musicologists at ease with *maqām* theories, is that this scale, in its arithmetic

formulation⁶⁹⁸, is Western-compatible and based on a semi-tone division, *i.e.* symmetric and compatible with the “Arabian” 24-quarter-tones division (Fig. 77).

In other words, this scale is not compatible with earlier *maqām* divisions of the scale in 17 intervals, which differentiates it considerably from its Chrysantine counterpart.

While the Music Committee expressed serious criticism of Chrysantine intervals when qualifying them as “incomplete”⁶⁹⁹ (see for instance Anṭūn Hibbī’s explanation of this lacuna in Fig. 78), and while being aware that Occidental influence would promote, in the 19th century, an equal-tempered interpretation for both theories (First and Second Reform), an additional “correction” of Byzantine intervals, whenever a theoretical scale should have a mere guidance role, was superfluous.

A preliminary conclusion would be that this theory extends the spirit of Chrysanthos’ scale while giving it a formulation which is more compatible with Western theories, a compromise of some sort, an approach that Bourgault-Ducoudray recommended to Aphonidēs.

However, the Music Committee’s claim that Chrysantine theory contained “errors” compels me to some clarifications.

*
* *

I have frequently noticed, in the researches I have undertaken on multifarious representations of scales, that theoreticians consider sometimes (even often) incursions into praxis unworthy of the elegant mathematical formulations that Pythagorean mathematics provide; for some of them, praxis should follow theory, and not the contrary.

⁶⁹⁶ Chrysantine “equal-temperament” values are included here for the sake of comparison, most Occidental theoreticians having contented themselves with such an interpretation, including Borrel [1950, p. 2].

⁶⁹⁷ The 12-minutes tone interval with ratio 9/8 is the same in both theoretical formulations: the difference occurs (12 cents) between the tones in equal-temperament equivalents, but equal-temperament, as explained above, is irrelevant for the Chrysantine scale.

⁶⁹⁸ *i.e.* in numbers of elementary intervals (12, 10 and 8 for the *diatonic* scale) which divide the intervals of second and all other intervals of the scale(s): the values in both formulations (Table 6) bear no significant (theoretical) importance if this division be deemed “prescriptive” (an unbinding guide for performers), but we will see that the Music Committee claimed otherwise.

⁶⁹⁹ “Because of the lack of technological means, at the time, which would have allowed for scientific measurements of Musical intervals”.

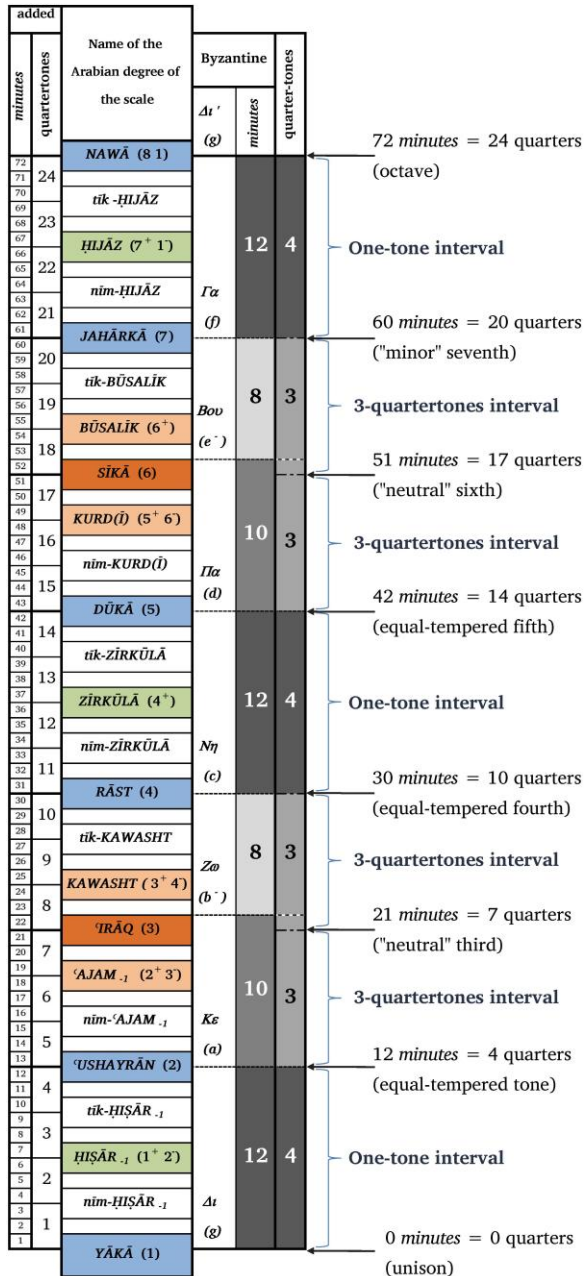

Fig. 77 Comparing the 24-ET division with the Byzantine (2nd Reform) 72-ET division of the scale⁷⁰⁰: 1-minute differences occur at the so-called “neutral” degrees *b* and *e*.

The only solid, however, and practical indication that we have on the Chrysantine scale, is the assertion of the First Reformer that the division of the strings of the *tunbūr*, as shown in Fig. 65, p. 133 and further detailed in FHT 22, p. 190, is the “best approximation”

⁷⁰⁰ Adapted and translated from [Beyhom, 2015b].

he could establish of the real intervals of the diatonic Byzantine scale⁷⁰¹.

	Music Committee (72-ET)	Hibbi (68-ET / 72-ET)	Mashāqa (68-ET)
$\Pi\alpha'$ (<i>d'</i>)	12	"missing" 1/3 tone	12
$N\eta'$ (<i>c'</i>)	8	7	7
$Z\omega'$ (<i>b'</i>)	10	9	9
$K\varepsilon$ (<i>a</i>)	12	12	12
$\Delta\iota$ (<i>g</i>)	12	12	12
$\Gamma\alpha$ (<i>f</i>)	8	7	7
$B\omicron\nu$ (<i>e</i>)	10	9	9
$\Pi\alpha$ (<i>d</i>)	1 div. = 16,67 c.	1 div. = 16,67 c.	1 div. = 17,65 c.
	8 div. = 133,4 c.	7 div. = 116,7 c.	7 div. = 123,6 c.
	10 div. = 166,7 c.	9 div. = 150 c.	9 div. = 158,9 c.
	12 div. = 200 c.	12 div. = 200 c.	12 div. = 211,8 c.

Fig. 78 The “error” in Chrysanthos Madytos’ scale according to Anṭin Hibbi⁷⁰² (Center column: “Chrysanthos’ octave is one third-of-the-tone short”), and comparison with Mashāqa’s (equal-temperament) interpretation of this scale (right) and the scale of the 1881 “Music Committee” (left)⁷⁰³.

⁷⁰¹ Thus [Chrysanthos (de Madytos) and Rōmanou, 1973, p. 89]: “§226. If one wants to know how the intervals of the scale of our diatonic genus on the diapason system are represented with numbers, we say that this is what we found the closer to truth possible [...]”.

⁷⁰² A Lebanese Greek-Catholic archimandrite who wrote a few works on Byzantine chant including the voluminous treatise [Hibbi, 1964] (in Arabic – but probably translated from a Greek treatise) from which the explanations about the “missing third of the tone” (in the Chrysantine scale) are taken; note that the Greek-Catholic Church in the Middle East, although it depends from the Church of Rome, follows currently the same liturgy as the Greek-Orthodox Church.

⁷⁰³ Minimal (1/10th of a cent) discrepancies in interval values appear in this figure when compared with the equivalent values in Table 6, due to the difference between two different procedures for computing the intervals. As for the “error” in the Chrysantine scale, it results from a misinterpretation by subsequent theoreticians, and can be explained thus: if the Chrysantine scale is deemed to be equal-tempered, the 12-minutes tone in this theory should be equal to 200 cents; dividing the 200 cents by 12, the outcome is 16,66666... cents per (alleged) Chrysantine “minute” which, multiplied by 68 (the total number of minutes in the Chrysantine scale) amount to 1133,33333... cents, with an octave short of one third of the tone (66,6666... cents). Knowing that Chrysantine theory is based on divisions of the string (as explained by Chrysanthos himself, and as shown in Fig. 66, p. 133), this “incompletion” is simply ridiculous.

These intervals are however variable depending on the melody, the mode⁷⁰⁴, the cantor, the venue⁷⁰⁵, the social event for which the performance takes place, the response of (or to) the audience, the physiology⁷⁰⁶ and, with regard to non-tempered instruments, the maker(s) of the latter and the different techniques used in playing them, etc. Hence the “approximate scale” of Chrysanthos, who was, as I could conclude from his various statements, well aware that it was impossible to determine the exact sizes⁷⁰⁷ of Byzantine chant intervals.

Chrysanthos was however compelled, for the needs of the First Reform, to imagine a simple way to differentiate the various tones of, primarily, the *diatonic* system of Byzantine chant, based at that time on the division common to most of the *maqām* area, the musical *Lingua Franca* of the *maqām*, or the Zalzalian asymmetric division of the octave theorized in the 13th century by Ṣafīyy-a-d-Dīn al-Urmawī and further developed by what was called the *Systematist school* and by later Ottoman theoreticians.

Hence the “three tones”⁷⁰⁸ of Byzantine music which, in relation one to another, reproduce the *approximate* proportions of the *theoretical* tone and two different *mujannab*(s) of Urmawī⁷⁰⁹, with the literal⁷¹⁰ formulation (beginning with $v\eta = c$) $T M_1 M_2 T T M_1$

M_2 ⁷¹¹ for the *diatonic* scale, the same formulation that applies to (typical) *maqām* scales since (at least) the times of Bharata Muni⁷¹².

At some point in his treatise, Chrysanthos tried to give another, mathematical explanation for this practical⁷¹³ – and approximate in his own formulation – scale, probably for the sake of justifying his practical determination of intervals to potential⁷¹⁴ critics. And while so doing, yes, he made an error⁷¹⁵: “So What”, would have said Miles Davis⁷¹⁶, one error in a 306-pages theoretical book packed with theoretical, practical and historical⁷¹⁷ explanations, and which has never been reviewed since⁷¹⁸; while I make tens such errors when I write⁷¹⁹, and while the (seven) members of the Music Committee of 1881 made themselves quite a few errors in the 63-pages long booklet explaining the basics of the Second Reform⁷²⁰.

⁷⁰⁴ See the examples for the positioning of the degree *SĪKĀ* in FHT 6, p. 182.

⁷⁰⁵ And its acoustics.

⁷⁰⁶ As shown in Chapter I for the four Byzantine cantors, and as is evident for any researcher who worked with interval measurements for the voice (as one example).

⁷⁰⁷ To be more precise in the formulation, I must add here that the exact size of an interval in performance can be measured (if recorded and analyzed with a computer program, for example), but this does not mean that this measure will correspond to the “ideal” value of the interval in other circumstances, or with other performers or instruments than the ones which contributed to the production of the measured interval.

⁷⁰⁸ The “Major”, “minor” and “minimum” tones (see for instance [Chrysanthos (de Madytos) and Rōmanou, 1973, p. 31, §80]), which are three different values for the three intervals of the *diatonic* scales, and different (greater) for the smallest from the European “semi-tone”: “The *leimma* of the Ancient Greeks or the semitone of the Europeans *si-ut*, are smaller than our minimum tone $\beta\omicron\upsilon-\gamma\alpha$ ” – [Chrysanthos (de Madytos) and Rōmanou, 1973, p. 95, §235].

⁷⁰⁹ *i.e.* the two scales are conceptually equivalent.

⁷¹⁰ Relative and conceptual.

⁷¹¹ In which T = whole tone, M_1 = First (greater) *mujannab* and M_2 = Second (smaller) *mujannab*, with $T > M_1 > M_2$, conceptually (and for the relations between the three intervals), *i.e.* the same relative proportion as with $12 > 9 > 7$.

⁷¹² As a reminder: 4 3 2 4 4 3 2 in *šrutis*, to compare also with the 12 9 7 12 12 9 7 progression of Chrysanthos theory intervals.

⁷¹³ Because it is based on the sense of hearing – which is approximate, and because it stems from the experience of a musician and cantor familiar with – if not an expert in – Byzantine chant.

⁷¹⁴ And perhaps effective: the *Theoretikon Mega* was printed in 1832 (but seemingly achieved in 1820 – see footnote 718), 11 years after the small booklet of the first reform [Chrysanthos (de Madytos), 1821] – which contained no such mathematical explanations.

⁷¹⁵ This error is examined and various explanations are proposed in [Beyhom, 2015b, p. 174–196].

⁷¹⁶ For those unfamiliar with Jazz classics, see [Anon. “So What (Miles Davis composition)”, 2016]: jazz improvisations are the privileged domain for “errors” which are “corrected” in the course of performance, or even used as a departure point for a new improvisation – I know this from experience.

⁷¹⁷ If not mythical.

⁷¹⁸ And the circumstances of their publication which did not allow for thorough verifications and adequate editing: “In 1820 Chrysanthos gave the manuscript of his Great Theory of Music to his student P.G. Pelopides, who eventually published it in 1832” – in [Chrysanthos (de Madytos) and Rōmanou, 1973, p. xxx].

⁷¹⁹ Although it has been reviewed quite a few times by myself and others.

⁷²⁰ Some of these errors are pinpointed in Part B of Chapter III in [Beyhom, 2015b], with one of them explained in the footnote of Fig. 76 in this dossier.

This does not mean, however, that Chrysantine intervals were “erroneous”⁷²¹, as apart from this mathematical error all other explanations by the Reformer⁷²² are coherent and sustainable⁷²³.

The error of the Music Committee and of its followers was the (re-)conceptualization of Chrysantine theory – an asymmetric, conceptual and based on string lengths theory – as an *equal-temperament* theory which shows, first of all, that the three-generations gap between the two reforms of the 19th century was enough for forgetting, or pretending to forget, two major characteristics of Early (and here transitional) theories of *maqām* scales: their relativity⁷²⁴, and their dependence on complementary Oral teaching⁷²⁵.

This is exactly the same process which, a few decades later, affected the teaching of Ottoman, Persian and Arabian musics.

*
* *

Apart from deeming the intervals of Chrysantine theory “erroneous”, the Music Committee claimed it “deliberately renounced any preconceived theory”⁷²⁶ of

⁷²¹ Neither would the arithmetical errors in the Music Committee booklet deem the whole theory of the Second Reform incoherent, for instance.

⁷²² Notably on the practical application of the “three tones” on the example of the two *tunbūrs* shown in FHT 24, p. 191, with the division of the whole tone which may result from these explanations shown in FHT 23, p. 190.

⁷²³ Let us also not forget that the main written support for “New” Byzantine chant is the Chrysantine *diastematic notation* (based on relative variations of intervals, and not on fixed pitches), for which theories of the scale can only give complementary explanations, not fixed interval (or pitch) values.

⁷²⁴ These theories provide relative relationships and proportions between intervals, not exact – measured – ones.

⁷²⁵ In [Commission musicale de (Musical Committee of) 1881, Aptonidēs, and al., 1888, p. 10], and on the same page on which Chrysanthos’ error is explained (and arbitrarily corrected) in a footnote, it is said that “the shortcomings of the theory have previously been addressed through long years of oral teaching of Ancient intervals: oral tradition, through a long experience, would imprint in the ear of the student the *diatonic* intervals [...] and [...] *chromatic* and *enharmonic*”; the aim of the Committee was then to address the growing lack of Oral teaching by “correcting” the theory (and making it completely written) and determining the precise intervals of Byzantine chant which, because of the changing nature of these intervals, cannot be done, and was done arbitrarily – if not erroneously – as I show in the next section.

⁷²⁶ This quote and the two following are taken from – [Borrel, 1950, p. 2].

the scale and that it “resorted exclusively to the monochord” for its purpose. Moreover,

“from the banks of the Danube reaching Egypt, [Byzantine tradition] remains unchanged; [the intervals] are performed in the same manner in Syria, Romania, Serbia, Greece, Crete, Bulgaria, and Palestine as well as in Mount Athos”.

The Music Committee formulated thus, after measuring all intervals and all the “attractions”, this new theory which was to replace the “erroneous” Chrysantine theory.

However, none of the claims listed in the above paragraphs and quote verifies, on the contrary...

Errors, approximations and breaches in the statements of the Music Committee

Let us list once more the allegations of the Music Committee of 1881:

1. Chrysantine intervals are incomplete.
2. The theory of the Second Reform is not preconceived.
3. This theory results from measurements, on the monochord, of intervals sung by cantors.
4. All cantors perform the intervals alike in the realm of Orthodoxy, Greece included.

The last claim is easily dismissed, as we know that Byzantine chant in Greece underwent deep changes⁷²⁷ under Othon the First, and that in Athenian churches it was even sung in polyphony.

The first claim is also untenable, and can solely be explained by a (conscious?) misconception of Chrysantine theory, notably by confusing it with an equal-temperament division⁷²⁸.

With regard to the theory of the Second Reform which had been conceived without prejudice, this is, given the theoretical formulation by the committee (Fig. 76 and footnote 695), simply impossible for two main reasons: firstly, because there is no traditional chant⁷²⁹ which is “naturally” based on “Pure” (“Harmonic”) intervals, and secondly, because the measuring procedure as described by the Music Committee is inconsistent.

⁷²⁷ And the Bulgarian Church had distanced itself from the Ecumenical Patriarchate (see footnote 559).

⁷²⁸ As shown in the previous section.

⁷²⁹ Except diphonic chant, which can however inconceivably convey the subtleties of Eastern Byzantine chant.

INTERVAL MEASUREMENT IS NOT AN EXACT SCIENCE

I have spent considerable time for the last 15 to 20 years measuring intervals⁷³⁰ for my research, which taught me to be very cautious about methodology in this matter⁷³¹. The Music Committee gives no clues about the measurement procedure for the intervals in its booklet, neither does it provide details about the cantors⁷³² who participated in this process. A series of questions arises, in this case, with regard to the latter.

Did the Music Committee gather cantors from all the realm of Orthodoxy, or did it content itself with a few renowned cantors from Constantinople? How did the members of the Music Committee agree on the adequacy of the monochord with the note sung by the cantors? Was it by ear, was it by consensus or was it by vote? Did the cantors sing only the intervals by holding both notes while the scientific investigators of the committee measured them on the monochord, or did they chant in situation while the latter measured the intervals simultaneously⁷³³? Were the pitches measured at the beginning of the attack of the note⁷³⁴, or when the note became stabilized? And does the measuring procedure give the same results for various tempos? Furthermore: how were the measurement results from different cantors⁷³⁵ handled statistically for the determination of the dispersion, the mean value⁷³⁶, the standard deviation and the evaluation of errors of measurement? Finally, did the committee ask the

⁷³⁰ And teaching Interval measuring at the university or elsewhere.

⁷³¹ See for instance [Beyhom, 2007d; Miramon-Bonhoure and Beyhom, 2010].

⁷³² Notably their identity.

⁷³³ An almost impossible task in praxis, noticeably for the “attractions” which can be measured only in the course of the (rising or falling) melody.

⁷³⁴ In which case, according to my experience, the pitch could be a quarter-tone to one and a half-tone higher (see / listen to, for instance, Slide No. 33, at 1.5 seconds).

⁷³⁵ Or even for the same cantor.

⁷³⁶ This is the only methodological procedure used by the Music Committee cited by Borrel in his [1950] article; however, the statistical correlation of interval measurements requires time-consuming and complex computational means; I explain, in [Beyhom, 2015b, p. 259–263], a simple procedure for statistical interval measurement verification which, for one single note in a song, requires hours of computation if not using a computer: how much time did the members of the committee spend on the verification of the accuracy of their results for each cantor, for each of the seven notes + octave of each scale, for all the possible combinations of intervals, and for all the attractions?

cantors to avoid fluctuations⁷³⁷ in their singing, and how were these fluctuations (or their absence) integrated in the final results?

To all these evident⁷³⁸ questions⁷³⁹, I could get no answers as the Music Committee did not find it necessary to provide them in written form, which brings a serious shadow of doubt about the claimed accuracy – and validity – of this measuring procedure⁷⁴⁰, as well as about the committee’s “un-preconceived” scale.

DID THE SECOND REFORM REACH ITS STATED OBJECTIVES?

The main issue which arises, however, and when realizing that the apparent aims of the Second Reform are purely rhetorical with regard to the mere 10 cents difference⁷⁴¹ in the theoretical configuration between the two theories⁷⁴², is the issue of the pertinence of

⁷³⁷ Which can also be considerable (see / listen to Slide No. 33, at 8,1 seconds).

⁷³⁸ *i.e.* for which any scholar in the field of musicology should require accurate, precise answers in order to endorse or decline the proposed results.

⁷³⁹ And many others that would arise from the answers to the previous questions; for an example of methodology in Interval measuring, see [Beyhom, 2015b, p. 323–329] (and the following pages for the results and the additional questions which arise when interpreting them).

⁷⁴⁰ Moreover: the Music Committee criticized at some point Chrysanthos because he used a *tunbūr* with moveable frets (instead of the monochord) to ensure that his intervals were accurate: while I do not pretend that Chrysantine intervals are fully consistent with the praxis of Byzantine chant at that time, it must be noted that using a fretted *tunbūr* is probably the best way for such a procedure, because it gives the pitches of *all* the notes in a scale (additional frets can be used when necessary) and allows for small modifications of the positions of the frets in order to verify if they are in tune with the chant or not; the *tunbūr* can also be played along with the the scale as many times as needed in order to verify the adequacy of the fretting. Note also that the *tunbūr* is an “oriental” (and mainly Ottoman) instrument, especially for Byzantine cantors in Constantinople, while the monochord, whenever used as a theoretical means for measuring pitches and intervals in Ancient Greece and later in Europe, became at some point an Occidental music instrument (see for instance [Adkins, 1963; 1967] and [Hughes, 1969; Meyer, 1997]). See also an example of the theoretical use of the *tunbūr* by Chrysanthos in [Chrysanthos (de Madytos), 2010, p. 116].

⁷⁴¹ Especially for a prescriptive theory, and whenever Bourgauld-Ducoudray had problems, as he states himself, distinguishing one-quarter-tone (*i.e.* 50 cents) differences between intervals (identifying – and appreciating – the three-quarter-tones and the five-quarter-tones intervals).

⁷⁴² Mostly because of the effective use of sixths of the tone as a smaller divider of the octave, *i.e.* an interval whose (equal-

the Second Reform and of the real reasons which underlie it.

The official reasons for the Second Reform, simply stated, were the following:

1. Safeguard the tradition.
2. Counter Western influence on Byzantine chant and society.
3. Help cantors with their apprenticeship of this chant.
4. Correct the errors in Chrysantine theoretical formulation.

While most of the repertoire, as seen above, had already been transcribed in the New Method at the time the Second Reform took place, the first and third reasons stated above are related to one another and could be dealt with through the implementation of the “attraction” in the theory – which was done⁷⁴³.

In the light of similarities in interval values between the two theories, however, “correcting” the errors in Chrysantine theory was a purely theoretical question, mostly limited to the formulation of the scale, which means that replacing the Zalzalian, Chrysantine theory, with a “Harmonic” theory, which uses moreover exact semi-tonal intervals in its scale descriptions, cannot constitute a distianciation from Western theories of the scale (and Western music), on the contrary.

Aphtonidēs’ concern, in his letter to Tantalidēs, about the influence of “Arabo-Persian” music on Byzantine chant shows that the two contradictory trends at work in Byzantine society, the westernization of Byzantine society and the defense of Byzantine tradition, did not exclude in his mind a detachment from the “more Oriental” Arabian⁷⁴⁴ or Persian (Zalzalian) musics. His approach is however similar to the approach of most “Oriental” theoreticians of the scale at that time, who still mastered the tradition and cherished it, but wished to adorn it with Western

clothes, making it more appealing for both Orientals and Westerners.

By doing so, however, Aphtonidēs and his “Oriental” counterparts have opened Pandora’s box.

Re-Byzantinism⁷⁴⁵

While Chrysantine theory survived until the second half of the 20th century (see Fig. 79)⁷⁴⁶, the Second Reform was successfully implemented⁷⁴⁷ and “exegetis”⁷⁴⁸ books and other literature on Byzantine chant flourished from that time on.

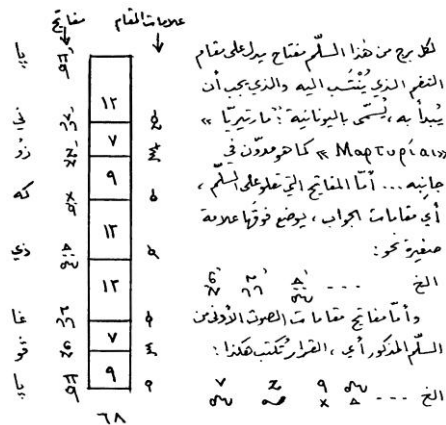

Fig. 79 Chrysantine diatonic scale and explanations by Mitri (al-) Murr (Lebanon)⁷⁴⁹.

Meanwhile, the three trends of Byzantine society, the craze for westernization, the defense of tradition, and Nationalistic exclusivism went on with various results, all pointing however, eventually, towards accrued occidentalization of Byzantine chant.

⁷⁴⁵ Re-Byzantinism (here in musicology) must be understood as the array of reactions to Interventionist (i.e. with the aim of changing the historical facts, if not the structure of Byzantine chant) Western Byzantinism, beginning with anti-Occidentalism and ending with the use of Occidental tools and rhetoric for the (alleged) purpose of “safeguarding” Byzantine tradition.

⁷⁴⁶ At least in Lebanon where Chrysantine theory was still known through the books (and only known theories in Arabic for Byzantine chant in the second half of the 20th century in Lebanon) of Mitri (al-) Murr (Greek-Orthodox, [Murr (al-), 1981]) and Anṭūn Hibbī (Greek-Catholic, [Hibbī, 1964]); at the present time, only the theory of the Second Reform seems to be in use in this country.

⁷⁴⁷ And probably helped, through the teachings of Constantinos Psachos, re-establish monophonic Liturgical chant in Greece, notably Athens, at the beginning of the 20th century.

⁷⁴⁸ Interpretation of the repertoire.

⁷⁴⁹ [Murr (al-), 1981, p. 1].

tempered) value is 33,33 cents which is three times more than the alleged difference.

⁷⁴³ With however a side effect which is that this implementation was one-sided and normative, while Byzantine chant tradition is interpretative, leaving the cantor a great deal of flexibility in praxis.

⁷⁴⁴ As compared with Ottoman music which had already set its course towards the same goal as Byzantine chant: occidentalization in the form of Ottoman music and society.

Whereas isolated⁷⁵⁰, sometimes shy reactions to the ditonic pressure in both music and musicology took place⁷⁵¹, the theory of the Second Reform remained practically unchallenged⁷⁵² till Simon Karas started a new process of Re-Byzantinism which, while allegedly

based on comparisons with Greek Folk music⁷⁵³ and Turkish theories of the scale, consisted in the use of Pythagorean theoretical material in order to make this theory even more descriptive⁷⁵⁴.

There are many other aspects to musical and musicological Re-Byzantinism, of which I can name (to name a few not in any specific order) the desire for (and the justification of) polyphony⁷⁵⁵ and equal-temperament in praxis⁷⁵⁶, rejection of mainstream Byzantinism⁷⁵⁷, Nationalism⁷⁵⁸, pro-Occidental

⁷⁵⁰ At least those published in Occidental books and reviews.

⁷⁵¹ Gregorios Stathis, a Greek priest and musicologist (and, at the present time, according to the description in [Stathis, 2012], “Professor of Byzantine Musicology and the Art of Chant” at the University of Athens), travelled to Great-Britain and gave a paper [Stathis, 1970] in which he notably states: “The *Monumenta Musicae Byzantinae* was formed in 1931, in Copenhagen, by three professors: Casten Höeg, a Dane; H. J. W. Tillyard, an Englishman (both of whom are presently deceased); and Egon Wellesz, an Austrian, who is a professor here at Oxford. With their pupils, they have worked very hard since 1931 and published many important works in four series. [...] We Greek traditionalists do not agree with these transcriptions because they are based on the fifteen signs of quantity—intervals only—which we believe do not form the entire melody, but only the frame of what is called the *melos*. Apart from this, the three *genera* of the eight modes—i.e., the *diatonic*, *enharmonic* and *chromatic*—and the different intervals of Byzantine Music are lost in these transcriptions. We consistently insist on their existence and have much evidence for their existence since the inception of the chants. Therefore, without these elements and with the Western European musical language expressed in these transcriptions, Byzantine Music is unrecognizable to us and sounds very western. These melodies, interpreted in this way, have nothing to do with Byzantine Music for us”. He later wrote an article [Stathis, 1979] in the same vein. This trend did however transform into (or accompany) Greek nationalism (see below). There are more recent examples of “resistance” to Western ditonism, notably the article of Eustachio Makris [2005] and writings by musicologists cited in the conclusions of this dossier.

⁷⁵² Many theoretical books were published meanwhile, extending, correcting, etc. the theory of the Second Reform, but none succeeded in imposing a different conception as Karas’ writings and active teaching did – see notably [Angelopoulos, 2005, p. 76–77], and [Moody, 2008, p. 111]: “In the field of Byzantine musicology, the highly controversial resurrection of disused neumatic symbols by Simon Karas has led to what might be characterized as a crisis in the practical execution of chant. Politically polarized factions have gathered around the followers of Karas (notably the influential *protopsaltis* of the church of Hagia Eirine in Athens, Lycourgos Angelopoulos) and his opponents, who not only see no practical value in this research but view it as a distortion of the psaltic tradition as transmitted by the last great cantors of the Patriarchate of Constantinople, such as Iakovos Nafpliotis and Konstantinos Pringos and their pupils. Voices of more moderate stance, such as that of the psaltis and musicologist Ioannis Arvanitis, a pupil of Karas, have found it difficult to make themselves heard, though Arvanitis’s choir, Hagiopolites, has carved a niche for itself by recording obscure repertoire such as that of the Kollyvades liturgical movement, which originated in the mid-18th century on Mount Athos”.

⁷⁵³ He was preceded however in this approach by many other musicologists notably, in the 20th century and relatively recently, [Merlier, 1960, p. 73]: “Folk songs, together with Greek Church music, are part of the great family of Oriental musics” (“La chanson populaire, comme la musique d’église grecque, appartient à la grande famille des musiques orientales”); for an echo of the polemic about Karas’ work, see [Beyhom, 2015b, p. 545–548].

⁷⁵⁴ See FHT 25 (p. 192) in which the scales of Byzantine modes hold a Turkish name, and in which intervals are expressed in *minutes* of the Second Reform but with (for instance) 5 ½-minute intervals as an approximation of the Pythagorean *leimma*, regardless of the inconsistency this creates for the degrees of the general scale – see also [Karas, 1982a; 1982b; 1989].

⁷⁵⁵ An ongoing debate in all “Oriental” musics: for Byzantine chant, however – see this interview [Ritter, 2010] of Alexander Lingas, Greek-American musicologist and director of the choir Cappella Romana (and author of numerous articles on Byzantine chant in the *New Grove*), notably this question of the interviewer: “you have almost pristine Byzantine-type music along with harmonized chant and even some pieces that sound completely divorced from the strict chant tradition. In the 1960s there was a lot of this type of experimentation going on; are these efforts accepted today as legitimate expressions of Byzantine chant or are they considered *passé* today and of historical interest only?”; see also [Moody, 2008] for a hagiographic presentation of this composer and other “Modernists”.

⁷⁵⁶ A most impressive aspect of this tendency is the shift (which I personally witnessed in Lebanon) in the Greek-Catholic Church after the 1960s, when liturgy became occidental, played with drums, trumpets, electronic keyboards, etc., and the theory suddenly turned equal-tempered as shown by the booklet of Anṭun Hibbi [Hibbi, 1987] – the same who explained Chrysantine theory in 1964; at the present time, however, liturgy has come back to its “Oriental” roots, but in the version of the Second Reform.

⁷⁵⁷ See footnote 751.

⁷⁵⁸ If not isolationism as may be inferred from Stathis’ (the same musicologist cited in footnote 751) recent statement: “This written and artistic musical Greek culture has lasted a millennium (from the tenth to the twenty-first century), and is the art of setting words to music in the Byzantine and post-Byzantine psalmodic style. The Greeks of this millennium, until the middle of the nineteenth century, were not familiar with any other musical culture except for that of Arabic-Persian music. They were able to keep Arabic-Persian music separate as ‘foreign’ or ‘ethnic’ music—as the music of a foreign race with a foreign religion—without letting it influence their own ethnic and religious musical

activism⁷⁵⁹, the loss or conflicting interpretations of tradition⁷⁶⁰, the rewriting of Ancient Greek theories⁷⁶¹, the abusive use of “scientific” musicological (Western) terminology⁷⁶² and, finally, straightforward Re-Byzantinism⁷⁶³.

While all these processes are shared by contemporary Oriental musicologists (replace however for the latter “Byzantinism” with “Orientalism”) and

→ expression” – [Stathis, 2012]; this point of view is similar to Aptonidēs’ we saw above, and seems to be common in “Traditionalist” literature of Byzantine chant (including in [Angelopoulos, 2005]).

⁷⁵⁹ This concerns many musicologists in the present time, including Dimitri Conomos who studied under Egon Wellesz in Oxford then took over the publication of *Studies in Eastern chant* (see [Conomos, 1990]), Diane Touliaos who totally adhered to the Wellesz-Tillyard mainstream Byzantinism (see for instance [Touliaos-Banker, 1978; 1988]) and, evidently, Katy Rōmanou to which we owe the translation of Chrysanthos’ *Great theoretical book* but who commented it from a Westernized point of view (these comments are detailed through the first part of Chapter III in [Beyhom, 2015b]; Rōmanou’s article [Rōmanou, 1990] edited by Conomos gives however additional information on the First Reform and corrects some errors, as does the reviewed translation in 2010).

⁷⁶⁰ Notably misunderstanding Chrysantine theory (“equal-tempered”) or confusing it with the theory of the Second Reform by underestimating or ignoring the changes between the two theories (see for instance Shireen Maalouf’s article about Mikhā’il Mashāqa [Maalouf, 2003] in which she mistakes Chrysantine theory with the scale of the Second Reform, generating thus errors corrected in [Beyhom, 2015b, p. 25–26]); but also ignoring or denying regional differences in performances in Greece (or outside it), a well known fact reported to me by all Lebanese cantors interviewed for [Beyhom, 2015b] (most of them having studied Byzantine chant in Greece) – see also footnote 752.

⁷⁶¹ A very common example is the attribution of the 12th of the tone division to Aristoxenos, but this is not a “Modern” Greek exclusivity.

⁷⁶² Examples of misuse are numerous, notably by qualifying intervals or scales as “natural”, by considering that the piano is a “well-tempered” instrument, or by considering Byzantine intervals as “micro-intervals”, as well as by the abuse of the term “Just” for intervals (all these terms are used in [Angelopoulos, 2005, p. 76–77]); such examples can be found mostly in musicological (?) literature by clergymen in the Orient, of which I propose further examples in the following chapter.

⁷⁶³ For instance [Conomos, 1982, p. 1]: “The introduction of the drone, or *ison* singing, so familiar in contemporary Greek, Arabic, Romanian and Bulgarian practice, is not documented before the sixteenth century, when **modal obscurity, resulting from complex and ambiguous chromatic alterations which appeared probably after the assimilation of Ottoman and other Eastern musical traditions**, required the application of a tonic, or home-note, to mark the underlying tonal course of the melody”.

are explained in detail in the following chapter, I address separately in this chapter the last item.

STRAIGHTFORWARD RE-BYZANTINISM⁷⁶⁴

One of the first references I looked up on Byzantine chant was the book of Dimitri Giannelos *La musique byzantine*⁷⁶⁵, the only available (in French⁷⁶⁶) complete description of Byzantine theory from the Second Reform.

At some point the author, while proposing the usual progression of the *diatonic* scale (the ascending – here on c – 12 10 8 12 12 10 8 minutes scale) “reminds” us that “all the intervals [of the Byzantine *diatonic* scale used in the 1990s] are natural” and “that this scale corresponds to the Occidental, Natural scale of Zarlino”⁷⁶⁷, with intervallic ratios given as 9/8, 10/9 and 16/15⁷⁶⁸ for the three “tones” of the *diatonic* scale (see first row in Fig. 80 and further comparisons)⁷⁶⁹.

	16/15 or 112 c.			16/15 or 112 c.		
9/8 or 204 c.	10/9 or 182 c.		9/8 or 204 c.	9/8 ou 204 c.	10/9 or 182 c.	
12 or 200 c.	11 or 183 c.	7 or 117 c.	12 or 200 c.	12 or 200 c.	11 or 183 c.	7 or 117 c.
c	→ ascending scale					c'
12	10	8	12	12	10	8
200 c.	167 c.	133 c.	200 c.	200 c.	167 c.	133 c.

Fig. 80 The “Byzantine” *diatonic* scale according to Giannelos and comparisons: the first row shows ratios as given by Giannelos and values of intervals in cents, the second row gives the closest equivalents in numbers of minutes of the scale of the Second Reform, and the third row gives the canonical numbers of minutes in the latter scale with the last row showing the equivalents of the latter intervals in cents⁷⁷⁰.

⁷⁶⁴ For more details on Giannelos’ (in some aspects incoherent) handling of Byzantine chant theory and his use of intervals (and Western notation), see [Beyhom, 2015b, p. 30–49].

⁷⁶⁵ [Giannelos, 1996], a redrafted version of his Ph.D. thesis [Giannelos, 1988].

⁷⁶⁶ An equivalent in English language would be [Savas, 1965] which however, although seemingly translated from the Greek language (see the title page) is limited in contents and relies heavily on Occidental literature (see [p. 106–107]).

⁷⁶⁷ [Giannelos, 1996, p. 61].

⁷⁶⁸ With the corresponding values approx. 204, 182 and 112 cents.

⁷⁶⁹ [Giannelos, 1996, p. 59].

⁷⁷⁰ Interval equivalents are given in the equal-tempered scale for the Second Reform; these values are close, as shown in Table 6, to their theoretical values; the logical conclusion is that the scale of

While this scale is presented as the scale of the Second Reform, it is obviously not so (see Fig. 74 and Table 6) although the numbers of minutes composing its intervals are the same as in the latter theory. It is also noteworthy to remind the reader that the intervals in Giannelos' "Zarlinian"⁷⁷¹ scale are even closer to the Pythagorean ditonic formulation (or 9/8, 9/8 and 256/243 in the ditonic tetrachord) than those of the Second Reform (see Table 7).

Interval	tone		"medium" tone		"small" tone	
	ratio	in cents	ratio	in cents	ratio	in cents
1 st Reform	9 / 8	203,91	12 / 11	150,64	88 / 81	143,50
2 nd Reform	9 / 8	203,91	800 / 729	160,90	27 / 25	133,24
Giannelos	9 / 8	203,91	10 / 9	182,40	16 / 15	111,73
Ditonic	9 / 8	203,91	9 / 8	203,91	256 / 243	90,22

Table 7 Evolution of "tones" from Chrysanthos (top) to Giannelos (before last row), to be compared with the intervals of the (Pythagorean) ditonic tetrachord (last row): the "mujannab" intervals (the "medium" and "small" tones) get closer, with each successive theoretical formulation, to the intervals of Pythagorean ditonism.

The most interesting, however, is that Chrysanthos Madytos, the architect of the First Reform, when he explained the *differences* between the Byzantine scale and the Western scale (see Fig. 81), presented the latter as composed with the same Zarlinian intervals⁷⁷² and as having nearly the same structure⁷⁷³ as the "Byzantine" scale of Giannelos (see the last scale to the right in Fig. 81 and compare it with the "Byzantine" scale of Giannelos in Fig. 80).

Indeed, the "Byzantine" scale of Giannelos is Western, as he himself writes, and similar in its intervallic contents to the Chrysantine "Western" scale⁷⁷⁴, but completely different from the Chrysantine estimation of Byzantine intervals, and from his *diatonic* scale. Therefore this scale represents a further "evolution" in the representation of Byzantine chant

→
Giannelos should be represented with (ascending) 12 11 7 12 12 11 7 minutes (of the Second Reform) intervals.

⁷⁷¹ And "Byzantine", according to him.

⁷⁷² See Fig. 70.

⁷⁷³ The two 9/8 and 10/9 tones are inverted when compared with the "Zarlinian" scale of Giannelos.

⁷⁷⁴ i.e. what Giannelos terms "Byzantine" was considered by Chrysanthos as "Western".

intervals, and one further (Re-Byzantinist) step towards the complete occidentalization of this chant⁷⁷⁵.

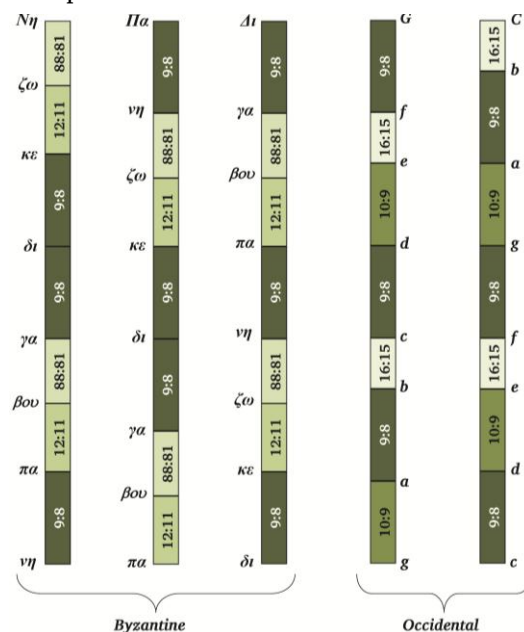

Fig. 81 Comparing a) Byzantine *diatonic* scales (the three on the left) with b) the Western scales (the two on the right) according to Chrysanthos⁷⁷⁶.

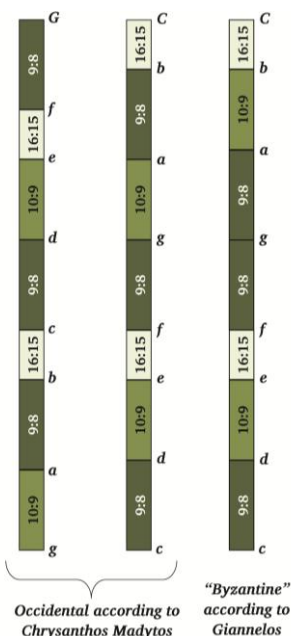

Fig. 82 The Western scale(s) according to Chrysanthos (left) and the "Byzantine" scale according to Giannelos (right) compared.

⁷⁷⁵ And towards the rewriting of both its theory and history.

⁷⁷⁶ Adapted from [Beyhom, 2015b]: the *diatonic* scales of Chrysanthos are Zalzalian, while the "Occidental" scales use so-called Zarlinian intervals (here based on a superparticular progression) with the smallest interval (ratio 16/15) considered as a "semi-tone".

Conclusions on Byzantine musicology

Byzantine chant theory and praxis underwent, while subjected to continuous Western strain beginning with the early 19th century, a series of reforms and changes which ended up in partial occidentalization⁷⁷⁷.

The roots of these reforms, whereas partly justified (for the First Reform) by an increased complexity of the chant itself, found their origin (for the Second Reform) in the Occidental desire to shape Greece to its image, an image based on a distorted understanding of Ancient Greek culture:

“Although we found an analogy between the diatonic shades known in Antiquity [...] and Modern accidentals in Ecclesiastic music, we do not think that these accidentals be a spontaneous emanation of Greek genius, but must find their origin in Asian influence [...]. We would repugnantly think that Greece could be driven by the natural inclination of its genius to adopt, for the intervals of its music, a principle which is completely alien to the musical sense of other European nations, and be thus condemned to intellectual isolation from the European Mainstream”⁷⁷⁸.

It is not surprising that Greek society, lured by Western prestige in the last two centuries, would evolve in the direction of accrued Occidentalization. The only recourse the Greeks (and the Byzantine Church) could have had was the support by a flourishing all-Oriental tradition, which would have justified a steady evolution on the same course as the one initiated more than a thousand years ago, with

Romanos the Melodist, John of Damascus and Kosmas of Jerusalem⁷⁷⁹.

Alas, this Oriental tradition had in parallel equally been laminated by the same trends and influences as the ones at work in Byzantine society⁷⁸⁰, but with the aim, in this latter case, to exclude this music and its countries from the “European mainstream”, and to deny them any legitimacy in an evolving “World civilization”.

In order to fulfill this aim, Western musicologists used the same tools as the ones used to impose changes in Byzantine chant – *i.e.* Hellenistic analytical tools devised in the 18th-19th centuries – coupled, however, with exclusive Orientalism.

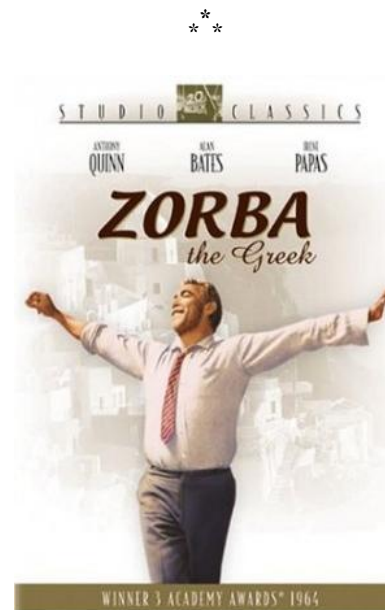

Fig. 83 Poster for the film *Zorba the Greek* (1964) directed by Michael Cacoyannis, with Anthony Quinn, Alan Bates and Irene Pappas, with music from Mikis Theodorakis⁷⁸¹.

⁷⁷⁷ And in complete (or nearly complete) occidentalization for the Russian, Bulgarian and other chants: this is too vast a subject to examine in this (already too extended) dossier, but for which some clues and explanations are provided in [Beyhom, 2015b].

⁷⁷⁸ [Bourgault-Ducoudray, 1877, p. 68–69]: “Bien que nous ayons constaté une analogie entre les nuances diatoniques connues dans l’antiquité [...] et les altérations modernes de la musique ecclésiastique, nous ne pensons pas que ces altérations soient une émanation spontanée du génie grec. C’est [à] l’influence de l’Asie [...] qu’il faut, suivant nous, en attribuer l’origine. Il nous répugne de penser que la Grèce soit poussée par l’inclination naturelle de son génie à adopter, pour les intervalles de sa musique, un principe complètement étranger au sentiment musical des autres nations de l’Europe, et qui la condamne à s’isoler intellectuellement du grand courant européen”.

⁷⁷⁹ Three famous composers and hymnographers, and successive founders – from the 6th to the 8th centuries – of what would be known as Byzantine chant.

⁷⁸⁰ And let us not forget that Byzantine chant is, at least partly, Arabian as out of the four original patriarchates (excluding the patriarchate of Rome), three (Antioch, Jerusalem and Alexandria) are found in Arabian countries, while the fourth is in Turkey today – for an example of the problems arising from the focusing of Orthodoxy on Greece, see for instance [Vatikiotis, 1994].

⁷⁸¹ Figure taken from [Anon. “Greek Music in Movies | Greek songs in films”], original poster and additional information available in [Anon. “*Zorba the Greek* (film)”, 2016].

INTERLUDE

It is very common, when analyzing musics from the “Orient”, especially *maqām* music, that a tonometric graph⁷⁸² shows subtle, however effective nuances in the melody for whoever is willing to hear and appreciate them.

Despite of my experience in this field, analyzing, listening, re-listening very frequently to the same excerpts to try and understand what was happening to the melodic line performed by a singer, a *ūd*ist, or any other instrumentalist, I find myself in some (rare) times confronted to an insoluble problem, or facing a (small) musical wonder.

This happened to me notably when analyzing two excerpts of the chant *Kyrie Ekekraxa* by Petros Byzantios⁷⁸³ performed in Arabic by Cantor⁷⁸⁴ Nicolas Malek, in the version adapted for Arabian Byzantine chant by Mitri (al-) Murr⁷⁸⁵ (see Fig. 84 and Fig. 85, and Slides Nos. 24 & 25 in the accompanying Power Point file).

The cantor – who is comfortable with both musics⁷⁸⁶ – interpreted during a recorded interview and as an example of differences between the “Byzantine” and the “ditonic”⁷⁸⁷ scales, the first excerpt

in “Byzantine diatonic”⁷⁸⁸ scale whereas the second excerpt was sung in “ditonic” scale.

The results of the first (*diatonic*) analysis (Fig. 84) were, unsurprisingly for this very reliable singer, compatible with the Greek Church contemporary theory, *i.e.* a *diatonic* scale on *d* with the degree *βου* (*e*) lower than its ditonic equivalent (*e* “natural”) by an approximate sixth of the tone⁷⁸⁹.

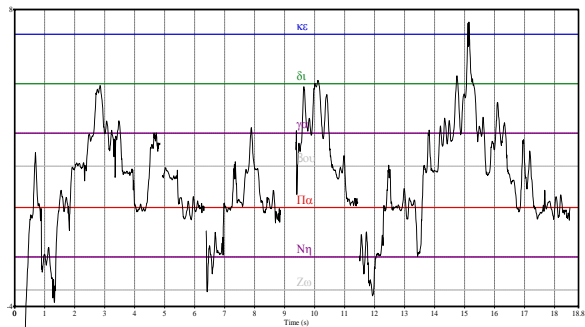

Fig. 84 Tonometric analysis of an excerpt of *Kyrie Ekekraxa* (Byzantios-Murr) in the *diatonic* Byzantine scale as performed by Fr. Nicolas Malek⁷⁹⁰.

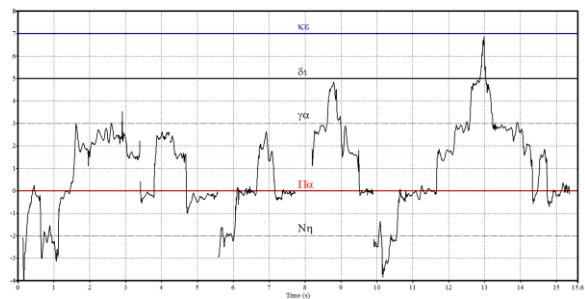

Fig. 85 Same as above (Fig. 84) in a “ditonic” scale as performed by Fr. Nicolas Malek⁷⁹¹.

The most astonishing result of the second analysis (Fig. 76), however, was that although differences – such as more stable pitches⁷⁹² – exist in this second version, the pitches of *βου* did not really change from

⁷⁸² As those provided on Slides Nos. 22 and 23, for the song *Ḥawwīl Yā Ghannām* performed by Najāḥ Salām in the accompanying Power Point slide show.

⁷⁸³ A famous composer in the second half of 18th-century (and beginning of 19th-century) Constantinople / Istanbul who was also, notably, the teacher of Chrysanthos Madytos – see [Patriarcat Œcuménique, 2012] and [Lingas, 2007].

⁷⁸⁴ Lebanese priest from the Orthodox Church, as well as director of the choir of the Greek-Orthodox diocese - North-Lebanon.

⁷⁸⁵ Probably the most renowned Lebanese cantor and composer, inside or outside this country (see [Analogion – Byzantine Music Resources, 2005 ; Analogion – Byzantine Music Resources, 2012]), and author of the small book on (Chrysantine) Byzantine chant cited above.

⁷⁸⁶ Fr. Malek is an exceptional cantor with a very steady voice as I could conclude by analyzing his excerpts in my book; he has taught himself guitar in his youth, then learned Byzantine chant orally, with teachers and listening to (then) tapes with recordings from famous Lebanese or Greek cantors. He is considered as the continuator of the “Arabian” Byzantine chant tradition established by Mitri Murr, and is the only cantor amongst the four whose chants I have analyzed in my book whose knowledge is (mostly) based on practice rather than on theoretical studies – see [Beyhom, 2015b, p. 396–399] for more details, but also all tonometric analyses of excerpts from this cantor in the same work.

⁷⁸⁷ Here supposedly a “minor” scale on *d*.

⁷⁸⁸ Composed in the First (*diatonic*) Mode by Mitri Murr, whereas it was originally composed in the Second (*chromatic* – more precisely *diphonic*) Byzantine Church mode by Petros Byzantios.

⁷⁸⁹ This is true mostly for the first *βου* (at 2+ seconds), while other occurrences are slightly lower, especially when they are part of a descending movement of the melody.

⁷⁹⁰ Taken from [Beyhom, 2015b, p. 398], excerpt [Malek, 2011a]: the horizontal axis shows time, the vertical axis shows the theoretical values of the degrees of the First mode of Byzantine chant – the *βου* is even lower at some times, such as, in Fig. 84, at 5.3 seconds.

⁷⁹¹ From [Beyhom, 2015b, p. 399], excerpt [Malek, 2011b]: the horizontal axis as in Fig. 84, while the vertical axis shows half-tone increments beginning with the fundamental.

⁷⁹² And less ornamentation.

one version to the other⁷⁹³, while the general plot of the tonometric analysis is similar in both versions.

This is even more dazzling because when listening to both excerpts, differences are perceptible from one version to the other, while not quantifiable⁷⁹⁴ with regard, specifically, to pitch. Most interesting are, however, the reactions of musicians and musicologists to the two excerpts: all found clear differences between the two versions (without being able to pinpoint them in detail) which were characterized, by musicologists aware of the two, Oriental and Occidental, traditions, as “Oriental” for the first, and as “Occidental Gregorian”⁷⁹⁵ for the second.

Notwithstanding the various other musical, physiological and physical factors which intervene in pitch perception, the bare fact of the existence of such examples compels (ethno-) musicologists to relativize the importance of pitches and scales in the perception of music, and to better study other aspects of sound which influence this perception.

This does not mean, however, that “traditional” pitch perception is meaningless, far from it: the changing (or different) pitches in *maqām* music, as with Najāh Salām whose singing is analyzed above, are an integral part of this tradition in the Middle East⁷⁹⁶, and one of the most important markers of the identity of this music (and of its performers).

Remains the most important question: what is “Oriental”, and what is “Occidental” in music?

While this question will have to be answered at some point by musicologists, musicians or others, what seems clear is that for Western musicologists the General scale is a fundamental marker of difference between the two musics, which is probably the reason for their obstinate adherence to the ditonic scale.

This, in its turn, is the most probable reason why Oriental music theoreticians focused, for the last two centuries, on the formulation of theories of the scale as the most important mean for defending their musics.

⁷⁹³ Except for the first *e* (at 1.7+ seconds); the other *e*(s) are almost a quarter-tone lower than the ditonic *e*.

⁷⁹⁴ Except for repeated hearing and comparing of, for instance, the first “*βov*” in both excerpts.

⁷⁹⁵ Including by Ethnomusicologist Jean Durrant who was the first to use the expression “Gregorian” for this excerpt.

⁷⁹⁶ Because these variations are perceptible, recognizable, and identifiable in this tradition as well as they characterize it.

5. ORIENTALISM IN MUSIC AND MUSICOLOGY, AND CONSEQUENCES⁷⁹⁷

“The European elite undertook to manufacture a native elite. They picked out promising adolescents; they branded them, as with a red-hot iron, with the principles of western culture, they stuffed their mouths full with high-sounding phrases, grand glutinous words that stuck to the teeth. After a short stay in the mother country they were sent home, whitewashed. These walking lies had nothing left to say to their brothers; they only echoed. From Paris, from London, from Amsterdam we would utter the words ‘Parthenon! Brotherhood!’ and somewhere in Africa or Asia lips would open ‘... thenon! ... therhood!’

It was the golden age. It came to an end; the mouths opened by themselves; the yellow and black voices still spoke of our humanism but only to reproach us with our inhumanity. We listened without displeasure to these polite statements of resentment, at first with proud amazement. What? They are able to talk by themselves? Just look at what we have made of them! We did not doubt but that they would accept our ideals, since they accused us of not being faithful to them. Then, indeed, Europe could believe in her mission; she had hellenized the Asians; she had created a new breed, the Graeco-Latin Negroes. We might add, quite between ourselves, as men of the world: ‘After all, let them bawl their heads off, it relieves their feelings; dogs that bark don’t bite’”
[Jean-Paul Sartre, 1961, “Foreword to Frantz Fanon’s *Les damnés de la terre*”]⁷⁹⁸

⁷⁹⁷ Appendix 7 entitled “Basic understanding of Orientalism – and a little more”, intended for readers unfamiliar with the more general problematic of Orientalism, may be of use before reading this chapter and the Conclusions that follow. Note that while Orientalism in music, in its two declinations, is a well known phenomenon which is examined or apparent in many previous publications and research (including the seminal [Al-Taei, 2010]), musicological Orientalism is still not addressed as such. As a result, the following sections address briefly Orientalism in music, and expand some of the explanations on Orientalism in musicology, notably those not addressed in the previous chapter on musicological Byzantinism and partly more specific to non-Byzantine musics of the *maqām*.

⁷⁹⁸ This translation is taken from [Anon. “Preface to Frantz Fanon’s *Wretched of the Earth* by Jean-Paul Sartre”]; this is the original text: “L’élite européenne entreprit de fabriquer un indigénat d’élite; on sélectionnait des adolescents, on leur marquait sur le front, au fer rouge, les principes de la culture occidentale, on leur fourrait dans la bouche des bâillons sonores, grands mots pâteux qui collaient aux dents; après un bref séjour en métropole, on les renvoyait chez eux, truqués. Ces mensonges vivants n’avaient plus rien à dire à leurs frères; ils résonnaient; de Paris, de Londres, d’Amsterdam nous lançions des mots

Orientalism may be defined as the general process of excluding Oriental cultures by “othering” them through biased research and reports.

Orientalism in music has two sides, the first being *maqām*-based exoticism which “signs” (and signals or identifies) this “otherness” with distorted musical citations, and the second side being the lessening or denigration of the musics of other cultures⁷⁹⁹.

Orientalism in musicology virtually gathers the whole musicological production of the 19th and 20th centuries on the “Orient”, with its backbone, exclusive Hellenism, being the primary tool used for the “othering” process.

Musical orientalism

Musical exoticism is a well-documented phenomenon⁸⁰⁰, whether for the numerous “turqueries”⁸⁰¹ found

in various compositions⁸⁰² by well-known Western composers, or for the exotic use of the (semi-tonal, *i.e.* with distorted intervals) *hijāz genus*⁸⁰³ till today as a marker for Arabism⁸⁰⁴, as well as various musical procedures⁸⁰⁵, citations or (modal?) *clichés* assimilated to the latter⁸⁰⁶.

→ “exotic” with “barbarous” – see also an “Autochthonous” point of view in [Balkiç, 2010].

⁸⁰² Mainly operas, which were the privileged means of expression of musical exoticism (for instance [Ringer, 1965, p.115]: “According to one recent estimate, well over four hundred operas written before 1800 were based on subject matter that may be loosely classified as ‘exotic’”).

⁸⁰³ Equated with the use of the “augmented second” in most musicological literature on the subject: see for instance [Pistone, 1981, p. 18], [Bartoli, 1981, p. 35], [Lishke, 1981, p. 61], while the only mention of the *hijāz genus* in this dossier devoted to “Musical Exoticism in France” is to be found in [Chabrier, 1981a, p. 39].

⁸⁰⁴ Some examples are provided notably in [Beyhom, 2007a; 2007c; 2014a], including the use of the scale of *maqām Hijāz-Kār* in the main theme of (the film, directed by David Lean with Peter O’Toole in the title role, music composed by Maurice Jarre) *Lawrence of Arabia* (1962); I hope to be able to publish an English version of these works some day soon.

⁸⁰⁵ Such as reproducing “Oriental” music as “monotonous, with persistent repetitions of single notes and short motives” – [Meyer, 1974, p. 487]; compare with [Ringer, 1965, p. 115]: “On the whole, non-Europeans were depicted as either cruel or ridiculous, and their musical characterization was confined to a limited number of stereotypes, such as rhythmic ostinati and persistent repetitions of brief melodic phrases, occasionally an unusual interval like the augmented fourth”; see also [Defrance, 1994, p. 200] for the different procedures used by Orientalists to create an “Oriental atmosphere”, and the three procedures for musical exoticism explained in [Bartoli, 1981, p. 34] who stresses, on the previous page, that “[these procedures] will become conventional markers for the evocation of Oriental countries. It is then even superfluous to insure the accuracy of this evocation; it is henceforth perceived as authentic”. Orientalist claim for “authenticity” perpetuated in the second half of the 20th century [Gradenwitz, 1976, p. 472–473]: “When the ‘Chant du muezzin’ was intoned in David’s Symphonic Ode *Le Désert* at the Salle Ventadour in Paris in December, 1844, the elegant public was not only fascinated by the novel and exotic sounds of the music but no less attracted by the reaction of a group of Arab chieftains who attended the performance as guests of the French government. ‘All eyes were directed towards the beautiful white phantoms which had so far not showed any signs of life,’ reported the poet Theophile Gautier, who was present that night. ‘At the very first words: *El salam alek[um]! Aleikum el salam!* they pricked up their ears like a war-horse at the sound of a fanfare and their brown faces began to shine. They followed the singing with low voices and at the end of the muezzin prayer applauded with such obvious satisfaction that the singer, Monsieur Béfort, was asked to repeat the piece another time especially for them”. While Gradenwitz concludes [p. 505-506] “a hundred years after

→ ‘Parthénon ! Fraternité !’ et, quelque part en Afrique, en Asie, des lèvres s’ouvraient : ‘... thénon !... nité !’ C’était l’âge d’or. Il prit fin : les bouches s’ouvrirent seules ; les voix jaunes et noires parlaient encore de notre humanisme mais c’était pour nous reprocher notre inhumanité. Nous écoutions sans déplaisir ces courtois exposés d’amertume. D’abord ce fut un émerveillement fier : comment ? Ils causent tout seuls ? Voyez pourtant ce que nous avons fait d’eux ! Nous ne doutions pas qu’ils acceptassent notre idéal puisqu’ils nous accusaient de n’y être pas fidèles ; pour le coup, l’Europe crut à sa mission : elle avait hellénisé les Asiatiques, créé cette espèce nouvelle, les nègres gréco-latins. Nous ajoutions, tout à fait entre nous, pratiques : et puis laissons-les gueuler, ça les soulage ; chien qui aboie ne mord pas” – Virginie Despentes, French author and director, says nearly the same thing in her recent book *Vernon Subutex* (including [Despentes, 2015, p. 256–257, beg. with §3 on p. 256]), but about the integration of second / third generation immigrants in the French academic system.

⁷⁹⁹ The quote of Berlioz about the music of the Chinese people is an example of this aspect of musical Orientalism, here to be considered as musical exclusivism (the question of whether Chinese or other [shortly and with regard to music: non-*maqām*] cultures should be considered as being subjects to Orientalism is still open – see Appendix 7).

⁸⁰⁰ See for instance the expanded article (in English) [Pasler, 2012] on the subject of French musical Orientalism in North Africa, or (in French) [Ladjili, 1995], and my article (in French) [Beyhom, 2007c].

⁸⁰¹ Which eventually influenced (through the *mehter*) Military bands and musical instruments in the West – see for instance [Signell, 1988] and [Rice, 1999], notably [p. 43 in the latter]: “Europe’s increasingly congenial relationship with Turks resulted in a similar identity crisis—a crisis that produced a need to reaffirm Turkish inferiority” and [*ibid.*] the definition of “exotic” in the 2nd edition of the *Oxford English Dictionary* which equates

Another aspect of musical “Oriental” exoticism is the use of (equal-tempered) quarter-tones⁸⁰⁷ and other “micro-intervals” by various composers⁸⁰⁸ in their music⁸⁰⁹, as a way of expanding the ever shrinking possibilities of semi-tonalism⁸¹⁰.

Musical Orientalism is moreover sometimes so well hidden⁸¹¹ that it becomes difficult to perceive without thorough listening and analyzing of the music, which thus surreptitiously helps promote Orientalist, if not antagonistic postures in the auditor’s unconscious mind⁸¹².

→
Félicien David’s death, having access to the authentic traditional music of the areas the composer visited and possessing the technical and musicological means to transcribe and analyze it without recourse to an equal-tempered piano, some of his music may sound naive, especially when compared with what twentieth-century composers have been able to do with Near Eastern and Far Eastern musical material”.

⁸⁰⁶ With the risk that misplaced (insufficiently documented) exoticism can end up with the composer “othering” his own culture (and music; see [Abraham, 1975], notably the conclusion on the “*Insirāf Ghrib*” used by Borodin for his “Arabian Melody”, an interesting case of “double exoticism” and – unwilling – reverse Orientalism; see also on this subject [Taruskin, 1992, p. 266 sq.] who seems to overlook this connection).

⁸⁰⁷ A use considered since the late 15th century in Europe according to [Rushton, 2001].

⁸⁰⁸ Jean-Étienne Marie, Juan Carillo, Alois Hába, Yvan Wyschnegradsky (and his manual for “harmonized” quarter-tone music [Wyschnegradsky, 1980] – a reprint from the 1933 edition), etc. See also a contemporary’s discussion on “microtones” and harmony in [Strangways, 1925, p. 122–124], and a discussion of the “Historical bases of quarter-tones” in [Kallenbach-Greller, 1927].

⁸⁰⁹ Ignoring thus, through the equal-temperament procedure, the variational aspect of *maqām* music.

⁸¹⁰ Which is also one of the aims of “conventional” (semi-tonal) exoticism. See as well the explanations on both Western and Oriental composer’s interests in [Vigreux, 1992, p. 229–230], notably [p. 230] Bourgault-Ducoudray who considers the use of quarter-tones to promote a renewed Western music “exhausted by the major and minor modes” (a somewhat contradictory statement when remembering his abhorrence of the three- and five-quarter-tones intervals for Byzantine chant – as quoted in the previous chapter of this dossier), while Camille Saint-Saëns considers that a new “music in quarter-tones” will be born which will transform “current music” into a “dead language”.

⁸¹¹ While becoming even more revealing.

⁸¹² I analyze in [Beyhom, 2005a] (in French – this is another article I hope to be able to translate soon) such a process in film music, in which the use of musical *dichés* and procedures subtly (and almost unconsciously) creates an image (both auditory and visually) of Arabs (or similar “Oriental” ethnicities) as a distorted, lesser version of “civilized” folks – see the (very summarized) results of this analysis in Slides Nos. 36-37; note also that this

RE-ORIENTALISM⁸¹³ IN MUSIC

Re-Orientalism in music has two sides: the implementation of Western musical procedures in Oriental music, and the shift of music teaching from Oral to Written form.

It is difficult today to find Arabian, Persian or Turkish music compositions or songs which do not comprise melodic or harmonic triads inspired by (or imitating) Western classical harmony⁸¹⁴, while irregular (non-isochronic) rhythms disappear slowly⁸¹⁵.

→
ideological use of music in film soundtracks was supposed to be a Soviet creation: “Soviet cinema did not, therefore, regard sound and music as passive or ‘silent’; it was to do more than simply provide what Royal S. Brown calls the ‘dramatically motivated musical backing’ that would characterize Hollywood films. In Soviet films sound would be endowed with an organizing or structural function. Film was intended to educate the masses in ‘high’ cultural values, and, under Iosif [Joseph] Stalin, this went hand in hand with the true and historically concrete depiction of reality in its revolutionary development. Music, too, had to play its part. Music could enhance and even determine analysis, comment, and judgment, ‘in the spirit of communism’” – in [Gillespie, 2003, p. 473]; which shows that ideologies change from one political system to the other, but the tools for promoting them remain the same.

⁸¹³ To be understood like “Re-Byzantinism” in footnote 745 (p. 147), by (evidently) replacing “Byzantine” with “Oriental”, and “Byzantinism” with “Orientalism” in the latter definition.

⁸¹⁴ Most, if not all, Lebanese composers use harmony in their music for instance, while some of them have theorized it (Boghossian), and at least two of them, ‘Abdul-Ghanī Sha’bān (listen to an excerpt of his *Fugue* in Slide No. 39 – example No. 8) and Tuwfiq Sukkar have composed harmonized or polyphoned music “in quarter-tones”; Sulaymān Gamīl in Egypt composed contemporary music pieces using Arabian non-tempered *maqāmāt* (*maqām Šabā* for instance – listen to [Gamīl, 2001], track *Pretence and Destiny* in which the composer uses polymodality in this *maqām*) – these are only some instances, as the general trend in the middle of the 20th century was “Arabian polyphony”.

⁸¹⁵ See for instance the problematic about “Alla turca, Alla franca” and the questionings on Turkish music, notably in [Erguner, 1990], and in [El-Shawan Castelo-Branco, 1992] as well as, for the changes in Egyptian music in the 19th and 20th centuries, mostly [Racy, Illinois, and International, 1977], notably: “Napoleon’s conquest of Egypt (1798-1801) was a turning point in the social history of the Islamic Middle East. To Ottoman Islam, challenged on its own territory, European military might became an indisputable fact. Besides arousing the Easterners’ resentment, the occupation triggered their interest in self-analysis and eventually led them to question their own self-image. It aroused their curiosity about the cultural values, social institutions, and political ideas that lay at the roof of Europe’s material supremacy (citing [Vatikiotis, 1969, p. 44]). It also led them to borrow some of Europe’s material achievements and cultural traits. In Egypt

A typical Re-Orientalist attitude can be found in the discussions between Arabian and European participants at the Congrès du Caire of 1932⁸¹⁶, be it about the introduction of harmony or Western instruments in Arabian music⁸¹⁷, or the standard for the degrees of the “24-quarter-tones” scale⁸¹⁸. Whereas musicologists like Curt Sachs, Robert Lachmann and Béla Bartók would emphasize the need to conserve Arabian traditional music⁸¹⁹, Arabian participants and musicologists insisted in their turn on the need for “modernizing” Arabian music⁸²⁰ and use the non-tempered Western instrumentarium (but also the “Arabian quarter-tones” piano⁸²¹) for their music.

The “Congrès” eventually suggested recommendations⁸²² for music teaching and education⁸²³ aiming at

→ westernization resulted from political and cultural contacts, and from deliberate attempts on the part of the rulers”.

⁸¹⁶ See the very complete [Vigreux and Hassan, 1992] for this “Congrès”, notably for the discussions on “modernizing” Arabian music, the social trend towards Occidentalization, a summary of the problems that *maqām* music faces today.

⁸¹⁷ A generalized problematic in *maqām* music, with “new” instruments introduction in the instrumentarium such as the “Pakistani” harmonium in *qawwali* music or the Baluchi *benju* – see [During, 2015], and, among many other articles and books on this subject, [During, 2005a] for this author’s remarks on (the loss of) the sense of tradition in Iran.

⁸¹⁸ A polemic that is still going on, as I could realize at the “Congrès du Caire” of 2007 (of which the theme was the “75 years of the Congress of Cairo 1932”) organized by the League of Arabian countries, and during which Isis Faḥallāh, a well-known Egyptian musicologist, lamented in public discussions that the Arabian scale was still not tempered (“fixed”).

⁸¹⁹ This is a typical “comparative music” (or ethnomusicological) attitude which reflects the desire of these musicologists to study these musics, notably for the sake of “better understanding the Western music of the Middle Ages” (see Chapter II, and [Sachs, 1933, p. 18]: “each new information on Oriental music accrues our knowledge on Western music of the Middle Ages” – cited in [Racy, 1992, p. 117]), and to analyze them, however, with the analytical tools described in Chapters I and III: a very contradictory, but in the same time a very understandable position.

⁸²⁰ El-Shawan describes these conflicts of interests at the “Congrès” efficiently in [El-Shawan Castelo-Branco, 1992].

⁸²¹ See for instance a description of the piano of Lebanese Abdallah Chahine in [Hage, 1975] – “prepared” (quarter-tone) pianos were also proposed at the 1932 Congrès du Caire.

⁸²² A usual procedure in Arabian conferences as I have witnessed more than once, and with the recommendations nearly never put to execution.

⁸²³ See for instance “L’éducation musicale en Égypte” by Martha Roy [1992, p. 32 sq.] about the recommendations of the

the teaching of both Western⁸²⁴ and “Arabian” musics in music institutes and conservatories: in the meantime, Arabian “*bonne société*”⁸²⁵ had already turned their eyes and ears towards Verdi’s opera *Aida*⁸²⁶, with their girls learning piano and their boys learning guitar, flute and other Western instruments⁸²⁷, whereas “National composers” wrote symphonies and various other sonatas and concertos⁸²⁸.

To the like of Byzantine music, “resistance” to Western musical influence⁸²⁹ existed, mostly in

→ specialized Commission for the teaching of music at the Congrès du Caire (1932).

⁸²⁴ Perhaps I should use the terms “Eurogenetic music” for this art, as in [Bozkurt, Ayangil, and Holzapfel, 2014, p. 7], “to avoid the misleading dichotomy of Western and non-Western music”...

⁸²⁵ Typically middle-class.

⁸²⁶ First representation in Cairo in 1871; for an analysis of the “exoticism” of this opera and the complex intrications between musical exoticism and political considerations of the time, including the European fear from the Wahhabist strain of Islam, see for instance [Locke, 2005; 2007].

⁸²⁷ For example in the Lebanese Conservatory, today (2016) and out of 5 559 students (for instruments studied as “main instrument”), there are 2 055 students for piano, 1 005 for guitar, 559 for (western) violin, and 231 for the *ūd*, 102 for the *qāmūn* and *none* for “Oriental violin” (the course does not even exist); whereas Lebanon is probably the most Westernized Arabian country, the trend is today towards even more Westernization of music; it must also not be forgotten that teaching of Arabian music in the conservatoires in Arabian countries relies on a system which incorporates Western music (called “Global” – *‘ālamīyya*) theory and a repertoire of “Arabian” music which already incorporates triads, limited harmonic lines, etc.

⁸²⁸ Such composers were and are in Lebanon Tuwfiq Sukkar, Boghos Gélalīan, Abd-al-Ghanī Sha’bān, the Raḥbānī Brothers ‘Aṣṣī and Maṣṣūr with their sons, etc.; for Turkey “Cemal Reşit Rey, Ulvi Cemal Erkin, Ahmet Adnan Saygun, Necil Kazım Akses and Hasan Ferit Alnar, who became known as the Turkish Five” ([Anon. “Music of Turkey”, 2016] – see also [Tansuğ, 2007] for more information on the problematic of Turkish “National” Music). See also, for the rapid transformation of Arabian music characteristics in the first half of the 20th century, the introduction (by Muḥammad al-Mannūbī a-s-Sannūsī) of Erlanger’s last volume [Erlanger, 1959, v. 6, p. viii].

⁸²⁹ And to “westernized” theories such as the Ezgi-Arel theory in Turkey, for instance, where Tanburi Cemil Bey and Mesut Cemil still used intonations which contravened theory, despite the fact “that in the circle of traditional art music the perception of theory has been more important than before [...]”, while “the practice seems to develop its own course, [although] it is clear that the practice defines itself with reference to theory” – in [Gedik and Bozkurt, 2009], with notably measurements showing discrepancies between theoretical and performance *hijāz genera*.

religious Islamic cantillation⁸³⁰, but the trend is so powerful⁸³¹ that even Islamic cantors seem to have in the meantime lost some feeling of tradition⁸³², while in popular music the generalized use of electronic “Oriental”⁸³³ keyboards established the use of equal-quarter-tones music⁸³⁴ and nearly ironed out popular instruments such as the *rabāb* and the *mijwīz*⁸³⁵.

Moreover, and with theory influencing music instead of trying to describe it, the “quarter-tone” theory contributed to a generalized westernization of musical thought and exclusivism⁸³⁶.

⁸³⁰ Discussions with Islamic cantors in Lebanon undertaken by Rosy Azar Beyhom show that, while evidently aware of the use of the *maqām* theoretical (and practical) system in their cantillation, (some) cantors still deny it has anything to do with “music”; it must also be noted that even in such religious circles, rapid westernization is at work as attested by a recent experience in (pre-Civil War) Damascus with a cantor chanting the Call to Prayer accompanied by a piano, a “noteworthy experiment in the field of religious chanting” according to *A-s-Safīr* (a Lebanese “Islamic-progressive” daily paper) in 2008 (see [Anon. “رفع الأذان في... بمصاحبة البيوتو :: فنون وعلوم”] – in Arabic).

⁸³¹ To the extent of modifying the intonations of *maqām* music which evolved, in the last centuries, towards an equal-tempered ditonic basis as documented in [Feldman, 1996, Part 11. Chapter I, The General Scale of 17th-century Ottoman Music, p. 195-218], [Zouari, Meētis, and Université de Paris-Sorbonne, 2007] and [Olley, 2012]; see also [During, 2008, p. 78] who explains (amongst numerous examples he provides in this article) that, although today’s fretted *tambur* in Central Asia is tuned ditonically, Viktor Belaiev described in 1933 a Zalzalian tuning for this instrument, confirmed by museological observations on an instrument from that time period.

⁸³² One of the indicators for such a loss is the generalized use, in countries of the Levant, of the semi-tonal *hijāz* tetrachord (2 6 2 in multiples of an approximate quarter-tone) in lieu of the Zalzalian *hijāz*(s) 3 5 2 and 2 5 3 (see [Beyhom, 2014a]); for the record, when I tried to explain to one of the acknowledged two best performers of the *ūd* in Lebanon all the possibilities of the *hijāz* genus (in September 2002 – see [Beyhom, 2007c, p. 69]), his irritated response was: “there is only one *hijāz*, the ‘Piano’ *hijāz*”.

⁸³³ With the possibility of programming pitch variations and with pre-programmed equal-tempered quarter-tone alterations.

⁸³⁴ A recent discussion I had with a Lebanese “Oriental” pop-songs composer, who uses computer assisted composition and “Oriental” keyboards, escalated slightly when discussing (different) “quarter-tones”, the composer strongly claiming that “there was only one quarter-tone, the 50 cents quarter-tone”, although (today) most music sequencers, various (recent) VSTs and almost all “Oriental” keyboards provide the possibility of tuning various (heptatonic, or less) scales to the cent.

⁸³⁵ For these and more examples on the effects of westernization on Arabian music, see [Beyhom, 2007c].

⁸³⁶ Based on the 12-semi-tones / 24-quarter-tones division: discussions about other possible procedures which may better describe Arabian music seem so incongruous for most Arabian theore-

The result of all these quantitative changes has transformed in a qualitative loss of tradition, with a generational gap which seems today impossible to mend⁸³⁷. This phenomenon is even more acute in Native musicology.

*
* *

The procedures and tools described in the following pages are characteristic of 20th-century *maqām*-musicology: it should be noted that these procedures are not monolithic, and differences in the interpretation of *maqām* music theories and scales have always existed, at one time or the other; there have also been (rare) discordant voices⁸³⁸, not (or only slightly) falling into the entrapment of occidental Hellenistic Orientalism.

Most of these procedures are still used, consciously or not, by a vast majority of Western⁸³⁹ musicologists⁸⁴⁰ who address “Oriental” musics.

→ ticians that explaining Kieseewetter’s “Arabian” scale to them is today a real wager. At the same time, these musicians-theoreticians are so attached to their “quarter-tone system” that (see also below “Consequences of Orientalism”) they use it as an argument for the “superiority” of Arabian music on “Global” (Western classical) music.

⁸³⁷ Most of the information about Early or Middle Arabian tradition seems today irrelevant for Arabian musicians, who do not even know the peculiarities of their art: this is mainly due to the generalization of the conservatoire teaching which results in the oversimplification of both theory and practice, as I concluded from numerous discussions with Conservatoire teachers in Lebanon. Besides the predominance today of the “Piano-*hijāz*” (see footnote 832), a simple example for this generational gap is that very few Arabian musicians today still acknowledge differences between the different positions of the degree *SĪKĀ* (see FHT 5, p. 182) in performance (and in theory) and use equal-tempered (quarter-tone altered) *e*: this is also a side effect, in Arabian countries, of the use of *qānūn*(s) with the “quarter-tone” system of *‘arabāt* (mandals) which impose a quarter-tone-temperament for other musicians. While in Turkish music the problems are different {Turkish *qānūn*(s) have multiple mandal systems which allow for more refined tuning and intonations}, the evolution of this music due to the influence of the Ezgi-Arel theoretical system is (elsewhere) well documented, notably for the *hijāz* tetrachord in [Beyhom, 2014a].

⁸³⁸ Which I shall not name, not wanting to forget anyone in the process.

⁸³⁹ And “Autochthonous” musicologists trained in Western universities as I show in the “Re-Orientalism (‘Consequences of Orientalism’)” section below.

⁸⁴⁰ And ethnomusicologists, for what the difference is worth in this case.

Musicological Orientalism

In the 19th century and the first quarter of the 20th century, most if not all the teaching of *maqām* music shifted from oral to written theories, and *all* *maqām* theories shifted from similar representations⁸⁴¹ of scales issued from the asymmetric, 17-intervals division of Ṣafīyy-a-d-Dīn al-Urmawī⁸⁴² or from equal-divisions of strings on a lute⁸⁴³ (beginning with Bharata Muni's *Nāṭyaśāstra*⁸⁴⁴) to new, sometimes complex formulations compatible with the semi-tonal and symmetric Western system⁸⁴⁵.

The chronological scheme of these transformations begins with the Levant⁸⁴⁶ (Lebanon and Syria⁸⁴⁷), a privileged entry point for Occidental influence, then Greece⁸⁴⁸, Egypt⁸⁴⁹ and the rest of Arabian countries⁸⁵⁰, Turkey⁸⁵¹ and, finally, Iran⁸⁵². Meanwhile, rising Nationalism⁸⁵³ contributed heavily to the differentia-

tion of praxis, on one side, and of theoretical formulations of the scale, on the other side, between different areas of the *maqām* realm.

The question that arises from this observation is, obviously: “how was this made possible?”

Whereas history⁸⁵⁴ gives us clues and reasons for this process, its implementation in musicology has still to be described.

MAQĀM-MUSICOLOGY AS A REFLECTION OF WESTERN ORIENTALISM

As we have seen in Chapter II, the main paradox which confronted Occidental musicologists was the Greek filiation of *maqām* music, the theories of which were inspired by Ancient Greeks theories then adapted for the needs of the Arabian⁸⁵⁵ empire⁸⁵⁶.

⁸⁴¹ Devised mainly by priests (inclusive in Byzantine chant) such as Chrysanthos Karamelles (as seen above) or Shihāb-a-d-Dīn al-Hijāzī (see [Beyhom, 2012]) and Muḥammad al-ʿAṭṭār (see [Beyhom, 2015b], Chapter I).

⁸⁴² Being a Pythagorean-like conceptualization of his predecessors' scale.

⁸⁴³ Either a *tunbūr* (long-necked lute) or a *ūd* (short-necked lute).

⁸⁴⁴ See [Beyhom, 2012].

⁸⁴⁵ This applies to Byzantine chant as seen above, to the “Arabian-Persian” quarter-tone scale, and to the 24 unequal intervals (“Pythagorean”) division elaborated by Rauf Yekta Bey (Yekta-Ezgi-Arel system).

⁸⁴⁶ The shift had started before Mashāqa, as ‘Aṭṭār’s 24-intervals equal-division of the string (see footnote 605) shows.

⁸⁴⁷ Invert the two if needed.

⁸⁴⁸ Which, while being the first country targeted by this process, resisted a little more because of the Ecumenical Patriarchate reluctance to implement Western theories in Liturgy.

⁸⁴⁹ A long process which materialized in Kāmil al-Khulāʿī’s book in 1904.

⁸⁵⁰ Having migrated meanwhile from Ottoman to Occidental rule.

⁸⁵¹ A process which has begun with Cantemir and cristallized in Rauf Yekta Bey’s theory as in the *Encyclopédie de la musique* [Yekta, 1922], a conclusion which was definitely precipitated by the “Young Turks” movement.

⁸⁵² “It is no coincidence that a small treatise on Latinizing the Persian language comes at the end of the first system of notation for Persian music. Dating from 1923, this system uses the Western scale supplemented by diacritic signs, that is to say half-flats and half-sharps, in order to retain something of the subtleties” – [During, 2005b, p. 145].

⁸⁵³ On the question of how the Young Turks movement influenced Nationalisms in the Arabian countries and the turn of Arabian peoples from complete support to this movement to an Entente with Western countries, see notably [Lutsky, 1969, p. 335–352] which gives an informative analysis on the process, notwith-

→

standing the Soviet bias which prevails in most of the book. See also [Bohman, 2001, §III]: “In general, the history of music in the Middle East follows an alternating pattern of expansion and consolidation, with classical traditions forming around a theoretical core. These then spread to and beyond cultural peripheries, only to enter a new phase of consolidation. The early expansion of Arab musical practices, therefore, was followed by the emergence of Persian musical practices, which in turn led to a shift towards the dominance of Turkish theoretical writing with the rise and expansion of the Ottoman empire until the 17th century. Similar patterns characterized the nationalistic movements of the 20th century, in which the consolidation of national power frequently stimulated attempts to shape, even through legislation, a national musical tradition through the institution of written traditions, musical ensembles and music academies, as emblems of a national music history”.

⁸⁵⁴ Even when it is written by the victors.

⁸⁵⁵ An empire is, by definition, multi-ethnic, a definition which spares the readers from continuous explanations (and me from continuous justifications) on the Persian and Turkic elements which were main components in this empire.

⁸⁵⁶ Orientalist activity in the field of *maqām*-music was buoyant in the 19th-20th centuries, with numerous translations of Arabian treatises or books on music undertaken mostly by French philologists or musicologists; for instance [Vaux, 1891] – Urmawī’s *Sharafīyya* (13th-14th centuries) – for the late 19th century, and Erlanger’s monumental *Musique arabe* (1931-1959) which contained both translations from Fārābī and (Ibn) Sinā or Systematist treatises in the first four volumes, and an in-depth study of Arabian music (scales and praxis) in the last two volumes. Specialized studies (such as [Collangettes, 1904; 1906], entitled “Étude sur la musique arabe”) relied on these or other partial translations, sometimes by the author of the study himself (as for Land’s *Recherches sur l’Histoire de la gamme arabe* [1884]).

After an initial period of detailed studies of Early theories and Autochthonous *maqām*-praxis⁸⁵⁷, the need to resolve this conflict of interests between the Occidental claim for the exclusive legacy of Greek heritage, on one side, and the evidence of the treatises of Kindī, Fārābī, (Ibn) Sīnā and others, on the other side, led Western musicologists to choose between two options:

1. Either music history is evolutionary and the Arabs were the successors of the Ancient Greeks, which means their existing music was the legacy of the music described in Early Arabian treatises, hence:

- the Arabs were the “real” heirs of Ancient Greece, and their current music was the continuation of Greek music,

which was evidently an unsustainable, if not unbearable option for Western musicologists; hence the need for alternatives, namely:

- First alternative (Evolving history): Arabs are (or were) indeed heirs of Greek culture but their music remained static and identical to the music of Ancient Greece (following the Occidental restricted acceptance of this music) in the first centuries of Islam,

→ while afterwards (under the influence of Persian music for instance) this music degenerated and was misled in the intricacies of non-temperament, or,

- Second alternative (Evolving history): Arabs have purely and simply copied Ancient Greek music and theory, and while they should be given credit for transmitting those to the Western world, this was however done in an altered form,

2. or (2nd option, close to the Second alternative above): music history is not evolutionary, and the Arabs copied Ancient Greek theories; hence these theories can only be ditonic.

From there, and in order to contend one of the three acceptable choices (the last three) amongst the four proposed above, it became essential for Occidental

musicologists to prove that Arabian theories of the scale were effectively ditonic from their onset, *i.e.* Pythagorean in the restricted acceptance, and to overlook, whether consciously or unconsciously, any contradicting evidence in Early Arabian writings as well as to dismiss Arabian music praxis as an irrelevant, later inconsequent addition to Ancient Greek music⁸⁵⁸, a deviation from the history of the civilized world.

THE “FRETTING” OF THE ARABIAN *‘ūd* – OR SEQUENCING MUSICOLOGICAL ORIENTALISM

As long as the main threat comes from the theories of the scale, and while these theories are, for all of them in the Early Arabian writings about music theory⁸⁵⁹, based on the *‘ūd*⁸⁶⁰, the first procedure to use was to change the Zalzalian aspect of theories using this instrument, namely:

1. Firstly, and from one, single (theoretical) description by the first major Arabian theoretician, Ya‘qūb Ibn Ishāq al-Kindī⁸⁶¹ (“The Philosopher of the Arabs”), and by neglecting all indications about praxis as provided by this author, the “Early Arabian *‘ūd*” (of the “Middle Ages”) is proclaimed “fretted” ditonically, hence:
 - Early Arabian music was ditonic and tempered (no more “movable [or ‘passing’] notes” to bother about).
2. Secondly, and from this first example, it is decreed that *all* Arabian *‘ūd*(s) were “fretted”, not

⁸⁵⁸ Or a reminiscence of Ancient, outdated Asian traditions.

⁸⁵⁹ And until at least the 14th-15th centuries.

⁸⁶⁰ With a small exception for the *ṭunbūr* in Fārābī’s and (al-) Ḥasan (al-) Kātib’s treatises, cited however very shortly and as a by-product (theoretically) of the *‘ūd* – see [Beyhom, 2010c, v. 1, p. 310 sq.].

⁸⁶¹ I show in [Beyhom, 2010c, v. 1, p. 583–591] that the alleged “ditonic fretting” of the *‘ūd* in the epistle of Yahyā ibn ‘Alī ibn Yahyā ibn abī Manṣūr al-Munajjim cannot be proven, and that his description may apply to an infinity of meshings, including Zalzalian. Besides this and Kindī’s descriptions, there exists still the description of the *Ikhwān a-ṣ-Ṣafā’* which is very short and far away from praxis; the whole problematic of the “ditonic” fretting of the *‘ūd* is treated in the aforementioned book and in [Beyhom and Makhlof, 2009], in which I explain that these “frettings” were theoretical (and hypothetical), merely used for the materialization of the positions of the tips of the fingers on the neck of the *‘ūd*; I show below in this dossier the extent of (musicological?) bad faith (or conscious “blindness”) which prevails in most of the literature on the “fretting” of the *‘ūd*.

⁸⁵⁷ Which covers basically the 19th century and the first decades of the 20th century: this is the time of researches such as Villoteau’s and Kiesewetter’s, then Land’s and, consequently, Collangettes’ cited above.

only in theory but also in praxis, not only at the time of Kindī, but from the very beginnings of this music until the post-Şafīyy-a-d-Dīn period,

“forgetting” that:

- Kindī was the first (Pythagorean and influenced by Plato⁸⁶²) philosopher who took over Ancient Greek theories⁸⁶³ for the needs of theorizing the still un-theorized Arabian music of his time, and that it was tempting to materialize this division directly on the neck of the *ūd*, the primary instrument of Arabian music then,
- Kindī’s epistle *Risāla fī-l-Luḥūn wa-n-Naḡham*⁸⁶⁴ was written⁸⁶⁵ for the son of Caliph al-Mu‘taṣim (833-842), Aḡmad ibn al-Mu‘taṣim⁸⁶⁶, and was meant as an informative brochure as well as a teaching method for the instrument⁸⁶⁷,
- Kindī’s description, in the only instance where he describes the technique of *ūd* playing and strings stopping, is at some point inconsistent and incompatible with an effective fretting of the instrument,
- the same Kindī described notes “used by singers” from which it can be deduced that the effective division of the scale was the seventeen (unequal-)intervals division⁸⁶⁸ (see FHT 29, p. 195) explained⁸⁶⁹ by his great successors Farābī (the “Second Master”⁸⁷⁰) and Sinā⁸⁷¹,

- all subsequent authors who mention “ties” on the neck of the *ūd* explain that the string must be stopped at exactly the position of the “tie”, (which is incoherent with the “ties” having the function of effective frets)⁸⁷², and that most of them mention the possibility of stopping the strings *between* the “ties”⁸⁷³, or to use hand shifts⁸⁷⁴ (towards the bridge) for higher notes, to positions where there are *no ties* (or marks),
- the second proven description of effective “fretting” of the *ūd*⁸⁷⁵ is contained in the treatise of al-Ḥasan ibn a-ṭ-Ṭaḡḡān, a Fatimid musician and music teacher who explained that such frettings are used only for beginners⁸⁷⁶,
- all subsequent authors who mention “ties” (*dasātīn*) on the neck of the *ūd* either do not mention any material for those, or explain that

⁸⁶² See for instance [Wright, 2001a] or [Adamson, 2011], and notably in the latter: “Abu Yusuf Ya‘qub ibn Ishaq Al-Kindi ca. 800–870 CE) was the first self-identified philosopher in the Arabic tradition. He worked with a group of translators who rendered works of Aristotle, the Neoplatonists, and Greek mathematicians and scientists into Arabic. Al-Kindi’s own treatises, many of them epistles addressed to members of the caliphal family, depended heavily on these translations”.

⁸⁶³ His inspiration came most probably from the pseudo-Euclidos or from another ditonic Pythagorean source.

⁸⁶⁴ In which the description of the “fretting” (tying) is found.

⁸⁶⁵ See [Beyhom, 2010c, v. 1, p. 125].

⁸⁶⁶ An amateur musician – see also footnote 862.

⁸⁶⁷ See the paragraph about a-ṭ-Ṭaḡḡān below.

⁸⁶⁸ Compare with Jean-Claude Chabrier who describes Kindī’s system (in [Rashed, 2002, p. 573]) as “a simple Pythagorean system [which] does not introduce any [...] degree defining intervals of an exotic type such as neutral seconds or neutral thirds”.

⁸⁶⁹ With small discrepancies between the two descriptions.

⁸⁷⁰ By reference to the “First Master”, Aristotélēs.

⁸⁷¹ As explained in [Beyhom, 2010c, v. 1, p. 183–276 (Chapter II)]: note that both authors do not name any material for the “ties” on the neck of the *ūd*.

⁸⁷² In fretted lutes, strings must be pressed slightly (depending on the distance between frets, approx. 0.5-1 cm) before the position of the fret for the sound to be heard clearly, which is the first left-hand technique (for right-handed musicians) that guitar and other fretted lute performers are taught – see the two videos (in French – by Hamdi Makhlouf) <http://foredofico.org/CERMAA/wp-content/uploads/2016/07/video-1-kindi.mp4> and <http://foredofico.org/CERMAA/wp-content/uploads/2016/07/video-2-Tahhan.mp4> showing the practical tying of the *dasātīn* (as described by Kindī and Ṭaḡḡān – see footnote 876) on the neck of the *ūd*, and resulting problems for performance.

⁸⁷³ See for instance Farābī’s description in [Farābī (al-), 1930, v. 1, p. 174], and the original Arabic text from [أبو نصر محمد بن محمد بن [ترخان الفارابي, 1967, p. 516]:

“غير أنه ليس في تكثير الدساتين كبير غناء. وكثير من الناس يستعملون نغمًا غير هذه بحسب حاجاتهم إليها في تميم الطرائق التي يستعملونها أو في ترتيبها، من غير أن يكون لتلك النغم أمكنة محدودة، فبعض تلك النغم يستخرج فيما بين الدساتين وبعضها يستخرج أسفل دستان الخنصر وبعضها فوق دستان السبابة، ويُقصد باستخراجها أن تعزّز النغم. ومتى أحب إنسان أن يعرف تلك النغم، فالوجه في ذلك أن يطلب ملائمتها في الأمكنة المعروفة، إما على الدساتين أو في أمكنة آخر”.

⁸⁷⁴ Described for instance by Farābī (see previous footnote) and by (Ibn) Sinā and (Ibn) Zayla – see [Beyhom, 2010c, v. 1, p. 332].

⁸⁷⁵ Probably inspired by Kindī’s description.

⁸⁷⁶ “Ibn al-Ṭaḡḡān, himself a musician, [...] tells us, however, that *he* did not need *dasātīn* on his lute because **he knew the place of every note on the fingerboard** without *dasātīn*” – [Farmer, 1937b, p. 457], and the original Arabic text of (Ibn a-ṭ-) Ṭaḡḡān in [Beyhom, 2010c, v. 1, p. 583–591] (or in the facsimile of the manuscript [Ṭaḡḡān (ibn a-ṭ- ~ al-Mūsīqī), 1990, p. 175]):

“و [...] دستان آخر يستعمل دستان زلزل وأكثر الناس يُهمله ودستان آخر يقع بين دستان البنصر ودستان الخنصر يُهمل أيضًا وهذه الدساتين الخارجة عن العدد الأول فهي ممّا يستعمله الفرس في طرائقهم وأنا أستعمل ذلك وأطرق مواضعه لمعرفتي به بغير دساتين وذلك يصعب على المتعلمين فتركه لهم أولى وأحق”.

these “ties” are marks⁸⁷⁷ on the surface of the neck materializing stopping positions of the strings for the performer⁸⁷⁸.

Hence, and despite discordant voices⁸⁷⁹, the myth of the fretting of the Early ‘ūd⁸⁸⁰ promoted by a series of more or less renowned authors including Lachmann,

⁸⁷⁷ Or possibly a thread: the only author who says otherwise is Lādhiqī who considers however both possibilities: “and marks were put on the necks of these instruments [‘late ‘ūd(s)’] that show the stopping points of the strings for the notes, and these marks are called *dasātīn* whether they are tied strings or drawn lines or others” – translated from the original Arabic [Lādhiqī (al-), 1986, p. 179]:

“وقد وضع على سواعد تلك الآلات علامات دالة على مخارج نغمات مدار الالجان من تلك السواعد ويسمى تلك العلامات بالدساتين سواء كانت أوتارا مشدودة أو خطوطا مكتوبة وغيرها.”

⁸⁷⁸ Urmawī explicitly states (in [Urmawī (d. 1294) and [Jurjāni (al-)], 1938, v. 3, p. 111]) that the “*dasātīn* are marks on the neck of the ‘ūd which are used to materialize (indicate) the stopping points of predetermined notes on the strings”, in the original Arabic text (from [Urmawī (d. 1294), 1984, p. 141]):

“والدساتين هي علامات توضع على سواعد الآلات ذوات الأوتار ليستدل بها على مخارج نغم معلومة في أماكن مخصوصة.”

⁸⁷⁹ Such as Curt Sachs’ statement “Lutes seem to have no frets, either in older times or today, in spite of the constant use by the theorists of the word *dāsātīn* {sic – should have been *dasātīn*], plural of Persian *dast* or ‘hand’, which is used to indicate frets [in fact ‘ties’]}. And it would have been difficult to string them securely around the sloping end of a pear-shaped lute. Very probably, the frets existed only theoretically to symbolize the positions of the stopping fingers” – [Sachs, 1940, p. 254]; Manik cites also [1969, p.16] Karl Geiringer’s (and Berner’s in his chapter on the ‘ūd [Berner, 1937, p. 18–23], based on Geiringer’s) contradictory opinion (to the “fretting” thesis) in “K. Geiringer: ‘Vorgeschichte und Geschichte der europäischen Laute bis zum Beginn der Neuzeit’, in *ZfMw*, X, 1927/28, S. 570”, based on iconographical evidence; note that Geiringer could have been influenced by C. Sachs’ opinion (had the latter expressed it before the quoted statement above), having been his student at the university of Vienna (see [Anon. “Karl Geiringer”, 2016]).

⁸⁸⁰ Mainly established in Lachmann’s “Die *Vīnā* und das indische Tonsystem bei Bsachsharata”, *Zeitschrift für vergleichende Musikwissenschaft*, II, 1934, p. 64 (according to [Manik, 1969, p. 12]) and in Henry George Farmer’s “Was the Arabian lute fretted?” [Farmer, 1937b]: Farmer was a prolific writer (examples of his writings concerning – more or less directly – the lute are [Farmer, 1919; 1931; 1932; 1935; 1937a; 1939; 1944; 1945; 1949; 1993] etc.), albeit faulty in many of his assertions about Arabian music, including the ‘ūd, mainly because of his (sometimes) poor understanding of the languages of the manuscripts (see for example [Bouterse, 1979], [Beyhom, 2010b – Appendix on the ‘ūd; 2011; Beyhom and Makhoul, 2009], for examples of faulty assertions by Farmer), or driven by his urge to present Arabian music as a precursor of polyphony for Western music as we have seen above.

Farmer, Manik, and finally Neubauer⁸⁸¹, is still taught in *maqām* musicology against all factual data⁸⁸² that we have, thus:

- in the *Encyclopedia of Islam*:

“Unlike the mediaeval lute, the modern lute is not fretted”⁸⁸³,

- or further widened such as in Poché’s assertion in the *New Grove*:

“The neck [of the ‘ūd] rarely has frets (*dasātīn*), but some are found on the Tunisian ‘ūd of Khumayyis Tamān”⁸⁸⁴,

- while we can read in the same dictionary:

“The ‘ūd still survives over all the Arab world, where it is used as a solo instrument and for accompanying song, though it no longer has frets”⁸⁸⁵.

While this myth has already been invalidated elsewhere⁸⁸⁶, very few contemporary researchers have put in doubt this common-place belief⁸⁸⁷, and sometimes indirectly such as Jean During⁸⁸⁸ in the *Encyclopedia Iranica*⁸⁸⁹.

⁸⁸¹ Not to forget Christian Poché, whose numerous errors concerning Arabian music duplicate errors made by earlier musicologists, or introduce new inconsistencies – see for instance [Beyhom, 2011].

⁸⁸² In fact a converging array of evidence contradicting the thesis of the “fretted” ‘ūd.

⁸⁸³ [Chabrier et al., 2000], entry “‘ūd”.

⁸⁸⁴ [Poché, 2001, p. 27], entry “‘ūd”: all Tunisian colleagues and musicians that I could consult on the matter confirm that they never saw, or heard of, “frets” on the neck of Khumayyis Tamān’s ‘ūd.

⁸⁸⁵ [Wachsmann et al., 2007]: entry “Lute”.

⁸⁸⁶ See [Beyhom, 2010c, v. 1, p. 324–363; Beyhom and Makhoul, 2009].

⁸⁸⁷ In fact, During’s quote is the only contemporary example I could find besides earlier affirmations cited in footnote 879; note that this quote (see footnote 889), does not concern itself with the ‘ūd directly, but with the *barbaṭ* – most probably the ancestor of the ‘ūd – in a Persian context.

⁸⁸⁸ Although During, basing himself on available literature, does attribute frets to the *barbaṭ*: “The *barbaṭ*’s frets and four silk or gut strings (from three to seven in the Indian form; according to other sources [Mallāh, p. 94], the original had three strings to which a fourth was added) were plucked with a wooden plectrum and tuned in fourths”. Compare with [van Oostrum]: “The *barbaṭ*’s frets and four strings—made of silk or gut, sometimes doubled, tuned in fourths, and plucked with a wooden plectrum—reach a range of nearly two octaves”.

⁸⁸⁹ “The *Barbaṭ* [...] was later supplanted by an improved modification, the ‘ūd (attributed to Z[i]ryāb, 8-9th cent.; Farmer, *loc. cit.*), which originally had four, then five double gut strings, a deeper and rounder sound box made of wood strips, and a neck that was independent from the body. For some time the new lute retained such features of the old *barbaṭ* as simple, as opposed to

To fully understand the reasons of the persistence of this fabrication⁸⁹⁰, against all indications of its invalidity, there needs only to remember that the music of the Early Arabs, in the eyes of Occidental musicologists, may explain the European music of the Middle Ages and its (later) crystallization in the ditonic paradigm, the Arabs having merely copied this theory from their predecessors and having further “regressed” being influenced by Persian (or other) music(s)⁸⁹¹, *i.e.* musics supposedly outside the realm of restricted Hellenism.

In the meantime, European (musical) culture retrieved its legitimate Greek legacy in its purest (ditonic) form, from which we can conclude that Europe and the Occident are effectively the only legitimate heirs of Greek culture and civilization, QED.

In parallel to this demonstration, all indications in the Early Arabian treatises on praxis⁸⁹² at that time are deemed insignificant or simply avoided⁸⁹³, the role of ditonism is amplified and Zalzalian praxis minimized while archeological evidence is ignored for the sake of “continuity”⁸⁹⁴ and, when the evidence becomes too

→

double, strings and seven frets that divided the fingerboard; nevertheless, double-stringed and non-fretted lutes also existed” – [During, 1988].

⁸⁹⁰ Or “mere fiction” as expressed in [Berner, 1937, p. 19]: “Wir müssen demnach annehmen, daß es sich bei der Bundlaute der Theoretiker um eine **bloße Fiktion** handelt, können allerdings in ihren Abhandlungen keine Bedeutung finden, welche diese Auffassung unterstützt”.

⁸⁹¹ See for instance [Parisot, 1898, p. 10].

⁸⁹² With regard to the scale and intervals used by performers.

⁸⁹³ Chapters I and II in [Beyhom, 2010c] reproduce these indications and explain their influence on the resulting, effective scales of that time.

⁸⁹⁴ An example amongst others coming from Pharaonic Egypt: Egyptian (mostly long-necked) lutes dating back to the 18th Dynasty (middle of 16th-14th centuries B.C.) have been found, one of which with remains of ties around the neck, and showing a Zalzalian tuning. The speaker at the ICONEA 2011 Conference (in which I took part personally), Ricardo Eichman (Paper title: *Extant lutes from the New Kingdom and the Coptic Period of Ancient Egypt*), explained that though he agreed with his local (Egyptian) colleagues about the Zalzalian nature of the resulting scale, “this tuning d[id] not comply with theory”; when asked (by myself) about the meaning of this statement, Eichman essentially explained that the scale did not conform to Pythagorean ditonism. As the result of the debate following this statement, Eichman explained that he consulted “specialists of the field” who had reservations about such (Zalzalian) results, which he later explained to me (through email exchanges) thus: “I looked at lutes from the 18th Dynasty (middle of 16th-14th centuries B.C.).

→

insisting, Arabian music becomes promoted as formulary music with the scale playing a secondary role in its structure⁸⁹⁵.

Moreover, and while this field of research is already crowded with factual errors⁸⁹⁶, new errors are added which are not even corrected when signaled to the authors, for reasons unascertained but probably of pride or for the sake of one’s career⁸⁹⁷.

→

Unfortunately there was only one lute with remaining traces of tied frets. While the first fret represents the ‘nut’, the second fret was not clearly visible, but it was clear that there had been a fret in the vicinity of the 200-220 cents point. For the third fret position we have two clear traces of fret positions: one almost exactly at the 312 cents point and the other around 358 cents. There are now two results: the Zalzal’s third could have been in use in Pharaonic times, as well as the minor third. Interestingly, others, studying the *nāy*, came to a comparable result. When I was asked, where the Pythagorean diatonic scale theory came from, I referred to Archaeologists and Assyriologists who are at the same time Musicologists (Anne Kilmer was the first, Konrad Volk a more recent one). They [...] represent my field of activities (Archaeology, Assyriology in contrast to Musicology) [...]. As an archaeologist, I am not able to identify the pythagorean diatonic system on the preserved lutes. But, I cannot exclude the possibility of a pythagorean diatonic system in Mesopotamia and Egypt. This theory is connected to the tuning instructions of lyres or harps. What the Assyriologists and Musicologists presented so far seems to be compatible with the cuneiform texts. Such system, however, is not yet attested for Egypt. Developing scales with free strings (lyre) and stopped strings (lute) may lead to different results”. Note that the speaker, during the debate following his paper at the Conference, eventually agreed with me that other, alternative theories could be used to characterize such scales, including equal-divisions of the strings.

⁸⁹⁵ A statement I was compelled to listen to on numerous occasions at the Université de la Sorbonne in Paris, evidently from teachers there.

⁸⁹⁶ For instance Dom Parisot’s famous statement in [Parisot, 1898, p. 15] that “Mikhā’il Mashāqa is the inventor of the quarter-tone system”.

⁸⁹⁷ I witnessed personally a number of (minor, but symptomatic) such erroneous introductions, and unsuccessfully tried to have them corrected: for instance when reporting to musicologist Lisa Lino about her article “Inheriting the Ghammāz-oriented Tradition: D’Erlanger and Aleppine Maqām Practice Observed” (*Ethnomusicology Forum* 18 2), that her claim (see the summary of [Lino, 2009]) that the “The concept [of *ghammāz*] was first introduced by Rodolphe d’Erlanger in the Congress of Arab Music held in Cairo in 1932” was erroneous, and that Mikhā’il Mashāqa introduced this “concept” one century before Erlanger; two years after that (and still today to my knowledge), this error was still not corrected. Another recent example is the publication by Jean Lambert (French specialist of Arabian music and editor of a book [Lambert, Mokrani, and Centre français d’archéologie et de sciences sociales de Sanaa, 2013] on the Yemenite lute, the *qunbīs*) on the website of the Société Française d’Ethno-

→

All this Orientalist procedure persists until today, leaving Autochthonous musicologists with one of two choices: endorse the fable(s) put together by Occidental musicologists, or try to establish an alternative musicology of the *maqām*, if not an alternative musicology altogether.

The Soviet alternative?

The only alternative⁸⁹⁸ to Western influence has been, for Third and Fourth world countries and for long decades until the fall of the Berlin Wall, the Soviet⁸⁹⁹ model; but which alternative in music(ology) could the U.S.S.R. provide?

* * *

In the early 1990s,⁹⁰⁰ as I was still a research engineer and music aficionado⁹⁰¹, I went to Bulgaria⁹⁰² following my discovery of “Le Mystère des Voix Bulgares”⁹⁰³ and other Bulgarian groups and choirs

→ musicologie, of a dating of the first description of the “Modern” *ūd* from the 13th century, whereas (at least) three different books [Ṭaḥḥān (ibn a-ṭ-~ al-Mūsīqī), 1990; 2006, قطط; Beyhom, 2010c] and (at least) three different articles or papers [Beyhom and Makhlouf, 2009; Neubauer, 1993; Ṭaḥḥān (ibn a-ṭ-~ al-Mūsīqī), 1976] (including Yūsuf’s fac-simile for the Congress of Arabian music in Baghdad in 1976) reproduce (a-ṭ) Ṭaḥḥān’s description (11th century): although this has been discussed directly with the author, an *erratum* was (to my knowledge) never published.

⁸⁹⁸ Except of course for the non-aligned movement who was founded in 1961 only and had however (due principally to its heterogeneity) no real model of society to propose, but only political neutrality between the two major blocs, the Eastern (mainly Soviet) and the Western (mainly American) blocs – see [Anon. “Non-Aligned Movement”, 2016] for more details.

⁸⁹⁹ Or the Chinese (Maoist) model – see footnote 947, p. 167.

⁹⁰⁰ My trip to Bulgaria took place in December 1990 and January 1991.

⁹⁰¹ Wether Arabian, Western, Classical, Jazz or Ethnic (or Traditional) music from around the world...

⁹⁰² I travelled to this country a few times before this trip, and was somewhat acquainted already with its culture and history.

⁹⁰³ 2 CDs produced by Marcel Cellier in France in 1986 (according to [Anon. “Le Mystère des voix bulgares”, 2015]; the English article of Wikipedia [Anon. “Bulgarian State Television Female Vocal Choir”, 2016] says 1975, which seems to be the year of the production of the LP – many editions are available the references of which can be found at <https://www.discogs.com/fr/Marcel-Cellier-Pr%C3%A9sente-Le-Myst%C3%A8re-Des-Voix-Bulgares-Vocal-Choir/> and <https://www.discogs.com/fr/Marcel-Cellier-Pr%C3%A9sente-Le-Myst%C3%A8re-Des-Voix-Bulgares-Volume-1/master/>

including the Trio Bulgarka⁹⁰⁴. The aim of my trip was to try and understand what seemed to be⁹⁰⁵ similar characteristics between Arabian and Bulgarian musics, and to journey and listen to local bands and singers, buy LPs for my collection etc.

I was provided in Paris the coordinates of Nikolay Kaufmann, a prominent composer of the Bulgarian state choir⁹⁰⁶, and could arrange to meet him in the Institute of Folkloristics in Sophia⁹⁰⁷. I was for instance intrigued by the chant of Radka Aleksova on *Besrodna Nevesta*⁹⁰⁸, which seemed to me non-tempered⁹⁰⁹, and by similar characteristics in the singing of the Trio Bulgarka.

Kaufman answered to me explaining that his compositions were all tempered and semi-tonal⁹¹⁰, and that Aleksova did not sing in tune because she had no musical education⁹¹¹. As for the singers of the Trio, the composer’s answer was that the differences of pitches that I seemed to perceive in the song *Sluntseto Trepti Zauda*⁹¹² were due to their old age, which kept them from mastering their voices and made them bleat...

Having listened to numerous other “Folkloric”⁹¹³ Bulgarian songs and bands⁹¹⁴, I was very surprised by these explanations, if not slightly discouraged, but of course I had no idea then of the particularities of

→ 38360, visited 20/04/2016) and 1988 ([Anon. *Le Mystère Des Voix Bulgares*, 1986] and [Anon. *Le Mystère Des Voix Bulgares, Vol. 2*, 1989]), with a third volume produced in 1991: the contents were a compilation by Cellier consisting mostly of pieces by the Bulgarian State Television Female Vocal Choir.

⁹⁰⁴ The three singers of the Trio Bulgarka were, according to [Anon. “Le Mystère des voix bulgares”, 2015], soloists of the same Bulgarian State Television Female Vocal Choir.

⁹⁰⁵ For me, and at that time.

⁹⁰⁶ And an eminent ethnomusicologist (see [Anon. “Nikolay Kaufman”, 2016]), but this I did not now then, neither did I understand the meaning of the term “ethnomusicology”.

⁹⁰⁷ Of which, I recall, he was the director.

⁹⁰⁸ Radka Aleksova begins the song, track 13 on the CD, with a solo performance.

⁹⁰⁹ In my thought it was more, then, that Aleksova’s singing seemed “Arabian”.

⁹¹⁰ Classical, I would say.

⁹¹¹ “*Ne grammatnaya*” in transliterated Russian, which was the language we used with Kaufmann.

⁹¹² [Trio Bulgarka, 1988, track 3].

⁹¹³ The term applied officially to Bulgarian traditional music.

⁹¹⁴ For instance Slide No. 39, “Bulgarian Folk song – excerpt”.

Soviet Ideologically-driven musicology⁹¹⁵, nor of the influence of Occidentism on the discourse of scholars and professional musicians in the Soviet sphere of influence⁹¹⁶.

SOVIET MUSIC POLICY IN THE FORMER U.S.S.R.

The Marxist-Leninist “official” position concerning arts, whether in the former U.S.S.R. or in China, could be summarized by the formula: “art should serve the masses”⁹¹⁷.

This could uneasily apply to the last period of the Soviet Empire, when musical Conformism became predominant⁹¹⁸, which was however not always the case⁹¹⁹:

“Schematically, the evolution of Soviet music may be divided into three phases: (1) 1917-1927, when radical Russian musicians attempted to create a new revolutionary art on the ruins of the old; (2) 1927-1936, signaled by the emergence of so called proletarian music; (3) 1936-1950, when cosmopolitan modernism and proletarian sectarianism were abandoned, and the ideal of Socialist Realism, ‘an art national in form and socialist in content,’⁹²⁰ in Stalin’s phrase, became

⁹¹⁵ I had nevertheless the same impression as when discussing with directors of music institutions or professional musicians in Lebanon, a definite disdain (if not despise) for “popular” music, a deep drive for “Classical” respectability.

⁹¹⁶ Although I have lived and studied in Moscow for 6 years in the late seventies-early eighties, I did not have then any contact with Soviet musicology, whereas in everyday contact with different ethnical groups of the Soviet empire (Moscow is evidently a convenient place for such encounters) I could sense a thirst for tradition as a reaction to the repression of certain of its aspects (such as the use of the Arabian alphabet for Central Asian countries) by the authorities.

⁹¹⁷ [Morcom, s.d., p. 13–14]: “The defining and still remarkably enduring Chinese communist statement on literature and the arts is Mao’s opening and concluding speeches on 2 and 23 May 1942 at the conference on literature and art held in Yan’an, which was first published in 1943 as *Talks at the Yan’an Conference on Literature and Art*. This statement, which has its roots in Marxist-Leninist theory, expounds two fundamental concepts of what art should be and how it should be evaluated:

1. There is no such thing as ‘art for art’s sake’: all art must serve socialism and the socialist state.
2. Literature and art are from the masses, for the masses and should raise the standards of and educate the masses”.

⁹¹⁸ This is a personal observation from the 1980s, as I was studying engineering in Moscow.

⁹¹⁹ Regardless here of the question of the conformity of Late Sovietism (Stalinism and post-Stalinism) with Marxism-Leninism.

⁹²⁰ About the shift from Internationalism to Nationalism and the changing and contradictory Soviet policy on the latter, see the premonitory *L’empire éclaté* (in French) [Carrère d’Encausse, 1980], notably the conclusion [p. 331]: “The Soviet political scene

the approved slogan. It is natural that in the first flush of the Revolution extreme tendencies should have prevailed in the arts as well as in politics. In 1920 the Russian musicologist, Arseny Avraamov, wrote a letter to the Department of Education, proposing the confiscation and destruction of all pianos as a step towards the abolition of tempered pitch. Others urged the junking of stringed instruments as well. New revolutionary music, they argued, could not be created by ‘scraping dried cows’ guts with horsetail hair’⁹²¹.

While Russians, whether during Imperial times or after, have always hesitated between their European or Asiatic identity and belonging, the trend from the time of Peter the Great (1672-1725)⁹²² on has been to consider the Russian people as European, or at least “Europeanized”⁹²³.

→ is characterized before all by National diversity and the intensity of national feelings. In this regard, the National politics of the authorities is a spectacular success, and nonetheless a spectacular failure. [...] [This was] a failure because the second component, the second stage of the Bolshevik project was the obliteration of National differences, their fusion in a superior, new community: the Soviet people”; see also [Broda, 1931], a contemporary article which describes notably the first stage (helping the peoples and ameliorating their living standards) of this policy, or [Phinney, 1935] with an apology of Soviet National Policy (resembling the “Mission civilisatrice” of the French and the Portuguese) which concludes [p. 327] very optimistically: “This in general has been the direction and spirit of rehabilitating backward nationalities in the Soviet Union. A distinguishing feature in this process, which has created a new life among nationalities, is a native spontaneity reanimating the traditional elements and forms of culture and bringing them into a new synthesis, consistent with the development of future world cultures national in form and international in content”. Needless to say, Soviet National Policy seems to have been far from purely altruistic (see for instance [Hirsch, 2000], and [Slezkine, 2000] for a discussion and projection into the 21st century), and its consequences were devastating for the cultures of the nations of the periphery, notably in music as is shown below.

⁹²¹ [Slonimsky, 1950, p. 236].

⁹²² Who Westernized and extended the Tsardom of Russia (later to become – under his reign – the Russian Empire).

⁹²³ But never completely, as the continued contacts with Asian populations created cultural links and influences in both directions; on Russia (and the U.S.S.R.) as a “Western” or “Eastern” country, see for instance the interesting article by George Guins [1949], notably the conclusion [p. 283]: “A long time ago, the poet Tiutchev with his Pan-Slavic and imperialist sympathies imagined the frontiers of Russia stretching–

‘From the Nile to the Neva, from the Elba to China,
From the Volga to the Euphrates, from the Ganges
to the Danube...’

Soviet writers ridicule this Russian geography according to Tiutchev. The same Russian geography, however, is being recreated under other slogans and with the help of other ideas and

With Marxism⁹²⁴ as a Western ideology *par excellence*⁹²⁵ the Bolsheviks, led by Vladimir Lenin and having failed, to the end of World War I, in exporting rapidly the (1917) revolution and internationalizing it, eventually decided to construct Socialism in one country⁹²⁶, in fact a conglomerate of more than 100 different ethnical groups and regions inherited from the Russian Empire. At the same time, and regardless of the struggle on the internal front to secure the Bolshevik power in Russia and its periphery, Worldwide domination of the Proletarian class

remained the final objective of Lenin and his companions⁹²⁷.

The need to integrate in the new Soviet society sometimes antagonistic ethnical groups or regions from the periphery, rushed the Bolsheviks into a policy of cultural and industrial development⁹²⁸ of the latter⁹²⁹ which eventually led⁹³⁰ to the creation of “Folkloric” music groups, with harmonized and equal-tempered compositions⁹³¹ exported as a showcase of Soviet Cultural policy with the minorities in the U.S.S.R.⁹³²

→ methods. To this end a new culture is being forged, on a Western foundation, but neither of the West nor of the East” – see also [Robinson, 1981, p. 14]: “Russia was not an Asian country until the Treaty of Nerchinsk in 1689 and did not settle the Far Eastern portions of Siberia until the nineteenth century. [...] The 1905 Russo-Japanese War put an end to St. Petersburg’s Asian ambitions and was the catalyst for the 1905 Russian Revolution, leading twelve years later to the Bolshevik seizure of power. These events caused Russia’s (now the Soviet Union’s) Asian posture to turn back to the defensive, from which it emerged only in 1945”.

⁹²⁴ And later Marxism-Leninism.

⁹²⁵ Marxist thought is based on the principle of Historical evolution of societies and peoples, while the “Historical conditions for the Socialist Revolution” include above all the existence of a proletarian class (created through an accumulation of profit converted into capital and) which existed virtually, until the 20th century, only in the Occident; the logical conclusion for Marxism thought was that the Asian peoples, which had not “yet” reached the Capitalist Period, should be helped get to that stage for which they had to renounce all their “backward” traditions – an efficient review of Marxist ideology is provided in [Anon. “Marxism”, 2016].

⁹²⁶ “A theory put forth by Joseph Stalin in 1924, elaborated by Nikolai Bukharin in 1925 and finally adopted by the Soviet Union as state policy” – in [Anon. “Socialism in One Country”, 2016]; see also [Stalin and Fineberg, 1935] (originally published in Russian in 1913 and available online in [Stalin, 1953, p. 300–381]), in which Stalin already explained his views on the National question, notably [p. 321-322]: “The right of self-determination means that a nation may arrange its life in the way it wishes. It has the right to arrange its life on the basis of autonomy. It has the right to enter into federal relations with other nations. It has the right to complete secession. Nations are sovereign, and all nations have equal rights. This, of course, does not mean that Social-Democracy will support every demand of a nation. A nation has the right even to return to the old order of things; but this does not mean that Social-Democracy will subscribe to such a decision if taken by some institution of a particular nation. The obligations of Social-Democracy, which defends the interests of the proletariat, and the rights of a nation, which consists of various classes, are two different things” – this was before the Bolshevik revolution in 1917.

⁹²⁷ Leon Trotsky was the most ardent defender of the idea of a continuous and spreading international revolution; he was eventually removed from power in 1927, expelled from the Communist Party then finally (in 1929) exiled from the Soviet Union (which led to Stalin’s full takeover – he was already, since 1922, the General Secretary of the Central Committee of the Communist Party – of the Soviet State). For a general review of the evolution of the Bolshevik Revolution and of the Soviet Union under Lenin, see the detailed [Carrère d’Encausse, 1979a] (and [Carrère d’Encausse, 1979b] for the U.S.S.R. under Stalin), notably Chapter II entitled “Birth of a State” for Lenin’s defense of the right for peoples for self-determination (and the Cultural policy he promoted), Chapter III (“Birth of a Nation”, notably [p. 119-124] on the limits of the self-determination process, including [p. 121] the initial secession in 1917 of Poland then Finland), and Chapter IV entitled “One step forward, two steps backwards” for the problems encountered in a second phase – see also the more easily accessible (and in English) Wikipedia articles [Anon. “Joseph Stalin”, 2016; Anon. “Leon Trotsky”, 2016; Anon. “Vladimir Lenin”, 2016].

⁹²⁸ And integration.

⁹²⁹ Conditioned however by the “Second phase”, the integration of these cultures in the “New Soviet People”.

⁹³⁰ Besides the development of “Classical” semi-tonal compositions, based on the local “Folklore”.

⁹³¹ *i.e.* excluding improvisation; note that, according to [Djumaev, 1993, p. 43], “[t]he main problem in [Soviet] culture policy was the relation of traditional music and the music of contemporary European-style composers. The State cultural leadership announced that the principal priority in the development of musical culture was to be the assimilation of so-called European professional music. In general, this priority was preserved right down to the beginning of the 1990s, when the Soviet Union collapsed”; note also [During, 2005b, p. 144]: “[In Central Asia], the most striking transformations have not come from the inside or from a straightforward process of acculturation, but from the outside under the pressure of colonial, socialist and nationalist ideologies. Beginning in the 19th century, Russian influence created music schools and introduced new instruments. During the early Soviet period there was a deliberate effort to academicize music that affected musical forms (resulting notably in a hybrid style called *akademik*), traditional instruments, methods of playing, the contexts and purposes of performances and methods of transmission. Censorship also served to alter the musical heritage”; finally, from [Vinogradov, 1960, p. 74] and noteworthy: “until recently, solo and unison performance was predominant in Central Asia. But now, the peoples of Central Asia

→

Let us note that Soviet Internal policy endured drastic changes under Stalin, from the rehabilitation of the Nation-State in the pre-Second World War period to the repression of (non-Russian)⁹³³ Nationalistic aspirations in the immediate Post-War period⁹³⁴, then a relative “liberalization” in the post-Stalinian period⁹³⁵.

In the 1920s and 1930s, and in parallel to “the creation of the key factors and mechanisms of culture policy”⁹³⁶, a wide activity of field collection of traditional songs was undertaken (including) in the

→ have their national operas, ballets, symphonic musics, composers. These new forms of professional art have been developed on the basis of folk music traditions, as a consequence of the natural advance of those traditions” (cf. with [Slobin, 1977, p. 11–12] for the Kirghiz, for instance, but also for other peoples of Soviet Central Asia).

⁹³² For this paragraph and a general view of Soviet Policy with minorities in the U.S.S.R. see [Kosacheva, 1990].

⁹³³ Russia becoming the “Big Brother” of other Nations of the U.S.S.R.

⁹³⁴ See [Carrère d’Encausse, 1979b, p. 77–85, 173–182].

⁹³⁵ Called “The Return to Utopia” by Hélène Carrère d’Encausse in [1980, p. 40–52]; all these changes justify various positions with regard to the status of the Soviet Power, “an Empire?” or a “Nation-State?” as in [Adams, 2005, p. 334]: “However, the Soviet Union was like other empires in the relationship between the culture of the center and that of the (Russian and non-Russian) periphery {citing here [Hirsch, 2000] and adding, in footnote 3: “did party workers from the center treat peripheral villages in Siberia with any more colonial disdain than peripheral villages in Kazakhstan? I am arguing that the dynamics of Soviet empire stem not from ethnic difference between the center and periphery but from the dominance of the culture of the center (Moscow and Leningrad) over all peripheral cultures” which is however debatable as the same question could be asked, with perhaps different answers to it, about the “immigrants” from the non-Russian periphery and their “Russian” counterparts; the author continues: “Thus we can characterize the Soviet Union as a new kind of state, one that exhibits both the cultural hierarchies of an empire and the modernization tendencies of a nation-state”; Adams is however sceptical about the losses induced by globalization: “Westernization and imperialism are issues that concern many scholars, and there are a variety of ways these questions have been addressed in the sociological literature in relation to the globalization of culture. Structuralist theorists who approach globalization from a critical perspective tend to see cultural globalization as a process of culture loss, as local values are wiped out by the homogenizing forces of consumerism (Sklair 1995; 1999; Wallerstein 1997). However, those who jump to the conclusion that the adoption of imported cultural forms is evidence of Americanization or Westernization have usually fallen into the trap of what Hannerz critically terms the ‘master scenario’ of homogenization” – [Adams, 2008, p. 615].

⁹³⁶ [Djumaev, 1993, p. 43].

periphery, part of which was published⁹³⁷; Commercial recordings of “ethnical” music eventually boomed, although they seem to have been limited to ethnical groups sufficiently numerous as to justify a pressing of a record⁹³⁸.

To justify their interest in *maqām* music, allegedly played at “feudal courts”, Soviet musicologists developed a subtle, albeit tautological argumentation as explained for the music of Uzbekistan:

“Belief in musical evolutionism from ‘folk’ to ‘professional’ draws ideological support both in its forward and retrograde direction; that is, at the same time that a highly evolved repertory such as the *Šašmaqam* can be legitimized by ‘proof’ of its origins in the ‘folk creativity’ of the Uzbeks, the very existence of ‘Uzbek’ folk creativity can be proven by the presence of its evolved product”⁹³⁹,

with the final aim of integrating the various nationalities of the U.S.S.R. still conducting the Soviet Cultural Policy, however contradictory this policy could be:

“just as Soviet aesthetics has eliminated purely ‘classical’ music from the Uzbek lexicon, Soviet Nationalities Policy has expunged any notions of pan-Islamicism, pan-Turkism, or even pan-Nationalism from its traditional music. For example, although Persian-speaking Tajiks share the *Šašmaqam* tradition equally with Uzbeks, having coexisted with and actually preceded Uzbeks as sedentary inhabitants of the cities of Transoxiana, Soviets have made a great effort to clone the repertory into two distinct variants: one for Tajiks, one for Uzbeks”⁹⁴⁰.

Note that Soviet ethnomusicology eventually tried to “solve” the problem of “Intonations” in Traditional (“Folk”) musics of the U.S.S.R.⁹⁴¹ which “cannot be transcribed”⁹⁴² while “intervals between the tones of the song[s] are not constant”⁹⁴³, an approach which seems to have had little effect on Mainstream

⁹³⁷ [Martynov, 1988, p. 307]; restrictions are documented in [Djumaev, 1993, p. 45]: “several investigations of traditional music and recordings in the 1930s and 1940s were not published for the reason that they contained uncleansed music or ideologically inimical genres, for example, religious music”.

⁹³⁸ [Gronow, 1975, p. 94]; more on “ethnic” music and its diffusion in the ex-U.S.S.R. in this reference.

⁹³⁹ [Levin, 1980, p. 151].

⁹⁴⁰ [Levin, 1980, p. 152] – parallels can be found with “The nationalization of Ottoman popular music in Greece” [Pennanen, 2004].

⁹⁴¹ [Martynov, 1988].

⁹⁴² [*id.* p. 10] – citing Asaf’ev.

⁹⁴³ [*ibid.*] – quoting Alekseev.

musicology as Jarustovsky's article on "Soviet Musicology"⁹⁴⁴ shows that, eventually, little attention was devoted to the in-depth musical characteristics of non-Russian ethnic groups⁹⁴⁵, and that this musicology concentrated on Classical semi-tonal music and its developments in the 20th century.

It was then this European-based musical culture, destructive for traditional music cultural models⁹⁴⁶, that the Soviet regime⁹⁴⁷, despite its propaganda⁹⁴⁸,

⁹⁴⁴ [1974].

⁹⁴⁵ Although Martynov [1988, p. 307] asserts the contrary: "In the USSR, music folklore studies have always held an important place".

⁹⁴⁶ The means being, in musicology, summarized by Belaiev thus: "The road to the third, our contemporary, period in the history of music was paved by long and persistent creative activity of the already civilized European nations in working out modern musical notation, high forms of polyphony and, later, harmony, and in establishing the tempered scale as a universal tonal system, replacing the Pythagorean system previously widely accepted" – [Belaiev, 1965, p. 22]; Djumaev puts it more directly (in the case of Uzbekistan): "the installation of the Soviet system, and subsequently that of the contemporary independent state of Uzbekistan, involved the demolition of the previous systems of cultural values ('heritage'), which became subject to destruction or radical critique, revision and adaptation" – [Djumaev, 2005, p. 166].

⁹⁴⁷ The Chinese (Maoist) model was seemingly mostly similar – the two ideologies being similarly based on Marxism – with traditional music being linked with anti-religious concerns as described in [Harris and Dawut, 2002, p. 113]: "The Chinese constitution enshrines the right to religious worship within the framework of the five acknowledged 'systematized religions' of Protestantism, Catholicism, Buddhism, Daoism and Islam. Hand-in-hand with this goes official intolerance of 'illegal religious activities' (*feifa zongjiao huodong*) and 'feudal superstition' (*fengjian mixin*), which are consistently linked in state propaganda to the 'backward' and 'uncivilized' and to social disorder. In practice, state intervention in ritual practices has ranged from the violent anti-superstition campaigns of the Cultural Revolution period, waged within the framework of class warfare, to more moderate strategies of propaganda and re-education"; in this, Western and Chinese policies seem to rejoin: "A few Uyghur scholars have recently dared to suggest that the banning of the *mazar* festivals fuels popular resentment against the authorities (cf. Roberts 1998) and have called for a redrawing of the line between 'illegal religious activities' and the 'folk Customs' of the Uyghurs. There is currently little space for debate of such issues in Xinjiang and, sadly, it appears increasingly likely in the international climate at the time of writing, following America's declaration of a 'global war against terrorism', that the space for such debate will become yet more limited".

⁹⁴⁸ "Similarly, a recent Soviet publication on Soviet relations with the Middle East and Africa stresses that Soviet cooperation with these countries in the sphere of culture and art is based 'on the one hand on the intensively dynamic process of the rejuvenation and continuing development of the ancient and original cultures

had to offer to Third and Fourth World countries"⁹⁴⁹, to say that no alternative was ever possible between the Soviet Hammer and the Western Anvil.

Consequences of Musicological Orientalism

The Orientalist intense stress on ditonism and the use of inappropriate analytical Hellenistic tools to analyze *maqām* music (and others?), parallel to the belittling of Zalzalism and its intonations, had a devastating impact on the way the "Orientals" understood and promoted their own musics.

While the first generation of reformers was still in close contact with Tradition⁹⁵⁰ and complemented its already Westernized theories (for some of them) with Oral teaching which was supposed to fill the gaps of these, new, written theories, the next generations gradually lost contact with the Old (Oral) tradition⁹⁵¹ and submitted to the occidentalizing craze.

With evermore students acquiring the "Science of Music"⁹⁵² in Western or (ex-)Soviet Universities⁹⁵³ and most of them returning to their home countries to teach their fellow countrymen and women the same Hellenistic tools, the same exaggerated justifications for the supremacy of the western tonal system, it was only natural that their admiration for occidental "Science" be transmitted to the next generations and widen up: after all, did they not get a diploma in this

→

of the Arab and African people and on the other hand on the conspicuous achievements of Soviet art which has received international acknowledgement as one of the most important sections of world culture" – [Dawisha, 1975, p. 423].

⁹⁴⁹ During's article [2005b] explores in detail the in-depth transformations of cultures of Inner Asia in the dual context of Western and Soviet influence, showing parallels with the change of alphabet in Turkey and the cyrillization of the alphabets in Central Asia, and emphasizing notably the losses and changes in the intonational systems of these countries.

⁹⁵⁰ If not growing up with it.

⁹⁵¹ This loss is explained for instance, for Central-Asian cultures, in [During, 2009]; for Indian music intonations and theoretical changes, see [Jairazbhoy, 2008]; for the problems concerning the implementation of Music notations (including Western staff notation) in Modern Turkey, see [Ergur and Doğrusöz, 2015].

⁹⁵² Better to call it in such case the "Justification of Ditonism".

⁹⁵³ The latter being generally (as I could conclude from personal contact with some of them) such in such a conformist fashion, intellectually, that it becomes difficult to discuss with them any music, even "Contemporary" Western music, except plain Classical ditonism (or perhaps, why not, chromatism).

science, did they not work hard to conform to their director's biased (but how would they know?) indications, did they not integrate all the external signs of this science, thesis writing, referencing, arguing, constructing a logical chain – even if based on unsound axioms or paradigms – etc., to sum up, all the markers of science with a capital S?

So should they refrain from using these tools, either to promote Occidentalization or to oppose it? Surely not! Wouldn't that also be the natural thing to do, use what you have proudly learned for a legitimate (allegedly) purpose? Yes, indeed!

And this is exactly what Autochthonous *maqām* musicologists did, and still do today, with various argumentations which exemplify different aspects of the same (generalized) phenomenon, namely Autochthonous (or Immigrant) Re-Orientalist Musicology (which, I believe, is present in all the cultures of *maqām* music today); these different approaches, most of them (as it seems to me) unconsciously used by these musicologists, spread from the straightforward integration of Western biases in the local teaching of Musicology (or Ethnomusicology, when the discipline exists as such), to the use of these same biased tools and stances⁹⁵⁴ to “prove” the “superiority” of *maqām* music, with an array of intermediate stances that I try to explain in the following pages.

MUSICOLOGICAL RE-ORIENTALISM⁹⁵⁵: A MULTIFACETED PHENOMENON

Besides the direct promotion of biased theories of the scale in their teaching⁹⁵⁶ and the unquestioned

(and overwhelmed) endorsement of the results and “findings” of Occidental “Musical Science” on *maqām* music⁹⁵⁷ as well as the denial of the bare existence of the Zalzalian *maqām*⁹⁵⁸, Autochthonous *maqām* musicology endures multiple, more or less structural disorders such as Nationalism and Intra-Orientalism⁹⁵⁹ or inversely Pan-Arabism and Pan-Islamism, Terminological abuse, Occidentalism, Belittling of (if not autism with regard to) Autochthonous musicological works from the Pre-Modern Era⁹⁶⁰ and, finally, *quasi*

→

“tolerance” principle, with [Chailley, 1985b] as a main reference. As for fr. Louis Hage, former president (1986-1992) of the Holy Spirit University of Kaslik (Lebanon; the university harbors the largest faculty of music in this country – and the only one with Doctoral studies – with Hage as founder of the original “Institute for Musicology” and as its director from 1970 to 1986): “With few exceptions, all scales follow two common musical laws: the [Acoustic] resonance table and the cycle of fifths” (in French “Exceptées quelques-unes, toutes les échelles obéissent à deux lois musicales communes: celle du tableau de la résonance et celle du cycle des quintes”) – [Hage, 2005, p. 10].

⁹⁵⁷ A typical attitude of most Autochthonous musicologists, especially with regard to Henry Farmer's writings.

⁹⁵⁸ A rare stance of complete Pro-Occidentalism.

⁹⁵⁹ [Makdisi, 2002a, p.795]: “Ottoman resistance to Western imperialism engendered its own interrelated forms of Orientalist representation and domination that existed simultaneously at the center and the periphery. [...] these forms were shaped not by a will to exclude but by a desire and determination to include subjects and empire in a hierarchy of modernity. Equally significant is that this double movement created the ideological space for Ottoman subjects to participate in this Orientalism as a project of national Ottoman resistance to Western colonialism. Unlike Western Orientalism, Ottoman Orientalism was as much a self-designation as it was a marker of difference from other, putatively less advanced, nations and races. It sought to unify Turks and Arabs within a rejuvenated East. At the same time, it differentiated them by overlaying temporal hierarchies with increasingly explicit ethnic and racial ones in which Ottoman became synonymous with Turk. To the extent that Arab elites were themselves involved in a similar dynamic with their own peripheries (whether constituted along ethnic, gender, or class lines), it becomes clear that the project of Ottoman modernization in an age of Western empire produced and anticipated multiple Orientalist discourses, many of which persisted long after the fall of the Ottoman Empire and with it the end of the specific line of Ottoman Orientalism” – this, as I call it, “Intra-Orientalism” is a prominent feature of today and yesterday Autochthonous Re-Orientalism in music, not only in Turkey of course.

⁹⁶⁰ For instance in 2007 at the “Congrès du Caire” in Dar al-Opera (Cairo), with Egyptian musicologist Fathi Khamisi reading a paper about “the 24-quarter-tones division of the octave of Shihāb-a-d-Dīn al-Hijāzi” and who, when asked how he could reduce the “28 *maqāmāt*” of Hijāzi (see the first part of [Beyhom, 2012]) to “24 quarter-tones”, did not even answer the question and continued elaborating on these virtual “*hijāzian* 24 quarter-tones”.

→

⁹⁵⁴ To understand as a “state of mind”.

⁹⁵⁵ Lisa Lau restricts [2009] the relation of the (composed) term “Re-Orientalism” to diasporic authors; in this dossier the main re-Orientalist schemes and procedures that are examined are produced by Autochthonous authors influenced by Orientalism.

⁹⁵⁶ As an example for this stance, the teachings of fr. Élie Keserwani {a Université de la Sorbonne Ph.D. graduate with a “Doctorat d'État” in Musicology “(nouveau régime)” in 1989 according to his biography at <http://musimedialogy.org/FRN/30/> – 2016-06-26 20:42:42, “founder and director” – till recently – of the department of Music and Musicology at the Université Notre-Dame (Louaizeh – Lebanon) and a “Professor [and] Research Director at the Université Paris IV Sorbonne” as well as a “Visiting Professor at the University of Yale; New Haven – USA”} is based, according to a conversation we had while participating both in the 2007 “Congrès du Caire”, on “the teachings of [Jacques] Chailley”, namely the “ditonic, tritonic, etc.” theory and the

generalized inconsistency⁹⁶¹ and double standard approaches, depending on whether they are Western- or “Oriental-” oriented⁹⁶², not forgetting the implementation of racial terminology in musicological thought⁹⁶³.

While these attitudes and positions may sometimes come together inextricably, some of these stances can however be clearly distinguished in modern and contemporary *maqām* musicological approaches⁹⁶⁴.

⁹⁶¹ A trait shared with the Occidental musicology of the *maqām* but, after all, isn't it normal that the students learn from their masters?

⁹⁶² A common procedure in 20th-century Autochthonous musicological literature, as for instance the difference in referencing, for the same author (Tunisian Muḥammad Šāliḥ al-Mahdī) between his booklet in French (and published in France) on Arabian music [Mahdī (al-), 1972] with one hundred pages – of which 11 pages of bibliography with almost 180 fully-informed (not in-text however) references (I counted 178, 124 for Arabic or translated texts and 54 for Western references), and the 244-pages (large format – in Arabic language) [Mahdī (al-), 1982] with 55 references with no mention of date (except for the unique Western reference – from Daniélou on Indian music), publisher or definite place, as if 1) Arabian readers needed no precise and informed references and, 2) as a proven “professor” Mahdī did not need anymore Academic legitimacy; and not to forget the impressive five volumes (*ca* 350 pages each) “encyclopedia” on Arabian music, the *A-s-Samā' ind-a-l-'Arab* of Syrian Majdī al-'Aqīlī (no date, no place – probably Damascus), with no references whatsoever or Al-Lāh-Wirdī's extensive theoretical book [Al-Lāh-Wirdī, 1950] – also without references.

⁹⁶³ For instance the opening speech of the (then) Rector of the Antonine University (Lebanon), fr. Antoine Rajeh, in June 19 2006 for the International Conference (in collaboration with the Université de la Sorbonne) “Traditions musicales au Carrefour du systématique et de l'historique : prolégomènes à une musicologie générale des traditions”, in which (see the university-founded musicological review *RTMMAM No. 1*, p. 250) he compared the “battling Greek and Semite”, while “the Greek is an explorer” and “the Semite is a pilgrim” – I wonder how the “Semitic Phoenicians” can be fitted in this exclusive two-fold classification; see also below the more significant “Semitic cycle of fifths” of Mahmoud Guettat (Founding director – now retired – of the first Tunisian Institute of musicology in Tunis), among numerous other examples I encountered in Arabian musical and musicological literature.

⁹⁶⁴ Most of the examples proposed in this section come from Lebanon, for two main reasons: firstly, I happen to have a good knowledge of the musicological environment in this country (having taught there and still pursuing my research herein) and, secondly, because Lebanon is the most Westernized, not only Arabian (although this belonging begins to be politically disputed) state, but also among all states of the *maqām* realm (except evidently Greece, although this could also be disputed); moreover, and as Westernization is (much) more accented in the Christian confessions (mainly the Maronites, who run so far all the

* *
* *

One of the most revealing (and “legitimizing”) procedures used in re-orientalist musicology is the abuse of Western terminology used to rule out Zalzalism, namely the word “Natural”, but also (as a secondary manifestation of the phenomenon) the “Good Temperament”.

The adjective “Natural” almost has any possible use in this musicology (and in Byzantine Autochthonous musicology of course)⁹⁶⁵, such as the “Natural Modes” (white keys of the piano in succession, and its counterpart the “Artificial Modes”⁹⁶⁶), the “Natural Intervals” (mainly Pythagorean, exceptionally from the

→ musicological institutes and faculties) in this country, a consistent part of the below and above cited “Lebanese” examples involve musicologists from these confessions. On a more personal note: private Christian schools operated by religious brotherhoods such as the Jesuits or the De La Salle Brothers are (still) considered in Lebanon as providing the best teaching in the country; in my experience (I was a student in a school operated by the De La Salle Brothers from my school beginnings), most of this teaching is the continuation of Colonialist ideology, with a stress on religious teaching and Western “values”, including Western supremacy and denigration of local culture. As a result, and during a tour of Great-Britain and Scotland organized by my school (I was 13 years old at the time), we were gathered in the pub of a hotel of a small Scottish town with local folks which started to sing Scottish folk songs and ballads. Whenever asked to sing *our* folk songs or tunes, no single member of the (Lebanese) group of students (including myself) knew a Lebanese folk tune, which was very strange to the local folks who asked us if we were not proud of our home country; this question arose discomfort in our group, while some of the boys (schools operated by Christian brotherhoods segregated boys from girls) in the group tried to sing French lullabies such as “Frère Jacques” and present them as “Lebanese folk songs” – which, in my opinion, shows the degree of deculturation of certain segments of Lebanese society which still evolve in a vacuum.

⁹⁶⁵ As one supplementary example [Savas, 1965, p. 39]: “[The Byzantine scale] is called the natural scale or diatonic, for it is comprised of natural notes which each represent a note”. This phenomenon seems to be amplified in Religious (Christian) Musicological (mainly theological) circles, probably influenced by previous pseudo-musicological, Christian-oriented (but not always explicitly) literature of the 19th-20th centuries and combining sometimes “Nature” with “Divine” arguments (see next footnotes, and the quote from fr. Louis Hage in footnote 968).

⁹⁶⁶ For instance in [Hage, 2005, p. 12], but also in [Angelopoulos, 2005, p. 76–77] in which “Natural” is mentioned twice, for the scales and for their intervals, while the “Well-tempered piano” is to be understood as “equal-tempered”, and all “Byzantine intervals” as “Just”.

Harmonic Progression⁹⁶⁷) and the “Natural [if not ‘Divine’] Laws (of Nature)”⁹⁶⁸.

As for the “Good Temperament”⁹⁶⁹ (of Johann Sebastian Bach of course), it seems that time in the Orient elapses (effectively) differently, and slower than in the West⁹⁷⁰, as (most) local musicologists still think

⁹⁶⁷ As alleged for the intervals of Arabian music by fr. Youssef Tannous, present dean of the Faculty of Music of the Holy Spirit University of Kaslik (Lebanon) – and former student of fr. Louis Hage mentioned above, at the conference “The Role of Musical Heritage in the Rise of Arabic Music and its Development”, July 12-14 2012.

⁹⁶⁸ The same fr. Louis Hage quoted in footnote 956 states [Hage, 2005, p. 10]: “The Tonal system is the best explored musical system (many centuries of preparation to arrive at Bach, the climax). The reason is that tonality implements and ‘systematizes’ the Laws of Resonance inscribed in Nature by the Creator Himself” {in French “le système tonal est celui qui fut le plus et le mieux exploité (plusieurs siècles de préparation pour arriver à Bach, le point culminant). La raison en est que la tonalité met en oeuvre et ‘systématise’ les lois de la résonance inscrites dans la nature par le créateur lui-même”}.

⁹⁶⁹ Mostly in the adjectival form “well-tempered”.

⁹⁷⁰ There are three main reasons for this phenomenon, none of which is “racial”, “religious” or “ethnic”:

- Autochthonous musicologists trained in Occidental musicology tend to rely on their university references, as the access to up-to-date references is costly; they favor eventually cheaper or even gratuitous references, *i.e.* mainly outdated.
- This phenomenon has been amplified by the worldwide scanning and archiving process which, while giving access to references previously only obtainable from specialized (mostly Occidental) libraries, inevitably fosters provisioning older, not copyrighted references.
- The third reason is the lack of support for research: when musicology is considered as nothing but a luxury in the *maqām* states, accessing key positions in faculties or institutes of music and musicology for a Ph.D. graduate becomes the ultimate goal, while funding for research is nearly void (to the notable exception of Tunisia); it is no wonder then that research would be later undertaken only of necessity, not as a longing for scientific (or self) development.

The last reason is becoming, alas, a worldwide weakness as the quality of research becomes (?) weighed only through the numbers of publications, and not by the intrinsic (in-depth) value of the research, an attitude which seems to have contaminated (or given a convenient excuse to) local decision makers: for instance, as I was trying to promote research to the rector of a Lebanese university (with a faculty of musicology), insisting on the means (access to worldwide archives, material support, equipment, etc.) which seemed to me indispensable to achieve such a goal, the answer I received was that the “only valid scientific activity was the publishing of articles in a review”, not exploring further trails, not innovating, just publishing (articles only: books are too difficult to promote amongst peers), regardless of the contents; no

(and write) that the “Good Temperament” is the equal-tempered ditonic (exceptionally chromatic) scale⁹⁷¹.

While the latter (ab)uses duplicate more or less known Occidental biases⁹⁷², other processes, such as the above reviewed implementation(s) and promotion of the Pythagorean restricted⁹⁷³, if not the semi-tonal scales⁹⁷⁴ in *maqām* theory, were the main means for promoting a “superiority”⁹⁷⁵ of this music over the

→ wonder then that research in these countries remains mostly conventional and superficial, if not inexistent.

⁹⁷¹ See footnote 966 for Angelopoulos; this *cliché* is so well inscribed in Autochthonous musicological thought that, as I argued – at the 2007 “Congrès du Caire” at the Dar al-Opera in Cairo – with fr. Youssef Tannous (see footnote 967) that he should at least read the article “Temperaments” [Lindley, 2001b] in the *New Grove* (not to say the articles “Equal-Temperament” and “Well-Tempered Clavier” [Lindley, 2001a; 2001d]), the only answer I received, on this occasion and on the following (for instance in July 2012) was a wry smile.

⁹⁷² Such as the example of the teaching of Arabian music theory in the Lebanese conservatory provided in footnote 376, p. 101.

⁹⁷³ And “extended” to a complex Pythagorean/semi-tonal and (implicitly) quarter-tonal representation in the Yekta-Ezgi-Arel theory; this theory (based on Yekta’s article [Yekta, 1922] in the *Encyclopédie et dictionnaire du Conservatoire* cited in Chapter II) was notably expounded by Ahmed Saygun in his “La musique turque” [Saygun, 2001] – first published 1960.

⁹⁷⁴ Adopted as the basis of the quarter-tone division of the octave since (at least) [Khulā‘ī (al-), 1904].

⁹⁷⁵ Examples are numerous, of which I may cite 1) Wadia Sabra (Wadī‘ Šabrā’s) *La musique arabe base de l’art occidental (Arabian music as the basis of Occidental Art)* – [Sabra, 1941] in which he replays the “ditonic” origin of Arabian music basing himself on the Harmonic suite, notably in its pseudo-Zarlinian formulation); 2) Mikhaïl al-Lāh-Wirdī’s *Falsafat al-Mūsīqa a-sh-Sharqīyya (the Philosophy of Oriental music)* with an apology of the “Pythagorean-Arabian” scale [Al-Lāh-Wirdī, 1950, p. 109–113] resulting [Al-Lāh-Wirdī, 1950, p. 137] with the restricted Pythagoro-ditonic scale as the basis of Arabian music (a proposition he later enriched – in [Al-Lāh-Wirdī and Šabrā, 1964, p. 6] – to integrate Šabrā’s views); 3) much more common (and easier to understand for most “Autochthonous” theoreticians of the *maqām*), the argumentation that “while Occidental music has harmony, Arabian music has the quarter-tone which makes it superior”, a statement I have heard on numerous occasions from different actors of the musical or musicological scene. See also Barkechli’s “Musique Iranienne” [Barkechli, 2001] in which all Iranian music intervals are “measured” Pythagorean (ditonic) as they have “remained” [Barkechli, 2001, p. 455–456] “since Fārābī” while “all witnesses of this time knew no other principle” as ditonism, and, most notably, in which the author “measures” the intervals of “an authentic Iranian lullaby” that he notates [p. 474] with ditonic intervals, performed “thrice by five different singers” with a scale [p. 478] which has, to the utmost, “a discrepancy of 1 cent” with the Pythagorean ditonic scale, with the overall conclusion [p. 486]

“Global”⁹⁷⁶ one, or supporting a Pan-Arabian, sometimes Pan-Islamic reading of “Arabian-Islamic” music theory and history⁹⁷⁷.

Moreover, the same tools are used in the support of exclusive nationalism(s)⁹⁷⁸, notably as a result of the

→ that the “Orientals” should use the 12 semitones per octave as their native scale.

⁹⁷⁶ Occidental, Tonal.

⁹⁷⁷ Most of Mahmoud Guettat’s writings, of whom I review one seminal article in the following pages, actively promote such a re-reading – see for instance his [Guettat, 2000, p. 11], notably: “[The diversity of this music reveals two essential characteristics: - a supranational unity cristallized across the centuries through a common base which is at the same time spiritual (islam) and linguistic (Arabic); it is transmitted by Classical Music, - local specificities determined by Ethnical, Cultural and Social statuses [...]”, a position which is in line with that of the Arab League (“The League of Arab States”) and its emanation the Arab Academy of Music (“Arab Consortium for Music”) which publishes the review (in Arabic) in which Guettat explains the “Arabian scales” that I comment below.

⁹⁷⁸ For instance Barkechli’s thesis in *L’art sassanide, base de la musique arabe (Sassanid Art as the basis of Arabian music – [Barkechli, 1947])* which he explains in [Barkechli, 2001, p. 453] thus: “Our first acquaintances with Persian music date back to the Sassanids (500 A.D.), a music we can consider as the basis of Iranian music after the Muslim conquest as well as the basis of the musics of the Muslim world” {in French “Nos premières connaissances portent sur la musique persane au temps des Sassanides (500 ap. J.-C.), que l’on peut considérer comme la base de ce que devait être la musique iranienne après la conquête musulmane, ainsi que la base des musiques du monde musulman”}. While Persian influence on the Arabs is undeniable (see notably the Wikipedia article [Anon. “Sasanian Empire”, 2016] which seems to concur with this pro-Sassanid influence thesis, notably: “The Sasanians’ cultural influence extended far beyond the empire’s territorial borders, reaching as far as Western Europe, Africa, China and India. It played a prominent role in the formation of both European and Asian medieval art. Much of what later became known as Islamic culture in art, architecture, music and other subject matter was transferred from the Sasanians throughout the Muslim world”), this is however a slightly exaggerated claim as crediting Sassanid music to be the “base of Arabian music” would be as excessive as would be a thesis stating that Byzantine music is the “basis” of Ottoman music, the parallel between the two historical periods and empires being obvious as the Byzantine Greeks played a similar role in the Ottoman Empire as the Persians in the Arabian Caliphate (see notably – [Bosworth, 1963, p. 97–98] for the latter, and [Arnakis, 1952; Kitsikis, 1985; Catsiapis, Kitsikis, and Svoronos, 2012] for the former); cultural influence is unavoidable in such cases – in both directions, and the resulting culture must be considered as a synthesis of all cultures in each empire (see for instance [Blachère, 1956] for the “Arabian-Islamic” culture), Arabian or Ottoman, both peoples having conquered previous, more educated and with a higher civilization, empire(s) with a pool of (much needed) experts for the conquerors. Other examples of nationalism are the

importation of Occidental nationalism in the Ottoman Empire⁹⁷⁹, while claims for the “Original *maqām*” harmony punctuate the musicological literature⁹⁸⁰ and when even the basics of “Intermediate-Modern” theories of the scale⁹⁸¹, such as Erlanger’s and al-Ḥilū’s, are gradually forgotten⁹⁸².

Meanwhile, the race for an over-description of *maqām* music becomes aggravated whenever smaller divisions of the octave continue to be proposed as The Grail for Oriental theories of the scale⁹⁸³, and whereas

→ multifarious appropriation of Fārābī, (ibn) Sinā and Urmawī by Arabs, Turks and Iranians, or various polemics about the origins of the ‘ūd, “the Sultan of instruments” (as described in [Sabra, 1941, p. 16]), with Rāshīd Ṣubḥī Anwar (an assyriologist) and Maḥmūd Aḥmad al-Ḥifnī (a musicologist) fighting over the supremacy [Rashīd, 1999, p. 38–40] of Iraq and [الحفني and Ḥifnī (al-), 1987, p. 73, 228] Egypt, but both (the assyriologist and the musicologist) overlooking the fact that the ‘ūd(s) of which they provide pictures are, in reality, *tunbūr*(s)...

⁹⁷⁹ As seen above: for Turkish “National Music” policy, see also [Woodard, 2007] and [Tansuğ, 2007].

⁹⁸⁰ See for instance [Barkechli, 2001, p. 457–458] who promotes the thesis of an original “Persian Ditonic Harmony” having been repressed by Islam, or Shawqī’s defense of Farmer’s theses in [Shawqī and 1976, شوقي, p. 9–40] (with regard to “Arabian Harmony” and influence).

⁹⁸¹ Formed before and after the 1932 Congrès du Caire and which still include *maqām* characteristics (besides the scale) such as the *ṣayr* (melodic evolution) and sometimes the formulae, while finger positioning and intervals specific to the *maqām*, localized modulations or one note modulations à la Alleppine (*Qudūd*) are still of the domain, uniquely, of the oral (mainly discontinued) tradition, whereas the performer’s touch remains the result of a personal research, and while the repertoire is today taught in written form, *i.e.* dead.

⁹⁸² A young Arabian musicologist (still a student, and who may still reconnect with tradition I hope) recently proposed an article addressing Ziad Raḥbānī’s (hybrid) music, commenting (and analyzing “Western style”) the “chromatism” in the latter changing melodic lines, totally overlooking the use of the *ḥijāz genre* in this music as a standard variational (modulating) process in Near Eastern *maqām* music; I fear this total disconnection from (late) traditional means of analysis will soon be the rule as shows this “anecdote” from one Lebanese musicologist who recently informed me that one of her students (and future school teacher) at the Faculty of Pedagogy of the Lebanese University (during a course on music pedagogy) stated she would not listen to the instrument *daff* (following a proposition by another student) because “the only instruments she could listen to were the piano and the guitar” – an extreme case of deculturation (and acculturation) which confirms my own observations when I taught at the same faculty a decade ago.

⁹⁸³ Notably in Turkish music where the 53-commas (Holderian) system becomes insufficiently descriptive (“precise”) as discussed for instance in [Bozkurt et al., 2009], and as proposed in [Yarman, 2008].

Early divisions of the fingerboard from the Golden Age are re-written to emphasize Arabian music theoretical complexity⁹⁸⁴.

* *

Whenever the 20th century was for Autochthonous musicologists of the *maqām* the time for the re-appropriation of Occidental musicology, the 21st century seems to be the time when re-Orientalist assimilation of this “science” came to its utmost with students outbidding their masters, notably in Maḥmūd Guettat’s article⁹⁸⁵ “Theories of the formation of Musical scales and [of] the Arabian Musical system”.

* *

While contending at some point⁹⁸⁶ that Mikhā’il Mashāqa “established” the theoretical use of equal-quarter-tones in Arabian music, Guettat begins explaining:

“Musical scales follow a very ancient principle (although attributed to Pythagoras – 6th century B.C.). And [this principle is] known in many Ancient civilizations where it was in use before being theorized and its ratios defined. And [this principle] follows from the series of Just ascending fifths

⁹⁸⁴ For instance the extension by Shireen Maalouf (see [Maalouf, 2002, p. 126] – reproduced in this dossier as FHT 30, p. 195) and Nidaa Abou Mrad (dean of the Faculty of Music at the Antonine University – Lebanon; see [Abou Mrad, 2005, p. 773–774]) of Fārābī’s 17-intervals scale as demonstrated on the fingerboard of the *ūd* (see [Beyhom, 2010c, v. 1, p. 273] and explanations preceding Figure 75 in the same reference – translated and adapted figure reproduced in this dossier as FHT 17, p. 188) to 22 intervals (to include the corresponding octaves on the fingerboard); both authors endorse the “fretting” thesis on one side (Abou Mrad [p. 771] states: “frets which are associated to the left-hand fingers are positioned on the fingerboard of the *ūd* until the end of the Middle Ages”) and completely overlook the problems for effective praxis brought up by such a “fretting” (see FHT 31 and FHT 32, p. 196), i.e. impracticability of performance for some zones on the fingerboard (“frets” are sometimes conjunct in this configuration, with either no space to place the fingers between them, or with even overlapping – i.e. impossible to place – “frets”); more on this subject in [Beyhom, 2010c, v. 1, p. 366–369].

⁹⁸⁵ In Arabic.

⁹⁸⁶ [Guettat, 2002, p. 42]:

[...] “أ/عند البعض، متساوية أي بحساب الأرباع المعتدلة (أسوة بالأنصاف المتساوية للنظام التونالي المعدل الذي فرضه بأوروبا من تطوّر الآلات الثابتة والكتابة التوافقية). وهذا التوجّه أقرّه مشاقه وواصله أغلب الموسيقيين المنظرين خاصة في مصر”.

(descending fourths) while it is naturally bound with the series of harmonics in its progression⁹⁸⁷.

The author then expounds⁹⁸⁸ Chailley’s “ditonic”, “tritonic” etc. theory⁹⁸⁹ and explains that notes add up gradually to form the scale, while other notes are “mobile [not structural] with unidentified ratios⁹⁹⁰ whereas:

“Essentially, musicologists concur that the melodic line is best expressed by the system based on the cycle of fifths, in particular for instruments tuned in fifths (the violin, the alto, the cello) or in fourths (the *ūd*, the *tunbūr*, the double-bass); it is even impossible for performers on these instruments to circumnavigate [“get out of”] the scale of this system... that physicists consider as the best melodic system ever [...]”⁹⁹¹.

Guettat proceeds then⁹⁹² to the description of the “three schools” of Early Arabian Music⁹⁹³, and concludes about the first, “*ūd*ist(s) school”:

⁹⁸⁷ [Guettat, 2002, p. 10]:

“وتكوين السلالم الموسيقية يعتمد أساسا على مبدأ ضارب في القديم (رغم نسبه إلى فيثاغورس/ القرن السادس ق.م). وهو معروف لدى عديد الحضارات القديمة حيث كان متداولاً قبل تنظيره وتحديد نسبه. وهو مستخرج من تسلسل تألف الخامسة الصاعدة (الرابعات النازلة) ويرتبط طبيعياً بمجموعة الأصوات التوافقية وتعاقيها التدريجي”.

⁹⁸⁸ [Guettat, 2002, p. 16–17].

⁹⁸⁹ And expands it further till “dodecaphonic” – semi-tonal chromatic.

⁹⁹⁰ [Guettat, 2002, p. 18]:

“يتم دمج تدريجياً، ثم بصفة نهائية إلى اللغة الموسيقية المستعملة من قبل النظام الجديد. وقد أطلق على الأصوات الإضافية في حالتها الأولى الطارئة، المصطلح الصيني المعروف ‘بيان’ (أي درجة انتقالية) وهي معروفة بكونها نادرة الاستعمال إذا ما قارناها بالدرجات المكونة للسلّم. - يقتصر دورها عادة على التزيين. - تكون متغيرة وغير ثابتة أي يمكن حذفها وإبدالها بالدرجات الأساسية عند إعادة الجملة اللحنية. - لها نسب غير ثابتة [...]”.

⁹⁹¹ [Guettat, 2002, p. 21]:

“وصفوة القول إن علماء الموسيقى مجمعون على أن السير اللحني أحسن ما يعبر عليه بالنظام القائم على مبدأ دائرة الخامسة خاصة بالنسبة إلى الآلات الوترية التي تسوّى أوتارها إمّا بالخامسات (مثل الكمنجة) والآلنو والشللو) أو بالرابعات (مثل العود والطنبور والكنترباس) بل ويستحيل على عازفي هذه الآلات الخروج على سلّم هذا النظام... والذي يعتبره الفيزيائيون أحسن سلّم مقامي على الإطلاق [...]”.

⁹⁹² [Guettat, 2002, p. 29 sq.].

⁹⁹³ Guettat expounds this thesis already in his first book [Guettat, 1980] and pursues it in [Guettat, 2000, p. 61–63], dividing the pre-Systematist period between the (first) “*ūd*ist(s) school” (Kindī, Munajjim, etc.) and the (second) “*tunbūr*ist(s) school” (from Fārābī till – not included – Šafīyy-a-d-Dīn al-Urmawī), the third component being the “Systematists’ school”; the “*tunbūr*ist(s) school” is supposed to have imported the “Persian subtleties” into the “Sober old Arabian style”. The weakness of this thesis had already been underlined in [Chabrier, 1981b, p. 238], for the simple reason that Guettat established it from one single,

“The scale of the Early Arabs [the *ūd*ist(s)] is a natural scale (known as Pythagorean, but its origin goes back, as said above, to an Ancient Semitic origin) which follows the cycle of fifths and leads to a practical division comprising tones and two types of semi-tones”⁹⁹⁴.

Whereas Guettat includes no precise references in this article for his various affirmations⁹⁹⁵, the only indication I could find for his “Semitic origin” of the cycle of fifths was, besides the unreferenced claim in the first quote above⁹⁹⁶, an equally unreferenced explanation about the Chinese *lǚ*(s) in which he specifies that,

“according to a document from the 3rd century B.C. [...] only the first five *lǚ*(s) [...] from the cycle of fifths, beginning with a specific fundamental sound, [are used for the Chinese scale]”⁹⁹⁷.

relatively brief (in 22 pages [Erlanger, 1930, p. 218–242] of which 8 devoted to the comparison with the previously reviewed – in 52 pages [Erlanger, 1930, p. 163–215] – *ūd*) description of the *tunbūr al-baghdādī* by Fārābī {and from a further one-page description of the division of the strings of the *tunbūr baghdādī* by (al-) Hāsān ibn (al-) Kātīb (see [Kātīb (al-), 1975, p. 54]) versus a preceding six-pages description of the same procedure on the *ūd* [Kātīb (al-), 1975, p. 48–53]}, while all other theoreticians of the claimed “*tunbūr*ists(s) school” mention exclusively the *ūd* as the main instrument for both theory and praxis. Note that Fārābī concludes his explanations on the scale of the *tunbūr baghdādī* by dismissing the instrument (in the form it was fretted at his time) as “incomplete” for both theory and praxis; note also that, to sustain his claim, Guettat uses in the same article [Guettat, 2002, p. 24] the expression “Fārābī, in his elaborate description of the *tunbūr baghdādī* [...]”, thus implicitly defending his brainchild.

⁹⁹⁴ [Guettat, 2002, p. 30]:

“ويتضح لنا من دراسة الأبعاد ومواضع عفق الأصابع على آلة العود وغيرها من الشروح التي نجدها في رسالة ابن المنجم وبصورة أوفر في رسائل الكندي، على أن الأوتار الأربعة كانت تعدل اعتماداً على الرباعية الكاملة (الذي بالربع) وأن السلم الموسيقي المتداول أو القياسي يعايرة أدق – لدى العوديين هو سلم طبيعي (يعرف بالفيناغوري غير أنه كما أسلفنا، يعود إلى أصل سامي قديم) يستخرج من تألف الخامسات ويؤول عملياً إلى تجزئة تتألف من أبعاد طنينية ونوعين من الأبعاد الصغيرة [...]”.

⁹⁹⁵ Although he provides an impressive (6 pages out of 51) list of mixed (Arabic and Western) “chosen” references at the end of his article.

⁹⁹⁶ “[This principle is] known in many Ancient civilizations in which it was in use before it was theorized and its ratios defined”.

⁹⁹⁷ [Guettat, 2002, p. 15]:

“وحسب وثيقة تعود إلى القرن الثالث ق.م، قد وجد لدى الصينيين الذين كانوا يعرفون السلم اللوني بأصناف أبعاده الاثني عشر وقد أثبتوا درجات ارتفاعها باستنباط اثني عشر أنبوباً من قصب الغاب [ليو] متفاوتة الطول ومتباعدة في تسلسلها تعاقب الخامسات مع جمع الاثني عشر درجة المتحصّل عليها داخل ديوان واحد. ومع ذلك فإنهم كانوا لا يستعملون رسمياً سوى خمسة منها (حيث أنّ كل أنبوب يمكن اعتماده كدرجة انطلاق مما

Which leaves us with one of two choices: either take Guettat’s word for this “Semitic origin” of the “cycle of fifths”, or attribute it to the “Semitic” Chinese, a remnant of the Occidental Colonialist (and pre-Colonialist) Period⁹⁹⁸.



Fig. 86 “This stylised T and O map⁹⁹⁹, from the first printed version of Isidore of Seville’s *Etymologiae*, identifies the three known continents as populated by descendants of Sem (Shem), Iafeth (Japheth) and Cham (Ham)”¹⁰⁰⁰.

يشكل اثنتي عشر سلماً خماسياً أي ستين درجة). وهي الأصوات الخمسة الأولى الناتجة عن دائرة الخامسات انطلاقاً من صوت أساسي معين”.

⁹⁹⁸ See Fig. 86: the Chinese people(s) have been assimilated, in some racial theories of the 19th century, to “Semites”, notably in [Viator, 1887] (according to [Anon. “Race humaine”, 2016], and probably based on Gobineau’s three-fold distribution – see “Concept of a ‘Semitic race’” in [Anon. “Racial antisemitism”, 2016]): “There are three distinct Human races: the Black race (descendants from Sham) has populated Afrika, where it still vegetates; the Yellow race (descendants of Sem) expanded in eastern Asia with the Chinese, its largest element, being people with positive thinking, enjoying useful Arts, but little concerned with idealism, and having reached a relative (state of) civilization which has remained intangible for a long time now; the White race, which is the most important for us, has dominated, and dominates still, the world” (in French “On distingue trois races humaines : la race noire (descendants de Cham) peupla l’Afrique, où elle végète encore ; la race jaune (descendants de Sem) se développa dans l’Asie orientale, et les Chinois, ses plus nombreux représentants, gens d’esprit positif, adonnés aux arts utiles, mais peu soucieux d’idéal, ont atteint une civilisation relative où ils se sont depuis longtemps immobilisés ; la race blanche qu’il nous importe spécialement de connaître, a dominé et domine encore le monde”).

⁹⁹⁹ See [Anon. “T and O map”, 2016].

¹⁰⁰⁰ Legend taken from [Anon. “Semitic people”, 2016], map from [Anon. “File:T and O map Guntherus Ziner 1472.jpg”].

AFTERWORD TO MUSICOLOGICAL ORIENTALISM

As a sequel of combined Occidental¹⁰⁰¹ and (later) Soviet Orientalism, *maqām* music gradually lost most of its Zalzalian characteristics with the trend still pointing towards the complete eradication of these characteristics.

The specialized discipline used for this purpose, called the “Science of Music”, succeeded in imposing the predominance of the Hellenistic-inspired ditonic model both at home and in the countries ruled or dominated by Occidental nations¹⁰⁰², mostly in the *maqām* region where the supremacy of ditonism could be threatened, stripping thus these countries from their (full) Hellenistic legacy.

One of the most significant consequences of this process, which lasted over two centuries, remains however its impact on Autochthonous thought: it seems to me appropriate at this point to come full circle and note that whereas Europe created, in the Colonial and post-Colonial periods, the Greco-Latin Negroes¹⁰⁰³, Occidental musicology – a subfield of Generalized Orientalism – succeeded almost single-handedly in creating a new subcultural species, the Greco-Latin Arabs¹⁰⁰⁴ which, although being the likes of the Greco-Latin Negroes had, at their beginnings, the great opportunity and incidental privilege to be heirs to the Ancient Greeks but squandered this golden possibility to the lure of Asian threnody and futility.

Meanwhile, peoples from the Orient lost most of their bearings, while still longing for their “Orientality”: a hopeless situation?

*
* *

6. CONCLUSIONS

*“Fétis asserted that ‘primitive’ (non-Western) societies were limited to simpler scales because of their simpler brain structures, while the more complex psychological organizations of Indo-Europeans permitted them to realize, over historical time, the full musical potential of tonalité; his theories were similar in their biological determinism to the racial theories of Gobineau. His inquiries into non-Western music advanced the academic agenda of Orientalism, an ambitious international attempt to research the languages, social organizations, sciences and arts of non-Western societies, those under European rule in particular. In its most common forms, this research was used to bolster vast and often irrational generalizations about race, intelligence, emotional temperament, social organization and various forms of cultural expression. A strong motive behind these generalizations was the tacit fear that various African and Eastern cultural practices constituted a threat to European notions of social self-identification: in contrast to the modern West, the Orient appeared to European writers as a primitive or even animalistic realm of sexual desire, religious violence and racial terror. In general, these writers organized knowledge about the East into cross-cultural comparisons that served to denigrate non-Western others and thus associated the Oriental with marginalized elements in their own societies – the ignorant, backward, degenerate, insane and the feminine. [...] Fétis’ contribution to Orientalism was to associate pitch repertoires with racial characteristics. His accounts of non-Western music, which he collected in the *Histoire générale de la musique* (1869–76), thus conceal emotive assertions within the neutral language of factual description. Because of its dearth in appellative semitones, Fétis contended (in the *Traité complet*) that the pentatonic music of ‘la race jaune ou mongolique’ – the music of the Chinese, Japanese, Koreans, Manchus and Mongols – was ‘grave and monotonous’. Arab, Persian and Indian music, in contrast, was ‘langoureuse et sensuelle’, befitting ‘the manners and mores [mœurs] of the nations that conceived it’. Fétis believed that the dangerous excess of microtonal inflections in the pitch repertoires of the Levant was consistent with the expressive content of their music, which consisted of nothing but ‘amorous songs and lascivious dances”*
[Brian Hyer, “Tonality”, *New Grove*]¹⁰⁰⁵

¹⁰⁰¹ The Russian Empire included.

¹⁰⁰² Or under their influence.

¹⁰⁰³ According to Sartre.

¹⁰⁰⁴ And Turks and Iranians, by osmosis and transitivity.

¹⁰⁰⁵ [Hyer, 2001].

Preliminary synthesis

Science is the field of knowledge concerned with observing, verifying and repeating observable facts, events or abstract formulations supposed to apply to real world manifestations at some point.

Western musicology, a disciplinary field studying originally Occidental “classical” music, has eventually succeeded in observing, notably with the help of the (ditonically tuned) piano, almost all music phenomena in the world. It has also succeeded in repeating those events, notably with the help of the (ditonically tuned) piano, at will.

However, while endogenously verifying these observations and whereas repeating these processes, Musicological “science” has mostly failed in the verification process because its main axioms would not allow for such verification.

*
* *

The main axioms of Occidental music of the common-practice period¹⁰⁰⁶, *i.e.* of Occidental musicology of the 18th and 19th centuries, are the superiority of the ditonic composition of the octavial scale over any other scalar formulation of music, combined with a preference for the so-called “major” scale and coupled, for its classical period, with the predominance of (the first,) the fifth and third degrees of this scale eventually used in a particular type of polyphony called “harmony”.

Concurrently, this music evolved from an early stage of melodic uncertainty towards a rigid model based on quantified relations between pitches, whereas different theories tried to justify the choices, for the most of them arbitrary, this model reflected and the music which they eventually shaped.

The first theoretical justification to be used was inherited from Ancient Greek civilization which, in some formulations, considered music as a science and defined its components using simplified mathematics: the resulting internal composition of the scale was called “diatonism”, while the ditonic content of the interval of the fourth came rapidly to be the only

legitimate construction of this interval, and of the whole, exclusively octavial scale.

With time, and with the need for transpositions¹⁰⁰⁷, another theory arose which helped organize all transpositional scales in a coherent ensemble.

Europe witnessed however, in the period preceding the 18th-19th centuries, an extraordinary development of the sciences which made it possible to apply new, more sophisticated mathematics to the basis of music, which is sound. With the Acoustic Resonance Theory acquiring slowly all the characteristics composing it today, music theoreticians in Europe had at some point to face a dilemma: while the justification of their music was based on so-called “science” – and mathematics –, the new “scientific” theory shattered this basis and excluded *de facto* its product from “science”. There was no other choice before these theoreticians, however, as to incorporate this new theory in the body of various justifications of ditonism built for more than a millennium, and to find alternate explanations to the discrepancies between theory (here the Acoustical Resonance Theory) and praxis, *i.e.* ditonism.

At this point, the original arbitrariness of European axioms, the statement that “music is a science”, grew to the extent of reaching a climax, while justifications of music¹⁰⁰⁸ (of ditonism) became themselves additional arbitrary inclusions, and whereas the particular¹⁰⁰⁹ came to justify, or “correct” the general¹⁰¹⁰.

On the brink of the (European) Colonization Period, and while some of these theories and justifications were still in the process of being established, European nations came into brutal contact with numerous other cultures whose musics followed different rules, and whose bare existence, at least for some of them, could jeopardize the relative *status quo* established through the constitution of this body of theoretical biases.

Moreover, and specifically in respect of *maqām* music, the relation with these musics was complicated due to two main causes, the first being political, and

¹⁰⁰⁷ Formerly called “modulations”.

¹⁰⁰⁸ The “tolerance” of the ear.

¹⁰⁰⁹ The “cycle of fifths”.

¹⁰¹⁰ The results of the Acoustic Resonance Theory.

¹⁰⁰⁶ The terminology is borrowed from Ruth Solie’s “Melody and the Historiography of Music” [1982, p. 297].

the second being social and cultural with the two reasons interwoven in an intricate manner.

Taken separately, the first of these reasons, the political reason, was also historical: the countries in which *maqām* music prevailed were part of three successive empires – Byzantine, Arabo-Persian, and Ottoman empires – which all three had antagonistic relations with European countries at some historical period or another, and had at some point threatened, shed war on, and/or occupied European nations or parts of them – and *vice versa*. All these facts made it difficult, whenever the (historical) wheel turned, not to indulge in a retaliation mood.

The second reason was social and cultural, as well as being rooted in Ancient and Early History: social because European identity had been founded on the Ancient Greek dogma – however distorted in the re-readings of the Europeans¹⁰¹¹; cultural and historical as *maqām*-countries cultures could all, at some point or another, also claim Greek legacy, a situation which created a clear conflict of interest with the colonizing nations.

These reasons led to a complex process of legitimation of Occidental music as a whole in order to establish its superiority – sometimes expressed using racial terminology – over the freshly colonized, as well as the to-be-colonized (or dominated) peoples.

On an internal basis, this legitimation process consisted mainly, as expressed above, in a re-reading (and a re-writing) of Ancient Greek music theories¹⁰¹² to fit them forcibly into Occidental music at that time, excluding thus all other characteristics of Ancient Greek music – deemed “Oriental”.

In parallel, Occidental music history, which contended itself in the previous centuries with a direct filiation with Ancient Greek – then “Roman” – music, with the inclusion of “Early Christian Music” leading to European Music of the Middle Ages and, as a climax, to Johann-Sebastian Bach as the utmost representative of the multi-tempered period, faced a new dilemma: the difficult task of including all the “new” (or “foreign”) musics (and their theories of the scale¹⁰¹³) in an evolutionary scheme (influenced by Spencerian and

Darwinian evolutionary thoughts) which would lead, eventually, to Occidental tonal music and justify its superiority – as well as its own, contradictory evolution towards equal-temperament.

While “primitive”, oral-based musics created – due to their “simplicity” – no specific problems for Occidental historians, “Art” musics, such as Chinese, Indian and *maqām* musics¹⁰¹⁴, although – and at least – partly based on Oral transmission, had an abundant musical (and theoretical) literature and had to be dealt with differently – and specifically.

Whenever Chinese and Indian music scale structures seemed to conform to Occidental biases, and while these two countries did not constitute a direct threat to Occidental supremacy at that time, these musics were seamlessly integrated in the generalized scheme figured out by Occidental historians and musicologists.

As for *maqām* musics¹⁰¹⁵, another difficulty arose from the fact that a prominent actor of these musics, Byzantine chant, happened to be at the same time Christian and, in the eyes of the Occidentals, Greek, which established an unacceptable flaw in the Orientalist (or “othering”) and Hellenistic (or “legitimation”) processes in which they were engaged.

Byzantine chant had thus to be irrevocably integrated into the Occidental realm, even if this process would necessitate considerable twisting of the historical and analytical facts to make them conform to Occidental biases.

The same process, which I call the “Hellenism / Orientalism Process”, was applied to other, “non-Christian” and “Eastern” *maqām* musics with the aim, in this case, of excluding these musics from the evolutionary scheme, deeming them “backwards”.

General scheme of the Hellenism/Orientalism process

A general, mostly simple pattern emerges from the Orientalism / Hellenism process applied to *maqām* musics in the 18th to 21st centuries, based on postulates

¹⁰¹⁴ In their variety for each of these.

¹⁰¹⁵ Indian music should definitely, in my opinion, be considered as an integral part of the more general *maqām* realm: this is however for Indian musicologists and musicians to determine and decide.

¹⁰¹¹ See Chapter IV: Hellenism and Philhellenism.

¹⁰¹² Or their “Europeanization”.

¹⁰¹³ When these existed.

with logical inferences and corollaries which lead, in turn, to new postulations allowing for further biased “logical” inferences.

The whole process led to consequences which suited the aim of the Orientalism / Hellenism procedure, and can be summarized as follows:

➤ Initial postulates:

- Ancient Greek music is in its essence ditonic (both in theory and praxis), *i.e.* Pythagorean-Occidental.
- The European tonal system is the climax of a world-wide evolutionary process; it is based on rules of harmony which are a further and unique phase of development of music, on consonantal laws inherited from Ancient Greek music, and on ditonism which is the unique scale system holding these characteristics and fitting best this music. It is further theorized up to the latest scientific discoveries – inclusive in the field of music acoustics – and based on written transmission and notation which supports it with the status of a “science”, a position to which other musics could hardly pretend.
- Early *maqām* theories follow the rules of Ancient Greek music theory (“they imitate the Greeks”).

➤ It follows that:

- Early Arabian, Persian or Byzantine musics, inherited from Ancient Greeks, could only have been ditonic.
- All “discrepancies” found in the descriptive Arabian, Persian or Byzantine and later Ottoman writings, ancient or contemporary, theoretical or practical, are merely non-structural additions, and should not be taken into consideration.
- “Zalzalian” theories (which include “Oriental characteristics”) are therefore (and to the least) inadequate as they are in conflict with the postulate of evolutionary music.

From the preceding propositions stems a new, additional postulate:

- *Maqām* music is originally an imitation of (or a legacy from) Ancient Greek music and has degenerated since – with the following consequences:

- Autochthonous *maqām* theoreticians in the 19th and 20th centuries absorbed the Pythagorean-Occidental theories they found in their conquerors/victors/masters’ books and theories – and teaching –, then regurgitated them in a *maqām*-like style following thus a typical attitude of re-Orientalism, with some of them postulating the superiority of *maqām* music over the Occidental.
- Written works stay, oral transmission fades away¹⁰¹⁶.
 - Oral teaching, which was intended (by local theoreticians) to preserve actual music and complement its theoretical teaching, becomes magisterial and written, based on 19th- and 20th-centuries theories (remembering that these theories were inspired by Occidental theories and differed from praxis).

➤ It follows that:

- *Maqām* praxis profoundly changes in the direction of equal-temperament and semi-tonality (“piano” keys), eventually as an equal- (or unequal-) tempered semitone-compatible system,
- Oral teaching is (practically) lost,
- Music aesthetics and listening change drastically,
- Autochthonous musicology goes astray,

➤ with the following collateral results:

- The enforced or intended assimilation of “Oriental” musics in the “Tonal Cauldron”,
- The gradual fading of the Zalzalian *Lingua Franca*¹⁰¹⁷,

¹⁰¹⁶ The basic example provided in this dossier is the passage from the First to the Second Byzantine chant reform in the 19th century; other examples have been provided such as the belief of most conservatory students or Autochthonous composers that the “Arabian quarter-tones” are equally tempered – competent teachers do explain peculiarities of the modal system that written books fail to consider, but even those, with the successive generations, have forgotten for instance, notably in Arabian countries, that the *hijāz* tetrachord was performed differently half a century (or one century) ago.

¹⁰¹⁷ Now replaced by World Music as the “Classic Music” of today? (see [Ling, 2003] entitled “Is ‘World Music’ the ‘Classic Music’ of Our Time?”).

- The loss of common bearings and identity (identity is torn apart – existential disorientation) and, consequently, with:
 - The rise of antagonistic nationalisms.
 - The reign of musical and musicological intra-Orientalism and re-Orientalism.
- At the end: “All is for the best in the best of all possible [Occidental] worlds”¹⁰¹⁸, *n’est-ce pas, madame la marquise?*

Beyond Hellenistic Orientalism?

As long as, according to Bohlman¹⁰¹⁹, musicology and comparative musicology share the same methodological tools, concepts and paradigms in the 19th century, and that the latter were carried on by ethnomusicology in the 20th (and now in the 21st) centuries¹⁰²⁰, it seems difficult to anticipate a positive role for any of these disciplines in the future analysis of *maqām* music as, until today, these “sciences” have utterly failed in the study of this music.

In parallel Orientalism, although deemed in crisis in the 20th century¹⁰²¹, seems today more effective than ever while Hellenism, albeit also deemed further unsustainable, is still predominant whereas its founding relation with Orientalism is still denied¹⁰²².

This proficiency is even more vivid when Hellenistic Orientalism is examined in the light of the musicological handling of Arabian, Persian, Turkish

and other *maqām* musics, as the Orientalist and Hellenistic processes in this field are nearly completed.

* * *

Has anything changed in (*maqām*) musicology since the time of Fétis? It seems it has not.

Could musicology eventually change? I do not know.

If “music cannot be defined as a phenomenon of sound alone”¹⁰²³, it is equally true that (ethno) musicology cannot be defined as a phenomenon of science alone: the object of study (“music”?), the interaction with ideology and identity biases, everything contributes to exclude musicology and its avatars, in their present form, from the “sciences”, and to relegate them as a phenomenon purely endogenous to Occidental societies, shaped by the Great Expansion in the 19th and 20th centuries.

Can Autochthonous musicologists – or better say researchers on music – alternatively and with their own biases, and with re-Orientalism prevailing in their *démarche*, try to found a new musicology of the *maqām*, independently from their own as well as from their teachers’ biases? This may seem very unlikely, although small sparks of hope seem to develop on the horizon¹⁰²⁴.

All in all, one last, and most important question arises about the deliquescence of the science of music. During the 19th and 20th centuries, errors, falsifications, approximations and alterations of Occidental musicology came from a more or less concerted agreement between musicologists (such as Bourgault-Decoudray, far from being an isolated case) whose interests converged towards the protection of the supremacy and the superiority of their music.

The continuation of this state of affairs remains baffling.

¹⁰¹⁸ This is the well-known Leibnizian mantra of Pangloss, then of his apprentice Candide in Voltaire’s eponymous book [Voltaire, 1759] – the added French phrase terms “Isn’t it so, Mylady?” and is inspired from the 1935 French song (written and composed by Paul Misraki) *Tout va très bien madame la marquise* (“All is well M’lady”) which became a symbol for blindness while facing a desperate situation – see [Anon. “*Tout va très bien madame la marquise* (chanson)”, 2016; Olivier Platteau, 2011] for the latter, and [Anon. “*Candide*”, 2016] for the former.

¹⁰¹⁹ “[...] both musicology and ethnomusicology were rooted in similar conceptual soils during the past century, so much so that the two disciplines were dependent upon one another for a scientific unity necessary to secure a place for them in the intellectual institutions of the present century” – [Bohlman, 1987, p. 148].

¹⁰²⁰ See [Bohlman, 1987, p. 163, footnote 57] and, for the implementation of historical methods in ethnomusicology, [Bohlman, 1988, p. 38–39].

¹⁰²¹ Apart from Abu Lughod, Abdel-Malek and Said’s writings, see [Kemp, 1984, p. 35].

¹⁰²² See [Vasunia, 2003] – quoted in Appendix 7, footnotes 1330, 1331 and 1332, p. 246.

¹⁰²³ [Merriam, 1964, p. 27], as quoted in [Wong, 2014, p. 349].

¹⁰²⁴ See for instance [Puchala, 2002, p. 30] and [Djumaev, 2005, p. 180–181] for potential perspectives for Autochthonous musicologists.

However, there are reasons for this unbearable silence of contemporary musicologists: some, merrily export¹⁰²⁵ their vacillating musicology to *maqām*-practicing countries, knowingly¹⁰²⁶, to say the least, avoiding to mention weaknesses for the purpose of perpetrating the flaw, to their satisfaction. Following on, others indulge in the same practice either indifferently or passively¹⁰²⁷ while the majority¹⁰²⁸ of those keen on spilling the works become mute, fearing retaliation from the establishment.

Fully aware that this silence feeds and encourages musicological Orientalism and re-Orientalism, as mentioned in Chapter V, the function of contemporary mainstream musicology persists with its destructiveness having for sole purpose inappropriate postulations, these being the very basis devised for the preservation of its 'superiority'¹⁰²⁹.

This form of musicological Orientalism has provoked considerable damage to an almost defunct *maqām* music, if not to most non-Occidental musics. It remains silent and this behavior, either from *maqām* or from general musicologists, amounts to promote actively cultural and scientific neo-colonialism.

Additionally, and in the current Orientalist context, the association of Western and local (*maqām*) Universities and other musical institutions contributes

to a neo-colonialist expansion with its ideologies and destructiveness.

In my personal opinion¹⁰³⁰, rather than undertaking a radical re-assessment of its axioms, Occidental musicology¹⁰³¹ will not only try to keep time on its side and maintain its Orientalist/Hellenistic course unchanged, but may even more endeavor to enshrine this course in current and future studies¹⁰³².

The only alternative, however, and as far as I am concerned, is to engage in a complete rethinking of the current status of musicology, whether historical or theoretical; to eliminate its original flaws, its feeding and perpetrating of silence; to find alternative and innovative answers with regard scale theories; to refute, irrevocably, the Hellenist myth believed seminal to European and Occidental principles, and lastly to incorporate the predominance of the Oriental heritage.

¹⁰²⁵ Or "import", in the case of Re-Orientalism.

¹⁰²⁶ By means of an acquiescent and para-institutional agreement since the goals of any academic institution are (should be?) the broadcasting of science and truth. This standpoint equates to a convergence of interests which no longer aims at the active modification of facts, (this has been done) but at the preservation of social and cultural heritages for any given field.

¹⁰²⁷ Or even unknowingly.

¹⁰²⁸ Bohlman's articles mentioned in this dossier are an encouraging counter-example. However, it appears that they did not have a long-lasting consequence as they relate, perhaps, predominantly to the history of the field rather than to the fundamentals of the field itself.

¹⁰²⁹ Occidental musicology, as far as I see it, is currently engaged in a headlong rush, at least with fundamental scale and temperament theory. The only innovations are nothing more, apparently, than refinements of Helmholtz's theory following Bailhache (cited in Appendix 4) and others, or the so-called Pythagorean theory, (numerous and ubiquitous in the musicological literature and the media). The opposition to the reconsideration of seminal postulations seems to have led to a vicious circle, still explored, in the hope of squaring the circle.

¹⁰³⁰ Based on my experience while discussing similar problematics, for the last 20 years or so, with representatives of Academic musicology; these discussions tend to comfort me in the thought that "The Orientalist attitude," [as] writes Said, 'shares with magic and with mythology the self-containing, self-reinforcing character of a closed system, in which objects are what they are because they are what they are, for once, for all time, for ontological reasons that no empirical material can either dislodge or alter.' [...] – as quoted in [Fleming, 2000, p. 1231].

¹⁰³¹ Except for – and for the time being – personal initiatives by independent or innovative scholars.

¹⁰³² Thus the Sorbonne University inviting in 2016 an Arabian musicologist to discuss "The history of the Major and Minor gamuts/modes, [which] are constantly and exclusively related to Latin Europe and to the evolution from modality to tonality. There is however clues about the musical system practiced in the 9th-century Baghdad which will be presented and clarified during this conference. These indications allow for the discussion of the history of the Major and Minor gamuts/modes within a more global historical approach of music evolution in the Middle Ages" – [Anon. "Laboratoire d'excellence - Religions et Sociétés dans le Monde méditerranéen - L'évolution des gammes/modes majeur et mineur : vers une approche Musicomédiane"], last viewed 2016-06-24 16:45:21: a convenient way of even more exporting one's own prejudices in the *maqām* realm, while using "Newspeak" (with a worked example, for French-speaking readers, available at <http://www.musicomed.net/>, viewed 28/11/2016) to foster this renewed Orientalist approach.

PLATES FOR THE MAIN ARTICLE

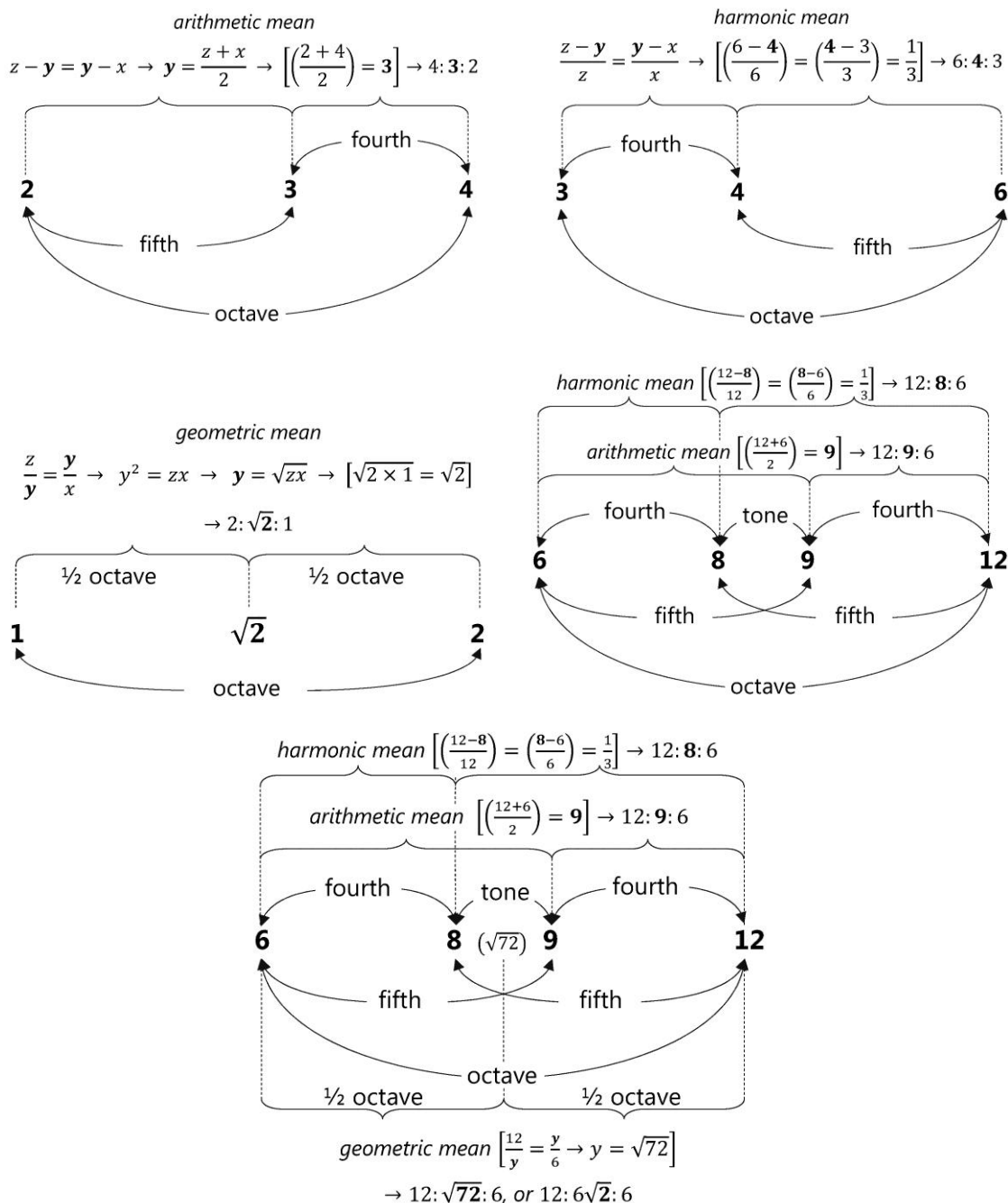

FHT 1 The three main means (adapted and translated from [Beyhom, 2010c])¹⁰³³.

¹⁰³³ From left to right, up to bottom, the *arithmetic mean* (by summing the two terms 2 and 4 and dividing by 2), the *harmonic mean* (4 being the harmonic mean of 3 and 6) and the *geometric mean* the computation of which imposes (in this particular case) the use of square roots – i.e. “irrational numbers” – for $z = 2x$, because in this case $y^2 = 2x^2$ and $y = x\sqrt{2}$ {a convenient suite for the *geometric mean* would be 1 2 4, with 4 being the double octave of 1, or $(1 \times 2)^2$ }; the *tetraktys* 6 8 9 12 expresses the two *arithmetic* and *harmonic* means, whereas failing to express the *geometric mean* in “rational” (integer) numbers (the last – lower – scheme is here corrected from [Beyhom, 2010c]); in other words, “rational” expressions of the half-octave in Pythagorean mathematics are impossible, as the geometric mean must always be equal to the smallest integer among the two delimitating the octave, multiplied by the square root of 2 (the latter being “irrational”), or $y = \sqrt{zx}$ with $z = 2x \rightarrow y = x\sqrt{2}$ – Slides Nos 3-4.

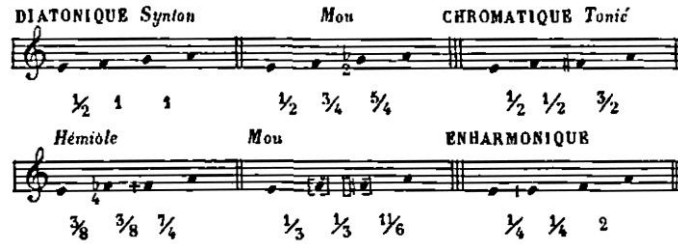

FHT 2 Weil and Reinach's notation of Aristoxenos' typical tetrachords¹⁰³⁴ (as for most representations, this one is chosen on e to minimize the number of accidentals).

Theoretician	Archytas	Eratosthenos	Didymus	Ptolemaeus		
Type	diatonic (P. "middle" or "tonic")	diatonic	diatonic	diatonic: "soft"	diatonic: "syntonic" or "tense"	diatonic: equal
1 st ratio	8/9	8/9	8/9	7/8	9/10	9/10
cents	204	204	204	231	182	182
2 nd ratio	7/8	8/9	9/10	9/10	8/9	10/11
cents	231	204	182	182	204	165
3 rd ratio	27/28	243/256	15/16	20/21	15/16	11/12
cents	63	90	112	84	112	151
Sum	498	498	498	498	498	498
Stated by	Fārābi, Sīnā (7/8, 8/9, 27/28)	Fārābi and Sīnā	Fārābi, Sīnā (9/10, 8/9, 15/16)	Fārābi and Sīnā	Fārābi (2 1st intervals inverted), Sīnā	Fārābi

FHT 3 Diatonic tetrachords in Greek texts: the definition of *diatonic genera* implies that they have no *pycnon*; in other terms, all diatonic *genera* have their greatest interval measuring less than 1 1/2 tones or $I_3 < 1\ 1/2$ tones (or $I_3 < I_1 + I_2$, where I_1 and I_2 are the smallest intervals in the tetrachord, composing the *pycnon* in non-diatonic tetrachords); values of the greatest interval in each tetrachord are reproduced in bold and brick font¹⁰³⁵ – Slide No. 8.

Tetrachordal divisions (Ancient Greek theories) - A -									
Theoretician	Archytas			Eratosthenos			Didymus		
Type	enharmonic	chromatic	diatonic	enharmonic	chromatic	diatonic	enharmonic	chromatic	diatonic
1 st ratio	4/5	27/32	8/9	15/19	5/6	8/9	4/5	5/6	8/9
in cents	386	294	204	409	316	204	386	316	204
2 nd ratio	35/36	224/243	7/8	38/39	18/19	8/9	30/31	24/25	9/10
in cents	49	141	231	45	94	204	57	71	182
3 rd ratio	27/28	27/28	27/28	39/40	19/20	243/256	31/32	15/16	15/16
in cents	63	63	63	44	89	90	55	112	112
sum	498	498	498	498	498	498	498	498	498
Equivalences	Fārābi (4/5, 27/28, 35/36), Sīnā (35/36, 4/5, 27/28)	missing	Fārābi, Sīnā (7/8, 8/9, 27/28)	missing	Fārābi (last 2 inverted), Sīnā (inverted)	Fārābi and Sīnā	Fārābi and Sīnā (4/5, 31/32, 30/31)	Fārābi (last 2 inverted), Sīnā	Fārābi, Sīnā (9/10, 8/9, 15/16)

Tetrachordal divisions (Ancient Greek theories) - B -									
Theoretician	Ptolemaeos								
Type	enharmonic	soft chromatic	tense chromatic	soft diatonic	middle or tonic diatonic	ditonic diatonic	tense or syntonic diatonic	equal diatonic	enharmonic 2 nd form
1 st ratio	4/5	5/6	6/7	7/8	8/9	8/9	9/10	9/10	4/5
in cents	386	316	267	231	204	204	182	182	386
2 nd ratio	23/24	14/15	11/12	9/10	7/8	8/9	8/9	10/11	21/22
in cents	74	119	151	182	231	204	204	165	81
3 rd ratio	45/46	27/28	21/22	20/21	27/28	243/256	15/16	11/12	55/56
in cents	38	63	81	84	63	90	112	151	31
sum	498	498	498	498	498	498	498	498	498
Equivalences	Fārābi	Fārābi and Sīnā	Fārābi and Sīnā	Fārābi and Sīnā	Fārābi (7/8, 8/9, 27/28), Sīnā	Fārābi and Sīnā	Fārābi (first 2 inverted), Sīnā	Fārābi	(Erlanger)

FHT 4 Ancient Greek tetrachords with equivalents for (al-) Fārābi (9th-10th centuries – see [Wright, 2001b]) and (ibn) Sīnā (10th-11th centuries – see [Wright, 2001c]), the first two major Arabian music theoreticians¹⁰³⁶.

¹⁰³⁴ [Plutarque (0046?-0120?), 1900, p. 113].

¹⁰³⁵ Adapted and translated from [Beyhom, 2010c; 2015b].

¹⁰³⁶ Arabian tetrachords are taken from [Fārābi (al-), 1930; Fārābi (al-) et al., 1935; Yūsuf, 1956; 1967 أبو نصر محمد بن محمد بن ترخان الفارابي, 1998]; Greek tetrachords from [Mathiesen, 1999]; the enharmonic tetrachord in its 2nd form in the lower table (Ptolemaeos – last column to the right) is taken from the Appendix of [Erlanger, 1930]. First published (in French) in [Beyhom, 2010c].

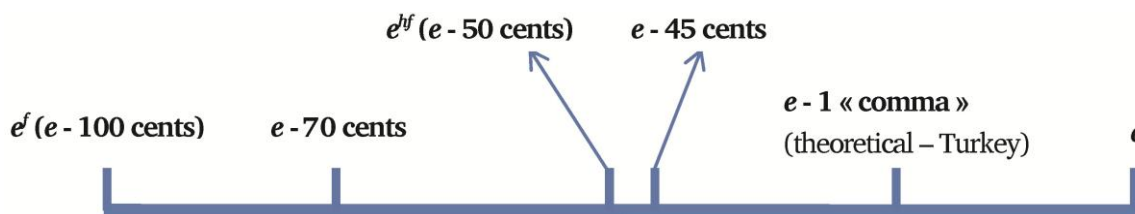

FHT 5 Differentiation of musical pitches: listening to different steps between e^{flat} and e^{1037} ; see Slide No. 15 for the related audio sounds.

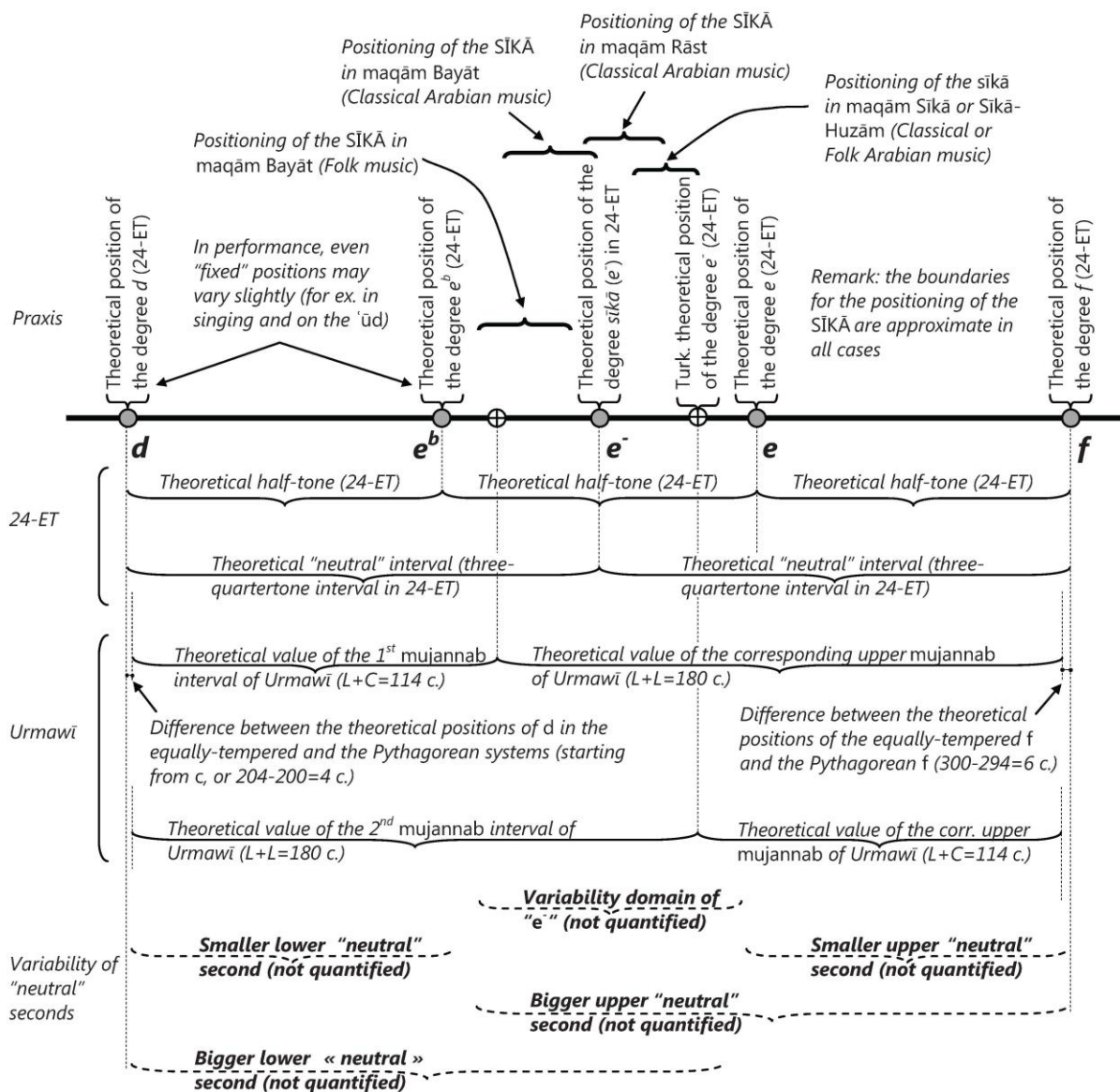

FHT 6 Theoretical and practical models for the degree SĪKĀ (e) in maqām music¹⁰³⁸.

¹⁰³⁷ Adapted and translated from [Beyhom, 2004].

¹⁰³⁸ Adapted from [Beyhom, 2010a, p. 179]: 24-ET = Equal-temperament in 24 divisions, *mujannab* = the so-called "neutral second" (intermediate, in Occidental theories, between the minor and major seconds), Urmawī = Šafiyī-a-d-Dīn al-Urmawī, Arabian-Persian-Turkish theoretician of the 13th century; note that Early "Arabian" theories and praxis always use consecutive *mujannab*(s) with different values.

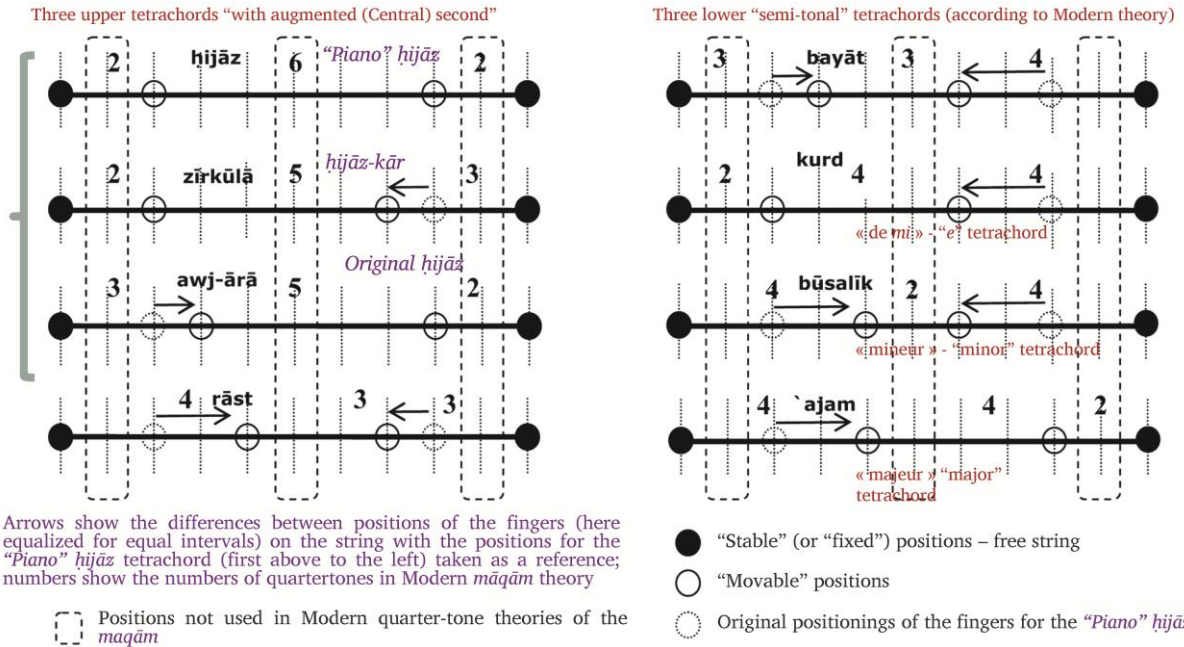

FHT 7 Typical *genera* (as tetrachords in their typical formulation in a given repertoire) in Arabian *maqam* music – performed by Hamdi Makhoul in the accompanying power point demo (Slide No. 17); names of tetrachords in black¹⁰³⁹ are older names found in various literature in Arabic, with updated denominations (see for example [Beyhom, 2014a]) in purple – this is the original sketch of Fig. 32.

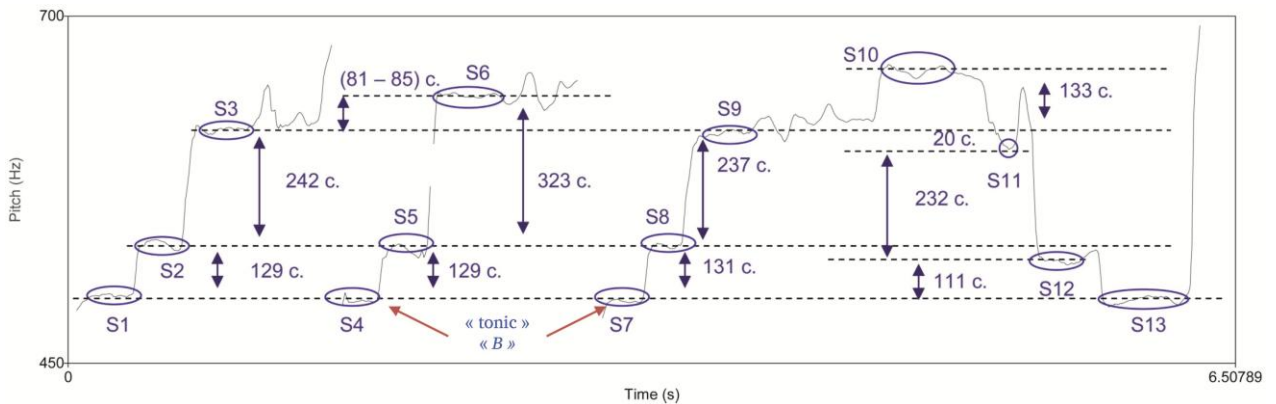

FHT 8 3 examples of *hijaz* by Kudsi Erguner (*na'y*): the 2nd example is, according to the (Turkish) performer, “to be avoided”. Recorded in Paris at the performer’s home, September 2005; tonometric analysis with *Praat* – Slide No. 18¹⁰⁴⁰.

¹⁰³⁹ “*ajam*” should for example be here written “*ajam*”.

¹⁰⁴⁰ Adapted from the author’s presentation at Royaumont [Beyhom, 2006b].

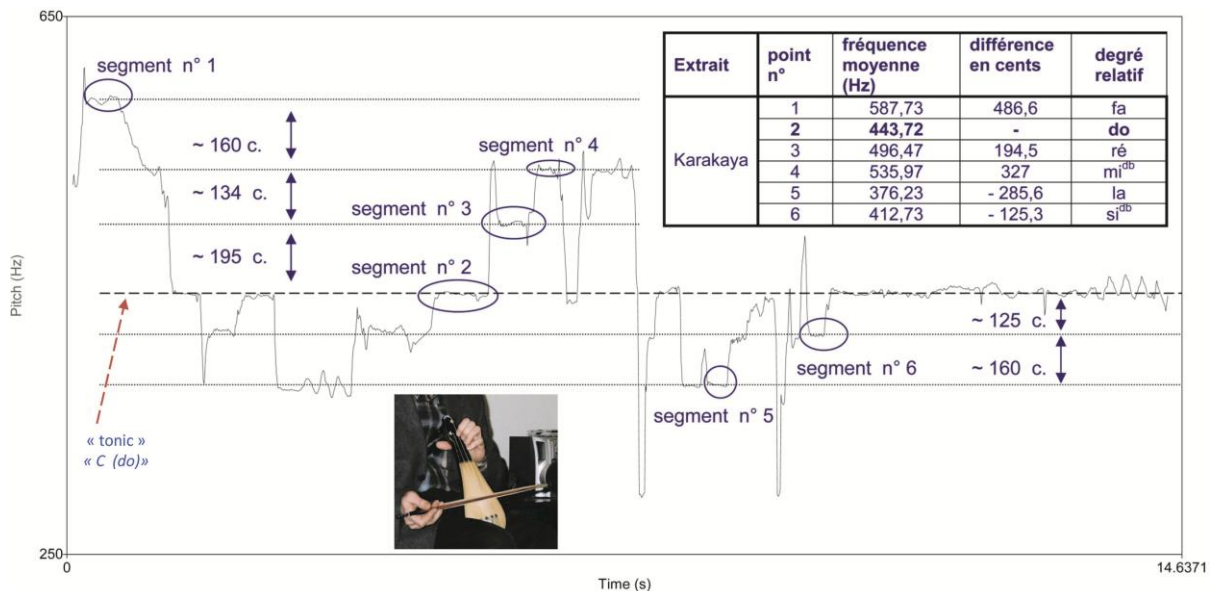

FHT 9 Introduction to *maqām Rāst* by Fikret Karakaya (Turkey), with inset showing (partly) the performer playing the *lyra*¹⁰⁴¹ – excerpts available on Slide No. 19.

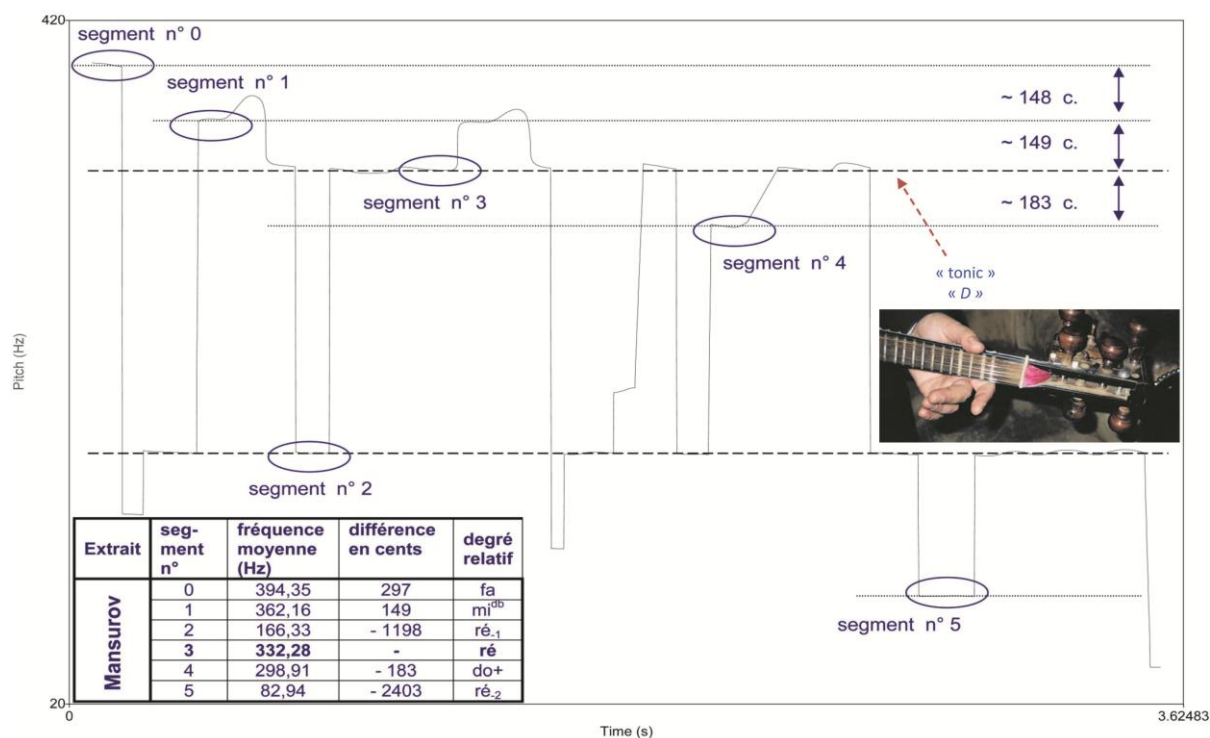

FHT 10 Introduction to *maqām Shur* by Malik Mansurov (Azerbaijan): the inset shows (a detail of) the performer with his (modified) *tār*¹⁰⁴² – excerpts available on Slide No. 21.

¹⁰⁴¹ Adapted from the author's presentation at Royaumont [Beyhom, 2006b]. Recorded in Tehran (IFRI) 17th of September 2005, tonometric analysis with *Praat*.

¹⁰⁴² Adapted from the author's presentation at Royaumont [Beyhom, 2006b]. Recorded in Tehran (IFRI) 17th of September 2005, tonometric analysis with *Praat*.

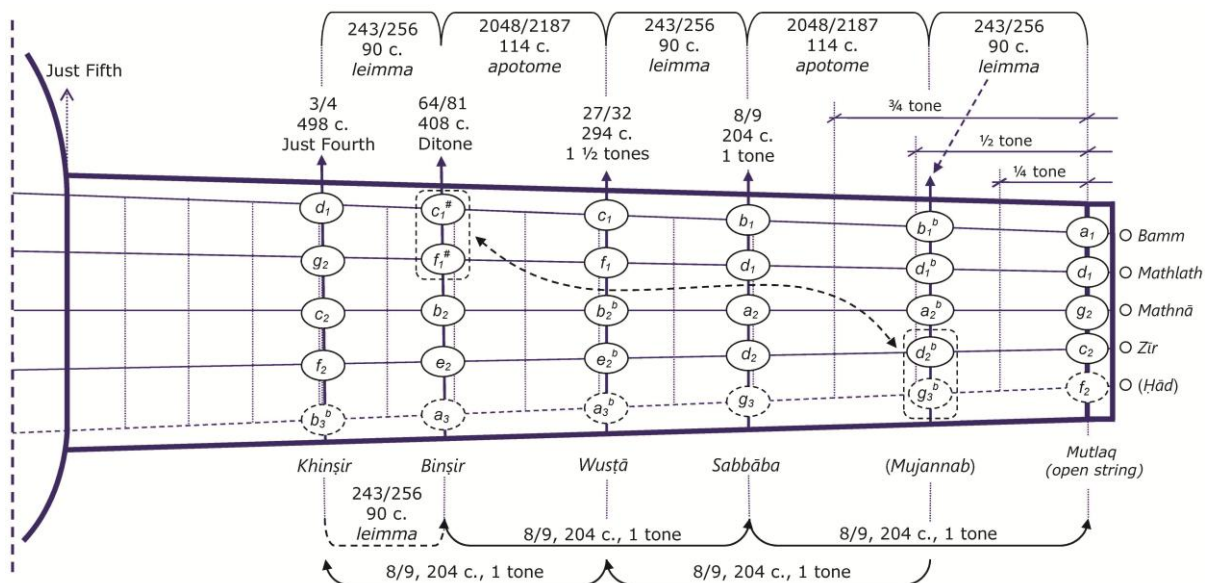

FHT 13 Pythagorean ascending-descending division of the fingerboard of the *ūd* (here stylized). Some correspondences between octave notes are faulty ([#] and ^b are Pythagorean, and raise or lower by one *apotome*); *g* is taken as the starting degree of the octave¹⁰⁴⁴.

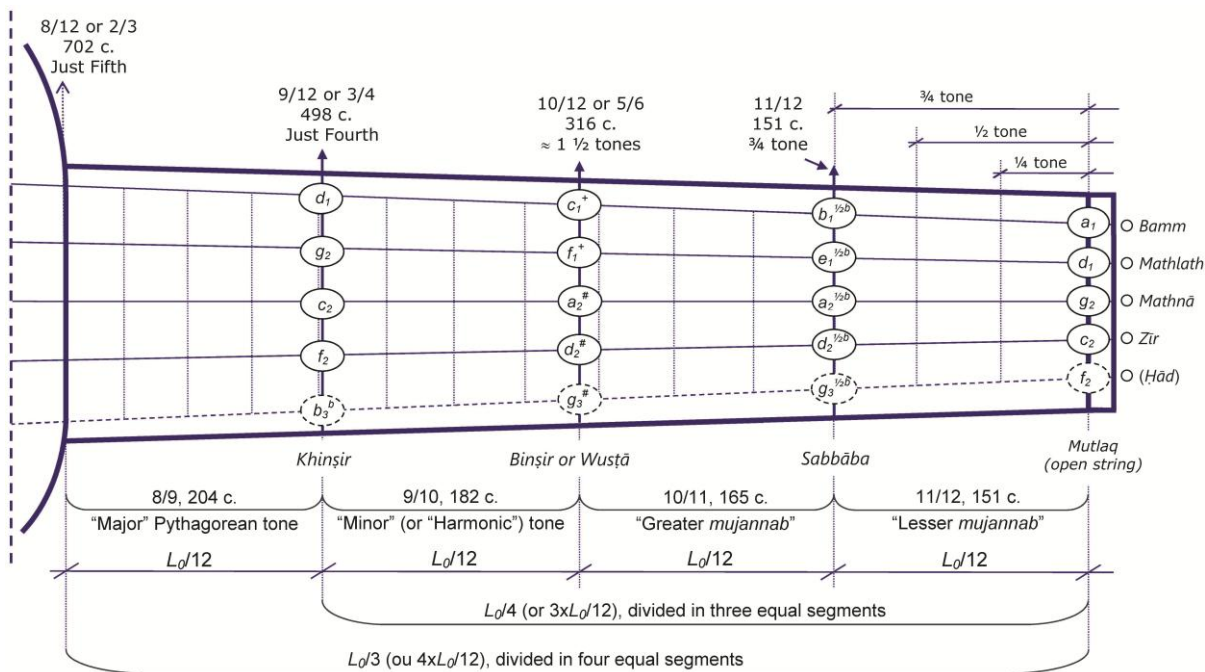

FHT 14 Equal-segments division (in 12 segments) of the strings on the fingerboard of the *ūd*¹⁰⁴⁵.

¹⁰⁴⁴ The ascending *dītōnicus* genus was used by the first Islamic theoreticians; later on, theoreticians added one descending tone, then another with a resulting Pythagorean semi-tonal mesh. The lowest string (*Hād*) was theoretical for most Early theoreticians: it was already effective at the time of Ibn a-ṭ-Ṭaḥḥān (11th-century Fatimid Egypt). Notes were generally identified by the name of the finger (*sabbāba* for the index, *wustā* for the middle finger, *binšir* for the ring finger and *khinšir* for the auricular) and the string name (*bamm*, *mathnā*, *mathnā*, *zīr* and the *hād*). Some theoreticians have devised alphabetical denominations of the notes for their systems. Strings were generally tuned in successive ascending fourths (from top down).

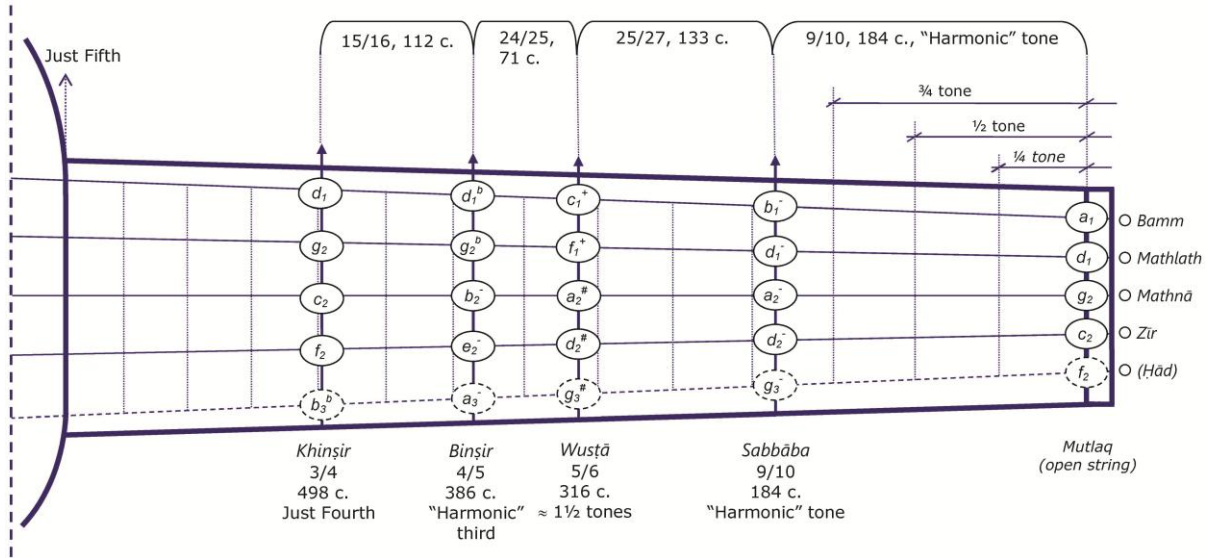

FHT 15 "Harmonic" division of the fingerboard of the 'ūd.

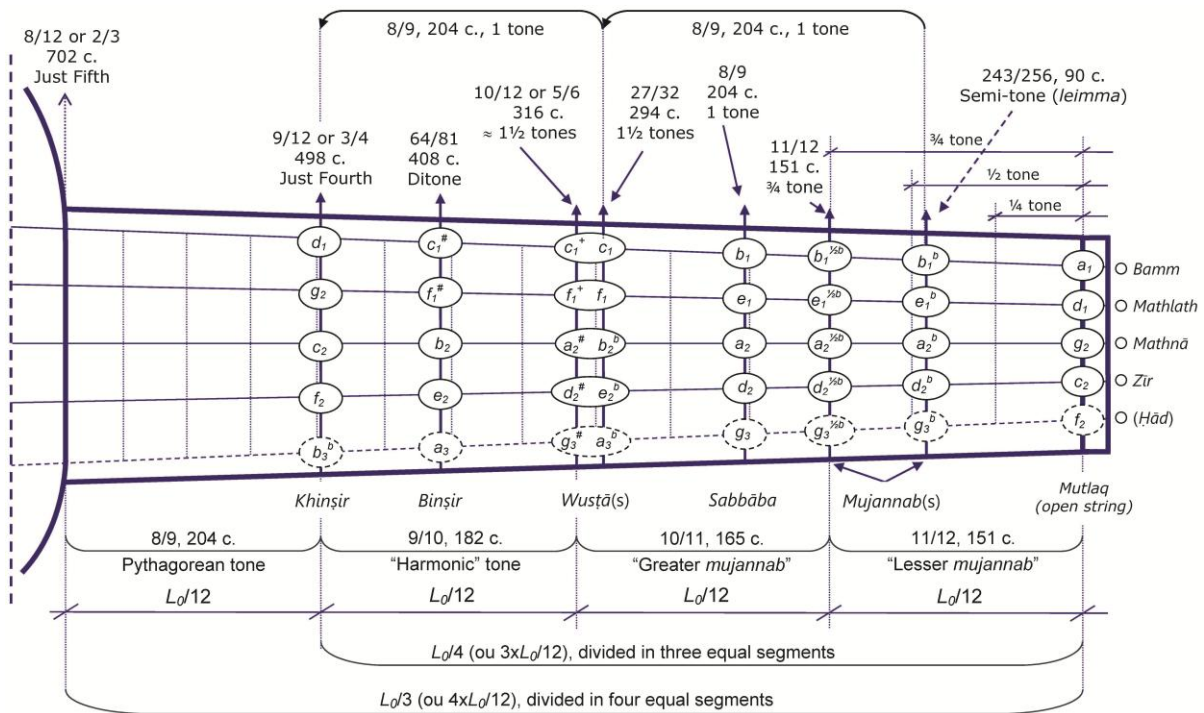

FHT 16 Mixed Pythagorean and Equal-segments division of the fingerboard of the 'ūd.

1045 Different numbers of equal segments have been used by Arabian or Islamic theoreticians (for instance 24-segments division), Early or less early, some equal-divisions being made between two positions of other (also issued from equal-divisions or Pythagorean processes) more or less neighboring finger positions. # and b are Pythagorean, and raise or lower by one *apotome*; + means raised by one (Pythagorean or "Syntonic") *comma*, and ^{1/2b} means lowered by an approximate quarter-tone.

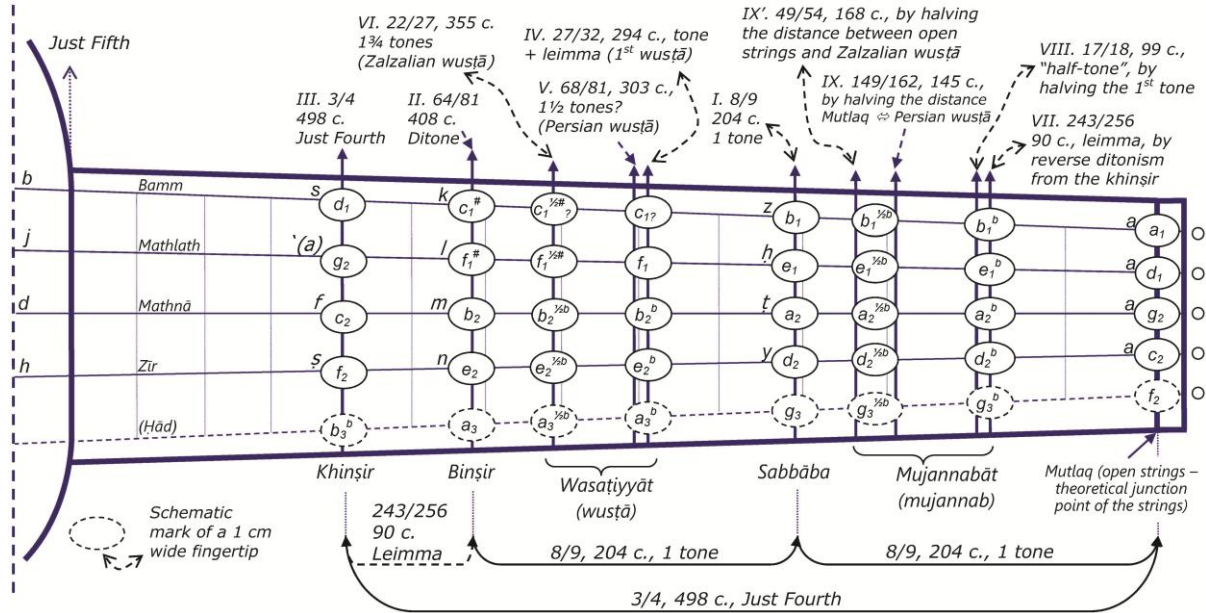

FHT 17 (Al-) Fārābī’s theoretical division of the fingerboard of the ‘ūd¹⁰⁴⁶.

Page 163.

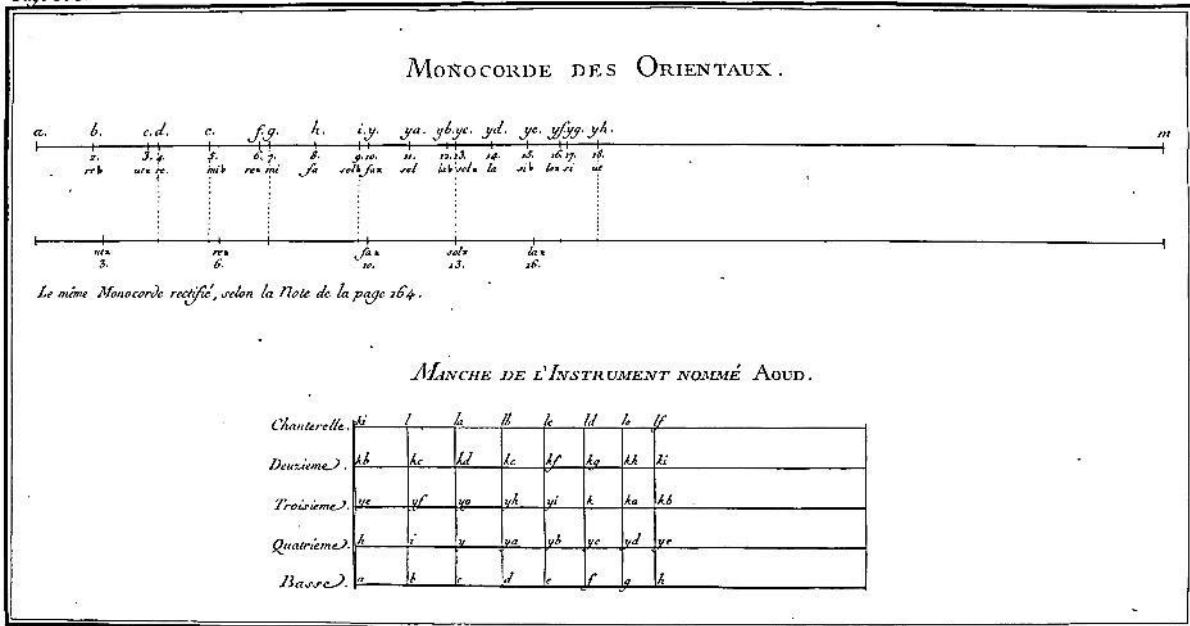

FHT 18 Division of the neck of the ‘ūd with presumed tablature and alphabetical notation (below), and correspondences (above) with the ditonic scale according to [Laborde (de), 1780a, v. 1, p. 163]; this (Systematist) division is attributed to the “Turks and the Persians”¹⁰⁴⁷.

¹⁰⁴⁶ Adapted from [Beyhom, 2010c, v. 1, p. 207] (Figure 75); # and b are Pythagorean, and raise or lower by one apotome; ¹/₄# and ¹/₄b respectively raise or lower the note by an approximate quarter-tone. Letters beside the fingertip marks correspond to the alphabetical notation of Fārābī: the “a”(s) to the right (open strings) show that the four strings are supposed to meet in this vertical emplacement on the fingerboard, a very unpractical disposition for performance. The fifth string (hād) is theoretical.

¹⁰⁴⁷ Whose music is addressed in [Laborde, *idem*, p. 162 sq.].

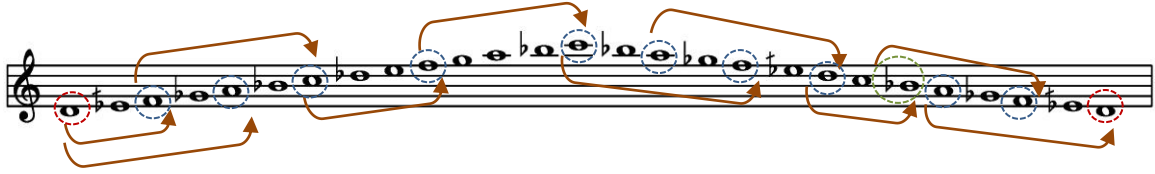

FHT 19 Polychordal structuring of the ascending and descending progressions of *maqām Ṣabā* as described in [Erlanger, 1949, v. 5, p. 282]¹⁰⁴⁸.

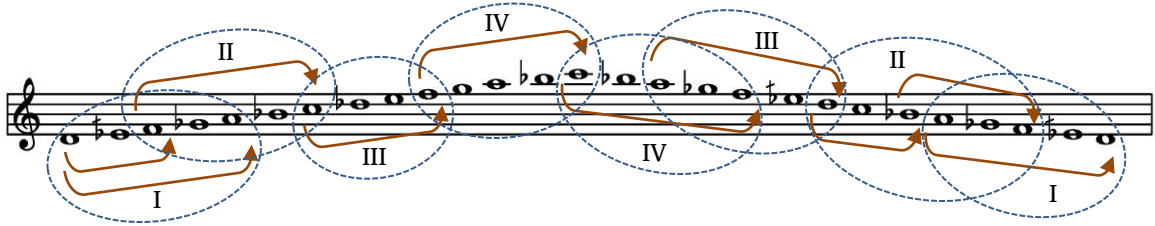

FHT 20 Same as above, with the main sections of the *sayr-al-amal* – or “typical modal path” – numbered and circled in blue¹⁰⁴⁹.

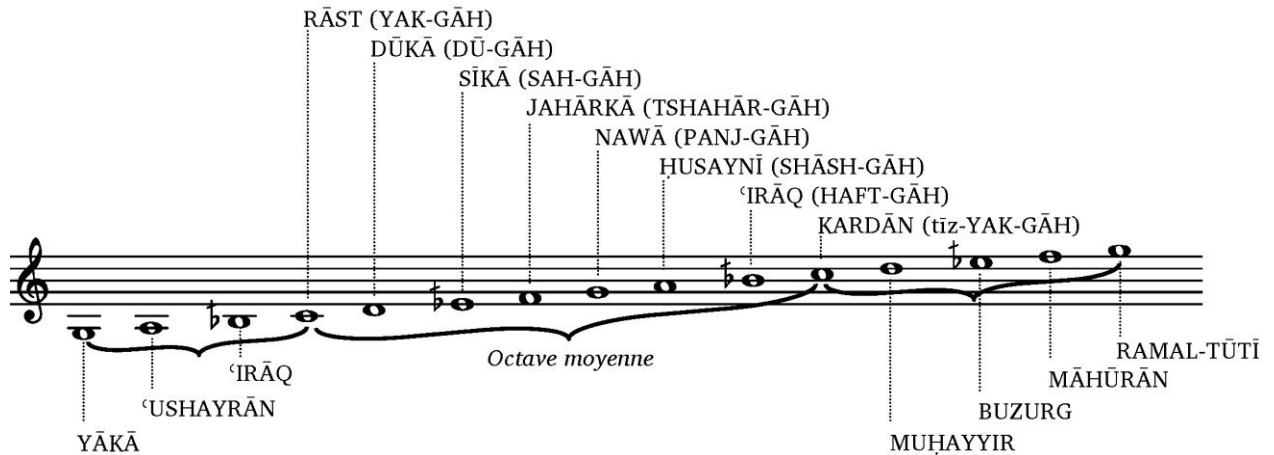

FHT 21 The General bi-octavial scale of Arabian music according to Erlanger, with the “modern” names of the degrees¹⁰⁵⁰.

¹⁰⁴⁸ The “rest notes” are circled in blue (descending b^{mol} in green), and the tonic(s) in red. Rest notes may become “secondary tonics”, which is the essence of *maqām* evolution at the time of performance.

¹⁰⁴⁹ Chronological progression goes from the left to the right, with variations in praxis (see the notated example in [Erlanger, 1949, v. 5, p. 283]). Further note: when describing the “modal path”, theoreticians often include “departure notes” (when these are different from the tonic), a *finalis* (including a “cadence”) and possible variations that the graphical representation in this figure does not cover.

¹⁰⁵⁰ Adapted from [Erlanger, 1949, v. 5, p. 13 (Fig. 3)]: \flat = half-flat, and the central, “middle” octave is the ascending scale of *maqām Rāst*. Older denominations, such as *YAK-GĀH* to *HAFT-GĀH*, are based on Persian numbers 1 (*yak*) to 7 (*haft*): note that the terms *yēk*, *dū*, *cē*, *johār*, *banj*, *shēsh* (transliterated from Lebanese vernacular dialect) are still in use for the game of tric-trac (backgammon) in Lebanon.

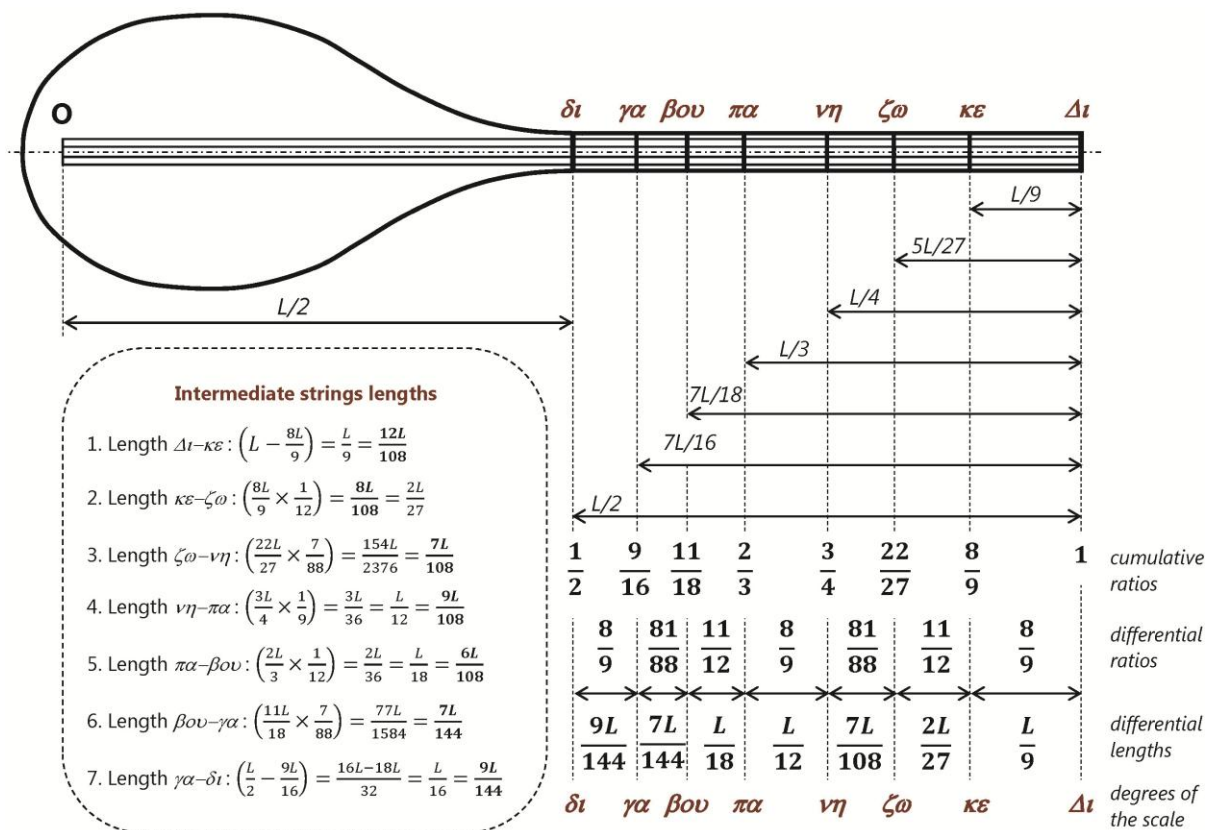

FHT 22 Chrysanthos Madytos' detailed division of the strings on the neck of the *tunbūr* (translated and adapted from [Beyhom, 2015b, p. 185]).

Intervallic ratio	Mean value	Cumulative ratios	Internal intervals	Cumulative	to the cent	minutes count
value in cents	Tone value		values in cents	values in cents		
8 / 9	204	8/9	203,91	203,91	204	204
203,910	204	8/9	17,94	203,91	18	12
		97/108	17,76	185,97	18	11
		49/54	17,58	168,21	18	10
		11/12	17,40	150,64	17	9
		25/27	17,23	133,24	17	8
		101/108	17,06	116,01	17	7
		17/18	16,89	98,95	17	6
		103/108	16,73	82,06	17	5
		26/27	16,57	65,34	17	4
		35/36	16,41	48,77	16	3
		53/54	16,26	32,36	16	2
107/108	16,10	16,10	16	1		
1 / 1	0	1	0,00	0	0	0

Divisions in minutes		
204	$\kappa\epsilon = \pi\alpha$	
12	12 divisions are equivalent to 1/9 of the string's length	
		8/9
		$\Delta\iota = \nu\eta$
		1

FHT 23 Deduced internal division of the 12-minutes tone in Chrysantine theory, based on an equal-division of the strings inside the boundaries of the interval (translated and adapted from [Beyhom, 2015b, p. 196]).

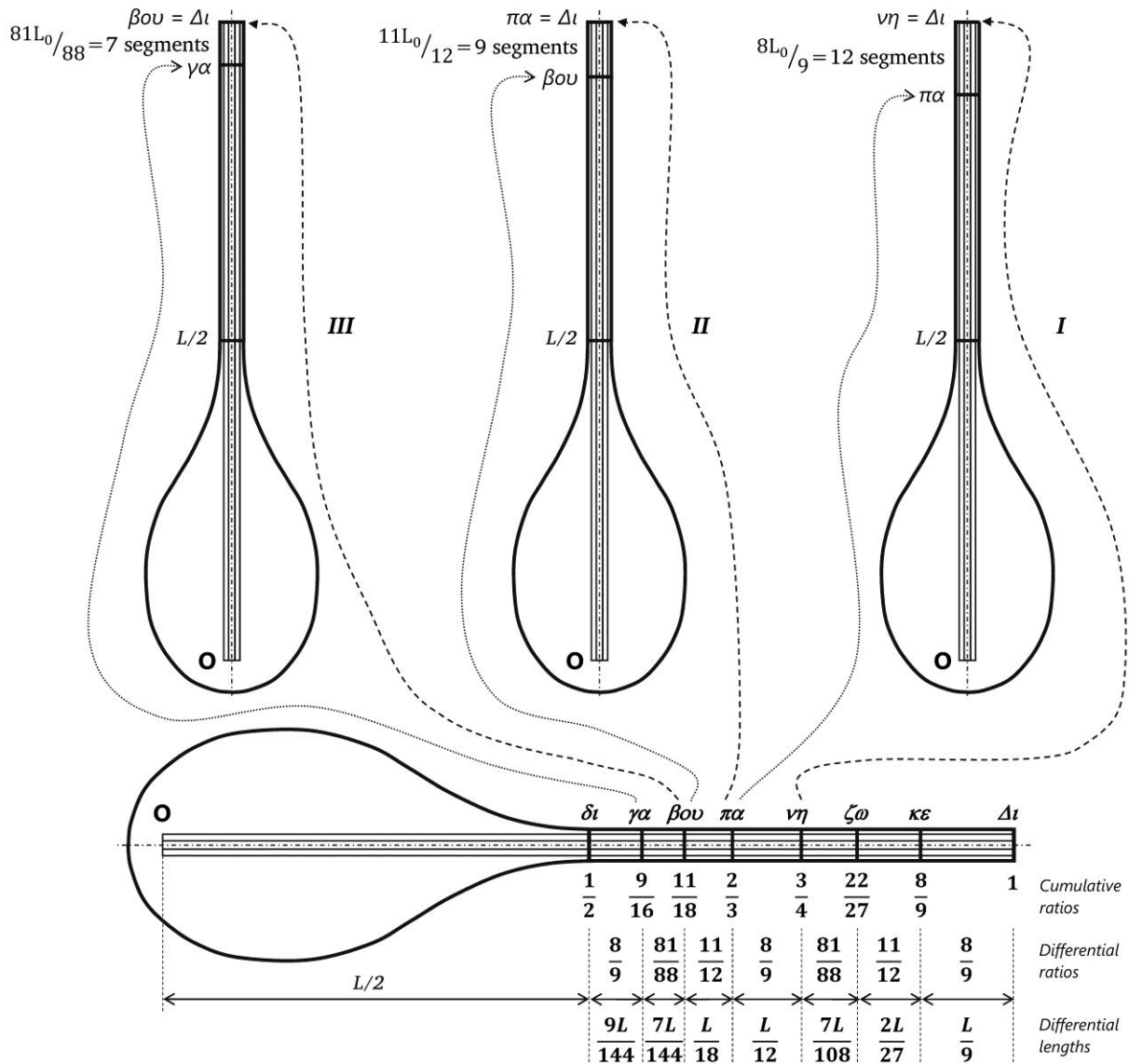

FHT 24 The procedure of the two *tunbūr*(s) as explained by Chrysanthos¹⁰⁵¹: “One could experience this truth this way: One takes two *pandourides*, one of which is not fretted, the other being fretted with the tones of our music as precisely as possible. He then makes the buzz [lowest note – of the free string] of the unfretted *pandouris* symphonous with the $\nu\eta$ of the fretted one and supposes that this buzz is the $\delta\iota$. He then plays on the fretted *pandouris* the $\pi\alpha$ and looks for its symphony on the unfretted *pandouris*. Wherever he finds it, he writes the $\kappa\epsilon$. He then divides this newly found interval $\delta\iota\ \kappa\epsilon$ into twelve sections¹⁰⁵². Then he makes the same buzz symphon[i]ous with the $\pi\alpha$ and plays the $\beta\upsilon\upsilon$, then he looks for its symphony and wherever he finds it, he writes the $\zeta\omega$ ¹⁰⁵³. He then makes the same buzz again symphon[i]ous with the $\beta\upsilon\upsilon$, plays the $\gamma\alpha$, looks for its symphony and wherever he finds it, he writes the $\nu\eta$ ¹⁰⁵⁴. Then he observes the newly written notes and finds out that the $\kappa\epsilon$ is written on the 12, the $\beta\upsilon\upsilon$ on the 9 and the $\gamma\alpha$ on the 7¹⁰⁵⁵.

¹⁰⁵¹ Translated and adapted from [Beyhom, 2015b, p. 195]: lengths on the vertical representations of the (2nd) *tunbūr* are approximate.

¹⁰⁵² Phase “I” in the figure.

¹⁰⁵³ Phase “II” in the figure.

¹⁰⁵⁴ Phase “III” in the figure.

¹⁰⁵⁵ [Chrysanthos (de Madytos) and Rōmanou, 1973, p. 89, note n° 3].

‘Arabān & Shadd-‘Arabān														
TIZ HİŞĀR											5 1/2	TIZ HİŞĀR		
TIZ NAWA												TIZ NAWA		
TIZ TĪK-ĤIJĀZ											6 1/2	4	TIZ TĪK-ĤIJĀZ	
TIZ ĤIJĀZ													TIZ ĤIJĀZ	
TIZ JAHĀRKĀ?													TIZ JAHĀRKĀ?	
TIZ JAHĀRKĀ?													TIZ JAHĀRKĀ?	
TIZ BŪSALĪK	5 1/2	Sĭkā									16	20	TIZ BŪSALĪK	
TIZ SĭKĀ													TIZ SĭKĀ	
????													????	
TIZ NAHAWAND	12	10	Ĥijāz (on d) I		Ĥiṣār Būsalĭk (rē)		‘Uṣṣāl		‘Ajām-Kurd(ī)		Ĥijāz (on d) II		TIZ NAHAWAND	
MUĤAYYAR													MUĤAYYAR	
MUĤAYYAR													MUĤAYYAR	
????													????	
TĪK-SĤĀHNĀZ	12	12	6 1/2	Nakrīz		6 1/2	12	12	Ĥijāz Zīrkūlā (c)				TĪK-SĤĀHNĀZ	
SHĀHNĀZ													SHĀHNĀZ	
KARDĀN													KARDĀN	
KARDĀN													KARDĀN	
????													????	
TĪK-AWJ	12	8	18	8	18	8	12	18	6 1/2	6 1/2	6 1/2	14	TĪK-AWJ	
AWJ													AWJ	
‘AJAM													‘AJAM	
????													????	
PES ‘AJAM	5 1/2	12	5 1/2	10	5 1/2	10	5 1/2	5 1/2	16	16	16	4	5 1/2	PES ‘AJAM
ĤUSAYNĪ													ĤUSAYNĪ	
????													????	
PES ĤUSAYNĪ					6 1/2								PES ĤUSAYNĪ	
BAYĀTĪ	12	10	12	12	12	12	12	12	7 1/2	7 1/2	7 1/2	12	12	BAYĀTĪ
HİŞĀR														HİŞĀR
NAWĀ														NAWĀ
???														???
ĤIJĀZ	12	12	6 1/2	6 1/2	18	6 1/2	12	6 1/2	12	6 1/2	12	12		ĤIJĀZ
JAHĀRKĀ														JAHĀRKĀ
HUZĀM ?		8	18	18	5 1/2	18	12	18	6 1/2	16	8	8		HUZĀM ?
SĭKĀ														SĭKĀ
ZAMZAMA														ZAMZAMA
NAHAWAND			5 1/2	5 1/2	12	5 1/2	5 1/2	5 1/2	16	7 1/2	10	10		NAHAWAND
DŪKĀ														DŪKĀ
ZĪRKŪLĀ					12				7 1/2	12				ZĪRKŪLĀ
RĀST														RĀST
????										6 1/2				????
											16			
BAYĀT(Ī)														BAYĀT(Ī)
YĀKĀ										7 1/2				YĀKĀ

FHT 25 Byzantine modes and degrees of the scale with Turkish-Arabian names – assembled from [Karas, 1989] (adapted and translated from [Beyhom, 2015b, p. 280]). Karas uses a 144-intervals division of the octave (effectively « halves » of the 1881 Music Committee *minutes*)¹⁰⁵⁶.

¹⁰⁵⁶ The Music Committee proposed a 72-ET division; other theoreticians, including 9th-10th-century Fārābī – see [Beyhom, 2010c, v. 1, p. 240, Tableau 16] – and [Misaelidis, 1902, v. 2, p. 12, 15 et 20] preceded the Committee with such a division; note that while Karas tries to model the *leimma* as 5,5, and the *apotome* as 6,5 Second Reform-minutes, this creates discrepancies in the position of some degrees of the scale (notably the MUĤAYYAR).

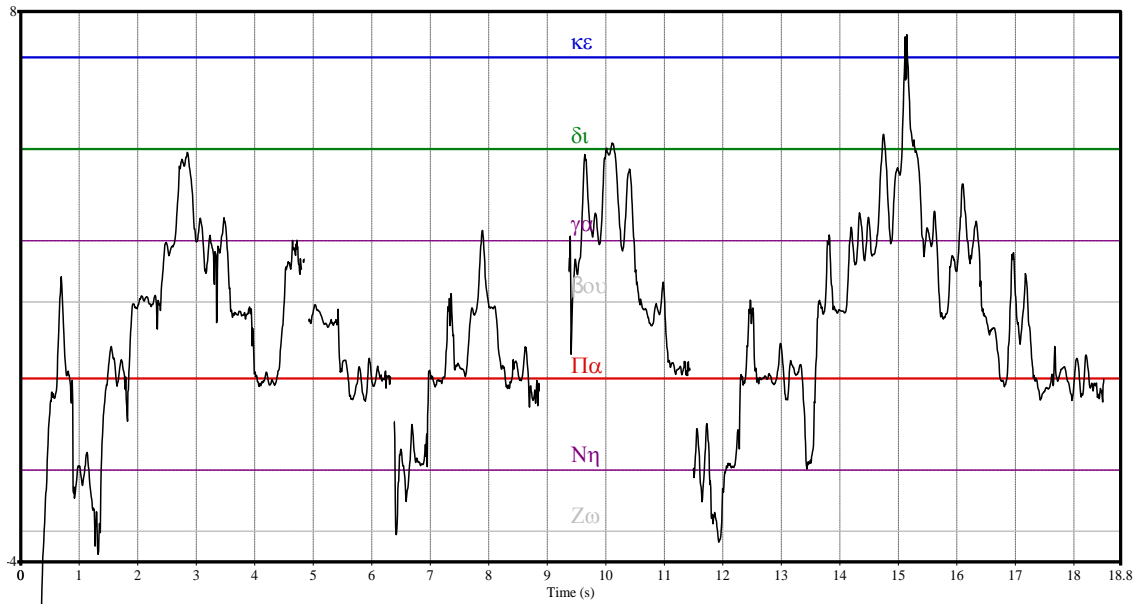

FHT 26 Tonometric analysis of Nicolas Malek's singing of *Kyrie Ekekraxa* in Arabic language, in the version of Lebanese composer and cantor Mitri Murr chant: "Byzantine" chant¹⁰⁵⁷. Vertical markings follow the theoretical degrees of the Second Reform of Byzantine chant (horizontal colored lines). There are no real differences in pitch for *e* (*βου*) between this "Byzantine" chant and the next, supposedly "ditonic" – see Slide No. 24 to listen to the animated analysis.

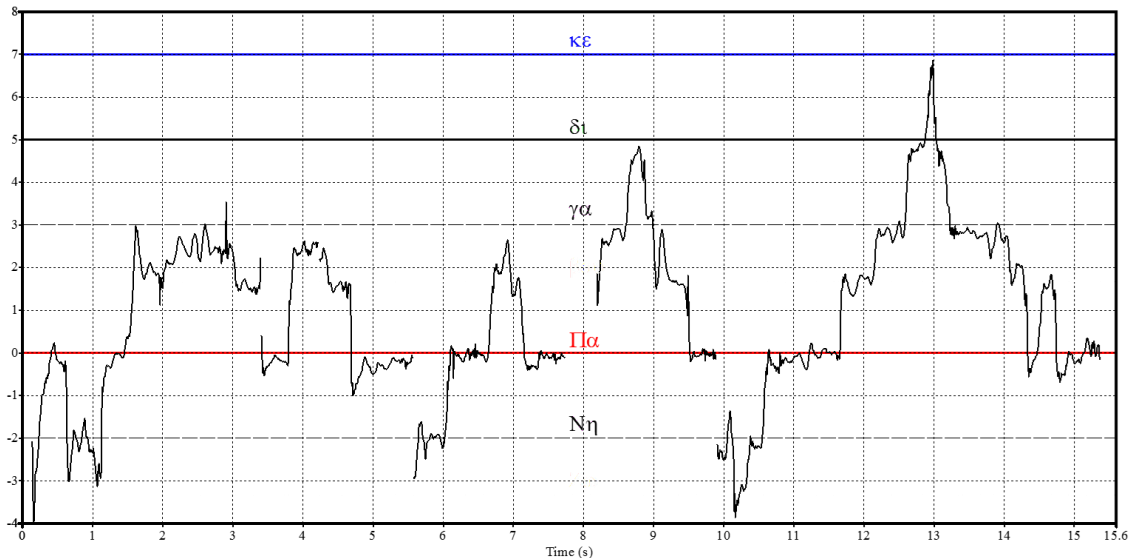

FHT 27 Tonometric analysis of Nicolas Malek's singing of *Kyrie Ekekraxa* in Arabic language, in the version of Lebanese composer and Cantor Mitri Murr: "Ditonic" (?) chant¹⁰⁵⁸.

¹⁰⁵⁷ From [Beyhom, 2015b].

¹⁰⁵⁸ From [Beyhom, 2015b]: all vertical markings are in successive semitones, with corresponding (matching) degrees of the Byzantine 72-ET scale shown. There is no real difference in pitch for *e* (*βου*) and of *b* (*ζω*) between this "ditonic" chant and the former, supposedly "Byzantine", these degrees being lowered in both versions. This chant ("ditonic") was characterized by French ethnomusicologist Jean Doring, upon listening during a presentation at the CREM (Centre de Recherche en Ethnomusicologie – CNRS-France), as (resembling) "a Gregorian chant". This analysis shows the limit of Pitch measurements, i.e. that Pitch (and Music) perception is not only frequency- or formula-dependent, but may depend on other characteristics including sound timbre, volume, interval (relative) proportions, pitch ornamentation (in the previous analysis) or voice placement and / or stability, which are all different in these two analyses – see Slide No. 25 to listen to the animated analysis for this version.

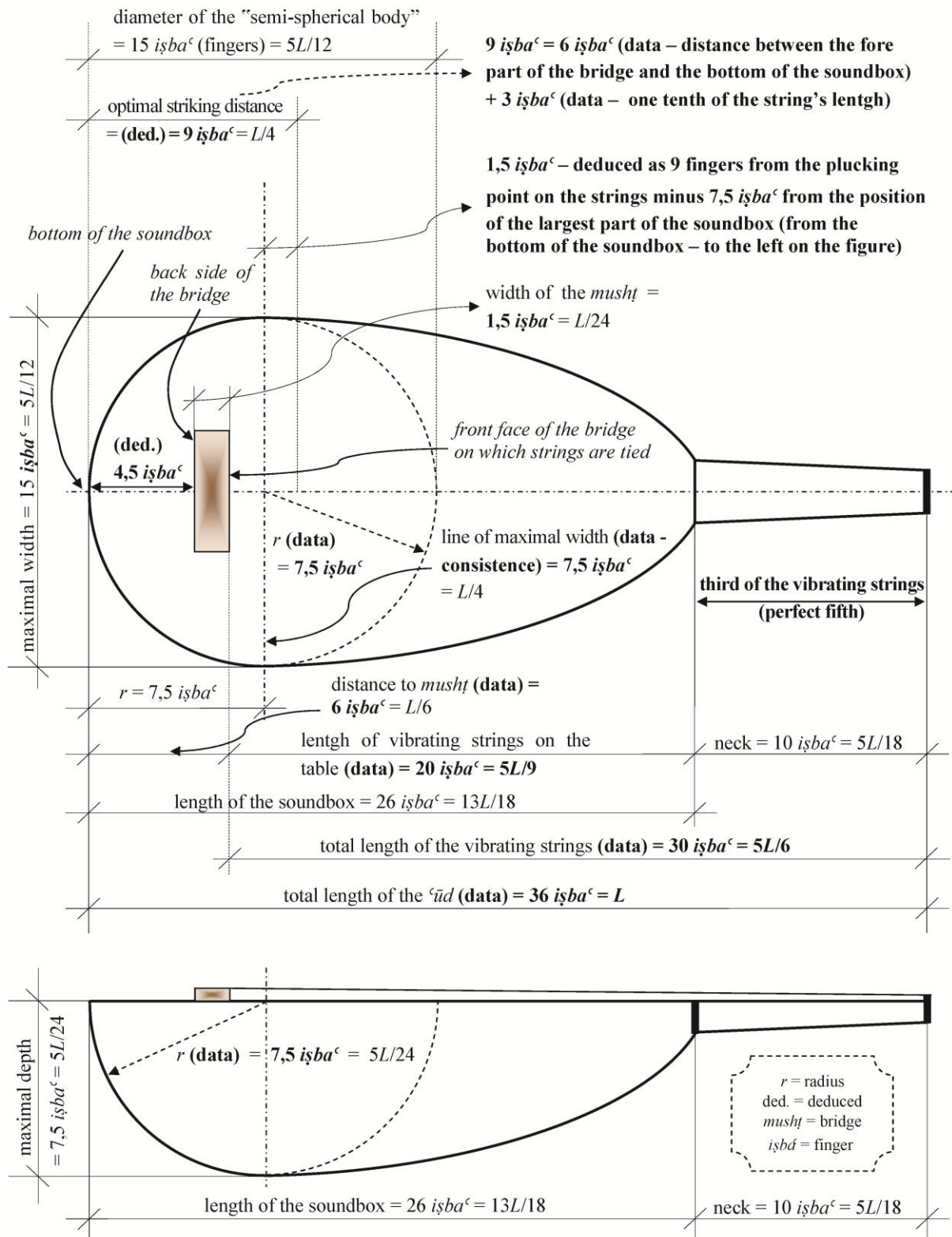

FHT 28 (Al-) Kindi's description of the 'ūd, in "finger (*ishba^c-aṣābi*)" thicknesses" measurements, and deduced (calculated) proportions¹⁰⁵⁹. The same procedure is used for the "Harmonic mesh" shown on the next figure.

¹⁰⁵⁹ First published in [Beyhom, 2011].

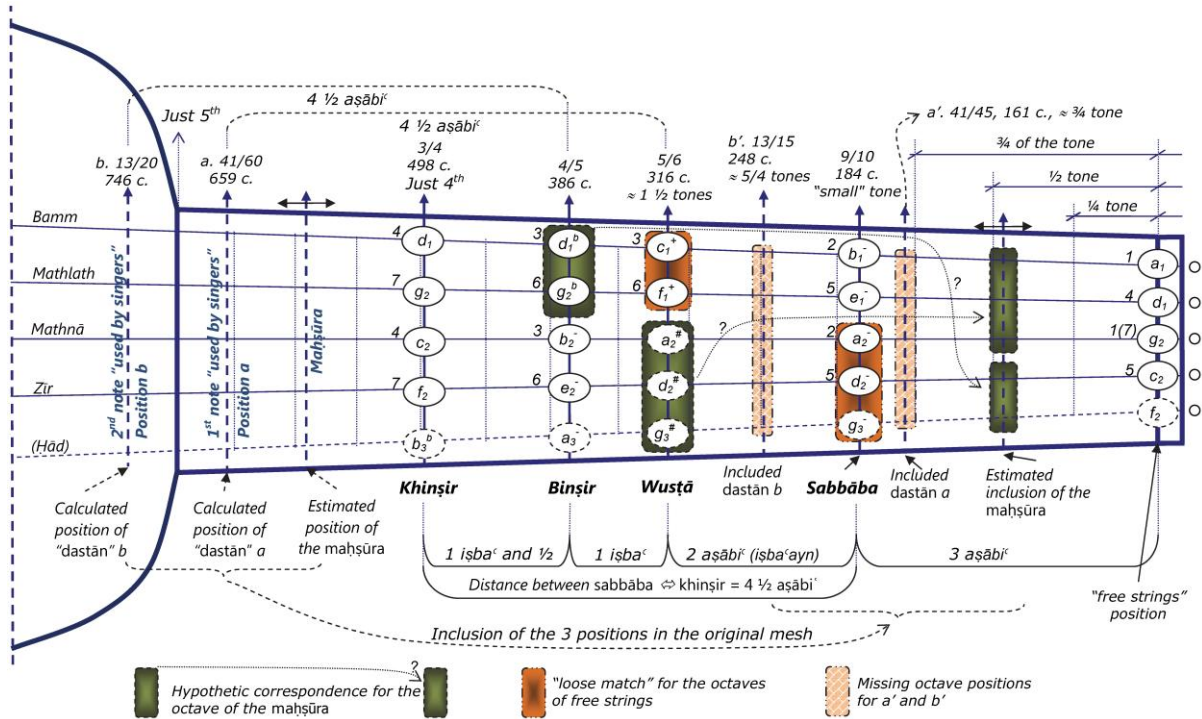

FHT 29 “Harmonic” mesh of the ‘ūd’s fingerboard with Kindī’s indications on the “supplementary notes”, an alternative mesh described by Kindī and totally ignored, for the praxis part, by Pythagorean musicologists.

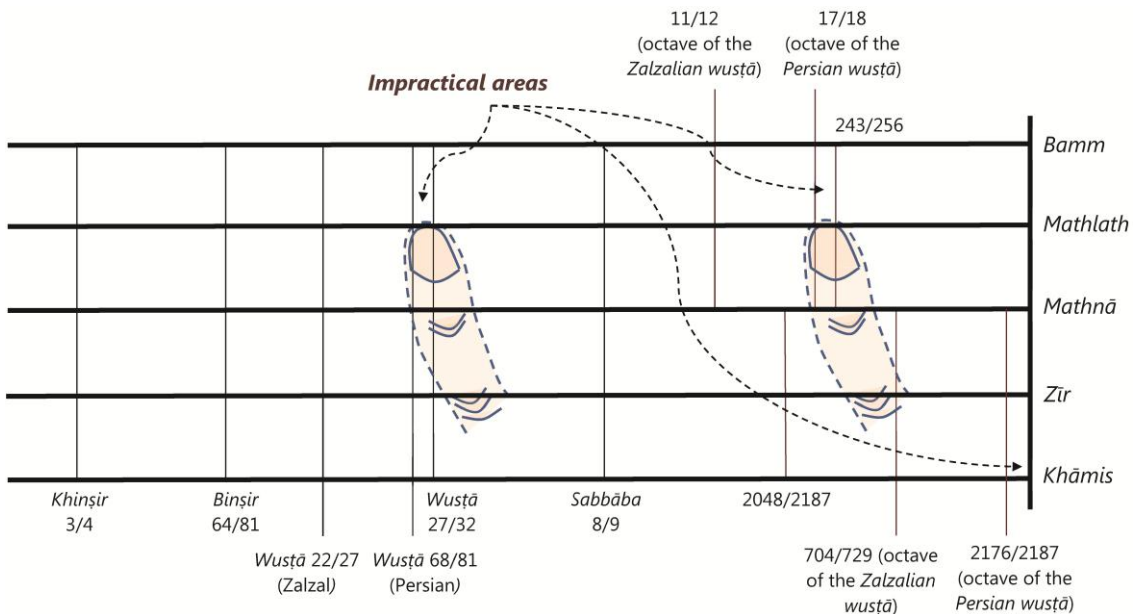

FHT 30 Impractical areas appear if including the octave equivalences for the scale of (al-) Fārābī: most musicologists maintain that the Early Arabian ‘ūd was “fretted” notwithstanding the complex meshing described by the Arabian theoreticians, and forgetting (or overlooking) the fact that some of the positionings are alternative positionings, as here for the wustā(s)¹⁰⁶⁰.

¹⁰⁶⁰ This figure and the previous are adapted and translated from [Beyhom, 2010c, v. 1, p. 175, 357]: virtual fingers reproduced in FHT 30 are approx. 1 cm wide.

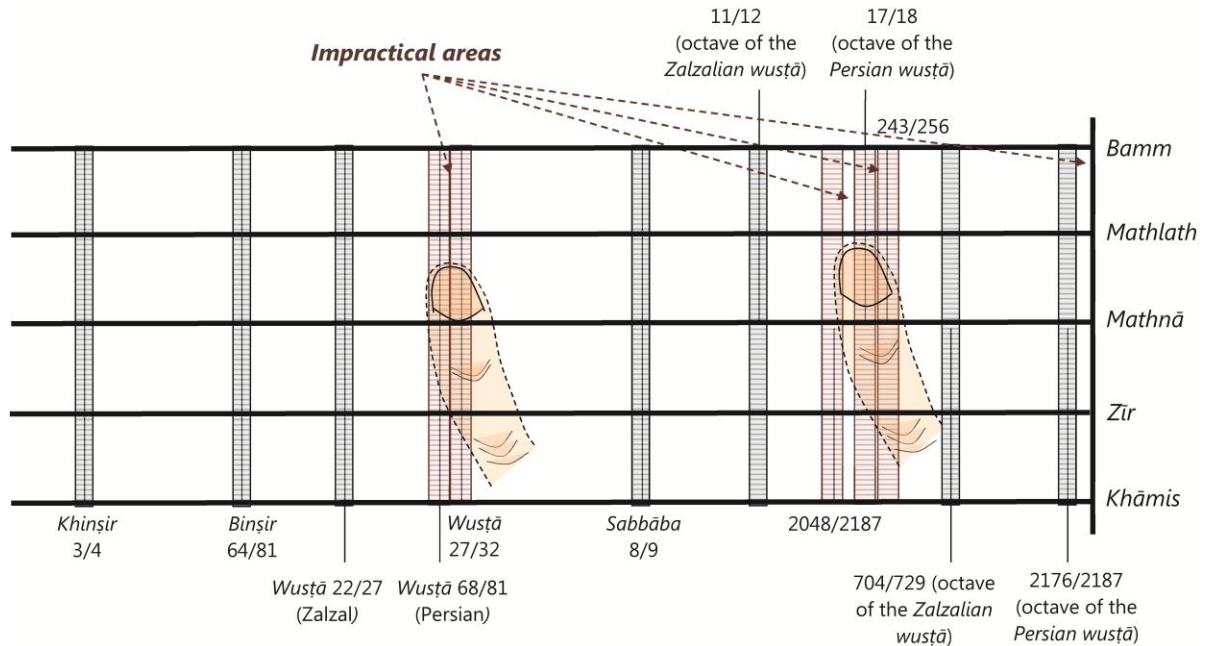

FHT 31 In the case of effective “fretting” (tying of strings around the neck of the ‘ūd) – here for the meshing of (al-) Fārābī, medium double-ties 1mm thick would nearly overlap on the fingerboard, making it impossible to play in some areas; using (al-) Kindī’s ties would lead, in the case of Fārābī’s meshing, to a clear impossibility of performance¹⁰⁶¹ (see the following figure).

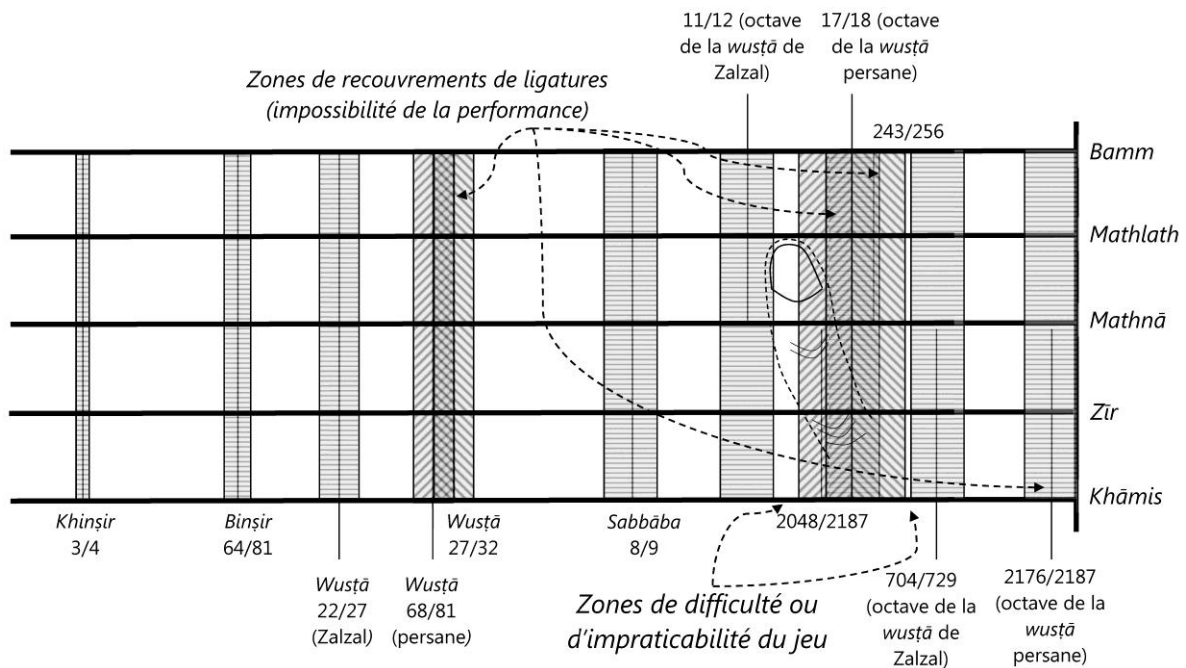

FHT 32 Figure 129 from [Beyhom, 2010c, v. 1, p. 358] showing Fārābī’s meshing with overlapping “frets” in case ties are notted around the neck of the ‘ūd following Kindī’s indications; note that Kindī was the only theoretician who described the “physical” ties (most probably for beginners) giving decreasing proportions (thicknesses) from the nut and in the direction of the bridge – the number of ties he described was however limited to four.

¹⁰⁶¹ Adapted and translated from [Beyhom, 2010c, v. 1, p. 358].

APPENDIX 1: HOW TO PRODUCE ARISTOXENOS' HALF-TONE

In *Appolo's Lyre*, Thomas Mathiesen¹⁰⁶² reports a closing discussion in Aristoxenos' Book I of the *Elementa Harmonica*:

"Aristoxenos is most interested in the ditone and the small interval that represents the difference between the fourth and the ditone [with a footnote included stating: "For Aristoxenos, the ditone is equivalent to two whole-tones; for the Pythagoreans, it is expressed as the ratio 81:64. The excess of the fourth over the ditone is commonly called the 'leimma' in Pythagorean treatises, expressed by the ratio 256:243; for Aristoxenos, it is a 'half-tone'"] because, as these are the principal dissonant intervals within the tetrachord, they are the most important in actual musical phenomena. He first proceeds to demonstrate the location of a ditone through the use of ascending and descending fourths and fifths. No notes are named because the procedure can be applied at any point. If, for example, one moved through the sequence e'-a'-d'-g'-c', the ditone e'-c' would be determined. Likewise, the small dissonant interval that represents the excess of a fourth over a ditone can be measured and identified by positing, for example, the fourth e'-a' and moving through the sequence a'-d'-g'-c'-f to produce the half-tone e'-f. Such a demonstration in a discussion of scales may at first seem incongruous, but Aristoxenos intends to use these dissonant intervals as part of the explanation of his smallest scale, the tetrachord. On two earlier occasions (*De principiis*, section XIV; *Elementa*, section III), he casually asserted that the interval of the tetrachord, the fourth, equals two-and-a-half tones. Recognizing that this assertion cannot be supported by Pythagorean mathematics and quite correctly anticipating criticism on this point from subsequent theorists, he applies the technique of the preceding demonstration as an explanation, given entirely in prose, without the aid of any note names, diagrams, or symbols. Nevertheless, figure 53 [adapted in this dossier as FHT 34, p. 201] can be easily constructed as an illustration of his argument".

The author continues explaining Aristoxenos' implementation of the "half-tone" (see FHT 34):

"First, the interval of a fourth, A-D, is hypothesized, and then, one ditone B-D is located below D, the upper pitch of the fourth, while a second ditone A-C is located above A, the lower pitch of the fourth. The remainders A-B and C-D must be equal excesses of the fourth over the ditone because the ditones are equal. A second set of fourths, X-C and B-Y, is then taken by consonance, and the excesses X-A and D-Y must be equal because they have been produced by equal extensions in opposite directions. The large interval, X-Y, that now

results must be evaluated by sense. If the result is dissonant, the fourth is not equal to two-and-a-half tones, but if it is adjudged to be a fifth, the fourth must be equal to two-and-a-half tones, Aristoxenos argues, for the following reason. By definition (section III/B), a fifth is larger than a fourth by one whole-tone; as the excesses of a fifth over a fourth, X-B and C-Y are whole-tones; X-A, A-B, C-D, and D-Y are equal because in every case they represent the excess of a fourth over a ditone/ which is, by the preceding demonstration, equal to two whole-tones; the whole-tones X-B and C-Y are divided into the equal half-tones, X-A, A-B, C-D, and D-Y; therefore, the fourth equals two-and-a-half tones. Anticipating questions about the initial condition, Aristoxenos notes that the interval X-Y cannot be a fourth because it is the result of extension in both directions beyond the initial dimension of a fourth; as the extensions X-A and D-Y were less than a tone, it is evident that the sum cannot be as large as an octave; the only consonant magnitude between the fourth and the octave is the fifth; therefore, if the interval X-Y is consonant, it must be a fifth".

Mathiesen concludes on this point:

"Objections to Aristoxenos's demonstration can be raised on various mathematical grounds, some of which appear in the Euclidean *Sectio canonis* and the treatises of Theon of Smyrna¹⁰⁶³, Ptolemy, and Boethius¹⁰⁶⁴. Aristoxenos, by

¹⁰⁶³ The only English translation of Theon's *Mathematics useful for understanding Plato* I know of is [Theon and Toulis, 1979], translated from the French translation by Dupuis ([Théon de Smyrne and Dupuis, 1892]); whenever translations from Ancient Greek may already differ in (detailed) contents, due to the difficulties for interpreting specific technical terms or phrasings, I prefer here to hold to the French, with the following quote which may be of interest: "VIII. Le demi-ton [*limma* in Theon's vocabulary] n'est pas ainsi appelé parce que ce serait la moitié d'un ton, comme le pense Aristoxène, de la même manière que la demi-coudée est la moitié de la coudée : mais parce que c'est un intervalle musical moindre que le ton, de la même manière que nous appelons certaine lettre semi-voyelle, non parce qu'elle fait entendre la moitié d'un son, mais parce qu'elle ne fait pas entendre complètement le même son. On démontre, en effet, que le ton, considéré dans la raison sesquioctave (9/8), ne peut pas plus se partager en deux parties égales que tout autre intervalle sesquipartiel, car 9 n'est pas divisible par 2" – in [Théon de Smyrne and Dupuis, 1892, p. 89]; this is in total contradiction with Aristoxenos' discourse, namely [Aristoxenos and Ruelle, 1870]: "70. Maintenant que cela est connu, il faut tâcher de définir l'intervalle tonié. Le ton est la différence des deux premiers consonnants [c'est-à-dire de la quarte et de la quinte], sous le rapport de la grandeur. 71. On le divisera de trois manières; car on chante musicalement la moitié, le tiers et le quart du ton, et les intervalles plus petits que ceux-là ne peuvent se chanter musicalement. 72. On appellera la plus petite [de ces divisions] diésis enharmonique minime, la seconde, diésis chromatique minime, et la plus grande, demi-ton" (comparing with the English equivalent from [Aristoxenos and Macran, 1902, p. 199] is a good exercise for readers fluent in both French and English: "A tone is the excess

¹⁰⁶² All quotes for the introduction in this appendix are taken from [Mathiesen, 1999, p. 327–329].

background and training, would certainly have been aware of these objections, but here, as elsewhere in *De principiis* and the *Elementa*, his demonstration is neither mathematical nor empirical. Rather, it is cast in a totally new spatial logic that mathematical objections cannot address, and although it is possible to test the demonstration on a monochord with reasonable results, the empirical validity is less important than the demonstration's conceptual idealization".

In the present appendix, I would, as many of my predecessors¹⁰⁶⁵ did, elaborate on Aristoxenos' half-tone implementation.

Aristoxenos' text and interpretations

Firstly let us re-read Aristoxenos' (more or less) original text, here in Macran's translation¹⁰⁶⁶:

"The surest method of verifying our original assumption that the fourth consists of two and a half tones is the following. Let us take such an interval, and let us find the discord of two tones above its lower note, and the same discord below its higher note. Evidently the complements will be equal, since they are remainders obtained by subtracting equals from equals. Next let us take the fourth¹⁰⁶⁷ above the lower note of the higher ditone, and the fourth below the higher note of the lower ditone. It will be seen that adjacent to each of the extreme notes of the scale thus obtained there will be two complements in juxtaposition, which must be equal for the reasons already given. This construction completed, we must refer the extreme notes thus determined to the judgement of the ear. If they prove discordant, plainly the fourth will not be composed of two and a half tones; and just as plainly it will

→

of the fifth over the fourth; the fourth consists of two tones and a half. The following fractions of a tone occur in melody: the half, called a semitone; the third, called the smallest Chromatic diesis; the quarter, called the smallest Enharmonic diesis. No smaller interval than the last exists in melody". For Latin and Old Greek readers, the following edition of Theon is available at www.archive.org: [Theon and Hiller, 1878].

¹⁰⁶⁴ cf. for example [Boethius, 2004, p. 168–221].

¹⁰⁶⁵ Including the above mentioned Theon of Smyrna, Ptolemaos and Boethius, but also (al-) Fārābī (who also criticized Aristoxenos on this matter); for a modern *exposé* of this problematic, see [Litchfield, 1988, p.61–65], who concludes: "The crux of [Aristoxenos'] proof is whether the fifth is a full perfect fifth. In concept, there is no reason to admit this interval as anything but a fifth; in practice, however, it does not sound like a fifth. Had Aristoxenos performed this proof, he would surely have heard the discrepancy, as would any other musician used to manipulating the monochord".

¹⁰⁶⁶ Compare with FHT 34, p. 201.

¹⁰⁶⁷ I have replaced Upper case quotes by Lower case ones for consistency, noticeably for intervals such as the fourth, the fifth and the octave.

be so composed, if they form a fifth. For the lowest of the assumed notes is, by construction, a fourth of the higher boundary of the lower ditone; and it has now turned out that the highest of the assumed notes forms with the lowest of them the concord of the fifth. Now as the excess of the latter interval over the former is a tone, and as it is here divided into two equal parts; and as each of these equal parts which is thus proved to be a semitone is at the same time the excess of the fourth over a ditone, it follows that the fourth is composed of five semitones. It will be readily seen that the extremes of our scale cannot form any concord except a fifth. They cannot form a fourth; for there is here, besides the original fourth, an additional complement at each extremity. They cannot form an octave; for the sum of the complements is less than two tones, since the excess of the fourth over the ditone is less than a tone (for it is universally admitted that the fourth is greater than two tones and less than three); consequently, the whole of what is here added to the fourth is less than a fifth; – plainly then their sum cannot be an octave. But if the concord formed by the extreme notes of our construction is greater than a fourth, and less than an octave, it must be a fifth; for this is the only concordant magnitude between the fourth and octave"¹⁰⁶⁸.

PYTHAGOREAN INTERPRETATION

A restricted Pythagorean interpretation of this description (FHT 35, p. 201) imposes the use of ditonic "ditones" (or $(8/9)^2$) which give, when subtracted from the fourths, *leimma* intervals¹⁰⁶⁹ (with ratio $243/256$) as boundary "half-tones". Applying the successive steps described by Aristoxenos changes not the value of the initial fourth A-D, presumably "concordant" with ratio $3/4$, but the value of the fifth X-Y which cannot be just as it is equal to a fourth + 2 *leimmata*, which is one (Pythagorean¹⁰⁷⁰) *comma* short of the Just (with ratio $2/3$) fifth.

¹⁰⁶⁸ [Aristoxenos and Macran, 1902, p. 207–208].

¹⁰⁶⁹ For example, on FHT 35, p. 201, when for step 2 the ditone B-D is subtracted from the initial fourth A-D, with the resulting *leimma* A-B.

¹⁰⁷⁰ i.e. a Pythagorean tone from which we deduce two *leimmata* or $8/9 \times \left(\frac{256}{243}\right)^2 = \frac{524288}{531441}$, a rather complicated ratio.

Note here that my definition of the Pythagorean *comma* is not a Classical (Occidental) definition, this interval being preferably described as "1) the difference between two enharmonically equivalent notes in a Pythagorean scale, such as C and B[♭], 2) the difference between a Pythagorean *apotome* and a Pythagorean *leimma*, 3) the difference between twelve just perfect fifths and seven octaves and 4) the difference between three Pythagorean ditones (major thirds) and one octave"; the *New Grove* definition retains only the third case, namely "the difference between twelve 5^{ths} and seven octaves" – see [Anon. "Pythagorean comma", 2015] and [Greated, 2001].

EQUAL-TEMPERAMENT INTERPRETATION

Applying these steps with an equal-tempered (semi-tonal) logic (FHT 36, p. 202), the fourths will be of 500 cents (the tone being 200 cents) and the boundary deducted half-tones are each 100 cents, or exact (equal-tempered) half-tones. The resulting value of the fifth X-Y's value in this scheme is 700 cents, a tempered "Just" fifth, which is one main reason why Aristoxenos' theories are reputed to be based on equal-temperament.

ALTERNATIVE INTERPRETATION BASED ON SUPERPARTICULAR INTERVALS

However, there exists (at least) one other possibility for halving the Pythagorean tone, based on the assumption that Aristoxenos, who knew well Pythagorean theories but wanted to oppose his "judgment of the ear" to their mathematical approach, would express his theories without explicitly using Pythagorean mathematics while implicitly relying on them to be sure their criticism could be deflected, if not avoided.

For the case of the "exact" half-tone, he would use the two formulations of the Pythagorean "semi-tones" closest to an "exact" half of a Pythagorean tone, *i.e.* the superparticular ratios 16/17 and 17/18 (see FHT 33, p. 200 and FHT 57, p. 221¹⁰⁷¹) and find the mean ratio of the two (33/35¹⁰⁷²) in order to use it as an "Exact Pythagorean half-tone" (see FHT 37, p. 202).

¹⁰⁷¹ 16/17 and 17/18 continue the progression shown on FHT 57, p. 221; their addition gives an exact Pythagorean tone 8/9. 17/18 (see FHT 33, p. 200) is 6 cents short from an "Exact" half of the Pythagorean tone, whenever 16/17 is a little (6 cents also) greater than it: the sum of the differences amounts to zero.

¹⁰⁷² This is a Classical Pythagorean procedure: the values of 16/17 and 17/18, when both numerators and denominators are doubled (*i.e.* 32/34 and 34/36), do not change.

32/34 is the same as $\frac{32}{33} \times \frac{33}{34}$ (33 being the arithmetic mean of 32 and 34); similarly, 34/36 is equal to $\frac{34}{35} \times \frac{35}{36}$ (35 being the arithmetic mean of 34 and 36).

The ratio of the two arithmetic means 35/36 is the "half" of the intervals 32/34 and 34/36. The procedure is described in various literature on Greek theories, including by Arabian authors such as (ibn) Sīnā (see [Beyhom, 2010c, v. 1, p. 247–248]). The same procedure applied to the 8/9 interval (Pythagorean tone) gives the 16/17 and 17/18 intervals.

The resulting X-Y interval¹⁰⁷³ (ratio 3267/4900) is close enough to the "exact" Pythagorean fifth with ratio 2/3, the difference (ratio 9800/9801) amounting to less than a fifth of a cent¹⁰⁷⁴.

The main difference lies in the tones internal to the fourth A-D, the ditones A-C and B-D having a ratio of 35/44 (or 396 cents); this is however compatible with the formulation of the ditones as composed of the 7/8¹⁰⁷⁵ and the 10/11¹⁰⁷⁶ (with superparticular ratios)¹⁰⁷⁷ tones used in Pythagorean representations of the diatonic *genera* (see FHT 3, p. 181)¹⁰⁷⁸.

* *
* *

¹⁰⁷³ Which is calculated as $\frac{3}{4} \times \left(\frac{33}{35}\right)^2 = \frac{3267}{4900}$, the difference with the Just fifth being equal to $\frac{2}{3} \times \frac{4900}{3267} = \frac{9800}{9801}$, a very small ratio indeed.

¹⁰⁷⁴ Knowing that significant differences in pitch perception begin with 1-2 cents (for trained, specialized musicians, instrument makers, etc.), a difference of one fifth of a cent (0.2 cent) is not perceptible by the ear, which is in agreement with Aristoxenos' approach of music.

¹⁰⁷⁵ Approx. 231 cents.

¹⁰⁷⁶ Approx. 165 cents.

¹⁰⁷⁷ 7/8 and 10/11, when added, give the ratio $\frac{35}{44}$.

¹⁰⁷⁸ This procedure is not, nonetheless, in agreement with the Aristoxenian statements that a (Just?) fourth should be equal to 5 half-tones (five half-tones are here 11 cents greater than the Just fourth – see FHT 38, p. 203), or a (Just?) fifth be equal to 7 half-tones, the latter being here also 11 cents greater than the former (FHT 39, p. 203); which leaves us wanting for more documentation on the subject (should it be discovered some day) and further philological interpretations of the extant texts.

Plates for Appendix 1

Value of the 1/2-tone				Tone, with the Pythagorean Tone = 203,910				
ratio	eq. ratio	dec.	cents	ratio	eq. ratio	dec.	cents	diff.
33/35	33/35	0,943	101,867	1089/1225	8/9	0,943	203,733	0,177
16/17	16/17	0,941	104,955	256/589	256/289	0,941	209,911	-6,001
32/34				1024/1156				
17/18	17/18	0,944	98,955	289/324	289/324	0,944	197,909	6,001
34/36				1156/1296				
610/647	610/647	0,943	101,948	$\frac{372100}{418609}$	8/9	0,000	203,896	0,014

FHT 33 Using the 33/35 “half-tone”, being the mean of the superparticular ratios 16/17 and 17/18 which, when added (when their ratios are multiplied), give the exact Pythagorean tone $8/9^{1079}$.

¹⁰⁷⁹ In the table: “diff.” is the difference (in cents) between the exact Pythagorean tone 8/9 and the tones calculated as the interval in the first column doubled; “eq. ratio” is the ratio when it is reduced to three digits for both numerator and denominator, which is the limit in Excel (which I use, along with a small FORTRAN program I devised for my thesis in 2000-2003, for interval calculations and ratio reduction). The results for the latter are either reductions, or simplifications by replacement with the closest equivalent (within the limit of three digits). For example, the closest (up to three digits) evaluation of the 1089/1225 ratio (which is equal to the doubled 33/35 ratio, i.e. two similar “half-tones” added together) is the Pythagorean 8/9 tone.

I. Aristoxenos' explanations about the half-tone

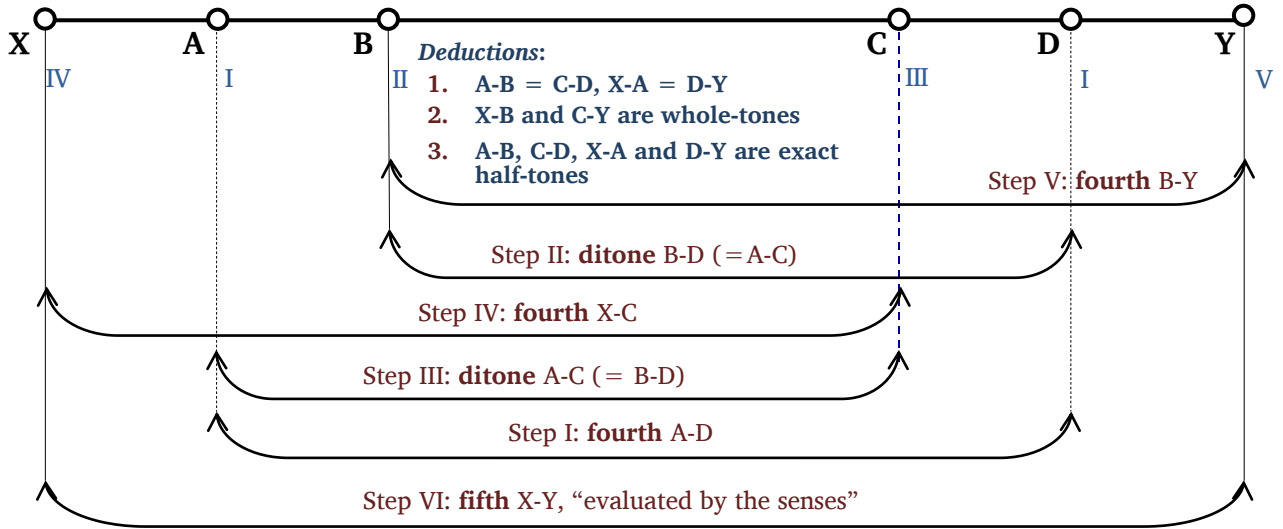

FHT 34 Determining the value of the half-tone in Aristoxenos' *Elementa harmonica* – non-proportional scheme, appended from Fig. 53 in [Mathiesen, 1999, p. 328].

II. Pythagorean (*Sectio canonis*) application for the determination of Aristoxenos' half-tone

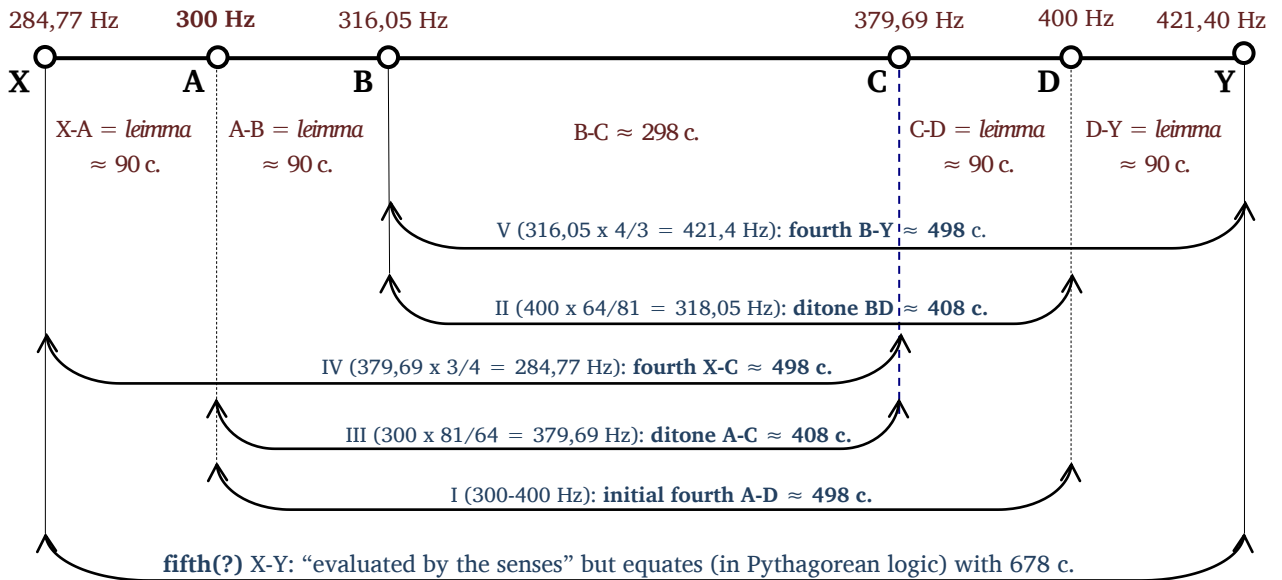

FHT 35 Applying Pythagorean logic for the determination of the value of the half-tone in Aristoxenos' *Elementa Harmonica*¹⁰⁸⁰.

¹⁰⁸⁰ A-B, C-D, X-A and D-Y are (equal) *leimma*(s) and the fifth X-Y is 24 cents (one Pythagorean *comma*) short (from $\approx 702 \text{ c.}$, with \approx standing for "approximately equal to"); basis pitch A is chosen at 300 Hz frequency, and the corresponding intervals can be listened to on Slide No. 11. Note that this interpretation does not fit Aristoxenos' description (with the deduction that A-B, C-D, X-A and D-Y must be "Exact half-tones").

III. Equal-temperament application for the determination of Aristoxenos' half-tone

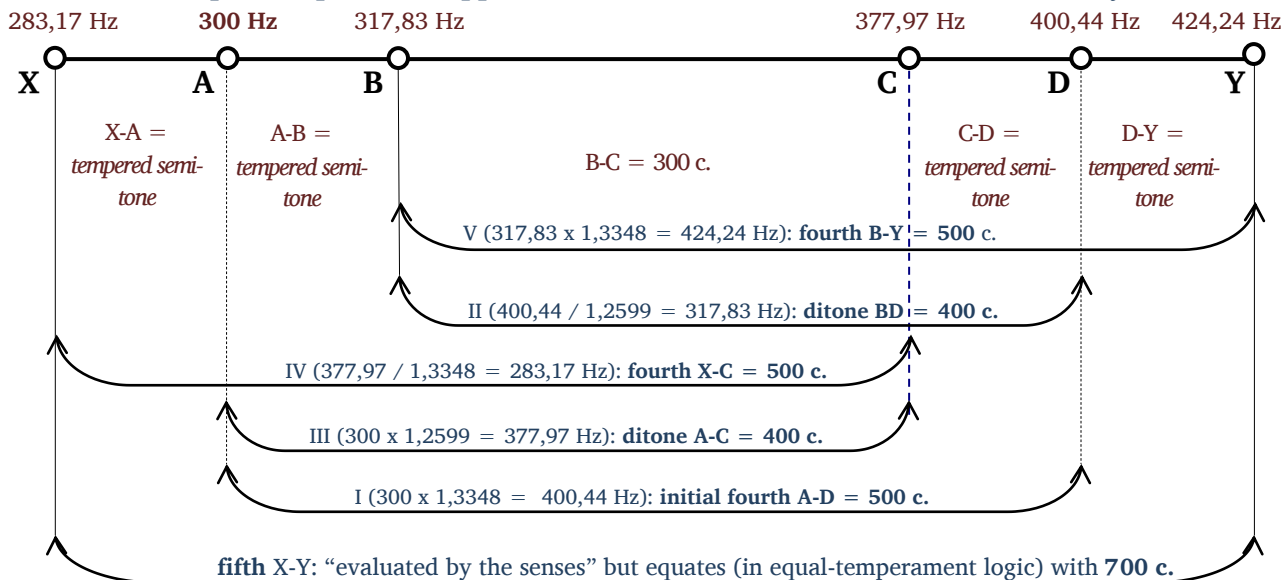

FHT 36 Applying Equal-temperament logic for the determination of the value of the *half-tone* – all intervals are tempered on an equal-semitone basis and match their equal-tempered values (see Slide No. 12).

IV. Dividing the Pythagorean disjunctive tone in two exact half-tones

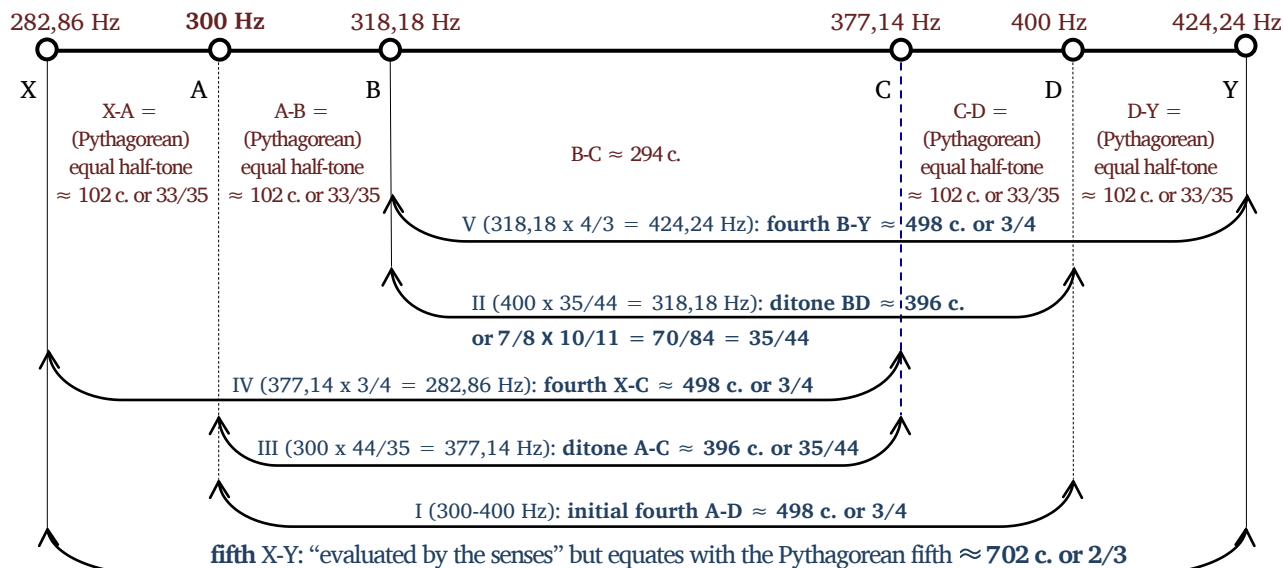

FHT 37 Applying (almost) perfect equality of the “half-tones” to the determination of the *half-tone*¹⁰⁸¹.

¹⁰⁸¹ A-B, C-D, X-A and D-Y are (acoustically) equal (Pythagorean) half-tones with a “just” fifth X-Y and “just” fourths A-D, B-Y and X-C (in the Pythagorean acceptance); the ditones B-D and A-C are each half a (Pythagorean) *comma* (i.e. 12 c.) short of the Pythagorean equivalents (see Slide No. 13). The resulting fifth’s X-Y ratio is equal to 3267/4900 (or 0.666673), close enough to 2/3 (or 0.666667), with a difference of (701.955 – 701.778 =) 0.18 cents (ratio 9800/9801). This procedure is not, however, in agreement with the Aristoxenian statements that a (Just?) fourth should be equal to 5 half-tones (five half-tones are here 11 cents greater than the Just fourth – see FHT 38, p. 203), or a (Just?) fifth be equal to 7 half-tones, the latter being here also 11 cents greater than the former (FHT 39, p. 203); cf. [Winnington-Ingram, 1932, p. 199]: “In a passage already noted [...] Aristoxenus grudgingly admits that the ditone may be slightly less than eight times the enharmonic quarter-tone. That is, the semitone is slightly more, not slightly less, than the equal semitone”.

Fourth 3/4 = 5 half-tones								
Value of the 1/2-tone / as Just Fourth/5 → 99,609					Value of the Fourth → Just Fourth = 498,045			
ratio	eq. ratio	decimal	cents	difference	eq. ratio	decimal	cents	difference
33/35	33/35	0,942857	101,867	-2,258	535/718	0,745126	509,333	-11,288
331/351	331/351	0,943020	101,568	-1,959	44/59	0,745769	507,839	-9,794
332/352	83/88	0,943182	101,271	-1,662	156/209	0,746409	506,353	-8,308
333/353	333/353	0,943343	100,975	-1,366	316/423	0,747047	504,876	-6,831
334/354	167/177	0,943503	100,682	-1,073	403/539	0,747680	503,408	-5,363
335/355	67/71	0,943662	100,390	-0,781	443/592	0,748311	501,948	-3,903
336/356	84/89	0,943820	100,099	-0,490	176/235	0,748939	500,496	-2,451
337/357	337/357	0,943978	99,811	-0,202	428/571	0,749563	499,053	-1,008
338/358	169/179	0,944134	99,524	0,085	3/4	0,750185	497,618	0,427

FHT 38 Successive approximations of the half-tone ratio, beginning with the 33/35 ratio used for the half-tone in FHT 37 and being the “arithmetic mean” of ratios 16/17 and 17/18, towards 17/18 in order to achieve a better approximation of the Just fourth considered as composed of 5 half-tones; the best approximation with this procedure (begin with the numerator and denominator both multiplied by 10, i.e. 330/350, then add 1 to each and so on until reaching the least difference with the Just fourth), limited to three integer digits, is ratio 338/358 (equivalent to 169/179). Note that “equivalent ratio 3/4” (sixth column, last row) is here a simplification, not a reduction.

Fifth 2/3 = 7 half-tones								
Value of the 1/2-tone / as Fifth/7 → 100,279286					Value of the Fifth → Just = 701,955			
ratio	eq. ratio	decimal	cents	cents	eq. ratio	decimal	cents	difference
33/35	33/35	0,942857	101,867	-1,587	414/625	0,662401	713,067	-11,112
331/351	331/351	0,943020	101,568	-1,288	319/481	0,663202	710,974	-9,019
332/352	83/88	0,943182	101,271	-0,991	83/125	0,664000	708,894	-6,939
333/353	333/353	0,943343	100,975	-0,696	355/534	0,664793	706,826	-4,871
334/354	167/177	0,943503	100,682	-0,402	205/308	0,665583	704,771	-2,816
335/355	67/71	0,943662	100,390	-0,110	2/3	0,666370	702,727	-0,772
336/356	84/89	0,943820	100,099	0,180	457/685	0,667152	700,694	1,261
337/357	337/357	0,943978	99,811	0,469	352/527	0,667931	698,674	3,281
338/358	169/179	0,944134	99,524	0,756	109/163	0,668707	696,665	5,290

FHT 39 Successive approximations of the half-tone ratio, beginning with the 33/35 ratio used for the half-tone in FHT 37 and being the “arithmetic mean” of ratios 16/17 and 17/18, towards 17/18 in order to achieve a better approximation of the Just fifth considered as composed of 7 half-tones; the best approximation with this procedure (begin with the numerator and denominator both multiplied by 10, i.e. 330/350, then add 1 to each and so on until reaching the least difference with the Just fifth), limited to three integer digits, is ratio 335/355 (equivalent to 67/71), with ratio 336/356 (equivalent to 84/89) being the second best approximation. Note that “equivalent ratio 2/3” (sixth column, fourth row from below) is here a simplification, not a reduction.

APPENDIX 2: THE “28 QUARTER-TONES (IN THE OCTAVE)” OF THE HARMONICISTS

The “28-quarter-tones” diagrams of the Harmonicists represent one of the intriguing problems raised by the interpretation of Aristoxenos’ *Elementa Harmonica*. Elsewhere¹⁰⁸², I have already put in doubt former interpretations of al-Ḥijāzī’s “28 quarter-tones” in the octave, and clarified how the division of the 7 “tones” of the typical *maqām* scale, on two strings of a *tunbūr* tuned in fifth, explain his statements.

(Al-) Ḥijāzī’s scale remained for decades an object of disdain, if not of derision, by Occidental and Oriental theoreticians and musicologists alike, but no one seemed to care for a logical explanation for such surprising, at first sight, an assertion; as I was re-reading the interpretations of Aristoxenos for the purpose of this dossier, it occurred to me that the “28 quarter-tones” of the Harmonicists might well be another example of musicological bias about music.

How the “28 dieseis in one octave” of the Harmonicists became “24 quarter-tones in one octave”, or “28 quarter-tones in one octave and one tone”

In his book *The science of harmonics in classical Greece*, Andrew Barker gives the following explanations about the *Harmonikoi*:

“Aristoxenos [...] repeatedly refers to earlier theorists as ‘the *harmonikoi*’, but he does so only when alluding to those whom he regards as his own legitimate predecessors, that is, to those who adopted an empirical rather than a mathematical approach to the subject. His *harmonikoi* turn out to be theorists of just the same sort as the non-Pythagorean students of harmonics mentioned in the Republic”¹⁰⁸³.

He quotes further Aristoxenos:

“‘Here is the evidence’, he says. ‘The diagrams they set out are those of enharmonic systems only, and no one has ever seen any of systems in diatonic or chromatic’ (2.11–14). The evidence Aristoxenos had at his disposal, then was a set of diagrams. He [Aristoxenos] continues:

‘And yet the diagrams in which they spoke only of enharmonic octachord¹⁰⁸⁴ systems did represent the whole ordering of melody; but about the other magnitudes and arrangements in the enharmonic *genus* itself, and in the others, no one even attempted to learn anything. Instead, **they cut off, from the whole of melody, just one magnitude, the octave**¹⁰⁸⁵, in just one of the three genera, and devoted all their attention to it”¹⁰⁸⁶.

Apart from Aristoxenos’ well publicized¹⁰⁸⁷ disdain for the Harmonicists, we may conclude here that the diagrams of the latter were drawn within the limits of an octave, and used an enharmonic (with smallest *dieseis*) graphical representation.

Barker further explains why the diagrams *must* be based on a quarter-tone division:

“In Aristoxenos’ usage, except where he explicitly qualifies the term to change its application, a *diesis* is a quarter-tone; and it is always so in contexts dealing with the enharmonic genus. **The term *katapyknōsis* is cognate with the expression to *pyknon*, which Aristoxenos uses regularly (in enharmonic contexts) to refer to the miniature structure formed by the two quarter-tones at the bottom of the tetrachord. The diagram was therefore divided into steps of a quarter-tone each.** It may have been no more than a **simple line marked off at equal distances** representing these successive dieses, upon which the notes of a scale were then mapped. *Katapyknōsis*, of course, also recalls the word *pyknōma* which we met in the Republic [...], in connection with the project of establishing a minimal interval ‘by which measurement is to be made’. The theorists whose work Aristoxenos knew had evidently settled on the identification of this unit with one quarter of a tone”¹⁰⁸⁸.

From which we can conclude that the quarter-tone division for these diagrams is an “educated guess”, and further (quote below) that they all encompass a “Just” octave:

“The passage from which we began (2.7–30) speaks of ‘diagrams’ in the plural, and says that they represented ‘enharmonic systems’, not just one single structure. Given that they were all recognisable as enharmonic, they cannot have

¹⁰⁸⁴ See footnote 1091.

¹⁰⁸⁵ This precision is important as it contradicts completely the hypothesis of “an additional one-tone [or two half-tone] interval[s]” examined below in the text.

¹⁰⁸⁶ [Barker, 2007, p. 39]: phrases in bold characters, in this quote and all other quotes in this dossier, are “underlined” by me.

¹⁰⁸⁷ I would say in all specialized literature which reviews his theories.

¹⁰⁸⁸ [Barker, 2007, p. 42].

¹⁰⁸² In NEMO-Online (No. 1) – [Beyhom, 2012]; also for an alternative explanation of Bharata Muni’s scale.

¹⁰⁸³ [Barker, 2007, p. 37].

been distinguished from one another by the sizes of their elementary intervals. Each must have been made up, at least predominantly, of ditones and pairs of quarter-tones (together with the ‘disjunctive’ tone that may separate one tetrachord from another), or have approximated reasonably closely to that pattern. **Nor did the analyses mentioned here differ by representing structures with different compasses; they were all ‘enharmonic octachord¹⁰⁸⁹ systems’, and each of them spanned an octave.**¹⁰⁹⁰ One of Aristoxenos’ references to a theorist named Eratocles might be construed as providing a clue about the ways in which they differed, and how they were related to one another. So it does; **but I must issue advance warning that the passage’s evidence may not bear on these questions quite as directly as at first appears.** Eratocles’ approach, in my view at any rate, was probably not typical of *harmonikoi* in general. [...] What Aristoxenos says is that Eratocles attempted ‘to enumerate the forms of one *systema*, the octave, in one *genus*, without any demonstration, by moving the intervals around cyclically’ (6.21–5). To this we may add **a later reference to people who focused all their attention on ‘the seven octachords which they called *harmoniai*’ (36.30–2)^{1091, 1092}.**

Barker then explains¹⁰⁹³, with some difficulty, the *harmoniai* of Quintilianus which, not being octave species but what would be called later “modes”, are related to Plato’s octave species, and that these (for Quintilianus) reflect “real” music while encompassing an octave + one tone. This whole demonstration continues¹⁰⁹⁴ until the final argumentation of the author:

“There is another feature of this procedure that needs to be disentangled from Aristoxenos’ polemic. He repeatedly implies that **the object on which its exponents focused was the instrument itself, with its ‘holes and bores and other such things’** (41.32–4), rather than the audible notes produced from it by an aulete (with which the supposedly objective data relied on by these *harmonikoi* are sharply contrasted, e.g. 42.7–22). Hence the scales and other sets of relations which they described were not simply transcriptions of what they heard, like those offered by other *harmonikoi*,

and they did not measure intervals just by comparing them, by ear, with an audible unit of measurement. **Their conclusions were based on inferences from what they could see, as features of the physical bodies of the instruments.** That cannot be quite the whole story, of course. They must have had some experiential basis for their inferences about the interval-patterns that a given arrangement of finger-holes would produce. But this creates a complication. **Imagine** a simplified wind-instrument with just three finger-holes, the first placed at a distance of eight units from the mouthpiece, the second at a distance of twelve units and the third at a distance of sixteen units. The distance between the first and the second is equal to that between the second and the third. **One might naively suppose that the intervals between the notes they sound would be equal too. But that is not so. The intervals depend on the ratios between the relevant lengths of pipe, not directly on the sizes of the differences between those lengths. Given an ‘ideal’ pipe and an ‘ideal’ player, two intervals will be equal if the ratios between the lengths of pipe producing their bounding notes are the same, not if these lengths differ by the same amount.** In the present case, the ratio of the second length to the first is $12:8 = 3:2$, while that of the third to the second is $16:12 = 4:3$. The first of the intervals corresponding to them (if we disregard variables introduced by the player’s technique) is a perfect fifth, and the second a perfect fourth. We seem to be back in the territory of the Pythagoreans¹⁰⁹⁵.

In fact, not only do we remain here in the territory of hypotheses, which allows Barker to put forward Pythagorean reasoning on an Aristoxenian explanation – such a procedure being in this case undertaken at the expense of logic – but also Barker will not even imagine equality between a string or a pipe lengths to be considered, in Ancient times, as effective equality between intervals¹⁰⁹⁶.

¹⁰⁹⁵ [Barker, 2007, p.58]: in this excerpt, Barker fails to acknowledge a topographic (and superparticular) understanding of music, i.e. equal divisions of the string (here the *aulos*) length.

¹⁰⁹⁶ Besides my belief that Aristoxenos would use Pythagorean logic more subtly (see Appendix 1 and Appendix 3), forcibly imposing Pythagorean divisions of the octave on what is described as a topographic equal-division of the *aulos* body is clearly not an attempt of understanding Aristoxenos’ logic and explanations, but looks more like an expedient to set aside explanations which might be less appropriate for Classical pythagoreanophile interpreters of Greek theories. We will see that Chailley and Ruelle apply more caution to this problematic, in that they both acknowledge the possibility of the existence of three-quarter-tones intervals in the scales of the Harmonicists, which is one logical conclusion deduced from Aristoxenos’ explanations.

¹⁰⁸⁹ See footnote 1091.

¹⁰⁹⁰ Confirmation of the twenty-eight “quarters” in one octave.

¹⁰⁹¹ Second confirmation, with here footnote 13: “The MSS here have *heptachordōn*, ‘heptachords’; the emendation *hepta oktachordōn*, ‘seven octachords’ was proposed by Westphal. It has been adopted by most modern editors and must surely be correct, in view of Aristoxenos’ contention that his predecessors studied only ‘octachord *systemata*’ (2.15–18), and his discussion of the seven octave-systems constructed by Eratocles (6.21–31)”.

¹⁰⁹² [Barker, 2007, p. 43].

¹⁰⁹³ [Barker, 2007, p. 44–51].

¹⁰⁹⁴ [Barker, 2007, p. 52–57].

In his article “Towards a history of *tonoi*”, Jon Solomon explains:

“So far as we can tell, the octave species¹⁰⁹⁷ is an analytical device developed by Eratocles who, according to Aristoxenos, with or without **the Harmonists divided the entire diapason system¹⁰⁹⁸ of notes into twenty-eight quartertone dieses¹⁰⁹⁹**. It looks as if the octave species is an analytical contrivance devised by Eratocles to assist him in maneuvering his music up and down his **impossibly** close-packed **quartertone** system and that the species of the *diatessaron* and *diapente* are then additional species devised and developed by Aristoxenos to conform to his notion that all Greek music consists of regularized conjunct and disjunct tetrachords¹¹⁰⁰.

It is interesting to observe here the logic in refusing the “impossibly close-packed system” of the Harmonicists, and in insisting on the supremacy of the octave and on its precedency on the smaller *species*, the pentachordal and tetrachordal constructions¹¹⁰¹; further in the article, we find an alternate explanation of “Eratocles’ species”:

“I would hazard a guess that the *tonos* and the octave species in Cleonides (ex Aristoxeno) were two very different entities, one an attempted standardization of actual national musics, the other an analytical device developed from Eratocles but which became part of the standardized music for subsequent generations¹¹⁰².

While keeping in mind this explanation, let us now examine a little bit more Aristoxenos’ effective discourse on the Harmonicists, here in Macran’s translation:

“Most students of Harmonic, as we perceived in a previous work, have failed even to notice that a treatment of this subject was required. Eratocles and his school have contented themselves with remarking that there are two possible melodic progressions starting from the interval of the fourth,

both upwards and downwards. **They do not definitely state whether the law holds good from whatever interval of the fourth the melody starts**; they assign no reason for their law; they do not inquire how other intervals are synthesized—whether there is a fixed principle that determines the synthesis of any given interval with any other, and under what circumstances scales do and do not arise from the syntheses, or whether this matter is incapable of determination¹¹⁰³,

and:

“As we then observed all the scales with the exception of one have been completely passed over; and of that one scale Eratocles merely endeavoured to enumerate the figures of one magnitude, namely the octave, empirically determining their number, without any attempt at demonstration, by the recurrence of the intervals. He failed to observe that unless there be previous demonstration of the figures of the fifth and fourth, as well as of the laws of their melodious collocation, such an empirical process will give us not seven figures, but many multiples of seven¹¹⁰⁴,

or:

“In inquiring into (28) continuity we must avoid the example set by the Harmonists in their condensed diagrams, where they mark as consecutive notes those that are separated from one another by the smallest interval. For so far is the voice from being able to produce twenty-eight consecutive dieses, that it can by no effort produce three dieses in succession. If ascending after two dieses, it can produce nothing less than the complement of the fourth, and that is either eight times the smallest diesis, or falls short of it only by a minute and unmelodic interval¹¹⁰⁵.

¹¹⁰³ [Aristoxenos and Macran, 1902, p. 168].

¹¹⁰⁴ [Aristoxenos and Macran, 1902, p. 169].

¹¹⁰⁵ [Aristoxenos and Macran, 1902, p. 185]; these excerpts are available in French in Ruelle’s interpretation [Aristoxenos and Ruelle, 1870, p. 7–8], who considers “24 *dieses*” and refers notably to Meibom’s “subtle explanation” about how the “original 24” *dieses* “became 28”: “Il sera nécessaire, lorsque nous étudierons les intervalles composés, auxquels il arrive en quelque sorte d’être des systèmes en même temps que des intervalles, de dire quelque chose sur la combinaison des intervalles incomposés, question dont la plupart des harmoniciens ne se sont pas même aperçus qu’il fallait parler, comme nous en avons acquis précédemment la conviction. 16. Les disciples d’Ératocles ont seulement dit à ce sujet que le *diatessaron* (la quarte), dans l’un et l’autre sens (aigu et grave), partage en deux le chant [footnote 2 by Ruelle: ‘Meybaum explique très-ingénièrement cette phrase qui, suivant son expression, l’a torturé longtemps [...]. Mais nous croyons remplacer avec avantage son interprétation par une conjecture qui a reçu l’adhésion de M. Vincent. Peut-être s’agit-il ici d’un système heptacorde composé de deux tétracordes conjoints et dont le chant se trouve partagé en deux par chacun des tétracordes, c’est-à-dire deux tétracordes conjoints dont les différentes grandeurs partielles se trouvent chantées musicalement ou si l’on veut

¹⁰⁹⁷ A detailed explanation on “What were the octave species and *tonoi*” of Ancient Greeks, and the evolution of their understanding by Western musicologists is available in [Palisca, 1984].

¹⁰⁹⁸ *i.e.* the octave: from which we have another confirmation of the 28-*dieses* division of the octave.

¹⁰⁹⁹ If this is the case, we find ourselves facing an al-Ḥijāzī-like division of the octave.

¹¹⁰⁰ [Solomon, 1984, p. 248].

¹¹⁰¹ This logic is opposed to the logic of Curt Sachs as explained in Chapter 3 of this dossier; but it is perhaps so because Solomon is discussing theoretical issues, whenever Sachs believed his theory applied to praxis?

¹¹⁰² [Solomon, 1984, p. 251].

Mathiesen comments:

“the opposite of musical continuity and consecution is the impression conveyed by the closely packed diagrams of the Harmonicists, composed of the smallest possible intervals placed one after another. Such a diagram implies, according to Aristoxenus, that the voice might be expected to sing as many as twenty-eight consecutive dieses, when in fact the voice cannot sing more than two consecutive dieses. **He observes that if the voice sings two dieses in ascent, the next interval must be the remainder of a fourth, or ‘eight times the smallest diesis or smaller by a wholly tiny and unmelodic interval’**”¹¹⁰⁶; if the voice sings two dieses in descent, the next interval must be at least as large as a whole-tone. **It is important to note that Aristoxenus qualifies this statement by conceding that the remainder of the tetrachord after subtracting the two enharmonic dieses may be slightly smaller than the remaining twenty-four** [i.e. Cleonidēs’ 12^{ths} of the tone in Mathiesen’s diagrams] parts (see figure 51 [equivalent to Fig. 18, p. 70 in this dossier]).

→
harmonieusement avec un repos observé à la moitié de cette sorte de gamme, qui est la mèse’], et cela sans déterminer si ce partage a lieu à partir d’un intervalle quelconque ; (sans examiner), à l’égard des intervalles autres que la quarte, comment ils se combinent entre eux ; sans observer s’il y a une relation déterminée dans la composition d’un intervalle quelconque avec un autre intervalle quelconque ; (sans dire) de quelle manière les systèmes peuvent ou ne peuvent pas résulter des intervalles ; ou bien [s’ils en parlent] rien n’est précisé”, [...] “Dans un seul genre, Ératocles voulut énumérer les diverses formes d’un seul système, à savoir l’octave, qu’il produisait démonstrativement par la circulation des intervalles ; il ne remarquait point que si l’on n’expose pas auparavant les diverses formes de la quarte et de la quinte, et ensuite la nature de la composition suivant laquelle ces (intervalles) se combinent mélodiquement, il est évident que l’on aura (exclusivement) des (intervalles) multiples de sept” – [Aristoxenos and Ruelle, 1870, p. 9], and “98. Il ne faut pas rechercher la continuité à la manière des harmoniciens : ils s’efforcent de la produire dans la *catapygnose* des diagrammes, et veulent montrer que, parmi les sons, ceux-là se placent successivement les uns après les autres qui se trouvent n’être séparés entre eux que par l’intervalle minime. 99. Bien loin en effet que la voix puisse chanter successivement vingt-quatre diésis [here footnote 2: ‘Meybaum explique d’une façon très-vraisemblable, mais peut-être trop subtile, comment le nombre $\kappa\eta'$ ou vingt-huit a remplacé $\kappa\delta'$ ou vingt-quatre. Aristoxène, dit-il, renfermait ses treize tons dans l’octave ; mais ceux qui ajoutèrent deux tons (ou deux diagrammes) nouveaux ajoutèrent ainsi un intervalle tonié, ce qui fait quatre diésis, et l’usage exigea par suite que l’on écrivit vingt-huit au lieu de vingt-quatre diésis’], elle n’est pas capable, quelque effort qu’elle fasse, de chanter musicalement un troisième diésis. 100. 1° Dans l’aigu, le plus petit intervalle qu’elle puisse chanter (après deux diésis) est le reste de la quarte. Tous les intervalles plus petits que celui-là, elle ne peut les chanter ; or c’est tantôt un intervalle octuple du diésis minime, tantôt un intervalle moindre que celui-là d’une petite quantité non mélodique” – [Aristoxenos and Ruelle, 1870, p. 41–42].

¹¹⁰⁶ Footnote 58 is inserted here by the author.

This is, of course, true, and it demonstrates that far from being unaware of the mathematical or empirical problems in his spatial conception, he was acutely aware of them. They do not matter, however: as the interval is musically negligible, it is irrelevant to the theoretical conception”¹¹⁰⁷.

In a footnote in the first paragraph¹¹⁰⁸, Mathiesen reproduces the Greek text concerning the “leftover of the fourth” then adds:

“Andrew Barker¹¹⁰⁹ observes that the reference to twenty-eight consecutive dieses is problematic, since there are only twenty-four in the octave. There are, however, several possible explanations. The range between the Hypodorian and Hyperlydian *tonoi* is an octave and a tone, or in other words, twenty-eight dieses. If a Harmonicist constructed a diagram of the fifteen *tonoi* accommodating all the possible pitches, it would be in the shape of a wing (such a diagram is described by Aristides Quintilianus *De musica* [...]) and the two central tetrachords would indeed encompass twenty-eight consecutive dieses. In the *Elementa*, Aristoxenus in fact

¹¹⁰⁷ [Mathiesen, 1999, p. 314–315]; Macran has a different, “Classical” interpretation – while reminding us [Aristoxenos and Macran, 1902, p. 227] that “[o]f Eratocles nothing is known beyond what we learn from Aristoxenus himself”, he adds [Aristoxenos and Macran, 1902, p. 228–229]: “Eratocles, according to the criticism of Aristoxenus, would seem to have presupposed the constitution of the octave scale



and to have arrived at the enumeration of its Figures by showing that after proceeding through the various arrangements to be obtained by beginning successively with *e, f, g, a, b, c, d*, one is brought back again to the first Figure with which one started. **Against this superficial empiricism** Aristoxenus very justly urges that the Figures of the fourth and fifth and the laws of their collocation must be demonstrated prior to the enumeration of the Figures of the octave. Otherwise we are not justified in limiting these Figures to seven. Why, for example, should we not admit the Figure



Here we have a scale that is illegitimate though it consists of five tones and two semitones, because it violates the law of the Figures of the fourth and fifth and their collocation”.

¹¹⁰⁸ Footnote 58 as indicated in footnote 1106 of this dossier.

¹¹⁰⁹ With the following references: “*Greek Musical Writings*, 2:145, n. 17; and ‘Aristides Quintilianus and Constructions in Early Music Theory’, *Classical Quarterly* n.s. 32 [1982]: 184–97”; in the latter [Barker, 1982], the author notably explains [p. 193–194]: “If, as Aristoxenus tells us, [the Harmonicists’] objective was to ‘compress the diagram’, and if what they were dealing with were octave scales, there could have been no sensible reason for choosing a sequence of 30 dieses or 28 or 26. The only rational choice is 24, the number of dieses in the octave”.

ascribes just this sort of closely packed diagram to the Harmonicists [...]. It might be countered, however, that beginning with Cleonides, later Greek theorists attribute only thirteen *tonoi* to Aristoxenus, asserting that the two highest *tonoi* were added by younger theorists. Nevertheless, in the surviving parts of the *Elementa*, Aristoxenus makes no such statement and firmly ascribes to the Harmonicists the naming of the *tonoi*¹¹¹⁰.

As a result of this persisting (and sustained?) uncertainty about the number(s) of *dieseis* in the Harmonicists “close-packed” diagrams, an oversimplification seems to have ruled not only in literature concerning itself generally with Ancient Greek theories¹¹¹¹, but even when examining Aristoxenus’ writings specifically, as with Flora Levin:

[note 24] Diagrams of ‘condensed’ scales comprising a series of **twenty-eight quarter-tones** were produced by the harmonists, the series **constituting an octave and a tone**. Their attempts to represent these sequences in notation provoked Aristoxenus’ acerbic criticism. Cf. L. Laloy, *Aristoxène de Tarente* (Paris 1904) 114-17¹¹¹².

¹¹¹⁰ [Mathiesen, 1999, p. 314].

¹¹¹¹ Such as Tiby’s statement that “the Greek admitted effectively that, from a theoretical point of view [for persons supposed to be “Empiricists”? – see footnote 1107 and the quote in bold], the octave was divided in 24 parts [...] accordingly quarter-tones” (with the complete French quote: “Il y avait encore d’autres possibilités de modifier la hauteur de certains sons. **Les Grecs admettaient en effet que, d’un point de vue théorique, l’octave se divisait en vingt-quatre parties**, adoptant ainsi une répartition double de la nôtre (qui comprend douze degrés, soit douze demi-tons) **ce qui revient à dire qu’ils mettaient ainsi en jeu des quarts de ton**. Cela était surtout valable en théorie. En pratique, l’usage des nuances – ainsi nommées – se réduisait à abaisser certains sons, dans les genres diatonique et chromatique, d’une fraction d’un demi-ton. Cette opération s’accomplissait sur la lyre et la cithara en diminuant quelque peu la tension de certaines cordes et, pour les instruments à vent, en obturant partiellement avec le doigt le trou correspondant au son qu’on voulait abaisser” – [Tiby, 2001, p. 381]).

¹¹¹² [Levin, 1972, p. 221, n. 24]; Laloy expresses this very concisely (and referring to Aristides Quintilianus): “the diagram contained a series of 28 of these quarter-tones, which extended overall to an octave and one tone” (with the complete French text: “Mais le texte d’Aristoxène montre qu’il fallait quatre intervalles de ce genre, ou à peu près, pour constituer un ton entier. **Les diagrammes comprenaient une série de 28 de ces quarts de ton, ce qui faisait en tout une étendue d’une octave et d’un ton**. Telle est aussi, vers cette époque, l’étendue de la gamme dorienne, d’après le témoignage d’Aristide Quintilien”. He proposes also a discussion of the “Harmonicists” in [Laloy, 1904, p. 106–113].

All this cart-and-horse game [shilly-shallying] seems to have been triggered by Meibom’s¹¹¹³ interpretation of this passage of Aristoxenus, an interpretation that Ruelle himself finds “too subtle”¹¹¹⁴.

Most interesting, none of these authors seems to have considered the possibility of another “equality” of the intervals, namely an equality based on string’s (or pipe’s) parts, to try and solve this riddle¹¹¹⁵.

The equal-division of the strings as a possible solution for the 28 dieseis of the Harmonicists

It seems to me of interest to reproduce here, as the last quote for this appendix, another interesting reference by Aristoxenus to the Harmonicists, later in his *Elementa*:

“some of the Harmonists hold that the Hypodorian is the lowest of the keys; that half a tone above lies the Mixolydian; half a tone higher again the Dorian; a tone above the Dorian the Phrygian; likewise a tone above the Phrygian the Lydian. The number is sometimes increased by the addition of the Hypophrygian clarinet at the bottom of the list. Others, again, having regard to the boring of finger-holes on the flutes, assume intervals of three quarter-tones between the three lowest keys, the Hypophrygian, the Hypodorian, and the Dorian; a tone between the Dorian and Phrygian; three quarter-tones again between the Phrygian and Lydian, and the same distance between the Lydian and Mixolydian. But they have not informed us on what principle they have (38) persuaded themselves to this location of the keys. And that the close packing of small intervals is unmelodious and of no

¹¹¹³ See [Bergsagel, 2001] for this 17th-century author, notably: “*Antiquae musicae auctores septem* {[Meibom, 1652]} is his most important contribution to musical scholarship. In his two quarto volumes he provided an edition of the Greek texts of Aristoxenus, Cleonides (under an attribution to Euclid), Nicomachus, Alypius, Gaudentius, Bacchius, Aristides Quintilianus and Martianus Capella (*Satyricon*, bk 9), with a Latin translation and commentary”.

¹¹¹⁴ See footnote 1105.

¹¹¹⁵ The resistance to “anything but Pythagoreanism” seems very deep-rooted in most of the literature dealing with Greek theories, as shows this consideration from Litchfield: “Using the mathematics available to him, Aristoxenus could never have represented the precise pitches indicated by his various tunings using numerals and ratios. Because this was the only precise method available to the ancients of specifying without any doubt the specific sizes of intervals (and, by consequence, relative pitches), it is clear that Aristoxenus never could aurally demonstrate the precise locations of the pitches or the exact size of the intervening intervals he posited” – [Litchfield, 1988, p. 54].

practical value whatsoever will be clear in the course of our discussion”¹¹¹⁶.

The mention of the “three-quarter-tones” intervals (see FHT 40, bottom-left) seems to have also bothered Meibom¹¹¹⁷, who “refuted” them and considered a semi-tonal representation as the only possible one (see FHT 40, bottom-right).

All these components put together lead me to think that, in his disdain for the “Harmonicists”, Aristoxenos may well have shown the same bias as with today musicologists who find equal-string(s) divisions an unworthy (for their Pythagorean-based thought) solution for theoretical systems and scales.

Two such possible solutions are proposed in FHT 41 and FHT 42, the first being based on Shihāb-a-d-Dīn al-Hijāzī’s division of the strings of the *tunbūr*¹¹¹⁸ (only one string is considered here), and the second solution based on a dual division of the string (or pipe) in superparticular intervals.

While I lack the literacy (Ancient Greek language) to verify if these propositions may represent possible solutions to this riddle, it may be worth the try¹¹¹⁹.

¹¹¹⁶ [Aristoxenos and Macran, 1902, p. 192–193], and the French text from Ruelle: “23. 1° De même chez les harmoniciens, les uns déclarent le ton *hypodorien* le plus grave de tous, le *dorien* plus aigu d’un demi-ton que celui-ci; le *phrygien* plus aigu que ce dernier de l’intervalle d’un ton; le *lydien* plus aigu d’un autre ton, et enfin le *mixolydien* plus aigu que le précédent de l’intervalle d’un demi-ton. 2° D’autres, même, ajoutent à ces tons, dans le grave, la flûte *hypophrygienne*. 3° Les autres, ayant en vue la perforation des flûtes, séparent entre eux par trois diésis les trois tons les plus graves, l’*hypophrygien*, l’*hypodorien* et le *dorien*; ils séparent ensuite par un ton le *phrygien* du *dorien*, par trois diésis le *lydien* du *phrygien*, et par la même distance le *mixolydien* du *lydien*. Quelle raison avaient-ils pour affecter d’espacer ainsi les tons? ils ne l’ont pas expliqué; mais la catapycnose est non mélodique et de tout point d’un mauvais emploi” – [Aristoxenos and Ruelle, 1870, p. 57–58, 60].

¹¹¹⁷ According to Ruelle in his footnote 1 [Aristoxenos and Ruelle, 1870, p. 58].

¹¹¹⁸ As proposed in [Beyhom, 2012, p. 72 – Fig. 15].

¹¹¹⁹ And from my point of view clearly better than continuously reproducing old biases from the 17th century.

DISPOSITIONS RELATIVES DES TONS (du grave à l’aigu).

Première disposition. (§ 23, 1°).		Deuxième disposition. (§ 23, 2°).	
HYPODORIEN.	} 1 dem on.	HYPOPHRYGIEN.	} 1 ton (vraisemblablement).
DORIEN.		HYPODORIEN.	
PHRYGIEN.	} 1 ton.	DORIEN.	} 1 demi-ton.
LYDIEN.		PHRYGIEN.	
MIXOLYDIEN.	} 1 demi-ton.	LYDIEN.	} 1 ton.
		MIXOLYDIEN.	
Troisième disposition. (§ 23, 3°).		Quatrième disposition (proposée par Meybaum).	
HYPOPHRYGIEN.	} 3 diésis (enharmoniques).	HYPODORIEN.	} 1 demi-ton.
HYPODORIEN.		HYPOPHRYGIEN.	
DORIEN.	} 3 diésis.	HYPOLYDIEN.	} 1 demi-ton.
PHRYGIEN.		DORIEN.	
LYDIEN.	} 1 ton.	PHRYGIEN.	} 1 ton.
MIXOLYDIEN.		LYDIEN.	
	} 3 diésis.	MIXOLYDIEN.	} 1 trihémiton.

FHT 40 Ruelle’s interpretation of Meibom 38 (above, and below to the left – Aristoxenos) and Meibom’s own interpretation (to the right) according to Ruelle¹¹²⁰.

*
* *

¹¹²⁰ For, according to Aristoxenos, the “other [Harmonicists which] assume intervals of three quarter-tones between the three lowest keys” of the flutes (“*aulos*” in [Chailley, 1979, p. 83] – see note 1200) – [Aristoxenos and Ruelle, 1870, p. 59]; “demi-ton” = “half-tone”, “trihémiton = 1 ½ tones; the upper-left “demi-ton” is partially erased in my digital copy (and in the figure).

Plates for Appendix 2

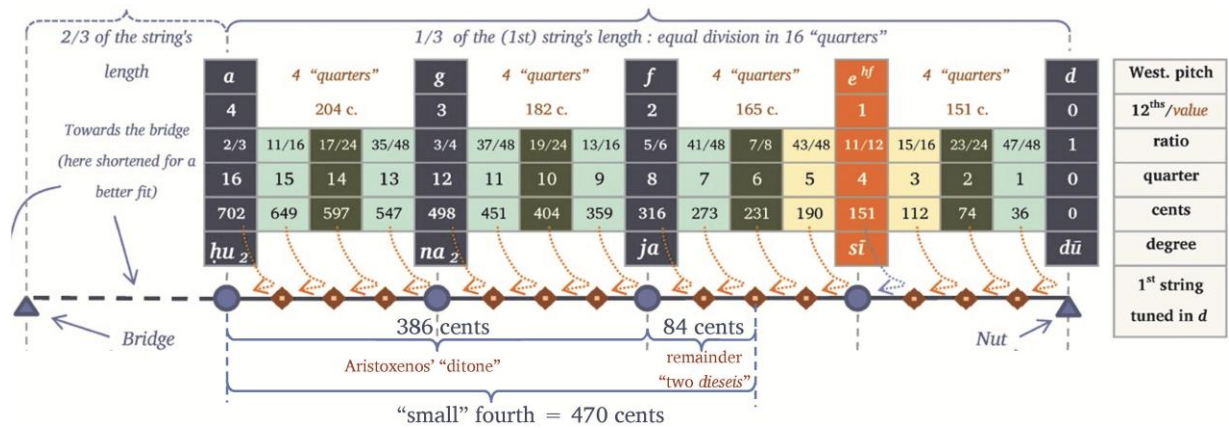

FHT 41 Shihāb-a-d-Din's division as a possible model for the Harmonicists' 28-dieseis diagrams¹¹²¹.

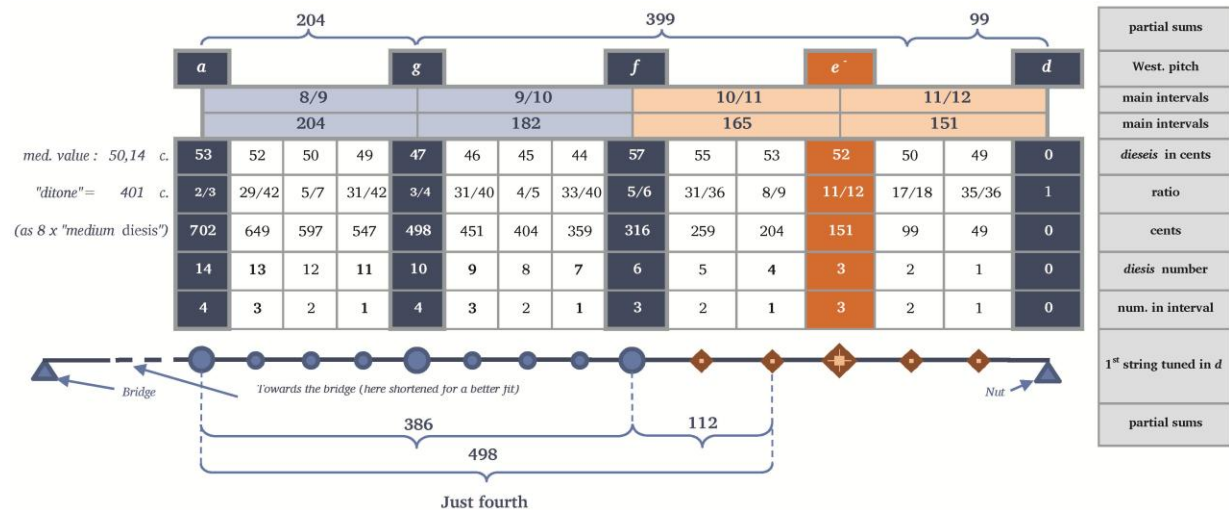

FHT 42 Alternative reasonings for the “24-dieseis” division based on a dual 12-parts main division of the string and divisions in 3 dieseis of the first 2 (ascending) “tones” and 4 “dieseis” for the last two tones; all divisions are equal-divisions of the string(s), with each of the 8/9, 9/10, 10/11 and 11/12 “tones” subdivided in either 3 (for the tones with ratios 11/12 and 10/11) or 4 (for the tones with ratios 10/9 and 9/8) equal-length parts¹¹²².

¹¹²¹ Adapted and complemented detail from [Beyhom, 2012, p. 72–Fig. 15]: see the original figure for the second (lower) string's division which complements the 28 “dieseis”.

¹¹²² The “medium value” of the diesis is calculated for the whole 14 dieseis; the upper part shows the “partial sums” of the tone 8/9, the “ditone” (“8 dieseis”) with 399 cents, and the remainder “half-tone” (the *pycnon*) with 99 cents; the lower part considers a (descending) superparticular 386 cents “ditone” (ratio 4/5) with a superparticular 112 cents *pycnon* (ratio 15/16); the remainder is a superparticular (and Pythagorean) tone with ratio 8/9.

APPENDIX 3: THE *GENERA* OF ARISTOXENOS AND DEVELOPMENTS BY (AL-) FĀRĀBĪ

The two foremost examples of Aristoxenos' use of Pythagorean logic are to be found, in my view, in his explanations about the half-tone (seen in Appendix 1) and in his use of Pythagorean mathematics, namely the *tetrad*, in his description of the typical *genera*, and more specifically in his theoretical processing of the *pycnon*.

As I write in the main text¹¹²³, diatonism in Ancient Greek theories is rooted in the “non-*pycnon*” rule, *i.e.* whenever there is no *pycnon*, the tetrachord is diatonic (FHT 43, p. 213). The counterpart of this rule is that all tetrachords which cannot be classified as “diatonic” must be either chromatic or enharmonic. The chromatic-enharmonic rule may be stated: “Whenever there exists in the tetrachord an interval greater¹¹²⁴ than the sum of the two others, the resulting tetrachord is either chromatic or enharmonic” (FHT 43), with the latter tetrachord being a boundary case for Aristoxenos¹¹²⁵.

This rule, as well as the typical tetrachords posited by Aristoxenos, can be problematic, notably in the latter case for the intervals composing the *pycnon*, beginning with the quarter-tone, the 3/8th of the tone, the third of the tone and ending with the semi-tone.

Another problematic, that I address elsewhere¹¹²⁶, is that the *pycnon rule* does not apply to *maqām* music, notably because of the assembly of small intervals together to form the *pycnon*, an unusual disposition for this music which prefers alternating smaller and bigger intervals of seconds (see FHT 44, p. 213), notably as in the *soft diatonic* (also a “boundary case” – see FHT 47, p. 215) tetrachord of Aristoxenos where the (ascending) progression [↑3 5 2] (quarter-tones) would best describe the *original hijāz* tetrachord (Fig. 19, p. 189).

¹¹²³ Chapter II.

¹¹²⁴ When the greatest interval is equal to the other two, this is in Aristoxenos' propositions a boundary case (*soft diatonic* – see FHT 47, p. 215) between diatonism and chromatism; note that the other “soft” tetrachord, the *soft chromatic*, draws also an internal boundary between chromatism and enharmonism.

¹¹²⁵ Notably because the smallest interval that can be sung is a quarter-tone (or enharmonic *diesis*).

¹¹²⁶ First in my Ph.D. thesis [Beyhom, 2003a] then in [Beyhom, 2010a].

It seems however that the *pycnon* plays a major role in Aristoxenos' tetrachordal theory, as well as in *maqām* music; although this role may have evolved with time.

If we observe the progression of the *pycnon* intervals on FHT 43, p. 213, trying to understand Aristoxenos' logic in establishing them, another “rule” for the *pycnydium* he uses for his typical tetrachords is the equality of the two component-intervals which compose it¹¹²⁷.

While studying Fārābī's treatise on music¹¹²⁸ I could establish¹¹²⁹ that this author, when addressing Aristoxenos' tetrachords, probably followed an incremental, simple (and extended *pycnon*) rule for the two supplementary tetrachords he posited (FHT 45, p. 214). This rule consisted in incrementing Aristoxenos' *pycnydium*, beginning with the *enharmonic* tetrachord (FHT 46) with a sixth of the tone, or one twelfth of the tone for each interval in the *pycnon*¹¹³⁰.

Such a solution, while probably justified for the supplementary tetrachords in *maqām* music (listen to the various tetrachords on Slide No. 7), implied however consistent discrepancies with the logic (if any) in the establishment of Aristoxenos' tetrachords (FHT 45, p. 214 and FHT 47, p. 215), notably for the *hemiotic chromatic* and the two *diatonic* tetrachords.

A complementary explanation was proposed in my latest book on Byzantine chant¹¹³¹, in which I focus more on the intervallic value of the *pycnon* as such¹¹³². FHT 48, p. 216 shows the progression of the values of the *pycnydium* (and following non-*pycnon* di-intervallic combinations of the lower two intervals) in Aristoxenos tetrachords, with values respectively worth 1/2¹¹³³ (2/4), 3/4¹¹³⁴, 2/3¹¹³⁵ and 4/4¹¹³⁶ (1) fractions

¹¹²⁷ A purely theoretical (practical) rule as we have seen in Chapter I, with all the possible shades and mixed tetrachords.

¹¹²⁸ [Fārābī (al-), 1930 ; 1935].

¹¹²⁹ In [Beyhom, 2010c].

¹¹³⁰ With a regular progression of the intervals composing the *pycnon* of the type $y_i = y_{i-1} + 1/12$ (of the tone).

¹¹³¹ [Beyhom, 2015b].

¹¹³² The first proposition focused on the component-intervals of the *pycnon* (see footnote 1130 above).

¹¹³³ The ratio of the Pythagorean octave.

¹¹³⁴ The ratio of the Pythagorean fourth.

¹¹³⁵ The ratio of the Pythagorean fifth.

¹¹³⁶ The ratio of the unison.

of the tone,¹¹³⁷ a perfect application of the Pythagorean *tetrad*, while the progression continues evenly (5/4, 6/4) for the “lower” intervals of the non-*pycnon* (*diatonic*) *genera*.

While this process explains the use of the 3/8 tone interval (as half of the 3/4-tone *pycnon*) for the *chromatic hemiolic* tetrachord, it would also imply a subtle, but implicit use¹¹³⁸ of Pythagorean mathematics by Aristoxenos¹¹³⁹.

For the remaining two a-*pycnon* (*diatonic*) tetrachords, the same logic applies, but for the central interval which is incremented with a quarter-tone twice, resulting thus in the *soft diatonic* in which the di-intervallic pseudo-*pycnon* amounts to 5/4 tones, while the *tense diatonic* pseudo-*pycnon* amounts to 6/4 (1 1/2) tones.

This process must logically stop whenever the central interval reaches the value of the upper interval, as is the case of the *tense diatonic* tetrachord¹¹⁴⁰; otherwise, the next logical step would be incrementing the central interval one further quarter-tone, with the resulting 2/4, 5/4 and 3/4 tones (or [↑2 5 3]¹¹⁴¹), or the intervals of the *soft diatonic* tetrachord with however the two upper intervals inversed¹¹⁴². The further application of this rule would result in the *tense chromatic* tetrachord with (also) inversed upper intervals [↑2 6 2] which proves itself equally useless for Aristoxenos’ demonstration.

Consequently, there is definitively a dual, simple¹¹⁴³ and in the same time complex¹¹⁴⁴ logic in Aristoxenos’

use of the *pycnidium* in his tetrachords, and the resulting “halves” composing these *pycnidium* are but a sequel of this logic, regardless of the very small discrepancy observed between the 1/3 tone (*soft chromatic*) and the 3/8 tone intervals (*hemiolic chromatic*).

Another consequence is that Fārābī’s additional tetrachords are alien to Aristoxenos’ logic in establishing his typical tetrachords (FHT 49, p. 216), and that Fārābī either relied on the (theoretical) equal-intervals process (FHT 49) or based himself on actual *maqām* praxis, with both of these hypotheses coinciding in the Zalzalian (*diatonic*) *rāst* [↑4 3 3] tetrachord or the equally *Zalzalian* (*diatonic*) equal-intervals tetrachord (utmost left in FHT 45, p. 214).

Conclusions of Appendix 3

While we do not know exactly which treatises Early *maqām* theoreticians had in hands, and even less (or only partially) what was the content of these copies from Ancient Greek treatises, or whether it was altered or not, to the extent of our knowledge Fārābī, Sīnā and Urmawī¹¹⁴⁵ did indeed expand on these theories and tried to adapt them to the music of the time(s)¹¹⁴⁶, while trying to remain faithful to the spirit of the original Greek treatises.

As for Aristoxenos, he was most probably more than aware of Pythagorean dogmas¹¹⁴⁷ and used them implicitly in his demonstrations, either taunting Pythagoreans (the *pycnidium*), or to secure his use of “the senses” (the “half-tone”).

¹¹³⁷ In a superparticular progression applied not to the ratios, but to the values of the *pycnidium*.

¹¹³⁸ And knowledge: “It should not be forgotten that Aristoxenos, whose system was to be later excessively opposed to the system of Pythagoras, wrote the biography of this Philosopher [...] as well as a report on the Pythagorean system, of which significant fragments are still extant” (in French “On ne doit pas oublier d’ailleurs qu’Aristoxène, dont le système fut plus tard opposé non sans excès à celui de Pythagore, avait écrit la biographie de ce philosophe [...] et un exposé du système pythagoricien, dont il subsiste d’importants fragments” – Reinach in [Plutarque (0046?-0120?), 1900, p. xvi]).

¹¹³⁹ Knowing Aristoxenos’ declared opposition to the Pythagoreans (as well as to the Harmonicists), his use of their mathematics would have to be concealed.

¹¹⁴⁰ Both central and upper intervals have reached a “tense” value of one whole tone.

¹¹⁴¹ In ascending multiples of the quarter-tone.

¹¹⁴² Or the *original hijāz* tetrachord.

¹¹⁴³ While based on simple numbers.

*
* *

→
¹¹⁴⁴ Because of its implicit use of the *tetrad*.

¹¹⁴⁵ For the use and adaptations of Greek theories by the last two theoreticians, see respectively [Beyhom, 2010c] and [Urmawī (d. 1294) and [Jurjānī (al-), 2001].

¹¹⁴⁶ At least partly, as I personally have no doubt that some of the theoretical developments of Early Arabian theoreticians may be, indeed, effectively and purely theoretical.

¹¹⁴⁷ See also Appendix 1.

Plates for Appendix 3

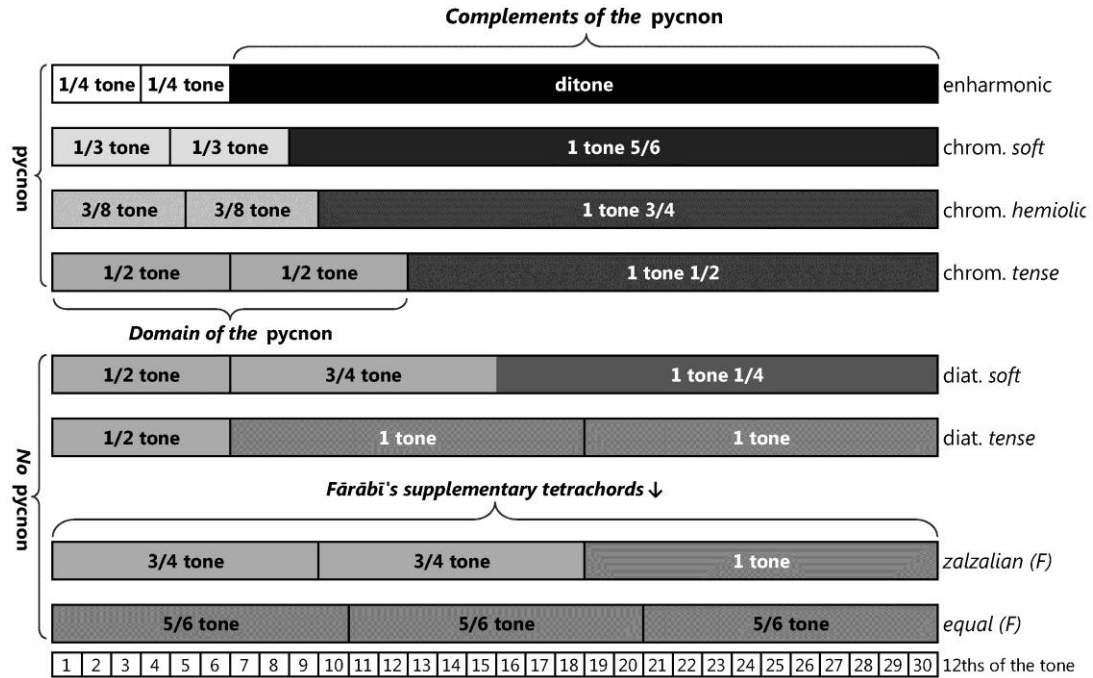

FHT 43 Aristoxenos' typical *genera* (in tetrachordal representation, the six above), with intervals expressed in fractions of the (equal-tempered) tone on a grid in multiples of the twelfth of the tone (or Byzantine *minutes* – 72-ET), and (al-) Fārābī's additions (the two tetrachords below); the *soft diatonic* is the prototype of the Arabian *original hijāz* (3/4 tones, 5/4 tones and 1/2 tone), with however a different disposition of the intervals inside the tetrachord¹¹⁴⁸.

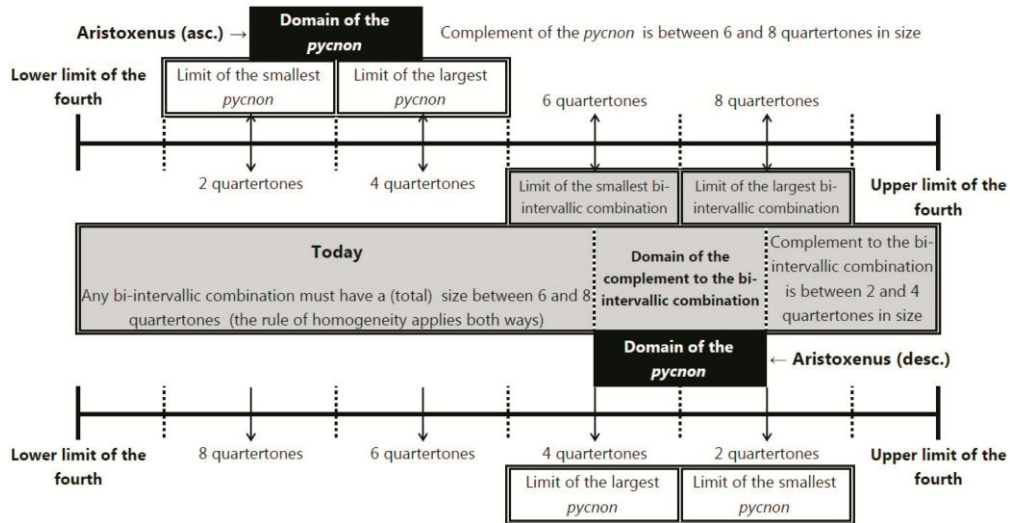

FHT 44 The homogeneity rule, or reverse *pycnon* rule. If Aristoxenos' *genus* is falling, the domain of the *pycnon* is the domain of the complement of the bi-intervallic combination (within a fourth) in today's traditional heptatonic modal music. This applies to *all* genera in (Just) fourth of common use in Arabian music, including the chromatic *genus hijāz* (the symmetrical "Piano" *hijāz* in 2 6 2 multiples of the quarter-tone) and its (most probably) original forms in 3 5 2 and 2 5 3 (the latter is more related to *maqām Hijāz-Kār*)¹¹⁴⁹.

¹¹⁴⁸ Adapted from figures 148 [p. 440] and 185 [p. 639] in [Beyhom, 2010c] – see Slide No. 7 to listen to the ascending pitches of each tetrachord.

¹¹⁴⁹ Previously published in [Beyhom, 2010a, p. 192]; the *Homogeneity rule for maqām* tetrachords can be expressed as: "Any bi-intervallic combination in a tetrachord must have a total value included between 6 and 8 quarter-tones" (i.e. 6, 7 or 8 quarter-tones).

		(Fārābī) 4 th complementary	(Fārābī) 2 nd usual	diatonic: <i>syntonic</i> or <i>tense</i>	diatonic: <i>soft</i>	chromatic: <i>tonic</i>	chromatic: <i>soft</i>	chromatic: <i>hemiolic</i>	enharmonic
1 st interval	tones	5/6	1	1	1 1/4	1 1/2	1 5/6	1 3/4	2
	quarter-tones	3 1/3	4	4	5	6	7 1/3	7	8
	minutes	10	12	12	15	18	22	21	24
	cents	167	200	200	250	300	367	350	400
2 nd interval	tones	5/6	3/4	1	3/4	1/2	1/3	3/8	1/4
	quarter-tones	3 1/3	3	4	3	2	1 1/3	1 1/2	1
	minutes	10	9	12	9	6	4	4 1/2	3
	cents	167	150	200	150	100	67	75	50
3 rd interval	tones	5/6	3/4	1/2	1/2	1/2	1/3	3/8	1/4
	quarter-tones	3 1/3	3	2	2	2	1 1/3	1 1/2	1
	minutes	10	9	6	6	6	4	4 1/2	3
	cents	167	150	100	100	100	67	75	50
Sum	tones	2,5	2,5	2,5	2,5	2,5	2,5	2,5	2,5
	quarter-tones	10	10	10	10	10	10	10	10
	minutes	30	30	30	30	30	30	30	30
	cents	500	500	500	500	500	500	500	500
		Fārābī		Aristoxenos					

FHT 45 Fārābī’s developments for Aristoxenos’ *genera* (two left rows) with intervals expressed in fractions of the (equal-tempered) tone, numbers of quarter-tones, Byzantine minutes (72-ET) and cents.

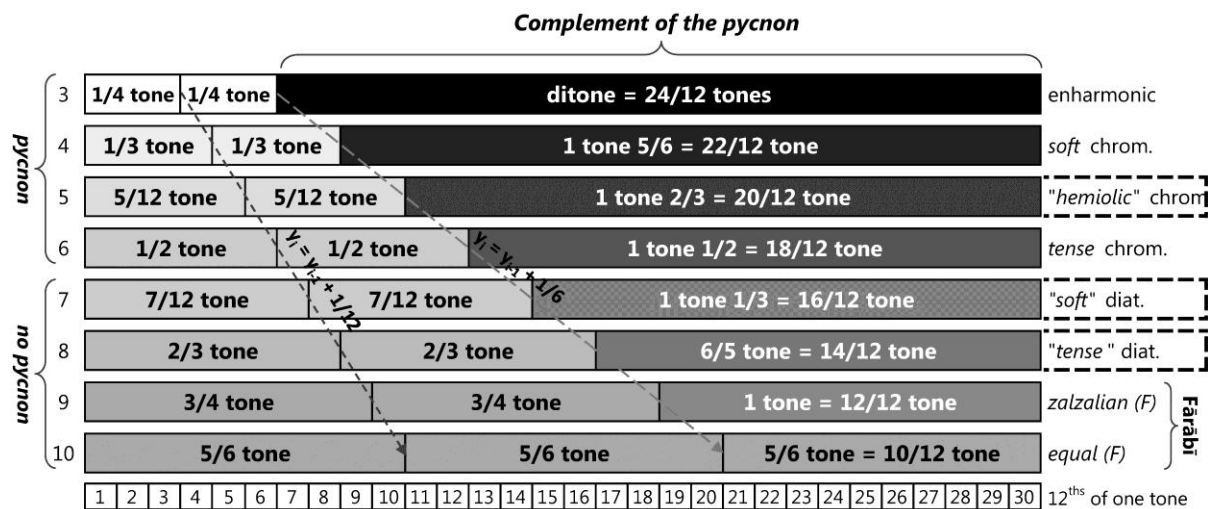

FHT 46 The “equal-intervals” hypothesis concerning Fārābī’s developments for Aristoxenos’ *genera* (1): the *hemiolic chromatic*, and the *soft* and *tense* diatonic tetrachords, in this hypothesis, would differ from Aristoxenos’ formulations.

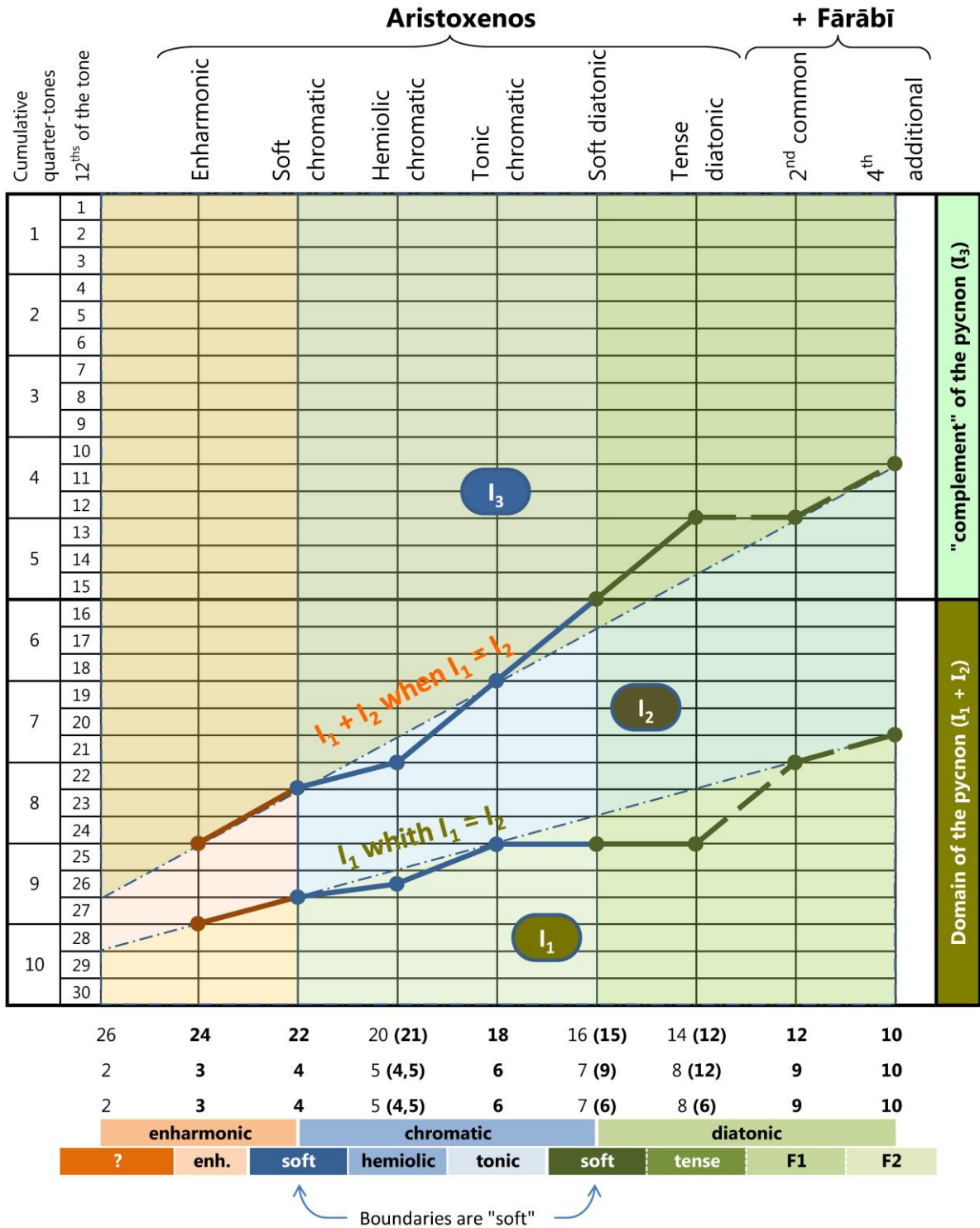

FHT 47 Detailed graphic for the “equal-intervals” hypothesis for Fārābī’s developments of Aristoxenos’ *genera*: the three rows below the graphic show successively the values of intervals I_3 , I_2 and I_1 in this hypothesis; values in **bold** correspond to the values of original Aristoxenos’ intervals (between parentheses when different from the hypothesis’ value); in this hypothesis, values of intervals I_1 and I_2 are equal and increase regularly (from left to right) in one twelfth of the tone, whenever I_3 decreases accordingly in one sixth of the tone. This graphic also shows that the “soft” *chromatic* and *diatonic* are internal boundary tetrachords between, respectively, the enharmonic and the chromatic tetrachords, and between the chromatic and diatonic tetrachords; Fārābī’s additions (to the right) are *diatonic* (Zalzalian) variations.

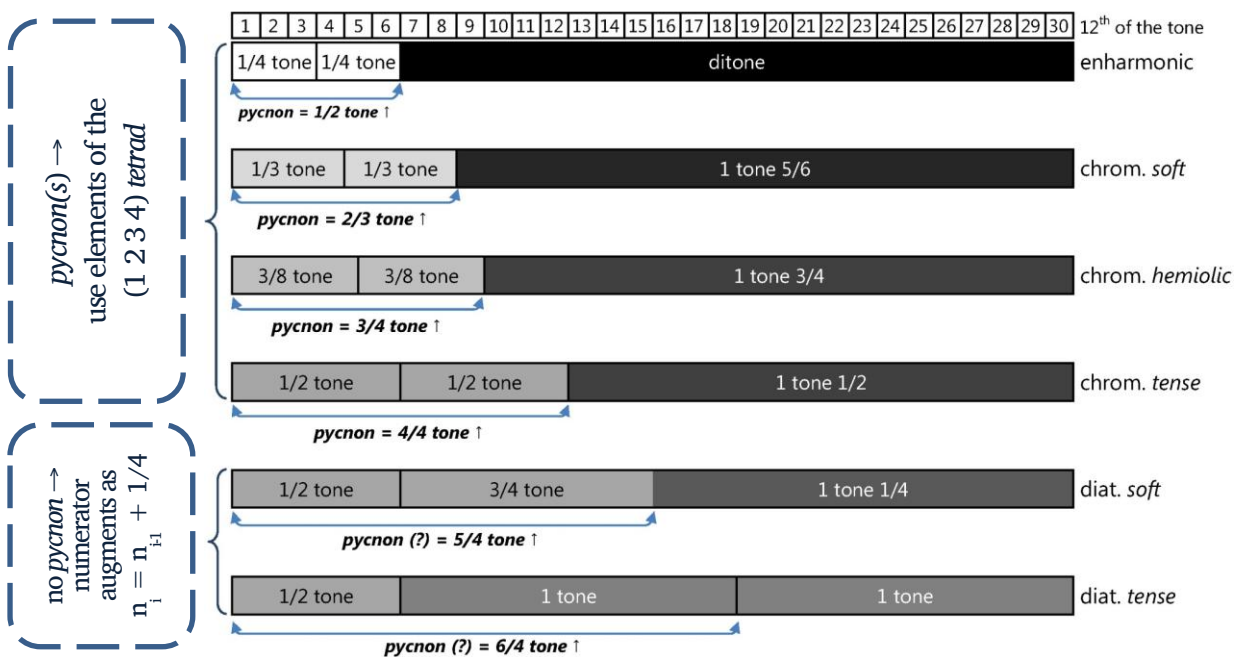

FHT 48 Aristoxenos’ use of the *tetrad* for his tetrachords: the *pycnon*’s sizes are, successively, 1/2, 2/3, 3/4, 4/4, a perfect Pythagorean system corresponding to the octave (“1/2”), the fifth (“2/3”) then the fourth (“3/4”) and the unison (“4/4”); this process explains the use of the 3/8 tone interval (as half of the 3/4 tone *pycnon*) for the chromatic *hemiolic* *genera*; note that the progression continues evenly (5/4, 6/4) for the “lower” intervals of the non-*pycnon* (*diatonic*) *genera* – see Slide No. 5 to listen to the various pitches delimitating the tetrachords.

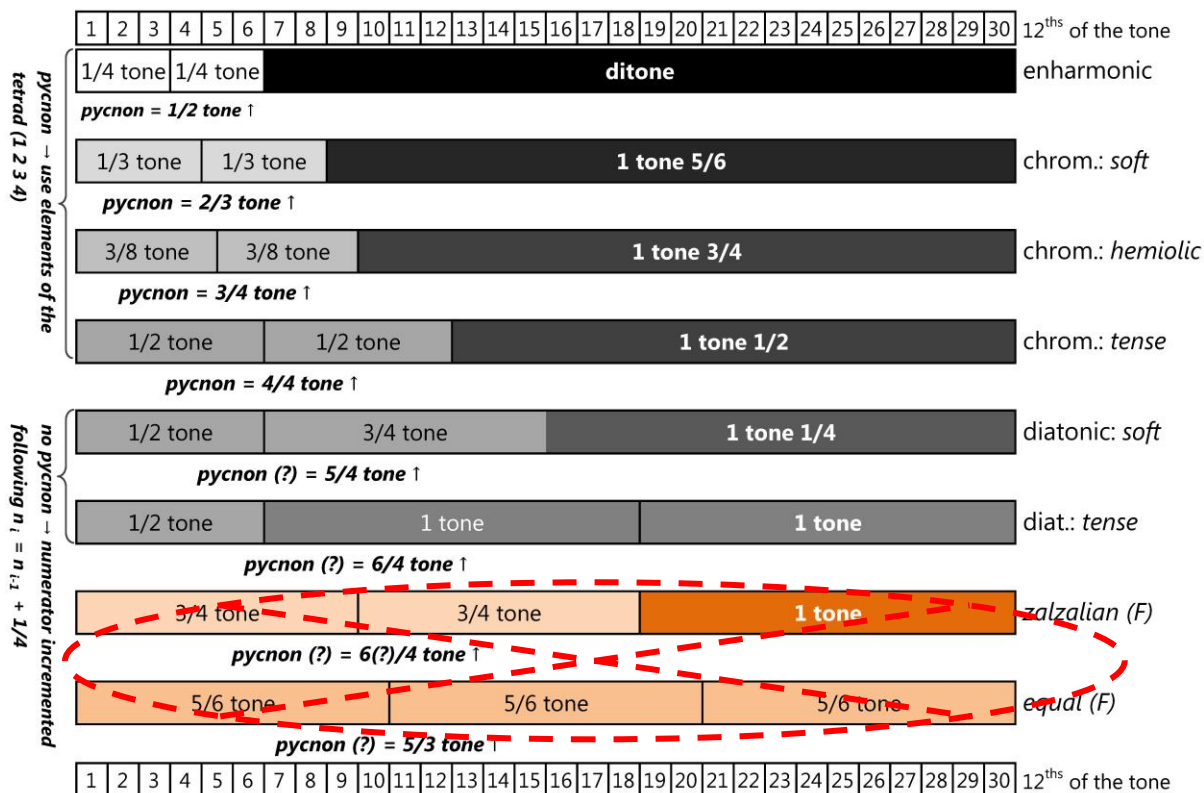

FHT 49 The “equal-intervals” hypothesis for Fārābī’s developments of Aristoxenos’ *genera* not fitting the Pythagorean model immanent in Aristoxenos’ exposé.

APPENDIX 4: ABOUT THE “RESONANCE” THEORY

As I put it in Chapter III, the Acoustic Resonance¹¹⁵⁰ Theory breaks down a “natural” (or “compound”) sound in a series of increasing partials¹¹⁵¹ (or “higher harmonics”) the frequencies of which are ideally equal to integer multiples of the fundamental sound (or “first “harmonic” sound).

Occidental music theory generally fails in taking account of this simple fact; I examine here the diverse applications of this theory and its implications¹¹⁵², either for melodic music, or (as in Occidental theories) for vertical and composed relations between partials or harmonics.

Three cases for inter-harmonics relations

The three types of relations between harmonics are illustrated on FHT 50, FHT 51 and FHT 52, p. 219. In the first case (FHT 50), the partials interact strictly with the fundamental sound, with in this example (limited to the first 5 harmonics) the emergence of the octave (2N/N)¹¹⁵³, the octave + fifth (3N/N), the double octave (4N/N) and the double octave + the harmonic third (5N/N).

Whenever these are the only interactions which should be considered, it is possible, in the case of melodic music, to consider the octave and the double octave (in FHT 51 – “Pragmatic melodic case” – 2N/N and 4N/N) as “secondary fundamentals”, in which case new intervals emerge¹¹⁵⁴, namely the fifth (3N/2N) and the harmonic third (5N/4N)¹¹⁵⁵.

¹¹⁵⁰ A complete retrospective of the gradual discoveries of Music acoustics can be found in [Bailhache, 2001], with additional articles from the same author available at <http://patrice.bailhache.free.fr/>, consulted 2016-07-20 09:02:15.

¹¹⁵¹ With decreasing intensities (levels).

¹¹⁵² Most of which are overlooked in standard theories of music.

¹¹⁵³ “N” being the frequency of the fundamental sound.

¹¹⁵⁴ Strictly between the partial and the lower octave multiples of the fundamental sound (powers of 2 of the fundamental frequency).

¹¹⁵⁵ This is the case chosen by Chrysanthos Madytos (FHT 43, p. 220), who in his *Theōrētikon mega* ([Chrysanthos (de Madytos) and Pelopidēs, 1832]) refused Occidental vertical logic when dealing with harmonics (see [Beyhom, 2015b, p.115–121] for more details).

The third case (FHT 52) is the “vertical generative process”, with harmonics interacting together whatever their rank may be and in both directions (*i.e.* including interaction with the upper harmonics). This is the only case in which the fourth (3N/4N), the “harmonic sixth” (3N/5N) and other intervals appear (for partials beyond 5N).

The fourth being an eminently “consonant” (and melodic) interval¹¹⁵⁶, another explanation should be found, in accordance with the Acoustic Resonance Theory.

Explaining the “consonance” of the fourth in the light of the Acoustic Resonance Theory

I know of two possible explanations for the consonance of the (Just) fourth, the two giving different rankings for the consonances of diverse intervals.

SOUNDING TWO NOTES SIMULTANEOUSLY¹¹⁵⁷

The first method consists in sounding two pitches simultaneously, considering that the full range of partials exists in their spectrum. In FHT 54, p. 220, different cases are proposed, from the (upper) octave to the whole tone, including the fifth and the fourth.

The harmonics of these sounds¹¹⁵⁸ coincide sometimes (fully for the fundamental sound and its octave), and sometimes not. We may observe on the figure that the number of blending (equivalent) harmonics decreases from the octave, passing through the fifth (less consonant), the fourth (less consonant) and finally the tone (the least consonant amongst the four considered cases).

This classical explanation is however limited, in this example, to two sounds emitted simultaneously; what would happen when considering, as Occidental theories suggest, all the partials as sounds simultaneously generated by the fundamental?

¹¹⁵⁶ In most non-Occidental musics.

¹¹⁵⁷ This is the theory of the “Coincidence des coups” of the 17th-18th centuries, perfected by Euler – see [Bailhache, 2001].

¹¹⁵⁸ 10 harmonics only are considered for the purpose of illustration in FHT 51.

CONSIDERING PARTIALS AS INDEPENDENT SOUNDS EMITTED SIMULTANEOUSLY WITH THE FUNDAMENTAL SOUND

This case is shown, for the first 8 partials¹¹⁵⁹, in FHT 55, p. 221. The first 8 harmonics are compared together (vertical relations), with the same partials, when compared to themselves (divided by themselves), giving the unity or unison (the black central diagonal from the upper left to the lower right of the table). The ratios given in the fourth column (from the left) are the ratios with the closest lower octave (the same ratios in the first row from top), *i.e.* those shown for the first 5 harmonics in FHT 51 (p. 219).

There are two criteria for “consonance” for intervals in this figure: 1) the higher the harmonic, the lesser the consonance (except for the unison), and 2) the closer the harmonics are in the series, the more consonant becomes the cross-relational ratio. The background for each resulting interval is darker when consonance augments, lighter when it diminishes.

In such case, the most consonant interval after the unison is the fourth with ratio 3/4, then the fifth with ratio 2/3, the whole tone 8/9, etc.¹¹⁶⁰

Intra-harmonic intervals

Let us lastly consider the linear relations between neighboring harmonics only, considering a low fundamental sound with frequency (for the sake of simplifying the computation) 20 hz (this is generally considered as the lower limit of hearing).

The suite of resulting harmonics would be:

20, 40, 60, 80, 100, 120, 140, 160, 180, 200, 220, 240, 260, 280, 300, 320, etc. hz (unending series and diminishing sound dynamics – in theory).

The successive inter-harmonic resulting ratios would reproduce the superparticular progression shown on FHT 57, p. 221, *i.e.*

1/2, 2/3, 3/4, 4/5, 5/6, 6/7, 7/8, 8/9, 9/10, 10/11, 11/12, 12/13, 13/14, 14/15, 15/16, etc.

¹¹⁵⁹ The ratio of the partials with the fundamental being their original ratio, it is not reproduced in the figure.

¹¹⁶⁰ Compare with Helmholtz' diagrams reproduced in FHT 56, p. 221.

The first four intervals generated by this process are the octave, the fifth, the fourth and the harmonic third, *i.e.* container intervals in the lower register (20-80 hz) of the human voice (in common speech¹¹⁶¹), whenever the following four intervals (4/5, 5/6, 6/7, 7/8) are various thirds to seconds which occupy the (ascending) medium low register (100-160 hz). The following four intervals still (8/9, 9/10, 10/11, 11/12) are the various tones used in generalized diatonism, and cover the medium high register (180-240 hz), while the last four intervals in this series of 16 (12/13, 13/14, 14/15, 15/16) represent a series of seconds generally assimilated to various “semi-tones”, and occupy the highest register of the human voice (speech – 260-320 hz).

It is easy to see that the middle “tones” (from 6/7 to 13/14), which occupy in this example almost completely the spoken register (120-260 hz, covering more than one octave), are the privileged intervals for melodic music, with the central “tones” 8/9, 9/10, 10/11, 11/12 generating in succession (FHT 58, p. 222) the ascending *diatonic* (Zalzalian) *rās* pentachord which, in the descending direction, becomes an equally *diatonic* (Zalzalian) *bayāt* pentachord.

This may explain the privileged use of Zalzalian seconds in *maqām* music (and others) while the *extended Zalzalian* zone of seconds (FHT 59, p. 223) covers the whole range of melodic music, with the *Pythagorean* (lowest) zone generating container intervals such as the octave, the fifth and the fourth, followed by the *harmonic* zone (a privileged *lieu* for harmonic music) and ending with the *higher harmonics* zone the usefulness of which may vary from the completion of tetrachordal or pentachordal (and why not octavial) structures to melodic variations of intonation.

* * *

¹¹⁶¹ “The voiced speech of a typical adult male will have a fundamental frequency from 85 to 180 Hz, and that of a typical adult female from 165 to 255 Hz” – [Anon. “Voice frequency”, 2015].

Plates for Appendix 4

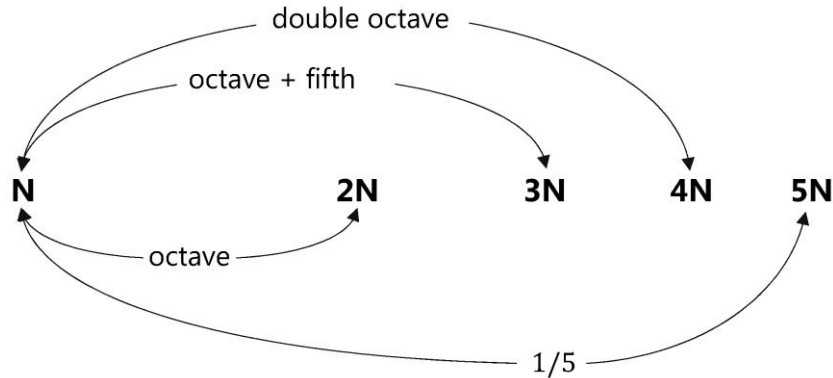

FHT 50 "Melodic" interaction process for the "Resonance theory": the relationships between harmonics occur only with the fundamental tone ("N", for "1 x N"), while the fifth or the fourth (see the following two figures) are not taken into account.

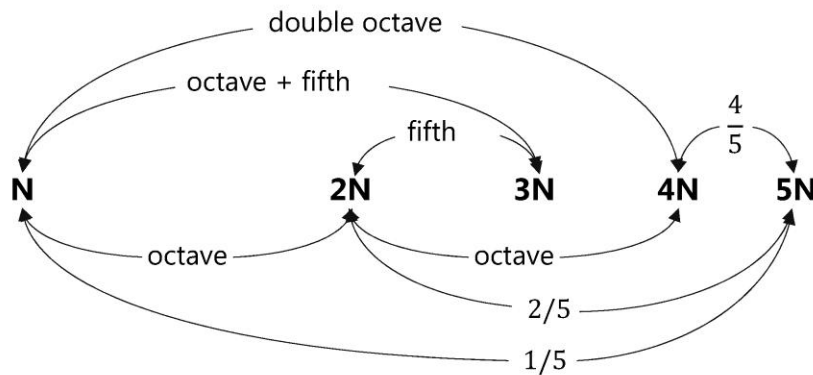

FHT 51 "Pragmatic melodic" generative process for the "Resonance theory": relationships between harmonics occur between the harmonics and the fundamental sound or its octaves only in the ascending direction (i.e. partials interact with the fundamental sound and with the octave of the latter immediately below them); in this case, the ratio of the fourth is still not "generated" by the process; this is the interaction process chosen by Chrysanthos Madytos (see [Beyhom, 2015b, p. 119 sq.] and FHT 53).

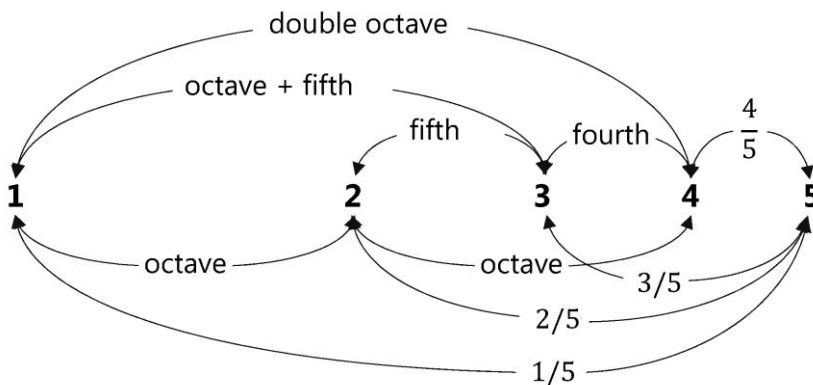

FHT 52 "Vertical" generative process for the "Resonance theory" as conceived in Occidental literature (i.e. as an extension of Pythagorean mathematics): the relationship between the fundamental sound ("N", for "1 x N") and the other harmonics (here 2 3 4 5) is extended to the relationships between harmonics, including in this figure the ratio $3/4$ which determines the fourth¹¹⁶².

¹¹⁶² This figure and the following are taken and translated from either of [Beyhom, 2010b ; 2010c ; 2015b].

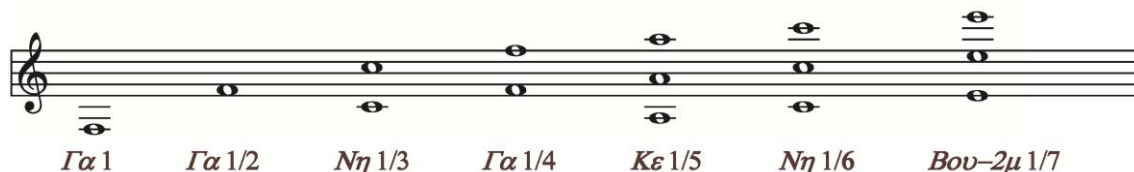

FHT 53 The first seven harmonics and their correspondence with Byzantine degrees of the scale according to Chrysanthos¹¹⁶³: notation of the partials pitch is approximate and provided exclusively as a reminder.

	Base	Octave	Fifth	Fourth	Tone (disj.)
etc.	etc.	etc.	etc.	etc.	etc.
Harmonic 10	10	20	15	13 1/3	11 1/4
Harmonic 9	9	18	13 1/2	12	10 1/8
Harmonic 8	8	16	12	10 2/3	9
Harmonic 7	7	14	10 1/2	9 1/3	7 7/8
Harmonic 6	6	12	9	8	6 3/4
Harmonic 5	5	10	7 1/2	6 2/3	5 5/8
Harmonic 4	4	8	6	5 1/3	4 1/2
Harmonic 3	3	6	4 1/2	4	3 3/8
Harmonic 2	2	4	3	2 2/3	2 1/4
Fundamental sound	1	2	1 1/2	1 1/3	1 1/8

	1 st sound	2 nd sound	3 rd sound	4 th sound	5 th sound
Pair 1	↑	↑			
Pair 2	↑		↑		
Pair 3	↑			↑	
Pair 4	↑				↑

FHT 54 How the “consonance” of the fourth can be explained (in Occidental – vertical – logic): when different tones are sounded simultaneously, some of their harmonics would (ideally) blend, reinforcing thus the “consonance” of these tones; the fourth, when sounded simultaneously (“paired”) with the “tonic” (the “fundamental sound” taken here as “1” – for “1 x N”, “N” being the fundamental frequency), has for example its third and sixth harmonics which coincide with the fourth and eighth harmonics of the fundamental sound¹¹⁶⁴.

¹¹⁶³ Adapted from [Beyhom, 2015b, p. 119] – a detailed comment of Chrysanthos’ explanations is proposed in [Beyhom, 2015b, p. 117–120]; Chrysanthos (according to the English translation [Chrysanthos (de Madytos) and Rōmanou, 1973, p. 20–21]) explains this progression: “From the outcome of the note combinations we know today of four symphonies:

the *diatriton βου δι 19* ; the *diatessarōn νη γα 28* ; the *diapente νη δι 40* ; and the *diapason νη νη 68*.

These four symphonies are verified with the following trial: When the low string of any sufficiently long four-stringed instrument is plucked, we hear its buzz, its octave and the other higher notes in this order:

1 1/2 1/3 1/4 1/5 1/6 1/7

γα Γα νη Γα κε Νη βου^ρ”; not only Chrysanthos did solely consider “melodic” relationships with the fundamental sound (*i.e.* the pragmatic approach considering exclusively relationships of the partials with the fundamental sound and its octaves), but he also did not try to pretend that the degree *βου* in this progression coincides completely with the 7th partial, a rare ethical position in musicology (compare with Chailley and Dommel-Diény in Chapter III of this dossier).

¹¹⁶⁴ Adapted and translated from [Beyhom, 2010c, v. 1, p. 68].

Ascending harmonics				Cross-related ratios: Vertical value / Horizontal value										
				1	1/7	1	1/6	1	1/5	1	1/4	1	1/3	1
8	N	3*octave 231,17	1 1/7	1 0,00	48/49 -35,70	20/21 -84,47	32/35 -155,14	6/7 -266,87	16/21 -470,78	4/7 -968,83				
7	N	266,87	1 1/6	1 1/48 35,70	1 0,00	35/36 -48,77	14/15 -119,44	7/8 -231,17	7/9 -435,08	7/12 -933,13				
6	N	315,64	1 1/5	1 1/20 84,47	1 1/35 48,77	1 0,00	24/25 -70,67	9/10 -182,40	4/5 -386,31	3/5 -884,36				
5	N	386,31	1 1/4	1 3/32 155,14	1 1/14 119,44	1 1/24 70,67	1 0,00	15/16 -111,73	5/6 -315,64	5/8 -813,69				
4	N	2*octave 498,04	1 1/3	1 1/6 266,87	1 1/7 231,17	1 1/9 182,40	1 1/15 111,73	1 0,00	8/9 -203,91	2/3 -701,96				
3	N	701,96	1 1/2	1 5/16 470,78	1 2/7 435,08	1 1/4 386,31	1 1/5 315,64	1 1/8 203,91	1 0,00	3/4 -498,04				
2	N	octave 1200,00	2	1 3/4 968,83	1 5/7 933,13	1 2/3 884,36	1 3/5 813,69	1 1/2 701,96	1 1/3 498,04	1 0,00				
1	N	orig.												

FHT 55 Cross-related ratios between the 8 first harmonics and alternative explanation of the “consonance” of the fourth¹¹⁶⁵.

Fig. 00 A.

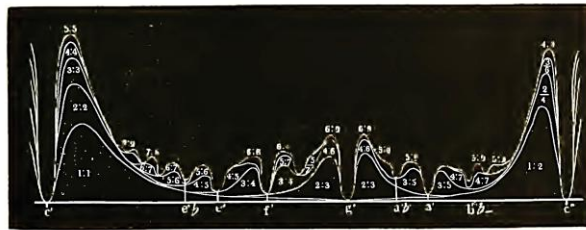
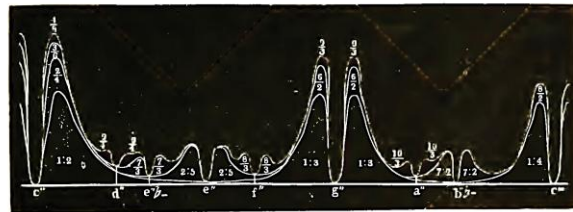

Fig. 00 B.



FHT 56 Two diagrams by Helmholtz showing “roughness” curves in relation with a fundamental sound¹¹⁶⁶.

	Tetrad			disj.				Ptolemaos				"half-tones"			
numerator	1	2	3	4	5	6	7	8	9	10	11	12	13	14	15
denominator	2	3	4	5	6	7	8	9	10	11	12	13	14	15	16
value in cents	1200	702	498	386	316	267	231	204	182	165	151	139	128	119	112
	8 ^{ve}	5 th	4 th	3 ^{rds}			Mostly seconds								

FHT 57 Superparticular progression (for n_i/n_{i+1}) with $n = 1$ to 15 ¹¹⁶⁷.

¹¹⁶⁵ Adapted and translated from [Beyhom, 2010c, v. 1, p. 65]: the first 8 harmonics are compared together (vertical relations), with the same partials, when compared to themselves (divided by themselves), giving the unity or unison (the black central diagonal from the upper left to the lower right of the table). The ratios given in the fourth column (from the left) are the ratios with the closest lower octave (the same ratios in the first row from top). Criteria for “consonance” are two: 1) the higher the harmonic, the lesser the consonance (except for the unison), and 2) the closer the harmonics are in the series, the more consonant becomes the cross-relational ratio. The background for each resulting interval is darker when consonance augments, lighter when it diminishes.

¹¹⁶⁶ [Helmholtz, 1877, p. 193]: like all the examples proposed in this appendix, the harmonics considered here are supposedly “ideal” (their frequencies are supposed to be equal to perfect multiples of the frequency of the fundamental sound); note also that Helmholtz formulations use unknown coefficients (he seems to have “cheated”), with an attempt at re-establishing these in [Baillache, 2016].

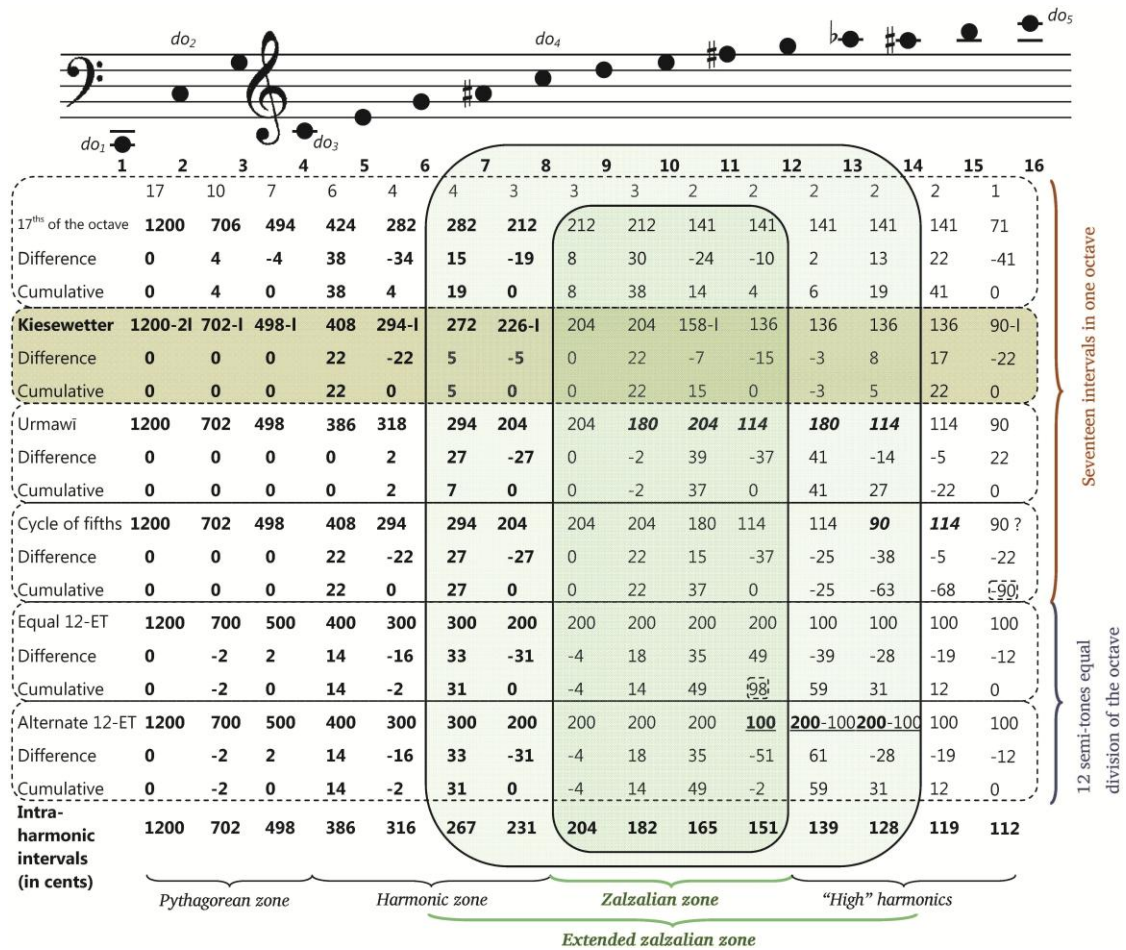

FHT 59 (Taken from the author’s habilitation thesis [Beyhom, 2010b]): Harmonic progression notated on the basis of a 17th Equal-intervals division or 17-ET (\sharp shifts by one elementary interval – see [Beyhom, 2010a; 2013], here a 17th of the octave – approx.. 71 cents, \flat lowers by the same value) with six sets of rows for 6 different divisions of the octave (and notations)¹¹⁶⁹.

¹¹⁶⁹ The first four sets are based on a division of the octave in 17 intervals. Set 1 (17th of the octave) is a proposition by the author: the numbers of the first row are values of successive intra-harmonics approximated in 17th of the octave (for example, between the 3rd and 4th harmonics, seven 17th of the octave are an approximate match (494 cents) for the Just fourth the value of which should be 498 cents as shown in the lowest row (“Intra-harmonic intervals”); the difference, -4 “cents”, is shown in the third row of this set and the cumulative differences (positive and negative differences added) are shown in the last row (below). The second set shows Georg Kiesewetter’s reading of Urmawī’s (and probably other Systematists’) theories, based on the division of the Pythagorean tone in three equal thirds of the tone (i.e. 3 x 67 cents), with *mi-fa* (*e-f*) and *si-do* (*b-c*) equal to a *leimma* (approx.. 90 cents); elementary intervals are here the *leimma* and the third of the tone. The third set shows Urmawī’s division of the octave in his first treatise – the well-known *Book of Cycles* – based on a *leimma* + *leimma* + (*Pythagorean*) *comma* division of the tone, *mi-fa* (*e-f*) and *si-do* (*b-c*) being also equal to a *leimma*; the upper intra-harmonic intervals are approximated with combinations of *leimmata* and *commata* (these first three “notations” approximate at best the harmonic progression, with Kiesewetter’s notation showing more regularity along with the smallest differences with intra-harmonic intervals, and Urmawī’s division showing exceptional correspondence with the first five harmonics). The fourth set shows the intervals “generated” by a cycle of ascending Just fifths (\sharp shifts by an *apotome* – approx. 114 cents, \flat lowers by the same value): discrepancies can be as far as 90 cents (for the 16th harmonic); 11th to 15th harmonics are notated g^\flat , g natural, g^\sharp , a , a^\sharp . The last two sets are both 12-ET based (equal-temperament division of the octave on a half-tone basis) but with two different notations: the upper set takes g, a, b for the 12th and 13th harmonics – as seen in [Dommel-Diény, 1986, p. 31], whenever the second set corresponds to alternate notations for the 13th harmonic (g_4^\sharp or a_4) found in [Chailley, Challan, and Delvincourt, 1947, p. 6] and in Nicolas Meeüs’ course of Organology for the Université de la Sorbonne in Paris (2009); discrepancies go as far as the semi-tone in both (sets of) notations. Notes on the harmonic progression and notation: do_1 (“ c_1 ”) is here per convention the fundamental sound; the progression may be divided in four parts, the first four harmonics compose what I call the “Pythagorean zone” with the intervals of the octave, the fifth and the fourth; the second part I call the “Harmonic zone” with the so-called “Harmonic third” and various “augmented” seconds; the third part is the *Zalzal* zone with the progression 8 9 10 11 12 (or 8:9:10:11:12), a prototype (in its upper part 9:10:11:12) of Ptolemaos’ “equal-diatonic” tetrachord, and of the Arabian-Persian-Turkish *jins rāst* – see Slide No. 20 to listen to various pitches and intervals of the progression.

APPENDIX 5: THE MYTH OF THE ORGAN(S) IN BYZANTINE CHURCHES (BEFORE “THE FALL”)¹¹⁷⁰

Egon Wellesz and Henry Julius Wetenhall Tillyard are known¹¹⁷¹ as the founders of Modern (musicological) Byzantinology. Their “findings” on Byzantine chant are based on the assumption that “Old” (“Medieval”) byzantine chant was solely “diatonic” (in the restricted Western understanding of the term, *i.e.* “ditonic”).

In order to support this thesis, three main argumentations were used:

1. Ancient Church music was “simple”, *i.e.* ditonic.
2. Byzantine chant was originally ditonic but Ottoman influence after “the Fall” changed its structure which became “Oriental”.
3. Byzantine churches in Constantinople used to have, prior to the Fall (1453), organs for singing training.

Of these arguments, the first (Ancient Church music was ditonic) can simply not be substantiated, although an attempt at “proving” such an assertion is examined in the next appendix¹¹⁷².

The second argument (Ottoman influence) has been examined elsewhere¹¹⁷³ and may be reversed, as sophisticated Byzantine music may well have itself influenced Ottoman music¹¹⁷⁴.

The third argument (the tale of the organs in Byzantine churches) fell in desuetude only recently, but

¹¹⁷⁰ This appendix and the next are based on (as well as translated and partly expanded from) my book on Byzantine chant theories and praxis [Beyhom, 2015b], notably the Appendix entitled “Origines et ‘diatonicité’ hypothétique du chant byzantin”; please note that this appendix with the following are considered as two faces of the same problematic, the conclusions of which are provided at the end of Appendix 6.

¹¹⁷¹ Not forgetting Amédée Gastoué in France.

¹¹⁷² Furthermore: most rural *maqām* music is “simple”, structurally, with an ambitus rarely exceeding the fifth: a typical example is the Middle Oriental (Lebanon-Syria-Palestine, where “Folk” music is mostly Zalzalian) *Dal’ūnā* which is the prototype of the Zalzalian *genus bayāt*, and evolves in successive seconds (or unisons) from *d* to *g*, with two Zalzalian seconds between *d* and *e* and between *e* and *f* (contemporary interpretations exceed this ambitus); such traditional melodies remain however Zalzalian, which will still not be “simple” for “musicologists” such as Wellesz and Tillyard.

¹¹⁷³ And will be further expanded as explained in Chapter IV.

¹¹⁷⁴ See the discussions and remarks on the influence of Persian music on Arabian music in footnotes 507 p. 116, 853 p. 158 and mostly 978 p. 171.

was never seriously disproved and recent editions of Egon Wellesz’s book still mention these “Byzantine church organs”.

This assumption hides another implicit one: Organ music can only be semi-tonal; as a result, and because Byzantine churches (prior the Fall) had organs, Byzantine chant was necessarily ditonic.

The origin of the myth

Egon Wellesz mentions, in the 1981 edition of *A History of Byzantine Music and Hymnography*, “Byzantine Church organs” which would have been used in the Byzantine churches by the time of the Fall of Constantinople to the Ottoman Turks in 1453; Wellesz considers, notwithstanding that the temperament of these (hypothetical) “organs” is unknown to us, that these “organs” are a clear proof of the ditonicity of Byzantine chant in the pre-Ottoman period; Wellesz makes a general reference for this to a series of 4 articles, written between 1929 and 1933, by Mahmoud Raghīb, and to an article by Amédée Gastoué published in 1930¹¹⁷⁵ (in the same review as Raghīb’s) which cites the first of Raghīb’s articles as a reference.¹¹⁷⁶

¹¹⁷⁵ [Gastoué, 1930].

¹¹⁷⁶ [Wellesz, 1980, Excursus p. 10]: “Organs. In a series of four articles in *Revue de Musicologie*, 1929-33, Mahmoud Raghīb collected excerpts from a number of Turkish sources which confirm the use of organs in Christian churches in the East. He quotes (*ibid.*, no. 36, Nov. 1930, p. 262) the report of a Turkish traveller in 1075 who describes the organ and says that ‘the instrument is played on certain days in the majority of churches’. A. Gastoué [é], in his *Notes sur l’orgue en Orient* in the same journal (no. 33, 1930, p. 20), rightly draws attention to the fact that the Byzantines had organs in their churches at least at the time when the Turks took possession of the country. He points out that the Turkish musicians were unable to play these instruments because they were used to different and much smaller intervals than the Byzantines. **Gastoué confirms an opinion which I had expressed since 1917, namely, that the transformation of the old Byzantine tonality took place under Turkish influence, and only during these last centuries.** Before that happened tonality was diatonic in Byzantium as well as in Syria. **The reports, however, of Arabic and Turkish writers need not upset our former views about unaccompanied Byzantine Chant.** I should like to suggest that portable organs, such as were used in the Imperial Palace, in the Hippodrome, and for processions, were used in the teaching places attached to a church as a help to the singing master. In the last phase of the Empire they may have been used in the churches as well, perhaps as a kind of ‘organum’, the ‘Ison’ of the Byzantines, *i.e.* a kind of drone

→

Raghib's 4 articles on the "Byzantine organ" extend from 1929 to 1933¹¹⁷⁷. Wellesz "quotes" (singularly) only the 1930 article¹¹⁷⁸, although two more articles were published in 1933. Furthermore, Wellesz chooses to neglect all "other" Arabi[an] and Turkish authors citing unaccompanied Byzantine chant¹¹⁷⁹.

How the myth was established

Raghib begins his 1929 article¹¹⁸⁰ by an erroneous reference to Hārūn a-r-Rashīd's gift to Charlemagne¹¹⁸¹,

→

which represents a primitive stage of polyphony, a stage which was never passed in the East".

¹¹⁷⁷ These articles, which (because of their similar titles) we shall refer to as "the first article", "the second article" etc., are:

- Raghib, Mahmoud, "Descriptions d'orgues données par quelques anciens auteurs turcs", *Revue de Musicologie* 10 30 [1929-5-1] [doi: 10.2307/925415] p. 99-104.
- Raghib, Mahmoud, "Descriptions d'orgues données par quelques anciens auteurs turcs. II", traducteur Eugène Borrel, *Revue de Musicologie* 11 36 [1930-11-1] [doi: 10.2307/926188] p. 260-264.
- Raghib, Mahmoud, "Descriptions d'orgues par des Auteurs Turcs et Persans (III)", traducteur Eugène Borrel, *Revue de Musicologie* 14 45 [1933-2-1] [doi: 10.2307/926487] p. 16-23.
- Raghib, Mahmoud et Eugène Borrel, "Descriptions d'orgues par des Auteurs Turcs et Persans (IV). Fin", *Revue de Musicologie* 14 46 [1933-5-1] [doi: 10.2307/925450] p. 86-91.

¹¹⁷⁸ The 1929 article contains no citations whatsoever about Organs in Byzantine churches, but only an assertion by Raghib.

¹¹⁷⁹ See footnote 1176: picking (false, as we shall see) singular information and presenting it as the only truth possible is clearly a non-scientific approach of a problem.

¹¹⁸⁰ Referenced in the Bibliography as [Raghib, 1929].

¹¹⁸¹ Raghib was clearly an unreliable author, still pretending, in this first article, that Hārūn a-r-Rashīd, Caliph of Bagdad, was among the first who sent an organ to Charlemagne, imitating thus the Byzantine rulers in that time. This "positif" – a portable instrument (see Fig. 58 p. 117 for a specimen) – was supposedly made by a certain Djafér [Ja'far] in the 9th century A.D. It seems that Hārūn a-r-Rashīd never sent an Organ to Charlemagne, as explained in [Bittermann, 1929a, p. 215]: "It has been common tradition that, among his other gifts, Hārūn a-r-Rashīd presented Charlemagne with an organ. Indeed, few other memories of the negotiations between the two rulers are apt to remain so clear. Having occasion to hunt for that particular reference, I was somewhat perplexed at my inability to find the gift mentioned in any of the French sources. None of the Arabian sources which I consulted even mentioned an embassy sent to the Frankish King by the Caliph. In a long and intriguing search, it finally developed that, like many other charming bits of history, the organ sent to Charlemagne by Hārūn a-r-Rashīd had never existed. The tale was based quite literally on fiction. It seems that in the eighteenth century, M^{me} Stéphanie de Genlis wrote a novel, *Les Chevaliers du*

→

supposedly an organ, a "fairy tale" that the same Gastoué refuted in his book about the Organ in 1921¹¹⁸². Nevertheless, in 1930, Gastoué refers¹¹⁸³ to

Cygne, in which she pictured the delivery of the organ, made by an Arabian named Giafer. Rimbault took over the notion in his History of the Organ, saying that 'it also appears that an organ, constructed by an Arabian named Giafer, was sent to Charlemagne by the renowned 'Commander of the Faithful,' the caliph Hārūn a-r-Rashīd — an incident introduced with considerable effect by Madame de Genlis in her romance *Les Chevaliers du Cygne*.' Audsley then adopted the story, saying that Hārūn a-r-Rashīd had presented Charlemagne with an organ, which must have been the instrument to which Walafrid Strabo referred, and whose tone he described as being so sweet that a woman lost her life in ecstasies while listening to it. Later G. Grove's *Dictionary of Music and Musicians* introduced the story into the article on the organ, saying that Hārūn a-r-Rashīd presented Charlemagne with an organ of exceptionally sweet tone which had been made by an Arabian named Giafer. And such is the form which the legend has taken in many and diverse histories of organ construction. The story is highly improbable. In no place do we find mention of the gift in the French annals. But assuming that M^{me} de Genlis had read through the sources, it is possible that she confused the term 'clepsidra' with an hydraulic organ in the enumeration of gifts from Hārūn found in the *Einhardi Annales*. That is the sole possibility of authenticity which I can suggest. The Giafer mentioned may have been one Dja'far, who was the most intimate friend of the Caliph. He certainly was not a man to become voluntarily an organ-builder. However, the name seems to be as common among the Arabs as our well-known Smith, so it in itself proves nothing. Of greater significance is the fact that the Arabs seem not to have made organs, either of the hydraulic or pneumatic variety, until the ninth century. Certainly the instrument was not indigenous to the Arab. So it would seem that the gift of an organ to Charlemagne was never made by Hārūn a-r-Rashīd" – (transliterations for the name [a-r-] Rashīd have been unified, in this quote, with other occurrences of the name in this dossier) – please note from the same author, in an article published the same year [Bittermann, 1929b, p. 403]: "The organ in particular was used in Byzantium only for purely secular purposes"; note also that the "Musicians" mosaic discovered in the Hama governorate in Syria (FHT 61 p. 232) seems to show an organ as soon as the 1st century B.C., while the archeological remains of "the oldest organ in Christendom" seem to date from the 12th century (see [Montagu, 1984]).

¹¹⁸² [Gastoué, 1921b, p. 32, footnote n°1]: "[A]insi, dans les très curieux passages qui regardent les échanges d'ambassades et de présents entre Charlemagne et Hārūn a-r-Rashīd (que nos chroniques nomment Aaron-Amir el Moumim). On y voit, entre autres choses, que le roi des Francs avait le plus vif désir de posséder un éléphant, dont la demande, l'expédition, l'arrivée et plus tard la mort sont soigneusement notées, entre deux traités de paix ou d'autres importantes affaires (l'éléphant mourut en 810). Les présents de Hārūn comportaient des objets divers, produits de l'industrie orientale, les clefs de la basilique du Saint-Sépulcre, une horloge sonnante, ce qui ne s'était jamais vu, etc. ; il n'y est nulle part question d'orgue ou d'autre instrument de musique".

¹¹⁸³ [Gastoué, 1930].

→

Raghib's (first) article as a "proof" for the existence of organs in the Byzantine churches before the Ottoman conquest, and infers that the Byzantine musical system was ditonic, which comforts Wellesz in his "intuition".

In short, Raghib postulates, without any proof whatsoever and in the first article (of the series of 4, published in 1929), that "organs" indeed were in use in the Byzantine churches prior to the Ottoman conquest in 1453¹¹⁸⁴.

However, Raghib publishes in 1930 a second article¹¹⁸⁵ where he "softens" his postulate¹¹⁸⁶ in the first article and revises a number of translations; the outcome in his last article is that he has no proof whatsoever of the existence of the "Byzantine Church organs".

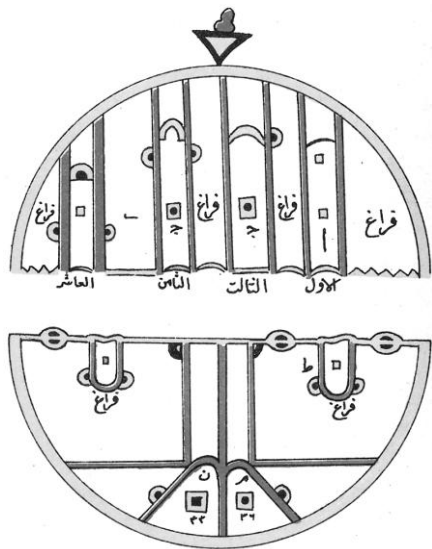

FHT 60 A schematic representation of the "Automatic Organ" by the Banū Mūsā (9th century)¹¹⁸⁷.

Deconstructing the myth

Let us examine first what Amédée Gastoué, a renowned French author and Byzantinologist, had to say about Raghib's first article:

"The texts cited by Mr. Raghib show that the organ was in use in Byzantine churches; this observation, coming from the testimony of a contemporary¹¹⁸⁸, is highly remarkable, as it

has been thought until now that the Byzantine Church never used this instrument. The precise documentation¹¹⁸⁹ given by the Turkish observer shows the contrary and that, to the least for the period when the Turks settled in Byzantium, the churches did use this instrument (also in use, incidently in the Imperial palaces and at the Circus). The very just remark of the old author confirms equally this fact, that Byzantine music, in that period of time, was still based on tones and half-tones, as the author [Raghib] deplores the impossibility for Turkish musicians to use these organs, their [Musical] Art being based on smaller and different intervals. It is hence quite true ["exact"] that Ancient Byzantine tonality was transformed under the influence of Turkish music, only with the last preceding centuries. Before, it was mostly diatonic, as pointed out by Byzantine authors of the preceding period"¹¹⁹⁰.

Let us first note that Gastoué's desire of "proving" that Byzantine chant was "mostly diatonic" is here overwhelming, as "diatonism" in the writings of "Byzantine authors of the preceding period" is not a synonym of "ditonism" (or the Occidental acceptance of diatonism).

These assertions of Gastoué are even more surprising when compared with his previous writings, for example in his *Introduction à la paléographie musicale byzantine* in which he considers the whole period from the 12th to the 19th centuries as a whole, with no sharp division marked by "the Fall" of 1453¹¹⁹¹.

However, in his article about Byzantine chant in the *Dictionnaire du Conservatoire* (1921), he had already

¹¹⁸⁹ This assertion of "precision of the documentation given" by Tchelebi is, to the least, surprising as we shall see, even in the case where Gastoué used here the term "documentation" for "description".

¹¹⁹⁰ [Gastoué, 1930, p. 20]: "Les textes cités par M. Raghib montrent que l'orgue était en usage dans les églises byzantines : cette observation, venant du témoignage d'un contemporain, est hautement remarquable. On a en effet cru jusqu'ici que l'Église grecque n'avait jamais employé cet instrument. La documentation précise donnée par l'observateur turc montre qu'il n'en est rien, et que, au moins à l'époque où les Turcs s'établirent à Byzance, les églises se servaient de cet instrument (en usage, d'ailleurs, dans les palais impériaux et au Cirque). La remarque très juste du vieil auteur confirme également ce fait, que la musique byzantine, à cette époque, était encore basée sur les tons et les demi-tons, puisqu'il déplore que les musiciens turcs ne puissent se servir de ces orgues, leur art étant basé sur des intervalles différents et plus petits. Ainsi, il est parfaitement exact que la transformation de l'ancienne tonalité byzantine a eu lieu sous l'influence de la musique turque, et seulement depuis les derniers siècles. Précédemment, elle était surtout diatonique, comme l'indiquent les auteurs byzantins de l'époque antérieure".

¹¹⁹¹ [Gastoué, 1907, p. 1-4].

¹¹⁸⁴ This discussion is detailed in the next section.

¹¹⁸⁵ [Raghib, 1930]: this is the article quoted by Wellesz.

¹¹⁸⁶ Without actually pin-pointing the blunder.

¹¹⁸⁷ [Banū Mūsā, s.d. (IX^e siècle), p^o 116].

¹¹⁸⁸ The unnamed author is most probably Evlia Tchelebi, cited by Raghib in [Raghib, 1929, p. 101] (see further in the main text).

expressed his opinion about the change undergone by Byzantine chant under the Ottoman Turks, calling the resulting chant “Byzantine-Turkish”¹¹⁹², although he does not mention Organs in Byzantine churches in this article or in his book on the organ (same year) *L’orgue en France, De l’antiquité au début de la période classique*¹¹⁹³. It seems then that he, and others, were waiting for a “proof” of their “intuitions” and beliefs¹¹⁹⁴ on Byzantine chant in the post 1453 period, which they seemingly found in Raghīb’s articles¹¹⁹⁵.

In his 1929 article, besides his affirmation on a-r-Rachīd’s gift of an organ to Charlemagne, Rāghīb begins with an erudite exposé on the *erganon*¹¹⁹⁶, gleaned in various documents concluding:

¹¹⁹² [Gastoué, 1921b, p. 548]: “Le dernier compositeur de cette école [preceding the first Reform of Byzantine chant in the 19th century], qu’on pourrait nommer byzantino-turque, est Pierre de Péloponnèse”, and [Gastoué, 1921b, p. 542] for the “influence of Arabian and Persian music” on Byzantine chant: “Un point seulement reste acquis : l’influence sans cesse grandissante de la musique arabe et persane, qui pénètre le vieux chant byzantin dans la structure de ses gammes et peut-être de ses rythmes. Ce dernier détail, cependant, laisse entr’ouverte la porte à un intéressant, presque passionnant problème. Vers la fin du XVI^e siècle, et dans tout le cours du XVIII^e, nous savons d’une manière certaine que les compositeurs byzantins travaillaient sur les mêmes modèles rythmiques que les musiciens turcs”.

¹¹⁹³ [Gastoué, 1921a].

¹¹⁹⁴ Which we can today call “biases”.

¹¹⁹⁵ This is to say that all assertions, presumptions and “intuitions” about the ditonicity of “Medieval Byzantine chant” (pre-1453) were mere hypotheses and assumptions. Moreover, it may be interesting to investigate this whole matter building on the possibility that Gastoué, Borrel (translator of at least one of Raghīb’s four articles, and later the author of an article [Borrel, 1950] relating very faithfully the scales resulting from the Second Reform of Byzantine chant in the 19th century) and Raghīb himself coordinated, more or less, the publications of these articles for the sake of “proving” the ditonicity of this chant, and to which extent Wellesz or others may have participated in this process.

¹¹⁹⁶ Probably an Ancient Greek denomination via the Arabic language – see [Owen, Williams, and Bicknell, 2007, §I: Word origin]: “Plato (*Laws*) and Aristotle (*Politics*) both used the term ‘organon’ to denote a tool or instrument in a general sense: something with which to do a job of [?] work (*ergon*, from root *uerg-*; cf *Werk*, ‘work’). Plato (*Republic*) and later authors also used it to denote any kind or all kinds of musical instrument or contrivance. No Greek author used it to mean ‘pipe organ’, and even in the term ‘hydraulic organ’ (1st century C.E.) used by Hero of Alexandria ‘organ’ has the sense of tool, so that the whole term properly indicates ‘an aulos-like device or instrument, operated by water’. (In this context, moreover, ‘aulos’ may indicate not the musical wind instrument of that name but ‘pipe’, ‘conduit’ etc.; thus ‘hydraulic’ refers to the water and air conduits.) Classical and patristic Latin show a fairly clear evolution of the terms ‘organum’, ‘organa’, ‘organis’ from a general to a specific sense, and a musical

“Persian poet Ḥāfīz of Shīrāz¹¹⁹⁷, in his ‘Muganni Namé’ (Book of singers) mentions the *erganon* among the instruments used in his time in Baghdad (end of the 14th century). It is the last document we have on the usage of the organ in Oriental countries”¹¹⁹⁸.

He asserts then, somewhat abruptly:

“The instrument soon fell into desuetude. On their Entrance in Constantinople, the Turks neglected it. The main reason must be that the organ cannot play the quarter-tone”¹¹⁹⁹.

Let us note that there are two assumptions in the latest quote which unequivocally show the biases of musicology at that time; the first assumption is that organs can only be tuned in a ditonic (or semi-tonal) fashion¹²⁰⁰. The second assumption is that Turkish music uses (or “used”) “quarter-tones”¹²⁰¹.

→

connection is often clear from the context, more consistently so than in Greek. 9th- and 10th-century Arabic had its own versions of the Greek, for example *hedhrula* (‘hydraulis’) and *urghanon* (‘organon’). The use of ‘organum’ to denote a kind of polyphony is of course post-classical”.

¹¹⁹⁷ Most probably Shams-a-d-Dīn Muḥammad Ḥāfēz-e [al-] Shīrāzī (1325/26–1389/90) – see [Anon. “Hafez”, 2016], whose poems can be found in English (for example [Khwaja Shamsu-d-Din Muhammad-i-Hafiz-i-Shirazi, 1970]) and in French (see [Khwaja Shamsu-d-Din Muhammad-i-Hafiz-i-Shirazi, 2010]) translations.

¹¹⁹⁸ [Raghīb, 1929, p. 99–100]: “Le poète persan Hafiz de Chiraz, dans son ‘Muganni Namé’ (livre des chanteurs) parle de l’*erganon* parmi les instruments employés de son temps à Bag[h]dad (fin du XIV^e siècle). C’est le dernier document que nous ayons sur l’usage de l’orgue en pays orientaux” – note that, in a personal communication, Jean During finds that this description of an “*erganon*”, in Baghdad (namely) and at that time, is very doubtful. ¹¹⁹⁹ [Raghīb, 1929, p. 100]: “L’instrument ne tarda pas à tomber en désuétude. En entrant à Constantinople, les Turcs ne s’en occupèrent pas. La cause principale doit en être que l’orgue ne pouvait donner les quarts de ton”.

¹²⁰⁰ The same is generally assumed for Ancient Greek instruments, although Chailley did write about the *aulos* that it had a Zalzalīan tuning (see [Chailley, 1979, p. 83]), quoting Aristoxenos’ diatribe against the “Harmonicists” (see footnote 1116, p. 209) with the resulting scale according to Ruelle shown in FHT 40, p. 209 (Appendix 2); it is worthy to note, however, that Chailley (same page: “[Cette échelle] disparut par la suite”, “[This scale] later disappeared”), while at first seemingly accepting the existence of this scale at some point in Greek music history, asserts its later disappearance, without however giving a clue as to why and from where this information was obtained (nothing in the following paragraphs from Aristoxenos’ treatise seems to confirm this assertion) unless Chailley meant that “it disappeared from written [scarce, theoretical] sources”.

¹²⁰¹ Let us remember here that *maqām* music uses intervals (frequently assimilated to three-quarter-tones intervals) of seconds the values of which lie between Occidental (classical, if not tempered) tones and semitones, or between the boundaries of the

Raghib pursues, seemingly getting here to the point:

“Concerning the organs of Byzantium, one of the most valuable document we could consult is, with no doubts, the description of the *Burhan Katé* dictionary, both while it is posterior to Byzantine documents which relate to the subject¹²⁰², and because it casts doubt¹²⁰³ on (if it does not ruin completely) the general conviction that Byzantine Orthodox churches¹²⁰⁴, in the 16th and 17th centuries¹²⁰⁵, did not use organs. Historians of the term ‘erganon’ explain other interesting meanings which are all suggestive¹²⁰⁶. The *Burhan Katé* was written in the 9th century of the *Hijra*¹²⁰⁷ by the Persian Husséin bén Tébrizi¹²⁰⁸; the famous Turkish

→

tones and the 1 ½ tones (frequently assimilated to the five-quarter-tones intervals) and sometimes greater (in praxis, or in both praxis and theory in Byzantine chant); quarter-tone intervals *per se* are seldom used, and generally for small variations the function of which being to underline the tonic or any other pivotal degree of the scale. Moreover, the vast majority of Turkish theoreticians would today probably react very negatively to such assertions, in the belief (largely initiated by Rauf Yekta Bey’s theories, but contradicted by scholars such as [Feldman, 1996] and, recently in NEMO-Online, by [Olley, 2012] – for various intonations of the *chromatic* tetrachord in *maqām* music, including Modern Turkish music, see [Beyhom, 2014a]) that Turkish music is a “comma” based music (or “Harmonic”, or “Just-Intonation” based). Raghib should have been aware of this fact, as Yekta Bey’s article in the *Encyclopédie de la musique et dictionnaire du conservatoire* [Yekta, 1922] had been published for a few years then; but, again, Raghib was not writing for the Turks, but for occidental musicologists (which takes us back to note 1195).

¹²⁰² Raghib has not mentioned yet, in this article, one single Byzantine document dealing with the subject: the rest of the article contains similarly no reference whatsoever to such documents.

¹²⁰³ Clearly, Raghib had no doubts whatsoever of the existence concerning the existence of organs in the Byzantine churches, because he asserts this already in the preceding quote.

¹²⁰⁴ The stress on “orthodoxy” is interesting here: its purpose will be made clear in the following paragraphs.

¹²⁰⁵ Let us note here that Raghib does not mention the period before the “Fall” in 1453, but the period after.

¹²⁰⁶ Raghib seems to imply that he gave at least one definition of the “erganon” up till this point in the article, which is not the case.

¹²⁰⁷ 17th century C.E. according to Raghib in his footnote.

¹²⁰⁸ Ḥusayn Ibn Tabrīzī, or Burhān, Muḥammad Ḥusayn ibn Khalaf Tabrīzī, active in the 17th century, and author of the *Burhān-i Qāṭi’*, a Persian dictionary of over 19,000 words, dedicated to (the) Šulṭān ‘Abd-Allāh Quṭb Shāh [ruled Golconda 1626-1672] – see [معین، محمد، 1963 and برهان، محمد حسین بن خلف تبریزی] “Burhān, Muḥammad Ḥusayn ibn Khalaf Tabrīzī active 17th century [WorldCat Identities]”; Anon. “Burhān-i qāṭi’., by Muḥammad Ḥusayn ibn Khalaf Tabrīzī Burhān | The Online Books Page”].

lexicographer Assef éféndi¹²⁰⁹ translated it, expressing many Arabic and Persian words: it is from this [last] source that we take the text, as we could unfortunately not see the original¹²¹⁰. Follows the text:

‘*Erganon*, well-known instrument, invented by Plato. Nestorians and Greeks use it in churches on fixed days. Hollow stems such as reeds, numerous, thick and thin are placed in [hearing] acuity order. On the back side there is an object like [resembling] a bellows; by manipulating it; the produced melody gives these stems a sound resembling the sound of a Pan-flute. Some (people) say that *Erganon* means *mazāmīr*, i.e. a generic term for wind instruments; others pretend that *Erganon* consists in singing the same [tune] thing by one thousand people of different types, i.e. by young and older people, put together, singing sometimes in unison, and some other times in multiple voices [polyphony?], exceeding by that usual limits (of the Persian mode). For others still, *Erganon* is a choir of 70 maiden singing and playing instruments harmoniously¹²¹¹ together’.

The Turks neglected the *erganon* [continues Raghib], abandoned it to the Occident and did not let themselves seize the occasion and benefit from the future promises the keyboard brought to the Art of polyphony. Although I have browsed numerous Persian and Arabic dictionaries, I could find nothing on the *erganon*. But the search must go on”¹²¹².

¹²⁰⁹ I could not trace this author and try and verify in his text the conformity of Raghib’s quote from his translation of the *Burhān-i qāṭi’*.

¹²¹⁰ This remark is of importance for the following paragraphs.

¹²¹¹ I am puzzled by what might have been the Turkish term corresponding to “harmoniously” in Rāghib’s translation of “Assef éféndi’s” text.

¹²¹² [Raghib, 1929, p. 100–101]: “Au sujet des orgues de Byzance, un des documents les plus précieux que nous ayons eu en mains est, sans aucun doute, la description du dictionnaire *Burhan Katé*, tant parce qu’elle est postérieure aux documents byzantins relatifs à ce sujet, que parce qu’elle met en doute (si même elle ne la ruine pas) la persuasion où l’on est que les églises orthodoxes de Byzance, aux XVI^e et XVII^e siècles, n’usaient pas de l’orgue. Les historiens du mot ‘erganon’ expliquent d’autres sens intéressants qui, tous, sont suggestifs. Le *Burhan Katé* a été écrit au XI^e siècle de l’Hégire par le Persan Husséin bén Tébrizi ; le célèbre lexicographe turc Assem éféndi, en exprimant en turc plusieurs mots arabes et persans, l’a traduit : c’est là que nous prenons le texte, n’ayant malheureusement pas pu encore voir l’original. Voici ce texte : ‘Erganon, instrument connu, inventé par Platon. Les Nestoriens et les Grecs en jouent dans les églises à certains jours fixés. Des tiges creuses comme des roseaux, nombreuses, grosses et minces sont placées par ordre d’acuité. Par derrière il y a un objet comme un soufflet ; en le manoeuvrant, l’air qu’il produit donne à ces tiges une voix comme celle de la flûte de Pan. Et certains disent qu’Erganon veut dire Mézāmīr, c’est-à-dire que c’est un nom générique désignant les instruments à vent ; et d’autres prétendent que l’Erganon consiste à faire chanter une chose par un millier de personnes de différentes sortes, c’est-à-dire par des gens jeunes et plus âgés, mêlés, qui chantent tantôt à l’unisson, tantôt à plusieurs voix, en dépassant les limites ordinaires (du mode persan). Pour

→

Let us note here that, whenever there is no mention whatsoever, in the quoted Assem éfendi's text, of a keyboard or of Byzantine churches, but of reeds, *mizmār(s)* and collective chanting, and also that "Nestorians and Greeks" play the *erganon* in churches¹²¹³ on particular occasions, Rāghib already concludes that:

1. The Byzantine churches in the 16th-17th centuries used organs.
2. The Turks may have also used organs but later neglected them.

In fact, the only serious indication about organs in the whole article lies in the quote of "Assef éfendi", supposedly after the *Burhān Qāṭi'*, about the "Nestorians and [the] Greeks [who] use it in churches".

The remaining part of the article contains nothing more about Byzantine organs, and consist in various quotes of Evlia Tchelebi¹²¹⁴, including one concerning the organ of the Cathedral of Vienna, but...

In Raghīb's second (1930) article, the quote from "Assef éfendi" becomes, in the *original* "Burhan Katé":

"*Erganon* is a well-known instrument, invented by Plato. Some (people) say that *Erganon* is the translation of *mazāmīr*, i.e. a generic term for wind instruments. Others say that, when a thousand men, old and young, sing together the same [tune] in different voices, this is called *Erganon*. Another group [still] pretends that *Erganon* is a choir of 70 maiden playing instruments and singing the sounds [notes?] of the same harmony, all together"¹²¹⁵.

→

d'autres encore, l'Erganon, c'est un chœur de 70 jeunes filles chantant et jouant des instruments ensemble et harmonieusement'. Les Turcs négligèrent l'erganon, l'abandonnèrent à l'Occident [p. 101] et ne surent pas saisir l'occasion de profiter de l'avenir que promettait à l'art de la polyphonie les ressources du clavier. Bien que j'aie feuilleté nombre de dictionnaires persans et arabes, je n'ai pu rien trouver sur l'erganon. Mais il faut encore chercher".

¹²¹³ Where? When?

¹²¹⁴ For example [Raghīb, 1929, p. 101]: "*Erganon* is a remarkable Ancient instrument. It is said that David the Prophet sang Psalm verses with [playing on] this instrument. Although it was invented in the Orient, it is nowadays only used by the Franks. There exist 300 *erganon*" (in the French original "L'*erganon* est un ancien instrument remarquable. On dit que le prophète David chantait les versets des psaumes avec cet instrument. Bien qu'il ait été inventé en Orient, actuellement il n'est usité que par les Franks. Il existe 300 *erganon*"). More about Evlia Tchelebi, author and traveller of the 17th century, in [Mordtmann and Duda, 2012; Wikipedia contributors, 2012b].

¹²¹⁵ [Raghīb, 1930, p. 261].

This new version, coming according to Raghīb from the original *Burhān-i Qāṭi'* and "a more abridged [!] in Persian"¹²¹⁶ version as the one of "Assem éfendi", makes no mention of the "Nestorians" and the "Greeks", or of their churches or their location and the time period in question, and even less about the organ, but provides other explanations for the term *erganon* of which the ones concerning collective singing suggest no more a possibility of polyphony, or harmony...

Was that the end for the hypothesis of the "Church Byzantine organs"? It seems not, as Raghīb provides us, in this second article, with two further quotes¹²¹⁷ which seem to strengthen his thesis. The first quote is from the *Férhének Chouri* (1153):

"*Erganon* is an instrument specific to the Infidels, which play it in their churches [...] It is played in most churches at given days"¹²¹⁸.

From which we may understand that organs are generally played, in the 12th century, in the churches of the Infidels, but these Infidels are no more (necessarily) Nestorians or Greeks. On the next page, Raghīb quotes further "Abourréfid Méhméd Hafid Ibn ém Mevla Moustafa Achir" (Constantinople, 1221 *Hijri* – 19th century)¹²¹⁹:

"*Erganon* is the name of a huge instrument played by the Franks in the church, on given days. [...] This instrument is presently in use in Galata, at the Frankish church"¹²²⁰.

So it seems that the "Byzantine church organ" was played, towards the end of the 18th century, by the Franks in the Frankish church of Galata in Constantinople (Istanbul)...

In the 1933 first article¹²²¹, Raghīb provides more quotes on the *erganon*/organ and gives this description from "Michel Febre, La Turquie, Paris 1682":

"They (The Turks) compelled, four years ago, the French Religious monks to carry their organs to Andrinople to play them for the marriage of the 'Great Lord's daughter",

¹²¹⁶ [*ibid.*]: "plus abrégé en persan".

¹²¹⁷ Out of a dozen different quotes on the organ/*erganon* not related to our problematic.

¹²¹⁸ [Raghīb, 1930, p. 262].

¹²¹⁹ About, according to Raghīb, "the [...] organs in Catholic churches in Constantinople at the end of the 18th century".

¹²²⁰ [Raghīb, 1930, p. 263]: "Erganon est le nom d'un grand instrument que jouent les Franks à l'église, à certains jours déterminés. [...] Cet instrument est en usage présentement à Galata dans l'église franque".

¹²²¹ i.e. the third article out of the four written on this thematic by the author.

[Raghib] adding further:

“It seems then that there existed, to these times, a portative organ in one of the Frankish churches of Constantinople”¹²²².

I shall not directly comment on this last quote as, in the fourth article¹²²³, Raghib further explains:

“[T]he author [Evlia Tchélébi] clearly and specifically states, after describing these instruments, that they are in use in Constantinople; secondly, when describing Galata, still in [his] Tome 1, he explains that the Frankish church is known to the Turks as ‘the church of the organ’, whenever there is no organ in the Italian church”¹²²⁴,

which is all the relevant information we can find about the subject, and which means that the only church in Constantinople (Galata) known to have an organ was then the Frankish church¹²²⁵.

So where are the Byzantine churches’ organs of Egon Wellesz (and Amédée Gastoué and others) prior to the Fall of Constantinople? Where is the evidence that “pre-Fall” Byzantine chant was ditonic?¹²²⁶

A few corollary questions arise:

1. Did Wellesz effectively read the articles of Raghib that he quotes or cites?
2. Did he (want to) understand them?
3. Did he deliberately use them to support his thesis of the ditonicity of Byzantine chant prior to the fall of Constantinople, regardless of the fact that this was clearly false?

Nonetheless Wellesz’ reference (and still unchallenged as such) book was first published with this enormous error in 1949, was “revised” and enlarged in 1961, then reprinted in 1962, 1971 and

¹²²² [Raghib, 1933, p. 18]: “Ils (les Turcs) obligèrent, il y a quatre ans, les moines religieux Francs de porter leurs orgues à Andrinople pour jouer au mariage de la fille du ‘Grand Seigneur’ [...] Il semble donc qu’il y avait, à cette époque, un orgue portatif dans une des églises franques de Constantinople”.

¹²²³ The second written in 1933, in a French translation by Eugène Borrel.

¹²²⁴ [Raghib and Borrel, 1933, p. 86].

¹²²⁵ Moreover, Raghib himself stresses, in this last article [p. 87], that “The Arabian traveller Ibn Baṭūṭā, while visiting the churches of Galata, some time before 1492, finds nothing else to say apart from ‘the churches in there are dirty and ugly’”: in French “Le voyageur arabe Ibn Bathouta, visitant les églises de Galata, assez longtemps avant 1492, ne trouve rien d’autre à dire que “les églises de cet endroit sont sales et laides”.

¹²²⁶ Noticeably, Raghib gives the information denying the use of organs in the Byzantine churches in his last two articles, but does still not write plainly (or even suggest) that his first assertions were erroneous.

1980, while this error still misleads scholars, or leads them on...¹²²⁷

Another possible reason for Western theoreticians’ crave for “Byzantine ditonism”

What is the reason for the overwhelming desire of the Western musicologist to reduce Byzantine chant to a ditonic, pejorative version of their own music?

I have given one, general (and multifaceted) answer to this question in Chapter IV; I have also pinpointed in my book on the subject another possible reason, which I propose here in English.

To better understand the following two documents, the reader must bear in mind that the *Tribune of Saint-Gervais*, a French review published by the *Schola Cantorum*¹²²⁸, contains some of the most critical articles on “Modern” Byzantine chant by French authors who researched this music¹²²⁹.

The first document is the presentation text of *La Tribune* on the title page:

“*The Tribune of Saint-Gervais* – Monthly Bulletin of the *Schola Cantorum* founded to foster:

- The implementation of plain-chant following the Gregorian tradition
- The return to Palestrinian music
- The creation of a Modern liturgical music

¹²²⁷ A few authors do explain, as late as 1968 (“Les orgues étaient employées principalement pour renforcer la splendeur des cérémonies impériales, mais jamais dans les églises. Il est du reste significatif que, lorsque les empereurs byzantins envoyaient un orgue en Occident, ils le destinaient à des chefs d’État et non à des communautés religieuses” – in [Velimirović, 1968a, p. 148]) that there were, eventually, no organs in the Byzantine churches prior to the “Fall”; Wellesz’ reference book remained however unchanged concerning this point, and the “ditonism” of “Medieval Byzantine chant” remained the creed of this (prevailing Occidental) current of Byzantine musicology. Moreover, the most striking feature concerning this problem is the overwhelming desire of authors such as Wellesz and Gastoué to “prove” the ditonicity of “Medieval” Byzantine chant, against a contradicting body of evidence.

¹²²⁸ A music school established to foster Gregorian chant – see [Anon. “Schola Cantorum de Paris”, 2016a] for more details (the English entry [Anon. “Schola Cantorum de Paris”, 2016b] is very concise).

¹²²⁹ Notably the virulent anti-Chrysantine [Thibault (fr.), 1898] and the unflattering [Gastoué, 1899a; 1899b] (in the latter [p. 8] Gastoué states notably “Do the Greeks have a chromatic mode? In theory, perhaps. In praxis, no” – in French “[Y] a-t-il chez les Grecs un mode chromatique? Théoriquement, peut-être; pratiquement, non”) for Byzantine Chant, but also Dom Parisot’s famous conference on “Oriental music” [Parisot, 1898].

- The improvement of the repertoire of organists¹²³⁰.

The second document is the Papal brief (“*bref*”) sent by pope Pie X to Charles Bordes¹²³¹, founder of the *Schola Cantorum*, also published in the *Tribune of Saint-Gervais*:

“Dear Son, Salute and Papal blessing. – It is for Us very pleasant, as should duly be thought, that the work and enlightened care of diverse persons drove through the project, that We have murely thought, of recalling Liturgical chant to its ancient form. Amongst these people, you must have a special place for you who, even before We prescribed anything concerning Sacred music, had already founded the *Schola Cantorum*, following Our desire, and who never ceased to propagate everywhere the legitimate field of Gregorian Chant. Receive from Us the praise that you deserve and Our appreciative volition, and know in the same time that We await still from your ingenious zeal, with God’s help, the most fruitful achievements. We grant you consequently, in the name of the Lord, and most affectionately, the Papal blessing as a token of celestial favors and as a testimony of Our benevolence with regard to your person, Dear Son.

Given in Rome near [the Basilica of] Saint Peter, the 11th of July 1904, the first year of [O]ur Pontificate.

Pie X. Pope¹²³².

In today’s words, writing about Byzantine chant in the *Tribune of Saint-Gervais* could have well represented a conflict of interests between the Catholic orientation of the review and the need for impartial and scientific

weighing of facts in Academic research, on one side, while, on the other side, reducing the monodic Byzantine chant to a ditonic substrate could also, whereas integrating it in Christian Europe and eliminating its differences with the Gregorian chant¹²³³, underline its (potential) deficiencies when compared with Palestrinian polyphony.

* * *

The myth of the organs in Byzantine churches was maintained for a few decades, giving a strong argument for the ditonicity of “Medieval” Byzantine chant. While Gastoué, Wellesz, Tillyard and others maintained this unproven statement their lifetime long, other musicologists in the field sensed the fragility of this argumentation: the only substantial attempt I know of, however, to sustain the “ditonic” thesis¹²³⁴ was made by Oliver Strunk in an article entitled “The Tonal System of Byzantine Music” published in the *Musical Quarterly*¹²³⁵.

This article, along with a second article published by the same author in 1962¹²³⁶ – both addressed in the next appendix, are supposed to have, according to another well-known scholar in the field of Byzantine musicology, ‘unambiguously’ established the ditonicity¹²³⁷ of Medieval Byzantine chant.

* * *

¹²³⁰ [Bordes and Boisjolin (de), 1920, v. 21, p. 22]: in French “‘LA TRIBUNE DE SAINT-GERVAIS – BULLETIN MENSUEL de la *Schola Cantorum* FONDÉE POUR ENCOURAGER : - L’exécution du plain-chant selon la tradition grégorienne, - La remise en honneur de la musique palestrinienne, - La création d’une musique religieuse moderne, - L’amélioration du répertoire des organistes”.

¹²³¹ More about this composer and director of the *Schola Cantorum* in [Anon. “Charles Bordes”, 2016].

¹²³² [Bordes and Boisjolin (de), 1920, v. 21, p. 23]: in French “Cher Fils, salut et bénédiction Apostolique. — Il Nous est fort agréable, comme on peut le penser, que le travail et les soins éclairés de diverses personnes avancement la réussite du projet, que Nous avons mûrement réfléchi, de rappeler le chant liturgique à son ancienne forme. Au nombre de ceux-là, il convient de vous donner une place particulière, à vous qui, dès avant que Nous ayons prescrit quelque chose sur la Musique sacrée, aviez déjà fondé la *Schola Cantorum*, conformément à Nos désirs, et qui ne cessez de propager partout la légitime discipline du chant grégorien. Recevez-en de Nous la louange que vous méritez, et la marque de Notre volonté reconnaissante, et sachez en même temps que Nous attendons encore de votre zèle ingénieux, avec l’aide de Dieu, les fruits les plus féconds. Nous vous accordons donc dans le Seigneur, de la façon la plus affectueuse, la bénédiction Apostolique, comme gage des faveurs célestes et témoignage de Notre bienveillance envers vous, Cher Fils. Donné à Rome près Saint-Pierre, le 11 juillet 1904, la première année de notre Pontificat. Pie X. Pape”.

¹²³³ Oliver Strunk [1945] seeks such a convergence between the “signatures” of Byzantine chant and the *differentiae* of Gregorian chant (another convergence is suggested, for instance in [Strunk, 1960] as well as in [Strunk, 1948], the role of Byzantine liturgy as a transmitter of synagogal pre-Christian traditions to “the Christian churches further West and further East”).

¹²³⁴ Wellesz’ “intuition”, “strengthened” by Raghīb’s and Gastoué’s articles, would (?) in the Academic World today be considered as plain fraud; in “Liturgical musicology” or its “sister musicology” of the *maqām*, however, many irrational (unproven) assertions are still considered as true, regardless of objective evidence. A few such assertions are scrutinized in this dossier.

¹²³⁵ See [Strunk, 1942].

¹²³⁶ [Strunk, 1962].

¹²³⁷ Evidently “diatonicity” in the lexicon of Occidental Byzantinologists.

Plates for Appendix 5



FHT 61 “Hama governorate contains some of the most important mosaics in Syria, with around 50% of uncovered mosaics, most significant of which is ‘Tiba al-Imam,’ a 600 square meters mosaic dating back to 242 AD. Another mosaic housed at Hama National Museum is the ‘Musicians’ mosaic. This piece, measuring 4.25 meters by 5.37 meters, depicts six female musicians and two children, in addition to old musical instrument including an organ, cymbals, two flutes, a harp and an Indian musical instrument consisting of metal bowls placed on a table. In a statement to Syrian press, professor of mosaic restoration at Athens University Stephania Chlouveraki underlined the strong composition and accuracy of representation in the Musicians mosaic, noting the small details such as attire, hair, braids, gentle smiles and wide eyes”: from <[http://www.english.globalarabnetwork.com/201003245260/Related-news-from-Syria/archaeologists-sublime-technique-makes-syrian-mosaics-on\[e\]-of-the-greatest-in-the-world.html](http://www.english.globalarabnetwork.com/201003245260/Related-news-from-Syria/archaeologists-sublime-technique-makes-syrian-mosaics-on[e]-of-the-greatest-in-the-world.html)>, visited 27/04/2012. According to archeomusicologist Richard Dumbrill [personal communication 24/04/2012], the “Musicians” mosaic can be dated as back as the 1st century B.C. and as late as the 2nd century A.D.

APPENDIX 6: ON THE “DIATONIC [DITONIC] TONAL SYSTEM” AS THE PROTOTYPE SYSTEM FOR “MEDIÉVAL” BYZANTINE CHANT¹²³⁸

The main analytical (and inconclusive) “proof” proposed for the ditonicity of the “Original” [“Medieval”] Byzantine chant consists of a “demonstration” by Oliver Strunk¹²³⁹, that the only fitting system for this music should be the ditonic system, with a later article (book-part) by the same author being considered as giving an “unambiguous” proof for this ditonicism. The two components of this “proof” are examined in the following pages.

The “tonal” system of the Byzantine chant according to Oliver Strunk

In his article “The Tonal System of Byzantine Music”, published in the midst of Second World War, Oliver Strunk commented his approach, along with the justification of “diatonism” [understand “ditonism”] of “Medieval” Byzantine chant, as follows:

“The first of the three studies¹²⁴⁰ deals with the tonal system underlying the medieval Byzantine chant and attempts to show—on the basis of literary and musical evidence, and without resort to analogy—that this system is a wholly diatonic one¹²⁴¹, its central octave lying between *d* and *d'* [...]. The conclusions reached in this first study are in themselves not new. They have indeed been widely accepted from the first. Yet it must be said that the arguments brought forward in their support by Riemann, Thibaut, Fleischer, Tillyard, Wellesz, and Gombosi have not entirely dispelled the last remaining doubt and are perhaps in part responsible for the skepticism with

which the subject as a whole is often still regarded^{1242>1243}.

In order to prove the ditonicity of “Medieval” Byzantine chant Strunk enumerates what he considers postulates for the resolution of this problem, including a tetrachordal disjunct system, the internal composition of which is to be determined:

“[T]he tonal system of Byzantine music centers in a series of eight pitches arrived at by combining disjunctly two similar tetrachords. [... see FHT 62] The precise nature of the steps within this series remains for the present unknown; [...]

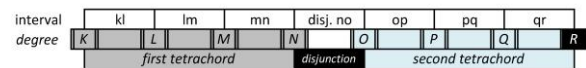

FHT 62 The generalized system of Byzantine chant according to Strunk, with two similar tetrachords separated by a disjunctive (whole) tone.

(continued) All we know is that the sum total of the seven steps [...] is an octave. If we may assume, however, that the interval [containing the upper tetrachord] is a perfect fourth—a reasonable assumption, to say the least, for a tetrachordal system based on any other interval is virtually inconceivable—the interval [between tetrachords] as the difference between an octave and two fourths, becomes a whole tone and the remaining intervals fall readily into line. Provided it be based on the perfect fourth, a tetrachordal system involves perfect fifths between the corresponding pitches of adjacent disjunct tetrachords, perfect fourths between the pitches of adjacent conjunct ones, these intervals remaining constant no matter what the division and internal structure of the tetrachord itself may be. Conversely, a system of disjunct tetrachords produces unequal fourths [see FHT 63],

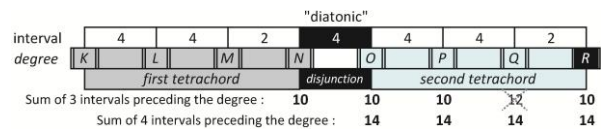

FHT 63 Strunk's explanation on the “diatonic” disjunct system, with one of the “fourths” (N-Q) being a tritone while the 4 other fourths and all 4 fifths are (in Equal-temperament) “just”¹²⁴⁴.

¹²³⁸ This appendix is a translation and adaptation of [Beyhom, 2015b, p. 459–468] with ad hoc plates.

¹²³⁹ “Strunk was [...] a founding member of the American Musicological Society, as well as the initial editor of JAMS in 1948 and the president of the AMS from 1959–1960. He directed the *Monumenta Musicae Byzantinae*, 1961–71. His scholarship was exceptionally broad, covering the notation of early Byzantine music, the *ars nova*, Renaissance motets, Haydn, and Verdi. He was one of the leading figures in post-World War II American musicology” – in [Anon. “Oliver Strunk”, 2016]; Strunk wrote a number of other articles on Byzantine chant, some of which are cited in the closing section of Appendix 5.

¹²⁴⁰ The two other studies are most probably [Strunk, 1945; 1948], already cited and quoted in the closing section of Appendix 5.

¹²⁴¹ “Ditonic”, evidently: see FHT 67, p. 237 for examples of scales (“systems”) for the First *diatonic* mode in Modern Byzantine chant.

¹²⁴² Inserted here is the following footnote: “See, for example, A. J. Swan, ‘The Znamenny Chant of the Russian Church’, in *The Musical Quarterly*, XXVI (1940), 233–234 {referenced in this dossier as [Swan, 1940]}, where it is held that the nature of the Byzantine chant has still to be ‘definitely established’ and that ‘time and further exploration have yet to vindicate’ the findings of Wellesz and Tillyard”.

¹²⁴³ [Strunk, 1942, p. 190].

¹²⁴⁴ Intervals are given in multiples of the quarter-tone; the value of a “just” fourth is 10 (quarter-tones), while the fifth will be “14”.

(continued) a system of conjunct tetrachords unequal fifths [see FHT 64]; or, to put it differently, the fourth is the critical interval in a disjunct system, the fifth in a conjunct one¹²⁴⁵.

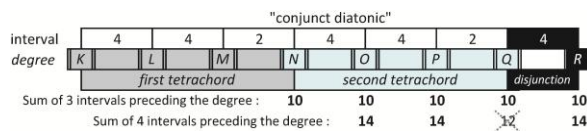

FHT 64 The conjunct ditonic system produces an unbroken and integral series of “just” fourths, with however only 3 perfect fifths out of 4¹²⁴⁶.

Following his first assumption, Strunk explains further:

“Applying these general truths to the central octave of the Byzantine tonal system, we may conclude that, provided the interval [K] to [N] be a perfect fourth, all four intervals of the type [K] to [O], will be perfect fifths¹²⁴⁷. Aside from this, we may conclude that the succession of fourths [L] to [O], [M] to [P], and [N] to [Q] will present some irregularity. If the division of the tetrachord be diatonic, two of these intervals will be perfect fourths while a third will be a tritone [see FHT 63]; if the division be chromatic [see FHT 65 – Top], two intervals¹²⁴⁸ will be tritones while a third¹²⁴⁹ will be an interval consisting of a whole tone plus two half tones (equals major third);

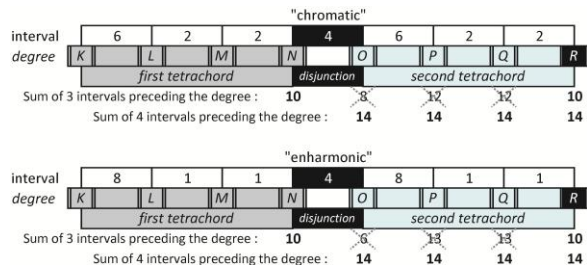

FHT 65 The (tense) “chromatic” and “enharmonic” systems hold only two “just” fourths, which, however, 4 “just” fifths.

(continued) if the division be enharmonic [see FHT 65 – Bottom], two intervals will be of the type augmented fourth plus quarter-tone¹²⁵⁰ while a third¹²⁵¹ will be an interval consisting of a whole tone plus two quarter-tones (equals minor third). As before, these intervals will remain constant

¹²⁴⁵ [Strunk, 1942, p. 192–193].

¹²⁴⁶ In the case of ditonism, a conjunct tetrachordal system produces a complete series of “Just” fourths, while, however, excluding one of the “Just” fifths from the disjunct system. Did this feature exclude further (as exposed lower in the main text of this Appendix) this system from consideration?

¹²⁴⁷ We are back here with the “disjunct” ditonic system – see FHT 63.

¹²⁴⁸ [M_P] and [N_Q] in FHT 65 – Top.

¹²⁴⁹ [L_O] in FHT 65 – Top.

¹²⁵⁰ [M_P] and [N_Q] in FHT 65 – Bottom.

¹²⁵¹ [L_O] in FHT 65 – Bottom.

no matter what the internal structure of the tetrachord may be¹²⁵².

Strunk explains further, with regard to the number of “Just” fourths:

“Now we should be able to assume that in vocal music the more complex fourths occurring in the several genera will be in principle avoided as direct leaps. If this be granted, it follows that, in a system of disjunct tetrachords, the division of the tetrachordal unit will be reflected in the rejection of one or more of the possible fourth leaps and in the acceptance of others¹²⁵³,

while stating that:

“Having gone this far, we could complete our construction by extending the central octave above and below, did we not find ourselves confronted by the essential paradox in the Byzantine theory of the modes – its insistence on the recurrence of the modes both at the fifth and at the octave. Whether we continue with disjunct tetrachords or, abandoning them, put conjunct ones in their place, we shall be running counter to one or other of these requirements. The theorists do not help us to resolve this contradiction; to do so we must turn again to the melodies themselves¹²⁵⁴.

Strunk concludes, after developing an argumentation which includes the formulae used for identifying the modes in Byzantine chant, that the Western ditonic system, which is the only system which maximizes the number of “perfect fourths” in the scale, is the only system which could apply to Byzantine chant, provided however a set of conditions and exceptions are fulfilled:

“[T]he tonal system of the medieval Byzantine chant is a wholly diatonic one, its central octave having the internal structure of our diatonic [read here ‘ditonic’] octave *d* to *d*; 2) as a matter of convenience and with a view to simplifying transcription from Byzantine neumes to staff-notation, these two octaves are best equated; 3) excepting in melodies involving changes of key and in transcriptions arbitrarily transposed, key-signatures and supplied accidentals are inadmissible; 4) to avoid obscuring its relation to the other modes, Mode IV is best left untransposed¹²⁵⁵.

*
* *

¹²⁵² [Strunk, 1942, p. 193]: the names of Byzantine notes have been replaced in the quotes and figures by corresponding capital letters for clarity.

¹²⁵³ [Strunk, 1942, p. 193].

¹²⁵⁴ [Strunk, 1942, p. 195].

¹²⁵⁵ [Strunk, 1942, p. 201–202].

Strunk's argumentation is (very) arguable:

1. Firstly, he restricts himself to the octave, whenever the systems should be at least bi-octavial, as he explains that the octave should be extended to the "lower" and "higher" parts.
2. He also restricts his argumentation to some modes, as Mode IV does not fit in the picture (no "perfect fourth"), so it is better to ignore it...
3. Moreover, he considers one single (and theoretical) type of scale construction (two disjunct tetrachords), whereas other constructions are possible, for instance a "conjunct" tetrachordal system, or even the favorite construction type of the Byzantine theoreticians, the *wheel*¹²⁵⁶.
4. Finally, he imposes a certain number of conditions without which all of his argumentation would fall apart, and because of which all his argumentation fell apart.

The most striking feature of Strunk's methodology is that he chose to test only the three "typical" systems used in basic "Ancient Greek" musicology, the "Occidental" (*tense*) *diatonic* (or ditonic), the *tense chromatic* and the *enharmonic* systems, ignoring all the different varieties (species) of "diatonic" and "chromatic" tetrachords used or theorized by Ancient Greeks.

I show further in [Beyhom, 2015b, p. 459–468] that the use of a *Zalzalian*¹²⁵⁷ octavial system (see also FHT 66) may also maximize the number of fourths in the octave (five), while bi-octavial systems composed of successive similar tetrachords, whether ditonic (FHT 68, p. 237) or *zalzalian* (FHT 69, same page), create a chain of eleven successive just fourths, at the expense however of the regularity of fifths and octaves¹²⁵⁸.

Among so many possibilities for attempting at understanding the Byzantine theoretical system, all possibilities which do not fit in the restricted acceptance of Ancient Greek theories fostered in

¹²⁵⁶ The *wheel* is a theoretical construction of a series of joined identical pentachords in Just fifths.

¹²⁵⁷ In this case based on tones and three-quarter-tones intervals.

¹²⁵⁸ Other possibilities are considered in [Beyhom, 2015b], including bi-octavial enharmonic and chromatic systems, or ditonic and *Zalzalian* (*diatonic*) systems of the (pentachordal) "Wheel".

Occidental musicology had to be, evidently, overlooked.

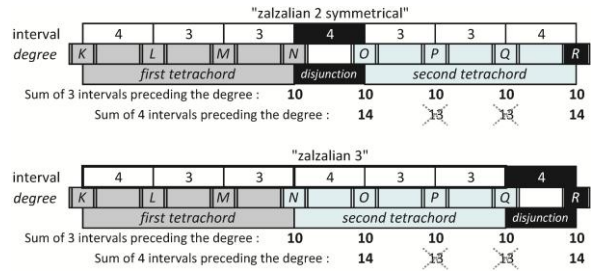

FHT 66 Disjunct and conjunct *Zalzalian* (*diatonic*) systems comprising a complete series of (5 successive) "Just" fourths.

This did not hinder Strunk¹²⁵⁹ from concluding that the Occidental ditonic system, regardless of the flaws brought up by the conditions that he sets above, is the *only* theoretical system which fits in with "Medieval" Byzantine music.

Even with this so-called "proof", however, it seems that other Byzantinologists still had some doubts about the sustainability of the ditonic thesis for "Medieval Byzantine chant": I shall try in the next pages to demonstrate the real issue at stake in this matter.

The "unambiguous supporting testimony" for the ditonicity of "Medieval" Byzantine chant

While it seems that Strunk's demonstration in his 1942 article was not conclusive, Byzantinologists still needed to maintain the fiction of the ditonicity thesis for the "Medieval" Byzantine chant, thus renowned Byzantinist Jørgen Raasted stating, in his 1966 book:

"Transcriptions of Byzantine melodies into Western notation are based on the **assumption** that medieval Byzantine chant consists of tones and half-tones only. **The diatonic character of Byzantine music has been postulated by Wellesz and Tillyard from the early days of their studies**, and their position – which lies behind such work as that done in the *Monumenta Musicae Byzantinae* and that of the Grottaferrata school – has since then found support in observations made by a number of scholars¹²⁶⁰. It would lead this book off the track if I were to **demonstrate once more** the validity of this **assumption**, and any such demonstration would presumably

¹²⁵⁹ Who did not even bother explore these other *genera* (tetrachordal) distributions.

¹²⁶⁰ At this point Raasted inserts a footnote commented in the text below.

add nothing substantial to the discussion. **So, for practical reasons I take this basic assumption as an axiom**¹²⁶¹.

It seems then that, regardless of the enormous task undertaken by Occidental (musicological) Byzantinology (including the well-known *Monumenta Musicae Byzantinae* part of which is Raasted's book), some doubts still subsisted concerning the constantly asserted ditonicity of Byzantine chant. To lift this ambiguity up Raasted explains, in a footnote to the above excerpt:

"Unambiguous supporting testimony has recently been found by Strunk in a 16th cent. treatise by Hieronymus Tragodistes of Cyprus. See Strunk, *A Cypriote in Venice* [...] p. 106"¹²⁶².

I was eager to consult Strunk's other article which provides "unambiguous supporting testimony" of the ditonicity of "Medieval" Byzantine chant, but all I could find in this article (and on the page cited by Raasted) was the following:

"Hieronymus has told us about his studies with Zarlino and we can see from the text of his treatise and from his composition that he has profited by them; on the other hand, he tells us also that he has devoted himself from childhood to the study of ancient and modern writings on the music of the Greeks—on 'our music,' to use his own phrase. Assuming for the moment that his background was equally solid on both sides, **we may certainly infer from his observations that the Byzantine chant he knew was fundamentally diatonic, even though we may hesitate to understand the term "diatonic" in the precise sense in which it was understood by Hieronymus and his teacher. At no point in his treatise does Hieronymus as much as mention another possibility**; the notation he advocates is wholly unsuited to the musical systems of later Byzantine theory and practice; and it is noteworthy that, having provided means for indicating chromatic alterations, he makes no use of them in his own Tenor, although his accompanying voices are liberally supplied with sharps and flats. This much is inference"¹²⁶³.

Knowing that Byzantine cantors in the Modern period consider the Zalzalian (Chrysanthos' or the Musical Committee's) system as the only "diatonic" system, and knowing that the term "diatonic" was used in ancient Greek theories for a variety of *genera* and systems (see FHT 67, next page) – only one of which coincides with the Occidental restrictive acceptance of

the term, it seems that the ambiguity was not cleared in this article, but even more deeply rooted in this musicology.

As for Raasted (and other Byzantinologists of this mainstream Occidental musicology), it is easy to understand that throwing Byzantine Early ("Medieval") ditonism in doubt would show the deciduous nature of all this related musicology, a perspective best avoided for generations of scholars in that field...

Conclusions for Appendices 5 and 6

Occidental musicology of Byzantine chant seems to have indulged, to say the least, in self-deception, if not in deliberate attempts misrepresenting the original system of this music.

There are many reasons for such a position, ranking from pure Orientalism (and Byzantinism) to the desire of safeguarding decades of (biased) works and Academic careers.

In this process, the Modern Greek (Byzantine) point of view was completely overlooked, whereas the "Arabian" point of view was never asked for.

As a result, the "Tillyard and Wellesz" school flourished during the 20th century with decades of publishing, mutual celebrations through articles and books, and self-congratulations through specialized conferences and publications¹²⁶⁴, while deploring¹²⁶⁵ the "impurity" of "Modern" Byzantine chant, supposedly "contaminated" by Ottoman music, and publishing hundreds of books and articles transcribing Byzantine chant semi-tonally, with tens (if not hundreds) of "musicological" careers based on a persistent forgery.

As for the results on Byzantine chant as such, and on Byzantine Autochthonous musicology, these are addressed in Chapters 4 and 5 of the main text.

*
* *

¹²⁶¹ [Raasted, 1966, p. 8].

¹²⁶² This is the footnote mentioned above (in footnote 1260).

¹²⁶³ [Strunk, 1962, p. 106].

¹²⁶⁴ See for instance [Touliatos-Banker, 1978 ; 1988 ; Velimirović, 1968b].

¹²⁶⁵ As with mainstream Occidental musicology of Byzantine chant for some two centuries.

Plates for Appendix 6

First mode: *diatonic*

Archetypes: *Ḥusaynī, Bayāt*

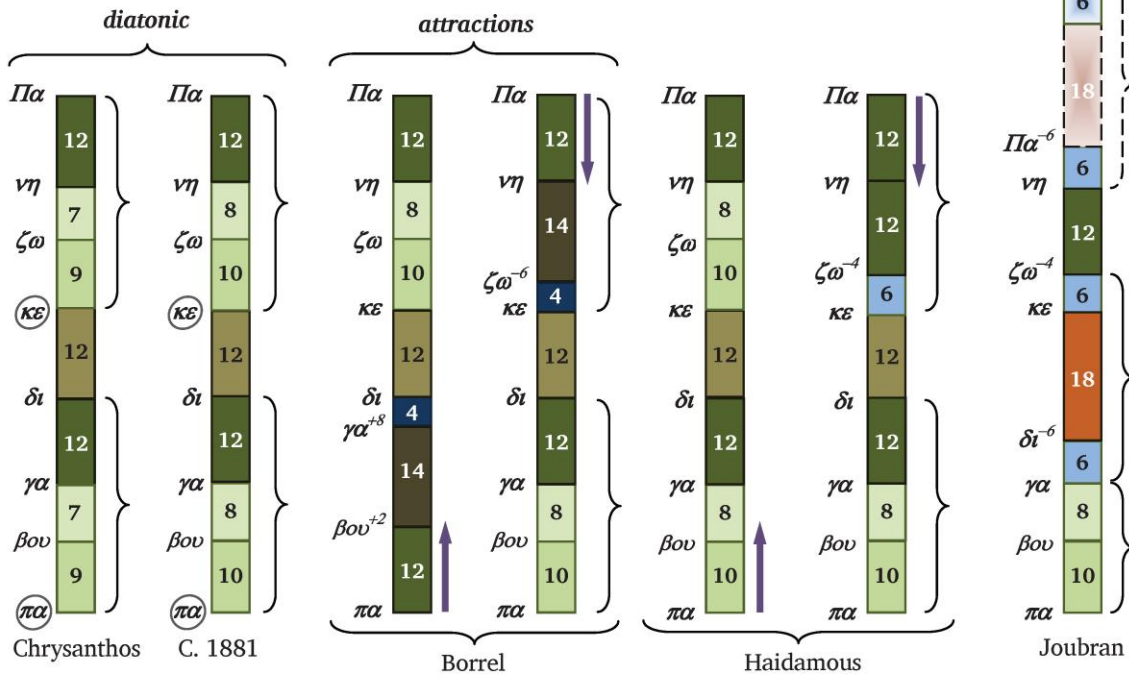

FHT 67 Scales of the First *diatonic* mode in Modern Byzantine chant, as expressed by Chrysanthos Karamellēs (of Madytos), the Music Committee of 1881, Makarios Haidamous and Romanos Joubran (adapted and translated from the book of the author [Beyhom, 2015, Plate A7]).

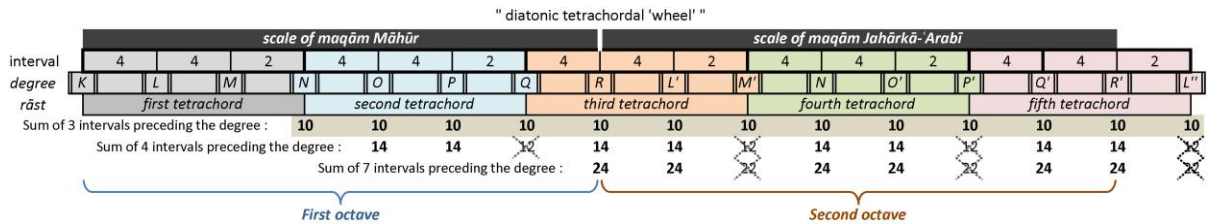

FHT 68 Ditone bi-octavial tetrachordal "wheel"¹²⁶⁶.

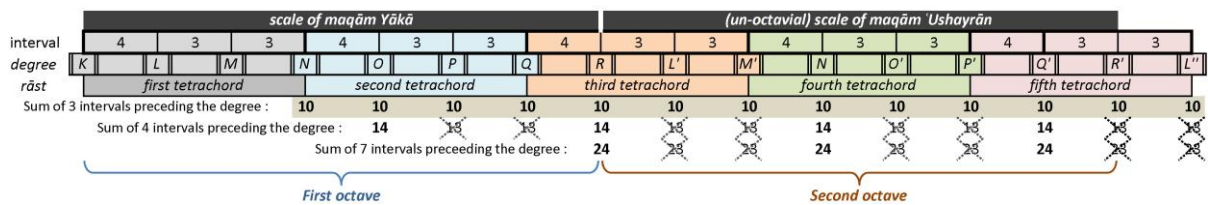

FHT 69 Zalzalian bi-octavial tetrachordal "wheel"¹²⁶⁷.

¹²⁶⁶ The bi-octavial system is made of successive similar tetrachords (here "major" Occidental tetrachords), with intervals expressed in multiples of quarter-tones and "Just" fourths holding the value of "10" quarter-tones, the ("Just") fifths the value of "14" quarter-tones and the ("Just") octaves the value of "24" quarter-tones.

¹²⁶⁷ As in the preceding figure, but with (theoretical) *Maqām*-music *rāst* tetrachords.

APPENDIX 7: BASIC UNDERSTANDING OF ORIENTALISM – AND A LITTLE MORE¹²⁶⁸



FHT 70 “The cover of *Orientalism*¹²⁶⁹ is a detail from the 19th-century Orientalist painting *The Snake Charmer*, by Jean-Léon Gérôme (1824–1904)”¹²⁷⁰.

“We were trained to be inferior copies of Englishmen, caricatures to be laughed at with our pretensions to British bourgeois gentility, our grammatical faultiness and distorted standards betraying us at every turn. We were neither fish nor fowl. We were denied the knowledge of our African past and informed that we had no present. What future could there be for us? We were taught to regard our culture and traditions as barbarous and primitive. Our text-books were English textbooks, telling us about English history, English geography, English ways of living, English customs, English ideas, English weather”
 [Kwame N’Krumah, *Africa Must Unite*]¹²⁷¹

¹²⁶⁸ This appendix relies mainly on available documentation on the subject of “Orientalism”, and is intended as 1) a general introduction to its critic undertaken mainly by Edward Said in his book *Orientalism* ([Said, 1980] – first French translation – and [Said, 1978] – first edition in English), and 2) its further developments and counter-critics. It is necessary for a better comprehension of Musicological Orientalism and its process, and stresses particular points that are developed in the chapter addressing Byzantinism, notably Todorova’s (then Fleming’s) reflection on the place of the Balkans and Greece in the Orientalist process, and Johnson’s considerations on the relations of the West with Eastern Churches. Continuity of Orientalist thought is also demonstrated, particularly with regard to the intricate relation of this disciplinary field with religion(s). The appendix is evidently not indispensable for the readers familiar with this problematic.

¹²⁶⁹ The English first edition: in the French edition [1980] the cover reproduces a detail of Preziosi’s *Vue d’Istanbul vers 1850-1860* (see FHT 71, next page).

¹²⁷⁰ Legend taken from [Anon. “Edward Said”, 2016a] and picture slightly enhanced from [Anon. “File:Jean-Léon Gérôme - Le charmeur de serpents.jpg”]. For copyrights, see [Anon. “Commons:Reuse of PD-Art photographs - Wikimedia Commons”].

Please replace or invert, in this most interesting statement by Ghana’s late leader Kwame N’krumah, “African” with “Arabian”¹²⁷², then “English” with “French”, and the picture would thus become complete for the post-Colonial Middle East.

*
* *

*Foreword*¹²⁷³

In the introduction to the 10th chapter¹²⁷⁴ of his book *The Arabs in History*, well-known Orientalist Bernard Lewis¹²⁷⁵ (magisterially) summarizes the

→
¹²⁷¹ [N’Krumah, 1963, p. 49]: French translation by Ignacy Sachs in footnote 1355, p. 250.

¹²⁷² Or “Persian”, etc.

¹²⁷³ There is an abundance of (I would have written “innumerable” were it not for the existence of computers which can count the – nearly – innumerable) different writings on, with or against Edward Said’s *Orientalism* of which I can only quote here the most pertinent for this dossier. I rely primarily, in the introductory sections of this chapter, on the writings of three opponents or critics of Said’s *Orientalism*, Bernard Lewis (namely [Lewis, 1964 ; 1993]), Albert Hourani’s *Islam in European thought* [Hourani, 1989 ; 1992] and Graham Huggan in his article “(Not) Reading ‘Orientalism’” [Huggan, 2005]. Other (sometimes not) useful critical writings include [Trefflich, 2011] and [Warraq, 2007], not quoted here (more on the latter author in [Anon. “Ibn Warraq”, 2016]); further, the Wikipedia article on Said is well documented, notably with regard to the Lewis / Said controversy (see [O A. “Edward Said”, 2016, section 6 “Orientalism” sq.]).

¹²⁷⁴ Entitled “The impact of the West”.

¹²⁷⁵ In a recent article Tahrir Khalil Hamdi criticizes Lewis’ work: “Bernard Lewis, who coined the term ‘a clash of civilizations’ in his 1990 article entitled ‘The Roots of Muslim Rage,’ {see [Lewis, 1990, p. 56]} has done a great deal in shaping a political and cultural atmosphere, which is hostile to Arabs and Muslims in general. The mere consideration of the titles of Lewis’ two essays, ‘The Roots of Muslim Rage’ (1990) and ‘The Revolt of Islam’ (2001) {[Lewis, 2001], and the French version [Lewis, 2011]} is quite revealing. These titles suggest that Islam, as a whole, is enraged and in revolt. Muslims are an angry and irrational mob or rabble, so to speak. Why are they so enraged? As Lewis explains in both article, it is not imperialism, Zionism or American support for Arab dictators, but rather a ‘rejection of modernity in favour of a return to the sacred past’ (‘Revolt,’ 2001), a past which Lewis traces back to the seventh century. Lewis refutes ‘Arab statements on the subject’ (*ibid.*) of Muslim anger—that their anger would have anything to do with Palestine and the ethnic cleansing of its people, for example. Is it, as Lewis would have us believe, a rejection or fear of modernity, which Lewis equates with Westernness? Is it this individual’s longing to go back to a previous era of Islamic glory? Wouldn’t a more logical response be, in the case of the Palestinian, for example, as a result of the loss of land, home, belongings, identity and his now 63-year-old refugee status? What would affect an individual more potently, the circumstances of his present predicament or a theoretical

History of the relationship of the Arabs with the Occident, stressing on the power-relationships between the two sides:

“The Arabs had been in contact with western Europe since the time of the first conquests. In Spain, Portugal, and Sicily they had ruled western European populations and had maintained military, diplomatic, and commercial relations with other western European states. They had received west European students in their centres of learning. The Crusaders had brought a piece of Western Europe to the very heart of the Arab East. But these contacts, fruitful for the West which had learnt much from the Arabs, had little effect on the latter. For them the relations were and remained external and superficial and had but little influence on Arab life and culture. The geographical and historical literature of the medieval Arabs reflects their complete lack of interest in western Europe, which they regarded as an outer darkness of barbarism from which the sunlit world of Islam had little to fear and less to learn”¹²⁷⁶.

Lewis quotes further:

“An eleventh-century *Qādī* of Toledo [which], in a work on the nations who have cultivated knowledge, enumerates the Indians, Persians, Chaldees, Greeks, Romans (including Byzantines and eastern Christians), Egyptians, Arabs, and Jews. Among the rest, he singles out the Chinese and the Turks as ‘noble peoples’ who have distinguished themselves in other fields, and contemptuously dismisses the remainder as the northern and southern barbarians, remarking of the former: ‘Their bellies are big, their colour pale, their hair long and lank. They lack keenness of understanding and clarity of intelligence, and are overcome by ignorance and foolishness, blindness and stupidity’”¹²⁷⁷,

adding:

“As late as the fourteenth century no less a man than Ibn Khaldun¹²⁷⁸ could still remark dubiously: ‘We have heard of late that in the lands of the Franks, that is, the country of Rome and its dependencies on the northern shore of the Mediterranean, the philosophic sciences flourish... and their students are plentiful. But God knows best what goes on in those parts.’ This attitude was at first justified, but with the

progress of western Europe it became dangerously out of date”¹²⁷⁹.



FHT 71 A detail from the cover of the first French edition of *Orientalism*; being a detail of an Amedeo Preziosi more general view of Istanbul in the 1850s¹²⁸⁰.

The danger for the Arabs came¹²⁸¹, obviously, from the growing wealth and power of European nations beginning with the 16th century and their expansionism in the (mainly) 19th-20th centuries¹²⁸².

Western influence began with trade – the Capitulations of the 16th-17th centuries – accompanied by limited, but steady territorial gains on the borders of the pan-national European entity, with Napoleon

¹²⁷⁹ [*ibid.*].

¹²⁸⁰ I have chosen to reproduce this detail (which struck me when first reading *Orientalism* in the 1980s) because I (still) feel, through my knowledge of Oriental customs, that the two persons represented here in a flirting position (and in what appears to be a burial place, perhaps abandoned...) are completely dissonant with the Orient, but fit much more as a projection of an Occidental fantasy on it.

¹²⁸¹ Interpreting here Lewis’ statements.

¹²⁸² “From the beginning of the sixteenth century a new relationship between Islam and the West is discernible. The West made great technological advances in the crafts of war and peace. It renewed itself through the Renaissance and the Reformation, and enriched itself through the discovery and exploitation of the New World. The break-up of the feudal order freed trade and unleashed enterprise, for which the consolidation of centralized nation states provided solid and reliable political instruments. At both ends of Europe, in the Iberian Peninsula and in Russia, Christian peoples were able to complete the long struggle of the Reconquest, and to end centuries of Muslim rule. But the struggle did not end with the defeat of the Moors in Spain and of the Tatars in Muscovy. At both ends, the triumphant Europeans pursued their former masters into their homelands—the Spaniards and Portuguese into and around Africa, the Russians into Asia—and thus inaugurated the great process of the expansion of Europe which by the twentieth century had forced the Whole world into its economic, political, and cultural orbit” – in [Lewis, 1993, p. 181–182]; there is a curious shift in Lewis’ discourse here, as he passes from a discourse on the Arabs and the West to a discourse on the conflict between Islam and Christianity (“Christian peoples”), although the fact that both religions were present in Europe (Spain, Portugal and Russia) may (partly?) explain this shift.

→ hypothesis which traces his anger to centuries past as Lewis and others have done? But, then, Lewis, as an Orientalist scholar, presumes to know more about the Oriental than the Oriental knows about himself. The Oriental, it seems, cannot absorb the source of his own anger” – [Tahrir Khalil Hamdi, 2013, p. 132].

¹²⁷⁶ [Lewis, 1993, p. 179].

¹²⁷⁷ [Lewis, 1993, p. 179–180].

¹²⁷⁸ The famous Traveller/Historian of the 14th century, author of the *Muqaddima* (The Introduction) which became a reference for subsequent historians, notably in Ottoman Turkey – more information available in [Anon. “Ibn Khaldun”, 2016].

Bonaparte’s “Expedition in Egypt”¹²⁸³ marking the era of direct military interventionism in the Ottoman Empire and Arabian (and others, mainly Muslim¹²⁸⁴) countries, while trade evolved into direct or indirect control of economic resources from those countries¹²⁸⁵.

The process eventually ended up¹²⁸⁶ with the colonization, in different forms¹²⁸⁷, of the vast majority of the former rulers’ of parts of European countries¹²⁸⁸. Accompanying and preceding this territorial expansion, a large body of writings on the “Orient” was gradually composed to fulfill the needs of European nations in trying to understand, and eventually better rule, the colonized new territories. This body extends from more or less exotic and fictional literature (and visual arts productions – see FHT 70, p. 238) on the subject¹²⁸⁹ to historical, lexicographical and technical research on the peoples of, notably, “Islam”¹²⁹⁰.

¹²⁸³ I have always wondered at the understatement of this (originally French) expression; wasn’t it a simple war against the Ottoman Empire? Of course, Napoleon’s discourse on freeing the enslaved peoples under Ottoman rule, the fact that the French army was accompanied by scientists who studied the Arts and archeology, geology, etc. of the conquered countries or lands, all this played a role in the discourse of French authorities (a kind of precursor of the Colonialist discourse on the “Civilizational role” of the Colonialist nations); today, Napoleon’s “Expedition” is (should be?) seen for what it really is, the occupation of Egypt (see for example [Cronin, 2015, p. 651], but also the contradicting “Napoleon’s Enterprise in Egypt” in [Leoni, 2007]) by a Colonizing nation.

¹²⁸⁴ See FHT 74.

¹²⁸⁵ [Lewis, 1993, p. 183].

¹²⁸⁶ Did it really end up in such a way? Are we not today living the consequences of this process, both in the East and the West?

¹²⁸⁷ Lebanon and Syria lived for decades, for example, under a French mandate granted by the League of Nations, which was administratively different from direct colonialism, although resulting in the same subordination of Autochthonous populations to the Mandate rule (more info in [Anon. “French Mandate for Syria and the Lebanon”, 2016]).

¹²⁸⁸ See FHT 72, FHT 73 and FHT 75.

¹²⁸⁹ Flaubert’s *Salammô* being a typical example of pseudo-Historical literature on the (Ancient) Orient – more in [Anon. “*Salammô*”, 2016].

¹²⁹⁰ I use mainly the term “Islam” (with a capital “I”) for the culture and civilization of the people living in countries under Islamic rule (or partly under it as for Lebanon) whose peoples, in their vast majority, consider themselves as “Muslims” (as for the African countries in general, Iran, Turkey, Central Asia, Muslim African countries and, evidently, Pakistan and the Philippines – for a map showing the extension of Islam today, see FHT 74 and [Anon. “Historical Atlas of Islam - Brill Reference”; Jul. 6 and 929]), and “islam” (with a non-capitalized “i”) for the religion itself.

Concurrently, a massive enterprise of translation and edition of “Autochthonous literature” was undertaken by various Occidental (mainly) philologists¹²⁹¹, thus providing scholars with technical and cultural data about the conquered nations¹²⁹².

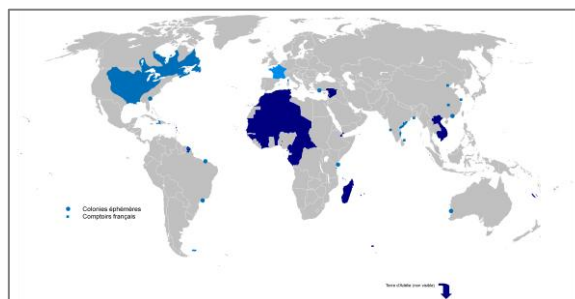

FHT 72 The two French Colonial empires¹²⁹³.

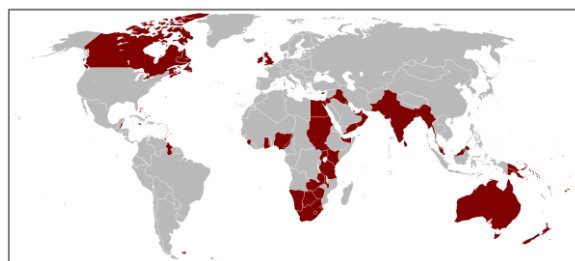

FHT 73 The British empire at its peak in 1921¹²⁹⁴.

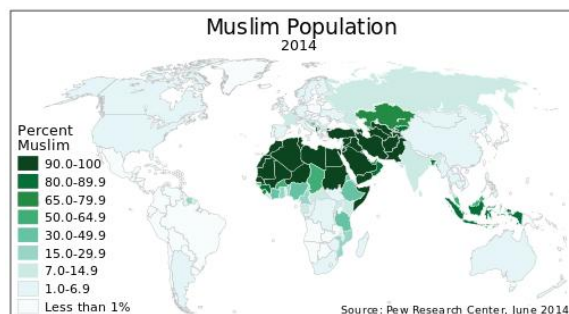

FHT 74 Percentage repartition of Muslim population in the world in 2014¹²⁹⁵.

¹²⁹¹ And (in the case of music) sometimes musicologists with knowledge of the local languages.

¹²⁹² Bonaparte’s “expedition” to the Middle East (1798-) was accompanied, for instance, by a group of scientists (including Villotteau as a musician – see also [Leoni, 2007, p.173] and [Pèrès, 1957]).

¹²⁹³ Source: [Gd21091993, 2010] – Light blue: the 1st Colonial empire (c. 1546-1763); Dark Blue: the 2nd Colonial empire (c. 1763-1962).

¹²⁹⁴ [Vadac, 2008].

¹²⁹⁵ Source [O A. “1280px-Muslim_Percent_Population.svg.png (Image PNG, 1280 × 703 pixels) - Redimensionnée (36%)”; O A. “Muslim world”, 2016] – more detailed maps on the expansion of Islam and the current repartition of Muslims can be found in the

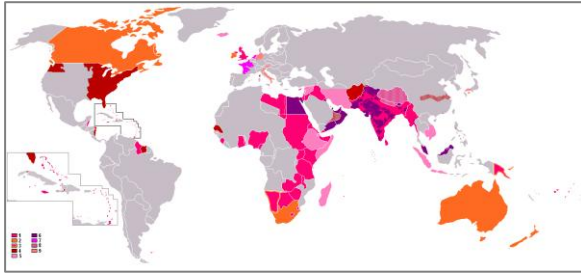

FHT 75 Anachronous map of the British Empire including colonies (Pink), dominions (Orange), colonies of dominions (Pink in Orange), areas occupied in World War II (Light pink), Princely states (India) and other protectorates (Purple) and sphere of influence (see details in source)¹²⁹⁶.

Orientalism

“Orientalism” *per se* relates today much more, as a direct sequel of the publication of Edward Said’s *Orientalism* in 1978¹²⁹⁷, to the Academic discourse of European (then more widely “Occidental”) nations on the Orient (and mainly Islam)¹²⁹⁸. Said’s influential¹²⁹⁹ (and largely misinterpreted, it seems¹³⁰⁰) book was

French edition of Reza Aslan’s *No god but God* [Aslan, 2015, p. 32 sq.].

¹²⁹⁶ [Anon. “British_Empire_Anachronous.4.PNG (Image PNG, 1357 × 628 pixels) - Redimensionnée (78%)”].

¹²⁹⁷ See footnote 1273, p. 222.

¹²⁹⁸ “‘Orientalism’ was advanced by Edward Said to denote ‘the corporate institution for dealing with the Orient—dealing with it by making statements about it, authorizing views of it, describing it, by teaching it, settling it, ruling over it: in short Orientalism [can be discussed and analyzed] as a Western style for dominating, restructuring, and having authority over the Orient’ – [Todorova, 1994, p. 453] quoting [Said, 1978, p. 3].

¹²⁹⁹ [Fleming, 2000, p. 1231–1232] quoting [Prakash, 1995, p. 200–201]: “More than anything else, what accounts for the extraordinary impact of *Orientalism* is its repeated dissolution of boundaries drawn by colonial and neo-colonial Western hegemony. The book ignited an intellectual and ideological conflagration by its insistent undoing of oppositions between the Orient and the Occident, Western knowledge and Western power, scholarly objectivity and worldly motives, discursive regimes and authorial intentions, discipline and desire, representation and reality, and so on. Violating disciplinary borders and transgressing authoritative historical frontiers, *Orientalism* unsettled received categories and modes of understanding”. Said himself comments in [Said, 1985, p. 89]: “Fortunately, *Orientalism* incited a great deal of comment, much of it positive and instructive, yet a fair amount of it hostile and in some cases (understandably) abusive”.

¹³⁰⁰ [Huggan, 2005, p. 135]: “Oscar Wilde once famously said that there is only one thing worse than being talked about, and that is not being talked about. Said seems unlikely to suffer the latter fate, even if it sometimes seems as if his work has been all the more enthusiastically talked about the less it has been comprehensively read”.

preceded, however¹³⁰¹, by Abū-l-Lughud’s *Arab rediscovery of Europe*¹³⁰² and Abdel-Malek’s article “L’Orientalisme en crise”¹³⁰³, all these corner-stone writings by Arabs living and teaching in the Occident¹³⁰⁴, and trying to express the need for another discourse on the “Orient”¹³⁰⁵, with the two most critical writings, Said’s and Abdel-Malek’s *Orientalism(s)*, receiving in their turn (more or less) harsh criticism from the criticized Orientalists¹³⁰⁶.

As for E. Said’s thesis and its reception in the West, it seems to me best explained in Huggan’s “(Not) Reading ‘Orientalism’”:

“The Orientalists, Said suggests, produced among several other things a kind of collective guidebook for uninitiated Western readers, but less a guidebook that informed them than one that confirmed what they already knew (*Orientalism* 81). Hence the constitutive tension in Orientalism between the need to accumulate detailed scholarly knowledge of the

¹³⁰¹ It is worth here mentioning [Hourani, 1962] (*Arabic thought in the liberal age 1798-1939*) re-issued as [Hourani, 1970] (and many more editions), although he is considered a “Classical” Orientalist.

¹³⁰² [Abu-Lughod, 1963], re-issued as [Lughod and Khalidi, 2011].

¹³⁰³ [Abdel-Malek, 1963b], translated in [Abdel-Malek, 1963a], received critical responses from European Orientalists such as [Gabrieli, 1965a] and [Cahen, 1965].

¹³⁰⁴ And of Arabian (or mixed) ascendancy.

¹³⁰⁵ Although Hourani’s arguments were more directed towards the secularization of the Islamic thought (and civilization) than towards the modification of the discourse about it.

¹³⁰⁶ Said’s *Orientalism* was widely acclaimed or criticized, it influenced the Academic world profoundly, triggering or stimulating post-Colonial studies in the United States (see for instance [Reichmuth, 2005, p. 307]); this was however not the case for Abdel-Malek’s “Orientalism in crisis” in France (see [Brisson, 2009]); Brennan [2000, p. 583] makes the case (as others after him – see for instance Brisson, cited above and [Almárcegui, 2003]) that the “success” of Said’s book was circumstantial: “[M]any other scholars had argued basically what Said had argued before him, and there were a number of earlier eloquent studies that, in retrospect, seemed to achieve the same clarity in regard to the function of imperial scholarship, the East/West civilizational divide, and the destructive power of the media mind. Had Said, for example, not written the book in the United States, or had he not been Palestinian, or had he not written it at a particular juncture in U.S. imperial resurgence, or had he not been a Columbia professor—or, for our purposes here, had there not been a transitory need within the academy for a curricular and discursive shift to account for the collapse of anticolonial liberation movements and the new demographics of American graduate schools—Orientalism would probably not have had the impact that it did. There are, in other words, limitations that need to be underlined here as well as achievements, for otherwise we cannot understand why the book has been in key ways misread or why it has been enlisted on behalf of a body of postcolonial scholarship with which it has had a quarrel all along”.

Orient and the desire to fail back on prescriptive formulations that distilled it into a version of what was already known before. More knowledge was needed, but not really needed since the Orient was already known (or at least intelligently intuited); more reading was needed, but not really needed since it confirmed what had already been written before. [... p. 127] Prescriptive rather than descriptive, the Orientalist system of representation was as likely to impede knowledge of the Orient as to produce it. Certainly, it was disinclined to the production of new knowledge: its contradictory reality was that it fostered a 'textual attitude' or predisposition that allowed the Orient to be regularly rewritten, but that effectively prevented it from being critically reread (*Orientalism* 80-81)¹³⁰⁷.

"While [Said] initially acknowledges the wide variety of instructive Western-academic responses he has received to Orientalism, he then points out that many of his respondents have continued, possibly inadvertently, to drown out the voices of those on whose behalf they have appeared to want to speak (127-28). He stresses, however, that this dialogue of the deaf has developed on both sides of the Oriental/Occidental divide, not only in certain sympathetic kinds of Western anti-Orientalist criticism, but also in those anti-Western (Said calls them 'nativist' or 'fundamentalist') readings that have chosen to misinterpret Orientalism, from a position of 'cultural insiderism' (142), as an apology for Islam or a wholesale condemnation of the iniquities of the West (132). Ironically, then, Said sees his book as having become subject to an Orientalism of reception in which the critics have often fallen into an alternative Orientalism, and the critics of the critics have been unwilling or unable to engage the critics 'in a genuine intellectual exchange' (132)¹³⁰⁸.

"[citing here Said's 1995 afterword for *Orientalism*] Orientalism is not 'just the antiquarian study of Oriental languages, societies, and peoples,' but is an evolved 'system of thought [that] approaches a heterogeneous, dynamic, and complex human reality from an uncritically essentialist standpoint' (333); Orientalism presupposes a non-Oriental reader insofar as '[t]he discourse of Orientalism, its internal consistency [sic]¹³⁰⁹ and rigorous procedures, were all designed for readers and consumers in the metropolitan West' (336). This familiar roll-call is then followed by an equally familiar demolition of Bernard Lewis, Said's intellectual nemesis, whose 'verbosity scarcely conceals both the ideological underpinnings of his position and his extraordinary capacity for getting nearly everything wrong' (343). Lewis and his followers, fumes Said, specialize in the 'elaborate confection of ideological half-truths [intended] to mislead non-specialist readers' (346), thereby reconfirming the very prejudices his own book had been explicitly designed to contest. These are the arguments one finds, again and

again, in *Orientalism*: that routine misreadings and misinterpretations can have devastating consequences for those routinely misread and misinterpreted; that erudition in the service of ignorance is another form of ignorance; that reading itself may produce knowledge –as in knowledge of the Orient– that confirms the authority of the knower without creating new possibilities for understanding or extending the boundaries of the known"¹³¹⁰.

Said's thesis arose criticism even among authors such as Hourani who, in the closing paragraphs of a 1989 conference, besides appealing for "a new kind of Muslim education"¹³¹¹, gives his thoughts about the criticism of "Orientalism" in what he probably regarded as a balanced approach to the problematic¹³¹².

¹³¹⁰ [Huggan, 2005, p. 129].

¹³¹¹ [Hourani, 1989, p. 283]: perhaps he should have also referred to a "new kind of Eastern Christian education"?

¹³¹² This conclusion is worth a (nearly) extensive quote: "There is another range of criticism which comes from among scholars themselves, and not only from those whose inherited culture is that of Islam. The critique of 'orientalism' which has become current in recent days is partly an expression of the conflict of different generations, partly of different intellectual formations. There appears to be three main lines of attack. It is said, first of all, that Western scholarship has tended to be 'essentialist': that is to say, to explain all the phenomena of Muslim societies and culture in terms of the concept of a single, unchanging nature of Islam and what it is to be a Muslim. There was some truth in this during an earlier period of Islamic scholarship, and echoes of it are still to be heard in popular writing and the mass media, but it has not been the dominant attitude of those in the central tradition of scholarship at least since the time of Snouck Hurgronje. Most of them would accept a formulation such as his: that Islam, as articulated in laws, rituals, and institutions, has provided a norm which affects societies where it has been the dominant religion, but the nature of any particular society can be explained only in terms of the interaction between this norm and the specific traditions and situation of that society, and even the norm itself changes in different times and places.

It is suggested, secondly, that Western scholarship has been politically motivated: in the period of European power –and now in that of another kind of Western ascendancy– it has been used to justify domination over Muslim societies, by creating an image of Muslim societies (or oriental societies in general) as stagnant and unchanging, backward, incapable of ruling themselves, or hostile; fear of the 'revolt of Islam' haunted the mind of Europe during the imperial age, and has now come back to haunt it once more. Again, there is some truth in this accusation, in regard to a certain period, but the attitude to which it points was not necessarily an ignoble one, nor universal. It was natural that British, French, and Dutch scholars should feel some responsibility for the way in which their governments exercised power; no doubt some of them did accept those broad divisions of mankind, between East and West, Christianity and Islam, advanced and backward, which could be taken to justify Western domination, and this has been prolonged into the present age by the elaboration of such broad

¹³⁰⁷ [Huggan, 2005, p. 126–127].

¹³⁰⁸ [Huggan, 2005, p. 128].

¹³⁰⁹ This is from Huggan.

Whenever Hourani expresses what is more to be considered as a classical Orientalist's response to *Orientalism*¹³¹³, Huggan explains further:

→ distinctions as that between 'developed' and 'underdeveloped' countries. Not all 'orientalists' did accept such distinctions or their implications, however. Some were strong opponents of the imperial policies of their countries: E. G. Browne in England was a supporter of the constitutional revolution in Iran, Louis Massignon of the Algerian movement for independence; others, such as Hurgronje, used what influence they had in favour of a more sensitive and understanding attitude toward those whom their nations ruled. What became the central tradition of Islamic studies in the nineteenth century, that expressed in German, was not so deeply marked by such attitudes, since neither Germany nor Austria had direct rule over Muslim countries in Asia or Africa; here too, however, certain distinctions of this kind were implied in such ideas about world history as those of Hegel.

The third line of criticism is that Western thought and scholarship have created a self-perpetuating body of received truths which have authority in intellectual and academic life but bear little relation to the reality of the object which is studied. There is undoubtedly some truth in this. Perhaps it is inevitable that scholars and thinkers should work in this way. In trying to understand a subject, we have to bring to it certain categories of explanation, which serve at least as principles of selection and emphasis; it is inevitable that these should be drawn from our own intellectual tradition, and they tend to perpetuate themselves. There is no other way of working effectively, but what may perhaps be said is that the categories which many of those who have worked on in the study of Islam have used are not those of the most vital modern thought, and are not likely to produce results which will be of great interest to those outside the ranks of specialists. The basic categories are still, to a great extent, those formulated by Goldziher, drawn from the speculative thought and philological scholarship of the nineteenth century. Compared with Chinese or South Asian history, that of most of the Muslim countries is still an underdeveloped field of study. This is so partly because serious studies of Muslim history and societies, formed by the specific discourse of these subjects, are comparatively new, and there are few specialists in the field; partly also because thinkers and scholars working within those societies have not – with some exceptions – been able to impose the authority of their own categories of explanation. This may be changing now, as more scholars of a new generation enter the field and make use of categories drawn from new bodies of thought. It is clear, however, that we should not expect to see emerging the same kind of consensus as existed in the past. There will be differences of approach between various lines of scholars, and there may well be also a difference of emphasis between those who look at the world of Islam from inside and those who look at it in terms of an inherited Western culture” – [Hourani, 1989, p. 283–286]; let us note here that this criticism of Edward Said's *Orientalism* is undertaken by Hourani without even citing him or his book...

¹³¹³ To be compared with Gabrieli's response to Abdel-Malek's article in [Gabrieli, 1965b] (English translation in [Gabrieli, 1965a]). Gabrieli, a distinguished Orientalist himself (and notably the author of *Chroniques arabes des Croisades* [Arabian chronicles of the Crusades] – [Gabrieli, 1977] – which was consistently copied in Amin Maalouf's *Les croisades vues par les Arabes* [The Crusades as seen by the Arabs] – [Maalouf, 1983]) advocated

“[T]hree patterns in the critical response to *Orientalism* have established themselves. The first of these patterns involves what might be called the ‘*de-Orientalization*’ of *Orientalism* (the method) [...] *Orientalism* is more historically and geographically heterogeneous than many readers have given Said credit for; the Orient to which he refers, at different moments and in different interests, may encompass all or parts of Central Asia, North Africa, Turkey, and the Middle East [...]. But given the fundamental heterogeneity and instability of the discourses contained within the umbrella term ‘*Orientalism*,’ why not cast the net even wider? Lowe, for one, cannot resist, including a chapter in her book on the utopian projection of Japan and China under French poststructuralism [...]. Other critics have interpreted the range and scope of *Orientalism* even more freely, using it, for example, as a critical tool for the unpacking of self-serving European colonial constructions of ‘darkest Africa’ and their corresponding cultural myths [...]. Studies such as these, which Said welcomed [...] risk emptying out the already mythologized category of the Orient, turning *Orientalism* into a codeword for virtually any kind of Othering process that involves the mapping of dominating practices of knowledge/power onto peoples seen, however temporarily or strategically, as culturally ‘marginal,’ economically ‘undeveloped,’ or psychologically ‘weak’”¹³¹⁴.

→ “enlightened” *Orientalism* and its use in the Academic process (in Chapters II, IV and V, I show that “enlightenment” is far from being an adequate substantive whenever it comes to Occidental readings of Ancient Greek music theories as applied to Byzantine chant and *maqām* music); for Gabrieli's argumentation, see also [Angheliescu, 2005, p. 11–12]: “Answering the accusations made by Anouar Abdel-Malek against orientalism as a whole, Francesco Gabrieli, at that time a professor of Arab language and literature at the University of Rome said: ‘In the past, the original contribution of certain oriental civilizations to the study of their own history was quite valuable, at a time when the Westerners ignored the East with vanity and candor. Today, by keeping in contact with this past, the way of scientific progress and intellectual maturity in the study of these civilizations still goes through Western orientalism, that is, through the European historical, philological, sociological thinking’. We cannot deny the West, he says elsewhere, the right to apply its own conceptions elaborated throughout its modern history, its own sets of values on what we should understand by history, civilization, philosophy. We cannot ask the West to look at the East ‘with Oriental eyes and an Oriental mentality’. For the humanists of our times, of Gabrieli's type, it is hard to understand the reproach made against the Orientalists, that they were accomplices of colonialism. It is equivocal and false, he says, to state that the main, or only, reason of the historical, linguistic, literary and religious interest Europe had in the Oriental world ‘was related to the political and economic plans of colonization’” – the rest of Angheliescu's article, in which she defines herself as an Orientalist, reproduces notably (in the beginning section) Arabian critics of *Orientalism* from as early as 1932.

¹³¹⁴ [Huggan, 2005, p. 125–126].

“A second pattern of response to Orientalism emerges here that we might call the ‘*re-Orientalization*’ of *Orientalism* (the book). Within this pattern, Orientalism’s exclusionary and immobilizing strategies are either inadvertently reproduced by those who seek to uncover alternative examples of its workings (‘anti-Orientalist Orientalism’) or are consciously deployed by those who, constructing themselves as the West’s victims, turn against their adversaries in uncompromising gestures of collective pride and righteous anti-imperialist revenge (‘Occidentalism’)”¹³¹⁵

“[A] third category of response to Said’s text that draws attention, explicitly or implicitly, to the unreflected Orientalism of *Orientalism* itself. This largely hostile view of *Orientalism* (the book) is founded on a series of apparently embarrassing paradoxes: that it reproduces the enumerative, patiently cumulative, and paternalistic methods of the ‘master’ Orientalists; that it reinstates broad transhistorical and cultural generalization in the service of magisterial expertise; that its seemingly counterintuitive insistence on the internal consistency of Orientalism is inconsistent with Said’s own Foucault-inspired discursive methods (but remains uncannily consistent with the self-authorizing maneuvers of classical Orientalism itself); that it assembles a textualized Orient with a view to establishing intellectual authority over it, even if this ‘textual, contemplative’ Orient is never allowed, like its nineteenth-century historical counterpart, to facilitate

¹³¹⁵ [Huggan, 2005, p. 126]; compare with [Fleming, 2000, p. 1222, n. 12]: “In the 1994 afterword to *Orientalism*, for instance, Said denigrates those who [slide] back into stereotypes like ‘the conflict of East and West’ and laments the fact that the enthusiastic welcome given the Arabic edition of the work was based largely on emotionality and misinterpretation. ‘The sense of fraught confrontation between an often emotionally defined Arab world and an even more emotionally experienced Western world drowned out the fact that *Orientalism* was meant to be a study in critique, not an affirmation of warring and hopelessly antithetical identities.’ But clearly these two things are not mutually exclusive, and the fact that Said’s ‘study in critique’ claimed as its territory the interplay between these ‘antithetical identities’ would make his protestations of utter innocence a bit disingenuous. Said, *Orientalism*, 334, 338”.

On a more personal note, I would like to share a fact that I have experienced in the late 1990s, in Beirut: I went to a debate (I vaguely remember it taking place in the West Hall of the American University of Beirut or some other location in the university) with Edward Said, who was presented (in Arabic) by a well-known left-wing Lebanese writer. The presenter, whom I knew as a rather self-contained person, was very excited by the event. He introduced Said in a very hagiographic manner, with his excitement growing through the (almost) 10 minutes of presentation (he was nearly shouting at the end), finally calling Said “and here he is, the (so and so), author of *Orientalism* (and others I do not remember)” etc.; I was so downcast by this whole process that I quietly rose and left: I saw Said entering the scene though, and noticed that he did not seem very pleased either.

the control of the geographical Orient as an ‘economic, administrative and even military space’”¹³¹⁶.

While Orientalism, Occidentalism and Re-Orientalism are musicological realities of the last two to three centuries¹³¹⁷, it is worth exploring more the place of the former Near East in Orientalist and (its musicological counterpart) Hellenistic thought.

THE BALKANS AND GREECE: ORIENTAL OR OCCIDENTAL?

In his article about Europeo-Centrism, Ignacy Sachs reminds us that there have been as many Europes as there have been reflections on “what is Europe”¹³¹⁸, while Fleming provides in his article “Orientalism, the Balkans, and Balkan Historiography” interesting thoughts and analyses, for example:

- on the denominations “Near” and “Middle East”:

“A map of the ‘Near East’ published in 1911 has as its westernmost point Banjaluka, in Bosnia, and as its easternmost Konya, in Turkey.¹³¹⁹ The Near East now has disappeared, or become a chronological (as in ‘the ancient Near East’) rather than locational marker. We have a West and a Middle East, even a Far East, but the Near East—or what it used to be—has become so near that it is no longer the East but the West”¹³²⁰,

- on the place of the Balkans (and notably Serbia and Greece) in the East-West relation:

“It is unclear whether the Balkans are the East or the West, but unclear, too, is just what counts as Balkan. On the eve of World War I, Turkey was decidedly ‘Balkan’ (it no longer is), as was Greece (it is now trying hard not to be); Hungary sometimes was (now it never is). ‘Balkan,’ clearly, is as much a conceptual designator as a geographic one, and just as its contours have changed over history, so, too, has the entire category shifted between East and West. The Balkans now are, albeit grudgingly, unanimously agreed to be in the West (that is, in Europe), whereas they used to be relegated to the East (the ‘Orient’) [...] Said has alerted us to the fact that the ‘Orient’ is less an actual place than a frame of mind, and he defines it in fact not as a territory but as a mode of thought”¹³²¹.

¹³¹⁶ [Huggan, 2005, p. 126].

¹³¹⁷ See Chapter V.

¹³¹⁸ [Sachs, 1966, p. 466, n. 4] quotes here [Duroselle, 1965, p. 25]: “L’Europe étant une construction de l’esprit humain à partir d’une réalité géographique mal délimitée, il y a eu depuis que les hommes y réfléchissent une immense variété d’Europes”.

¹³¹⁹ Citing [Woods, 1911, appendix].

¹³²⁰ [Fleming, 2000, p. 1228].

¹³²¹ [Fleming, 2000, p. 1230].

“Where is one to place Serbia, for instance, in the Saidian formulation? Greece, with its peculiar cultural relationship to the West, provides a still more categorically perplexing example”¹³²²,

- on the reasons for the sometimes marked differences between the Balkan countries:

“Finally, the peculiar circumstances of imperial rule in the Balkans—its division between the Catholicizing Habsburgs and the *laissez-faire* Ottomans—shaped different Balkan territories in different ways”¹³²³,

- on the adoption of “Orientalist” rhetoric by both East and West:

“Milica Bakic-Hayden and Robert M. Hayden deal straightforwardly with the different, non-imperial circumstances of the Balkans. They argue that while Said ‘associates [Orientalism as a] rhetorical structure with a political and economic relationship of domination and submission,’ the ‘language of orientalism still retains its force’ in noncolonial settings, pointing out that now, in the postcolonial world, it has not as a discourse of power disappeared along with the institutions of colonialism. Bakic-Hayden and Hayden thus rehistoricize Said through their explicit interest in comparing a colonial world to a postcolonial one. In addition to suggesting some of the ways in which Orientalist discourse has outlived the very structures that first gave it life, Bakic-Hayden and Hayden’s work is particularly illuminating in showing how, when divorced from those structures, Orientalism loses much of its unidirectionality (as a discourse imposed by the West on the East) and becomes instead embedded and internalized in East and West alike. Or, better put (and more germane to the Balkan instance), they show how, through the adoption of ‘orientalist’ rhetoric by both East and West, the boundaries between the two categories begin to blur. Thus, as they argue, Orientalist rhetoric (‘Balkan mentality, Balkan primitivism, Balkanization, Byzantine, Orthodoxy’) is now deployed not just by outsiders but by the very people whom they are meant to describe. ‘These terms, and the orientalist framework in general, are often used even by those who are disparaged by them, a point... which indicates the hegemonic nature of the concepts involved.’¹³²⁴ While Goldsworthy’s work assumes a model of Western imposition on or exploitation of a non-Western ‘other’ (despite the absence of literal colonial control of that other), that of Bakic-Hayden and Hayden situates Orientalist discourse within the supposed ‘Orient’ itself, thus interrogating the nature both of that discourse and of the ‘Orient’ as a geographical and cultural category”¹³²⁵,

- and finally, on the differences between Orientalism as applied to the “Orient” and as applied to the Balkans (“Balkanism”):

“Western literatures such as those produced by Rebecca West, Christie, Durrell, et al. have led scholars to suggest the need for a category parallel to Orientalism (in its Saidian, discursive sense) that is applicable to the Balkan context. Maria Todorova, the real groundbreaker in this regard, explores the comparative possibilities of ‘Balkanism’ and ‘Orientalism,’ but she concludes¹³²⁶, quite rightly, that they are not the same thing. This is a conclusion based on many factors (differences in the perception of the geopolitical importance of the Balkans relative to the Orient, the lack of a colonial legacy in the case of the Balkans, the largely Christian makeup of the Balkans versus the overwhelmingly Muslim Orient), among them a recognition that the history of the West’s intellectual engagement with the Balkans is not reminiscent of the history of the West’s intellectual engagement with the Orient. ‘The Balkans *per se*, that is, as a distinct geographic, social, and cultural entity, were ‘discovered’ by European travelers only from the late eighteenth century.”¹³²⁷¹³²⁸.

As for Hellenism and its relation with Orientalism¹³²⁹, Vasunia’s essential article “Hellenism and Empire: Reading Edward Said” is of the utmost importance for the subject, notably on the continuation of Hellenism in Orientalist thought:

¹³²⁶ [Todorova, 1997, p. 20]: “Balkanism evolved to a great extent independently from orientalism and, in certain aspects, against or despite it. One reason was geopolitical: the separate treatment, within the complex history of the Eastern question, of the Balkans as a strategic sphere distinct from the Near or Middle East. The absence of a colonial legacy (despite the often exploited analogies) is another significant difference. In the realm of ideas, balkanism evolved partly as a reaction to the disappointment of the West Europeans’ ‘classical’ expectations in the Balkans, but it was a disappointment within a paradigm that had already been set as separate from the oriental. The Balkans’ predominantly Christian character, moreover, fed for a long time the crusading potential of Christianity against Islam. Despite many attempts to depict its (Orthodox) Christianity as simply a subspecies of oriental despotism and thus as inherently non-European or non-Western, still the boundary between Islam and Christianity in general continued to be perceived as the principal one. Finally, the construction of an idiosyncratic Balkan self-identity, or rather of several Balkan self-identities, constitutes a significant distinction: they were invariably erected against an ‘oriental’ other. This could be anything from a geographic neighbor and opponent (most often the Ottoman Empire and Turkey but also within the region itself as with the nesting of orientalisms in the former Yugoslavia) to the ‘orientalizing’ of portions of one’s own historical past (usually the Ottoman period and the Ottoman legacy)”.

¹³²⁷ Citing [Todorova, 2009, p. 62].

¹³²⁸ [Fleming, 2000, p. 1225].

¹³²⁹ See also the developments on Greece and Byzantinism in the Foreword to Chapter IV and in the latter.

¹³²² [Fleming, 2000, p. 1222].

¹³²³ [Fleming, 2000, p. 1222–1223].

¹³²⁴ Citing [Bakic-Hayden and Hayden, 1992, p. 3].

¹³²⁵ [Fleming, 2000, p. 1223–1224].

“While Said’s work has been used and explored by several scholars of ancient Greece, scholars frequently appear to mention his name only then to forget his larger claims and to practise unchanged their scrutiny of antiquity, as if invoking *Orientalism* were a sufficient gesture in itself or as if the context of modern European colonialism were irrelevant”¹³³⁰,

or on the denial of the Orientalist aspect of Hellenism:

“To trace the roots of Orientalism back to Greece is to bestow on Hellenic antiquity a sanctity of origin or a founding point of reference which, in the light of the history of European thought, has come to appear extremely problematic. Said himself has been much chastized for presenting literary history in the form of a unified and continuous grand narrative extending from antiquity to the present day. In fact, this criticism misses the point since Said was keen to suggest in *Orientalism* that the authoritative nature of the unbroken European cultural tradition was founded on massive denial and violence. The idea that a post-Enlightenment discursive formation could be traced back in any unmediated sense to ancient Greece was a self-validating European construct and fantasy. Moreover, as Said showed by example, every discursive tradition has a history and a politics, and it cannot simply emerge out of a vacuum. While many Hellenists have maintained a scrupulous concern for methodology and for the historical location of their work, it needs to be said that some, whether deliberately or not, have continued to practice a scholarship in which ancient Greece maintains its position of privilege. Scholars of antiquity who have attempted critiques of Orientalism, thus, have regularly also reaffirmed the sovereign authority of the very tradition that they seek to call into question”¹³³¹,

and finally on its unsustainability:

“Now that Europe’s self-representation seems crossed from within by the ‘Orient’, now that Europe itself has been ‘provincialized’, neither ancient Greece nor the study of ancient Greece can be thought of as they were by many scholars even twenty-five years ago. Indeed, the lesson we take from Orientalism is that how, what, and even why any one today thinks about ancient Greece is inseparable from two hundred years of European colonialism”¹³³².

Moreover, religious belongings (mainly Christian and “Other”) play a major role in the Orientalist process, which makes it necessary to undertake a rapid exploration of their roles.

¹³³⁰ [Vasunia, 2003, p. 88].

¹³³¹ [*idem*, p. 89-90].

¹³³² [*idem*, p. 96].

THE PROBLEM OF RELIGION(S)

John Tolan explains in the summary of his article “Lex alterius: Using Law to Construct Confessional Boundaries” that the two notions of “Law” and “Religion” are strongly influenced by the culture of the persons who use them:

“Historians and anthropologists are confronted with a persistent problem for which there is no clear solution: the conceptual tools which we use to attempt to understand cultures are themselves products of (often) the very cultures we are attempting to understand. Take ‘religion’. Boyarin¹³³³ has argued that the very concept of ‘religion’ as we know it was a product of the fourth and fifth centuries, as bishops and emperors constructed Christianity as a religion (the true one, of course), and in counterdistinction constructed ‘Judaism’ and ‘Hellenism’ (or paganism) as ‘false’ religions. For Boyarin, Judaism only becomes a ‘religion’ when Christian authorities define it as one. The same could be said for the jumble of texts, beliefs and rituals that the English, upon arriving in India, lump together under the name ‘Hinduism’, which they turn into a religion. Building, defining and policing borders between confessional groups has been an important part of constructing identities—or visions of community—in various societies, in particular those ruled by Christians or Muslims¹³³⁴, from the time of the fourth-century Christian Roman emperors”¹³³⁵,

concluding:

“Historians, anthropologists, sociologists and others should thus keep in mind that the terms ‘law’ and ‘religion’ are packed with strata of implications that have accumulated over the centuries: neither term translates easily into languages that were not shaped by these events. Anthropologists have of course long been aware of this and

¹³³³ [Boyarin, 2004].

¹³³⁴ The only reference to “islam” or “Muslim(s) that I could find in Boyarin’s (37 pages-long) article “The Christian invention of Judaism: The Theodosian empire and the rabbinic refusal of religion” was this quote {unreferenced, but possibly from “Jacob Neusner, *Judaism and Christianity in the Age of Constantine: History, Messiah, Israel, and the Initial Confrontation* (Chicago, 1987) found in footnote 4 [p. 48]}: “As Neusner writes, ‘in context Christianity (and later on, Islam) made rabbinic Judaism permanently relevant to the situation in which Jews found themselves’, a somewhat light argument for including Islam in the process; knowing that Islam’s politics with regard to the “Religions of the Book” (*i.e.* the Jewish and Christian religions) was mainly tolerant, equating the two positions seems to some extent, exaggerated (but Tolan expands upon the notion of “protected religions [and *dhimmi* status]” in Islam (the religion) further in his article [p. 63-66], citing primarily “Fattal, A. 1995. *Le Statut Légal des Non-Musulmans en Pays D’islam*. Beirut: Dar El-Machreq Sarl” and “Morabia, A. 1993. *Le Gihâd dans l’Islam Médiéval: Le ‘Combat Sacré’ des Origines au XI^e Siècle*. Paris: A. Michel”).

¹³³⁵ [Tolan, 2015, p. 55].

have struggled to define ‘religion’ or to propose alternate terms [...]. But often the alternate terms are even more problematic: ‘faith’ or ‘belief’, for example, emphasize a phenomenon that is at the heart of the definition of Christianity or Islam, but is only part of it—and is not the defining or most salient feature of other commonly identified ‘religions’. And of course faith and belief are important to many aspects of our lives that we do not recognize as pertaining to the realm of the religious. ‘Cult’, ‘rite’ and other terms pose similar problems. The solution is perhaps not to find some euphemistic substitute for our loaded terms law and religion, but to bear in mind that these terms, like so many others we use, are far from universal, and that to understand them one has to comprehend how they have evolved over the centuries¹³³⁶.

In contrast to the attitude with Hinduism in the aforementioned quote, the contact of the French with the Muslim religion, although it also led to more or less thorough studies of Islam¹³³⁷, seems to have faltered between the statement of the superiority of the Christian religion and that of the (seemingly?) irreconcilable differences between Islam¹³³⁸ and the secularism inherited from the French Revolution.

For instance, in the first edition (1921) of his *Les institutions musulmanes*, French Orientalist Maurice Gaudefroy-Demombynes described very pessimistically the state of Islamic religion and culture in the 19th century, concluding:

“Islam, born to the Arabs, a people with anarchistic traditions, and propagated by them, was accepted by populations with [equally] anarchistic inclinations which adopted it all the more that it did not offend their natural instincts, and which [in turn] achieved the destruction of the constructive forces that other influences sought to develop in them. In no place has Islam brutally destroyed intellectual thought or artistic development; on the contrary, it gave a new life to populations dissatisfied with aged disciplines. It has weakened at the same time that political disorder accentuated economic decline, therefore Europe, while engaging intimately with Islam in the 19th century, found nothing more than an inert and lifeless religion which kept repeating formulae and entangling in endless discussions. Weakened, fallen in all their social events, Muslim peoples deserved a mediocre religion, fitted to their size¹³³⁹.”

¹³³⁶ [Tolan, 2015, p. 72].

¹³³⁷ The religion.

¹³³⁸ The civilization.

¹³³⁹ Quoted from the 1931 edition of [Gaudefroy-Demombynes, 1921, p. 214–215].

In the 1931 edition Gaudefroy-Demombynes acknowledged that these statements were somewhat too sketchy, and reflected upon the scientific rise of Europe in the 19th century which “developed the methodical skills” of the European peoples, and “remarkably expanded their economic resources and their material strength” while

“Muslim peoples; who have different qualities and lacked the Political and National sense, found themselves in a state of marked inferiority¹³⁴⁰;

thus, whenever

“European nations slowly established the notion of Secularism and separated the Temporal from the Spiritual, the Muslim world remained connected with the doctrine of the Muslim community, which came from the Revelation and the Prophetic tradition”

and,

“although some attempts to establish Secularism took place with some Muslim peoples, that is where the main cause of disagreement between them and the European nations must be looked for¹³⁴¹.”

Finally, while dismissing the “European-induced Muslim nationalisms” and wishing that Islam would modernize itself, the author urges

“Young Muslims not to Americanize themselves too much, and not to lose all the charming qualities of the Elders: a somewhat smiling fatalism not exempt of *grandeur*; the care for social attitude which could attain Dignity; a profound sense of solidarity which led to goodness and discrete charity; the taste for a happy life, with a delicate sense of Color, of Nature, of the [natural] Harmony of things¹³⁴².”

We find in conclusion, under a “charming”, Paternalistic disguise, a completely Orientalist (in the Saidian acceptance) attitude towards the “Muslims”, denying them the possibility of reaching the level of their (today) former masters.

Nothing has really changed since in the Orientalist discourse, as it has mostly even worsened and became a call for confrontation:

¹³⁴⁰ [Gaudefroy-Demombynes, 1921, p. 215–216] – quoted from the 1931 edition; evidently today, such a statement could be considered as naïve as, with the fall of the Soviet Union, Secularism seems to be a notion from the past at a time when Religious thought and Populism have nearly completely (re-)invested the Globe.

¹³⁴¹ [Gaudefroy-Demombynes, 1921, p. 216].

¹³⁴² [Gaudefroy-Demombynes, 1921, p. 215–216].

“There is something in the religious culture of Islam which inspired, in even the humblest peasant or peddler, a dignity and a courtesy toward others never exceeded and rarely equalled in other civilizations. And yet, in moments of upheaval and disruption, when the deeper passions are stirred, this dignity and courtesy toward others can give way to an explosive mixture of rage and hatred which impels even the government of an ancient and civilized country—even the spokesman of a great spiritual and ethical religion to espouse kidnapping and assassination, and try to find, in the life of their Prophet, approval and indeed precedent for such actions. The instinct of the masses is not false in locating the ultimate source of these cataclysmic changes in the West and in attributing the disruption of their old way of life to the impact of Western domination, Western influence, or Western precept and example. And since the United States is the legitimate heir of European civilization and the recognized and unchallenged leader of the West, the United States has inherited the resulting grievances and become the focus for the pent-up hate and anger”¹³⁴³.

¹³⁴³ [Lewis, 1990, p. 59–60], under the subtitle “The clash of civilizations”, to compare with Salem’s reflection: “Despite a relatively consistent production of new books and articles on Islam and politics, it is difficult to find works which go beyond the traditional statement, namely that there is no difference, or separation between religion and politics in Islam [...] Few these authors [...] adopt a genuinely Historical approach, and few succeed in avoiding the entrapment which consists in reducing Islam to an essence expressed in one or two phrases. Few seem aware that the relation between religion and politics has evolved throughout the history of Islam – that things changed from the time of Muhammad to the one of Mamun, from Mamun to the Buwayhids [and] from the Buwayhids to the Fatimids, from the Fatimids to the Mameluks, from the Mameluks to the Ottomans and from the Ottomans to the Nation-states”; in (original) French “Malgré [une] production relativement importante de nouveaux livres et articles sur l’Islam et la politique, il demeure difficile de trouver des travaux qui dépassent l’énoncé traditionnel, à savoir qu’il n’y a pas de différence, ou de séparation, entre religion et politique en Islam [...] Peu de ces auteurs [...] adoptent une approche véritablement historique et peu réussissent à éviter le piège consistant à réduire l’Islam à une essence qui pourrait être exprimée en une ou deux phrases. Peu d’entre eux semblent être conscients du fait que la relation entre religion et politique a évolué à travers l’histoire de l’Islam – que les choses changèrent du temps de Muhammad à celui de Mamun, de Mamun aux Buwayhides des Buwayhides aux Fatimides, des Fatimides aux Mameluks, des Mameluks aux Ottomans, et des Ottomans aux États-nations” – [Salem, 1985, p. 412–413]; note that Reza Aslan’s book [Aslan, 2011] is a notable exception in the field which retells the story of the relation between Islam (the religion) and politics – from the Egalitarian rule of Muḥammad in Medina to today’s fanatisms – and of the gradual growth of the control on the Islamic religion by the *‘ulamā’* and the *fuqahā’* (the “scholars” of religion).

Whenever Islamic countries are clearly designed by Lewis as the enemy¹³⁴⁴, the Eastern Christian Churches seem to have been assigned a different role; Johnson describes vividly the aims of Western Scholars and missionaries in the late 19th and early 20th centuries:

“Whereas Edward Said describes the Orient as a topos or ‘a set of references, a congeries of characteristics’ ([1979] 1994: 177), in the writings considered [in this article], Eastern Christianity has been constructed as a *soma*, a body that can bear these references and characteristics. While also seen as a repository or museum for Western civilization’s childhood whose restoration can restore the West [...], the Christian East is here more often depicted as an ailing or moribund body in need of care and outside intervention that ultimately ‘serves the Samaritan.’ As a distorted image of the Church as body of Christ, the body has died but has not been resurrected. The word ‘barren’ [...] is used to characterize the Eastern Christian Churches, which suggests both the barren fig tree in Luke 13:6–9 and a female body unable to conceive and thus without a generational future. This body, as fallen Pauline *sarx*, is also given many of the attributes traditionally ascribed to the ‘Orient’: silence, passivity, otherworldliness, atemporality, eternity, luxury, splendor, homogeneity, and

¹³⁴⁴ Notably in [Lewis, 1990; Lewis, 2001], but also in [Lewis, 1993] as quoted in the foreword to this chapter; is it however a “love-hate relationship?” as is suggested in [Anon. “Bernard Lewis”, 2016]: “I doubt, in any case, that Zionism quite explains Lewis’s role as a cheerleader for the war in Iraq. Nor does his supposed contempt for the Arab world do so. It is a common phenomenon among Western students of the Orient to fall in love with a civilization. Such love often ends in bitter impatience when reality fails to conform to the ideal. The rage, in this instance, is that of the Western scholar. His beloved civilization is sick. And what would be more heartwarming to an old Orientalist than to see the greatest Western democracy cure the benighted Muslim? It is either that or something less charitable: if a final showdown between the great religions is indeed the inevitable result of a millennial clash, then we had better make sure that we win”, quoting [Buruma, 2004] who concludes “Lewis did say, in his Jerusalem Post interview, that he saw ‘the possibility of a genuinely enlightened and progressive and—yes, I will say the word—democratic regime arising in a post-Saddam Iraq.’ But, as has become increasingly obvious, an invasion by foreign armies is not the ideal way to bring this about. Here, Rashid Khalidi who {still – see [Anon. “Rashid Khalidi - Faculty - Department of History - Columbia University”]} holds ‘the Edward Said Chair in Arab Studies at Columbia’, and attributed ‘American failures in the Middle East to ignorance, or worse’, {notably in his book *Resurrecting Empire: Western Footprints and America’s Perilous Path in the Middle East*” [Khalidi, 2004] – he also edited the 2011 version of Abu Lughod’s *Arab rediscovery of Europe* cited above} appears to be more clearheaded when he says that ‘unwanted foreign military occupation, or even the threat of it, is incompatible with democratization.’ Let us hope that he is wrong and Lewis is right. But it looks as though Arabs are crawling through yet another ring of Hell, prompted in part by the zeal of a man who claimed to wish them well”.

absolute opposition to the West. What most accounts from this perspective share is a mixture of repugnance at the present state of Eastern Christianity and hope for its future revival according to the standards of, and in service of, Western Christianity. It is a sleeping giant that awaits rescue and rehabilitation, a Frankenstein constructed of the remnants of once-living Christian cultures, and the goal of Western scholars and missionaries is to eventually reanimate it for their own purposes¹³⁴⁵,

concluding:

“[N]ineteenth-century authors try to reconcile what they consider to be two contradictory categories, Oriental and Christian. These accounts use somatic imagery to depict a body of Christians that are nearly dead from the suffocating weight of the Orient but are capable of being brought back with outside help, which helps to justify proselytism or even political intervention. This example also shows how a complex and varied tradition or set of traditions can be described as a unified body, inscribed with various useful characteristics (in this case, symptoms and illnesses calling for remedy), and then prescribed a treatment based on this diagnosis (in this case, the nurturing or resuscitation of an ailing or deceased body)¹³⁴⁶”.

I could not have found a better description¹³⁴⁷ of the general process which led to, among other changes, the modifications in Byzantine music theory in the late 19th century.

Consequences of Orientalism

Whenever colonialism, and its Academic companion Orientalism, secured a firm grip of the European nations on the dominated peoples in their dominions and colonies, the contradictions between the “civilizational” discourse and the aspirations of the latter for political (if not economical and social – and immediate) freedom ended up eventually with the independence of (almost) all conquered countries, most of them in the artificial boundaries agreed upon by the Colonizing nations; the consequences of the period had however deep roots in the newly “independent” societies, as Ignacy Sachs puts it:

¹³⁴⁵ [Johnson, 2014, p. 814].

¹³⁴⁶ [Johnson, 2014, p. 835]; this seems to be a useful complement to Todorova’s conclusion in [Todorova, 1994]: “With the rediscovery of the East and Orientalism as independent semantic values, the Balkans are left in Europe’s thrall, anti-civilization, *alter ego*, the dark side within”.

¹³⁴⁷ Although Johnson sets limits for his article with British and American literature on the subject.

“the struggle against colonization implied [...] that the dominated peoples would assimilate the techniques and the tangible values of Europe. The English¹³⁴⁸ Arabist B[ernard] Lewis described the resulting, ambivalent attitude towards European culture: ‘Even after liberation, the intelligent and sensitive Arab cannot but be aware of the continued subordination of his culture to that of the West. His richest resource is oil¹³⁴⁹ – but it is found and extracted by Western processes and machines, to serve the needs of Western inventions. His greatest pride is his new army¹³⁵⁰ – but it uses Western arms, wears Western-style uniforms, and marches to Western tunes. His ideas and ideologies, even of anti-Western revolt, derive ultimately from Western thought. His knowledge even of his own history and culture owes much to Western scholarship. His writers, his artists, his architects, his technicians, even his tailors, testify by their work the continued supremacy of Western civilization—the ancient rival, once the pupil, now the model, of the Muslim¹³⁵¹. Even the gadgets and garments, the tools and amenities of his everyday life are symbols of bondage to an alien and dominant culture, which he hates and admires, imitates but cannot share. It is a deeply wounding, deeply humiliating experience’. Lewis raised thus a real issue, even if one may not share completely his views¹³⁵²,

¹³⁴⁸ And American since 1982 – see [Anon. “Bernard Lewis”, 2016].

¹³⁴⁹ This is a very restricted lecture of resources in the Arabian countries (most of them do not have oil), perhaps because of the importance of oil to the West (and to Lewis?).

¹³⁵⁰ I really wonder at reading this: I do think (at least some) Arabs may have other subjects of pride than the army.

¹³⁵¹ We see here at work the continuous assimilation by Lewis, of Arabs to Muslims.

¹³⁵² (Ignacy) [Sachs, 1966, p. 482], quoting [Lewis, 1964, p. 135]: in French “La lutte contre la colonisation impliquait cependant que les peuples dominés s’assimilent les techniques et les valeurs matérielles de l’Europe. L’arabisant anglais B. Lewis a décrit l’attitude ambivalente qui en résulte vis-à-vis de la culture européenne: ‘Même après la libération l’Arabe intelligent et sensible ne peut pas ignorer la continuelle subordination de sa culture à celle de l’Occident. La ressource principale de son pays, le pétrole, est exploitée selon des techniques occidentales et destinée aux besoins des économies occidentales. Son plus grand sujet de fierté — l’armée nouvelle — se sert d’armes occidentales, porte des uniformes occidentaux et marche au son de musiques occidentales. Ses conceptions et ses idéologies — y compris celles de la révolte contre l’Occident — s’inspirent toujours, en dernière analyse, de pensées occidentales. Les écrivains, les architectes, les techniciens et jusqu’aux tailleurs, s’inspirent dans leur travail de la supériorité de la civilisation occidentale qui, après avoir été l’ennemie, devient un modèle pour les musulmans. Même les gadgets, les parures, les objets qu’il utilise pour son confort et dans toute sa vie quotidienne deviennent, pour l’Arabe, autant de signes de son asservissement à une culture étrangère qu’il déteste et admire, qu’il imite et qu’il refuse. Il fait une expérience profondément blessante et humiliante’. Lewis a ainsi posé un problème réel même si on ne partage pas entièrement ses vues”.

while he remarks:

“African intellectuals and leaders stressed frequently the fact that the colonized have been deprived [stripped] of their cultural and historical personality [...]”¹³⁵³. Following a remark by [Jacques] Berque, colonization induced ‘deculturation’ and ‘denaturation’ to the Natives¹³⁵⁴⁺¹³⁵⁵.

In the same decade, Jean-Paul Sartre made the connection between the Colonialist *Mission civilisatrice* and Hellenism¹³⁵⁶, while History provides us with (at least) one, supplementary warning:

“[In 1860], the annexation of Central Italy to Piedmont irritated Austria and other governments of the Peninsula. The Vienna office had withdrawn its ambassador from Turin, and made the clink of weapons heard in Veneto. Pope Pie X launched, on March the 30th, an excommunication against all the protagonists, promoters, coadjutors, counselors or supporters of the usurpation [...] but this [papal bull] had no impact whatsoever. [...] It was then projected to call to Rome, to organize the papal army, a famous general, Lamoricière¹³⁵⁷, who was however hostile to the government of Napoleon III. [...] As soon as he took command [General] Lamoricière addressed, on April the 8th, the papal troupes with the following order of the day which raised vivid surprise,

coming from a general who was formerly a minister of the French Republic: ‘His Holiness Pope Pie IX having deigned to call me to the honor of commanding you to defend His unrecognized and endangered rights, I took up arms, unhindered. [...] Christianity is not only the religion of the Civilized world, it is the sole principle of civilization; [...] The revolution, *like islam once*, threatens today Europe and, today as before, the cause of the Pope is the cause of civilization and freedom in the world. [...]’¹³⁵⁸.

The author concludes:

“This comparison between the revolution and Islamism was to the least strange, not to say more”¹³⁵⁹.

No further comments.

¹³⁵³ Citing here [N’Krumah, 1963, p. 49] in footnote 1 (see the quote at the beginning of this appendix), who adds: “Many of these manuals had not been altered since 1895”.

¹³⁵⁴ Citing “J. Berque, *Dépossession du Monde*, p. 101, 116” in footnote 2.

¹³⁵⁵ [Sachs, 1966, p. 482]: in French “Les intellectuels et les dirigeants africains ont souvent insisté sur le fait que les colonisés ont été dépossédés de leur personnalité culturelle et historique. ‘Nous étions élevés, dit N’Krumach, pour être de mauvaises copies d’Anglais, des caricatures ridicules par notre prétention d’atteindre à la distinction des bourgeois britanniques, alors que nos fautes grammaticales et notre méconnaissance des usages nous trahissaient à chaque instant. Nous étions ni chair ni poisson. On nous refusait la connaissance de notre passé africain tout en nous disant que nous n’avions pas de présent. Quel pouvait être notre avenir? On nous enseignait à considérer notre culture et nos traditions comme barbares et primitives. Nos livres d’étude étaient des livres anglais qui nous parlaient de l’histoire anglaise, des coutumes anglaises, des idées anglaises, du temps qu’il fait en Angleterre’. Selon une remarque de J. Berque, la colonisation a fait subir une ‘déculturation’ et une ‘dénaturation’ aux indigènes”.

¹³⁵⁶ As quoted at the beginning of Chapter V.

¹³⁵⁷ Christophe Louis Léon Juchault de Lamoricière, with more information on this French general in [Anon. “Christophe Louis Léon Juchault de Lamoricière”].

¹³⁵⁸ [Dury, 1864, p. 100, 102]: in French “L’annexion [en 1860] de l’Italie centrale au Piémont avait irrité l’Autriche et les autres gouvernements de la Péninsule. Le cabinet de Vienne avait retiré son ambassadeur de Turin, et fait entendre un cliquetis d’armes dans la Vénétie. Pie IX lança, le 30 mars, l’excommunication contre tous les acteurs, promoteurs, coadjuteurs, conseillers ou adhérents de l’usurpation [...] mais [cette bulle] ne porta point coup. [...] On conçut alors le projet d’appeler à Rome pour organiser l’armée pontificale un général célèbre, mais hostile au gouvernement de Napoléon III, le général Lamoricière. [...] Le général Lamoricière, à peine investi du commandement, adressa, le 8 avril, aux troupes pontificales l’ordre du jour suivant, qui excita un vif étonnement, venant d’un général ancien ministre de la république française :— ‘Sa sainteté le pape Pie IX ayant daigné m’appeler à l’honneur de vous commander pour défendre ses droits méconnus et menacés, je n’ai point hésité à reprendre mon épée. [...] [L]e christianisme n’est pas seulement la religion du monde civilisé, il est le principe de la vie même de la civilisation [...]. La révolution, *comme autrefois l’islamisme*, menace aujourd’hui l’Europe, et, aujourd’hui comme autrefois, la cause du pape est celle de la civilisation et de la liberté dans le monde. [...]”, with the conclusion: “Cette comparaison de la Révolution à l’Islamisme, était au moins étrange, pour ne pas dire autre chose”.

¹³⁵⁹ [*ibid.*].

References

Some of the readers of this dossier may be surprised by the number of “Anonymous” references in this section (approx. 15% of the total). The reason for this particularity is that I have tried to provide the reader with easily accessible sources from the internet, whenever other, supposedly complete and better, sources provided less, or even less accurate, information. Indeed encyclopedias such as *The New Grove* and the *Encyclopedia of Islam* are a major help to researchers in, for instance, the field of *maqām* music, although the numerous errors they contain have been reproduced and amplified in the not less numerous “webpedias” (including Wikipedia) available on the internet. However, and in the particular case of Wikipedia, most “unfinished”, incomplete, biased articles contain, in the file (web page) itself, a warning included by peers, reminding the reader to remain cautious about the information provided; this is a feature the reader does not find in the “prestigious” encyclopedias cited above. These are the major reasons why I prefer a well-documented Wikipedia article to a less documented, or less argumentative article (and with reading or download charge) from a specialized encyclopedia (sometimes I quote both entries, which is an invitation for the reader to compare the two versions), especially when the latter contains – frequently with regard to *maqām* music – numerous errors. Cost is also an issue, particularly for researchers who do not have massive access to scientific literature through prestigious universities or research centers. This is a supplementary reason for citing documented, mostly reliable, available literature and, whenever the cited sources are less accessible (and while this dossier is intended for a large spectrum of scholars, and from different countries), for quoting often and widely from these sources, allowing thus all readers to directly verify the adequacy of the cited references.

*
* *

1. ABDEL-MALEK, Anouar: “Orientalism in crisis”, *Diogenes* 11 44 [1963a] [url: <http://dio.sagepub.com/content/11/44/103.short>] p. 103–140.
2. ABDEL-MALEK, Anouar: “L’Orientalisme en crise”, *Diogenes* 44 [1963b] p. 109–142.
3. ABOU MRAD, Nidaa: “Échelles mélodiques et identité culturelle en Orient arabe”, *Musiques et Cultures Vol. III/V*, ed. Jean-Jacques Nattiez, *Musiques: une encyclopédie pour le XXI^e siècle*, Actes Sud / Cité de la musique [Arles (Bouches-du-Rhône); [Paris], 2005] p. 756–795.
4. ABRAHAM, Gerald: “Arab Melodies in Rimsky-Korsakov and Borodin”, *Music & Letters* 56 3/4 [1975-7-1] [url: <http://www.jstor.org/stable/734888>] p. 313–318.
5. ABROMONT, Claude, Eugène de MONTALEMBERT, Philippe FOURQUET, et al.: *Guide de la théorie de la musique*, Paris: Fayard, H. Lemoine. [Paris, 2001].
6. ABU-LUGHOD, Ibrahim A.: *Arab rediscovery of Europe: a study in cultural encounters*, Princeton University Press [Princeton, N.J., 1963].
7. ADAMS, Laura L.: “Modernity, Postcolonialism, and Theatrical Form in Uzbekistan”, *Slavic Review* 64 2 [2005] [doi: 10.2307/3649987. url: <http://www.jstor.org/stable/3649987?origin=crossref>] p. 333.
8. ADAMS, Laura L.: “Globalization, Universalism, and Cultural Form”, *Comparative Studies in Society and History* 50 3 [2008] [url: <http://www.jstor.org/stable/27563692>] p. 614–640.
9. ADAMSON, Peter: “Al-Kindi”, *Stanford Encyclopedia of Philosophy* [2011] [url: <http://plato.stanford.edu/entries/al-kindi/>].
10. ADKINS, Cecil: *The theory and practice of the monochord*, State University of Iowa [1963].
11. ADKINS, Cecil: “The Technique of the Monochord”, *Acta Musicologica* 39 1/2 [1967-1-1] [doi: 10.2307/932465. url: <http://www.jstor.org/stable/932465>] p. 34–43.
12. AL-LĀH-WĪRDĪ, Mikhā’il الله ويدي ميخائيل and Wadīf ŠABRĀ: *Jawla fi ‘Ulūm al-Mūsīqā al-‘Arabiyya, Sīlsilat al-Kutub al-Ḥadītha* 3, Wazārat a-th-Thaqāfa wa-l-Irshād – Mudiriyyat a-th-Thaqāfa al-‘Āma – Maṭba‘at Dār al-Jumhūriyya [Baghdad, 1964].
13. AL-LĀH-WĪRDĪ, Mikhā’il الموسيقى الشرقية ويدي: فلسفة ميخائيل الله ويدي Falsafat al-Mūsīqā a-sh-Sharqiyya fi Asrār al-Fann al-‘Arabiyy [The philosophy of oriental music], 2nd ed., Ibn Zaydūn [Damas?, 1950].
14. ALMÁRCEGUI, Patricia: “Orientalism: twenty years on”, *Quaderns de la Mediterrània* 3–4 [2003] p. 255–259.
15. ALMESSA-TESSGILETTE-ZEMENNE: اعلى نجاح سلام [url: <http://archive.org/details/NajehSellem>].
16. AL-TAEË, Nasser: *Representations of the Orient in Western Music: Violence and Sensuality*, Ashgate Publishing, Ltd. [2010].
17. Ambrazevičius, Rytis: “Pseudo-Greek modes in traditional music as result of misperception”, ed. Mario Baroni, *Society for Music Perception & Cognition; European Society for the Cognitive Sciences of Music*, [s.l.], 2006].
18. AMBROS, August Wilhelm: *Geschichte der Musik* 1/, F.E.C. Leuckart [1862].
19. AMBROS, August Wilhelm, Gustav NOTTEBOHM, B. von SOKOLOWSKY, et al.: *Geschichte der Musik* 2/, Leipzig, F.E.C. Leuckarts [1881-93] [url: <http://archive.org/details/geschichtedermus02ambr>].
20. Amiot, Joseph (1718-1793) Auteur du texte: *Mémoire sur la musique des Chinois, tant anciens que modernes*, par M. Amiot,... avec des notes, des observations et une table des matières, par M. l’abbé Roussier,... faisant partie du tome VI des [1779] [url: <http://gallica.bnf.fr/ark:/12148/bpt6k54211858>].
21. AMIOT, Joseph (1718-1793), François (S. J. BOURGEOIS and Aloys de (S. J. Le P) POIROT: *Mémoires concernant l’histoire, les sciences, les arts, les moeurs, les usages, &c. des Chinois / par les*

- missionnaires de Pe-kin 6/15 (vols.), Nyon l'aîné [Paris, 1779] [url: <http://gallica.bnf.fr/ark:/12148/bpt6k1144574>].
22. ANALOGION – BYZANTINE MUSIC RESOURCES: “Mitr Murr” [2005-2009] [url: <http://analogion.com/MitriMurr.html>].
 23. ANALOGION – BYZANTINE MUSIC RESOURCES, (site): “Mitri Murr”, *Analogion* [2012] [url: <http://analogion.com/MitriMurr.html>].
 24. ANGELOPOULOS, Lykourgos: *Les voix de Byzance*, Desclée de Brouwer [Paris, 2005].
 25. ANGHELESCU, Nadia: “Orientalism seen from the East”, *Romano? Arabica 5* [2005] [url: <http://www.nadia-anghelescu.com/PDF/orientalism.pdf>] p. 21–38.
 26. Anon. “Acoustic resonance”, *Wikipedia, the free encyclopedia* [2016-3-28] [url: https://en.wikipedia.org/w/index.php?title=Acoustic_resonance&oldid=712296368].
 27. Anon. “Alexandre Joseph Hidulphe Vincent”, *Wikipédia* [2015-11-22] [url: https://fr.wikipedia.org/w/index.php?title=Alexandre_Joseph_Hidulphe_Vincent&oldid=120703938].
 28. Anon. “Bernard Lewis”, *Wikipedia, the free encyclopedia* [2016-7-13] [url: https://en.wikipedia.org/w/index.php?title=Bernard_Lewis&oldid=729578766].
 29. Anon. “British_Empire_Anachronous.4.PNG (Image PNG, 1357 × 628 pixels) - Redimensionnée (78%)” [url: https://upload.wikimedia.org/wikipedia/commons/c/cb/British_Empire_Anachronous.4.PNG].
 30. Anon. “Building a medieval lute, building early instruments” [url: http://www.cincinatiearlymusic.com/medieval_lute.html].
 31. Anon. “Building a Renaissance lute, building early instruments” [url: http://www.cincinatiearlymusic.com/renaissance_lute.html].
 32. Anon. “Bulgarian State Television Female Vocal Choir”, *Wikipedia, the free encyclopedia* [2016-3-3] [url: https://en.wikipedia.org/w/index.php?title=Bulgarian_State_Television_Female_Vocal_Choir&oldid=708148881].
 33. Anon. “Burhān, Muḥammad Ḥusayn ibn Khalaf Tabrīzī active 17th century [WorldCat Identities]” [url: <http://www.worldcat.org/identities/lccn-n85-93344/>].
 34. Anon. “Burhān-i qāṭi”, by Muḥammad Ḥusayn ibn Khalaf Tabrīzī Burhān | The Online Books Page” [url: <http://onlinebooks.library.upenn.edu/webbin/book/lookupid?key=ha008394784>].
 35. Anon. “*Candide*”, *Wikipedia, the free encyclopedia* [2016-7-8] [url: <https://en.wikipedia.org/w/index.php?title=Candide&oldid=728955599>].
 36. Anon. “Cent (music)”, *Wikipedia, the free encyclopedia* [2016-2-20] [url: [https://en.wikipedia.org/w/index.php?title=Cent_\(music\)&oldid=705939058](https://en.wikipedia.org/w/index.php?title=Cent_(music)&oldid=705939058)].
 37. Anon. “Charles Bordes”, *Wikipédia* [2016-3-3] [url: https://fr.wikipedia.org/w/index.php?title=Charles_Bordes&oldid=123973243].
 38. Anon. “Chrysalis Foundation – Musical Mathematics: Safi Al-Din and Bartolomeo Ramis” [url: http://chrysalis-foundation.org/Al-Din_and_Ramis.htm].
 39. Anon. “Civilizing mission”, *Wikipedia, the free encyclopedia* [2016-5-8] [url: https://en.wikipedia.org/w/index.php?title=Civilizing_mission&oldid=719279560].
 40. Anon. “Commons:Reuse of PD-Art photographs - Wikimedia Commons” [url: https://commons.wikimedia.org/wiki/Commons:Reuse_of_PD-Art_photographs#United_Kingdom_2F_UK].
 41. Anon. “Dawood Hosni”, *Wikipedia, the free encyclopedia* [2016-4-2] [url: https://en.wikipedia.org/w/index.php?title=Dawood_Hosni&oldid=713182326].
 42. Anon. “Dāwūd Ḥusnī (1870-1937)” [2016-5-13] [url: <http://www.amar-foundation.org/dawud-husni/>].
 43. Anon. “Diletsky_circle.jpg (Image JPEG, 857 × 1143 pixels) - Redimensionnée (44%)” [url: https://upload.wikimedia.org/wikipedia/commons/d/d6/Diletsky_circle.jpg?uselang=fr].
 44. Anon. “Edward Gibbon”, *Wikipedia, the free encyclopedia* [2016-4-11] [url: https://en.wikipedia.org/w/index.php?title=Edward_Gibbon&oldid=714715849].
 45. Anon. “Edward Said”, *Wikipedia, the free encyclopedia* [2016a-4-16] [url: https://en.wikipedia.org/w/index.php?title=Edward_Said&oldid=715485335].
 46. Anon. “Edward Said”, *Wikipedia, the free encyclopedia* [2016b-4-16] [url: https://en.wikipedia.org/w/index.php?title=Edward_Said&oldid=715485335].
 47. Anon. “Equal temperament”, *Wikipedia, the free encyclopedia* [2016-3-22] [url: https://en.wikipedia.org/w/index.php?title=Equal_temperament&oldid=711311818].
 48. Anon. “File:Circle of fifths ascending within octave.png”, *Wikipedia* [url: https://en.wikipedia.org/wiki/File:Circle_of_fifths_ascending_within_octave.png].
 49. Anon. “File:Jean-Léon Gérôme - Le charmeur de serpents.jpg”, *Wikipedia, the free encyclopedia* [url: https://en.wikipedia.org/wiki/File:Jean-L%C3%A9on_G%C3%A9r%C3%B4me_-_Le_charmeur_de_serpents.jpg].
 50. Anon. “File:Pitch class space star.svg”, *Wikipedia* [url: https://en.wikipedia.org/wiki/File:Pitch_class_space_star.svg].
 51. Anon. “File:T and O map Guntherus Ziner 1472.jpg”, *Wikipedia, the free encyclopedia* [url: https://en.wikipedia.org/wiki/File:T_and_O_map_Guntherus_Ziner_1472.jpg].
 52. Anon. “French Mandate for Syria and the Lebanon”, *Wikipedia, the free encyclopedia* [2016-3-30] [url: https://en.wikipedia.org/w/index.php?title=French_Mandate_for_Syria_and_the_Lebanon&oldid=712668995].
 53. Anon. “Greco-Turkish War”, *Wikipedia, the free encyclopedia* [2015-8-28] [url: https://en.wikipedia.org/w/index.php?title=Greco-Turkish_War&oldid=678271166].
 54. Anon. “Greco-Turkish War (1919–22)”, *Wikipedia, the free encyclopedia* [2016-5-20] [url: [https://en.wikipedia.org/w/index.php?title=Greco-Turkish_War_\(1919%E2%80%9322\)&oldid=721261289](https://en.wikipedia.org/w/index.php?title=Greco-Turkish_War_(1919%E2%80%9322)&oldid=721261289)].
 55. Anon. “Greek Music in Movies | Greek songs in films” [url: <http://www.greeksongs-greekmusic.com/greek-music-in-movies/>].
 56. Anon. “Guido d'Arezzo”, *Wikipédia* [2015-11-13] [url: https://fr.wikipedia.org/w/index.php?title=Guido_d%27Arezzo&oldid=120475872].
 57. Anon. “Hafez”, *Wikipedia, the free encyclopedia* [2016-4-2] [url: <https://en.wikipedia.org/w/index.php?title=Hafez&oldid=713117181>].
 58. Anon. “Harmonic series (music)”, *Wikipedia, the free encyclopedia* [2016-4-25] [url: [https://en.wikipedia.org/w/index.php?title=Harmonic_series_\(music\)&oldid=717011075](https://en.wikipedia.org/w/index.php?title=Harmonic_series_(music)&oldid=717011075)].
 59. Anon. “*Heart of Darkness*”, *Wikipedia, the free encyclopedia* [2016-4-27] [url: https://en.wikipedia.org/w/index.php?title=Heart_of_Darkness&oldid=717330852].
 60. Anon. “Herbert Spencer”, *Wikipedia, the free encyclopedia* [2016-4-18] [url: https://en.wikipedia.org/w/index.php?title=Herbert_Spencer&oldid=715785187].

61. Anon. "Histoire de la Grèce", *Wikipédia* [2016-4-27] [url: https://fr.wikipedia.org/w/index.php?title=Histoire_de_la_Gr%C3%A8ce&oldid=125675655].
62. Anon. "Histoire de la Grèce aux Dix-neuvième et Vingtième siècles", *Wikipédia* [2016-5-2] [url: https://fr.wikipedia.org/w/index.php?title=Histoire_de_la_Gr%C3%A8ce_aux_XIXe_et_XXe_s%C3%A8cles&oldid=125820700].
63. Anon. "Historical Atlas of Islam - Brill Reference" [url: <http://referenceworks.brillonline.com/browse/historical-atlas-of-islam>].
64. Anon. "History of logarithms", *Wikipedia, the free encyclopedia* [2016-5-1] [url: https://en.wikipedia.org/w/index.php?title=History_of_logarithms&oldid=718018030].
65. Anon. "History of the Ottoman Empire", *Wikipedia, the free encyclopedia* [2016-5-10] [url: https://en.wikipedia.org/w/index.php?title=History_of_the_Ottoman_Empire&oldid=719569891].
66. Anon. "Ibn Khaldun", *Wikipedia, the free encyclopedia* [2016-4-7] [url: https://en.wikipedia.org/w/index.php?title=Ibn_Khaldun&oldid=714092574].
67. Anon. "Ibn Warraq", *Wikipedia, the free encyclopedia* [2016-2-25] [url: https://en.wikipedia.org/w/index.php?title=Ibn_Warraq&oldid=706783401].
68. Anon. "Jacques Chailley", *Wikipédia* [2016-3-23] [url: https://fr.wikipedia.org/w/index.php?title=Jacques_Chailley&oldid=124643278].
69. Anon. "Jacques Chailley (1910-1999)" [url: https://www.musicologie.org/Biographies/c/chailley_jacques.html].
70. Anon. "Joseph Stalin", *Wikipedia, the free encyclopedia* [2016-6-25] [url: https://en.wikipedia.org/w/index.php?title=Joseph_Stalin&oldid=726922369].
71. Anon. "Jules Ferry", *Wikipedia, the free encyclopedia* [2016-4-29] [url: https://en.wikipedia.org/w/index.php?title=Jules_Ferry&oldid=717711521].
72. Anon. "Karl Geiringer", *Wikipedia, the free encyclopedia* [2016-4-22] [url: https://en.wikipedia.org/w/index.php?title=Karl_Geiringer&oldid=716620293].
73. Anon. "Laboratoire d'excellence - Religions et Sociétés dans le Monde méditerranéen - L'évolution des gammes/modes majeur et mineur: vers une approche Musicomédiane" [url: <http://www.labex-resmed.fr/1-evolution-des-gammes-modes>].
74. Anon. *Le Mystère Des Voix Bulgares*, Audio CD 008 (track 1), Disques Cellier [Suisse, 1986].
75. Anon. "Le Mystère des voix bulgares", *Wikipédia* [2015-11-5] [url: https://fr.wikipedia.org/w/index.php?title=Le_Myst%C3%A8re_des_voix_bulgares&oldid=120201105].
76. Anon. *Le Mystère Des Voix Bulgares, Vol. 2*, Audio CD 016 (track 2), Disques Cellier [Suisse, 1989].
77. Anon. "Leon Trotsky", *Wikipedia, the free encyclopedia* [2016-6-23] [url: https://en.wikipedia.org/w/index.php?title=Leon_Trotsky&oldid=726564343].
78. Anon. "Louis-Albert Bourgault-Ducoudray", *Wikipedia, the free encyclopedia* [2016-5-24] [url: https://en.wikipedia.org/w/index.php?title=Louis-Albert_Bourgault-Ducoudray&oldid=721776068].
79. Anon. "Marxism", *Wikipedia, the free encyclopedia* [2016-6-22] [url: <https://en.wikipedia.org/w/index.php?title=Marxism&oldid=726523799>].
80. Anon. "Music of Turkey", *Wikipedia, the free encyclopedia* [2016-6-3] [url: https://en.wikipedia.org/w/index.php?title=Music_of_Turkey&oldid=723589624].
81. Anon. "Nikolay Kaufman", *Wikipedia, the free encyclopedia* [2016-4-18] [url: https://en.wikipedia.org/w/index.php?title=Nikolay_Kaufman&oldid=715828164].
82. Anon. "Non-Aligned Movement", *Wikipedia, the free encyclopedia* [2016-6-16] [url: https://en.wikipedia.org/w/index.php?title=Non-Aligned_Movement&oldid=725564097].
83. Anon. "Oliver Strunk", *Wikipedia, the free encyclopedia* [2016-4-5] [url: https://en.wikipedia.org/w/index.php?title=Oliver_Strunk&oldid=713640517].
84. Anon. "Preface to Frantz Fanon's Wretched of the Earth by Jean-Paul Sartre" [url: <https://www.marxists.org/reference/archive/sartre/1961/preface.htm>].
85. Anon. "Pythagorean comma", *Wikipedia, the free encyclopedia* [2015-7-6] [url: https://en.wikipedia.org/w/index.php?title=Pythagorean_comma&oldid=670159329].
86. Anon. "Race humaine", *Wikipédia* [2016-1-13] [url: https://fr.wikipedia.org/w/index.php?title=Race_humaine&oldid=122284217].
87. Anon. "Racial antisemitism", *Wikipedia, the free encyclopedia* [2016-5-30] [url: https://en.wikipedia.org/w/index.php?title=Racial_antisemitism&oldid=722840153].
88. Anon. "Rashid Khalidi - Faculty - Department of History - Columbia University" [url: <http://history.columbia.edu/faculty/Khalidi.html>].
89. Anon. "Salammbô", *Wikipedia, the free encyclopedia* [2016-3-5] [url: <https://en.wikipedia.org/w/index.php?title=Salammb%C3%B4&oldid=708336713>].
90. Anon. "San Remo conference", *Wikipedia, the free encyclopedia* [2016-5-3] [url: https://en.wikipedia.org/w/index.php?title=San_Remo_conference&oldid=718374149].
91. Anon. "Savart", *Wikipedia, the free encyclopedia* [2016-4-11] [url: <https://en.wikipedia.org/w/index.php?title=Savart&oldid=714652545>].
92. Anon. "Schola Cantorum de Paris", *Wikipédia* [2016a-7-8] [url: https://fr.wikipedia.org/w/index.php?title=Schola_Cantorum_de_Paris&oldid=127679860].
93. Anon. "Schola Cantorum de Paris", *Wikipedia, the free encyclopedia* [2016b-7-9] [url: https://en.wikipedia.org/w/index.php?title=Schola_Cantorum_de_Paris&oldid=729106236].
94. Anon. "Semitic people", *Wikipedia, the free encyclopedia* [2016-6-8] [url: https://en.wikipedia.org/w/index.php?title=Semitic_people&oldid=724256170].
95. Anon. "Simon Stevin", *Wikipedia, the free encyclopedia* [2016-5-3] [url: https://en.wikipedia.org/w/index.php?title=Simon_Stevin&oldid=718407341].
96. Anon. "So What (Miles Davis composition)", *Wikipedia, the free encyclopedia* [2016-6-25] [url: [https://en.wikipedia.org/w/index.php?title=So_What_\(Miles_Davis_composition\)&oldid=726988297](https://en.wikipedia.org/w/index.php?title=So_What_(Miles_Davis_composition)&oldid=726988297)].
97. Anon. "Socialism in One Country", *Wikipedia, the free encyclopedia* [2016-6-3] [url: https://en.wikipedia.org/w/index.php?title=Socialism_in_One_Country&oldid=723443228].
98. Anon. "Sykes-Picot Agreement", *Wikipedia, the free encyclopedia* [2016-5-16] [url: https://en.wikipedia.org/w/index.php?title=Sykes%E2%80%93Picot_Agreement&oldid=720523040].
99. Anon. "T and O map", *Wikipedia, the free encyclopedia* [2016-4-2] [url: https://en.wikipedia.org/w/index.php?title=T_and_O_map&oldid=713112494].

100. Anon. "The Lute | Thematic Essay | Heilbrunn Timeline of Art History | The Metropolitan Museum of Art" [url: http://www.metmuseum.org/toah/hd/lute/hd_lute.htm].
101. Anon. "The Lute Society: Building Lute Original Methods" [url: <http://www.lutesociety.org/pages/building-lute-original-methods>].
102. Anon. "Tout va très bien madame la marquise (chanson)", *Wikipédia* [2016-2-24] [url: [https://fr.wikipedia.org/w/index.php?title=Tout_va_tr%C3%AAs_bien_madame_la_marquise_\(chanson\)&oldid=123669525](https://fr.wikipedia.org/w/index.php?title=Tout_va_tr%C3%AAs_bien_madame_la_marquise_(chanson)&oldid=123669525)].
103. Anon. "Traité de Constantinople (1832)", *Wikipédia* [2015-5-13] [url: [https://fr.wikipedia.org/w/index.php?title=Trait%C3%A9_de_Constantinople_\(1832\)&oldid=114982149](https://fr.wikipedia.org/w/index.php?title=Trait%C3%A9_de_Constantinople_(1832)&oldid=114982149)].
104. Anon. "Turkish tambur", *Wikipedia, the free encyclopedia* [2016-5-8] [url: https://en.wikipedia.org/w/index.php?title=Turkish_tambur&oldid=719181025].
105. Anon. "Vladimir Lenin", *Wikipedia, the free encyclopedia* [2016-6-26] [url: https://en.wikipedia.org/w/index.php?title=Vladimir_Lenin&oldid=727021107].
106. Anon. "Voice frequency", *Wikipedia, the free encyclopedia* [2015-3-30] [url: https://en.wikipedia.org/w/index.php?title=Voice_frequency&oldid=654244861].
107. Anon. "Zorba the Greek (film)", *Wikipedia* [2016-8-27] [url: [https://en.wikipedia.org/w/index.php?title=Zorba_the_Greek_\(film\)&oldid=736481076](https://en.wikipedia.org/w/index.php?title=Zorba_the_Greek_(film)&oldid=736481076)].
108. Anon. 27-9-2010 | *أحوال يا غلام - سهام رقى (النسخة الاصلية القديمه)* [url: https://www.youtube.com/watch?v=PeWm_tI8xLw&feature=youtu.be].
109. Anon. 12-2-2012 | *أحوال يا غلام لنجاح سلام ضمن أهم 100 أغنية عربية* [url: <https://www.youtube.com/watch?v=U9GfPBC0tvM&feature=youtu.be>].
110. Anon. رفع الأذان في دمشق... بمصاحبة البياتو :: قون وعولم", *جريدة السفير* [url: <http://assafir.com/article/137913>].
111. Anon. "9-2-2015 | إنجاح سلام", *ويكيبيديا، الموسوعة الحرة* [url: http://ar.wikipedia.org/w/index.php?title=%D9%86%D8%AC%D8%A7%D8%AD_%D8%B3%D9%84%D8%A7%D9%85&oldid=149264377].
112. Anon. إنجاح سلام تروي ل المستقبل سيرتها منذ الطفولة حتى اليوم: تأ صالحة الفضل في " نشر الأغنية اللبنانية في مصر", *Almustaqbal Newspaper* [url: <http://www.almustaqbal.com/v4/article.aspx?type=NP&articleid=225408>].
113. Anon. "إنجاح سلام... غنت للحب وغنت للوطن", [url: <https://ar.facebook.com/notes/10150285217626952/>].
114. ANONYME: *A-sh-Shajara Dhāt al-Akmām al-Hāwīya li-Uṣṭil al-Anghām* [The tree with calyxes which contains the origins of the melodies], editors Ghattās ‘Abd-al-Malik Khashaba (عطلس عبد الملك) and Isis Fath-al-Lāh (د. إيزيس فتح الله), Al-Hay’a al-Miṣriyya al-‘amma li-l-Kitāb (الهيئة المصرية العامة للكتاب) [Le Caire, 1983-xiv^e siècle].
115. ARISTOXENOS, (Aristoxène de Tarente) and Henry Stewart MACRAN: *Aristoxenoy Armonika stoicheia: The harmonics of Aristoxenus*, Oxford The Clarendon Press [Chicago - EU, 1902].
116. ARISTOXENOS, (Aristoxène de Tarente) and Charles-Émile RUELLE: *Éléments harmoniques d’Aristoxène: tr. en français pour la première fois d’après un texte revu sur les sept manuscrits de la Bibliothèque Nationale et sur celui de Strasbourg*, Pottier de Lalaine [1870].
117. ARNAKIS, G. Georgiades: "The Greek church of Constantinople and the Ottoman empire", *The Journal of Modern History* [1952] [url: <http://www.jstor.org/stable/1875481>] p. 235–250.
118. ASLAN, Reza: *No god but God (Updated Edition): The Origins, Evolution, and Future of Islam*, Random House Publishing Group [2011-8-30].
119. ASLAN, Reza: *Le Miséricordieux: La véritable histoire de Mahomet et de l’Islam*, Les Arènes [2015-3-4].
120. ATKINSON, Charles M.: *The Critical Nexus: Tone-System, Mode, and Notation in Early Medieval Music*, Oxford University Press [2008-12-19].
121. AUGER, Léon: "Les apports de J. Sauveur (1653-1716) à la création de l’Acoustique.", *Revue d’histoire des sciences et de leurs applications* 1 4 [1948] [doi: 10.3406/rhs.1948.2670. url: http://www.persee.fr/web/revues/home/prescript/article/rhs_0048-7996_1948_num_1_4_2670] p. 323–336.
122. AUGUSTINOS, Olga: *French Odysseys: Greece in French travel literature from the Renaissance to the Romantic era*, Johns Hopkins Univ Pr [1994].
123. BAGHDĀDĪ (AL-), ‘Abd-al-Latif and Antoine-Isaac Silvestre SACY (DE): *Relation de l’Égypte par ‘Abd-al-Latif*, Impr. Impériale [1810] [url: http://archive.org/details/bub_gb_tNivq4w3_EAC].
124. BAILHACHE, Patrice: *Une histoire de l’acoustique musicale*, CNRS éditions [2001].
125. BAILHACHE, Patrice: "Reconstitution des calculs de Helmholtz" [2016] [url: http://patrice.bailhache.free.fr/thmusique/helmholtz_reconstitution.html].
126. BAKIC-HAYDEN, Milica and Robert M. HAYDEN: "Orientalist Variations on the Theme ‘Balkans’: Symbolic Geography in Recent Yugoslav Cultural Politics", *Slavic Review* 51 1 [1992] [doi: 10.2307/2500258. url: <http://www.jstor.org/stable/2500258?origin=crossref>] p. 1.
127. BALKIŞ, Lale Babaoğlu: "Defining the Turk: Construction of Meaning in Operatic Orientalism", *International Review of the Aesthetics and Sociology of Music* 41 2 [2010] [url: <http://www.jstor.org/stable/41203366>] p. 185–193.
128. BANŪ MŪSĀ: "Ms. BO 223A f^{os} 66-121 *Al-Āla al-lati Tuzamminu bi-Nafsihā – Şir‘at Banī Mūsā [ijbn Shākīr* [L’instrument qui siffle tout seul (‘Traité sur la manière de confectionner un orgue automatique) – Fabriqué par les fils de Mūsā ibn Shākīr] [Bibliothèque Orientale – Beyrouth (بيروت – لبنان), s.d. (IX^e siècle)].
129. BARBERA, André: "Placing Sectio Canonis in Historical and Philosophical Contexts", *The Journal of Hellenic Studies* 104 [1984-1-1] [doi: 10.2307/630287. url: <http://www.jstor.org/stable/630287>] p. 157–161.
130. BARBERA, C. André: "Arithmetic and Geometric Divisions of the Tetrachord", *Journal of Music Theory* 21 2 [1977-10-1] [doi: 10.2307/843492. url: <http://www.jstor.org/stable/843492>] p. 294–323.
131. BARBEREAU, Auguste-Mathurin-Balthasar: *Études sur l’origine du système musical, premier mémoire, par A. Barbereau...* [1852] [url: <http://gallica.bnf.fr/ark:/12148/bpt6k62095822>].
132. BARBEREAU, Auguste-Mathurin-Balthasar: *Études sur l’origine du système musical: premier mémoire (Édition augmentée d’un errata complet et d’une table des matières) / par A. Barbereau...* [1864] [url: <http://gallica.bnf.fr/ark:/12148/bpt6k8415496>].
133. BARKECHLI, Mehdi: *L’art sassanide, base de la musique arabe*, Université de Téhéran, Presses Universitaires [Téhéran, 1947].
134. BARKECHLI, Mehdi: "La Musique Iranienne", editor Roland-Manuel, *Histoire de la musique Tome I - Des Origines à Jean-Sébastien Bach, Encyclopédie de la Pléiade* 1/2 (vols.), Gallimard [Paris, 2001] p. 453–525.
135. BARKER, Andrew: "Methods and Aims in the Euclidean Sectio Canonis", *The Journal of Hellenic Studies* 101 [1981-1-1]

- [doi: 10.2307/629840. url: <http://www.jstor.org/stable/629840>] p. 1–16.
136. BARKER, Andrew: “Aristides Quintilianus and Constructions in Early Music Theory”, *The Classical Quarterly* 32 1 [1982] p. 184–197.
137. BARKER, Andrew: “An Oxyrhynchus Fragment on Harmonic Theory”, *The Classical Quarterly, New Series* 44 1 [1994-1-1] [url: <http://www.jstor.org/stable/638875>] p. 75–84.
138. BARKER, Andrew: *The science of harmonics in classical Greece*, Cambridge University Press [2007].
139. BARTHÉLÉMY, Pierre: “L’archéologie démolit les clichés sur le Moyen Age”, *Journal, Le Monde/Sciences* [2016-10-10] [url: http://www.lemonde.fr/sciences/article/2016/10/10/l-archeologie-demolit-les-cliches-sur-le-moyen-age_5011238_1650684.html].
140. BARTOLI, Jean-Pierre: “La musique française et l’Orient : à propos du *Désert* de Félicien David”, *L’exotisme musical français*, Slatkine [Genève, 1981] p. 29–36.
141. BAUD-BOVY, Samuel: “L’accord de la lyre antique et la musique populaire de la Grèce moderne”, *Revue de Musicologie* 53 1 [1967-1-1] [doi: 10.2307/926960. url: <http://www.jstor.org/stable/926960>] p. 3–20.
142. BAUD-BOVY, Samuel: “L’évolution d’une chanson grecque”, *Journal of the International Folk Music Council* 20 [1968a-1-1] [doi: 10.2307/836070. url: <http://www.jstor.org/stable/836070>] p. 39–47.
143. BAUD-BOVY, Samuel: “Équivalences métriques dans la musique vocale grecque antique et moderne”, *Revue de Musicologie* 54 1 [1968b-1-1] [doi: 10.2307/927406. url: <http://www.jstor.org/stable/927406>] p. 3–15.
144. BAUD-BOVY, Samuel: “Le dorien était-il un mode pentatonique?”, *Revue de Musicologie* 64 2 [1978-1-1] [doi: 10.2307/928234. url: <http://www.jstor.org/stable/928234>] p. 153–180.
145. BAUD-BOVY, Samuel: “Bourgault-Ducoudray et la musique grecque ecclésiastique et profane”, *Revue de Musicologie* 68 1/2 [1982-1-1] [doi: 10.2307/928286. url: <http://www.jstor.org/stable/928286>] p. 153–163.
146. BAUD-BOVY, Samuel: “Chansons populaires de la Grèce antique”, *Revue de Musicologie* 69 1 [1983-1-1] [doi: 10.2307/928714. url: <http://www.jstor.org/stable/928714>] p. 5–20.
147. BAUD-BOVY, Samuel: “Chansons populaires de la Grèce antique’ Corrigenda”, *Revue de Musicologie* 70 2 [1984-1-1] [doi: 10.2307/928430. url: <http://www.jstor.org/stable/928430>] p. 259–260.
148. BAUD-BOVY, Samuel: “Le ‘genre enharmonique’ a-t-il existé?”, *Revue de Musicologie* 72 1 [1986-1-1] [doi: 10.2307/928769. url: <http://www.jstor.org/stable/928769>] p. 5–21.
149. BAUD-BOVY, Samuel: “Grèce antique et Grèce moderne”, *Cahiers de musiques traditionnelles* 1 [1988-1-1] [doi: 10.2307/40240011. url: <http://www.jstor.org/stable/40240011>] p. 77–86.
150. BEATON, Roderick: “Koraios, Toynbee and the modern Greek heritage”, *Byzantine and Modern Greek Studies* 15 1 [1991-1-1] [doi: 10.1179/byz.1991.15.1.1. url: <http://www.tandfonline.com/doi/abs/10.1179/byz.1991.15.1.1>] p. 1–19.
151. BEATON, Roderick: “Antique nation? ‘Hellenes’ on the eve of Greek independence and in twelfth-century Byzantium”, *Byzantine and Modern Greek Studies* 31 1 [2007-3-1] [doi: 10.1179/030701307X162541. url: <http://www.tandfonline.com/doi/abs/10.1179/030701307X162541>] p. 76–95.
152. BEATON, Roderick and David RICKS: *The Making of Modern Greece: Nationalism, Romanticism, and the Uses of the Past* (1797-1896), Publications of the Centre for Hellenic Studies, King’s College London 11, King’s College [London, 2009].
153. BELAIEV, V.: “Folk Music and the History of Music”, *Studia Musicologica Academiae Scientiarum Hungaricae* 7 1/4 [1965] [doi: 10.2307/901408. url: <http://www.jstor.org/stable/901408?origin=crossref>] p. 19.
154. BELTRANDO-PATIER, Marie-Claire: *Histoire de la musique, In Extenso*, Larousse [Paris, 1998].
155. BENT, Ian D., David W. HUGHES, Robert C. PROVINE, et al.: “Notation”, editor Stanley Sadie, *New Grove: Dictionary of Music & Musicians* 18/ [Oxford, 2001] p. 73–189.
156. BERGSAGEL, John: “Meibom, Marcus”, *Grove Music Online* [2001].
157. BERLIOZ, Hector: *À travers chants : études musicales, adorations boutades et critiques*, Paris: M. Lévy [1862] [url: <http://archive.org/details/traverschantst00berl>].
158. BERNER, Alfred: *Studien zur arabischen Musik auf Grund der gegenwärtigen Theorie und Praxis in Ägypten*. - Leipzig: Kistner & Siegel 1937. VI, 124 S. 4^o(8^o) Zugleich Berlin, phil. Diss. (Schriftenreihe d. Staatl. Inst. f. Deutsche Musikforschung. 2.), Fr. Kistner & C. F.W. Siegel [Leipzig, 1937].
159. BEYHOM, Amine: *Systématique modale – Volume I-II-III*, Thèse de doctorat, Université Paris Sorbonne [Paris, 2003a-9-1] [url: <http://foredofico.org/CERMAA/publications/publications-on-the-site/publications-amine-beyhom>].
160. BEYHOM, Amine: *3. Systématique modale – Volume III*, Thèse de doctorat, Université Paris Sorbonne [2003b-9-3] [url: <http://foredofico.org/CERMAA/publications/publications-on-the-site/publications-amine-beyhom>].
161. BEYHOM, Amine: “Systématique modale: génération et classement d’échelles modales”, *Musurgia* XI 4 [2004-12] [url: <http://foredofico.org/CERMAA/publications/publications-on-the-site/publications-amine-beyhom>] p. 55–68.
162. BEYHOM, Amine: “L’Interaction entre la musique et l’image: l’exemple de la trilogie du Seigneur des Anneaux”, *Regards* 7 [2005a-1] [url: <http://foredofico.org/CERMAA/publications/publications-on-the-site/publications-amine-beyhom>] p. 5–18.
163. BEYHOM, Amine: “Approche systématique de la musique arabe: genres et degrés système”, *De la théorie à l’Art de l’improvisation: analyse de performances et modélisation musicale*, ed. Mondher Ayari, Delatour [Paris, 2005b-12] [url: <http://foredofico.org/CERMAA/publications/publications-on-the-site/publications-amine-beyhom>] p. 65–114.
164. BEYHOM, Amine: “Intervalle de mesure ou intervalle conceptuel? Les errements des notations et théories des musiques arabes” [Université Paris Sorbonne, 2006a-4-1].
165. BEYHOM, Amine: “Une étude comparée sur les intervalles des musiques orientales”, publ. internet [Royaumont – France, 2006b-10-7] [url: http://www.royaumont.com/fondation_abbaye/fileadmin/user_upload/dossier_PDF/programmes_music_aux/COLLOQUE_MAQAM_ET_CREATION_OCTOBRE_2005.pdf].
166. BEYHOM, Amine: “Les tribulations du *hijāz* autour de la *Mare Nostrum*” [Université Paris Sorbonne, 2007a-3-24].
167. BEYHOM, Amine: “Point de vue: Musiques savantes de l’Orient ou le temps de la reconnaissance”, *Revue des Traditions Musicales des Mondes Arabe et Méditerranéen* 1 1 [2007b-6] [url: <http://foredofico.org/CERMAA/publications/publications-on-the-site/publications-amine-beyhom>] p. 13–26.
168. BEYHOM, Amine: “Des Critères d’authenticité dans les musiques métissées et de leur validation: exemple de la musique arabe”, *Filigrane. Musique, esthétique, sciences, société* 5 [2007c-6] [url: <http://foredofico.org/CERMAA/publications/publications->

- on-the-site/publications-amine-beyhom, URL: <http://revues.mshparisnord.org/filigrane/index.php?id=168> p. 63–91.
169. BEYHOM, Amine: “Dossier: Mesures d’intervalles – méthodologie et pratique”, *Revue des Traditions Musicales des Mondes Arabe et Méditerranéen 1 1* |2007d-6| [url: <http://foredofico.org/CERMAA/publications/publications-on-the-site/publications-amine-beyhom>] p. 181–235.
170. BEYHOM, Amine: “Arabité et modernité en musique, ou de quel modèle se démarquer”, *Congrès des musiques dans le monde de l’islam du 8 au 13 août 2007* |Assilah – Morocco, 2007e-8-8| [url: <http://www.mcm.asso.fr/site02/music-w-islam/articles/Beyhom-2007.pdf>, <http://www.mcm.asso.fr/site02/music-w-islam/congresfr.htm>, <http://www.mcm.asso.fr/site02/music-w-islam/intervenantsfr.htm>].
171. BEYHOM, Amine: “Étude musicologique de ‘Frañsezañ’”, *Grands interprètes de Bretagne 4 – Marie-Josèphe BERTRAND, CD, DASTUM* |2008a| [url: <http://foredofico.org/CERMAA/publications/publications-on-the-site/publications-amine-beyhom>] p. 44–53.
172. BEYHOM, Amine: “‘Ūd et *tunbūr*: origines, aspects organologiques, touche(s)” |Université Paris Sorbonne, 2008b-3-25].
173. BEYHOM, Amine: “A new hypothesis on the elaboration of heptatonic scales and their origins”, *ICONEA 2008, Lulu* on behalf of ICONEA PUBLICATIONS, LONDON-UK |London, 2010a| [url: <http://foredofico.org/CERMAA/publications/publications-on-the-site/publications-amine-beyhom>] p. 151–209.
174. BEYHOM, Amine: *Une approche systématique et diachronique de la modalité maqamiyye*, Mémoire d’habilitation à diriger les recherches (HDR), Université Paris Sorbonne |Institut Finlandais à Paris (France), 2010b-3-9].
175. BEYHOM, Amine: *Théories de l’échelle et pratiques mélodiques chez les Arabes – Volume 1: L’échelle générale et les genres – Tome 1: Théories gréco-arabes de Kindi (IX^e siècle) à Ṭūsī (XIII^e siècle) 1/4 (vols.)*, Librairie orientaliste Paul Geuthner |Paris, 2010c-11].
176. BEYHOM, Amine: “Two persistent misapprehensions about the ‘ūd”, *The Oud from its Sumerian Origins to Modern Times ICONEA 2011 – 1-3 December 2011*, ed. Richard Dumbrell and Irving Finkel, ICONEA Publications |University of London – Senate House, 2011-12-3| [url: <http://foredofico.org/CERMAA/wp-content/uploads/2017/01/Amine-Beyhom-Two-common-errors-about-the-ŪD-from-iconea2011web.pdf>] p. 81–110.
177. BEYHOM, Amine: “*Kashf al-Asrār ‘an Karkarat al-Ahbār fi Ta’wīl al-Adwār*”, *Near Eastern Musicology Online 1 1* |2012-11| [url: <http://nemo-online.org/articles>] p. 67–88.
178. BEYHOM, Amine: “Un lexique de la modalité”, *Near Eastern Musicology Online 2 2* |2013-11| [url: <http://nemo-online.org/articles>] p. 5–24.
179. BEYHOM, Amine: “Dossier: Influence des théories européanisées du XIX^e siècle sur la notation et la pratique des modes de la musique arabe et d’autres musiques, à travers la mise en exergue du mythe du genre *ḥijāz* semi-tonal”, *Near Eastern Musicology Online 2 3* |2014a-11| [url: <http://nemo-online.org/articles>] p. 87–177.
180. BEYHOM, Amine: “A conscious forgery or an unconscious desire? The myth of ditonism in medieval Byzantine chant”, *Arithmetical Subjectivism or Unconscious Knowledge? Sonic Systems of the Ancient Near East and beyond. ICONEA 2014 – 10-11-12 December 2011*, ICONEA |University of London – Senate House, 2014b-12-11| [url: <http://www.iconea.org/?cat=29>].
181. BEYHOM, Amine: “Paroles (et gestes mélodiques) dans les musiques d’Orient: une mise en perspective”, *Al-Kalima min al-Ma’nā ilā-l-Maghna [La parole: de la signification au chant du répertoire]*, ed. Lassaād Zouari, Ministère de l’éducation supérieure et de la recherche scientifique / L’Institut supérieur de musique de Sfax |Sfax - Tunisie, 2015a-4-30| p. 17–23.
182. BEYHOM, Amine: *Théories et pratiques de l’échelle dans le chant byzantin arabe: Une approche comparative et analytique proposant une solution inédite pour le système théorique de Chrysanthos le Madyte*, Par l’auteur |Broummana (Liban), 2015b-9].
183. BEYHOM, Amine: *Théories de l’échelle et pratiques mélodiques chez les Arabes – Volume 1: L’échelle générale et les genres – Tome 1: Théories gréco-arabes de Kindi (IX^e siècle) à Ṭūsī (XIII^e siècle) 1/4 (vols.)*, Librairie orientaliste Paul Geuthner & l’Auteur |Beyrouth, 2015c-11-25| [url: http://foredofico.org/CERMAA/?attachment_id=482].
184. BEYHOM, Amine: “On priests and modes. Or how the author finally got to understand Byzantine chant theory and praxis”, *OIB, Orient Institut Beirut* |Beirut - Lebanon, 2016a-2-16| [url: [http://www.orient-institut.org/index.php?id=164&tx_news_pi1\[action\]=eventDetail&tx_news_pi1\[news\]=268&tx_news_pi1\[controller\]=News&cHash=ff0e21c281d8deba4b558a6ec5008bd2](http://www.orient-institut.org/index.php?id=164&tx_news_pi1[action]=eventDetail&tx_news_pi1[news]=268&tx_news_pi1[controller]=News&cHash=ff0e21c281d8deba4b558a6ec5008bd2)].
185. BEYHOM, Amine: “L’Hellénisme comme outil analytique de domination occidentale”, *CREM-CNRS*, CNRS (Centre National de Recherche Scientifique) |Paris - France, 2016b-3-7| [url: <http://crem-cnrs.fr/1-hellenisme-comme-outil-analytique-de-domination-occidentale-en-musicologie>].
186. BEYHOM, Amine: *Musical scales and Melodic praxis of the Arabs, a systematic and diachronic approach – Volume 1: The general scale and the genera – Tome 2: From Urmawī’s Synthesis (13th century) to contemporary theories of the scale*, ed. to be published 2/4 (vols.), the Author |Beirut - Lebanon, 2018-sortie prévue en -2019].
187. BEYHOM, Amine and Hamdi MAKHLOUF: “Fretage du ‘ūd (luth arabe) dans la théorie musicale arabe et influence sur la pratique [The fretting of the ‘ūd in Arabian music theory and its interaction with practice]”, *5^{ème} Congrès de Musicologie Interdisciplinaire (CIM09), La musique et ses instruments, Fifth Conference on Interdisciplinary Musicology* |Paris, 2009-10-26| [url: <http://cim09.lam.jussieu.fr/CIM09-en/Proceedings.html>, http://cim09.lam.jussieu.fr/CIM09-en/Proceedings_files/Beyhom-Makhlouf.pdf].
188. BITTERMANN, Helen Robbins: “Hārūn Ar-Rashid’s Gift of an Organ to Charlemagne”, *Speculum 4 2* |1929a-4-1| [doi: 10.2307/2847955. url: <http://www.jstor.org/stable/2847955>] p. 215–217.
189. BITTERMANN, Helen Robbins: “The Organ in the Early Middle Ages”, *Speculum 4 4* |1929b-10-1| [doi: 10.2307/2847071. url: <http://www.jstor.org/stable/2847071>] p. 390–410.
190. BLACHÈRE, Régis: “Regards Sur L’«Acculturation» Des Arabo-Musulmans Jusque Vers 40/661”, *Arabica 3 3* |1956-1-1| [doi: 10.1163/157005856X00300. url: <http://booksandjournals.brillonline.com/content/journals/10.1163/157005856X00300>] p. 247–265.
191. BOERSMA, Paul and David WEENINK: “Praat: doing Phonetics by Computer”, *Praat: doing Phonetics by Computer* |2012-9| [url: <http://www.fon.hum.uva.nl/praat/>].

192. BOETHIUS: *Traité de la musique*, editor Christian Meyer, Brepols [Turnhout, 2004].
193. BOHLMAN, Philip V.: "R. G. Kiesewetter's 'Die Musik der Araber': A Pioneering Ethnomusicological Study of Arabic Writings on Music", *Asian Music* 18 1 [1986-10-1] [doi: 10.2307/834163. url: <http://www.jstor.org/stable/834163>] p. 164-196.
194. BOHLMAN, Philip V.: "The European Discovery of Music in the Islamic World and the 'Non-Western' in 19th-Century Music History", *The Journal of Musicology* 5 2 [1987-4-1] [url: <http://www.jstor.org/stable/763849>] p. 147-163.
195. BOHLMAN, Philip V.: "Traditional Music and Cultural Identity: Persistent Paradigm in the History of Ethnomusicology", *Yearbook for Traditional Music* 20 [1988] [doi: 10.2307/768164. url: <http://www.jstor.org/stable/768164>] p. 26-42.
196. BOHLMAN, Philip V.: "Middle East", *Grove Music Online* [2001].
197. BORDES, Charles and G. BOISJOLIN (DE), eds.: *La Tribune de Saint-Gervais; revue musicologique de la Schola Cantorum* 21/, Schola Cantorum [Paris, 1920-1] [url: <http://archive.org/details/latribunedesaint190612pari>].
198. BORREL, Eugène: "Les gammes byzantines et la commission de Constantinople en 1881", *Revue de musicologie* 32 93/94 [1950] p. 1-7.
199. BORTHWICK, E. K.: "Plato and Aristotle on Musical Theory", *The Classical Review, New Series* 13 2 [1963-6-1] [url: <http://www.jstor.org/stable/706698>] p. 160-161.
200. BOSE, Fritz: "Western Influences in Modern Asian Music", *Journal of the International Folk Music Council* 11 [1959] [doi: 10.2307/834857. url: <http://www.jstor.org/stable/834857?origin=crossref>] p. 47.
201. BOSWORTH, C. E.: "A Pioneer Arabic Encyclopedia of the Sciences: Al Khwarizmi's Keys of the Sciences", *Isis* 54 1 [1963-3-1] [url: <http://www.jstor.org/stable/228730>] p. 97-111.
202. BOURGAULT-DUCOUDRAY, Louis-Albert: *Études sur la musique ecclésiastique grecque: mission musicale en Grèce et en Orient - janvier-mai 1875*, Hachette et Cie [Paris, 1877].
203. BOURGAULT-DUCOUDRAY, Louis-Albert: *Souvenirs d'une mission musicale en Grèce et en Orient*, Hachette [Paris, 1878].
204. BOURGAULT-DUCOUDRAY, Louis-Albert and François COPPÉE: *Trente mélodies populaires de Basse-Bretagne*, Henry Lemoine [Paris - Bruxelles, 1885].
205. BOURGAULT-DUCOUDRAY, Louis-Albert and Achille de LAUZIERES: *Trente mélodies populaires de Grèce & d'Orient recueillies et harmonisées par L. A. Bourgault-Ducoudray, H. Lemoine* [1876].
206. BOUTERSE, Curtis: "Reconstructing the Medieval Arabic Lute: A Reconsideration of Farmer's 'Structure of the Arabic and Persian Lute'", *The Galpin Society Journal* 32 [1979-5-1] [doi: 10.2307/841532. url: <http://www.jstor.org/stable/841532>] p. 2-9.
207. BOWLES, Edmund A.: "The Impact of Turkish Military Bands on European Court Festivals in the 17th and 18th Centuries", *Early Music* 34 4 [2006-11-1] [url: <http://www.jstor.org/stable/4137306>] p. 533-559.
208. BOYARIN, Daniel: "The Christian invention of Judaism: The Theodosian empire and the rabbinic refusal of religion", *Representations* 85 1 [2004] [url: <http://rep.ucpress.edu/content/85/1/21.abstract>] p. 21-57.
209. BOZKURT, Barış, Ruhi AYANGIL and André HOLZAPFEL: "Computational Analysis of Turkish Makam Music: Review of State-of-the-Art and Challenges", *Journal of New Music Research* 43 1 [2014-1-2] [doi: 10.1080/09298215.2013.865760. url: <http://dx.doi.org/10.1080/09298215.2013.865760>] p. 3-23.
210. BOZKURT, Barış, Ozan YARMAN, M. Kemal KARAOSMANOĞLU and Can AKKOÇ: "Weighing Diverse Theoretical Models on Turkish Maqam Music Against Pitch Measurements: A Comparison of Peaks Automatically Derived from Frequency Histograms with Proposed Scale Tones", *Journal of New Music Research* 38 1 [2009-3-1] [doi: 10.1080/09298210903147673. url: <http://dx.doi.org/10.1080/09298210903147673>] p. 45-70.
211. BRENNAN, Timothy: "The Illusion of a Future: 'Orientalism' as Traveling Theory", *Critical Inquiry* 26 3 [2000] [url: <http://www.jstor.org/stable/1344294>] p. 558-583.
212. BRISSON, Thomas: "La critique arabe de l'orientalisme en France et aux États-unis", *Revue d'anthropologie des connaissances* Vol. 2, N° 3 3 [2009-1-30] [url: http://www.cairn.info/resume.php?ID_ARTICLE=RAC_005_0505] p. 505-521.
213. BRODA, Rudolf: "The Revival of Nationalities in the Soviet Union", *American Journal of Sociology* 37 1 [1931] [url: <http://www.jstor.org/stable/2766799>] p. 82-93.
214. BRODY, Elaine and Richard Langham SMITH: "Bourgault-Ducoudray, Louis", *Grove Music Online* [2001] [url: <http://www.oxfordmusiconline.com/subscriber/article/grove/music/03719?q=brittany+music&search=quick&pos=5&start=1#firsthit>].
215. BROMLEY, J.H.: *On Music (Plutarch)*, C. Whittingham [Chiswick, 1822].
216. BROWN, Katherine Butler: "Evidence of Indo-Persian Musical Synthesis? The Tanbur and Rudra Vina in Seventeenth-Century Indo-Persian Treatises", *Journal of the Indian Musicological Society* [2006] [url: <http://www.academia.edu/download/32886156/2006IndoPsynt.pdf>] p. 36-7.
217. BRUYÈRE, Jean de La, THEOPHRASTUS and Jean Geoffroy SCHWEIGHAEUSER: *Caractères de La Bruyère: suivis des caractères de Théophraste, traduits du grec par La Bruyère, avec des notes et des additions*, Firmin Didot frères [1847].
218. BRYENNIUS, Manouël (Manuel): *MANOYHA BRYENNIYOY APMONIKA = The harmonics of Manuel Bryennius*, editor Goverdus Henricus Jonker, translator Goverdus Henricus Jonker, Wolters-Noordhoff [Groningen, 1970].
219. BUELOW, George J.: *Thorough-Bass Accompaniment According to Johann David Heinichen*, University of California Press [Berkeley, Los Angeles, 1966].
220. BUISSON, Ferdinand Edouard, ed.: *Dictionnaire de pédagogie et d'instruction primaire. Partie 2 / Tome 1 / publié sous la direction de F. Buisson, ... avec le concours d'un grand nombre de collaborateurs, 1 2/2 (vols.)* [1882-1893] [url: <http://gallica.bnf.fr/ark:/12148/bpt6k24239x>].
221. BURGUIÈRE, André: "L'historiographie des origines de la France: Genèse d'un imaginaire national", *Annales. Histoire, Sciences Sociales* 58 1 [2003-1-1] [url: <http://www.jstor.org/stable/27587115>] p. 41-62.
222. BURNLEY, Charles: *A general history of music, from the earliest ages to the present period. To which is prefixed, a dissertation on the music of the ancients 1/*, London, Printed for the author [1776] [url: <http://archive.org/details/generalhistoryofbum>].
223. BURNLEY, Charles: *A general history of music, from the earliest ages to the present period 1/*, HARCOURT, BRACE AND COMPANY [1789] [url: <http://archive.org/details/generalhistoryof017442mbp>].
224. BURNLEY, Charles and Frank MERCER: *A general history of music, from the earliest ages to the present period (1789) 1/*, Harcourt, Brace and Company [New York, 1935] [url: <http://archive.org/details/generalhistoryof00burn2>].

225. BURSTYN, Shai: “The ‘Arabian Influence’ Thesis Revisited”, *Current Musicology* 45 [1990] [url: <http://search.proquest.com/openview/1cc5961cfa1c48a4efd8c2a0206d/1?pq-origsite=gscholar&cbl=1819340>] p. 119.
226. BURUMA, Ian: “Lost In Translation”, *The New Yorker* [2004-6-14] [url: <http://www.newyorker.com/magazine/2004/06/14/lost-in-translation-3>].
227. BUTLER, Alfred Joshua: *The Arab conquest of Egypt and the last thirty years of the Roman dominion*, Oxford, Clarendon Press [1902] [url: <http://archive.org/details/arabconquestegy00butlgoog>].
228. CAHEN, Claude: “Lettre à Anouar Abdel-Malek”, *Diogenes* 49 [1965] p. 141.
229. CARRÈRE D'ENCAUSSE, Hélène: *L'empire éclaté: la révolte des nations en URSS; suivi de postface de mars 1990*, ed. 2. éd, Le livre de poche 5433, Flammarion [u.a.] [Paris, 1980].
230. CASELLA, Alfredo: *Evolution of music: throughout the history of the perfect cadence*, Chester [1924].
231. CATSIAPIS, Jean, Dimitri KRISIKIS and Nicolas SVORONOS: “Universalis: GRÈCE - De la Grèce byzantine à la Grèce contemporaine”, *Universalis* [2012-1-26] [url: <http://www.universalis-edu.com/encyclopedie/grece-de-la-grece-byzantine-a-la-grece-contemporaine/>].
232. CAZDEN, Norman: “Pythagoras and Aristoxenos Reconciled”, *Journal of the American Musicological Society* 11 2/3 [1958-7-1] [url: <http://www.jstor.org/stable/829897>] p. 97–105.
233. CHABRIER, Jean-Claude Ch.: “Les conditions historiques de l'exotisme musical français”, *L'exotisme musical français*, Slatkine [Genève, 1981a] p. 37–40.
234. CHABRIER, Jean-Claude Ch.: “[Review] La musique classique du Maghreb by Mahmoud Guettat”, *Revue de Musicologie* 67 2 [1981b-1-1] [doi: 10.2307/928740. url: <http://www.jstor.org/stable/928740>] p. 237–240.
235. CHABRIER, Jean-Claude Ch., A. DIETRICH, Clifford Edmund BOSWORTH and Henry George FARMER: “Üd: Encyclopaedia of Islam, Second Edition: Brill Online”, editors Peari Bearman, Th. Bianquis, C. E. Bosworth, et al., [Print Version: Volume X, page 767, column 2] [2000] [url: <http://www.brillonline.nl/>].
236. CHAILLEY, Jacques: *Histoire Musicale du Moyen Âge Théorie Occidentale*, Quadrige / PUF [Vendome - France, 1950].
237. CHAILLEY, Jacques: “Le mythe des modes grecs”, *Acta Musicologica* 28 4 [1956-10-1] [doi: 10.2307/932142. url: <http://www.jstor.org/stable/932142>] p. 137–163.
238. CHAILLEY, Jacques: “Essai sur les structures mélodiques”, *Revue de Musicologie* 44 120 [1959-12-1] [doi: 10.2307/927967. url: <http://www.jstor.org/stable/927967>] p. 139–175.
239. CHAILLEY, Jacques: *L'imbroglia des modes*, Alphonse Leduc [1960-1977].
240. CHAILLEY, Jacques: *40,000 Years of Music: Man in Search of Music*, Macdonald [1964].
241. CHAILLEY, Jacques: *Expliquer l'harmonie ?*, L'Harmattan [1967].
242. CHAILLEY, Jacques: *La musique grecque antique*, Les Belles Lettres [Paris, 1979].
243. CHAILLEY, Jacques: “Les huit tons de la musique et l'éthos des modes aux chapiteaux de Cluny”, *Acta Musicologica* 57 1 [1985a] p. 73–94.
244. CHAILLEY, Jacques: *Éléments de philologie musicale [Recherche des principes - Intervalles et Échelles]*, Alphonse Leduc [Paris, 1985b].
245. CHAILLEY, Jacques, H. CHALLAN and Claude DELVINCOURT: *Théorie de la musique: J. Chailley, ... H. Challan, ... Préface de Claude Delvincourt*, Alphonse Leduc [Paris, 1947].
246. CHAILLEY, Jacques and Jacques VIRET: *Le Symbolisme de la Gamme, La Revue Musicale, Double numéro* 408–409, CID [Nantes - France, 1988].
247. CHRISTIANOWITSCH, Alexandre: *Esquisse historique de la musique arabe aux temps anciens: avec dessins d'instruments et quarante mélodies notées et harmonisées* [1863].
248. CHRYSANTHOS (DE MADYTOS): Εισαγωγή εις το Θεωρητικόν και Πρακτικόν της Εκκλησιαστικής Μουσικής [Eisagōgē eis to theōrētikon kai praktikon tēs ekklesiastikēs mousikēs – *Introduction to the Theory and Practice of Ecclesiastical Music*], Koutoura [En Parisois (Paris), 1821].
249. CHRYSANTHOS (DE MADYTOS): *Great theory of music*, translator Kaitē Rōmanou, The Axion Estin Foundation [2010].
250. CHRYSANTHOS (DE MADYTOS) and CHOURMOUZIOS (CHARTOPHYLAX): *Introduction to the New Method of Byzantine Chant Notation: An English translation of Chourmouziou's revision of Chrysanthos' Eisagoge*, translator Konstantinos Terzopoulos, CreateSpace [2012-3-22].
251. CHRYSANTHOS (DE MADYTOS) and Panagiōtēs G. PELOPIDĒS: Θεωρητικόν μέγα της Μουσικῆς [Theōrētikon mega tēs mousikēs – *Great theoretical book of music*], En Tergeste: ek tes typographias Michael Vais (Michele Weis) [Trieste - Italie, 1832].
252. CHRYSANTHOS (DE MADYTOS) and Kaitē RŌMANOU: *Great theory of music by Chrysanthos of Madytos*, Thesis, Indiana University [1973].
253. CLÉONIDE and EUCLIDE: L'introduction harmonique de Cléonide: la Division du canon d'Euclide le géomètre, canons harmoniques de Florence; traduction française avec commentaire perpétuel, editor Charles-Émile Ruelle, Firmin Didot et Cie [1884].
254. COLLANGETTES, S. J.: “Étude sur la musique arabe (premier article)”, *Journal Asiatique ou recueil de mémoires d'extraits et de notices relatifs à l'histoire, à la philosophie, aux langues et à la littérature des peuples orientaux* 10 IV [1904-7] p. 365–422.
255. COLLANGETTES, S. J.: “Étude sur la musique arabe (suite)”, *Journal Asiatique ou recueil de mémoires d'extraits et de notices relatifs à l'histoire, à la philosophie, aux langues et à la littérature des peuples orientaux* 10 VIII [1906] p. 149–190.
256. COLLECTIF: كتاب مؤتمر الموسيقى العربية Kitāb mu'tamar al-mūsīqā al-'arabiyya [Livre du Congrès de Musique arabe], Al-Maṭba'a al-Amīriyya (وزارة المعارف العمومية) [Le Caire 1933 القاهرة].
257. COLLECTIF, ouvrage: *Recueil des Travaux du Congrès de Musique Arabe qui s'est tenu au Caire en 1932 (Hég. 1350) sous le Haut Patronage de S. M. FOUAD 1er, ROI D'ÉGYPTE*, Imprimerie Nationale d'Égypte [Le Caire - Egypte, 1934].
258. COMMISSION MUSICALE DE (MUSICAL COMMITTEE OF) 1881, APHTONIDĒS and AL: Στοιχειώδης διδασκαλία της εκκλησιαστικής μουσικής εκπονηθείσα επί τη βάσει του ψαλτηρίου υπό της μουσική επιτροπής του Οικουμενικού Πατριαρχείου εν έτει 1883 [Elementary teachings of ecclesiastical music elaborated on the basis of the psalter by the musical committee of the Ecumenical Patriarchate in the year 1883], (Orthodox Patriarchate) Patriarcate de Constantinople [Istanbul, 1888].
259. COMMISSION MUSICALE DE (MUSICAL COMMITTEE OF) 1881, APHTONIDĒS and AL: Στοιχειώδης διδασκαλία της εκκλησιαστικής μουσικής εκπονηθείσα επί τη βάσει του ψαλτηρίου υπό της μουσική επιτροπής του Οικουμενικού Πατριαρχείου εν έτει 1883 [Elementary teachings of ecclesiastical music elaborated on the

- basis of the psalter by the musical committee of the Ecumenical Patriarchate in the year 1883], ed. 2 (?), Coultoura [Athènes, 1978-1888].
260. CONOMOS, Dimitri E.: "Experimental Polyphony „According to the... Latins“, in Late Byzantine Psalmody”, *Early Music History* 2 1 [1982] p. 1–16.
261. CONOMOS, Dimitri E., ed.: *Studies in Eastern chant vol. V 5/5* (vols.), St Vladimir's Seminary Press [Chestwood NY, 1990].
262. CONOMOS, Dimitri E.: "A Brief Survey of the History of Byzantine and Post-Byzantine Chant" [2012-6-3] [url: <http://stanthonysmonastery.org/music/History.htm>].
263. CONRAD, Joseph: *Heart of Darkness*, Rosings Digital Publications [2012] [url: http://archive.org/details/ost-english-conrad_joseph_1857_1924_heart_of_darkness].
264. COWL, Carl and Sheila M CRAIK: Henry George Farmer: a bibliography, Glasgow University Library Studies, GLUS [Scotland, 1999].
265. CREAMY, Edward Shepherd and Joseph HAMMER-PURGSTALL (VON): *History of Ottoman Turks; from the beginning of their empire to the present time. Chiefly founded on Von Hammer*, London R. Bentley [1854-56] [url: <http://archive.org/details/historyofottoman02creaouff>].
266. CREAMY, Edward Shepherd and Joseph HAMMER-PURGSTALL (VON): *History of the Ottoman Turks; from the beginning of their empire to the present time, chiefly founded on Von Hammer*, London R. Bentley [1856] [url: <http://archive.org/details/historyottomant01creagoog>].
267. CROCKER, Richard L.: "Pythagorean Mathematics and Music", *The Journal of Aesthetics and Art Criticism* 22 2 [1963-12-1] [doi: 10.2307/427754. url: <http://www.jstor.org/stable/427754>] p. 189–198.
268. CRONIN, Stephanie: "Introduction: Edward Said, Russian Orientalism and Soviet Iranology", *Iranian Studies* 48 5 [2015-9-3] [doi: 10.1080/00210862.2015.1058633. url: <http://dx.doi.org/10.1080/00210862.2015.1058633>] p. 647–662.
269. DAWISHA, Karen: "Soviet Cultural Relations with Iraq, Syria and Egypt 1955-70", *Soviet Studies* 27 3 [1975] [url: <http://www.jstor.org/stable/150445>] p. 418–442.
270. DEFRANCE, Yves: "Exotisme et esthétique musicale en France: Approche socio-historique", *Cahiers de musiques traditionnelles* 7 [1994-1-1] [doi: 10.2307/40240201. url: <http://www.jstor.org/stable/40240201>] p. 191–210.
271. DELIA, Diana: "From Romance to Rhetoric: The Alexandrian Library in Classical and Islamic Traditions", *The American Historical Review* 97 5 [1992-12] [doi: 10.2307/2165947. url: <http://www.jstor.org/stable/10.2307/2165947?origin=crossref>] p. 1449.
272. DELORME, Olivier: *La Grèce et les Balkans: du Ve siècle à nos jours*, Collection Folio histoire 220–222, Gallimard [Paris, 2013].
273. DESPENTES, Virginie: *Vernon Subutex, 1: roman* 1/2 (vols.), Grasset [Paris, 2015-1-7].
274. DINGELSTEDT, V.: "The Greeks and Hellenism", *Scottish Geographical Magazine* 30 8 [1914-8-1] [doi: 10.1080/14702541408554091. url: <http://dx.doi.org/10.1080/14702541408554091>] p. 412–427.
275. DJUMAEV, Alexander: "Power Structures, Culture Policy, and Traditional Music in Soviet Central Asia", *Yearbook for Traditional Music* 25 [1993] [doi: 10.2307/768682. url: <http://www.jstor.org/stable/768682?origin=crossref>] p. 43.
276. DJUMAEV, Alexander: "Musical Heritage and National Identity in Uzbekistan", *Ethnomusicology Forum* 14 2 [2005-11-1] [doi: 10.1080/17411910500329732. url: <http://dx.doi.org/10.1080/17411910500329732>] p. 165–184.
277. DOMMEL-DIÉNY, Amy: *L'Harmonie tonale: Regards sur l'évolution du langage harmonique*, ed. 4e éd., Editions transatlantiques [Paris, 1986].
278. DRABKIN, William: "Circle of fifths", editors Stanley Sadie and John Tyrrell, *New Grove Dictionary of Music and Musicians – Vol. 5: Canon to Classic Rock 5/29* (vols.), Oxford Usa Trade [2001] p. 866–867.
279. DRAGOUMIS, Markos Ph. (Marc): "L'Église grecque du xv^e siècle à nos jours", editor Jacques Porte, *Encyclopédie des musiques sacrées* 2/3 (vols.), Éditions Labergerie [Paris, 1968] p. 170–175.
280. DURING, Jean: "BARBAT", *Encyclopaedia Iranica*, [Vol. III, Fasc. 7, p. 758-759] [1988-12-15] [url: <http://www.iranicaonline.org/articles/barbat>].
281. DURING, Jean: "Third millenium Tehran: Music!", *Iranian Studies* 38 3 [2005a-9-1] [doi: 10.1080/00210860500300762. url: <http://dx.doi.org/10.1080/00210860500300762>] p. 373–398.
282. DURING, Jean: "Power, Authority and Music in the Cultures of Inner Asia", *Ethnomusicology Forum* 14 2 [2005b-11-1] [doi: 10.1080/17411910500336273. url: <http://www.jstor.org/stable/20184516>] p. 143–164.
283. DURING, Jean: "The sources of Transoxian musical intervals", *Proceedings of the 5th Meeting of the Study Group "Maqâm"*, ed. Jürgen Elsner and Gisa Jähnichen, Trafo [Berlin, 2008] p. 75–82.
284. DURING, Jean: "The loss of maqamic sense in Central Asia", *Muqam in and outside of Xinjiang / China, Proceedings of the 6th Study Group Meeting Muqam, Urumqi 2006*, Chinese uyghur classical litterature and muqam institute [Urumqi, 2009] p. 91–101.
285. DURING, Jean: "Globalisations de l'ère préindustrielle et formatage de l'oreille du monde. L'écoute de l'ethnomusicologue", *Musique et globalisation: Musicologie Ethnomusicologie*, ed. Jacques Bouët and Makis Solomos, L'Harmattan [Paris, 2011] p. 39–68.
286. DURING, Jean: "The Baluchi benju, a new traditional instrument", *Near Eastern Musicology Online* 3 4 [2015-11] [url: <http://nemo-online.org/articles>] p. 5–12.
287. DUROSELLE, Jean Baptiste: *L'idée d'Europe dans l'histoire*, Denoël [1965].
288. DURUY, Victor: *Histoire populaire contemporaine de la France*, Paris: Hachette [1864] [url: http://archive.org/details/bub_gb_EmdaAAAaAAJ].
289. VAN EDWARDS, David: "A HISTORY of the LUTE, Part 1" [url: <http://www.vanedwards.co.uk/history1.htm>].
290. EFSTATHIOU, Ioannis, Fokion GEORGIADIS and Apostolos ZISIMOS: "Religion in Greek education in a time of globalization", *Intercultural Education* 19 4 [2008-8-1] [doi: 10.1080/14675980802376853. url: <http://www.tandfonline.com/doi/abs/10.1080/14675980802376853>] p. 325–336.
291. EL-ABBADI, Mostafa, Omnia FATHALLAH and Ismail SERAGELDIN: *What Happened to the Ancient Library of Alexandria?*, BRILL [2008-2-28].
292. ELLIS, Alexander John: "On the Sensitiveness of the Ear to Pitch and Change of Pitch in Music", *Proceedings of the Musical Association* 3 [1876-1-1] [url: <http://www.jstor.org/stable/765234>] p. 1–32.
293. ELLIS, Alexander John: "On the musical scales of various nations", *Journal of the Society of Arts* 33 [1885] p. 485–517.
294. EL-SHAWAN CASTELO-BRANCO, Salwa El-Shawan: "Mutations dans la musique égyptienne: une question majeure au Congrès de

- musique arabe”, *Musique arabe: le congrès du Caire de 1932*, CEDEJ |Le Caire - Egypte, 1992| p. 41–49.
295. EMMANUEL, Maurice: “Grèce”, editor Albert Lavignac, *Encyclopédie de la musique et dictionnaire du conservatoire – Première partie: Histoire de la musique 1.1.*, Delagrave |Paris, 1921| [url: <http://gallica.bnf.fr/ark:/12148/bpt6k1237270>] p. 377–540.
296. D’ENCAUSSE, Hélène Carrère: *Lénine: la révolution et le pouvoir*, Flammarion |1979a|.
297. D’ENCAUSSE, Hélène Carrère: *Staline: l’ordre par la terreur*, Flammarion |1979b|.
298. ERGUNER, Ahmed Kudsi: “Alla turca: Alla franca: Les enjeux de la musique turque”, *Cahiers de musiques traditionnelles 3* |1990-1-1| [doi: 10.2307/40240065. url: <http://www.jstor.org/stable/40240065>] p. 45–56.
299. ERGUR, Ali and Nilgün DOĞRUSÖZ: “Resistance and Adoption towards Written Music at the Crossroads of Modernity: Gradual Passage to Notation in Turkish Makam Music”, *International Review of the Aesthetics and Sociology of Music 46 1* |2015| [url: <http://www.jstor.org/stable/24327332>] p. 145–174.
300. ERICKSON, Raymond and Claude V. PALISCA: *Musica Enchiriadis: And, Scolica Enchiriadis*, Yale University Press |1995|.
301. ERLANGER, Rodolphe (d’): *La musique arabe*, 6 tomes – I. [Al-Fārābī] (1930) ; II. [Al-Fārābī et Ibn Sīnā] (1935) ; III. [Commentaires sur Le Livre des Cycles de Safiyy-a-d-Din al-Urmawī] (1938) ; IV. [Anon. – a-sh-Shirwānī – et al-Lādhiqī] (1939) ; V. [Échelles et modes] (1949) ; VI. [Rythmes et formes] (1959) 6 (vols.), Librairie orientaliste Paul Geuthner |Paris, 1930-1959|.
302. ERLANGER, Rodolphe (d’): *La musique arabe (5) – Essai de codification des règles usuelles de la musique arabe moderne. Échelle générale des sons, système modal 5/6* (vols.), Librairie Orientaliste Paul Geuthner |Paris, France, 1949|.
303. ERLANGER, Rodolphe (d’): *La musique arabe (6) – Essai de codification des règles usuelles de la musique arabe moderne (suite): Système rythmique, Formes de composition 6/6* (vols.), Librairie Orientaliste Paul Geuthner |Paris, France, 1959|.
304. ERLANGER, Rodolphe (d’): *La musique arabe*, 6 tomes – I. [Al-Fārābī] (1930) ; II. [Al-Fārābī et Ibn Sīnā] (1935) ; III. [Commentaires sur Le Livre des Cycles de Safiyy-a-d-Din al-Urmawī] (1938) ; IV. [Anon. – a-sh-Shirwānī – et al-Lādhiqī] (1939) ; V. [Échelles et modes] (1949) ; VI. [Rythmes et formes] (1959), editor Christian Poché, ed. 2^e en fac-similé 6 (vols.), Librairie orientaliste Paul Geuthner |Paris, 2001a|.
305. ERLANGER, Rodolphe (d’): *La musique arabe (5) – Essai de codification des règles usuelles de la musique arabe moderne. Échelle générale des sons, système modal*, ed. 2^e en fac-similé, Les Geuthner (Paris), ISSN 1294-6656 5/6 (vols.), Librairie Orientaliste Paul Geuthner |Paris, 2001b|.
306. EROL, Merih: *Greek Orthodox music in Ottoman Istanbul: nation and community in the era of reform*, Ethnomusicology multimedia, Indiana University Press |Bloomington ; Indianapolis, 2015|.
307. EUCLID, André BARBERA and PORPHYRY: *The Euclidean Division of the canon: Greek and Latin sources: new critical texts and translations on facing pages, with an introduction, annotations, and indices verborum and nominum et rerum*, The greek and Latin music theory, University of Nebraska Press |Nebraska - EU, 1991|.
308. EUCLIDE: *Euclide: la division du canon*, translator Charles Emile Ruelle, Firmin Didot Freres |Paris, 1884| [url: <http://remacle.org/bloodwolf/erudits/euclide/canon.htm>].
309. FALLMERAYER, Jacob Philipp: *Das albanesische Element in Griechenland*, G. Franz |1857|.
310. FANON, Frantz: *Les damnés de la terre*, J.-M. Tremblay |Chicoutimi, 2011| [url: http://classiques.uqac.ca/classiques/fanon/franz/damnes_de_la_terre/damnes_de_la_terre.html].
311. FĀRĀBĪ (AL-), Abū-n-Naṣr Muḥammad ibn Muḥammad ibn Tarkhān: *La musique arabe (1) – Al-Fārābī, Grand traité de la musique [Kitāb al-Mūsīqī al-Kabīr] (Livres I et II)*, editor Rodolphe d’Erlanger, translator Rodolphe (d’) Erlanger 1/6 (vols.), Librairie Orientaliste Paul Geuthner |Paris, France, 1930|.
312. FĀRĀBĪ (AL-), Abū-n-Naṣr Muḥammad ibn Muḥammad ibn Tarkhān: *La musique arabe (1) – Al-Fārābī, Grand traité de la musique [Kitāb al-Mūsīqī al-Kabīr] (Livres I et II)*, editor Christian Poché, translator Rodolphe (d’) Erlanger, ed. 2^e en fac-similé, *Les Geuthner (Paris)*, ISSN 1294-6656 1/6 (vols.), Librairie Orientaliste Paul Geuthner |Paris, France, 2001|.
313. FĀRĀBĪ (AL-), Abū-n-Naṣr Muḥammad ibn Muḥammad ibn Tarkhān, al-Ḥusayn ibn ‘Abd-al-Lāh SĪNĀ (IBN) OU AVICENNE (0980?-1037), (الصينين ابن عبد الله -0980 and محمد ابن محمد أبو نصر الفارابي (1037: *La musique arabe (2) – Al-Fārābī [Grand traité de la musique] Livre III du Kitāb al-Mūsīqī al-Kabīr; Sīnā (ibn) ou Avicenne*, Kitāb a-sh-Shifā’ – *Mathématiques*, editor Rodolphe d’Erlanger, translator Rodolphe (d’) Erlanger, *Les Geuthner (Paris)*, ISSN 1294-6656 2/6 (vols.), Librairie Orientaliste Paul Geuthner |Paris, 1935|.
314. FARMER, Henry George: “Arab Influence on Spanish Music”, *The Musical Times 60 920* |1919-10-1| [doi: 10.2307/3701778. url: <http://www.jstor.org/stable/3701778>] p. 555.
315. FARMER, Henry George: “Clues for the Arabian Influence on European Musical Theory”, *Journal of the Royal Asiatic Society of Great Britain and Ireland 1* |1925a-1-1| [url: <http://www.jstor.org/stable/25220636>] p. 61–80.
316. FARMER, Henry George: “The Influence of Music: From Arabic Sources”, *Proceedings of the Musical Association 52* |1925b-1-1| [url: <http://www.jstor.org/stable/765597>] p. 89–124.
317. FARMER, Henry George: *A History of Arabian Music to the XIIIth Century*, Luzac |Bristol, Great-Britain, 1929|.
318. FARMER, Henry George: Historical facts for the Arabian musical influence, Ayer Publishing |1930a|.
319. FARMER, Henry George: “Greek Theorists of Music in Arabic Translation”, *Isis 13 2* |1930b-2-1| [url: <http://www.jstor.org/stable/224649>] p. 325–333.
320. FARMER, Henry George: “An Old Moorish Lute Tutor”, *Journal of the Royal Asiatic Society of Great Britain and Ireland 2* |1931-4-1| [url: <http://www.jstor.org/stable/25194254>] p. 349–366.
321. FARMER, Henry George: “An Old Moorish Lute Tutor (Cont.)”, *Journal of the Royal Asiatic Society of Great Britain and Ireland 4* |1932-10-1| [url: <http://www.jstor.org/stable/25194614>] p. 897–904.
322. FARMER, Henry George: “A Maghribī Work on Musical Instruments”, *Journal of the Royal Asiatic Society of Great Britain and Ireland 2* |1935-4-1| [url: <http://www.jstor.org/stable/25201113>] p. 339–353.
323. FARMER, Henry George: “The Lute Scale of Avicenna”, *Journal of the Royal Asiatic Society of Great Britain and Ireland 2* |1937a-4-1| [url: <http://www.jstor.org/stable/25201498>] p. 245–257.
324. FARMER, Henry George: “Was the Arabian and Persian Lute Fretted?”, *Journal of the Royal Asiatic Society of Great Britain and Ireland 3* |1937b-7-1| [url: <http://www.jstor.org/stable/25201549>] p. 453–460.
325. FARMER, Henry George: “The Structure of the Arabian and Persian Lute in the Middle Ages”, *Journal of the Royal Asiatic*

- Society of Great Britain and Ireland 1* [1939-1-1] [url: <http://www.jstor.org/stable/25201835>] p. 41–51.
326. FARMER, Henry George: *The Sources of Arabian Music. An Annotated Bibliography of Arabic Manuscripts Which Deal with the Theory, Practice and History of Arabian Music*, the Author [1940].
327. FARMER, Henry George: “The Music of ‘The Arabian Nights’”, *Journal of the Royal Asiatic Society of Great Britain and Ireland 2* [1944-10-1] [url: <http://www.jstor.org/stable/25221976>] p. 172–185.
328. FARMER, Henry George: “The Music of the Arabian Nights (Continued from p. 185, October, 1944)”, *Journal of the Royal Asiatic Society of Great Britain and Ireland 1* [1945-4-1] [url: <http://www.jstor.org/stable/25222000>] p. 39–60.
329. FARMER, Henry George: “An Early Greek Pandore”, *Journal of the Royal Asiatic Society of Great Britain and Ireland 2* [1949-10-1] [url: <http://www.jstor.org/stable/25222335>] p. 177–179.
330. FARMER, Henry George: “Mi’zaf, Mi’zafa: Encyclopaedia of Islam, Second Edition: Brill Online”, [Print Version: Volume VII, page 189, column 2] [1993] [url: http://www.brillonline.nl/subscriber/uid=2022/entry?result_number=2&entry=islam_COM-0756&search_text=santur&refine_editions=islam_islam#hit].
331. FARMER, Henry George: “Zalzal”, *Grove Music Online* [2001] [url: <http://www.oxfordmusiconline.com/>].
332. FARMER, Henry George, Werner BACHMANN, Heinrich BESELLER and Max SCHNEIDER: *Musikgeschichte in Bildern: Islam, [Band III: Musik des Mittelalters und der Renaissance / Lieferung 2]*, Veb Deutscher Verlag Fur Musik [Leipzig, 1966].
333. FARMER, Henry George and Eckhard NEUBAUER: “Zalzal: Encyclopaedia of Islam, Second Edition: Brill Online”, [Print Version: Volume XI, page 427, column 1] [2002] [url: <http://www.brillonline.nl/>].
334. FELDMAN, Walter: *Music of the Ottoman Court: makam, composition and the early Ottoman instrumental repertoire, Intercultural Music studies, VWB-Verlag für Wissenschaft und Bildung* [Berlin, 1996].
335. FELDMAN, Walter Zev: “Ottoman music”, editors Stanley Sadie and John Tyrrell, *New Grove: Dictionary of Music and Musicians 18/29* (vols.), Oxford University Press [Oxford, 2001] [url: <http://www.oxfordmusiconline.com/>] p. 809–814.
336. FEND, Michael: “La Borde, Jean-Benjamin de”, *Grove Music Online* [2001].
337. FÉTIS: “Classification des races à l’aide de leurs systèmes musicaux”, *Bulletins de la Société d’anthropologie de Paris 2 1* [1867] [doi: 10.3406/bmsap.1867.4288. url: http://www.persee.fr/web/revues/home/prescript/article/bmsap_0301-8644_1867_num_2_1_4288] p. 134–146.
338. FÉTIS, François-Joseph: *Histoire générale de la musique (3) depuis les temps les plus anciens jusqu’à nos jours 3/5* (vols.), Firmin Didot [Paris, 1869a].
339. FÉTIS, François-Joseph: *Histoire générale de la musique (2) depuis les temps les plus anciens jusqu’à nos jours 2/5* (vols.), Firmin Didot [Paris, 1869b].
340. FINKELSTEIN, Henry C.: “Persia”, *The American History and Encyclopedia of Music: Opera, with introd, by H. E. Krehbiel*, Vol. 3, I. Squire [Toledo, New York, Chicago, 1908].
341. FLEISCHER, Oskar: “Recherches sur l’histoire de la gamme arabe”, *Vierteljahrsschrift für Musikwissenschaft 2 4* [1886] [doi: Leiden].
342. FLEMING, K. E.: “Orientalism, the Balkans, and Balkan Historiography”, *The American Historical Review 105 4* [2000] [doi: 10.2307/2651410. url: <http://www.jstor.org/stable/2651410>] p. 1218–1233.
343. FLEMING, K. E.: *The Muslim Bonaparte: Diplomacy and Orientalism in Ali Pasha’s Greece*, Princeton University Press [2014-7-14].
344. FLEMING, Katherine. E.: *The Muslim Bonaparte: Diplomacy and Orientalism in Ali Pasha’s Greece*, 1st ed., Princeton University Press [Princeton, 1999].
345. FRANCE. COMMISSION DES SCIENCES ET ARTS D’ÉGYPTE: *Description de l’Égypte, ou, Recueil des observations et des recherches qui ont été faites en Égypte pendant l’expédition de l’armée française*, Imprimerie impériale [Paris, 1809].
346. GABRIELI, Francesco: “Apology of Orientalism (Apologie de l’orientalisme)”, translator Victor A. Velen, *Diogenè 50* [1965a] p. 134.
347. GABRIELI, Francesco: “Apologie de l’orientalisme”, *Diogenè 50* [1965b] p. 134.
348. GABRIELI, Francesco: *Chroniques arabes des Croisades, Sindbad* [Paris, 1977].
349. GAMIL, Soliman: *Map of Egypt Before the Sands*, Audio CD, Touch Records [2001-1-11].
350. GASTOUÉ, Amédée: “La tradition ancienne dans le chant byzantin”, *La Tribune de Saint-Gervais; revue musicologique de la Schola Cantorum*, ed. Charles Bordes and G. Boisjolin (de), Schola Cantorum [Paris, 1899a] [url: <http://archive.org/details/latribunedesaint190612pari>] p. 107–112, 145–152.
351. GASTOUÉ, Amédée: “Le chromatisme byzantin et le chant grégorien”, *La Tribune de Saint-Gervais; revue musicologique de la Schola Cantorum*, ed. Charles Bordes and G. Boisjolin (de), Schola Cantorum [Paris, 1899b] [url: <http://archive.org/details/latribunedesaint190612pari>] p. 6–13.
352. GASTOUÉ, Amédée: *Introduction à la paléographie musicale byzantine. Catalogue des manuscrits de musique byzantine de la Bibliothèque Nationale de Paris et des bibliothèques publiques de France*, Publications de la Société Internationale de Musique – Section de Paris, Impressions artistiques L. M. Fortin [Paris, 1907].
353. GASTOUÉ, Amédée: *L’orgue en France: de l’antiquité au début de la période classique*, Au Bureau d’édition de la “Schola” [1921a].
354. GASTOUÉ, Amédée: “La musique byzantine”, editor Albert Lavignac, *Encyclopédie de la musique et dictionnaire du conservatoire – Première partie: Histoire de la musique 1.1/*, Delagrave [Paris, 1921b] [url: <http://gallica.bnf.fr/ark:/12148/bpt6k1237270>] p. 541–556.
355. GASTOUÉ, Amédée: “Notes sur l’orgue en Orient. A Propos de la Communication de M. M. Raghieb”, *Revue de Musicologie 11 33* [1930-2-1] [doi: 10.2307/926299. url: <http://www.jstor.org/stable/926299>] p. 19–21.
356. GAUDEFRY-DEMOMBYNES, Maurice: *Les institutions musulmanes*, E. Flammarion [Paris, 1921-1931].
357. Gd21091993: “Extent of the French Colonial empires” [2010-4-11] [Own work. url: https://commons.wikimedia.org/wiki/File:131Etendue_de_l%27Empire_Fran%CC%80%27ais.png].
358. GEDIK, Ali C. and Barış BOZKURT: “Evaluation of the Makam Scale Theory of Arel for Music Information Retrieval on Traditional Turkish Art Music”, *Journal of New Music Research 38 2* [2009-6-1] [doi: 10.1080/09298210903171152. url: <http://dx.doi.org/10.1080/09298210903171152>] p. 103–116.
359. GEVAERT, F. A. (François Auguste): *Histoire et théorie de la musique de l’antiquité 1/2* (vols.), Gand: Typographie C. Annoot-Braeckman [1875a] [url: <http://archive.org/details/histoireettheori00geva>].
360. GEVAERT, F. A. (François Auguste): *Histoire et théorie de la musique de l’antiquité 2/2* (vols.), Gand: Typographie C. Annoot-

- Braeckman [1875b] [url: <http://archive.org/details/histoireettheori02geva>].
361. GHULMIYYA, Walid, Tawfiq KIRBĀJ and Antūn FARAH: *Nazarīyyāt al-Mūsīqā A-sh-Sharqī 'Arabīyya 5/*, CNSMB – Conservatoire National Supérieur de Musique de Beyrouth [Beyrouth, 1996].
362. GIANNELOS, Dimitrios: *Musique byzantine: tradition orale et tradition écrite*, XVIII^e-XX^e siècles, 3^e cycle Ethnologie, Paris X [Nanterre, 1988].
363. GIANNELOS, Dimitrios: *La musique byzantine: le chant ecclésiastique grec, sa notation et sa pratique actuelle*, Collection Musique et musicologie, les Dialogues, ISSN 1272-1972; 1996, L'Harmattan [1996].
364. GIBBON, Edward: *The History of the Decline and Fall of the Roman Empire IX/XII* (vols.), Thomas Y. Crowell & Co [New York, 1872].
365. GILLESPIE, David C.: "The Sounds of Music: Soundtrack and Song in Soviet Film", *Slavic Review* 62 3 [2003] [doi: 10.2307/3185802. url: <http://www.jstor.org/stable/3185802?origin=crossref>] p. 473.
366. GILMAN, Benjamin Ives: "The Science of Exotic Music", *Science, New Series* 30 772 [1909-10-15] [doi: 10.1126/science.30.772.532. url: <http://www.jstor.org/stable/1635211>] p. 532–535.
367. GRADENWITZ, Peter: "Félicien David (1810-1876) and French Romantic Orientalism", *The Musical Quarterly* 62 4 [1976-10-1] [url: <http://www.jstor.org/stable/741553>] p. 471–506.
368. GRAZIANO, Amy B. and Julene K. JOHNSON: "Richard Wallasche's Nineteenth-Century Contributions to the Psychology of Music", *Music Perception: An Interdisciplinary Journal* 23 4 [2006] [doi: 10.1525/mp.2006.23.4.293. url: <http://www.jstor.org/stable/10.1525/mp.2006.23.4.293>] p. 293–304.
369. GREATED, Clive: "Comma", *Grove Music Online* [2001] [url: <http://www.oxfordmusiconline.com/>].
370. GRONOW, Pekka: "Ethnic Music and Soviet Record Industry", *Ethnomusicology* 19 1 [1975-1] [doi: 10.2307/849748. url: <http://www.jstor.org/stable/849748?origin=crossref>] p. 91.
371. GUETTAT, Mahmoud: *La musique classique du Maghreb, La Bibliothèque arabe*. Collection Hommes et sociétés, ISSN 0990-4913; 5 Ethnomusicologie Arabe/, Sindbad [Paris, France, 1980].
372. GUETTAT, Mahmoud: *La musique arabo-andalouse. L'empreinte du Maghreb*. Tome I, Chants et Poésies du Maghreb, Fleurs Sociales - El-Ouns [Paris, Montréal, 2000].
373. GUETTAT, Mahmoud: "Nazariyyat Takwīn a-s-Salālim al-Mūsīqīyya wa-n-Nizām al-Mūsīqīyy al-'Arabīyy", *Al-Baḥṡh al-Mūsīqīyy* (2002) 1 2 (البحث الموسيقي) - Autumn - Winter 2003] p. 9–59.
374. GUID'AREZZO, Marie-Noëlle: *Micrologus*, Éd. IPMC [Paris, 1993].
375. GUIDO, d'Arezzo and Mich (Michael) HERMESDORFF: *Micrologus Guidonis de disciplina artis musicae, d. i. Kurze Abhandlung Guido's über die Regeln der musikalischen Kunst*, Trier, Commissionsverlag J. B. Grach [1876] [url: <http://archive.org/details/micrologusguido00hermgoog>].
376. GUINS, George C.: "East and West in Soviet Ideology", *Russian Review* 8 4 [1949-10] [doi: 10.2307/125289. url: <http://www.jstor.org/stable/125289?origin=crossref>] p. 271.
377. HAGE, Louis: *Un piano occidental oriental: Le piano Chahine* [Kaslik - Liban, 1975].
378. HAGE, Louis: *Les "modes" du chant syro-maronite*, Université Saint-Esprit de Kaslik [Kaslik - Lebanon, 2005].
379. HAMMER-PURGSTALL (VON), Joseph: *Histoire de l'empire ottoman depuis son origine jusqu'à nos jours (01) 01/*, Bellizard, Barthès, Dufour et Lowell [1835] [url: <http://archive.org/details/histoiredelempi11turkgoog>].
380. HARASZTI, Emile: "Fétis fondateur de la musicologie comparée. Son étude sur un nouveau mode de classification des races humaines d'après leurs systèmes musicaux, Contribution à l'œuvre de Fétis", *Acta Musicologica* 4 3 [1932-7-1] [doi: 10.2307/931921. url: <http://www.jstor.org/stable/931921>] p. 97–103.
381. HARRIS, Rachel and Rahilā DAWUT: "Mazar festivals of the Uyghurs: Music, Islam and the Chinese State", *British Journal of Ethnomusicology* 11 1 [2002-1-1] [doi: 10.1080/09681220208567330. url: <http://dx.doi.org/10.1080/09681220208567330>] p. 101–118.
382. HARRISON, Frank Llewellyn: *Time, place and music: An anthology of ethnomusicological observation c. 1550 to c. 1800*, Frits Knuf [1973].
383. HAUGHTON, Brian: "What happened to the Great Library at Alexandria?", *Ancient History Encyclopedia* [2011-2-1] [url: <http://www.ancient.eu/article/207/>].
384. HEINICHEN, Johann David: *Der General-Bass in der Composition, oder: Neue und gründliche Anweisung: wie ein Music-Liebender mit besonderm Vortheil, durch die principia der Composition, nicht allein den General-Bass im kirchen- cammer- und theatralischen Stylo vollkommen. & in altiori Gradu erlernen: sondern auch zu gleicher Zeit in der Composition selbst, wichtige profectus machen Können. Nebst einer Einleitung oder musikalischen Raisonnement von der Music überhaupt, und vielen besondern Materien der heutigen Praxeos*, Dresden: Bey dem autore [1728] [url: http://archive.org/details/dergeneralbassin00hein_0].
385. HELLMIG, Friedemann: "An Example of Lute Restoration", *The Galpin Society Journal* 23 [1970] [doi: 10.2307/842064. url: <http://www.jstor.org/stable/842064>] p. 64–68.
386. HELLMIG, Friedemann: "Lute Construction in the Renaissance and the Baroque", *The Galpin Society Journal* 27 [1974-5-1] [doi: 10.2307/841751. url: <http://www.jstor.org/stable/841751>] p. 21–30.
387. HELMHOLTZ, Hermann L. F. (von): *Die Lehre von den Tonempfindungen als physiologische Grundlage Für die Theorie der Musik*, F. Vieweg [1877] [url: <http://archive.org/details/dielehrevondent04helmgoog>].
388. HELMHOLTZ, Hermann L. F. (von): *On the sensations of tone as a physiological basis for the theory of music: Translated, rev. and corr. rendered conformable to the 4th (and last) German ed. of 1877*, Longmans, Green, and Co. [London, UK, 1895].
389. HELMHOLTZ (VON), Hermann: *Sensations of Tone as a Physiological Basis for the Theory of Music*, Dover Publications [New York - EU, 1954-1885].
390. HIBBĪ, Antūn: *مبدىء الموسيقى الكنسية البيزنطية بحسب المذهب الصلطنيني* [Mabādī' al-Mūsīqā al-Kanasiyya al-Bizantīyya bi-Ḥasab al-Madhhab al-Qiṣṭānīniyy], 2nd ed., al-Maṭba'a al-Būlusīyya [Ḥariṣā – Lubnān (Liban), 1964].
391. HIBBĪ, Antūn: *Petite méthode de musique ecclésiastique byzantine: à l'usage des Paroisses grecques melkites catholiques de la diaspora*, imp. St Paul (Beyrouth), 1987].
392. HIGGINS, W. Mullinger: *The Philosophy of Sound and History of Music*, WM. S. ORR And Co. [Londres - Grande-Bretagne, 1838].
393. HİLŪ (AL-), Salim الموسيقى النظرية سليم الحلو: *Al-Mūsīqā a-n-Nazarīyya [La musique théorique]*, 2nd ed., منشورات دار مكتبة الحياة Dār Maktabat al-Ḥayāt بيروت - لبنان Beyrouth - Liban, 1972].
394. HIRSCH, Francine: "Toward an Empire of Nations: Border-Making and the Formation of Soviet National Identities", *The Russian Review* 59 2 [2000-4-1] [doi: 10.1111/0036-0341.00117].

- url: <http://onlinelibrary.wiley.com/doi/10.1111/0036-0341.00117/abstract>] p. 201–226.
395. HOLDER, William and Gottfried KELLER: *A treatise of the natural grounds, and principles of harmony*, Printed by W. Pearson, ... for J. Wilcox ... and T. Osborne [1731].
396. HOLLADAY, Richard L.: *The Musica Enchiriadis and Scholia Enchiriadis: A Translation and Commentary*, Ohio State University. [1977].
397. HOLLAND, Professor Robert: “Patterns of Anglo-Hellenism: A ‘Colonial’ Connection?”, *The Journal of Imperial and Commonwealth History* 36 3 [2008-9-1] [doi: 10.1080/03086530802318482. url: <http://dx.doi.org/10.1080/03086530802318482>] p. 383–396.
398. HOLLEMAN, A. W. J.: “The Oxyrhynchus Papyrus 1786 and the Relationship between Ancient Greek and Early Christian Music”, *Vigiliae Christianae* 26 1 [1972-3-1] [doi: 10.2307/1583179. url: <http://www.jstor.org/stable/1583179>] p. 1–17.
399. HOURANI, Albert: *Arabic thought in the liberal age 1798-1939, Oxford Paperbacks Orient*, Oxford University Press [Worcester, Grande-Bretagne, 1962].
400. HOURANI, Albert: *Arabic thought in the liberal age, 1798-1939, Oxford paperbacks, 197*, issued under the auspices of the Royal Institute of International Affairs [by] Oxford U.P [London, New York, 1970].
401. HOURANI, Albert: “Islam in European thought”, *THE TANNER LECTURES ON HUMAN VALUE* [Clare Hall, Cambridge University, 1989-2-30] [url: http://tannerlectures.utah.edu/_documents/a-to-z/h/hourani90.pdf] p. 225–287.
402. HOURANI, Albert: *Islam in European Thought*, Cambridge University Press [1992-7-31].
403. HOUZEL, Christian: “Euler”, *Encyclopedia Universalis* [1999].
404. HUBBARD, William Lines, George W. ANDREWS, Edward DICKINSON, et al.: *The American History and Encyclopedia of Music: Operas, with introd, by H. E. Krehbiel* 12 (vols.), I. Squire [1908].
405. HUFFMAN, Carl: “Pythagoras”, *Stanford Encyclopedia of Philosophy* [2006a] [url: <http://plato.stanford.edu/entries/pythagoras/>].
406. HUFFMAN, Carl: “Pythagoreanism”, *Stanford Encyclopedia of Philosophy* [2006b] [url: <http://plato.stanford.edu/entries/pythagoreanism/>].
407. HUFFMAN, Carl: “Philolaus”, *Stanford Encyclopedia of Philosophy* [2008] [url: <http://plato.stanford.edu/entries/philolaus/>].
408. HUFFMAN, Carl: “Archytas”, *Stanford Encyclopedia of Philosophy* [2011a] [url: <http://plato.stanford.edu/entries/archytas/>].
409. HUFFMAN, Carl: “Pythagoras”, *The Stanford Encyclopedia of Philosophy*, ed. Edward N. Zalta, ed. Fall 2011 [2011b] [url: <http://plato.stanford.edu/archives/fall2011/entries/pythagoras/>].
410. HUGGAN, Graham: “(Not) Reading ‘Orientalism’”, *Research in African Literatures* 36 3 [2005-10-1] [doi: 10.2307/3821368. url: <http://www.jstor.org/stable/3821368>] p. 124–136.
411. HUGHES, Andrew: “Ugolino: The Monochord and musica ficta”, *Musica Disciplina* 23 [1969-1-1] [url: <http://www.jstor.org/stable/20532043>] p. 21–39.
412. HUGHES, Andrew and Edith GERSON-KIWI: “Solmization”, *Grove Music Online* [2001].
413. HUNT, A. S.: “P.Oxy.XV 1786 / Oxyrhynchus Papyrus”, (3rd century) [1922] [url: <http://www.papyrology.ox.ac.uk/>].
414. HUSEBY, Gerardo V., Peter REIDEMEISTER and Mirko CAFFAGNI: “The Lute Worldwide 2”, *Early Music* 3 4 [1975-10-1] [url: <http://www.jstor.org/stable/3125413>] p. 387–391.
415. HYER, Brian: “Tonality”, *Grove Music Online* [2001].
416. IACOVOU, Maria: “The Greek exodus to Cyprus: The antiquity of Hellenism”, *Mediterranean Historical Review* 14 2 [1999-12-1] [doi: 10.1080/09518969908569756. url: <http://dx.doi.org/10.1080/09518969908569756>] p. 1–28.
417. ISMAIL, Adel: *Histoire du Liban du xviii^e siècle à nos jours (IV) – Redressement et déclin du féodalisme libanais (1840-1861) IV/VI* (vols.), Les Presses Harb Bijjani [Beyrouth – Liban, 1958-7-31].
418. JAIRAZBHOY, Nazir Ali: “What Happened to Indian Music Theory? Indo-Occidentalism?”, *Ethnomusicology* 52 3 [2008-10-1] [url: <http://www.jstor.org/stable/20174604>] p. 349–377.
419. JARUSTOVSKY, Boris: “Soviet Musicology”, *Acta Musicologica* 46 1 [1974-1] [doi: 10.2307/932477. url: <http://www.jstor.org/stable/932477?origin=crossref>] p. 50.
420. JENSEN, Claudia R.: “A Theoretical Work of Late Seventeenth-Century Muscovy: Nikolai Diletskii’s ‘Grammatika’ and the Earliest Circle of Fifths”, *Journal of the American Musicological Society* 45 2 [1992-7] [doi: 10.2307/831450. url: <http://jams.ucpress.edu/cgi/doi/10.2307/831450>] p. 305–331.
421. JOHNSON, C. D. L.: “‘He Has Made the Dry Bones Live’: Orientalism’s Attempted Resuscitation of Eastern Christianity”, *Journal of the American Academy of Religion* 82 3 [2014-9-1] [doi: 10.1093/jaarel/lfu036. url: <http://jaar.oxfordjournals.org/cgi/doi/10.1093/jaarel/lfu036>] p. 811–840.
422. JOHNSON, Charles W. L.: *Musical pitch and the measurement of intervals among the ancient Greeks*, by Charles W. L. Johnson,... thesis..., John Murphy & CO [1896].
423. JONES, A. H. M.: “The Hellenistic Age”, *Past & Present* 27 [1964] [url: <http://www.jstor.org/stable/649758>] p. 3–22.
424. JUL 6, 2015 and 586 929: “This animated map shows how religion spread across the world”, *Business Insider* [url: <http://www.businessinsider.com/map-shows-how-religion-spread-around-the-world-2015-6>].
425. JUSDANIS, Gregory: “Acropolis Now?”, *boundary* 2 23 1 [1996] [doi: 10.2307/303581. url: <http://www.jstor.org/stable/303581>] p. 185–193.
426. KALKBRENNER, Christian (1755-1806): *Histoire de la musique. Tome 1 / , par C. Kalkbrenner...*, A. Koenig (Paris) [1802a] [url: <http://gallica.bnf.fr/ark:/12148/bpt6k5695942x>].
427. KALKBRENNER, Christian (1755-1806): *Histoire de la musique. Tome 2 / , par C. Kalkbrenner...*, A. Koenig (Paris) [1802b] [url: <http://gallica.bnf.fr/ark:/12148/bpt6k5696016n>].
428. KALLENBACH-GRELLER, Lotte: “Die historischen Grundlagen der Vierteltöne”, *Archiv für Musikwissenschaft* 8 4 [1927] [doi: 10.2307/929814. url: <http://www.jstor.org/stable/929814>] p. 473–485.
429. KANFOH: 30-7-2012 | [لما بنا تشي](https://www.youtube.com/watch?v=Tm8cKnJkUt4) [url: <https://www.youtube.com/watch?v=Tm8cKnJkUt4>].
430. KARAMANOLIS, George: “Plutarch”, *Stanford Encyclopedia of Philosophy* [2010] [url: <http://plato.stanford.edu/entries/plutarch/>].
431. KARAS, Simon: *Μέθοδος Ἑλληνικῆς Μουσικῆς: Θεωρητικὴ [A method for Greek music: Theory] A/B* (vols.), ΣΥΛΛΟΓΟΣ ΠΡΟΣ ΔΙΑΔΟΣΙΝ ΤΗΣ ΕΘΝΙΚΗΣ ΜΟΥΣΙΚΗΣ [Association for the dissemination of national music] [Athens (Αθήνα), 1982a].
432. KARAS, Simon: *Μέθοδος Ἑλληνικῆς Μουσικῆς: Θεωρητικὴ [A method for Greek music: Theory] B/B* (vols.), ΣΥΛΛΟΓΟΣ ΠΡΟΣ ΔΙΑΔΟΣΙΝ ΤΗΣ ΕΘΝΙΚΗΣ ΜΟΥΣΙΚΗΣ [Association for the dissemination of national music] [Athens (Αθήνα), 1982b].
433. KARAS, Simon: “Ἀρμονικὰ [‘Harmonics’]”, ΣΥΛΛΟΓΟΣ ΠΡΟΣ ΔΙΑΔΟΣΙΝ ΤΗΣ ΕΘΝΙΚΗΣ ΜΟΥΣΙΚΗΣ [Association for the dissemination of national music] [Athens (Αθήνα), 1989].

434. KĀTĪB (AL-), Al-Hasan ibn Aḥmad ibn ‘Alī: *كتاب كمال أدب الغناء [Kitāb Kamāl Adab al-Ghinā’]*, editors Ghaṭṭās ‘Abd-al-Malik Khashaba, Mahmūd Aḥmad Hifnī (al-), and الهيئة المصرية للعلمة محمد أحمد الحفيىة *Al-Hay’a al-Miṣriyya al-‘Āmma li-l-Kitāb* [1975].
435. KEMP, Percy: “Désapprendre L’Orientalisme”, *Arabica* 31 1 [1984-1-1] [doi: 10.1163/157005884X00011. url: <http://booksandjournals.brillonline.com/content/journals/10.1163/157005884x00011>] p. 1–35.
436. KESKİNKILIÇ, Erdoğan and Ebubekir CEYLAN: “Her Majesty’s Protected Subjects: The Mishaqa Family in Ottoman Damascus”, *Middle Eastern Studies* 51 2 [2015-3-4] [doi: 10.1080/00263206.2014.934817. url: <http://dx.doi.org/10.1080/00263206.2014.934817>] p. 175–194.
437. KHALIDI, Rashid: *Resurrecting empire: western footprints and americas perilous path in the middle east*, I.B.Tauris [2004].
438. KHULĀ‘Ī (AL-), Muḥammad Kāmil: *كتاب كمال الخليلي : كتاب الموسيقى الشرقي Kitāb al-Mūsīqī a-sh-Sharqiyy [The book of oriental music / Le livre de la musique orientale]* [1904].
439. KHWAJA SHAMSU-D-DIN MUHAMMAD-I-HAFIZ-I-SHIRAZI: *Divan, Writen in the Fourteenth Century; 2 Vol. Set*, translator H. Wilberforce Clarke, Samuel Weiser [1970].
440. KHWAJA SHAMSU-D-DIN MUHAMMAD-I-HAFIZ-I-SHIRAZI: *Cent un ghazals amoureux*, translator Gilbert Lazard, Gallimard [2010].
441. KIESEWITTER, Raphael Georg: *Guido von Arezzo: Sein leben und wirken. Aus veranlassung und mit besonderer Rücksicht auf eine Dissertation: Sopra la vita, le opere ed il sapere di Guido d’Arezzo, von Luigi Angeloni. Nebst einem anhang über die dem heiligen Bernhard zugeschriebenen musikalischen Tractate*, Breitkopf und Härtel [1840].
442. KIESEWITTER, Raphael Georg: *Die Musik der Araber nach Originalquellen dargestellt, mit einem Vorworte von Jos. von Hammer-Purgstall: Mit VI. Abbildungen im Text und XXIV. Seiten Noten-Beilagen, welche die Tonformeln der alten Autoren, dann einige jetzt gangbare Volksweisen und Gesänge enthalten*, Breitkopf und Härtel [1842].
443. KIESEWITTER, Raphael Georg: *Über die Musik der neueren Griechen*, Breitkopf und Härtel [1858].
444. KIESEWITTER, Raphael Georg: *Die Musik der Araber*, 2nd ed. [Vaduz / Liechtenstein, 1988].
445. KIRCHER, Athanasius: *Musurgia Universalis Sive Ars Magna Consoni Et Dissoni In X. Libros Digesta Quà Vniuersa Sonorum doctrina, & Philosophia, Musicaeque tam Theoricae, quam practicae scientia, summa varietate traditur Qui continet In Lib. VIII. Musicam Mirificam. In Lib. IX. Magiam Consoni & Dissoni. In Lib. X. Harmoniam Mundi*, Corbelletti [1650] [url: http://archive.org/details/bub_gb_97xCAAACAAJ].
446. KIRCHER, Athanasius and Jacobus VIVA: *Athanasii Kircheri Fvldensis e Soc. Iesv presbyteri Mvsurgia vniuersalis: sive Ars magna consoni et dissoni, in X libros digesta*, Romae: Ex typographia Haeredum Francisci Corbelletti [1650] [url: <http://archive.org/details/athanasilkircherkirc>].
447. KITROMILIDES, Paschalis M.: “The Enlightenment and the Greek cultural tradition”, *History of European Ideas* 36 1 [2010-3-1] [doi: 10.1016/j.histeuroideas.2009.06.001. url: <http://dx.doi.org/10.1016/j.histeuroideas.2009.06.001>] p. 39–46.
448. KRISIKIS, Dimitri: *L’Empire ottoman*, Presses universitaires de France [Paris, 1985].
449. KOKKONIS, Georges and Markos SKOULIOS: “Théories et pratiques modales de l’Orient: un itinéraire”, *De la théorie à l’Art de l’improvisation: analyse de performances et modélisation musicale*, ed. Mondher Ayari, Delatour [Paris, 2005-12].
450. KONSTANDINOS (BYZANTIOS), Prōtopsaltēs: Ἐρμηνεία τῆς Ἐξωταρικῆς Μουσικῆς καὶ Ἐφαρμογῆ αὐτῆς εἰς τὴν καθ’ἑμῶς Μουσικὴν [Interpretation of the foreign Music and its adjustment to our Music], 1st ed., Œcumenical Patriarcat [Constantinople, 1843].
451. KONSTANTINIDIS, Antonis I.: *Study and designation of the fine intervals of the one tone (Studies 17)*, Thesis, Institute of Byzantine Musicology [Athens, 2011].
452. KOSACHEVA, Rimma: “Traditional Music in the Context of the Socio-Political Development in the USSR”, *Yearbook for Traditional Music* 22 [1990] [doi: 10.2307/767927. url: <http://www.jstor.org/stable/767927?origin=crossref>] p. 17.
453. KOTTICK, Edward L.: “Building a 15th-Century Lute”, *The Galpin Society Journal* 26 [1973-5-1] [doi: 10.2307/841115. url: <http://www.jstor.org/stable/841115>] p. 72–83.
454. KOUZINI, Maria-Eleni: *Regards sur la continuité de l’hellénisme chez les écrivains français du XX^{ème} siècle (1947-1967): une image de la Grèce reconstruite*, Phd thesis, Université Paul Valéry - Montpellier III [2012-12-19] [url: <https://tel.archives-ouvertes.fr/tel-00806847/document>].
455. KRAUT, Richard: “Plato”, *The Stanford Encyclopedia of Philosophy*, ed. Edward N. Zalta, ed. Spring 2015 [2015] [url: <http://plato.stanford.edu/archives/spr2015/entries/plato/>].
456. KUTINER, F. A.: “Prince Chu Tsai-Yü’s Life and Work: A Re-Evaluation of His Contribution to Equal Temperament Theory”, *Ethnomusicology* 19 2 [1975] p. 163–206.
457. KUTINER, Fritz A.: “The Music of China: A Short Historical Synopsis Incorporating the Results of Recent Musicological Investigations”, *Ethnomusicology* 8 2 [1964-5-1] [doi: 10.2307/849856. url: <http://www.jstor.org/stable/849856>] p. 121–127.
458. KUTINER, Fritz A.: “A Musicological Interpretation of the Twelve Lüs in China’s Traditional Tone System”, *Ethnomusicology* 9 1 [1965-1-1] [doi: 10.2307/850415. url: <http://www.jstor.org/stable/850415>] p. 22–38.
459. LA LETTRE DU MUSICIEN 401: “À propos de Jacques Chailley” [2016-5-14] [url: http://www.lalettredumusicien.fr/s/articles/826_110_a-propos-de-jacques-chailley].
460. LABORDE (DE), Jean-Benjamin: *Essai Sur La Musique Ancienne Et Moderne (1) 1/4* (vols.), Pierres / Onfroy [Paris, 1780a].
461. LABORDE (DE), Jean-Benjamin: *Essai Sur La Musique Ancienne Et Moderne (3) 3/4* (vols.), Pierres / Onfroy [Paris, 1780b].
462. LABUSSIÈRE, Annie: “Réflexions sur la modalité à partir de productions d’enfants d’âge scolaire”, *Musurgia, La modalité revisitée* 4 3 [1997-1-1] [url: <http://www.jstor.org/stable/40591307>] p. 81–118.
463. LĀDHIQĪ (AL-), Muḥammad ibn ‘Abd-al-Ḥamid: *الرسالة التقية (في)* *الحاج هاشم محمد الرجب (الموسيقا)*, محمد بن عبد الحميد اللاتقي and Ḥashim Muḥammad Rajab (a-r-) [1986, الكويت].
464. LADJILI, Myriam: “La musique arabe chez les compositeurs français du xix^e siècle saisis d’exotisme (1844-1914)”, *International Review of the Aesthetics and Sociology of Music* 26 1 [1995-6-1] [doi: 10.2307/836963. url: <http://www.jstor.org/stable/836963>] p. 3–33.
465. LALOY, Louis: *Aristoxène de Tarente et la musique de l’antiquité*, Paris, Société française d’imprimerie et de librairie [1904] [url: <http://archive.org/details/aristoxnedetar00lalo>].
466. LAMBERT, Jean, Samir MOKRANI and Centre français d’archéologie et de sciences sociales de Sanaa, eds.: *Quarbus, Tarab: le luth monoxyle & la musique du Yémen*, Geuthner; CEFAS [Paris: Sanaa, 2013].

467. LAND, J.P.N. and Abū-n-Naṣr Muḥammad ibn Muḥammad ibn Tarkhān FĀRĀBĪ (AL-): *Recherches sur l'histoire de la gamme arabe*, Brill |Leiden, 1884].
468. LANE, Edward William: *An account of the manners and customs of the modern Egyptians, written in Egypt during the years 1833, -34, and -35, partly from notes made during a former visit to that country in the years 1825, -26, -27, and -28 2/2* (vols.), C. Knight and co. |1836].
469. LANG, Paul Henry: *Music and history*, Poughkeepsie, N. Y. Vassar College |1953| [url: <http://archive.org/details/musichistory00lang>].
470. LATHAM, R. G.: *The Ethnology of the British Colonies and Dependencies*, John van Voorst |1851].
471. LAU, Lisa: "Re-Orientalism: The Perpetration and Development of Orientalism by Orientals", *Modern Asian Studies* 43 2 |2009| [url: <http://www.jstor.org/stable/20488093>] p. 571–590.
472. LAURENS, Henry: "« Les Français et les Anglais ont dessiné les frontières, et les Arabes ont colorié la carte »" |2016-5-16| [url: <http://www.lorientlejour.com/article/986144/-les-francais-et-les-anglais-ont-dessine-les-frontieres-et-les-arabes-ont-colorie-la-carte-.html>].
473. LAVIGNAC, Albert: *1.1 Encyclopédie de la musique et dictionnaire du conservatoire. 1,1, Encyclopédie de la musique et dictionnaire du conservatoire. première partie, Histoire de la musique. [1], Antiquité, Moyen-Age / Albert Lavignac, ... Lionel de La Laurencie, ...*, 1 1/5 (vols.), Delagrave (Paris) |Paris, 1921| [url: <http://gallica.bnf.fr/ark:/12148/bpt6k123719d>].
474. LAVISSE, Ernest (1842-1922): *Histoire de France: cours élémentaire / Ernest Lavisse, ...* |1913| [url: <http://gallica.bnf.fr/ark:/12148/bpt6k648847>].
475. LECKY, William Edward Hartpole: *History of European morals from Augustus to Charlemagne - Vol. II II/II* (vols.), D. Appleton and company |1869].
476. LEONI, Stefano A. E.: "Western Middle-East Music Imagery in the Face of Napoleon's Enterprise in Egypt: From Mere Eurocentric Exoticism, to Very Organized Orientalistic Ears / Zapadne glazbene slike Srednjega istoka u svjetlu Napoleonova pohoda na Egipat: od obične eurocentrične egzotike do vrlo organiziranih istočnjačkih usjiti", *International Review of the Aesthetics and Sociology of Music* 38 2 |2007-12-1| [url: <http://www.jstor.org/stable/25487524>] p. 171–196.
477. LEONTIS, Artemis: *Topographies of Hellenism: mapping the homeland*, Cornell University Press |1995].
478. LEOUSSI, Athena S.: "Nationalism and racial Hellenism in nineteenth-century England and France", *Ethnic and Racial Studies* 20 1 |1997-1-1| [doi: 10.1080/01419870.1997.9993947. url: <http://dx.doi.org/10.1080/01419870.1997.9993947>] p. 42–68.
479. LEVIN, Flora R.: "Synesis in Aristoxenian Theory", *Transactions and Proceedings of the American Philological Association* 103 |1972-1-1| [doi: 10.2307/2935976. url: <http://www.jstor.org/stable/2935976>] p. 211–234.
480. LEVIN, Theodore C.: "Music in Modern Uzbekistan: The Convergence of Marxist Aesthetics and Central Asian Tradition", *Asian Music* 12 1 |1980| [doi: 10.2307/833801. url: <http://www.jstor.org/stable/833801?origin=crossref>] p. 149.
481. LEVY, Kenneth and Christian TROELSGÅRD: "Byzantine Chant", editors Stanley Sadie and John Tyrrell, *The New Grove Dictionary of Music and Musicians - Vol. 4 - Barovski to Canobbio* 4/29 (vols.), Oxford University Press |Oxford, 2001| p. 734–755.
482. LEWIS, Bernard: "The Islamic guilds in the middle ages", *Journal of The Royal Central Asian Society* 27 4 |1940-10-1| [doi: 10.1080/03068374008730985. url: <http://dx.doi.org/10.1080/03068374008730985>] p. 462–465.
483. LEWIS, Bernard: *The Middle East and the West*, Weidenfield and Nicolson |1964].
484. LEWIS, Bernard: "The roots of Muslim rage", *The Atlantic Monthly* 266 3 |1990| p. 47–60.
485. LEWIS, Bernard: *The Arabs in History*, Oxford University Press |1993].
486. LEWIS, Bernard: "The Revolt of Islam", *The New Yorker* |2001-11-19| [url: <http://www.newyorker.com/magazine/2001/11/19/the-revolt-of-islam>].
487. LEWIS, Bernard: "La révolte de l'Islam", *Le Débat* 119 |2011-1-1| [url: http://www.cairn.info/resume.php?ID_ARTICLE=DEBA_19_0050] p. 50–67.
488. LINDLEY, Mark: "Equal temperament", *Grove Music Online* |2001a].
489. LINDLEY, Mark: "Temperaments", *Grove Music Online* |2001b| [url: <http://www.oxfordmusiconline.com/>].
490. LINDLEY, Mark: "Just intonation", *Grove Music Online* |2001c].
491. LINDLEY, Mark: "Well-tempered clavier", *Grove Music Online* |2001d].
492. LING, Jan: "Is 'World Music' the 'Classic Music' of Our Time?", *Popular Music* 22 2 |2003| [url: <http://www.jstor.org/stable/3877612>] p. 235–240.
493. LINGAS, Alexander: "Petros Byzantios", *Grove Music Online* |2007-2012].
494. LINO, Lisa: "Inheriting the Ghammāz-oriented Tradition: D'Erlanger and Aleppine Maqām Practice Observed", *Ethnomusicology Forum* 18 2 |2009-11-1| [doi: 10.2307/27808679. url: <http://www.jstor.org/stable/27808679>] p. 261–280.
495. LISHKE, André: "Les conditions historiques de l'exotisme musical français", *L'exotisme musical français*, Slatkine |Genève, 1981| p. 59–66.
496. LITCHFIELD, Malcolm: "Aristoxenus and Empiricism: A Reevaluation Based on His Theories", *Journal of Music Theory* 32 1 |1988-4-1| [doi: 10.2307/843385. url: <http://www.jstor.org/stable/843385>] p. 51–73.
497. LLOYD, L. S.: "Just Temperament", *Music & Letters* 20 4 |1939-10-1| [url: <http://www.jstor.org/stable/728456>] p. 365–373.
498. LLOYD, L. S.: "The Myth of Equal Temperament", *Music & Letters* 21 4 |1940-10-1| [url: <http://www.jstor.org/stable/727311>] p. 347–361.
499. LLOYD, L. S.: "The A Priori Theorist and Music", *Music & Letters* 26 2 |1945-4-1| [url: <http://www.jstor.org/stable/727109>] p. 97–102.
500. LOCKE, Ralph P.: "Beyond the Exotic: How 'Eastern' Is Aida?", *Cambridge Opera Journal* 17 2 |2005-7-1| [url: <http://www.jstor.org/stable/3878257>] p. 105–139.
501. LOCKE, RALPH P.: "A Broader View of Musical Exoticism", *The Journal of Musicology* 24 4 |2007-10-1| [url: <http://www.jstor.org/stable/10.1525/jm.2007.24.4.477>] p. 477–521.
502. LORTAT-JACOB, Bernard: "F. Harrison, Time, Place and Music. An Anthology of Ethnomusicological Observation c. 1550 to c. 1800", *L'Homme* 15 1 |1975| [url: http://www.persee.fr/doc/hom_0439-4216_1975_num_15_1_367544] p. 144–145.
503. LUGHOD, Ibrahim Abu and Rashid KHALIDI: *The Arab Rediscovery of Europe: A Study in Cultural Encounters*, Saqi Books |London, UK, 2011-8-1].

504. LUNN, Henry C.: "The History of Musical Notation", *The Musical Times and Singing Class Circular* 12 278 [1866-4-1] [doi: 10.2307/3354152. url: <http://www.jstor.org/stable/3354152>] p. 261–263.
505. LUTSKY, Vladimir Borisovich: *Modern History of the Arab Countries, U.S.S.R. Academy Of Sciences - Institute of the Peoples of Asia*, Progress [Moscow, 1969] [url: <http://archive.org/details/ModernHistoryOfTheArabCountries>].
506. MAALOUF, Amin: *Les croisades vues par les Arabes*, J'ai lu [1983].
507. MAALOUF, Shireen: *History of Arabic Music Theory, change and continuity in the Tone Systems, Genres, and Scaled.*, Universite Saint-Esprit de Kaslik [Kaslik - Lebanon, 2002].
508. MAALOUF, Shireen: "Mikhā'il Mishāqā: Virtual Founder of the Twenty-Four Equal Quartertone Scale", *Journal of the American Oriental Society* 123 4 [2003] [url: <http://www.jstor.org/stable/3589971>] p. 835–840.
509. MACLEOD, Roy M.: *The Library of Alexandria: Centre of Learning in the Ancient World*, Revised Edition, I.B.Tauris [2004-9-4].
510. MAHDĪ (AL-), Muḥammad Ṣāliḥ al-mahdi: *La musique arabe: structures, historique, organologie*, Alphonse Leduc [Paris, 1972].
511. MAHDĪ (AL-), Muḥammad Ṣāliḥ: *مقالات المهدي: مقدمات الموسيقى العربية [Maqāmāt al-Mūsīqā al-'Arabīyya]*, Ma' al-Fann wa-l-Fannānīn 3, المعهد الرشيدى للموسيقى التونسية Al-Ma'had a-r-Rashidī li-l-Mūsīqā a-t-Tūnisīyya [تونس - السداي - تونس] Tunis, 1982].
512. MAHMŪD, 'Alī and Sāmi SHAWWĀ (A-SH-): *Yā Nasīma-ṣ-Ṣabā* [s.d.].
513. MAKDISI, Ussama: "Ottoman Orientalism", *The American Historical Review* 107 3 [2002a] [doi: 10.1086/532495. url: <http://www.jstor.org/stable/10.1086/532495>] p. 768–796.
514. MAKDISI, Ussama: "After 1860: Debating Religion, Reform, and Nationalism in the Ottoman Empire", *International Journal of Middle East Studies* 34 4 [2002b-11-1] [url: <http://www.jstor.org/stable/3879690>] p. 601–617.
515. MAKRIIS, Eustathios: "The chromatic scales of the Deuterios modes in theory and practice", *Plainsong and Medieval Music* 14 01 [2005-5] [doi: 10.1017/S0961137104000075. url: <http://www.journals.cambridge.org/abstract/S0961137104000075>] p. 1–10.
516. MALEK, Nicolas: *Kyrie Ekekraxa – extrait en version grecque, mixé avec le résultat de l'analyse par le logiciel Praat*, Windows PCM (.wav), Comp. Petros (Byzantios) and Mitri Murr (al-), CDA-001 [Mansourieh - Liban, 2011a-3-2].
517. MALEK, Nicolas: *Kyrie Ekekraxa – extrait en version arabe, mixé avec le résultat de l'analyse par le logiciel Praat*, Windows PCM (.wav), Comp. Petros (Byzantios), CDA-002 [Mansourieh - Liban, 2011b-3-2].
518. MANGO, Cyril: "Byzantinism and Romantic Hellenism", *Journal of the Warburg and Courtauld Institutes* 28 [1965-1-1] [doi: 10.2307/750662. url: <http://www.jstor.org/stable/750662>] p. 29–43.
519. MANIK, Liberty: *Das arabische Tonsystem im Mittelalter*, Tuta Sub Aegide Pallas, E.J. Brill [Leiden, 1969].
520. MANTRAN, Robert: "Universalis: OTTOMAN EMPIRE" [2012] [url: <http://www.universalis-edu.com/encyclopedie/empire-ottoman/>].
521. MARTYNOV, Ivan: "On Soviet Musicology", *Acta Musicologica* 60 3 [1988-9] [doi: 10.2307/932756. url: <http://www.jstor.org/stable/932756?origin=crossref>] p. 306.
522. MASHĀQA, Mikhā'il: "Ms. A-r-Risālā a-sh-Shihābiyya fi-ṣ-Ṣinā'a al-Mūsīqīyya – رسالة الشهابية – OBS 1741 (D 3) 38 F⁶⁹ [Couvent Saint-Sauveur – Joun, s.d. (xix^e siècle)].
523. MASHĀQA, Mikhā'il: *A-r-Risālā a-sh-Shihābiyya fi-ṣ-Ṣinā'a al-Mūsīqīyya*, editor Louis Ronzevalle, Imprimerie Catholique مطبعة الآباء اليسوعيين [Beyrouth, 1899-12-31].
524. MASHĀQA, Mikhā'il: *Mashhad al-Iyān bi-Ḥawādith Sūriyya wa Lubnān* [1908].
525. MASHĀQA, Mikhā'il: *Un traité de musique arabe moderne – Version française (avec reproduction de l'original arabe) de A-r-Risālā a-sh-Shihābiyyah fi-ṣ-Ṣinā'a al-Mūsīqīyya [The Shihabi treatise of the musical art]*, editor Louis Ronzevalle, translator Louis Ronzevalle, Imprimerie Catholique [Beyrouth, 1913].
526. MASHĀQA, Mikhā'il: *A-r-Risālā a-sh-Shihābiyya fi-ṣ-Ṣinā'a al-Mūsīqīyya*, editor Isis Faṭḥ-al-Lāh Jabrāwī إيزيس فتح الله جبرولي [Dār al-Fikr al-'Arabīyy [Le Caire, 1996].
527. MASHĀQA, Mikhā'il and Eli SMITH: "A Treatise on Arab Music, Chiefly from a Work by Michail Meschakah of Damascus", *Journal of the Oriental American Society* 1 3 [1849-1847 selon JSTOR] p. 171 + 173-217.
528. MATHIESEN, Thomas J.: "An Annotated Translation of Euclid's 'Division of a Monochord'", *Journal of Music Theory* 19 2 [1975] p. 236–258.
529. MATHIESEN, Thomas J.: "Hermes of Clío? The Transmission of Ancient Greek Music Theory", *Musical Humanism and Its Legacy: Essays in Honor of Claude V. Palisca*, ed. Nancy Kovaleff Baker and Barbara Russano Hanning, *Festschrift* 11, Pendragon Press [1992].
530. MATHIESEN, Thomas J.: *Apollo's lyre: Greek music and music theory in antiquity and the Middle Ages*, University of Nebraska Press [Nebraska - EU, 1999].
531. MAZZA, Suzan: "Finding the Missing Link in the Talent Gap", *Halogen Software Talent Management Blog* [2013-10-23] [url: <http://www.halogensoftware.com/blog/finding-the-missing-link-in-the-talent-gap>].
532. MCCLAIN, Ernest G.: *The Pythagorean Plato: prelude to the song itself*, N. Hays;;distributed by Great Eastern Book Co. [Stony Brook N.Y. ;Boulder Colo., 1977].
533. MCCLAIN, Ernest G.: *The myth of invariance: the origin of the gods, mathematics, and music from the Ṛg Veda to Plato*, Taylor & Francis [1978-10-12].
534. MEEÛS, Nicolas: *Théorie modale – Moyen Âge et Renaissance, Cours pour les étudiants en 2^e année de Master*, Université Paris Sorbonne [2005].
535. MEIBOM, Marcus: *Antiquae Musicae Auctores Septem: Graece Et Latine. Aristeidu Kointilianu Peri Musikēs*, Elzevirius [1652].
536. MENESTRIER, Claude François: *Des représentations en musique anciennes et modernes*, chez Robert Pepie [1685].
537. MERLIER, Melpō (Melpo): "La chanson populaire grecque", *Acta Musicologica* 32 2/3 [1960-4-1] [doi: 10.2307/931656. url: <http://www.jstor.org/stable/931656>] p. 68–77.
538. MERRIAM, Alan P.: *The anthropology of music*, Northern Western University Press [EU, 1964].
539. MEYER, Christian: "La tradition du Micrologus de Guy d'Arezzo. Une contribution à l'histoire de la réception du texte", *Revue de Musicologie* 83 1 [1997-1-1] [doi: 10.2307/947028. url: <http://www.jstor.org/stable/947028>] p. 5–31.
540. MEYER, Eve R.: "Turquerie and Eighteenth-Century Music", *Eighteenth-Century Studies* 7 4 [1974-7-1] [doi: 10.2307/3031600. url: <http://www.jstor.org/stable/3031600>] p. 474–488.
541. MEYSAMI, Hoseyn (Seyyed): *Musiqi-e asr-e Safavi*, Matn [Tehran, 2010-1389 H].
542. MIRAMON-BONHOURE, Jeanne and Amine BEYHOM: "Praat: Petit manuel pratique pour débutants – 1^{ère} partie: Analyses de

- systèmes intervalliques et d'échelles V 1.0.3", Université Paris Sorbonne |2010-9|.
543. MISAELEIDIS, Misael: Νέον Θεωρητικόν Συντομώτατον ἤτοι παρὶ τῆς καθ' ἑμῶς Ἐκκλησιαστικῆς καὶ Ἀρχαίας Ἑλληνικῆς Μουσικῆς (Neon Theoretikon 1) [The New Concise Theory or about our Ecclesiastical and Ancient Greek Music] – Volume 2 2/2 (vols.), Publié à compte d'auteur |Athens (Ἀθήναι), 1902|.
544. MOHAFAZ, Arash and Jean DURING: *Approche comparative des systèmes musicaux classiques persan et turc. Origines, devenirs et enjeux*, Doctorat 3e cycle, Paris-Ouest (Nanterre), Paris-Lumières (UPL) |Nanterre, France, .
545. MOLOKOTOS-LIEDERMAN, Lina: "Identity crisis: Greece, orthodoxy, and the European Union", *Journal of Contemporary Religion* 18 3 |2003-10-1| [doi: 10.1080/13537900310001601677. url: http://dx.doi.org/10.1080/13537900310001601677] p. 291–315.
546. MONTAGU, Jeremy: "The Oldest Organ in Christendom", *FoMRHIQ, Pub. by the Author with add. details* 35 534 |1984-4|.
547. MOODY, Ivan: "Some Current Areas of Research in Orthodox Chant and Their Impact on Performance", *Medieval sacred chant: from Japan to Portugal = Canto sacro medieval: do Japão a Portugal*, ed. Manuel Pedro Ferreira, Edições Colibri: Centro de Estudos de Sociologia e Estética Musical |Lisboa, 2008| p. 111–123.
548. MORCOM, Anna: Unity and discord: *Music and politics in contemporary Tibet*, Tibet Information Network |s.l., s.d.|.
549. MORDTMANN, J. H. and H. W. DUDA: "Ewliyā Ćlebi", *Encyclopédie de l'Islam, Brill Online* |2012|.
550. MORGAN, Maureen M.: "The 'Three Teachers' and Their Place in the History of Greek Church Music", *Studies in Eastern chant*, ed. Egon Wellesz and Miloš M. Velimirović, Oxford Univ. Press |London & others, 1971| p. 86–99.
551. MOUNTFORD, J. F.: "The Musical Scales of Plato's Republic", *The Classical Quarterly* 17 3/4 |1923-7-1| [url: http://www.jstor.org/stable/635635] p. 125–136.
552. MURR (AL-), Fu'ād (Di-)Mitri: *Al-Kunūz al-Mūsīqīyya al-Bizantiyya*, منشورات معهد التقدير بوحنا المنشقي اللاهوتي - جمعة البلمند Ma'had al-Qiddis Yūhanna a-d-Dimashqi |Balamand – Liban, 1981|.
553. NEUBAUER, Eckhard: "Der Bau der Laute und ihre Besaitung nach arabischen, persischen und türkischen Quellen des 9. bis 15. Jahrhunderts", *Zeitschrift für Geschichte der Arabisch-Islamischen Wissenschaften*, Institut für Geschichte der Arabisch-Islamischen Wissenschaften an der Johann Wolfgang Goethe-Universität |Frankfurt am Main, 1993| p. 279–378.
554. N'KRUMAH, Kwame: *Africa Must Unite*, FREDERICK A. PRAEGER |New York, 1963|.
555. NORWICH, John Julius: *Histoire de Byzance: 330-1453*, Perrin |1999|.
556. OLIVIER PLATTEAU: *Tout va très bien, Madame la Marquise* |2011-1-19| [url: https://www.youtube.com/watch?v=T5WdpSPeQUE].
557. OLLEY, Jacob: "Modal diversity in early Ottoman music: the case of *makâm Sabâ'*", *Near Eastern Musicology Online* 1 1 |2012-11| [url: http://nemo-online.org/articles] p. 39–54.
558. VAN OOSTRUM, Anne H.: "Barbat: Encyclopaedia of Islam, THREE: Brill Online", *Encyclopaedia of Islam, THREE* [url: http://www.brillonline.nl/subscriber/tuid=2022/entry?result_number=9&entry=e3_COM-23474&fields_1=content&search_text_row_1=%60ud&search_mode_1=%2B&row_id=1#hit].
559. ORTHODOXWIKI: "Autonomy" |2010a-4-21| [url: http://orthodoxwiki.org/Autonomy].
560. ORTHODOXWIKI: "Autocephaly" |2010b-12-28| [url: http://orthodoxwiki.org/Autocephaly].
561. ORTHODOXWIKI: "List of autocephalous and autonomous churches" |2012-11-29| [url: http://orthodoxwiki.org/List_of_autocephalous_and_autonomous_churches].
562. OWEN, Barbara, Peter WILLIAMS and Stephen BICKNELL: "Organ", *Grove Music Online* |2007-2012|.
563. PACHYMERES, Georgios and BACCHIUS L'ANCIEN: *Notice sur divers manuscrits grecs relatifs à la musique, comprenant une traduction française et des commentaires: Extrait de la 2e partie du Tome XVI des Notices et extraits des manuscrits de la Bibliothèque du Roy ...*, editor Alexandre Joseph Hidulphé Vincent, translator Alexandre-Joseph-Hidulphé Vincent, Imprimerie royale |1847|.
564. PALISCA, C. V.: "Introductory Notes on the Historiography of the Greek Modes", *The Journal of Musicology* 3 3 |1984| p. 221–228.
565. PANN, Alton: *Bazul teoretic și practic al muzicii bisericești sau Gramatica melodică* |Bucarest, 1846|.
566. PAPACHRISTOPOULOS, Ioannis: "Das Verhältnis von Textinhalt und Musikgestaltung im griechischen Kirchengesang", *Acta Musicologica* 81 2 |2009| p. 301–352.
567. PARISOT, Jean (1862-): *Musique orientale: Conférence prononcée dans la salle de la Société Saint-Jean, le 28 février 1898*, Schola Cantorum |Paris, 1898|.
568. PASLER, Jann: "Musical Hybridity in Flux: Representing Race, Colonial Policy, and Modernity in French North Africa, 1860s-1930s", *Afrika Zamani: revue annuelle d'histoire africaine = annual journal of African history* 20-21 |2012| p. 21–68.
569. PATRIARCAT ŒCUMÉNIQUE: "Petros Byzantios" |2012-8-5| [url: http://www.ec-patr.net/en/history/petros-byzantios.htm].
570. PENNANEN, Risto Pekka: "The Nationalization of Ottoman Popular Music in Greece", *Ethnomusicology* 48 1 |2004-1-1| [url: http://www.jstor.org/stable/30046238] p. 1–25.
571. PÉRÈS, Henri: "L'Institut D'Égypte Et L'Œuvre De Bonaparte Jugés Par Deux Historiens Arabes Contemporains", *Arabica* 4 2 |1957-1-1| [doi: 10.1163/157005857X00354. url: http://booksandjournals.brillonline.com/content/journals/10.1163/157005857x00354] p. 113–130.
572. PERRET, Denise: "The Lute Worldwide-3", *Early Music* 4 2 |1976-4-1| [url: http://www.jstor.org/stable/3125551] p. 239–241.
573. PERRETT, Wilfrid: "The Heritage of Greece in Music", *Proceedings of the Musical Association* 58 |1931-1-1| [url: http://www.jstor.org/stable/765649] p. 85–103.
574. PHILIPP, Thomas: "Class, Community, and Arab Historiography in the Early Nineteenth Century--The Dawn of a New Era", *International Journal of Middle East Studies* 16 2 |1984-5-1| [url: http://www.jstor.org/stable/163097] p. 161–175.
575. PHINNEY, Archie: "Racial Minorities in the Soviet Union", *Pacific Affairs* 8 3 |1935-9| [doi: 10.2307/2751475. url: http://www.jstor.org/stable/2751475?origin=crossref] p. 321.
576. PIERCE, John R.: *The science of musical sound*, Scientific American Library: Distributed by W.H. Freeman |New York, 1983|.
577. PIOTROWSKA, Anna G.: "'Gypsy music' as music of the Other in European culture", *Patterns of Prejudice* 47 4-5 |2013-9-1| [doi: 10.1080/0031322X.2013.846615. url: http://dx.doi.org/10.1080/0031322X.2013.846615] p. 395–408.
578. PISTONE, Danièle: "Les conditions historiques de l'exotisme musical français", *L'exotisme musical français*, Slatkine |Genève, 1981| p. 11–22.
579. PLATO: "The Internet Classics Archive | The Republic by Plato" |s.d.| [url: http://classics.mit.edu/Plato/republic.html].
580. PLATO: The Timaeus of Plato: Plato: Free Download & Streaming: Internet Archive [url: http://www.archive.org/details/timaeusofplato00platala].

581. PLUTARCH: *Peri mousikēs*, editor Rudolph Westpahl, translator Rudolf Westpahl, Breslau, F. E. C. Leuckart [1865] [url: <http://archive.org/details/ploutarchouperi00westgoogl>].
582. PLUTARQUE (0046?-0120?): *De la Musique / Plutarque*, editors Henri Weil (1818-1909) and Théodore Reinach (1860-1928), Ernest Leroux [Paris, 1900] [url: <http://gallica.bnf.fr/ark:/12148/bpt6k486063k>].
583. POCHÉ, Christian: “Üd”, *Grove Music Online* [2001] p. 25–31.
584. PONTE, Joseph Perry and AURELIAN (OF REOME): Aureliani Reomensis Musica disciplina: a revised text, translation, and commentary, Brandeis University. [1961].
585. POWERS, Harold S., Frans WIERING, James PORTER, et al.: “Mode”, *The New Grove Dictionary of Music and Musicians* 16/29 (vols.), Oxford University Press [Oxford, 2001].
586. PRAKASH, Gyan: “Orientalism Now”, *History and Theory* 34 3 [1995] [doi: 10.2307/2505621. url: <http://www.jstor.org/stable/2505621>] p. 199–212.
587. PRATT, Waldo Selden: *History of music, the*, G. Schimmer, Inc. [New York, 1907].
588. PRATT, Waldo Selden: *The history of music: a handbook and guide for students*, Forgotten Books [1927].
589. PUCHALA, Donald J.: “Colonisation and Cultural Resistance: Egypt and Iran after Alexander”, *Global Society* 16 1 [2002-1-1] [doi: 10.1080/09537320120111889. url: <http://dx.doi.org/10.1080/09537320120111889>] p. 7–30.
590. QIFĪ (IBN AL-), Jamāl-a-d-Dīn Abū-l-Ḥasan Alī Ibn Yūsuf, August MÜLLER and Julius LIPPERT: *Tārīkh al-Ḥukamāʾ*, Dieterich [1903] [url: <http://archive.org/details/TarikhAlHukama>].
591. QRĪFA (KRĪAA), Muḥammad al-Asʿad (Lasaad): تحقيق الرسالة الشريفة في النسب التاليفية لصفى الدين الأرموي البغدادي: تحقيق ونشر Sharafīyya fi-n-Nisab a-t-Taʿlīfīyya li-Ṣafīyy-a-d-Dīn al-Urmawī], editor Mahmoud Guettat, A-n-Najma a-z-Zahrāʾ (منشورات النجمة) [إسديني بوسعيد/ تونس], Sidi Bousaid (Tunisie 2009).
592. RAASTED, Jørgen: *Intonation formulas and modal signatures in Byzantine musical manuscripts*, E. Munksgaard [Copenhagen, 1966].
593. RACY, A.J., University of ILLINOIS and University Microfilms INTERNATIONAL: *Musical change and commercial recording in Egypt, 1904-1932*, University of Illinois at Urbana-Champaign [1977].
594. RACY, Ali Jihad: “Musicologues comparatistes européens et musique égyptienne au Congrès du Caire”, *Musique arabe: le congrès du Caire de 1932*, CEDEJ [Le Caire - Egypte, 1992] p. 109–122.
595. RAGHIB, Mahmoud: “Descriptions d’orgues données par quelques anciens auteurs turcs”, *Revue de Musicologie* 10 30 [1929-5-1] [doi: 10.2307/925415. url: <http://www.jstor.org/stable/925415>] p. 99–104.
596. RAGHIB, Mahmoud: “Descriptions d’orgues données par quelques anciens auteurs turcs. II”, translator Eugène Borrel, *Revue de Musicologie* 11 36 [1930-11-1] [doi: 10.2307/926188. url: <http://www.jstor.org/stable/926188>] p. 260–264.
597. RAGHIB, Mahmoud: “Descriptions d’orgues par des Auteurs Turcs et Persans (III)”, translator Eugène Borrel, *Revue de Musicologie* 14 45 [1933-2-1] [doi: 10.2307/926487. url: <http://www.jstor.org/stable/926487>] p. 16–23.
598. RAGHIB, Mahmoud and Eugène BORREL: “Descriptions d’orgues par des Auteurs Turcs et Persans (IV). Fin”, *Revue de Musicologie* 14 46 [1933-5-1] [doi: 10.2307/925450. url: <http://www.jstor.org/stable/925450>] p. 86–91.
599. RAMEAU, Jean-Philippe: *Generation harmonique, ou Traité de musique theorique et pratique*, Prault fils [Paris, 1737] [url: <http://archive.org/details/generationhammon00rame>].
600. RAMEAU, Jean-Philippe (1683-1764): *Traité de l’harmonie reduite à ses principes naturels; divisé en quatre livres. Livre I. Du rapport des raisons & proportions harmoniques. Livre II. De la nature & de la propriété des accords; et de tout ce qui peut servir à rendre une musique parfaite. Livre III. Principes de composition. Livre IV. Principes d’accompagnement. Par monsieur Rameau...* [1722] [url: <http://gallica.bnf.fr/ark:/12148/btv1b86232459>].
601. RASHED, Roshdi: *Encyclopedia of the History of Arabic Science*, Routledge [2002-9-11].
602. RASHĪD, Ṣubḥī Anwar: *Tārīkh al-ʿÜd*, Dār ʿAlāʾu-d-Dīn [Damas - Syrie, 1999].
603. REICHMUTH, Stefan: “Facets of Orientalism: Introductory Remarks”, *Die Welt des Islams* 45 3 [2005] [url: <http://www.jstor.org/stable/20140696>] p. 307–311.
604. REINHARD, Ursula and Kurt REINHARD: *Musique de Turquie, Les Traditions musicales* (Paris), ISSN 1274-9303 [1996].
605. RICE, Eric: “Representations of Janissary music (Mehter) as musical exoticism in western compositions, 1670-1824”, *Journal of Musicological Research* 19 1 [1999] [doi: 10.1080/01411899908574768. url: [http://www.informaworld.com/openurl?genre=article&doi=10.1080/01411899908574768&magic=crossref\[D404A21C5BB053405B1A640AFFD44AE3\]](http://www.informaworld.com/openurl?genre=article&doi=10.1080/01411899908574768&magic=crossref[D404A21C5BB053405B1A640AFFD44AE3])] p. 41–88.
606. RICHMOND, Helen, Gusta GOLDSCHMIDT, Donna CURRY and G. H.: “The Lute Worldwide-1”, *Early Music* 3 2 [1975-4-1] [url: <http://www.jstor.org/stable/3125982>] p. 199–205.
607. RINGER, A. L.: “On the Question of ‘Exoticism’ in 19th Century Music”, *Studia Musicologica Academiae Scientiarum Hungaricae* 7 1/4 [1965-1-1] [doi: 10.2307/901419. url: <http://www.jstor.org/stable/901419>] p. 115–123.
608. RITTER, Steven E.: “Bringing Byzantium to Light: a Conversation with Alexander Lingas of Cappella Romana (First published in Fanfare Magazine on Tuesday, 12 October 2010)” [2010-10-15] [url: <http://mybyzantine.wordpress.com/2010/10/15/bringing-byzantium-to-light-a-conversation-with-alexander-lingas-of-cappella-romana/>].
609. ROBINSON, Thomas W.: “The Soviet Union and Asia in 1980”, *Asian Survey* 21 1 [1981-1] [doi: 10.2307/2643662. url: <http://as.ucpress.edu/cgi/doi/10.2307/2643662>] p. 14–30.
610. ROCKSTRO, William Smith: *A general history of music from the infancy of the Greek drama to the present period*, Scribner & Welford [New York, 1886] [url: <http://www.archive.org/details/cu31924022262533>].
611. ROGAN, Eugene L.: *The Arabs: a history*, ed. First Edition, Basic Books [New York, 2009-11-3].
612. RÖMANOU, Kaitē: “A new approach to the work of Chrysanthos of Madytos: the New Method of musical notation in the Greek church”, *Studies in Eastern chant*, ed. Dimitri E. Conomos, Oxford Univ. Press [London & others, 1990] [url: Oxford University Press] p. 89–100.
613. ROUSSEAU, Jean-Jacques: *Lettre sur la Musique française* [1753].
614. ROUSSIER, Pierre J.: *Mémoire Sur La Musique Des Anciens, Où l’on expose le Principe des Proportions authentiques, dites de Pythagore, & de divers Systèmes de Musique chez les Grecs, les Chinois & les Egyptiens: Avec un Parallèle entre le Système des Egyptiens & celui des Modernes*, Paris, Lacombe [1770] [url: <http://archive.org/details/mmoiresurlamusi00rous>].
615. ROY, Martha: “Mutations dans la musique égyptienne: une question majeure au Congrès de musique arabe”, *Musique arabe: le congrès du Caire de 1932*, CEDEJ [Le Caire - Egypte, 1992] p. 32–35.

616. RUSHTON, Julian: "Quarter-Tone", *Grove Music Online*, *Grove Music Online*, Oxford Music Online [2001].
617. SABRA, Wadia: *La musique arabe base de l'art occidental*, Imprimerie Catholique |Beyrouth, 1941].
618. SACHS, Curt: "Zum Kongress für Arabische Musik-Kairo 1932: Die Marokkaner", *Zeitschrift für Vergleichende Musikwissenschaft* 1 [1933] p. 17–18.
619. SACHS, Curt: "Prolégomènes a une préhistoire musicale de l'Europe", *Revue de Musicologie* 17 57 [1936-1-1] [doi: 10.2307/926451. url: <http://www.jstor.org/stable/926451>] p. 22–26.
620. SACHS, Curt: *The History of Musical Instruments - Curt Sachs* [1940] [url: http://archive.org/details/the_history_of_musical_instrument_s_curt_sachs].
621. SACHS, Curt: *The rise of music in the ancient world, East and West*, W. W. Norton & company, inc. |EU, 1943].
622. SACHS, Curt: "A Strange Medieval Scale", *Journal of the American Musicological Society* 2 3 [1949-10] [doi: 10.2307/829718. url: <http://jams.ucpress.edu/cgi/doi/10.2307/829718>] p. 169–170.
623. SACHS, Curt: *The wellsprings of music*, Martinus Nijhoff |The Hague, 1962].
624. SACHS, Ignacy: "Du Moyen Âge à nos jours: européo-centrisme et découverte du Tiers Monde", *Annales. Histoire, Sciences Sociales* 21 3 [1966] [doi: 10.3406/ahess.1966.421392. url: http://www.persee.fr/web/revues/home/prescript/article/ahess_0395-2649_1966_num_21_3_421392] p. 465–487.
625. SACHS, Ignacy: *La découverte du Tiers Monde*, Flammarion [1971].
626. SACHS, Ignacy: *The discovery of the Third world*, translator Michael Fineberg, MIT Press |Cambridge, Mass, 1976].
627. ŞAFIYY-A-D-DİN 'ABD-AL-MU' MIN IBN YŪSUF IBN (AB-ĪL-MA)FĀKHİR (AL-) صفي الدين الأرموي URMAWĪ (D. 1294): *Kitāb al-Adwār*, editor Hāshim Muḥammad Rajab (a-r-), *Silsilat Kutub a-t-Turāth*, ISSN 1811-4040 192 |Baghdad, 1980].
628. SAID, Edward: *Orientalism*, Pantheon Books [1978].
629. SAID, Edward: *L'orientalisme: l'Orient créé par l'Occident*, Éditions du Seuil |Paris, 1980].
630. SAID, Edward W.: "Orientalism Reconsidered", *Cultural Critique* 1 [1985] [doi: 10.2307/1354282. url: <http://www.jstor.org/stable/1354282>] p. 89–107.
631. SALAPPA-ELIOPOULOU, ATHENA: "MUSIC EVOLUTION IN ANCIENT GREECE AND THE VALUE OF MUSIC EDUCATION", *ΣΧΟΛΗ, Polytechnic School, University of Patras* 6 1 [2012] [url: <http://www.nsu.ru/classics/schole/6/schole-6-1.pdf#page=76>] p. 76–86.
632. SALEM, Norma: "Nouvelles perspectives sur l'Islam en politique", *Études internationales* 16 2 [1985] [doi: 10.7202/701843ar. url: <http://id.erudit.org/iderudit/701843ar>] p. 409.
633. SALVADOR-DANIEL, Francisco: "La musique arabe: ses rapports avec la musique grecque et le chant grégorien", *Revue africaine, Journal des travaux de la société historique algérienne, Bastide, libraire-éditeur* 6 31 [1862a-1] p. 32–45.
634. SALVADOR-DANIEL, Francisco: "La musique arabe: ses rapports avec la musique grecque et le chant grégorien", *Revue africaine, Journal des travaux de la société historique algérienne, Bastide, libraire-éditeur* 6 32 [1862b-3] p. 106–115.
635. SAUVEUR, Joseph: *Rapport des sons des cordes d'instruments de musique, aux flèches des cordes; et nouvelle détermination des sons fixes*. Par M. Sauveur, de l'Imprimerie royale [1716].
636. SAVAS, Savas I.: *Byzantine music in theory and in practice*, Hercules Press |Boston, 1965].
637. SAYGUN, Ahmed Adnan: "La Musique Turque", editor Roland-Manuel, *Histoire de la musique Tome I - Des Origines à Jean-Sébastien Bach, Encyclopédie de la Pléiade* 1/2 (vols.), Gallimard |Paris, 2001] p. 573–617.
638. SCHAEFFNER, Andre: *Origine des Instruments de Musique*, Ecole des Hautes Etudes en Sciences Sociales |Chateau-Gontier, France, 1994].
639. SCHAEFFNER, André: *Variations sur la musique*, Fayard |Paris, 1998].
640. SCHARTAU, B. and C. TROELSGÅRD: "The Translation of Byzantine Chants into the 'New Method': Joasaph Pantokratorinos-Composer and Scribe of Musical Manuscripts", *Acta Musicologica* 69 2 [1997] p. 134–142.
641. SCHLESINGER, Kathleen: "Further Notes on Aristoxenus and Musical Intervals", *The Classical Quarterly* 27 2 [1933-4-1] [url: <http://www.jstor.org/stable/636812>] p. 88–96.
642. SCHLESINGER, Kathleen and HG FARMER: "Is European Musical Theory Indebted to the Arabs?: Reply to 'The Arabian Influence On Musical Theory' by HG Farmer, H. Reeves [1925].
643. SEEBASS, Tilman: "Notation and Transmission in European Music History", *Garland Encyclopedia of World Music Volume 8: Europe*, Routledge |United Kingdom, 2000] [url: <http://glnd.alexanderstreet.com/View/331721#page2>] p. 49–57.
644. SEEGER, Charles: "Prescriptive and Descriptive Music-Writing", *The Musical Quarterly* 44 2 [1958-4-1] [url: <http://www.jstor.org/stable/740450>] p. 184–195.
645. SHAWQĪ, Yūsuf and رسالة ابن المنجم في الموسيقى وكتف رموز يوسف شوقي: *إقتاب الأغاني*, مطبعة دار الكتب [1976].
646. SHILOAH, Amnon and Annie BERTHIER: "A propos d'un 'petit livre arabe de musique'", *Revue de Musicologie* 71 1/2 [1985-1-1] [doi: 10.2307/928598. url: <http://www.jstor.org/stable/928598>] p. 164–177.
647. SIGNELL, Karl L.: "The modernization process in two oriental music cultures: Turkish and Japanese", *Asian Music* 7 2 [1976] p. 72–102.
648. SIGNELL, Karl L.: "Mozart and the Mehter", *Turkish Music Quarterly* 1 1 [1988] p. 9–15.
649. SIGNELL, Karl L.: *Makam: modal practice in Turkish art music*, Usul |Nokomis (FL), 2004].
650. SKOULIOS, Markos: "Modern theory and notation of Byzantine chanting tradition: a Near-Eastern musicological perspective", *Near Eastern Musicology Online* 1 1 [2012-11] [url: <http://nemo-online.org/articles>] p. 19–38.
651. SLEZKINE, Yuri: "Imperialism As the Highest Stage of Socialism", *The Russian Review* 59 2 [2000-4-1] [doi: 10.1111/0036-0341.00118. url: <http://onlinelibrary.wiley.com/doi/10.1111/0036-0341.00118/abstract>] p. 227–234.
652. SLOBIN, Mark: "Music of Central Asia and of the Volga-Ural Peoples. Teaching Aids for the Study of Inner Asia No. 5." [1977] [url: <http://eric.ed.gov/?id=ED295874>].
653. SLONIMSKY, Nicolas: "The Changing Style of Soviet Music", *Journal of the American Musicological Society* 3 3 [1950-10] [doi: 10.2307/829735. url: <http://jams.ucpress.edu/cgi/doi/10.2307/829735>] p. 236–255.
654. SOLIE, Ruth A.: "Melody and the Historiography of Music", *Journal of the History of Ideas* 43 2 [1982-4-1] [doi: 10.2307/2709205. url: <http://www.jstor.org/stable/2709205>] p. 297–308.
655. SOLOMON, Jon: "Towards a history of tonoi", *The Journal of Musicology* 3 3 [1984] p. 242–251.
656. SOLOMON, Jon: "Cleonides", *Grove Music Online* [2001].

657. SPENCER, Herbert: *Essays: Scientific, Political and Speculative*, Longman, Brown, Green, Longmans, & Roberts [London, 1858a].
658. SPENCER, Herbert: “The origin and function of music”, *Essays: Scientific, Political and Speculative*, Longman, Brown, Green, Longmans, & Roberts [London, 1858b] p. 359–384.
659. STAFFORD, William Cooke: *Histoire de la musique*, Paulin [Paris, 1832].
660. STALIN, I: *Works Vol. 2, Vol. 2*, Foreign Languages Pub. House, Lawrence and Wishart, [sl., 1953].
661. STALIN, Joseph and A FINEBERG: *Marxism and the national and colonial question*, International Publishers [New York, 1935].
662. STATHIS, Gregorios Th.: “Byzantine Church Music”, *psaltiki: the Online Journal 1 1* [1970-5-18] [url: http://www.psaltiki.net/journal/1.1/stathes_bcm/bcm.html] p. 1–7.
663. STATHIS, Gregorios Th.: “An Analysis of the Sticheron [...] by Germanos, Bishop of New Patras [The Old ‘Synoptic’ and the New ‘Analytical’ Method of Byzantine Notation]”, *Studies in Eastern chant*, ed. Miloš M. Velimirović, Oxford Univ. Press [London & others, 1979] [url: Oxford University Press] p. 177–227.
664. STATHIS, Gregorios Th.: “Prologue” [2012-6-3] [url: <http://stanthonysmonastery.org/music/Prologue.htm>].
665. STOBART, J. C. (John Clarke) and R. J. (Robert John) HOPPER: *The glory that was Greece: a survey of Hellenic culture and civilization*, Philadelphia: J.B. Lippincott [1915] [url: http://archive.org/details/glorythatwasgree00stob_0].
666. STRANGWAYS, Arthur Henry Fox: “Exotic Music”, *Music & Letters 6 2* [1925-4-1] [url: <http://www.jstor.org/stable/726089>] p. 119–127.
667. STRUNK, Oliver: “The Tonal System of Byzantine Music”, *The Musical Quarterly 28 2* [1942] p. 190–204.
668. STRUNK, Oliver: “Intonations and Signatures of the Byzantine Modes”, *The Musical Quarterly 31 3* [1945] p. 339–355.
669. STRUNK, Oliver: “Byzantine Psalmody and Its Possible Connection with Hebraic Cantillation”, *Bulletin of the American Musicological Society 11/12/13* [1948] [url: <http://www.jstor.org/stable/829264>] p. 19–21.
670. STRUNK, Oliver: “The Antiphons of the Oktoechos”, *Journal of the American Musicological Society 13 1/3* [1960] p. 50–67.
671. STRUNK, Oliver: “A Cypriote in Venice”, *Natalicia Musicologica*, ed. Knud Jeppesen, Wilhelm Hansen et. al. [Copenhagen, 1962] p. 101–113.
672. SWAN, Alfred J.: “The Znamenny Chant of the Russian Church—Part I”, *The Musical Quarterly 26 2* [1940-4-1] [url: <http://www.jstor.org/stable/738849>] p. 232–243.
673. ṬAḤḤĀN (IBN A-Ṭ- ~ AL-MŪSIQĪ), Abū-l-Ḥusayn Muḥammad ibn al-Ḥasan al-Ḥusaynī: *Ḥāwī al-Funūn wa-Salwat al-Maḥzūn [transcription dactylographiée de Zakariyyā Yūsuf]*, Al-Majma‘ al-‘Arabiyy li-l-Mūsiqā [Baghdad, 1976].
674. ṬAḤḤĀN (IBN A-Ṭ- ~ AL-MŪSIQĪ), Abū-l-Ḥusayn Muḥammad ibn al-Ḥasan al-Ḥusaynī: *Compendium of a Fatimid court musician – Ḥāwī al-Funūn wa-Salwat al-Maḥzūn* [Reproduction du manuscrit Funūn Jamīla 539 de la Bibliothèque nationale, Dār al-Kutub, du Caire], editor Eckhard Neubauer, Facsimile Editions; 52, Institut für Geschichte der Arabisch-Islamischen Wissenschaften [Frankfurt am Main, 1990].
675. TAHRIR KHALIL HAMDĪ: “Edward Said and Recent Orientalist Critiques”, *10.13169 Arab Studies Quarterly 35 2* [2013] p. 130–148.
676. TANNER, Robert: La musique antique grecque expliquée par une conséquence de la théorie psycharithmétique, 248, Richard-Masse [1961].
677. TANNERY, Paul: “Inauthenticité de la ‘Division du canon’ attribuée à Euclide”, *Comptes-rendus des séances de l’Académie des Inscriptions et Belles-Lettres 48 4* [1904] [doi: 10.3406/crai.1904.19877. url: http://www.persee.fr/web/revues/home/prescript/article/crai_0065-0536_1904_num_48_4_19877] p. 439–445.
678. TANSUĞ, Feza: “Rauf Yekta Bey et le nationalisme de la musique turque”, editor Georges Kokkonis, *Études balkaniques, Création musicale et nationalismes dans le Sud-Est européen 13* [2007-4-1] [url: <http://etudesbalkaniques.revues.org/index331.html>] p. 171–184.
679. TAPPER, Thomas and Percy GOETSCHUIS: *Essentials in Music History*, New York, C. Scribner’s sons [1914] [url: <http://archive.org/details/essentialsinmusi00tapp>].
680. TARUSKIN, Richard: “Entoiling the Falconet: Russian Musical Orientalism in Context”, *Cambridge Opera Journal 4 3* [1992-11-1] [url: <http://www.jstor.org/stable/823694>] p. 253–280.
681. TAYLOR, Charles Lewis: “The Discovery of the Third World. By Ignacy Sachs. (Cambridge, MA: The MIT Press, 1976. Pp. xi, 287. \$14.95.)”, *The Journal of Politics 40 01* [1978-2] [doi: 10.2307/2129998. url: http://journals.cambridge.org/article_S0022381600059302] p. 255–256.
682. TERRY, R. R.: “The Music of the Byzantine Liturgy”, *Proceedings of the Musical Association 35* [1908-1-1] [url: <http://www.jstor.org/stable/765672>] p. 53–67.
683. THÉON DE SMYRNE and Jean DUPUIS: *Exposition des connaissances mathématiques utiles pour la lecture de Platon / Théon de Smyrne, ... ; traduite pour la première fois du grec en français par J. Dupuis*, Hachette (Paris) [1892] [url: <http://gallica.bnf.fr/ark:/12148/bpt6k994572>].
684. THEON, of Smyrna and Eduard HILLER: *Theonis Smyrnaei, philosophi platonici, Expositio rerum mathematicarum ad legendum Platonem utilium*, Lipsiae, B. G. Teubneri [1878] [url: <http://archive.org/details/theonissmymaei00theogoo>].
685. THEON and Christos TOULIS: Mathematics useful for understanding Plato, Secret doctrine reference series, Wizards Bookshelf [San Diego, 1979].
686. THIBAUT (FR.), Joannès: “La musique byzantine et le Chant liturgique des Grecs modernes (en trois parties)”, *La Tribune de Saint-Gervais; revue musicologique de la Schola Cantorum*, ed. Charles Bordes and G. Boisjolin (de), Schola Cantorum [Paris, 1898] [url: <http://archive.org/details/latribunedesaint190612pari>] p. 220–225, 241–248, 269–276.
687. TIBY, Ottavio: “La Musique des Civilisations Gréco-Latines”, editor Roland-Manuel, *Histoire de la musique Tome I - Des Origines à Jean-Sébastien Bach, Encyclopédie de la Pléiade 1/2* (vols.), Gallimard [Paris, 2001] p. 377–450.
688. TILLYARD, Henry Julius Wetenhall: “Mediaeval Byzantine Music”, *The Musical Quarterly 23 2* [1937-4-1] [url: <http://www.jstor.org/stable/738676>] p. 201–209.
689. TODOROVA, Maria: “The Balkans: From Discovery to Invention”, *Slavic Review 53 2* [1994] [doi: 10.2307/2501301. url: <http://www.jstor.org/stable/2501301?origin=crossref>] p. 453.
690. TODOROVA, Maria: *Imagining the Balkans*, Oxford University Press [1997].
691. TODOROVA, Maria: *Imagining the Balkans*, Oxford University Press [2009-3-18].
692. TOLAN, John: “Lex alterius: Using Law to Construct Confessional Boundaries”, *History and Anthropology 26 1* [2015-1-1] [doi: 10.1080/02757206.2014.933104. url: <http://dx.doi.org/10.1080/02757206.2014.933104>] p. 55–75.

693. TOULIATOS, Diane: "Research in Byzantine Music Since 1975", *Acta Musicologica* 60 3 |1988| [doi: 10.2307/932752. url: <http://www.jstor.org/stable/932752>] p. 205–228.
694. TOULIATOS-BANKER, Diane: "State of the Discipline of Byzantine Music", *Acta Musicologica* 50 1/2 |1978-1-1| [doi: 10.2307/932291. url: <http://www.jstor.org/stable/932291>] p. 181–192.
695. TREFFLICH, Comelia: *Edward Said's Orientalism*, GRIN Verlag |2011-1|.
696. TRIO BULGARKA: *The Forest Is Crying*, Audio CD HNCD 1342, Hannibal |1988|.
697. TRUESDELL, C. and Murray CAMPBELL: "Sauveur, Joseph", *Grove Music Online* |2001| [url: <http://www.oxfordmusiconline.com/subscriber/article/grove/music/24644?q=Bernoulli&search=q&quick&pos=5&start=1#firsthit>].
698. TURNER, E. G.: "Oxyrhynchus and Its Papyri", *Greece & Rome* 21 63 |1952-10-1| [url: <http://www.jstor.org/stable/640886>] p. 127–137.
699. UNIVERSALIS, Encyclopædia: "JACQUES CHAILLEY", *Encyclopædia Universalis* |2016-5-14| [url: <http://www.universalis.fr/encyclopedie/jacques-chailley/>].
700. URMAWĪ (D. 1294), Şafiyî-a-d-Dîn 'Abd-al-Mu'min ibn Yūsuf ibn (ab-ī-l-Ma)Fākhir (al-) *الرسالة الشرفية في النسب التليفية* [A-r-Risāla a-sh-Sharafiyya fi-n-Nisab a-t-Ta'lifiyya], editor Hāshim Muḥammad Rajab (a-r-), *Silsilat Kutub a-t-Turāth*, ISSN 1811-4040 119, Dār a-r-Rashid li-n-Nashr (دار الرشيد للنشر) |Baghdad, 1982|.
701. URMAWĪ (D. 1294), Şafiyî-a-d-Dîn 'Abd-al-Mu'min ibn Yūsuf ibn (ab-ī-l-Ma)Fākhir (al-) 1 *صفي الدين الارموي*: Kitāb al-Adwār fi-l-Mūsīqā [*Livre des cycles musicaux* – MS. Istanbul, Nuruosmaniye 3653, f^o 1a-49a (1r^o-49r^o), possiblement autographe] 2. A-r-Risāla a-sh-Sharafiyya fi-n-Nisab a-t-Ta'lifiyya [L'épître à Sharaf-a-d-Dīn sur les proportions musicales – MS. Ahmet III 3460, f^o 1a-68a (1r^o-68r^o), copie datant de 827H/1424C], editor Eckhard Neubauer, (معهد تاريخ العلوم العربية والإسلامية) Institut für Geschichte der Arabisch-Islamischen Wissenschaften |Frankfurt am Main, 1984|.
702. URMAWĪ (D. 1294), Şafiyî-a-d-Dîn 'Abd-al-Mu'min ibn Yūsuf ibn (ab-ī-l-Ma)Fākhir (al-) *صفي الدين الارموي*: "Kitāb al-Adwār – ljs235", [D. 1293, XIII^e siècle] |2001| [url: <http://sceti.library.upenn.edu/ljscollection/index.cfm>, <http://dewey.library.upenn.edu/sceti/ljs/PageLevel/index.cfm?ManID=ljs235>].
703. URMAWĪ (D. 1294), Şafiyî-a-d-Dîn 'Abd-al-Mu'min ibn Yūsuf ibn (ab-ī-l-Ma)Fākhir (al-) *صفي الدين الارموي*: *Risālah-ī sharafiyyah* [A-r-Risāla a-sh-Sharafiyya fi-n-Nisab a-t-Ta'lifiyya], Farhangistān-i Hunar/Iranian Academy of Arts |Tīhrān, 2005|.
704. URMAWĪ (D. 1294), Şafiyî-a-d-Dîn 'Abd-al-Mu'min ibn Yūsuf ibn (ab-ī-l-Ma)Fākhir (al-) *صفي الدين الارموي* and 'Alī ibn Muḥammad [JURJĀNĪ (AL-)]: *La musique arabe (3) – I. A-sh-Sharafiyya ou Épître à Sharaf a-d-Dīn. II. (Commentaire anonyme du) Kitāb al-Adwār ou Livre des Cycles musicaux*, translator Rodolphe (d') Erlanger, ed. orig., *La Musique Arabe* 3/6 (vols.), Librairie Orientaliste Paul Geuthner |Paris, 1938|.
705. URMAWĪ (D. 1294), Şafiyî-a-d-Dîn 'Abd-al-Mu'min ibn Yūsuf ibn (ab-ī-l-Ma)Fākhir (al-) *صفي الدين الارموي* and 'Alī ibn Muḥammad [JURJĀNĪ (AL-)]: *La musique arabe (3) – I. A-sh-Sharafiyya ou Épître à Sharaf a-d-Dīn. II. (Commentaire anonyme du) Kitāb al-Adwār ou Livre des Cycles musicaux*, editor Christian Poché, translator Rodolphe (d') Erlanger, ed. 2^e en fac-similé, *La Musique Arabe* 3/6 (vols.), Librairie Orientaliste Paul Geuthner |Paris, 2001|.
706. VADAC: "A map of the British Empire in 1921 when it was at its height, just before the Anglo-Irish Treaty of 1921." |2008-8-27| [Own work. url: https://commons.wikimedia.org/wiki/File:British_Empire_1921.png].
707. VALOGNES, Jean-Pierre: *Vie et mort des chrétiens d'Orient: des origines à nos jours*, Fayard |Paris|, 1994|.
708. VASUNIA, Phiroze: "Hellenism and Empire: Reading Edward Said", *Parallax* 9 4 |2003-10-1| [doi: 10.1080/1353464032000142390. url: <http://dx.doi.org/10.1080/1353464032000142390>] p. 88–97.
709. VATIKIOTIS, P. J.: "The Greek Orthodox Patriarchate of Jerusalem between Hellenism and Arabism", *Middle Eastern Studies* 30 4 |1994-10-1| [doi: 10.1080/00263209408701029. url: <http://dx.doi.org/10.1080/00263209408701029>] p. 916–929.
710. VATIKIOTIS, P. J.: "The Modern History of Egypt (London, 1969)", *Vatikiotis197The Modern History of Egypt* |1969| p. 197.
711. VAUX, Bernard Carra (de): "Le traité des rapports musicaux ou l'épître à Scharaf ed-Dīn. Par Safī ed-Dīn 'Abd el-Mumin Albaghdādī [L'épître à Sharaf-a-d-Dīn par Safiyî-a-d-Dīn 'Abd-al-Mu'min al-Baghdādī]", *Journal Asiatique ou recueil de mémoires d'extraits et de notices relatifs à l'histoire, à la philosophie, aux langues et à la littérature des peuples orientaux XVIII* |1891-10| p. 279–355.
712. VELMIROVIĆ, Miloš M.: "Musique byzantine", editor Jacques Porte, *Encyclopédie des musiques sacrées* 2/3 (vols.), Éditions Labergerie |Paris, 1968a| p. 145–164.
713. VELMIROVIĆ, Miloš M.: "HJW Tillyard, Patriarch of Byzantine Studies", *The Musical Quarterly* 54 3 |1968b| p. 341–351.
714. VIATOR, C. S.: *Histoire de France et Notions d'Histoire générale précédées d'un résumé d'histoire ancienne grecque et romaine conforme aux programmes officiels: Cours supérieur: récits, biographies, résumés, cartes...*, E. Robert; A. Pigureau; C. Puech |Fontaine-sur-Saone; Paris; Rodez, 1887|.
715. VIGREUX, Philippe: "II- Le Congrès de Musique arabe du Caire dans la presse égyptienne (janvier-juin 1932)", *Musique arabe: le congrès du Caire de 1932*, CEDEJ |Le Caire - Egypte, 1992| p. 225–434.
716. VIGREUX, Philippe and Scheherazade Qassim HASSAN: *Musique arabe: le congrès du Caire de 1932*, CEDEJ |Le Caire - Egypte, 1992|.
717. VILLOTEAU, Guillaume André: *De l'art musical en Égypte, ou, Relation historique et descriptive des recherches et observations faites sur la musique en ce pays, Description de l'Égypte, ou, Recueil de observations et des recherches qui ont été faites en Égypte pendant l'expédition de l'armée française* |1809|.
718. VILLOTEAU, Guillaume André: *De l'état actuel de l'art musical en Égypte, ou relation historique et descriptive des recherches et observations faites sur la musique en ce pays, 2nd ed., Description de l'Égypte, ou Recueil des observations et des recherches qui ont été faites en Égypte pendant l'expédition de l'armée française État Moderne* 14/, Impr. de Charles Louis Fleury Panckoucke |France, 1826|.
719. VINOGRADOV, Victor: "The Study of Folk Music in the U. S. S. R.", *Journal of the International Folk Music Council* 12 |1960| [doi: 10.2307/835440. url: <http://www.jstor.org/stable/835440?origin=crossref>] p. 73.
720. VOLTAIRE: *Candide, ou L'optimisme*, Marc-Michel Rey |1759|.
721. WACHSMANN, Klaus, James W. MCKINNON, Robert ANDERSON, et al.: "Lute", *Grove Music Online* |2007-2012|.
722. WALLASCHEK, Richard: *Primitive Music: An Inquiry Into the Origin and Development of Music, Songs, Instruments, Dances ...*, Longmans, Green, and Co. |1893| [url: <http://archive.org/details/primitivemusica00wallgoog>].
723. WARRAQ, Ibn: *Defending the West: A Critique of Edward Said's Orientalism*, Prometheus Books |Amherst - New-York, 2007|.

724. WELLESZ, Egon: "Byzantine Music", *Proceedings of the Musical Association* 59 [1932-1-1] [url: <http://www.jstor.org/stable/765709>] p. 1-22.
725. WELLESZ, Egon: *A history of Byzantine music and hymnography*, 2nd ed., Clarendon Press [1980].
726. WIKIPEDIA CONTRIBUTORS: "Église grecque orthodoxe", *Wikipédia*, Wikimedia Foundation, Inc. [2012a-4-9] [url: http://fr.wikipedia.org/w/index.php?title=%C3%89glise_grecque_orthodoxe&oldid=76683066].
727. WIKIPEDIA CONTRIBUTORS: "Evliya Çelebi", *Wikipedia, the free encyclopedia*, Wikimedia Foundation, Inc. [2012b-4-20] [url: <http://en.wikipedia.org/w/index.php?title=Evliya.%C3%87elebi&oldid=488350713>].
728. WIKIPEDIA CONTRIBUTORS: "Orthodox Church organization", *Wikipedia, the free encyclopedia* [2012c-11-29] [url: http://en.wikipedia.org/w/index.php?title=Orthodox_Church_organization&oldid=525606761].
729. WIKIPEDIA CONTRIBUTORS: "Première République hellénique", *Wikipédia* [2013a-7-16] [url: https://fr.wikipedia.org/w/index.php?title=Premi%C3%A8re_R%C3%A9publique_hell%C3%A9nique&oldid=90685437].
730. WIKIPEDIA CONTRIBUTORS: "Élection au trône de Grèce (1822-1832)", *Wikipédia* [2013b-7-25] [url: [https://fr.wikipedia.org/w/index.php?title=%C3%89lection_au_tr%C3%B4ne_de_Gr%C3%A8ce_\(1822-1832\)&oldid=94686823](https://fr.wikipedia.org/w/index.php?title=%C3%89lection_au_tr%C3%B4ne_de_Gr%C3%A8ce_(1822-1832)&oldid=94686823)].
731. WIKIPEDIA CONTRIBUTORS: "Trois Glorieuses", *Wikipédia* [2013c-7-25] [url: https://fr.wikipedia.org/w/index.php?title=Trois_Glorieuses&oldid=94582486].
732. WILLIAMS, W. G. and Ian HARWOOD: "Lute Construction and Playing", *Early Music* 3 2 [1975-4-1] [url: <http://www.jstor.org/stable/3125976>] p. 177-185.
733. WINGELL, Richard Joseph and HUCBALD (OF SAINT-AMAND): *The "De Harmonica Institutione" of Hucbald of St. Amans: A Critical Translation and Commentary*, Holy Names College [1971].
734. WINNINGTON-INGRAM, R. P.: "Aristoxenus and the Intervals of Greek Music", *The Classical Quarterly* 26 3-4 [1932] [doi: 10.1017/S0009838800014415. url: <http://journals.cambridge.org/action/displayAbstract?fromPage=online&aid=3616620>] p. 195-208.
735. WONG, Deborah: "Sound, Silence, Music: Power", *Ethnomusicology* 58 2 [2014] [doi: 10.5406/ethnomusicology.58.2.0347. url: <http://www.jstor.org/stable/10.5406/ethnomusicology.58.2.0347>] p. 347-353.
736. WOODARD, Kathryn.: "Music Mediating Politics in Turkey: The Case of Ahmed Adnan Saygun", *Comparative Studies of South Asia, Africa and the Middle East* 27 3 [2007] [url: http://muse.jhu.edu/journals/comparative_studies_of_south_asia_africa_and_the_middle_east/v027/27.3woodard.html] p. 552-562.
737. WOODS, Henry Charles: *The danger zone of Europe: changes and problems in the Near East*, Boston: Little, Brown [1911] [url: <http://archive.org/details/dangerzoneofeuro00woodrich>].
738. WRIGHT, Owen: *The modal system of Arab and Persian music, 1250-1300: an interpretation of contemporary texts* [1969].
739. WRIGHT, Owen: *The modal system of Arab and Persian music: A.D. 1250-1300 28/*, Oxford University Press |Oxford [Eng.]; New York, 1978].
740. WRIGHT, Owen: "Kindi, al-", *Grove Music Online* [2001a].
741. WRIGHT, Owen: "Fārābī, al- in Oxford Music Online" [2001b] [url: <http://www.oxfordmusiconline.com/subscriber/article/grove/music/00548?q=al-F%C4%81r%C4%81b%C4%AB&search=quick&pos=12&start=1#firsthit>].
742. WRIGHT, Owen: "Ibn Sinā", *Grove Music Online* [2001c].
743. WYSCHNEGRADSKY, Ivan: *Manuel d'harmonie à quarts de ton*, Éditions Max Eschig [1980-1933].
744. YARMAN, Ozan: *79-Tone Tuning & Theory for Turkish Maqam Music - as a solution to the non-conformance between current model and practice*, Istanbul Technical University - Institute of Social Sciences [Istanbul - Turquie, 2008-6].
745. YEKTA, Rauf: "La musique turque", editor Albert Lavignac, *Encyclopédie de la musique et dictionnaire du conservatoire - Première partie: Histoire de la musique 1.5/2.6 (vols.)*, Delagrave [Paris, 1922] [url: <http://gallica.bnf.fr/ark:/12148/bpt6k1237270>] p. 2945-3064.
746. YŪSUF, Zakariyyā: (الشفاء، مثنوق. 3، مسق (جامع علم موسقا. 3، مسق) ed. Al-Maṭba'a al-Amiriyya [1956].
747. ZACHS, Fruma: "Mikhā'il Mishāqa—The First Historian of Modern Syria", *British Journal of Middle Eastern Studies* 28 1 [2001-5-1] [url: <http://www.jstor.org/stable/826195>] p. 67-87.
748. ZACHS, Fruma: "Osmanli Tarihçileri – MİHA'İL MİSHAQA" [2005-8] [url: http://www.ottomanhistorians.com/database/html/mishaqa_en.html].
749. ZANNOS, Iannis: "Intonation in Theory and Practice of Greek and Turkish Music", *Yearbook for Traditional Music* 22 [1990-1-1] [doi: 10.2307/767931. url: <http://www.jstor.org/stable/767931>] p. 42-59.
750. ZANNOS, Ioannis: *Ichos und Makam 74/*, Verlag für systematische Musikwissenschaft [1994].
751. ZOUARI, Mohamed Zied, Nicolas MEEÛS and UNIVERSITÉ DE PARIS-SORBONNE: *Mutation du langage musical tunisien à travers le temps: essai d'une étude empirique sur le tba' Rasd Dhil* [2007].
752. أبو نصر محمد بن محمد بن ترخان الفارابي: *كتاب الموسيقى الكبير*، محمود أحمد الحنفي. [1967] *Turāthunā*.
753. الأصفهاني، أبي الفرج: *كتاب الأغاني*، *Encyclopedies*، دار الثقافة |بيروت - لبنان. |1990
754. الحنفي، محمود أحمد: (AL-) Maḥmūd Aḥmad ḤIFNĪ and علم الآلات الموسيقية، الهيئة المصرية العامة للكتاب |مصر، 1987.
755. الفارابي: *كتاب الموسيقى الكبير*، *Manuscript*، معهد تاريخ العلوم العربية والإسلامية في إطار جامعة فرانكفورت، [إقرانكفورت]، جمهورية ألمانيا الاتحادية، 1998.
756. برهان، محمد حسين بن خلف تبريزي and معين، محمد: *برهان قاطع Burhān-i qāṭi'*، مكتبة روشني ابن سننا، |تهران، 1963.
757. قسطنطين، محمود: *آلة العود بين نقه العلم وأسرار الفن*، سلطنة عمان، وزارة الإعلام، مركز عمان للموسيقى التقليدية، [2006] [url: <http://books.google.com/books?id=mluIPwAACAAJ>].

Contents of the dossier

FOREWORD	53
Prefatory remarks	54
1. A REMINDER ON ANCIENT GREEK MUSIC THEORIES AND THEIR IMPLEMENTATION IN OCCIDENTAL AND ARABIAN MUSICOLOGICAL LITERATURE	55
Container intervals and means: the original tetrad and the tetraktys	56
Genera (tetrachords).....	58
Restricted acceptance of Ancient Greek theories in Occidental musicological literature.....	60
<i>Genera and tetrachords in Occidental theories and music literature.....</i>	<i>61</i>
Pro-ditonic (and pro-Hellenistic) arguments – And their refutal	63
“ <i>Ancient Greece is not Oriental</i> ”	63
“ <i>Enharmonism and other non-ditonic forms are unattractive, difficult (impossible to sing), if not perverted music</i> ”.....	64
“ <i>Ditonicism is the most advanced stage of evolution of Ancient Greek music, i.e. superior to all other forms</i> ”	67
Further refutal of (some) pro-ditonic arguments and misconceptions about Ancient Greek music	68
<i>On Greek and Arabian tetrachords and genera (and Aristoxenos’ “equal-temperament”)</i>	<i>69</i>
<i>On Pitch perception.....</i>	<i>71</i>
<i>On “Mobile, stable, fluctuant” notes and “glissandi”</i>	<i>72</i>
<i>On Choir singing – or Heterophony reconstructed</i>	<i>73</i>
<i>Conclusions on Greek theories in their restricted application by Occidental Scholars</i>	<i>77</i>
Greek theories in Arabian writings	78
<i>The ‘ūd as the “Monochord” of the Early and Middle Islamic theoreticians</i>	<i>79</i>
<i>Short conclusion on Greek theories in Arabian thought.....</i>	<i>80</i>
2. MUSIC HISTORY (OR “THE HISTORY OF MUSIC [S]”) IN THE 19TH-20TH CENTURIES.....	81
How the West saw the East before (near-) World domination	81
The clash of cultures	83
Three stages (?) of the History of (World’s) Music in the 19 th century.....	86
(World-Wide) Evolutionary(?) Music History	88
<i>Erratic inclusions (or exclusions) of “Foreign musics”</i>	<i>89</i>
The “ethnomusicological” approach	92
3. “MUSICOLOGICAL” THEORIES ON THE FORMATION OF THE SCALE	95
Equal-temperament and Pythagoreism, two struggling creeds of 18 th -20 th -centuries music in the West.....	95
The “superior structuring role” of the octave – Or do we really need it?	97
The cycle of fifths.....	102
<i>Shortcomings of the theory of the cycle of fifths as a particular theory of the formation of the Occidental tonal scale</i>	<i>105</i>
<i>Additionally: Complete inadequacy of the theory of the cycle of fifths as a generalized theory of the formation of the scale.....</i>	<i>106</i>
The theory of Acoustic resonance.....	106
<i>Discrepancies between theories</i>	<i>108</i>
<i>Why the Acoustic resonance theory cannot be a generative theory of the ditonic scale.....</i>	<i>109</i>
FOREWORD ON MUSICOLOGICAL ORIENTALISM / BYZANTINISM – AND TRANSITION	111
4. MUSICOLOGICAL BYZANTINISM AND ITS CONSEQUENCES	115
Romantic Hellenism and Philhellenism in the 19 th -20 th centuries.....	117
Byzantine chant under Ottoman rule and its transformations in Greece in the 19 th century and the Early 20 th century – A short overview	121
<i>Byzantine chant transformations in Greece in the 19th and the beginning of the 20th centuries.....</i>	<i>122</i>
The reasons underlying the reforms of Byzantine chant in the 19 th century	124
<i>The reasons for the First Reform.....</i>	<i>124</i>
<i>The reasons for the Second Reform</i>	<i>126</i>
The theory of the First Reform.....	127
<i>Mikhā’īl Mashāqa’s epistle and the “Byzantine division of the octave” (as compared to the “Arabian” 24-quarter-tones division)</i>	<i>129</i>
<i>Chrysantine theory of the scale explained from an Occidental / Oriental point of view.....</i>	<i>131</i>
Towards the modification of Chrysantine theory.....	135

<i>Bourgault-Ducoudray and Germanos Aphonidēs – Or an insight of Byzantinism in operation</i>	136
The Second Reform – A radical change in the conception of Byzantine chant theory	139
<i>The theoretical system of the Second Reform</i>	140
Errors, approximations and breaches in the statements of the Music Committee	145
<i>Interval measurement is not an exact science</i>	146
<i>Did the Second Reform reach its stated objectives?</i>	146
Re-Byzantinism	147
<i>Straightforward Re-Byzantinism</i>	149
Conclusions on Byzantine musicology	151
INTERLUDE	152
5. ORIENTALISM IN MUSIC AND MUSICOLOGY, AND CONSEQUENCES	153
Musical orientalism	154
<i>Re-orientalism in music</i>	155
Musicological Orientalism	158
<i>Maqām-musicology as a reflection of Western Orientalism</i>	158
<i>The “fretting” of the Arabian ‘ūd – or Sequencing Musicological Orientalism</i>	159
The Soviet alternative?	163
<i>Soviet Music policy in the former U.S.S.R.</i>	164
Consequences of Musicological Orientalism	167
<i>Musicological Re-Orientalism: a multifaceted phenomenon</i>	168
<i>Afterword to musicological Orientalism</i>	174
6. CONCLUSIONS	174
Preliminary synthesis	175
General scheme of the Hellenism/Orientalism process	176
Beyond Hellenistic Orientalism?	178
PLATES FOR THE MAIN ARTICLE	180
APPENDIX 1: HOW TO PRODUCE ARISTOXENOS’ HALF-TONE	197
Aristoxenos’ text and interpretations	198
<i>Pythagorean interpretation</i>	198
<i>Equal-temperament interpretation</i>	199
<i>Alternative interpretation based on superparticular intervals</i>	199
Plates for Appendix 1	200
APPENDIX 2: THE “28 QUARTER-TONES (IN THE OCTAVE)” OF THE HARMONICISTS	204
How the “28 dieseis in one octave” of the Harmonicists became “24 quarter-tones in one octave”, or “28 quarter-tones in one octave and one tone”	204
The equal-division of the strings as a possible solution for the 28 dieseis of the Harmonicists	208
Plates for Appendix 2	210
APPENDIX 3: THE GENERA OF ARISTOXENOS AND DEVELOPMENTS BY (AL-) FĀRĀBĪ	211
Conclusions of Appendix 3	212
Plates for Appendix 3	213
APPENDIX 4: ABOUT THE “RESONANCE” THEORY	217
Three cases for inter-harmonics relations	217
Explaining the “consonance” of the fourth in the light of the Acoustic Resonance Theory	217
<i>Sounding two notes simultaneously</i>	217
<i>Considering partials as independent sounds emitted simultaneously with the fundamental sound</i>	218
Intra-harmonic intervals	218
Plates for Appendix 4	219
APPENDIX 5: THE MYTH OF THE ORGAN(S) IN BYZANTINE CHURCHES (BEFORE “THE FALL”)	224
The origin of the myth	224
How the myth was established	225

Deconstructing the myth.....	226
Another possible reason for Western theoreticians' crave for "Byzantine ditonism"	230
Plates for Appendix 5	232
APPENDIX 6: ON THE "DIATONIC [DITONIC] TONAL SYSTEM" AS THE PROTOTYPE SYSTEM FOR "MEDIÉVAL" BYZANTINE CHANT	233
The "tonal" system of the Byzantine chant according to Oliver Strunk.....	233
The "unambiguous supporting testimony" for the ditonicity of "Medieval" Byzantine chant.....	235
Conclusions for Appendices 5 and 6.....	236
Plates for Appendix 6	237
APPENDIX 7: BASIC UNDERSTANDING OF ORIENTALISM – AND A LITTLE MORE	238
Foreword	238
Orientalism.....	241
<i>The Balkans and Greece: Oriental or occidental?</i>	244
<i>The problem of religion(s)</i>	246
Consequences of Orientalism	249
REFERENCES	251
Contents of the dossier	273

