



**HAL**  
open science

# Confrontation of Genetic Algorithm Optimization Process with a New Reference Case: Analytical Study with Experimental Validation of the Deflection of a Cantilever Beam

Jerome Giordano, Y Burtschell

► **To cite this version:**

Jerome Giordano, Y Burtschell. Confrontation of Genetic Algorithm Optimization Process with a New Reference Case: Analytical Study with Experimental Validation of the Deflection of a Cantilever Beam. *International Journal of Advanced Science and Technology*, 2012, 49. hal-01446859

**HAL Id: hal-01446859**

**<https://hal.science/hal-01446859>**

Submitted on 26 Jan 2017

**HAL** is a multi-disciplinary open access archive for the deposit and dissemination of scientific research documents, whether they are published or not. The documents may come from teaching and research institutions in France or abroad, or from public or private research centers.

L'archive ouverte pluridisciplinaire **HAL**, est destinée au dépôt et à la diffusion de documents scientifiques de niveau recherche, publiés ou non, émanant des établissements d'enseignement et de recherche français ou étrangers, des laboratoires publics ou privés.

# Confrontation of Genetic Algorithm Optimization Process with a New Reference Case: Analytical Study with Experimental Validation of the Deflection of a Cantilever Beam

J. Giordano and Y. Burtschell

*Aix-Marseille Université, Laboratoire IUSTI UMR CNRS-AMU  
5 rue Enrico Fermi, technopôle de Château Gombert,  
13453 Marseille, France  
jerome.giordano@polytech.univ-mrs.fr*

## **Abstract**

*This paper deals with the optimization of a cantilever beam submitted to its own weight. In a first approach, we consider that the beam section can be equal to two values and we are looking for the section changing location, which minimizes the deflection. We propose an analytical model with an experimental validation that will allow us to optimize the shape of the beam. Then, we develop a numerical code based on a genetic algorithm that we validate on this case. In a last section, we use our numerical optimization code to find the best shape of the beam, where the section can now take any values in a given range, to minimize its deflection. These two study cases can serve as reference case to validate numerical approach for automatic structure optimization.*

**Keywords:** *cantilever beam; optimization; self weight loading; reference case; genetic algorithm; automatic optimization*

## **1. Introduction**

The optimization in the design and construction processes has been a permanent wish for engineers since decades. Nowadays, this desire of structure optimization is increased by the taking into consideration of ecological criteria. Indeed, if the engineers want to decrease the material used in order to minimize the cost and the impact on nature, they have to design the best structure with the less amount of matter. To reach this objective, engineers and researchers have investigated lots of domains and have provided many strategies, optimization algorithms and numerical codes. In the field of civil engineering, one can cite for example the different recent works, such as the one [1] dealing with the structure optimization under seismic loading or the one [2] about the shape optimization of a green building. A survey of published works shows that the evolutionary algorithms can be considered as well adapted algorithms to the building structures optimization. We can find in the literature many papers dealing with the structure optimization with genetic algorithms. The articles [3, 4, 5] or more recently [6] are devoted to the optimization of truss structures with genetic algorithms. In the same way, but dealing with concrete structures, the work [7] or [8] show the relevance of the genetic algorithm in the domain of the civil engineering.

In these papers, authors propose solutions to optimize the structure with a mechanical point of view. In all these works, the architectural design is not taken into account and the final geometry of the structure has no aesthetic consideration. However, we think that, for visible building structures, the engineer and the architect have to work

together, not only to optimize the structure but also to respect and to give an emphasis of the original shape given by the architect. Some recent studies dealt with this idea of a compromise or cohabitation between the architectural design of the structure and its mechanical optimum. We can cite the relevant work of Dimcic [9], where the optimization of grid shells is treated with architectural considerations.

Thus, our goal for the long-term is to develop tools for structure optimization, which could assist architects and engineers during the design period of a construction. As mentioned before, we think that genetic algorithms are efficient in this frame of study, so we have chosen to use them. As for all numerical approaches, we have to validate our code on a well documented test case. However, we did not find in the literature a simple reference case for nonlinear problems where the own weight of the structure cannot be neglected. Thus, the main purpose of this paper is to propose a study case of shape optimization able to be used as a nonlinear test case. This study deals with the shape optimization of cantilever beam loaded by its own weight in order to minimize its deflection. To present our work, we have divided this article into four sections. After this introduction, Section 2 is devoted to the presentation of the analytical and experimental results that we obtained on this beam mechanical problem. In Section 3, we will present and validate our structures optimization code on the cantilever beam of the Section 2. In Section 4, we will use our structures optimization code to deal with a less academic study and to show the efficiency of our approach. In a last section, we will try to make conclusive remarks about this work and try to give main perspectives.

## 2. Reference Case: Cantilever Beam with Two Section Values Under its Own Weight

The Figure 1 shows the study case that we want to deal with. The beam, fastened at its first extremity and free at the other one, is loaded by its own weight. Our purpose here is to determine the optimal shape of this beam to minimize the deflection of its free ending. This optimization is achieved with one only variable parameter: the length  $a$  which locates the section changing of the beam from segment 1, with cross section equals to  $S_1$ , to segment 2, with a value of cross section  $S_2$ .

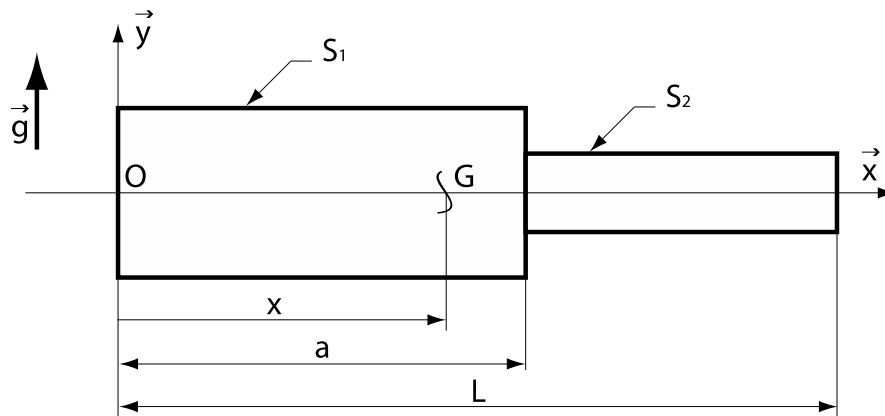

Figure 1. Geometry of the Beam to Optimize

To illustrate our work, we have chosen a set of values for the whole parameters of the problem which gives relevant results and enables us to be easily able to realize experiments. Thus, the cross sections are supposed rectangular and calculated with the

respective relations  $S_1 = b \times h$  and  $S_2 = (b/\lambda) \times h$ . We impose the ratio between the sections:  $\lambda = S_1/S_2$ . The total length of the beam is  $L$ . The moment of inertia of each section  $I_i$  is calculated with the following relations:

$$I_1 = \frac{bh^3}{12}$$

This case corresponds to a beam with rectangular cross sections where only  $b$  is varying between  $S_1$  and  $S_2$ . Moreover, we consider that the beam is made of Plexiglas, with a Young modulus  $E$  equals to  $\approx 2.2$  GPa and a density  $\rho$  equals to  $\approx 1250$  kg. We have chosen to use Plexiglas for experimental considerations. The Earth gravity, denoted  $\mathbf{g}$  is taken equal to  $\mathbf{g} = 9.81 \text{m.s}^{-2} \mathbf{y}$ . The bending moments for each segment can be written with the following equations:

$$\text{if } 0 \leq x \leq a \Rightarrow Mf_1 = \frac{1}{2} \rho g S_1 (\lambda(L-a)(a+L-2x) + (a-x)^2) \quad \square \quad (1)$$

and

$$\text{if } a \leq x \leq L \Rightarrow Mf_2 = \frac{1}{2} \lambda \rho g S_1 (L-x)^2 \quad (2)$$

The diagram of the bending moment is represented in the figure 2. The case where  $a = L$  corresponds to a beam with a constant section equals to  $S_1$ , otherwise the case where  $a = 0$  corresponds to the beam with a constant section equals to  $S_2$ .

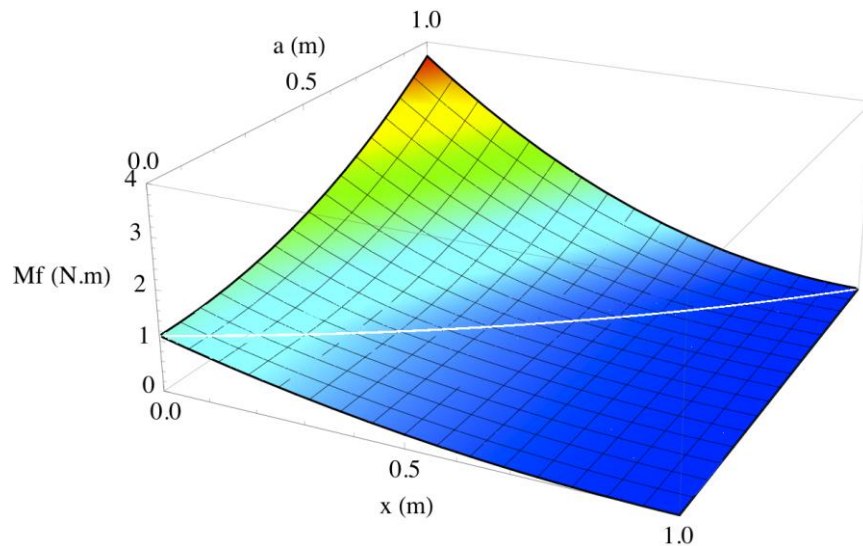

**Figure 2. Bending Moment versus  $x$  and  $a$**

We have also represented in the figures of the Table 1 the plot of the moment for particular values of  $a$ , showing classical bending moment diagrams.

**Table 1. Bending Moment versus x at a=0, a=L, a=2L and a=L**

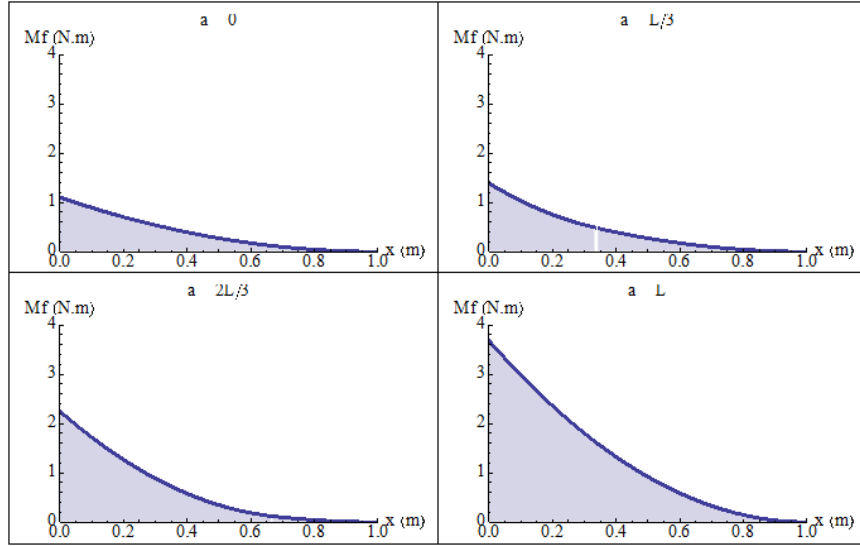

With integrating one time the two equations of bending moment, we can determine the derivate of the deflection  $y_i$  for each segment. We obtain the following equations:

$$EI_1 y_1' = \frac{\rho g S_1}{2} \left( -\frac{1}{3}(a-x)^3 - (a-L)(a+L)\lambda x + (a-L)\lambda x^2 \right) + C_{11} \quad (3)$$

$$EI_2 y_2' = -\frac{\rho g \lambda S_1}{2} (L-x)^3 + C_{21} \quad (4)$$

$C_{11}$  and  $C_{21}$  are the two constants of integration. These constants can be solved with two boundary conditions. The first condition to respect is  $y_1 = 0$  for  $x = 0$  and  $\forall a$ . The second one comes from the respect of the continuity of the slope deflection:  $y_1' = y_2'$  for  $x = a$  and  $\forall a$ . Thus, the two integration constants can be written as:

$$C_{11} = \rho g S_1 \frac{1}{6} a^3 \quad (5)$$

$$C_{21} = \frac{\rho g S_1 \left( -(a-L)(a+L)\lambda a + (a-L)\lambda a^2 \right) + 2C_{11} I_2 + \left( \frac{\rho g \lambda S_1 (L-a)^3}{6} \right)}{2I_1} \quad (6)$$

Then, the equations of the deflection for the two segments  $y_i$  can be determined by integrating the two slope equations. We found:

$$EI_1 y_1 = \frac{\rho g S_1 \left( \frac{1}{12}(a-x)^4 - \frac{1}{2}(a-L)(a+L)\lambda x^2 + \frac{1}{3}(a-L)\lambda x^3 \right)}{2} + C_{11}x + C_{12} \quad (7)$$

$$EI_2 y_2 = \frac{\lambda \rho g S_1 (L-x)^4}{24} + C_{21}x + C_{22} \quad (8)$$

One more time, the two constants of integration  $C_{12}$  and  $C_{22}$  are determined with the boundary conditions of the study. The first condition to respect is:  $y_1 = 0$  for  $x = 0$  and  $\forall a$ . The second condition is:  $y_1 = y_2$  for  $x = a$  and  $\forall a$ . Thus, the two constants are given by the two following relations:

$$C_{12} = -\rho g S_1 \frac{1}{24} a^4 \quad (9)$$

$$C_{22} = \frac{(\rho g S_1 (-\frac{1}{2}(a-L)(a+L)\lambda a^2 + \frac{1}{3}(a-L)\lambda a^3) + 2C_{11}a + 2C_{12})}{2I_1} (I_2) - \left( \frac{\lambda \rho g S_1 (L-a)^4}{24} + C_{21}a \right) \quad (10)$$

The deflection of the beam for all the values of  $x$  and  $a$  can be represented by the figure 3. In order to better see the beam deflection, the curve of the deflection is plotted for different values of  $a$  in the figures of the Table 2.

**Table 2. Beam Deflection versus  $x$  at  $a=0$ ,  $a=L$ ,  $a=2L$  and  $a=L$**

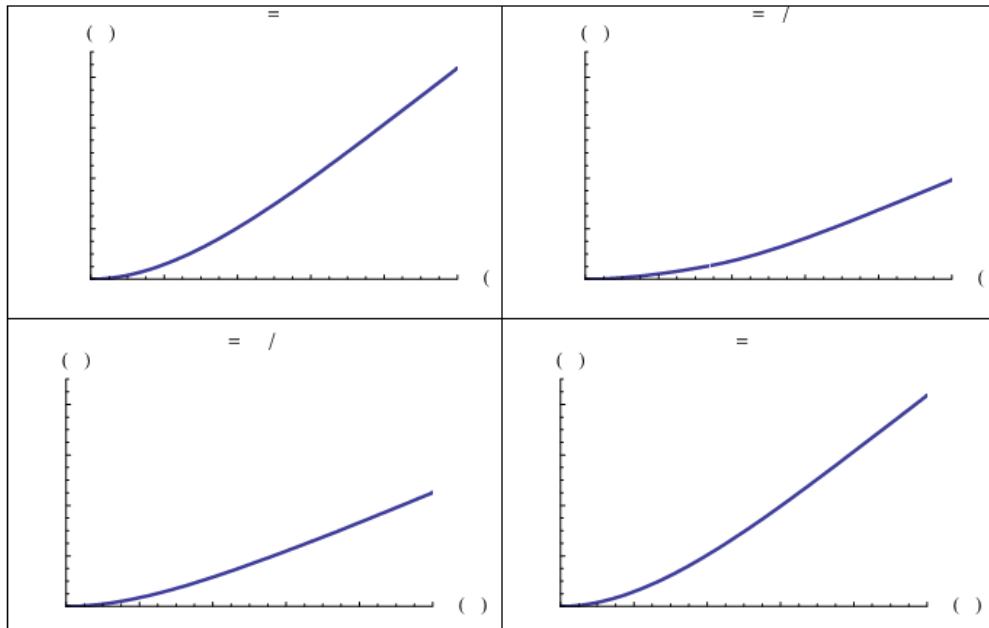

We can clearly see in the Figure 3 that the deflection can be minimized for a particular value of  $a$ . If we plot now the maximum deflection at the free ending of the beam,  $y_2$  for  $x = L$ , versus  $a$ , cf. the Figure 4, we can estimate that the minimum of this deflection is equal to  $\approx 0.37$  m and that is reached at  $a \approx 0.44$  m. A better estimation is found with Wolfram Mathematica software which gives  $a \approx 0.446$  m. Moreover, we also see that the optimal value of  $a$  does not depend on the values of the section  $S_1$  and  $\lambda$ .

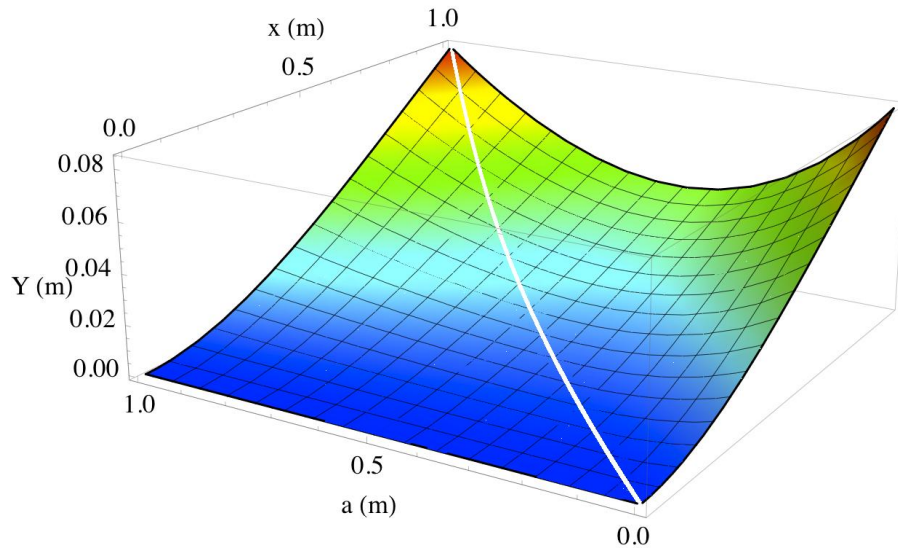

**Figure 3. Deflection of the Beam versus x and a**

Besides, we have also plotted on the Figure 4 the experimental results of the beam deflection that we measured. The measures were obtained with the experimental device presented on the Figure 5. The beam, made in Plexiglas, has been fastened on the table and we take pictures of it with digital camera. Pictures are then post-processed with the software ImageJ in order to get the maximal deflection. In addition, the values of the deflection are also gauged with a tape measure. We can observe that the agreement between the analytical model and the measures is quite good and allows us to validate our approach and confirms the best value of  $a$  which minimizes the deflection.

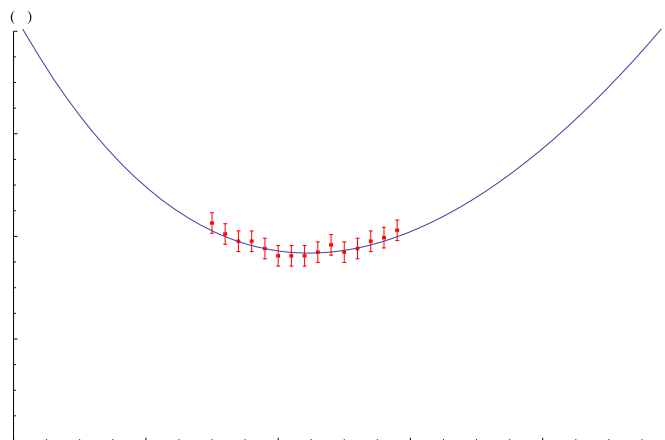

**Figure 4. Deflection at the Free Ending of the Beam versus a**

Thus, the optimal shape of a beam, for the set of parameters we have considered until now, is a 1 m long beam with the length of segment 1 equals to  $\approx 0.446$  m. This shape allows us to minimize the maximum deflection of the beam at its free ending. We can use now this configuration as a reference case to validate automatic optimization programs.

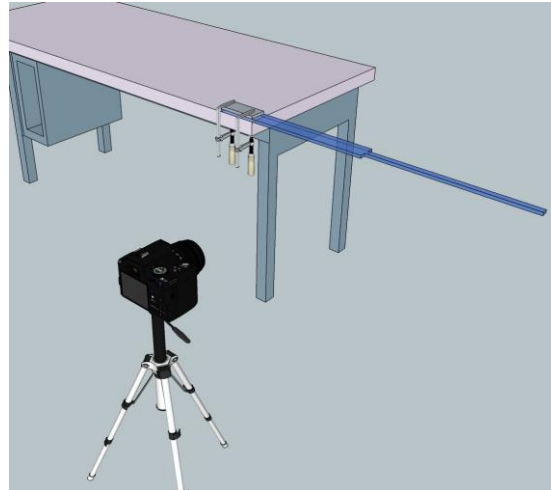

**Figure 5. Scheme of Experimental Set-up**

### 3. Validation of our Genetic Algorithm Optimization Program with the Reference Case

In this section, we present the validation of our numerical method on the previous case. Our purpose is to characterize the accuracy of our code on this case by evaluating the optimal shape of the beam which minimizes the maximal deflection. Our approach is based on the use of classical genetic algorithm coupled here with a numerical algorithm to estimate the beam deflection. Moreover, we want to underline that in this present study the constraint function is dependent on the design variables and, as a consequence, needs what [6] calls a hybrid genetic algorithm to be minimized.

#### 3.1. Numerical Beam Deflection Estimation

The calculation of the deflection is made with the discretization and numerical integration of the relation between the second derivative of the deflection  $y''$  and the bending moment *Moment*. The beam is discretized into P segments of which the length is equal to  $l = L/P$ . The second derivative of the deflection  $y_p''$  and the moment *Moment<sub>p</sub>* are supposed as constant on each p segment. We note the first derivative of the deflection  $y_p'$ , the deflection  $y_p$ , the section  $S_p$  and the moment of inertia  $I_p$ . Thus, we can estimate the beam deflection with the following procedure:

```

For p = 2→P Do
    Momentp = 0
    For i = p→P Do
        Momentp = Momentp - (ρ g l2 Si 2(i-p)+12) / 2
         $y_p'' = \textit{Moment}_p / EI_p$ 
         $y_p' \square = y_p'' l + y_{p-1}'$ 
         $y_p = y_p'' l^2/2 + y_{p-1}' l + y_{p-1}$ 
    EndFor
EndFor
    
```

In this case, this method is much faster than to use a finite element one and as consequence is well adapted to iterative genetic algorithm. Nevertheless, because our



method is not a current one, the accuracy of the estimation of the beam deflection has to be characterized. Thus, we have realized a convergence study on a uniform beam, still made in Plexiglas and submitted to its own weight. The beam properties are: length equals to 1 m, section equals to  $b \times h = 0.06 \times 0.01 \text{ m}^2$  and a moment of inertia equals to  $(b \times h^3)/12 = 5.10^{-9} \text{ m}^4$ . For this beam, the maximum deflection is estimated analytically at  $\approx 0.083 \text{ m}$ . In the Table 3, we give the estimation of this deflection obtained with our method for different values of P. One can see that the estimation of the deflection is converging to the analytical reference value, but with an overestimation of this value. We can consider that the agreement between our model and analytical estimation of the deflection becomes acceptable with at least 40 segments.

**Table 3. Study of Convergence**

<i>P</i>	deflection	deviation
10	0.095 m	14%
20	0.089 m	7%
40	0.086 m	3.4%
80	0.085 m	1.6%
160	0.084 m	0.8%
320	0.083 m	0.35%
640	0.083 m	< 0.1%

### 3.2. Genetic Algorithm Method

Genetic algorithms are computational algorithms, which imitate life evolution mechanisms. Genetic algorithms are introduced in the middle of the seventies by [10] and his students, for example [11]. These types of optimization algorithms have been well studied and documented, for example in [12], and are appropriate in our context of civil engineering.

The implementation of genetic algorithms starts with the creation of a random population of individuals, here of beams, which have each its own genotype. The genotype of one individual is made as the following way: as we discretized the length of beam in P segments, each segment can have a cross section equals to  $S_1$  or  $S_2$ . Thus, in the present case, with one byte we can assign the value of the section for each segment. If we consider that the binary value 0 is attributed to  $S_2$  and the binary value 1 to  $S_1$ , we can randomly code the genotype of a beam as follow:

**Table 4. Genotype of One Individual**

segment	1	2	3	4	...	(P-1)	P
genotype	0	1	1	0	...	0	1

Then, the deflection of each individual, *i.e.* each beam, is calculated using the algorithm previously described and we proceed to the selection step. A proportion of the initial population, which gives the better results in term of minimal deflection, is selected to breed the new generation. Different methods can be used for the selection process as it is exposed in [13]. In our approach, we have chosen to use the truncation method by keeping the best third of individuals. Even if this method cannot always be considered as the most efficient, it remains the simplest to code and gives an acceptable convergence.

The next step is to generate the following population by reproducing the individuals. This step consists by a mixing of genes of selected individuals, the *parents*, to provide new individuals, the *children*, with new genotype. Again, many methods can be used to recombine the genotype as it is described by [14]. We use here a uniform crossover, where each gene of a created child is randomly selected among those of the parents ones. The Table 5 illustrates this crossover technics.

**Table 5. Crossover Method**

<i>Parent 1</i>	x	x	x	x	...	x	x
<i>Parent 2</i>	y	y	y	y	...	y	y
<i>Child</i>	x	y	y	x	...	y	x

The last operation of genetic algorithm is mutation. The mutation resides in the random modification of one or several genes of an individual genotype. The aim of the mutation process is to explore the search space. In our code, 10% to 20% of the population can be subject to the mutation of one to four of their genes.

### 3.2. Results on Test Case

We expose in this section the results obtained with our numerical method to deal with the two sections beam test case of the Section 2. Our objective is to show the ability of our approach to find the analytical minimum of the beam deflection. In the table 3.3, we remind the parameters of the test case.

**Table 6. Test Case Parameters**

length	1 m
$\lambda$	3
section $S_1$	$b \times h = 0.06 \times 0.01 \text{ m}^2$
section $S_2$	$(b/\lambda) \times h = 0.02 \times 0.01 \text{ m}^2$
moment of inertia $I_1$	$S_1 \times h^2/12 = m^4$
moment of inertia $I_2$	$S_2 \times h^2/12 = m^4$
Young modulus $E$	2.2 GPa
density $\rho$	1250 kg/m <sup>3</sup>

Different simulations with a variation of the accuracy of the discretization from  $p = 20$  to  $p = 160$  have been realized. All these simulations converge to an optimum of the deflection and so to an optimal shape of the beam. We can see that the shape of the optimal beam does not

depend on the accuracy of the discretization. We have plotted on the Figure 6 the final shape of beam for all the values of  $p$ .

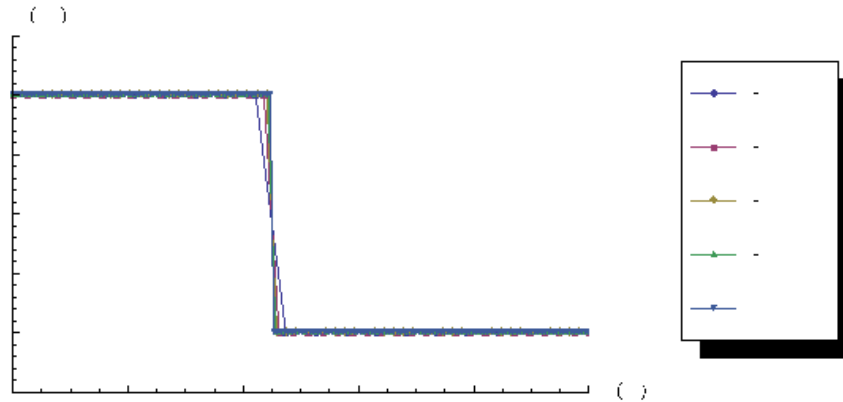

**Figure 6. Optimal Beam Shape Obtained for Different Values of  $p$**

The Figure 7 gives a closer view around the section changing of the optimal shape:

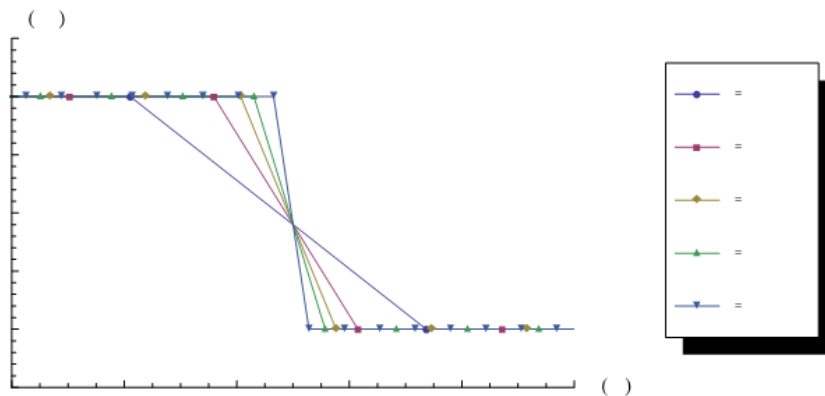

**Figure 7. Zoom of the Optimal Beam Shape Obtained for Different Values of  $p$**

Our numerical approach allows us to assess the optimal shape of the beam with the section changing located at  $\approx 0.45$  m for all the values of  $p$ . For this shape, the deflection observed is  $\approx 0.40$  m. Compared to the analytical value of  $a$ , which it estimated in the previous section at  $\approx 0.446$  m, the deviation is less than 1%. For the deflection, the deviation between the numerical value and the analytical one is  $\approx 9\%$  when  $p = 80$ . The most important deviation about the deflection can be explained by the beam discretization, which could be improved. However, the discretization improvement will lead to the increase of the time calculation and is not useful here. We can conclude that this good agreement validates our numerical approach to deal with the automatic shape optimization with a genetic algorithm. With this first validation, we can use our numerical approach to optimize the shape of a beam submitted to its own weight. An example of this type of optimization process is given in the following section.

#### 4. Shape Optimization of Cantilever Beam

In this section, we present the results of the optimization of a cantilever beam submitted to the load of its own weight. The difference with the previous section is that the section can now vary in a given interval. As we have done before, our purpose is to minimize the beam deflection without any consideration about the volume of the beam. Thus, this case of beam optimization becomes strongly non-linear and can no more be solved analytically. We consider that the section of the beam can vary from  $S_2$  to  $S_1$  by increments. One can note that this case is different from that exposed by [15], where the beam is optimized with an imposed volume and so an imposed amount of matter. The section increment depends on the byte number that we attribute in the genotype to code the section value. In the present case, we have decided to use 6 bytes to code the section values. Thus, we consider  $2^6 = 64$  values of section in the range of  $[S_2, S_1]$ . Coding the section with greater byte numbers increases too much the time of calculations and the size of the necessary memory. As for the previous calculations, we have considered several discretization for the beam, where  $p$  can be equal to 10, 20, 40 and 80. The results are plotted on the Figure 8 and on the Figure 9.

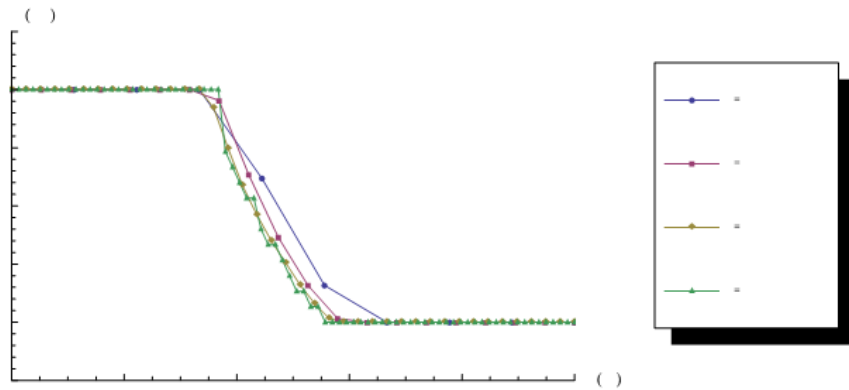

Figure 8. Optimal Beam Shape Obtained for Different Values of  $p$  with Incremental Variation of the Section

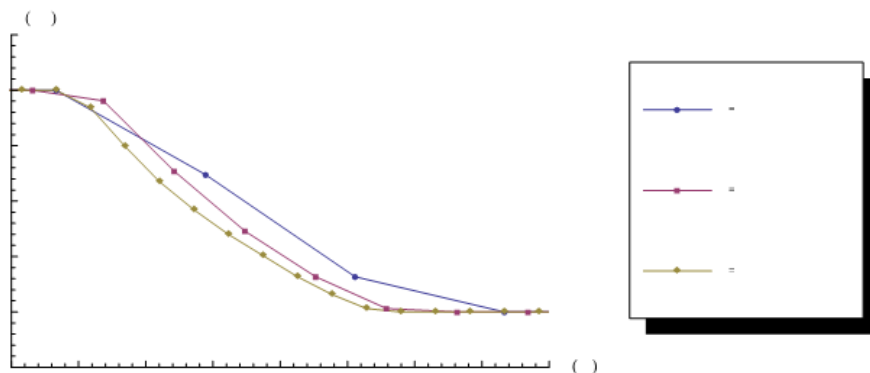
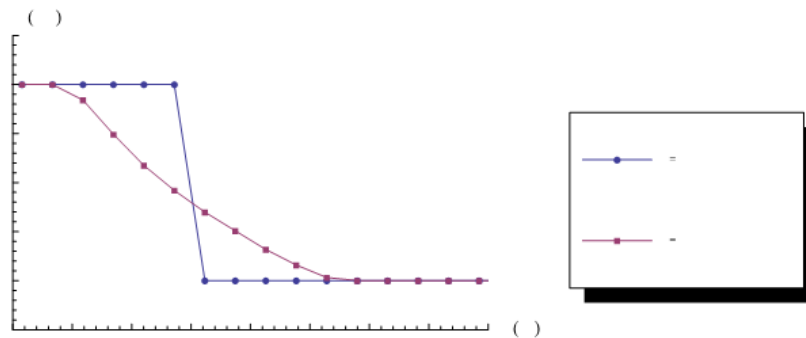

Figure 9. Zoom of the Optimal Beam Shape Obtained for Different Values of  $p$  with Incremental Variation of the Section

We can observe in the Figure 8 that the beam converge to an particular shape where the section is: constant and equal to the maximum S1 for  $x \leq \approx 0.35$  m, constant and equal to the minimum S2 for  $x \approx 0.6$  m. In the range of  $x \in [\approx 0.35 \text{ m}; \approx 0.6 \text{ m}]$ , the section is varying with a slightly continuous curvature. Even if this curve becomes smoother with the increase of discretization, one can note that the shape is already quite well estimated as soon as p is greater than 20. We can also see in the figure 10 that the variation of the section, which minimizes the beam deflection, appears at the same location that we have determined analytically when the section can take only two values. The deflection when  $p = 80$  is equal to  $\approx 0.039$  m, which represents a decrease of 2.5% compared to the case where the beam section can only be set to two values.

Thus, the optimization with a free section value does lead to a much better optimal beam. As a consequence, we can say that a more accurate calculation is not mandatory to optimize the shape of the beam. Moreover, it is noticeable that in this case the section variation is not decreasing from one of the beam extremity to the other one. Actually, the two segments where the section takes the values S1 and S2 represent a large part of the beam (Cf. Figure 8). This shape of the optimized beam is far away from that obtained on the case where the loading on the beam is an external force which does not depend on the shape of the beam itself. Indeed, in this last case, the section decreases all along the beam as shown by the results of [16].



**Figure 10. Zoom of the Optimal Beam Shape Obtained for Different Values of p with Incremental Variation of the Section**

## 7. Conclusions

This work deals with the development of a reference case to help the validation of numerical codes for automatic structure optimization. Thus, we have studied the deflection of a beam loaded by its own weight and where its section can vary. Through an analytical approach, we have been able to optimize the beam shape to obtain the minimal deflection. In this first case, we have considered that the section of the beam can take two values and our purpose was to locate the section changing of the beam. This result was corroborated by experimental measures of the deflection. Then, we have developed a numerical code to deal with this beam optimization based on genetic algorithm. We have proposed a numerical method to estimate the deflection of the beam faster in this case than the finite elements approach. The results obtained with our numerical codes were confronted to analytical ones and were validated with a variation less than 1% on the location of the section changing. Then, we have used our numerical approach to optimize the beam, again loaded by its own weight, but with the possibility for the section to take any values in a range of [S2, S1]. This

case can no more be solved analytically. The optimized beam given by our approach has three distinct parts. On a first segment, where  $x \leq 0.35$  m, the section is constant and reaches the maximum value  $S_1$ . Then, we observe a segment in the range of  $0.35 \text{ m} \leq x \leq 0.6 \text{ m}$  where the section decreases from  $S_1$  to  $S_2$ . For the last part of the beam, for  $x \geq 0.6 \text{ m}$ , the section is constant and equal to its minimum  $S_2$ . Thus, we propose in this paper a reference case helpful for the validation of numerical strategies of structures optimization. Moreover, we have developed and validated our own numerical approach to be able to deal with some beam optimization problems that can be used to optimize structures. This method should now be extended to more realistic problems that we encounter in the civil engineering domain.

## References

- [1] I. Hajirasouliha, K. Pilakoutas and H. Moghaddam, "Topology optimization for the seismic design of truss-like structures", *Computers and Structures*, (2011).
- [2] W. Wanga, H. Rivarda and R. Zmeureanub, "Floor shape optimization for green building design", *Advanced Engineering Informatics*, vol. 20, no. 4, (2006), pp. 363–378.
- [3] C. A. Coello and A. D. Christiansen, "Multiobjective optimization of trusses using genetic algorithms", *Computers and Structures*, vol. 75, (2000), pp. 647–660.
- [4] V. Togan and A. T. Daloglu, "Optimization of 3D trusses with adaptive approach in genetic algorithms", *Engineering Structures*, vol. 28, (2006), pp. 1019–1027.
- [5] H. Rahami, A. Kaveh and Y. Gholipour, "Sizing, geometry and topology optimization of trusses via force method and genetic algorithm", *Engineering Structures*, vol. 30, (2008), pp. 2360–2369.
- [6] J. Cheng, "Optimum design of steel truss arch bridges using a hybrid genetic algorithm", *Journal of Constructional Steel Research*, vol. 66, (2010), pp. 1011–1017.
- [7] S. Atabay, "Cost optimization of three-dimensional beamless reinforced concrete shear-wall systems via genetic algorithm", *Expert Systems with Applications*, vol. 36, (2009), pp. 3555–3561.
- [8] R. Perera and J. Vique, "Strut-and-tie modeling of reinforced concrete beams using genetic algorithms optimization", *Construction and Building Materials*, vol. 23, (2009), pp. 2914–2925.
- [9] M. Dimcic, "Structural Optimization of Grid Shells based on Genetic Algorithms", PhD thesis, Institut für Tragkonstruktionen und Konstruktives Entwerfen, (2011).
- [10] J. Holland, "Adaptation in natural and artificial systems: an introductory analysis with applications to biology", control, and artificial intelligence, MIT Press, (1975).
- [11] A. De Jong, "An analysis of the behavior of a class of genetic adaptive systems", PhD thesis, Department of computer and communications sciences, University of Michigan, Ann Arbor, (1975).
- [12] D. Whitley, "A genetic algorithm tutorial. Statistics and Computing", vol. 4, (1994), pp. 65–85.
- [13] R. Sivaraj and T. Ravichandran, "A review of selection methods in genetic algorithm", *International journal of Engineering Science and Technology*, vol. 3, no. 5, (2011), pp. 3792–3797.
- [14] E. G. Shopova and N. G. Vaklieva-Bancheva, "Basic a genetic algorithm for engineering problems solution", *Computers and Chemical Engineering*, vol. 30, (2006), pp. 1293–1309.
- [15] R. H. Plaut and L. N. Virgin, "Optimal design of cantilevered elastica for minimum tip deflection under self-weight", *Struct. Multidisc. Optim.*, vol. 43, (2011), pp. 657–664.
- [16] E. Kita and H. Tanie, "Shape optimization of continuum structures by genetic algorithm and boundary element method", *Optimization and Sensitivity Analysis*, vol. 19, no. 2, (1997), pp. 129–136.

