



**HAL**  
open science

## Linear Sensor Networks

El Hadji Malick Ndoeye, Ibrahima Niang, Frédérique Jacquet, Michel Misson

► **To cite this version:**

El Hadji Malick Ndoeye, Ibrahima Niang, Frédérique Jacquet, Michel Misson. Linear Sensor Networks : A comparative study between a Token based and a contention based MAC Protocol . 2017. hal-01446421v1

**HAL Id: hal-01446421**

**<https://hal.science/hal-01446421v1>**

Preprint submitted on 25 Jan 2017 (v1), last revised 15 Feb 2018 (v3)

**HAL** is a multi-disciplinary open access archive for the deposit and dissemination of scientific research documents, whether they are published or not. The documents may come from teaching and research institutions in France or abroad, or from public or private research centers.

L'archive ouverte pluridisciplinaire **HAL**, est destinée au dépôt et à la diffusion de documents scientifiques de niveau recherche, publiés ou non, émanant des établissements d'enseignement et de recherche français ou étrangers, des laboratoires publics ou privés.

# Linear Sensor Networks

## A comparative study between a Token based and a contention based MAC Protocol

<sup>1,2</sup> El Hadji Malick NDOYE, <sup>1</sup> Ibrahima NIANG, <sup>2</sup> Frédérique JACQUET and <sup>2</sup> Michel MISSION

<sup>1</sup> Laboratoire d'Informatique, Université Cheikh Anta Diop de Dakar (UCAD), B. P. 5005 Dakar-Fann, Sénégal

<sup>2</sup> Clermont Université / LIMOS CNRS - Complexe scientifique des Cézeaux, 63172 Aubière cedex, France

E-mail: {[ndoye.jacquet.mission@sancy.univ-bpclermont.fr](mailto:ndoye.jacquet.mission@sancy.univ-bpclermont.fr), [ibrahima1.niang@ucad.edu.sn](mailto:ibrahima1.niang@ucad.edu.sn)}

.....

**ABSTRACT.** A wireless sensor network is a large number of sensor nodes deployed in a fixed or random manner over a wide area for environmental monitoring applications. Wireless sensors communicate via wireless links and are powered by batteries. They collect and provide information to the base station usually called sink. The information collected is generally physical, chemical or biological nature. For some of these applications, as pipeline or road monitoring, wireless sensor nodes have to be deployed in a linear manner. We refer to these WSNs as Linear Sensor Networks (LSNs). Suitable MAC protocols for LSN must take account the linearity in order to ensure reliability and optimize parameters such as the end-to-end delay, the delivery ratio, the throughput, etc. In this paper, we present LTB-MAC a Linear Token Based Mac Protocol designed for linear sensor networks. In this paper we present a comparative study in terms of throughput, delivery ration, end-to-end delay between a Linear Token Based MAC protocol and the unslotted CSMA/CA of 802.15.4.

**KEYWORDS:** Wireless sensor network, linear topology, throughput, MAC protocol, CSMA/CA, RTS/CTS, token passing, end-to-end delay, delivery ratio, 802.15.4.

.....

## 1. Introduction

In LSNs, MAC protocols must effectively ensure the end-to-end delay and delivery ratio through a protected and effective access to the channel. This paper focuses on a Linear Token Based MAC protocol for linear sensor network (LTB-MAC). LTB-MAC is based on a synchronization using token generation for the access to the transmission channel. The token contains temporal informations on the periods of activity and inactivity of nodes. So, it gives to a node the right to access to the channel during an amount of time. We evaluate LTB-MAC in terms of throughput, end-to-end delay in comparison to CSMA/CA in order to show its impact on the behavior of LSN.

The rest of the paper is outlined as follows: in section 2 we present a state of the art on the MAC protocols used in linear networks. Section 3 gives the hypothesis and the network topology; section 4 presents LTB-MAC. In this section we show the principles of the token by explaining the role of temporal information related to the token. In section 5, we analyze the token propagation process and define the concept of shuttle. We present our simulation results in section 6. Finally, we end this paper with a conclusion and perspectives in section 7.

---

## 2. State of art

The linear sensor networks are present in many monitoring applications. They are found in the surveillance of pipelines [1][2][3], mine [4][5][6], volcanoes, bridges or roads [7] [8], etc. They are characterized by a limited neighborhood and extend over long distances [9].

The major challenges of MAC protocols in LSN are therefore equitable load distribution on the nodes in the linear topology, optimizing the rate of delivery packets and the end-to-end delay, fault tolerance, energy saving, etc. Linear sensor network MAC protocols are mainly based on the contention and synchronization. DiS-MAC [10] is a MAC protocol based on time synchronization of sensor nodes linearly deployed for highway surveillance. In DiS-MAC, each node uses directional oriented antennas to reduce its transmission range to a direct neighbor in the line. This minimizes not only the interference between nodes on the same line but also between the nodes of the line on the other side of the highway. The access to the channel in Dis-MAC is divided into two phases called phase I and phase II which respective durations are  $T_1$  and  $T_2$ . In phase I, only the oddly positioned nodes on the linear network access the transmission channel. The evenly positioned nodes are receivers during this phase. Similarly, during Phase II, the oddly positioned nodes are transmitters during  $T_2$  and those of the oddly positioned ones are receptors. However, Dis-MAC is not suitable to linear multidirectional networks antennas where the transmission range of a node can extend over a neighborhood of more than one node. Indeed, in this case, there are risks of

**ARIMA**

collisions between nodes impacting negatively within the end-to-end delay and delivery ratio. LC-MAC [11] is another MAC protocol based on time synchronization. This protocol is designed for linear networks extending over long distances to reduce the end-to-end delay while saving the energy of sensors. CMAC-T [12] is a MAC protocol for linear network designed for forest environment monitoring. It uses token propagation for nodes access to the transmission channel. The creation and generation of the token frame are managed by the sink. So, it periodically diffuses it towards the nodes to designate the one that has access to the channel. However, this periodic resynchronization of nodes increases the end-to-end delay in the network. WiWi [13] is a MAC protocol which synchronizes nodes by using time slots. Between two transmissions a node must wait for a period of time equivalent to four time slots to avoid any collision with the reception of the reverse traffic. This increases the waiting time and reduces the delivery rate. The 802.15.4 MAC protocol [14] is the main contention MAC protocol used in linear sensor network. The L-CSMA protocol [15] is a MAC protocol based on 802.15.4 CSMA/CA and is designed for linear sensor network. It is assumed that, with CSMA/CA, the probability that a packet collides during its transport is quite high in the case of a linear topology because of the contention and the problem of hidden terminal. To avoid packet loss, L-CSMA is based on the priorities assigned to nodes according to their position on the line. Nodes closer to the sink have the higher priority. This method reduces contention between nodes but increases also the end-to-end delay. The protocol presented in [16] makes a comparison of CSMA/CA protocol with RTS/CTS and without RTS/CTS in a linear sensor network. It shows that the CSMA/CA protocol with RTS/CTS offers better performance in terms of number of dropped packets and queuing behavior over time.

### 3. Previous works

In previous works [17][18], we introduced LTB-MAC for a clustering technique in Linear Sensor Networks in conditions where radio links are supposedly stable and identical between nodes uniformly distributed. We considered the Tworayground propagation model [19] in which the reception power for a given link remains constant for a given transmission power. In this approach, the size and the distance between clusters head are calculated logically and statically depending on the connectivity of the network, a link has a binary behavior: it is operational or not. This distance represents the distance between two nodes token holders, According to this, we shown that the size of the cluster under the propagation conditions depends on the redundancy factor  $R$ . This defines the neighborhood in a linear network i.e the number of neighbors left or right for a given node. We have thus defined an  $R$ -redundant network in which a given node is within range of  $2 * R$  nodes distributed equitably to its left and to its right.

We have shown the impact of clustering on network performance. Network parameters such as the delivery rate, the throughput at the sink increase with the size of the linear cluster. Indeed, the delivery rate and the throughput are higher for the 3-redundant network, followed by the 2-redundant network. In this, paper, we present a comparison study between LTB-MAC and the 802.15.4 MAC protocol in order to show the behavior of the linear sensor network for two different channel access protocols.

#### 4. Hypothesis and network model

We focus on a linear sensor network where the access to the transmission channel is managed by a token generation. Three types of sensors can be defined according to the role of the sensor nodes. The basic node that is a simple node with the relay functions of aggregated data. The Token Allocator that creates the token periodically is usually located at the opposite end of the sink. In Fig. 1, it is located at the extreme left of the network. The Token Allocator is also a basic node with the particularity of having no left neighbors. The sink is the base station which aggregates and analyzes data.

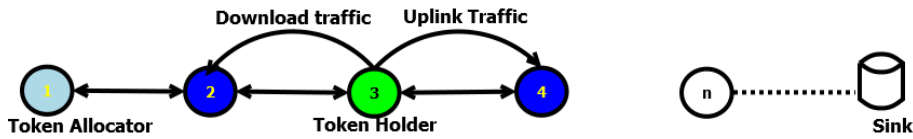

Fig. 1. Linear sensor network

In this study, we consider a LSN where the Token Allocator is located at the extreme left of the network and the sink at the right end. In this case, for a given node, we define two types of neighbors. (i) The left neighbors which are nearest to the Token Allocator. (ii) The right neighbors which are nearest of the sink. In the LSN data can transit from Token Allocator to the sink node. We refer this traffic as uplink traffic. This traffic consists of information collected by the monitoring application (physical, chemical, environmental variables, etc.). They can also transit from the sink to the Token Allocator. This is called downlink traffic. This traffic consists of control data of the network or the application. We can also include synchronization or alert settings.

We suppose that nodes are deployed in a fixed manner over the line and the distance between two adjacent nodes is equal to  $d$ . It is assumed that the environment is homogeneous and that the propagation conditions allow to receive the token with a power beyond the defined sensitivity threshold (-92 dBm in 802.15.4). The traffic and the token are acknowledged and data packets have the same size. For resources management of sensor nodes, it is assumed that the radio module of a node changes

**ARIMA**

from one state to another depending on data collected and specifications of the access method.

### 5. LTB-MAC description

In LTB-MAC, the token gives to a given node the access to the transmission channel. This is a data frame containing temporal informations on the synchronization of the nodes. So, a node is either token holder or is waiting for it. When it is the possessor of the token it accesses to the transmission channel during a defined time interval. This time interval is divided as follows as shown in [17]. Fig. 2. shows the sequence of activity time and inactivity for a defined node. Upon awakening, the node goes into reception mode of the uplink traffic of its left neighbor during  $T_0$  and the token during  $T'_0$ . After the  $T'_0$  period it receives the token and begins its transmission period ( $T_1 + T_2 + T'_2$ ). After the transmission of the token, the node goes into reception mode of downlink traffic during  $T_3$ . At the end of the reception, it then goes into sleep mode to save power during  $T_4$ . The way of propagating the token from node to node towards the sink can be seen as the passage of a shuttle [17][18] in which the nodes deposit their traffic towards sink. We define the shuttle duration (Fig. 2) as the amount of time duration of the shuttle duration (SDur) and the amount of information exchanged by a node during the shuttle passage as the shuttle payload (Splo).

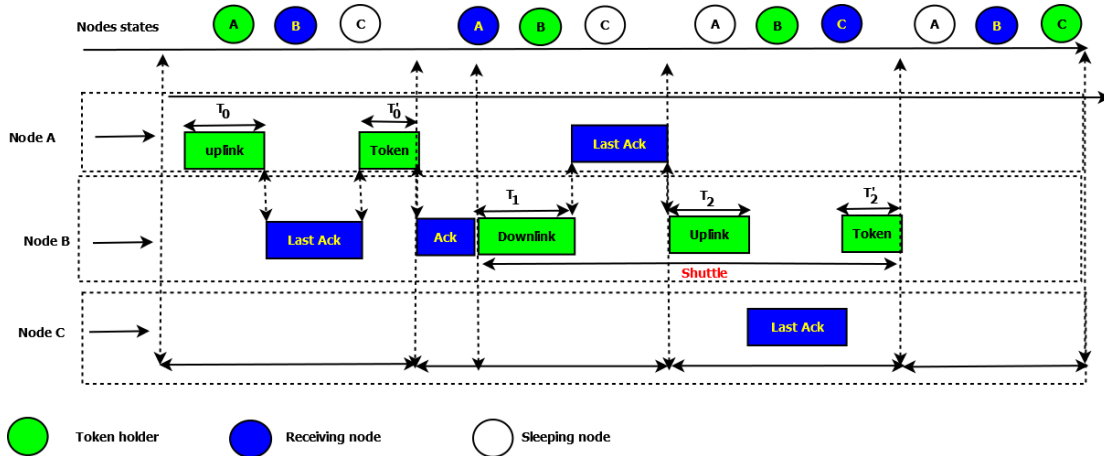

Fig. 2. Token process and shuttle propagation

Fig. 3 shows the automate of the different states of a current node. The sink and the token allocator are node concerned.

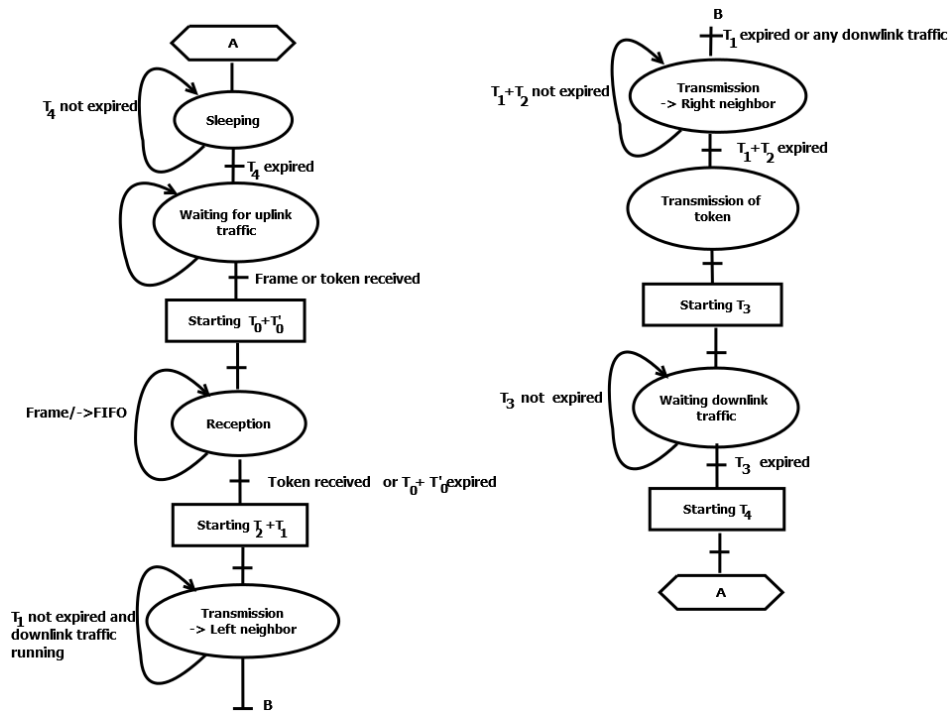

Fig. 3 The automate of the current node

## 6. The unslotted CSMCA/CA algorithm with RTS/CTS description

In this paper we compare LTB-MAC to the unslotted CSMA/CA algorithm of 801.15.4 with RTS/CTS [16]. This algorithm works as follows. When a node wants to send a data frame, it first sends an RTS by using the non-slotted CSMA / CA algorithm

ARIMA

of 802.15.4. If the channel is free, then the node sends the RTS. If the channel is busy, the node retries sending the RTS after a waiting period depending on the contention windows. If the number of retries exceeds five instances, then the current frame is dropped in order to avoid overload and congestion in the network. When the transmitter receives the CTS then it sends the data frame directly to the receiver node (the next hop) and this responds with an acknowledgment after reception of the frame. . The RTS and CTS frames contain all the information necessary for the realization of the transmissions. The inter-frame periods such as SIFS and DIFS are assimilated to a backoff period of 320  $\mu$ s and correspond in reality to the time required for the radio module to switch from the receiving state to the transmission state and vice versa in 802.15.4.

The other nodes which receive RTS or CTS block their Network Allocation Vector during the a period corresponding to the data frame transmission time + acknowledgment transmission time. The algorithm of the unslotted CSMA/CA of 802.15.4 is shown in figure 4.

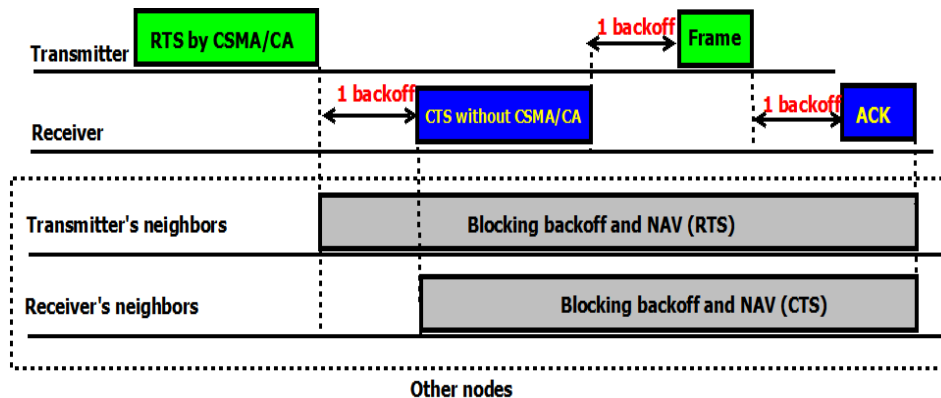

Fig. 4. The CSMA/CA with RTS/CTS



## 7. Simulations and results

### 7.1 Simulations parameters

We simulate our analysis on NS2 with version 2.32. We consider a linear sensor network of 10 nodes and a sink. Local traffic is generated pseudo-randomly per time interval and begins independently between 0 and 1 s for each node. The conditions of propagation are made so that each node has exactly two neighbors: one on the right and one on the left. To do this, let's consider a transmission power of -5 dBm and a distance equal to 90 m. The size of FIFOs is considered fixed and equal to 50 packets.

The possibility of downlink traffic is neglected assuming that the physical characteristics of the sink allow it to receive correctly traffic. In this case, the need to send resynchronization messages or alert is negligible. We focus on three performance parameters: the throughput at the sink, the end-to-end delay and the delivery rate for a given node. The throughput is the average rate of traffic received by the sink per time unit while the delivery ratio is the rate of packets delivered to the sink for a given node. In fact, it represents the ratio between the number of received packets and the number of sent packets by the node. The delivery rate depends on the overall load of the network at a time and the number of hops performed by the packets before reaching the sink. We are mainly interested in two nodes to study the delivery rate: node 1 and node 5. We compare LTB-MAC with the CSMA/CA protocol with and without RTS/CTS. Fig.5 shows the conditions of collision-free transmissions for LTB-MAC protocol and CSMA/CA with RTS/CTS.

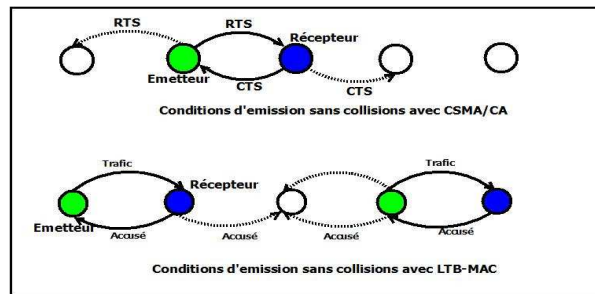

Fig. 5. Conditions of collision-free transmissions

Under these conditions, it is considered that the distance between two consecutive shuttles is three hops. We consider three shuttles: 10 ms, 50 ms, and 250 ms.

The simulation parameters are summarized in the following table.

**Table 1 Simulations parameters**

Parameters	Values
Token size	11 Bytes
Frame size	100 Bytes
Number of repetitions	50
Physical Layer	802.15.4
FIFO size	50-60 packets
Transmission Power	-5 dBm
LSN offered load	[10-100] Kbps
Simulation start time	[0-1] s
Simulation end time	[199-200] s
Shuttle duration	[10,50,250] ms

## 7.2 Results

Fig. 6 shows the throughput at the sink according to the global load offered in the network for small shuttles 10, 50 and 250 ms. It shows that the LTB-MAC protocol offers better performance than the CSMA/CA with or without RTS/CTS in terms of throughput beyond a 10 ms shuttle. Indeed, for LTB-MAC the maximum received flow rate is about 40 Kbps, while it is 25 Kbps for CSMA/CA with RTS/CTS and 15 Kbps without RTS /CTS. The evolution of the throughput for LTB-MAC protocol can be divided into two phases.

- Between 8 and 40 Kbps of offered load (depending on the shuttle): during this phase the it increases as a function of the overall network load. This is explained by the fact that the network is not overloaded and therefore the FIFOs do not overflow. Thus, during the passage of the shuttle, the nodes are able to send as much data as possible.
- Between 40 and 80 Kbps the throughput is stationary. This phase corresponds to the saturation which is the consequence of the high network load. Therefore, the aggregated data during passage of the shuttle remains constant which explains that the throughput does not progress.

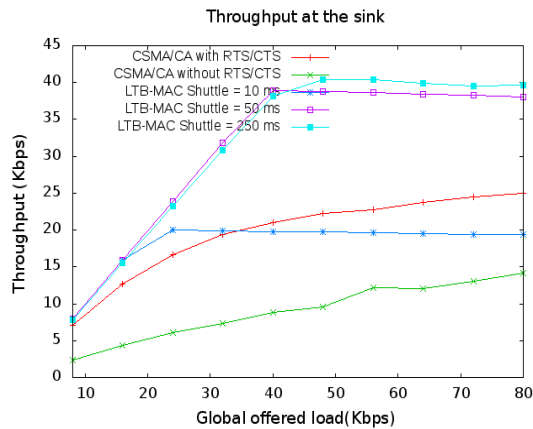

Fig. 6. Throughput at the sink

Fig. 7 shows the delivery ratio as a function of the network load expressed in number of packets per second for three shuttles. For nodes 1 and 5 we can see that the packet delivery ratio at the sink is more important in the case of LTB-MAC protocol than for CSMA/CA protocols with or without RTS/CTS even in a very small shuttle of 10 ms. Indeed, for node 5, the minimum delivery ratio (maximum resp.) is 0.6 (resp. 1), whereas it is 0.11 (resp. 0.85) and 0.28 (resp. 0.25) respectively for the CSMA/CA protocols with RTS/CTS and without RTS/CTS. For node 1, we find a minimal ratio of 0.4 for LTB-MAC whereas it is 0.1 for the CSMA/CA protocols with or without RTS / CTS.

For LTB-MAC protocol we see that the evolution of the curve is divided into two parts.

- Between 10 and 60 packets per second (depending on the shuttle). In this case the delivery rate is equal to 1 because the network is not loaded. So the packets are not victims of overload of the FIFOs.
- Between 60 and 100 packets per second. In this part, the delivery rate decreases gradually as the network is loaded. This is explained by the fact that the FIFOs are overloaded causing packet drops. For node 1, however it realizes that LTB-MAC protocol and CSMA/CA with or without RTS/CTS have the same behavior when the network is very dense.

ARIMA

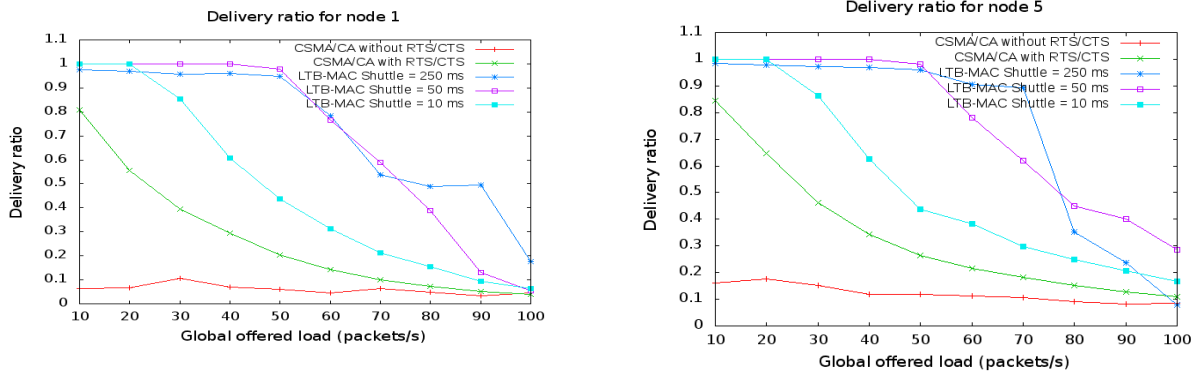

Fig. 7. Delivery ratio for node 1 and node 5

Fig. 8 represents the end-to-end delay as a function of the available overall charge expressed in terms of packets per second. Here again we see that the LTB-MAC protocol reduces considerably the end-to-end delay in comparison to CSMA/CA for all shuttles. It is smaller for the node 5 because it is closer to the wells and thus delivers data faster.

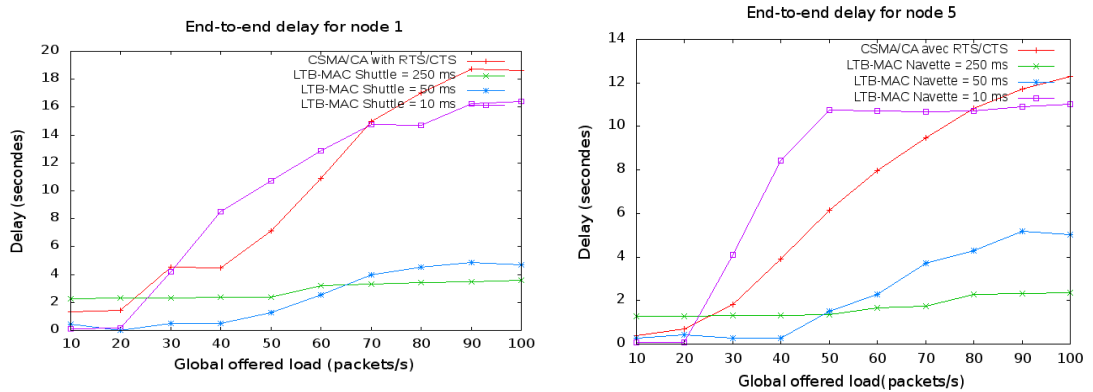

Fig. 8. End-to-end delay for node 1 and node 5

## 8. Conclusion

In this paper propose LTB-MAC based on the generation of a token that gives a node the right to access the transmission channel. It is created by the node that is at the opposite extremity of the sink known as token generator. It contains information on the activity periods of the nodes. The propagation of the token is similar to a shuttle that passes and in which the nodes deposit information to the sink. The shuttle determines the amount of information that a node can send when it is token holder.

We compare LTB-MAC protocol to CSMA/CA in terms throughput, delivery ratio and end-to-end delay. We have shown, thanks to simulations, that the LTB-MAC protocol offers better performance than the CSMA/CA in wireless networks of linear sensors.

In our future work, we plan study the redundancy in sensors using LTB-MAC protocol to better optimize the performance parameters.

## References

- [1] S. Yoon, W. Ye, J. Heidemann, B. Littlefield, and C. Shahabi, "SWATS: Wireless sensor networks for steamflood and waterflood pipeline monitoring," *Netw. IEEE*, vol. 25, no. 1, pp. 50–56, 2011.
- [2] I. Jawhar, N. Mohamed, and K. Shuaib, "A framework for pipeline infrastructure monitoring using wireless sensor networks," in *Wireless Telecommunications Symposium, 2007. WTS 2007, 2007*, pp. 1–7.
- [3] T. T.-T. Lai, W.-J. Chen, K.-H. Li, P. Huang, and H.-H. Chu, "Triopusnet: Automating wireless sensor network deployment and replacement in pipeline monitoring," in *Information Processing in Sensor Networks (IPSN), 2012 ACM/IEEE 11th International Conference on, 2012*, pp. 61–71.
- [4] M. Li and Y. Liu, "Underground coal mine monitoring with wireless sensor networks," *ACM Trans. Sens. Netw.*, vol. 5, no. 2, pp. 1–29, Mar. 2009.
- [5] M. Li and Y. Liu, "Underground Structure Monitoring with Wireless Sensor Networks," in *Proceedings of the 6th International Conference on Information Processing in Sensor Networks, New York, NY, USA, 2007*, pp. 69–78.
- [6] G. Werner-Allen, J. Johnson, M. Ruiz, J. Lees, and M. Welsh, "Monitoring volcanic eruptions with a wireless sensor network," in *Wireless Sensor Networks, 2005. Proceedings of the Second European Workshop on, 2005*, pp. 108–120.
- [7] W. Nan, M. Qingfeng, Z. Bin, L. Tong, and M. Qinghai, "Research on Linear Wireless Sensor Networks Used for Online Monitoring of Rolling Bearing in Freight Train," *J. Phys. Conf. Ser.*, vol. 305, no. 1, p. 012024, Jul. 2011.

**ARIMA**

- [8] M. Zimmerling, W. Dargie, and J. M. Reason, "Localized power-aware routing in linear wireless sensor networks," in Proceedings of the 2nd ACM international conference on Context-awareness for self-managing systems, 2008, pp. 24–33.
- [9] M. FITZSIMONS, "The langed approach," World Pipelines, vol. 5, no. 6, pp. 24–26, 2005.
- [10] T. Karveli, K. Voulgaris, M. Ghavami, and A. H. Aghvami, "DiS-MAC: A MAC protocol for sensor networks used for roadside and highway monitoring," in International Conference on Ultra Modern Telecommunications Workshops, 2009. ICUMT '09, 2009, pp. 1–6.
- [11] C. Fang, H. Liu, and L. Qian, "Lc-mac: An efficient mac protocol for the long-chain wireless sensor networks," in Communications and Mobile Computing (CMC), 2011 Third International Conference on, 2011, pp. 495–500.
- [12] T. Sun, X. J. Yan, and Y. Yan, "A Chain-type Wireless Sensor Network in Greenhouse Agriculture," J. Comput., vol. 8, no. 9, Sep. 2013.
- [13] D. De Caneva, P. L. Montessoro, and others, "A synchronous and deterministic MAC protocol for wireless communications on linear topologies," Intl J Commun. Netw. Syst. Sci., vol. 3, no. 12, p. 925, 2010.
- [14] L. S. Committee and others, "Part 15.4: wireless medium access control (MAC) and physical layer (PHY) specifications for low-rate wireless personal area networks (LR-WPANS)," IEEE Comput. Soc., 2003.
- [15] C. Buratti and R. Verdone, "L-CSMA: A MAC Protocol for Multi-Hop Linear Wireless (Sensor) Networks," 2015.
- [16] E. H. M. Ndoye, F. Jacquet, M. Misson, and I. Niang, "Evaluation of RTS/CTS with unslotted CSMA/CA algorithm in linear sensor networks," NICST, France, 2013.
- [17] E. H. M. NDOYE, F. JACQUET, M. MISSON, and I. NIANG, "A Token-based MAC Protocol for Linear Sensor Networks.," Sens. Transducers 1726-5479, vol. 189, no. 6, 2015.
- [18] E. H. M. Ndoye, F. Jacquet, M. Misson, and I. Niang, "Using a token approach for the MAC Layer of Linear Sensor Networks : Impact of the redundancy on the Throughput," Sensornet, France, 2015.
- [19] T. S. Rappaport and others, Wireless communications: principles and practice, vol. 2. prentice hall PTR New Jersey, 1996.