



HAL
open science

Separation of sedimentary micron-sized particles for palaeoceanography and calcareous nannoplankton biogeochemistry

Fabrice Minoletti, Michaël Hermoso, Vincent Gressier

► **To cite this version:**

Fabrice Minoletti, Michaël Hermoso, Vincent Gressier. Separation of sedimentary micron-sized particles for palaeoceanography and calcareous nannoplankton biogeochemistry. *Nature Protocols*, 2008, 10.1038/nprot.2008.200 . hal-01444137

HAL Id: hal-01444137

<https://hal.science/hal-01444137>

Submitted on 23 Jan 2017

HAL is a multi-disciplinary open access archive for the deposit and dissemination of scientific research documents, whether they are published or not. The documents may come from teaching and research institutions in France or abroad, or from public or private research centers.

L'archive ouverte pluridisciplinaire **HAL**, est destinée au dépôt et à la diffusion de documents scientifiques de niveau recherche, publiés ou non, émanant des établissements d'enseignement et de recherche français ou étrangers, des laboratoires publics ou privés.



Distributed under a Creative Commons Attribution 4.0 International License

Separation of sedimentary micron-sized particles for palaeoceanography and calcareous nanoplankton biogeochemistry

Fabrice Minoletti 1,2, Michaël Hermoso 1,2 & Vincent Gressier 1

1 UPMC Univ Paris 06, JE 2477 Biominéralisations et Paléoenvironnements, Case postale 116, 4 place Jussieu F-75005, Paris, France.

2 These authors contributed equally to this work. Correspondence should be addressed to F.M. (fabrice.minoletti@upmc.fr).

Published online 11 December 2008; doi:10.1038/nprot.2008.200

A protocol is described for separating sub-20 μm -sized particles contained in sedimentary rocks into size fractions. Geochemical data from manually isolated foraminifera are commonly used in the interpretation of marine palaeoenvironments; problems associated with the isolation of calcareous nanofossils hampers their geochemical exploitation. However, geochemistry performed on calcareous nanofossil monotaxic assemblages should provide more meaningful data sets than those generated from the highly heterogeneous bulk carbonate. This protocol is based on cascade filtering steps, using polycarbonate membranes with well-calibrated pores. Strong ultrasonic treatment can further be applied to selectively reduce the size of particles for greater enrichment. Obtained residues frequently comprise near-monotaxic nanofossil assemblages. The application of this technique, which can be achieved within less than 2 days, has provided distinct fractions of coccoliths, calcareous dinoflagellate shells and also diagenetic monocrystals. This protocol is designed for application in reconstructing the history of water-column physicochemistry and diagenesis. It also has the potential to provide insights into the biogeochemistry of calcareous nanoplankton, including vital effects.

INTRODUCTION

Problem statement

Carbonate isotope and trace metal analyses have generated useful data sets for palaeoceanographic reconstructions of pelagic environments. Despite significant improvements in analytical techniques, doubts exist concerning the usefulness of data from bulk sample analysis as reliable indicators of palaeo-seawater chemical composition^{1,2}. This is especially true for carbon and oxygen isotopic studies, where questions remain as the reliability of interpretations because the bulk carbonate data represent an average of different environmental characteristics (in situ production in surface or bottom water-masses, export from shallow environments, post-deposition precipitation and so on). Even if biogenic particles dominate the calcareous assemblages, a bias indubitably arises from discrete isotopic offsets related to distinct calcification environments (depths, season) and/or different vital effects of the various carbonate producers.

Objectives of this technique

The geochemistry of calcareous nanofossils, and its potential in surface-water reconstructions, has attracted considerable attention over the past 10 years because they are the dominant carbonate component in pelagic sediments since the Jurassic period, ca. 200 Myr ago, and because they are both a major carbonate producer and sink for carbon, which has implications for the regulation of past and future climates ('Anthropocene' Earth). As calcification in phytoplanktonic organisms is

restricted to the photic zone, selective analyses of coccoliths could capture more precise and reliable data for estimating palaeoseawater chemistry.

The purpose of our technique is to isolate monotaxic assemblages for measuring their specific geochemical compositions. We describe a protocol on the basis of microfiltration and ultrasonic treatment that enables the isolation of various fractions of a sediment. We also describe sediment preparation steps that make this technique suitable for different lithologies, irrespective of the original particle assemblage.

Previous techniques and alternative methods

Species-specific analyses are routinely performed on foraminifera and have generated valuable data sets for palaeo-seawater reconstruction (e.g., through the Neogene³). These calcareous microfossils are relatively large (>63 µm), so manual picking is appropriate to extract them from washed and sieved residues of marine sediments.

Such an approach is not possible for separating <20 µm-sized particles, such as nannofossils and diagenetic crystals. A number of techniques have, however, been published in this end^{4–7}, using wet sieving and decantation-centrifuge. Sieving may not be successfully used to manage coccolith separation because the classical mesh apertures are larger than the size of most nannofossils, and the squared structure of sieves impairs efficient separation of flat particles such as coccoliths. Decantation/centrifuge separates particles according to their relative weights, densities and flatness but is difficult to calibrate, as settling laws are described for spherical objects only and the influence of convection currents in settling tubes is ignored. Thus, both of these techniques prove rather inefficient for separating coccolith taxa.

In addition to these more conventional methods, three studies have brought significant advances to calcareous nanoplankton geochemistry:

- A study of Quaternary calcareous oozes using an automated decanting device on <38 µm-sieved fractions⁸. The decantation was repeated up to ten times to purify the fractions that are enriched in calcareous nannofossils (<50%).
- A technique was developed, on the basis of repeated decanting steps of <32 µm-sieved fractions, subsequently treated using density-stratified columns⁹. A small quantity of material was poured into a graduated tube and, after 5 h settling, small aliquots of suspension were taken from six different depths in the density column. As a result, the main taxon components ranged from between 40 and 90% in mass.
- Most recently a micropicking method using an inverted light microscope and micromanipulator has been described¹⁰.

Although permitting ion probe measurements on few individual nannofossil specimens, this technique is hugely time consuming, requires expansive apparatus and is suitable for only the largest nannofossils. The protocol described here is that first originally described in 2001¹¹ in French. It has been applied for coccolithophorid biogeochemistry studies^{12–15} and palaeoceanographic reconstructions of various geological periods: Cretaceous-Palaeogene interval^{16,17}, Pliocene¹⁸ and Early Toarcian¹⁹. However, since 2001, considerable technical improvements^{14,15,20} have been evolved that are incorporated in this protocol. More significantly, we provide here a step-by-step procedure enabling its easy implementation.

Overall strategy for separating micron-sized sedimentary particles

Factors for consideration in separating calcareous particles. The major contributors to pelagic calcareous sediments are foraminiferal tests, coccoliths, calcareous dinoflagellate cysts (calcispheres) and nannoliths. Among these biogenic particles, the predominant size range of the nannofossils is from 2 to 25 μm , with certain taxa restricted to particular ranges (Table 1). Apart from separating the nannofossils from coarse foraminifera, their fragments and fine carbonates (micarbs), microfiltration within the 2 to 25 μm -size spectrum can efficiently separate nannofossils' taxa from each other. Further 'purification' can be achieved by reducing the size ranges of target particles by exploiting their differential gross morphological structures (Table 1).

Granulometric separation: microfiltration. The separation of <20 μm particles is achieved by microfiltration, using polycarbonate membranes etched by well-calibrated, cylindrical pores (Fig. 1). The membranes act like sieves, with particles smaller than the pores passing through the membrane being physically separated from the larger ones that remain on it. These filtering media can be confidently used because (i) they are physically resistant, (ii) they are chemically inert, so do not induce any chemical contamination and (iii) their smooth surfaces allow easy recovery of the material after treatment. These membranes are classically used in solid–liquid separation with Nalgene or polycarbonate filtration units. For solid–solid separation, as described herein, we have devised a separation column using a versatile screwthread system (SVL42) pyrex tube (Fig. 1). The filtration is facilitated by an ultrasonic-induced shaking that reduces membrane clogging. To avoid nannofossil breakage, it is necessary to use only a moderately powered ultrasonic source (between 50 and 75 W at 40kHz frequency). As proved on *Emiliana huxleyi* assemblages²¹, such a gentle treatment results in negligible coccolith fragmentation and dissolution.

TABLE 1 | Main calcareous components encountered in presented samples with their respective size spectra and microstructures.

| Producers | Sedimentary components | Size spectra | Microstructures |
|----------------------------|---------------------------------|---------------------|-----------------------------------------------------------|
| Foraminifera | Foraminiferal tests | >63 μm | Multilayered wall chambers |
| | Foraminiferal fragments | >5 μm | |
| Coccolithophorids | Coccoliths | 2–12 μm | Imbricated calcite platelets (V/R model) |
| Discoasterids | Discoasters | 7–15 μm | Nonoverlapping monocrystalline rays |
| Calcareous Dinoflagellates | Calcispheres | 10–25 μm | Slightly overlapping crystals arranged in a hollow sphere |
| (Nonbiogenic?) | Rhombs and xenomorphic crystals | 3–30 μm | Monocrystalline |
| | Micarbs | <3 μm | |

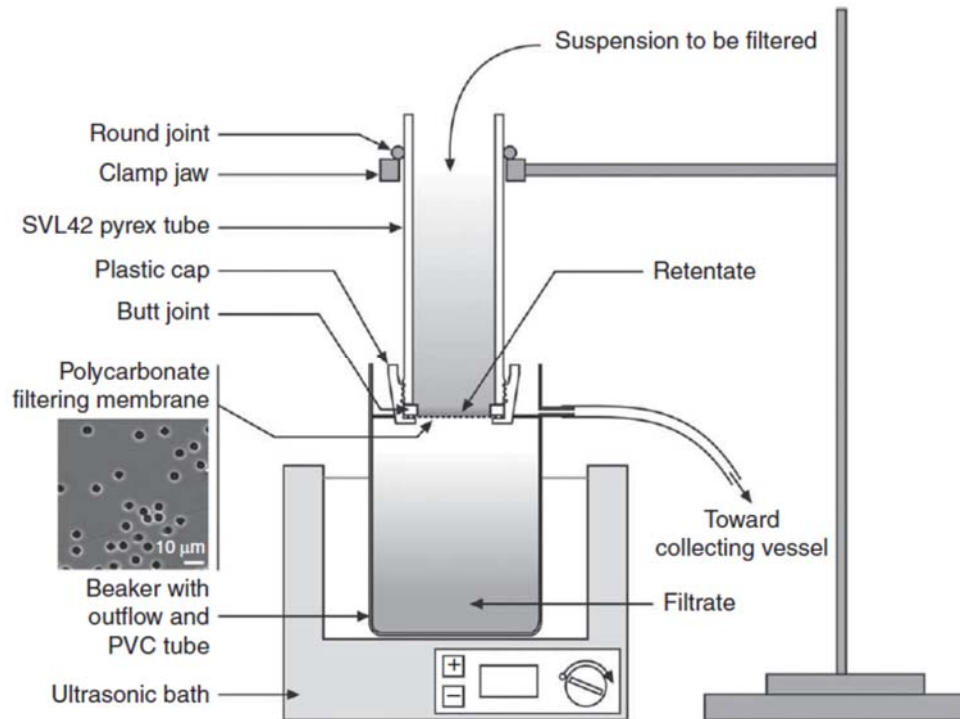

Figure 1 | The microfiltration apparatus; schematic diagram of the filtration column. On the left-hand side: the different parts of the material; on the right-hand side: the different suspensions obtained during filtration. The suspension to be filtered is split into a retentate containing particles larger than the micropore diameter and a filtrate with smaller particles that automatically flows in a collecting vessel through a PVC outflow tube.

Selective breakage of particles by strong ultrasonic supply. The reduction in the size of particles is obtained by targeted breakage using an ultrasonic disintegrator (Fig. 2). Such a treatment causes violent implosions of air bubbles by cavitation, which expose the particles to strong acceleration likely to induce their breakage. Monocrystals and blocky nanofossils (e.g., *Crepidolithus*, *Nannoconus*, *Micula*) are relatively resistant to this treatment, whereas other polycrystalline biogenic structures (e.g., calcispheres, discoasters and delicate coccoliths) are more susceptible. After treatment, an additional filtration is applied for separating fragments of fragile nanofossils from unaltered resistant particles.

MATERIALS

REAGENTS

- Sediment to be treated
- Deionized water
- Concentrated ammonia solution for correcting the pH of deionized water ! CAUTION Corrosive and dangerous for the environment. Store in a cool, dry and well-ventilated area. May be hazardous at high concentrations. Manipulate under fume board, use gloves and wear safety goggles during REAGENT SETUP.
- Benzalkonium chloride (BKC; Prolabo, cat. no. 21797.232) for clay-rich samples ! CAUTION Corrosive and dangerous for the environment. May be hazardous at high concentrations. Manipulate under fume board, use gloves and wear safety goggles during REAGENT SETUP.

- Sodium hypochlorite solution, 13% active chlorine, for organic-rich samples as black shale or sapropel ! CAUTION Toxic. Store in a cool, dry and well-ventilated area. May be hazardous at high concentrations. Manipulate under fume board, use gloves and wear safety goggles during REAGENT SETUP.

EQUIPMENT

- 47mm polycarbonate membranes (Millipore, cat. nos. TKTP04700 for 12 μm ; TCTP04700 for 10 μm ; TETP04700 for 8 μm ; TMTP04700 for 5 μm ; TSTP04700 for 3 μm ; TTTP04700 for 2 μm)
- Housing for membrane can be any universal screw thread setting fitting with the membrane diameter (Bibby Scientific, cat. no. SVL42):
 - 200mm-long Pyrex tube
 - silicone butt joint acting as sealing ring
 - drilled plastic cap
- 400ml-tall form beaker set with a factory-made outflow (2cm glass horizontal tube with external diameter 9 mm fused 1 cm below the top of the beaker)
- Collection vessel (e.g., 1L beaker or any other container)
- Polyvinyl chloride (PVC) flexible (internal diameter 8/9 mm) to be set around the outflow tube of the beaker
- Aluminum clamps with vinyl-covered jaws
- Round joint (maximal internal diameter 42 mm)
- Digital ultrasonic bath with single frequency and variable output power (40 KHz, 30–180 W)
- Disintegrator (Branson Sonifier D-450 or equivalent digital model) composed by an ultrasonic digital processor (minimal output power 400 W), a disruptor with titanium horn and temperature probe
- Heavy duty beaker
- Polarizing light microscope (Zeiss, Axioskop40) equipped with a digital camera

REAGENT SETUP

- The deionized water (usually near pH 5.5 due to its under-saturation with respect to alkaline ions as Ca^{2+}) must be neutralized to avoid calcite dissolution. Required 'neutralized deionized water' thereafter is obtained by addition of 5% ammonia in deionized water (check with pH paper). As an indication, appropriate alkalinity (pH 8) is reached by adding 0.5 ml of 5% ammonia in 5 liters of deionized water.
- The diluted BKC solution is obtained by stirring 1 g of BKC powder in 1 liter of deionized water. BKC is weakly alkaline, ammonia addition is not necessary.
- The sodium hypochlorite solution is used pure and also without ammonia addition.

EQUIPMENT SETUP

Microfiltration column

1. Set the round joint around the nonthreaded end of the tube (Fig. 1).
2. Set the SVL42 tube top-down (threaded end up) on a bench.
3. Place the silicone butt joint on the top of it, wet it with deionized water and place the filtration membrane (shiny side down) on it.
4. Gently screw down the drilled cap to tighten the membrane horizontally.

■ CRITICAL Over-tightening of the screw can cause folding of the filter around the edges, which may damage the filter.

5. Set PVC flexible (15 cm length) around the outflow tube of the beaker.

6. Fill the outflow beaker with neutralized deionized water up to the outflow.

7. Place this beaker into the ultrasonic bath.

8. Fill the ultrasonic bath.

9. Place the end of the PVC tube in the collecting vessel.

10. Immerse the base of the filtration column 1 cm deep in the outflow beaker. ■ CRITICAL The column must be immersed obliquely to evacuate the air volume otherwise trapped below the membrane. Air bubbles may be completely removed by a rapid, oblique immersion of the column in the outflow beaker.

11. Fix the filtration column to the stand by laying the round joint onto the clamp. ■ CRITICAL The column clamp should not be firmly fixed to the clamp to avoid attenuation of ultrasonic waves.

Disintegrator apparatus

1. Clamp the disintegrator horn and thermal probe to the stand (Fig. 2).

2. Set the intensity of ultrasonic emission at maximal power (100%, 400 W).

3. Set on/off cycles at 2/5 s, respectively.

4. Set an end point of treatment when the temperature of the suspension reaches 40 °C. A cooling bath should help preventing excessive and rapid heating.

5. Immerse the disintegrator horn into the beaker according to the supplier's recommendations to get most efficient results.

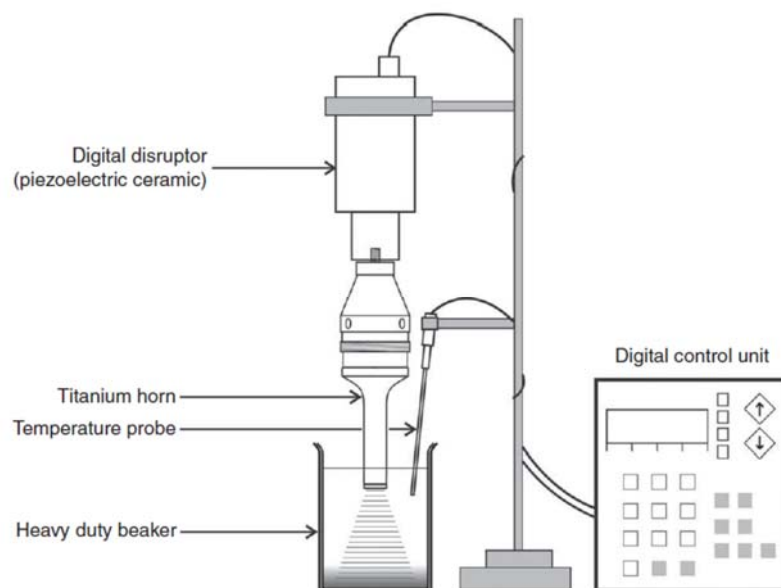

Figure 2 | The ultrasonic disintegrator composed by the digital controller, the disruptor and the sonicator horn. The level of immersion of the probe and the load of the suspension must be regarded as important factors for obtaining efficient results (see text).

PROCEDURE

Sample preparation and fine fraction sieving

1| **Disaggregation of sediment.** Weigh an aliquot of sediment. Usually, about 5 g are appropriate to provide sufficient material in each separated fraction for optical and geochemical analyses and is not too great an amount for the filter to cope with. The nature of the sample dictates the method of disaggregation. We describe routes for: nonlithified pelagic sediments (oceanic oozes, option A), indured sediments (limestones, option B), clayey sediments (marls, CaCO₃ >50 wt%, option C) and organic-rich sediments (black shales, total organic carbon >5 wt%, option D).

(A) Nonlithified pelagic sediments

(i) Place the sediments or pelagic oozes into neutralized water.

(ii) If the disaggregation is not immediately obtained, gently stir the suspension with glass rod.

(iii) Allow the suspension to settle and remove the supernatant that contains dissolved NaCl to prevent subsequent salt recrystallization.

(B) Indured sediments: soft disaggregation of limestones

(i) Crush gently the sediment in an agate mortar to obtain <1mm pieces.

(ii) Place the crushed sediment into neutralized water.

(iii) Burst the suspension using gentle ultrasonic treatment by immersing the beaker in the ultrasonic bath (30 W for about 1 h).

■ CRITICAL STEP Ensure that all visible aggregates are eliminated.

? TROUBLESHOOTING

(C) Marly sediments: unbinding argillaceous material in clay-dominated samples

(i) Gently crush the sediment in an agate mortar to obtain >1mm pieces.

(ii) Place rock fragments into diluted BKC solution for about 1 d with intermittent shakes.

■ CRITICAL STEP Ensure that all visible aggregate has been removed. If not, repeat the previous step.

? TROUBLESHOOTING

(iii) After settling, remove the supernatant to remove excessive BKC.

(D) Organic-rich sediments: oxidizing pretreatment

(i) Gently crush the sediment in an agate mortar to obtain <1µm pieces.

(ii) Place rock fragments into neutralized water.

(iii) Expose the suspension to soft ultrasonic treatment immersing the beaker in the ultrasonic bath (30 W for about 1 h).

(iv) Allow the suspension to settle and remove the supernatant.

(v) Add the sodium hypochlorite solution and leave overnight.

■ CRITICAL STEP Ensure that all visible aggregates have been removed.

? TROUBLESHOOTING

(vi) Rinse the suspension five times by centrifuge (2,500g, or usually 4,000 r.p.m., 10 min) to eliminate dissolved organic matter and hypochlorite ions.

2| Recovery of coarse fractions. Sieve the disaggregated suspension through 315 and 50 μm sieves (depending on the microfossil assemblage, any additional sieving step may be applied).

3| Oven-dry (60 $^{\circ}\text{C}$, overnight) and weigh all residues.

4| Inspect all fractions under a binocular reflecting-light microscope. Where possible, extract microfossils by conventional manual-picking techniques⁷.

Microfiltering steps

5| Implementation of a microfiltering step. Dilute the suspension to be filtered according to Table 2.

6| Set the output power of the ultrasonic tank as given in Table 2.

TABLE 2 | Indicative parameters for microfiltration steps: suspension loads, ultrasonic bath output powers and timing (for 150 ml of suspension at given load).

| | Microfiltering steps | | | | | |
|-------------------------------------------|----------------------|------------------|-----------------|-----------------|-----------------|-----------------|
| | 12 μm | 10 μm | 8 μm | 5 μm | 3 μm | 2 μm |
| Suspension loads (g liter ⁻¹) | 5 | 5 | 3 | 3 | 1 | 1 |
| Output power (W) | 30 | 30 | 30 | 30 | 60 | 60 |
| Filtration timing for each 150 ml (min) | 10 | 15 | 30 | 45 | 60 | 90 |

7| Pour few milliliters of neutralized water into the filtration column to initiate the filtration.

8| Switch on the ultrasonic bath.

9| Pour the suspension to be filtered into the filtration column (Fig. 1).

10| Ensure the efficiency of the filtration by observing the filtrate (turbid suspension) mixing with pure water below the membrane. The volume of suspension in the filtration column rapidly decreases at the beginning of the treatment. Meanwhile, the beaker fills up to the outflow level, and then the excess suspension flows down to the collecting vessel. ? TROUBLESHOOTING

11| At the end, when only few milliliters of slurry (filtration retentate) remain on the membrane, take off the filtration column. Set the retentate aside in a 200 ml beaker.

12| Set the column back and replenish it with the suspension to be filtered. Steps 11 and 12 must be repeated until all materials are processed.

13| When filtration is complete, stop the ultrasonic bath.

14| Take off the filtration column and set the retentate aside in the beaker.

15| Combine the filtrate suspensions contained in the outflow beaker and the collecting vessel.

16| Purity control of obtained fractions. Check the granulometric homogeneity of both retentate and filtrate by smear-slide inspection; evaporate 1 ml of the suspension on a cover glass. Set the cover glass on the smearslice with optical glue. ? TROUBLESHOOTING

17| Oven-dry (60 1C) and weigh the retentate.

18| Reserve the filtrate for further process if required; if not, centrifuge it (4000 r.p.m., 10 min). Oven-dry (60 1C, overnight) and weigh it.

Strong ultrasonic treatment

19| Intended particle breakage. Weigh a 500mg aliquot of sample (bulk sample or granulometric fraction).

20| Switch on the ultrasonic digital unit.

21| Pour 200 ml of neutralized water into the heavy-duty beaker.

22| Stir the aliquot in the beaker.

23| Immerse the disintegrator horn.

24| Start the sonicator.

! CAUTION Long-term treatment could damage your hearing. Use of protective ear-muff is highly recommended.

■ CRITICAL STEP Proceed in short, incremental steps, followed by smear-slide observation to check results. This allows to control the particle breakage. As an indication, these steps may be run for 2 min for hollow particles (e.g., calcispheres) and nannofossils with nonoverlapping crystal units (e.g., discoasters); 5 min for coccoliths with strongly imbricate crystal units.

25| After the treatment, switch off the sonicator.

26| Take the sonicator horn off the suspension.

27| Centrifuge and remove the supernatant, which contains dissolved carbonates.

28| Investigate the modified assemblage by smear-slide observation and select the target size fraction.

29| Separation of fragmented particles. Implement the appropriate microfiltering step(s) for recovering particles as detailed in the 'Microfiltering steps' section (Steps 5–18) above.

● TIMING

The time required to perform this separation may significantly vary depending on the nature of the sample to be treated.

Average durations are given below:

Step 1: 2 min

Option A: 5 min

Option B: 1.5 h

Option C: 2–6 h; may be left overnight

Option D: 2 h and hypochlorite bleaching and left overnight

Step 2: 0.5 h

Step 3: overnight

Step 4: indeterminate

Steps 5–18, depending on the quantity of material to be processed: from 2 h for 12 and 10 μm filtering steps to 6 h for 3 and 2 μm filtering steps

Steps 19–27: 1.5 h

Step 28: indeterminate

Step 29: see duration for Steps 1–5 above.

? TROUBLESHOOTING

Troubleshooting advice can be found in Table 3.

ANTICIPATED RESULTS

Here, we illustrate the results of microgranulometric separations and combining strong ultrasonic and microfiltering steps applied to various lithologies. Although fractions obtained in this way can be used for a variety of applications, we present herein palaeoceanographical and biogeochemical insights derived from carbon and oxygen isotope proxies to illustrate the potential of this protocol^{13–19}.

Results of microfiltering separations

Results for three examples are described: (i) pelagic oozes; (ii) lithified sediments; and (iii) black shales.

Pelagic oozes. We present results from two Neogene pelagic oozes: a Miocene (ca. – 15 Ma) ooze from Ocean Drilling Program Leg 121 site 758A (Northern Indian Ocean) and a Pliocene (ca. – 5 Ma) ooze from Deep Sea Drilling Program Leg 8 site 74 (Western Central Pacific)^{13–15}. Pretreatments were applied as described in Step 1A followed by microfiltering steps at 12, 8, 5 and 3 μm . Compositions of the fractions are similar for both samples as summarized in Table 4, and illustrated by microphotographs in Figure 3. In detail, the coarse fractions contain exclusively foraminifera tests, either entire specimens (>315 μm , 50 to 315 μm fractions obtained by sieving) or fragments (12 to 50 μm fractions recovered by the first filtration step). Discoasterids and small foraminiferal fragments dominate 8 to 12 μm and 5 to 8 μm fractions for both samples. Coccoliths (mainly *Reticulofenestra* genus) are concentrated in 3 to 5 μm fractions. Finally, <3 μm fractions contain the smallest coccoliths (small reticulofenestrids) along with micarb particles.

TABLE 3 | Troubleshooting table.

| Step | Problem | Possible reason | Solution |
|------------------------------------|-----------------------------------------------------------------------------------------------------------------------|---------------------------------------------------------------------------------------|-----------------------------------------------------------------------------------------------------------------------------------------------------------------------------------------------------------------------------------------------------------------------------------------------|
| 1B(iii), 1C(ii) and 1D(v) | Lithogenic fragments remain in the suspension | The suspension load is too high, so particles settle down to the bottom of the beaker | <ul style="list-style-type: none"> • Split the suspension into two beakers and complete with neutralized water • Repeat soft ultrasonic treatment further |
| | | The organic matter content is high | <ul style="list-style-type: none"> • Add a pretreatment route D • Proceed ultrasonic treatment further |
| 10 | The suspension volume in the filtration column decreases rapidly, even if the ultrasonic bath is off | The membrane is probably damaged | <ul style="list-style-type: none"> • Dismount the filtration column • Change the membrane |
| | The efficiency of filtration decreases too much during treatment | The suspension load is too heavy, so a cake has settled down on the membrane | <ul style="list-style-type: none"> • Stop the ultrasonic bath • Empty the filtration column • Dilute the suspension • Set the column back (microfiltration column setup Steps 10 and 11) • Resume microfiltering step (from Step 5 onward) |
| 16 | The retentate contains particles smaller than the openings (i.e., expected to be collected in the filtrate) | The load of the suspension is too high | <ul style="list-style-type: none"> • Proceed the microfiltering step again with the retentate suspension |
| | The filtrate contains particles smaller or larger than the openings (i.e., expected to be collected in the retentate) | The membrane may be damaged | <ul style="list-style-type: none"> • Set a column filtration with a new membrane • Proceed the microfiltering step again with the filtrate suspension |

TABLE 4 | Relative mass abundances of separated fractions and their compositions in terms of calcareous components.

| Samples | Techniques Size ranges key to pie charts | Wet sieving | | Microfiltering step | | | Centrifuge | | Granulometric distribution |
|----------------------------|------------------------------------------------|----------------------------|----------------------------|------------------------------------------|---------------------------------------------------|---------------------------------------------------|-------------------------|------------------------|-------------------------------|
| | | > 315 μm 315 | 50–315 μm 50 | 12–50 μm 12 | 8–12 μm 8 | 5–8 μm 5 | 3–5 μm 3 | < 3 μm m | |
| ODP Site 758A | Carbonate fraction (wt) | 2% | 15% | 13% | 11% | 10% | 21% | 28% | |
| Miocene pelagic ooze | Composition | Entire foraminifera | Entire foraminifera | Foraminifera fragments | Discoasters (60%) Foraminifera fragments (40%) | Discoasters (80%) Foraminifera (20%) | Coccoliths | Micarbs | |
| DSDP Site 74 | Carbonate fraction (wt) | 0.5% | 4.5% | 20% | 7% | 8% | 15% | 45% | |
| Pliocene pelagic ooze | Composition | Entire foraminifera | Entire foraminifera | Foraminifera fragments | Discoasters (60%) Foraminifera fragments (40%) | Discoasters (60%) Foraminifera fragments (40%) | Coccoliths | Micarbs | |
| Bidart | Carbonate fraction (wt) | — | — | 14% | 4% | 13% | 20% | 49% | |
| Danian calcareous clay | Composition | | | Monocrystals (60%) Calcispheres (40%) | Monocrystals | Calcareous nannofossils | Calcareous nannofossils | Micarbs | |
| Bascharage | Carbonate fraction (wt) | — | 9% | 11% | 2% | 8% | 2% | 68% | |
| Early Toarcian black shale | Composition | | Lithogenic fragments | Monocrystals | Monocrystals Calcispheres | Coccoliths Calcispheres | Coccoliths | Micarbs | |

Pie chart diagrams represent the granulometric distribution of the whole carbonate fraction in sample.

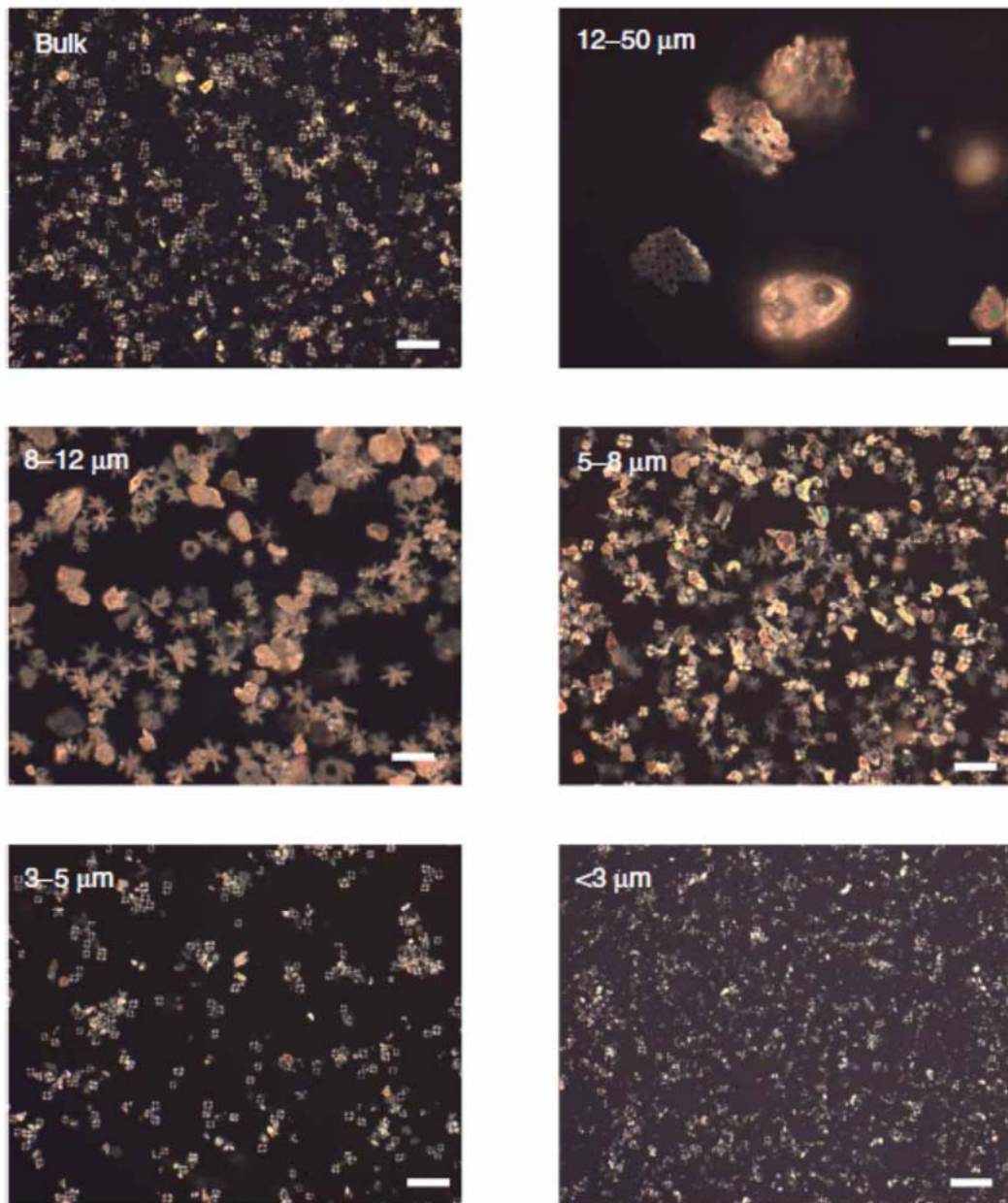

Figure 3 | Cross-polarized microphotographs of site 758A (Miocene, Indian Ocean) bulk sample and separated fractions (scale bar, 20 μm). Compositions of fraction are summarized in Table 3. Note the nearly pure *Reticulofenestra* assemblage recovered in the 3 to 5 μm fraction.

Lithified sediments. A lowermost Palaeocene (ca. – 65 Ma) calcareous clay from Bidart section (southwest France) sampled three centimeters above the Cretaceous-Palaeogene iridium layer was processed according to Step 1C followed by microfiltering steps at 12, 8, 5 and 3 μm (see ref. 16). Compositions of the fractions are summarized in Table 4. Coarse particle abundance is very low (rare foraminifera). Smooth prism monocrystals dominate the 8 to 12 μm fraction, but they coexist in a same proportion than *T. operculata* calcispheres in the >12 μm fraction. The 5 to 8 μm and 3 to 5 μm fractions consist of calcareous nanofossil assemblages. The finest fraction is mainly composed of micarb fraction, dominant with respect to coccolith debris, originally present in the pristine sample.

Black shales. Similar microfiltering steps can also be efficiently applied on organic-rich sediments as black shales (Fig. 4a)¹⁹, but require previous specific treatment to remove the organic matter⁶ as described in Step 1D. Once the carbonate particles are unbound from organic-cemented flakes, it is possible to separate coccolith species from each other and from other abiogenic carbonate particles¹⁹. Thus, it has been possible to process black shales from the Lower Toarcian in Paris Basin ('Schistes carton' Formation, ca. –185 Ma) in which the mean organic content reaches 10 wt% (phytoplanktonic organic matter) and carbonate content 30 wt%. After oxidation of the sample, cascade microfiltering steps have provided numerous coccolith-dominated fractions as exemplified on a 3 to 5 μm fraction from Bascharage section in Luxembourg (Fig. 4b).

Further enrichments in obscure particles using ultrasonic treatment.

Two examples for this treatment are described: (i) recovery of Discoaster rays from the Pliocene ooze; and (ii) recovery of Thoracosphaera fragments from Palaeocene marl.

Recovery of Discoaster rays from the Pliocene ooze. From the 8 to 12 μm fraction obtained for Pliocene ooze, a strong ultrasonic treatment (400 W, 20 min) was carried out to break up star-shaped Discoaster by dismembering their monocrystalline rays from each other (Fig. 5)^{13,15}. As produced particles have a low-size spectrum, they can be recovered in the filtrate of an additional filtration at 8 μm (Fig. 6a), whereas resistant foraminiferal fragments keep their pristine sizes and are concentrated in the retentate.

Recovery of Thoracosphaera fragments from Palaeocene marl. A strong ultrasonic step (400 W, 10 min)¹⁶ was implemented on a blend of biogenic/diagenetic assemblage originally recovered in the >12 μm fraction of Palaeocene calcareous clay. During this treatment, the calcispheres are fragmented into small (<12 μm) debris consisting of irregular chips because of their hollow structure, whereas massive diagenetic crystals remain unaffected. A subsequent filtration at 12 μm has afforded isolation of the two components. As a result, the <12 μm fraction is highly dominated by calcisphere debris (Fig. 6b), and the >12 μm assemblage is pure in monocrystals (Fig. 6c).

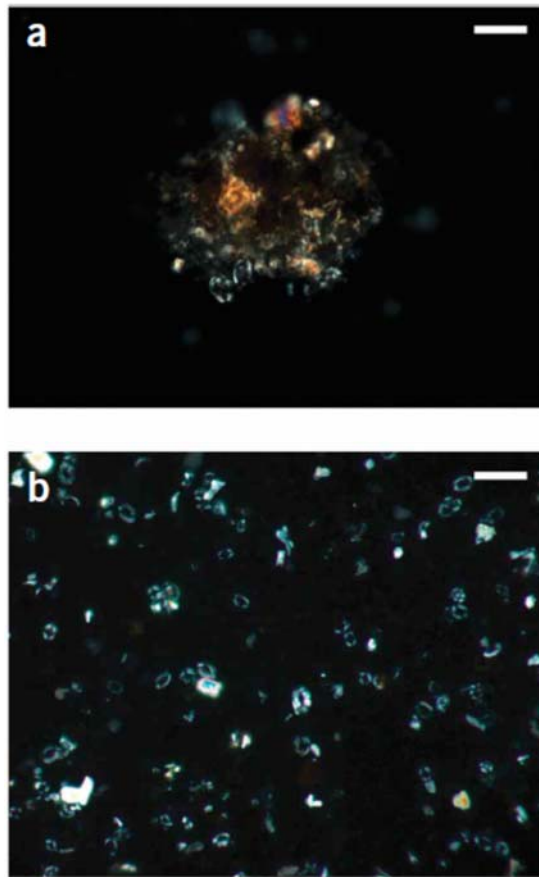

Figure 4 | Cross-polarized microphotographs of Early Toarcian black shale, Bascharage section, Luxembourg (scale bar, 10 mm). (a) Nontreated bulk sample in which most micron-sized sedimentary components are trapped in organic matter-cemented flakes associated with pyrite framboids. These hamper effective microfiltering separation. (b) Coccolith-rich fraction obtained after oxidation of the sample by sodium hypochlorite (Step 1D) and microfiltering steps (3 and 5 mm).

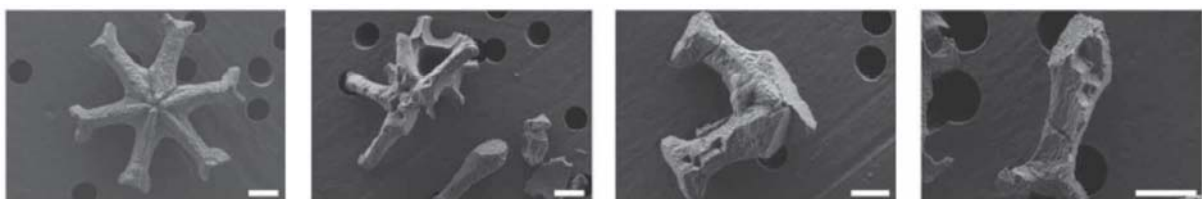

Figure 5 | Evolution of star-shaped discoasterids breakage induced by strong ultrasonic treatment (scale bar, 2 mm). The fragmentation occurs at contact surfaces between calcite units (Discoaster rays) and selectively reduces the size of these fragile particles. Isolated rays can be recovered by a subsequent filtering step.

Biogeochemical and palaeoceanographical insights

The main purpose of the separation method is to perform specific geochemical analyses on monogenetic assemblages. From examples presented above, we combine quantification of sedimentary components and targeted geochemistry. These are discussed under the headings: differential vital effect evaluation; and refinement of microcalcitic particles characterization.

Differential vital effect evaluation. Isotopical signals measured on *Reticulofenestra*, *Thoracosphaera* and *Discoaster* assemblages represent innovative data sets capable of generating further advances in palaeoceanography and calcareous nannoplankton biogeochemistry. Separating nanofossils from each other helps in evaluating their differential vital effects^{13,22}, seek bias in the geochemical record caused by producer assemblage change and eventually derive actual seawater fluctuations. Taxa for which culture studies provided isotopic fractionation factors^{23–25} may be used as ‘anchor points’ for estimating fractionation ranges for other taxa in the same assemblage²². Alternatively, applied isotopic corrections can be approximated from closest living relative data²⁶.

For example, we illustrate such an approach by comparing *Reticulofenestra* spp. coccolith data with discoasterids to infer the underexplored biogeochemistry of these extinct taxa. In the Pliocene ooze from site 74, calcite oxygen isotope composition of *Reticulofenestra* coccolith and *Discoaster* are -0.60‰ and -0.40‰ , respectively (Fig. 7a). Assuming that both organisms thrive together in the upper photic zone^{27–29}, this $+0.20\%$ offset in oxygen isotopes may be ascribed to a differential vital effect. Then, using a -2.00‰ correction factor for oxygen isotopes of *Reticulofenestra* coccoliths^{24,30}, we can tentatively infer a -2.20‰ absolute vital effect for the considered discoasterids. Other examples should be studied to further constrain *Incertae sedis* discoasterid biogeochemistry.

Beyond this example, such an approach is possible for most nannoplankton taxa.

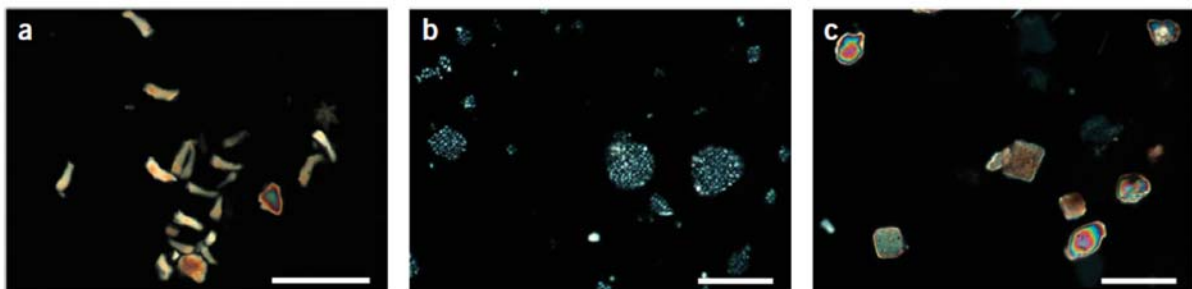

Figure 6 | Monogenetic assemblages obtained after strong ultrasonic treatment and recovered by a microfiltering step (scale bar, 20 μm). (a) *Discoaster* ray-rich assemblage obtained from 8 to 12 μm fraction of site 74 Pliocene ooze. (b) *Thoracosphaera* fragment-rich assemblage from 8 to 12 μm fraction of Palaeocene calcareous clay, Bidart section. (c) Calcitic monocystal-rich assemblage obtained from 8 to 12 μm fraction of Palaeocene calcareous clay, Bidart section.

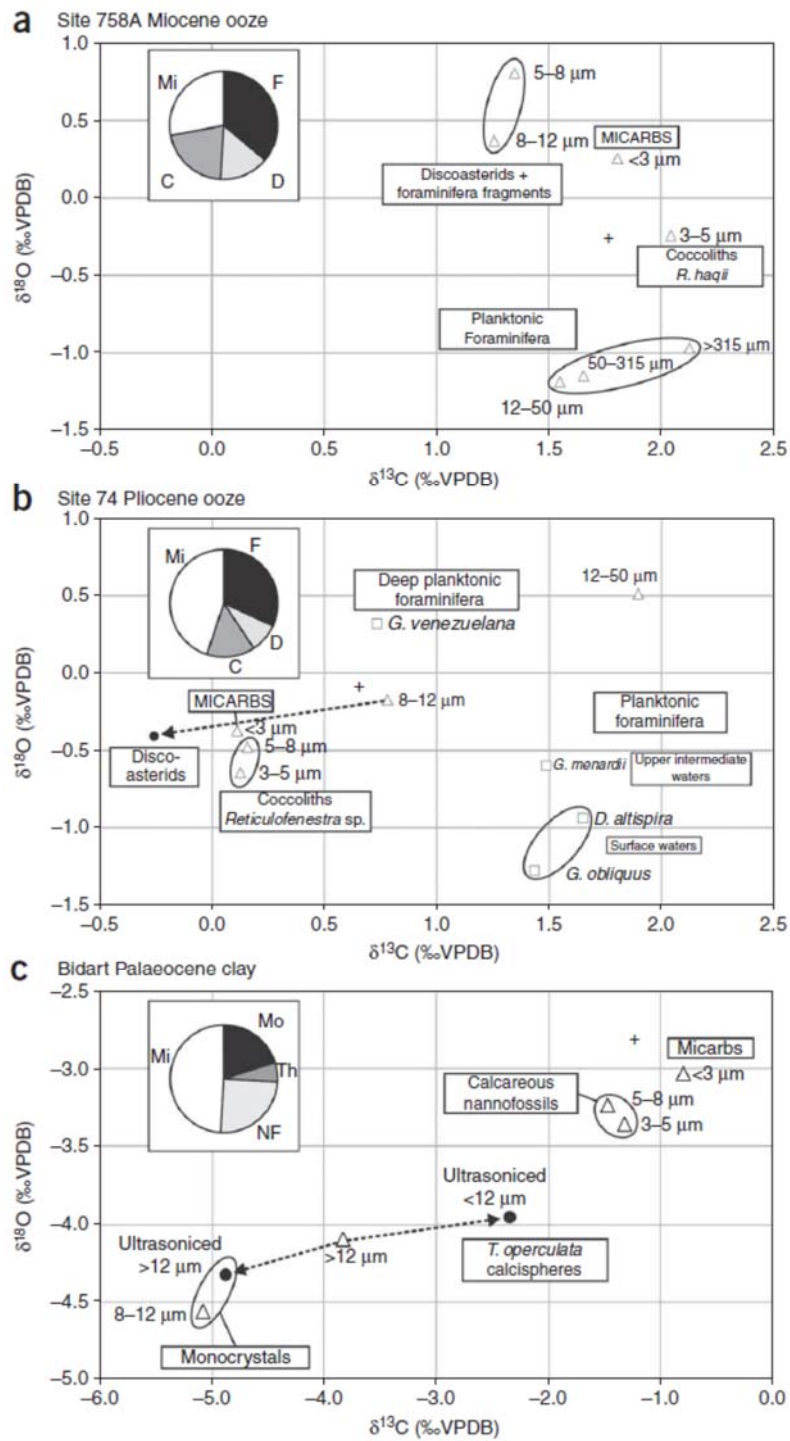

Figure 7 | Scatter diagrams (C and O isotope ratios) of bulk carbonate (crosses), separated fractions (triangles for granulometric fractions and filled circle for ultrasonicated residues) and manually picked foraminifera (squares) with depth stratification given by previous works³⁴. Pie chart diagrams (upper left) indicate the calcareous composition of bulk carbonate. F, foraminifera (including entire and fragmented tests); D, discoasterids; C, coccoliths; Mi, micarbs; Mo, calcareous monocrystals; NF, calcareous nannofossils; Th, Thoracosphaera calcispheres. (a) Site 758A ooze (Miocene, Indian Ocean). (b) Site 74 ooze (Pliocene, Pacific Ocean). (c) Calcareous clay (Palaeocene, Bidart section).

Refinement of microcalcitic particles characterization (so-called micarbs). The origin of micarbs drew considerable debate^{31,32}. However, their characterization and quantification are difficult from microscopic inspection of bulk sample because this phase forms a cryptocrystalline background in smear-slide, even at high magnification. When appropriately used (neutralization of deionized water, gentle ultrasonic treatment), the presented protocol preserves the pristine size and shape of particles. As a consequence, micarbs gathered in <3 μm fraction were originally present from pristine samples. Innovative results generated for this finest fraction (Table 4) challenge the importance of micarbs with respect to definite biogenic components as illustrated previously with the same protocol^{17–19}. Being capable to isolate and concentrate micarbs from coarser particles, this protocol may afford to greatly improve their optical and electronic observations, and also to provide access to their geochemical composition.

For Neogene oozes, neither the abundance nor the nature of such a microcrystalline phase can be confidently deduced from bulk observation (Fig. 3, see bulk sample). However, <3 μm fractions provide more details on these micarbs because the weight of these fractions allows a direct measurement of their relative mass contribution with regard to the whole sample. Moreover, as they are concentrated in this fraction, their observation is not hampered by coarser particles.

In this case, this phase comprising 28% and 45% for both treated pelagic oozes (Table 4) is mainly derived from nannofossils fragmentation (Discoaster and Reticulofenestra fragments). This may also be inferred by geochemical data because both isotopic signatures are relatively close: for site 758A Miocene ooze (Fig. 7a), <3 μm fraction signatures are intermediate between coccolith fraction (3–5 μm) and discoaster fraction (5–8 μm), and for site 74 Pliocene ooze (Fig. 7b), micarb isotopic signatures (<3 μm fraction) are indeed similar to coccolith-rich ones (3 to 5 μm and 5 to 8 μm fractions).

For ancient and lithified deposits, micarb nature and origin are more complicated and challenged by the diagenetic overprint. This phase is thought to be involved in cement buildup during the sediment burial³³. Through our example for the lowermost Palaeocene calcareous clay from Bidart, recognizable coccolith fragments dominate over other components in the <3 μm fraction. These observations were originally not possible from bulk observation of this low-carbonate sediment. Assuming that these nannofossil fragments have the same isotopic composition as entire specimens collected in both 3 to 5 μm and 5 to 8 μm fractions, this may imply that the non-coccolith-derived monocryalline phase has more positive isotopic signatures (Fig. 7c). According to our data, micarbs did not only originate from diagenetic precipitation and should be used for better constraining of the diagenetic environment in which this cryptocrystalline phase mineralizes. However, these results challenge our view about the importance of micarbs in sediment because they represent a considerable part of the carbonate fraction with respect to other biogenic particles. Although common to all processed samples, their actual importance in pristine sediment should be further investigated, in particular regarding the possibility that they derive from fragmentation during treatment.

ACKNOWLEDGMENTS We are grateful to Maurice Renard (UPMC, Paris) for opening us the door of calcareous nannofossil separation in the JE 2477 'Biomínéralisations et Paléoenvironnements' Research Group in Paris, and also to Nathalie Labourdette for her technical assistance in stable isotope analyses and Grégoire Egoroff (undergraduate research assistant) for monocrystal isolation. We warmly thank Ros Rickaby and Owen Green (Oxford University) for valuable improvements of an early version of this manuscript. This protocol also benefited from the helpful contributions of Jackie Lees, Jeremy Young, and an anonymous referee. F.M. was partly supported by UPMC action 'BQR2006' and M.H. by FNR/07/MA6/21.

Bibliography

1. Brand, U. Carbon, oxygen and strontium isotopes in Paleozoic carbonate components: an evaluation of original seawater-chemistry proxies. *Chem. Geol.* 204, 23–44 (2004).
2. Marshall, J.D. Climatic and oceanographic isotopic signals from the carbonate record and their preservation. *Geol. Mag.* 129, 143–160 (1992).
3. Zachos, J.C., Pagani, M., Sloan, L., Thomas, E. & Billups, K. Trends, rhythms, and aberrations in global climate 65 Ma to present. *Science* 292, 696–693 (2001).
4. Edwards, A.R. A preparation technique for calcareous nannoplankton. *Micropaleontology* 9, 103–104 (1963).
5. Katz, B.J. Preparation of calcareous nanofossils assemblages for chemical examination. *J. Paleontol.* 52, 497–500 (1978).
6. Eshet, Y. Obtaining rich nanofossils assemblages from ‘barren’ samples: processing organic-rich rocks in nanofossil investigation. *J. Nanoplankton Res.* 18, 17–21 (1996).
7. Green, O.R. *A Manual of Practical Laboratory and Field Techniques in Palaeobiology* (Springer Verlag, Berlin, 2001).
8. Paull, C.K. & Thierstein, H.R. Stable isotopic fractionation among particles in Quaternary coccolith-sized deep-sea sediments. *Paleoceanography* 2, 423–429 (1987).
9. Stoll, H.M. & Ziveri, P. Separation of monospecific and restricted coccolith assemblages from sediments using differential settling velocity. *Mar. Micropaleontol.* 46, 209–221 (2002).
10. Stoll, H.M. et al. Insights on coccolith chemistry from a new ion probe method for analysis of individually picked coccoliths. *Geochem. Geophys. Geosyst.* 8 10.1029/2006GC001546 (2007).
11. Minoletti, F., Gardin, S., Nicot, E., Renard, M. & Spezzaferri, S. Mise au point d’un protocole expérimental de séparation granulométrique d’assemblages de nanofossiles calcaires: application paléocologiques et géochimiques. *Bull. Soc. Géol. Fr.* 172, 437–446 (2001).
12. Hermoso, M., Minoletti, F., de Rafe’lis, M., Rickaby, R. & Hesselbo, S.P. Uncovering high strontium content in biogenic calcite: new data from a murolith-producing coccolithophore. *Eos. Trans. AGU.* 88 Fall Meet. Suppl., Abstract B44C-05 (2007).
13. Hermoso, M., Minoletti, F., Rickaby, R.E.M. & Halloran, P. Determination of differential vital effects for some Neogene calcareous nannoplankton taxa. *Geochimica Cosmochimica Acta.* 72 (Suppl. 1): A371 (2008).
14. Minoletti, F., Hermoso, M. & Gressier, V. A new protocol to decipher the geochemistry of pelagic micron-sized particles: influence of bioproduction and diagenesis. *Eos. Trans. AGU* 87 Fall Meet. Suppl., Abstract PP12B-08 (2006).
15. Minoletti, F., Hermoso, M. & Gressier, V. Deciphering the Geochemistry of Calcareous Pelagic Producers: Beyond Bulk Carbonate Analyses. *Eos. Trans. AGU* 88 Fall Meet. Suppl., Abstract PP31C-0531 (2007).
16. Minoletti, F., de Rafe’lis, M., Renard, M. & Gardin, S. Remaniement des nanofossiles calcaires maastrichtiens dans les sédiments du Danien basal de Bidart (France): arguments isotopiques (carbone et oxygène). *Rev. Micropale’ontol.* 47, 145–152 (2004).

17. Minoletti, F., de Rafe'lis, M., Renard, M., Gardin, S. & Young, J. Changes in the pelagic fine fraction carbonate sedimentation during the Cretaceous–Paleocene transition: contribution of the separation technique to the study of Bidart section. *Palaeogeogr. Palaeoclimatol. Palaeoecol.* 216, 119–137 (2005).
18. Beltran, C. et al. Coccolith $d_{18}O$ and alkenone records in middle Pliocene orbitally-controlled deposits: high frequency temperature and salinity variations of sea surface water. *Geochem. Geophys. Geosyst.* 8 10.1029/2006GC001483 (2007).
19. Hermoso, M., Le Callonnec, L., Minoletti, F., Renard, M. & Hesselbo, S.P. Expression of the early Toarcian negative carbon-isotope excursion in separated carbonate microfractions (Jurassic, Paris Basin). *Earth Planet Sci. Lett.* (in press). DOI:10.1016/j.epsl.2008.10.013.
20. Lees, J.A & Minoletti, F. Separation of nannofossil size fractions by microfiltration: innovations, modifications, and results. 11th INA conference, Lincoln (Nebraska, USA), International Nannoplankton Association, Abstract volume 63 (2006).
21. Bairbakhish, A.N., Bollmann, J., Sprengel, C. & Thierstein, H.R. Disintegration of aggregates and coccospheres in sediment trap samples. *Mar. Micropaleontol.* 37, 219–223 (1999).
22. Stoll, H.M. Limited range of interspecific vital effects in coccolith stable isotopic records during the Paleocene-Eocene thermal maximum. *Paleoceanography* 20 10.1029/2004PA001046 (2005).
23. Dudley, W.C. & Goodney, D.E. Oxygen isotope content of coccoliths grown in culture. *Deep-sea res., Part 1, Oceanogr. Res. PAP.* 26, 495–503 (1979).
24. Dudley, W.C., Blackwelder, P., Brand, L. & Duplessy, J.C. Stable isotopic composition of coccoliths. *Mar. Micropaleontol.* 10, 1–8 (1986).
25. Ziveri, P. et al. Stable isotope 'vital effects' in coccolith calcite. *Earth Planet. Sci. Lett.* 210, 137–149 (2003).
26. Steinmetz, J.C. Stable isotopes in modern coccolithophores. In *Coccolithophores* (eds Winter, A. and Siesser, W.G.) 219–229 (Cambridge University Press, Cambridge, 1994).
27. Aubry, M.P. Late Paleogene calcareous nannoplankton evolution: a tale of climatic deterioration. In *Eocene-Oligocene Climatic and Biotic Evolution* (eds Prothero, D.R. and Berggren, W.A.) 272–309 (Princeton University Press, Princeton, 1993).
28. Chapman, M.R. & Chepstow-Lusty, A.J. Late Pliocene climatic change and the global extinction of the discoasters: an independent assessment using oxygen isotope records. *Palaeogeogr. Palaeoclimatol. Palaeoecol.* 134, 109–125 (1997).
29. Chepstow-Lusty, A. The last million year of the discoasters: a global synthesis for the upper Pliocene. In *Microfossils and Oceanic Environments* (eds Moguevsky, A. and Whatley, R.) 165–175 (University of Wales Aberystwyth-Press, Aberystwyth, 1996).
30. Stoll, H.M. & Ziveri, P. Coccolithophorid-based geochemical paleoproxies. In *Coccolithophores: From Molecular Processes to Global Impact* (eds Thierstein, H.R. and Young, J.R.) 529–562 (Springer Verlag, Berlin, 2004).
31. Bellanca, A., Masetti, D. & Neri, R. Rare earth elements in limestone/marlstone couplets from the Albian-Cenomanian Cison section (Venetian region, northern Italy): assessing REE sensitivity to environmental changes. *Chem. Geol.* 141, 141–152 (1997).

32. Westphal, H., Munnecke, A., Pross, J. & Herrle, J.O. Multiproxy approach to understanding the origin of Cretaceous pelagic limestone–marl alternations (DSDP site 391, Blake-Bahama Basin). *Sedimentology* 51, 109–126 (2004).
33. Munnecke, A., Westphal, H., Reijmer, J.J.G. & Samtleben, C. Microspar development during early marine burial diagenesis: a comparison of Pliocene carbonates from the Bahamas with Silurian limestones from Gotland (Sweden). *Sedimentology* 44, 977–990 (1997).
34. Keller, G. Depth stratification of planktonic foraminifers. In *Miocene Ocean: Paleoceanography and Biogeography—GSA Memoir 163* (ed Kennett, J.) 177–195 (Geological Society of America, Boulder, 1985).