



**HAL**  
open science

## Compressed digital holography: from micro towards macro

Colas Schretter, Stijn Bettens, David Blinder, Beatrice Pesquet-Popescu,  
Marco Cagnazzo, Frederic Dufaux, Peter Schelkens

► **To cite this version:**

Colas Schretter, Stijn Bettens, David Blinder, Beatrice Pesquet-Popescu, Marco Cagnazzo, et al..  
Compressed digital holography: from micro towards macro. Applications of Digital Image Processing  
XXXIX, SPIE, Aug 2016, San Diego, United States. hal-01436102

**HAL Id: hal-01436102**

**<https://hal.science/hal-01436102>**

Submitted on 10 Jan 2020

**HAL** is a multi-disciplinary open access archive for the deposit and dissemination of scientific research documents, whether they are published or not. The documents may come from teaching and research institutions in France or abroad, or from public or private research centers.

L'archive ouverte pluridisciplinaire **HAL**, est destinée au dépôt et à la diffusion de documents scientifiques de niveau recherche, publiés ou non, émanant des établissements d'enseignement et de recherche français ou étrangers, des laboratoires publics ou privés.

# Compressed digital holography: from micro towards macro

Colas Schretter<sup>a,c</sup>, Stijn Bettens<sup>a,c</sup>, David Blinder<sup>a,c</sup>, Béatrice Pesquet-Popescu<sup>b</sup>,  
Marco Cagnazzo<sup>b</sup>, Frédéric Dufaux<sup>b</sup>, and Peter Schelkens<sup>a,c</sup>

<sup>a</sup>Dept. of Electronics and Informatics (ETRO), Vrije Universiteit Brussel, Brussels, Belgium

<sup>b</sup>LTCI, CNRS, Télécom ParisTech, Université Paris-Saclay, Paris, France

<sup>c</sup>iMinds, Technologiepark 19, Zwijnaarde, Belgium

## ABSTRACT

The age of computational imaging is merging the physical hardware-driven approach of photonics with advanced signal processing methods from software-driven computer engineering and applied mathematics. The compressed sensing theory in particular established a practical framework for reconstructing the scene content using few linear combinations of complex measurements and a sparse prior for regularizing the solution. Compressed sensing found direct applications in digital holography for microscopy. Indeed, the wave propagation phenomenon in free space mixes in a natural way the spatial distribution of point sources from the 3-dimensional scene. As the 3-dimensional scene is mapped to a 2-dimensional hologram, the hologram samples form a compressed representation of the scene as well. This overview paper discusses contributions in the field of compressed digital holography at the micro scale. Then, an outreach on future extensions towards the real-size macro scale is discussed. Thanks to advances in sensor technologies, increasing computing power and the recent improvements in sparse digital signal processing, holographic modalities are on the verge of practical high-quality visualization at a macroscopic scale where much higher resolution holograms must be acquired and processed on the computer.

**Keywords:** Digital holographic microscopy (DHM), Compressed sensing (CS), Compressed digital holography (CDH), Image reconstruction, Inverse problems

## 1. INTRODUCTION

Digital holography is commercially well established for single viewpoint visualizations. Applications include quantifying the depth at sub-wavelength resolution, which provides us specific signature of the shape of cells and other micro-organisms under study in microscopy, as well as non-destructive testing for strain and stress surface imaging and several synthetic aperture radar modalities in metrology.

Using the framework of compressed sensing, we can view complex samples on the hologram plane as linear combinations of several non-compact point spread functions from distant point emitters. Natural scenes are represented in high-dimensional ambient vector spaces, but their support is in general limited to low-dimensional subspaces with a dimensionality that corresponds with the scene's sparsity or a comparable rate of innovation metric. As opposed to the band-width, the innovation rate is a more appropriate information measure that quantifies the number of non-zero or significant coefficients when the scene is represented in a well-chosen sparsifying basis. Given a sparse scene and an invertible light-transport model like the Fresnel transformation, we can recover the scene from few hologram samples by means of a convex optimization problem.

Figure 1 shows a generic compressed digital holographic acquisition setup for planar object wavefronts that interfere with a reference beam. A ramp-shaped phase-modulation plate is depicted in Figure 1, making this particular example equivalent to an off-axis configuration. For an on-axis phase-shifting configuration, we would have to use phase plates of different uniform thicknesses. More exotic phase coding schemes, microscopic objectives, lenses, gratings and holographic optical elements may be envisaged as well for introducing wavefront modulations of different kinds.

---

Further author information: (Send correspondence to C. Schretter)  
C. Schretter: E-mail: cschrett@vub.ac.be

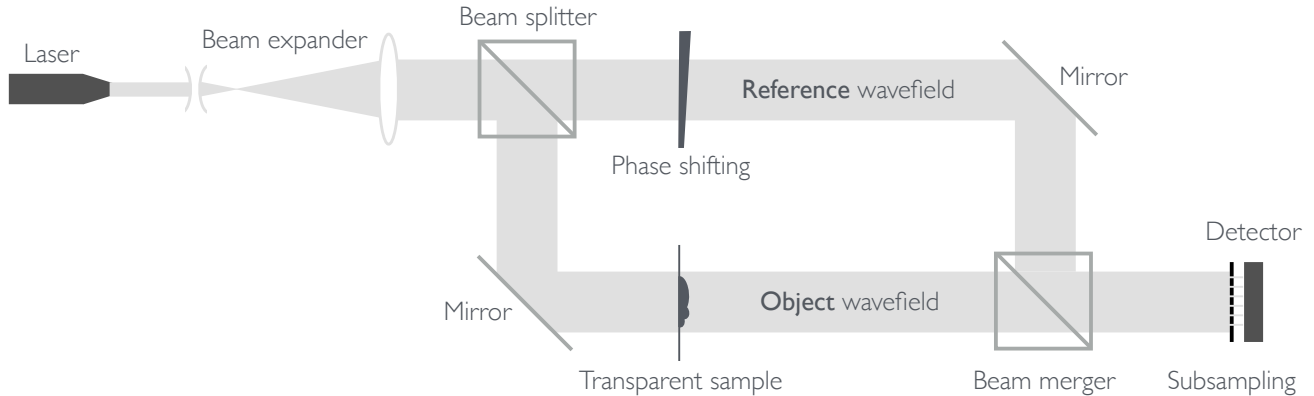

Figure 1. Generalized digital holography acquisition setup. From a coherent light source, the object wavefield transmitted through the sample is interfered with a phase modulating reference beam. The interferences in free space are implicitly mixing all measurements in a progressive way, depending on the sample-to-detector distance. Few samples are selected from the full hologram through an aperture masking process and finally, intensity information is recorded by a CCD digital detector. This parallel detection could also be replaced by a sequential scanning process and a single pixel detector.

In this article, we partition the scale in mainly two bins, according to Figure 2. The microscopic scale where all orthogonal projections of objects in the scene are bounded by the digital detector size. This allows for acquiring data with traditional holographic setup in orthographic geometries. The macroscopic scale encloses geometries where multiple detectors and view points or scanning acquisition protocols are needed for data acquisition. Such large macro scale poses additional challenges in terms of large scale complex signal compression and transmission.

At the microscopic scale, the phase of the recorded wavefield is proportional to a depth map of the scene and is therefore modeled as a heightfield in the absence of significant effects from occlusions and speckle noise. At the macroscopic scale however, holography presents additional challenges. Different parts of the object are exposed with a large viewing angle, occlusions introduce non-linearities that are essential to handle and speckle noise impairs visualization.<sup>1</sup> Nevertheless, the advances in the field at the micro scale may be translated to the macroscopic imaging scenario, provided that enough computation and storage resources are available.

Recently, the application of compressed sensing to holography has attracted significant interest and many contributions have been published so far. This article aims at reviewing and relating the key papers in a principled way. Several notable review papers and books have already been published in recent years. In 2013, Rivenson, Stern and Javidi published a brief overview of applications of compressed sensing for designing optical systems.<sup>2</sup>

Sparsity is an indispensable pillar of compressed sensing. The book of Xing, Kaaniche, Pesquet-Popescu and Dufaux is a compendium of the state-of-the-art for efficient compression and representation of digital holographic data.<sup>3</sup> SPIE also published a review paper by Dufaux *et al.* in 2015.<sup>4</sup> More focusing on the hardware photonics side, while the review of Tsang and Poon gives a glimpse of the future of holography by simplifying optical components in turn for advanced software processing.<sup>5</sup>

A recent review by McLeod and Ozcan<sup>6</sup> discusses emerging computational imaging techniques in microscopy and how they will lead to smaller and simpler devices that can communicate with handheld computers, such as smart-phones, for performing complex calculations. This portable format will allow large-scale field studies which is a drastic change compared to the conventional protocol of sending (probably dead-by now) samples in the wet lab.

The present article overviews the field of digital signal processing for holography with comprehensible references to recent techniques that stem from the pillars of compressed sensing. Section 2 presents briefly the compressed sensing framework and its inception in digital holography. Then, Section 3 reviews works that were developed with the aim at microscopic imaging. An outreach to future applications at the macroscopic scale is discussed in Section 4. Finally, we conclude this review paper in Section 5.

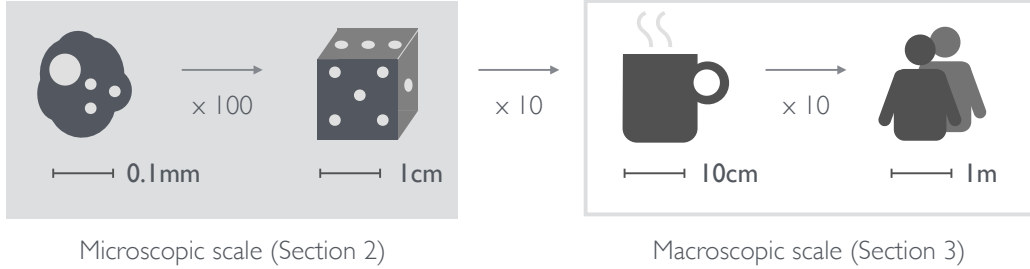

Figure 2. The microscopic scale ranges from holographic field of views of few millimeters for multiple-cell imaging to about one centimeter for metrology and 3D reconstruction of small objects. The macroscopic scale ranges from centimeters to real-life scale such as persons in a room.

## 2. COMPRESSED SENSING

Since the late eighties and early nineties, a wealth of regularization techniques for solving large underdetermined systems of equations of the form  $y = Ax$  have been developed in the applied mathematics community. If we assume that the system matrix  $A$  has full row rank, then the  $M$  measurements in  $y \in \mathbb{C}^M$  are linearly independent but many solution vectors  $x \in \mathbb{C}^N$  may comply with these measurements since  $M < N$ . In 1989 already, the "Uncertainty principles and signal recovery" paper<sup>7</sup> from Stanford's mathematician Donoho and colleagues has shown the possibility to recover sparse non-bandlimited signals that are characterized using the (now-deprecated) notion of "concentration" of non-zero entries in sparse vectors.

A milestone in their long string of research was the discovery in 2002 by Donoho and Elad that among all possible regularization priors for selecting a unique solution, minimizing  $\|x\|_1$ , *i.e.*, the Manhattan  $l_1$  norm of the solution vector  $x$  is promoting sparsity.<sup>8</sup> Promoting means that the number of zero coefficients in  $x$  is maximized, which is equivalent to minimizing the "complexity", or the message length, of the solution.

This regularization prior is a close cousin of the classical energy minimization which selects the solution of smallest Euclidian  $l_2$  norm, *i.e.*,  $\|x\| \equiv \|x\|_2$ . Promoting sparsity with approximate-to-strict data consistency constrains is equivalent to solving the following "basis pursuit-denoising" problem:

$$\operatorname{argmin}_x \|x\|_1 \quad \text{subject to} \quad \|y - Ax\|^2 \leq \epsilon. \quad (1)$$

Note that when the tolerance bound  $\epsilon = 0$ , we obtain the strict "basis pursuit" problem where an exact match with measurements is enforced. A specific definition of the system matrix  $A$  for compressed digital holography is described in the next section.

By combining theoretical insights with algorithms for solving large-scale basis pursuit problems, a complete framework emerged for forming a minimum set of measurements and reconstructing the maximally sparse solution. In particular, the work of Daubechies, Defrise and De Mol, in 2004, proposed a practical  $l_1$ -norm minimization solver based on iterative soft thresholding.<sup>9</sup> This algorithm allows solving large inverse problems that arise in digital image reconstruction. That same year, Candès published a proof of exact recovery, together with field medalist Tao and his thesis director Donoho. This theoretical proof started the field of "compressed sensing" in 2006<sup>10</sup> that has been popularized further in digital imaging by the work of Candès and many authors.<sup>11-13</sup>

Because of the inherent dimensionality reduction of a 3D scene to a 2D hologram and the natural mixing of scene content through interferences in coherent light imaging, the compressed sensing framework has influenced greatly the field of digital holography. The remainder of this article will identify key works that we enclose under the umbrella term of compressed digital holography (CDH). We will emphasize the stepping stones towards translating the technique from the microscopic scale toward the macro scale that would be required for imaging real-size scenes. For interested readers, the book of Foucart and Rauhut<sup>14</sup> provides an exhaustive and didactic introduction to mathematical aspects of compressed sensing. The book of Eldar and Kutyniok<sup>15</sup> brings more exciting motivations on new applications of compressed sensing.

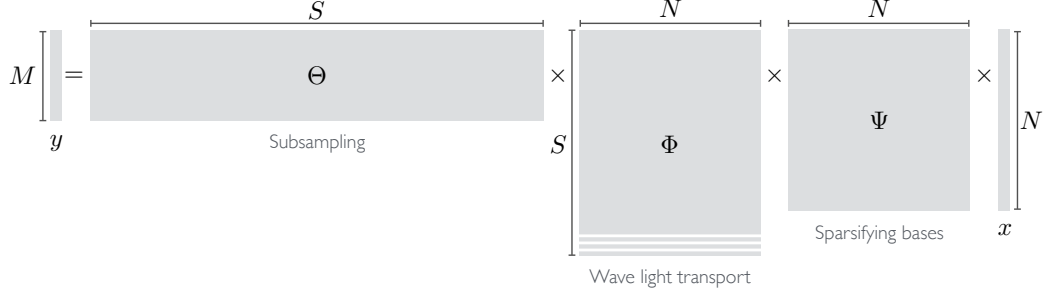

Figure 3. The triple product of sparsifying bases  $\Psi$ , a linear light transport model  $\Phi$  and a specific sample selection strategy  $\Theta$  forms the rectangular "fat" system matrix  $A$ . From this linear system, the compressed sensing framework proposes to select the sparsest set of solution coefficients. This regularized solution  $x$  is constrained with observed data  $y$ .

## 2.1 Compressed digital holography

A discriminant view that differentiates compressed digital holography problems from other "regular" linear algebra inversion problems is the specific factorization of the system matrix

$$A = \Theta\Phi\Psi \quad (2)$$

into three successive operators. Figure 3 illustrates this factorization on a typical problem instance emphasizing relative dimensions of the three matrices.

Columns of the sparsifying operator  $\Psi \in \mathbb{C}^{N \times N}$  are selected such that the imaged scene can be represented by a sparse vector  $x$ . Secondly, the rows of the sensing operator  $\Phi \in \mathbb{C}^{S \times N}$  hold translated versions of the wave propagation phenomenon's impulse response. And thirdly,  $\Theta \in \{0, 1\}^{M \times S}$  is a sample selection operator with a single non-zero element per row. We notice that  $S$  can be much larger than  $N$ . The number of required linear measurements  $M$  is dependent on the sparsity of the scene, but also on the structure of  $\Phi\Psi$  and the sample selection criterion in  $\Theta$ . First of all, the columns of  $\Phi\Psi$  have to approach a constant function rather than a Dirac pulse. As such, the coherence between the sensing operator  $\Phi$  and the sparsifying operator  $\Psi$  is low, which is beneficial for the reconstruction of the scene.

A sample selector  $\Theta$  that picks measurements in a random fashion is ideal in the above case. However, if any of the columns of  $\Phi\Psi$  are closely approximated by a Dirac pulse, then it is necessary to select the measurements that are associated with the rows that contain the peak of this pulse because otherwise the influence of one of the sparsifying basis functions on the measurements is cancelled, which means there is no hope to reconstruct the coefficient that is associated with that basis function.

As such, the selection of hologram samples by means of  $\Theta$  really matters. The operators  $\Psi$ ,  $\Phi$  and  $\Theta$  are implemented by means of fast transformation algorithms that compute on-the-fly matrix-vector multiplications. The final system  $A$  is "fat", *i.e.*,  $M \ll N$ , except when we are dealing with diffuse objects. The resulting basis pursuit (denoising) problem is solved with a convergent optimization algorithm.

Figure 4 shows the holographic image formation pipeline from point disturbances in scene space, through interference formation, to final recorded wavefront in detector space. The three aforementioned stages of signal transformation and sampling are attached to these three steps of physical signal transformation. As the physics behind the wave propagation phenomenon in free space and the geometry of the acquisition setup cannot be controlled, the choice of the sensing operator  $\Phi$  should model as accurately as possible the physics of light transport, while being computationally tractable.

We assume the paraxial approximation is sufficiently accurate in microscopy where propagation distances are fairly small. Therefore, the propagation of the angular spectrum may be used and thus  $S = N$ . However,  $S$  must be significantly greater than  $N$  for handling larger detectors than the scene enclosing box or for macroscopic case, a Fresnel or Bluestein-Fresnel model will be preferable for accounting for distance-dependent deformations of hemispherical wavefronts.

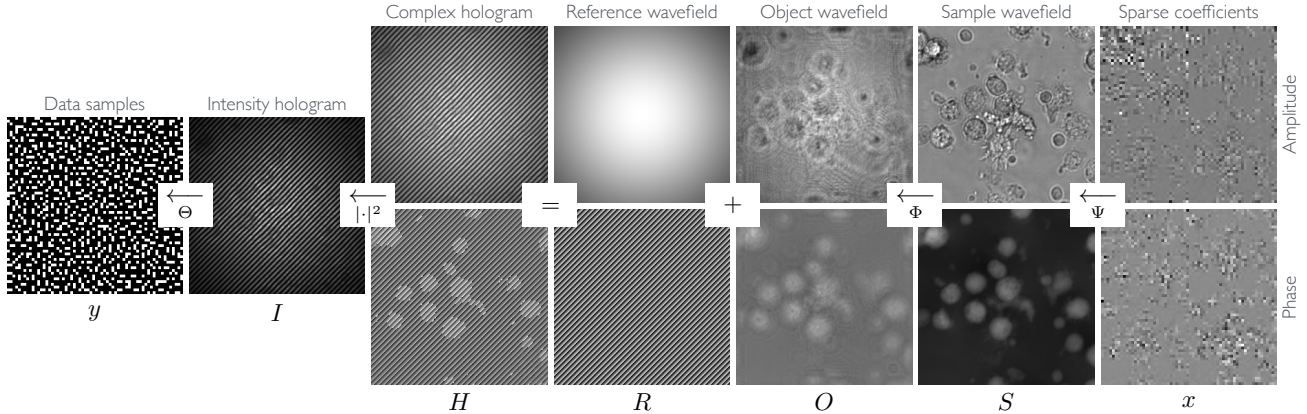

Figure 4. An example of holographic image formation pipeline. The solution is represented by a sparse set of coefficients  $x$  expanded in basis functions  $\Psi$ . From this complex sample image  $S$  in focus plane, a light transport operator  $\Phi$  generates a complex object wavefront  $O$  in detector plane. The addition of a known reference beam  $R$  produces an interferometric complex-valued hologram  $H$ . The detector only records light intensities and not the phase, hence squared magnitudes from  $H$ , yields the records  $I$  from which a short vector of few digital samples  $y$  are sampled through the operator  $\Theta$ .

As each complex value in the hologram contains a sum of a large point source emitter in 3D scene space, an hologram already contain compressed samples by nature. According to the Huygens-Fresnel principle, the complex-valued hologram samples are affected by many point sources that are distributed in the scene. As a consequence, the columns of  $\Phi\Psi$  look more like constant functions. This explains the natural match between digital holography and the compressed sensing framework for the reconstruction of sparse scenes from an incomplete set of hologram samples. The idea of using computation following a compressive acquisition procedure is not new to holography. Indeed, the work of Lucente at MIT in 1996 already flirted with this concept in a suprisingly interesting way.<sup>16</sup> He modeled holograms with Fringelets and interpolated the full record from few samples.

In the next sections, we will discuss and link notable works closely related to compressed digital holography. Most efforts have been dedicated to microscopic applications of holography, where capturing the phase information maps directly to sample thicknesses, assuming semitransparent samples and constant indices of refraction. Many of the ideas developed at the micro scale are potentially applicable to macroscopic scenes where the scaling challenge is certainly the requirement of extremely large hologram definition and we are faced with many more challenges. For that reason, we conclude this review with an outreach to the macroscopic future of compressed sensing in digital holography.

### 3. AT THE MICROSCOPIC SCALE

In this section, works are first binned according to their respective contributions along the aforementioned three-steps forward image formation pipeline. Starting from the scene representation, to the detection and data section. Then, applications to tomographic, single pixel imaging and new computational imaging concepts are discussed. Finally, we link compressed digital holography with the general phase retrieval problem in diffraction tomography for recovering complex wavefronts from amplitude information only.

#### 3.1 Scene representation

In microscopy, the thickness of specimen on transparent ground glass is a direct function of the phase shift of the transmitted object wavefront when it passes through the specimen. Therefore, complex variants of classical compressed image representations are natural choice for representing imaged objects. The Cohen-Daubechies-Fauveau (CDF) wavelets<sup>17</sup> for instance have been retained as an ideal choice for its multi-scale and smooth wavelet transformation that match relatively well the human visual system. Fast transforms based on lifting schemes exist for CDF wavelets,<sup>18</sup> and hologram compression schemes<sup>19</sup> as well as reconstruction from few hologram samples<sup>20</sup> have been proposed based on this representation.

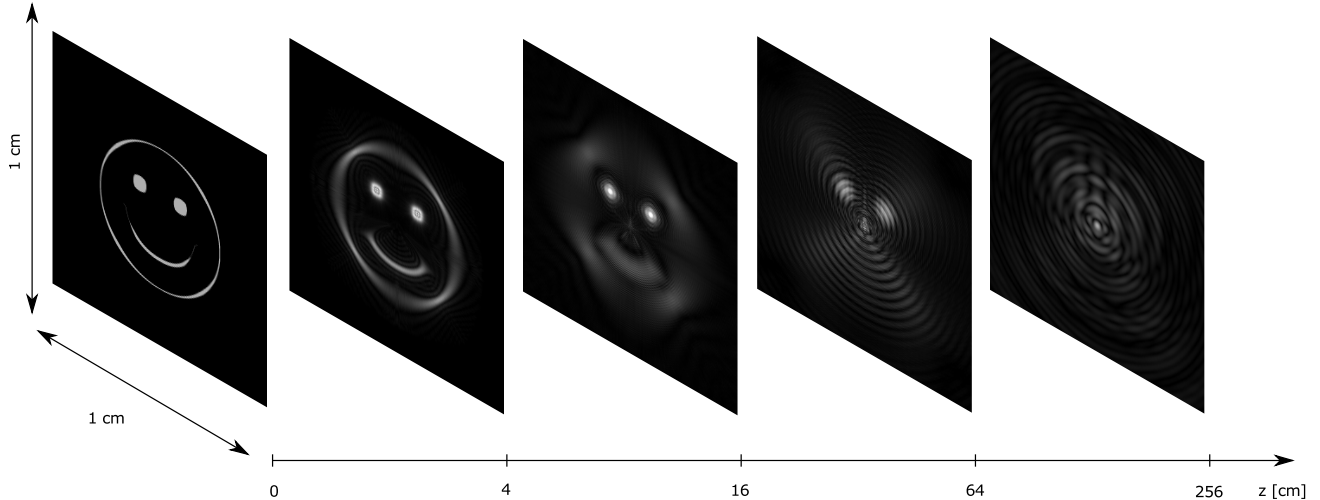

Figure 5. Visualization of the wavefield amplitude after propagation through free space. The sample contains only light attenuation and no phase shift occurs at the disturbance location. Both constructive and destructive interferences amplify as propagation distance increases. As a result, each measurement on the distant hologram planes contain mixed information from multiple points emitters located on the leftmost source disturbance plane.

Fast transforms implemented with lifting scheme are optimally efficient algorithms, requiring a constant processing time per pixel. A wealth of work has been pursued in this track for compression and image analysis tasks. For example, both separable and adaptive, but non-separable vector schemes allow sequential processing.<sup>21,22</sup> In that work, a joint multiscale decomposition based on the vector lifting methods is proposed for encoding interference patterns that are repeatedly used to store the whole hologram. These methods have been applied to form a content-adaptive hologram compression scheme using sparse optimization techniques.<sup>23</sup>

A popular and versatile universal approximation of the 3D scene contents may be defined with scattered data representations such as point clouds of uniform emitters. This representation has been used for fast rendering of holograms in computer-generated holography.<sup>24</sup> In the work of Symeonidou *et al.*, the scene is sliced in multiple local wavefront recording planes, which are implicitly enforcing sparsity from coarse granularity along the depth dimension.<sup>25</sup> However, the inverse problem of reconstructing point clouds from holograms has not been tackled yet. This is definitely a very interesting venue for future research.

### 3.2 Light wave propagation

Banerjee evaluated experimentally the important effect of the propagation distance between the sample plane and the detector.<sup>26</sup> The Fresnel transform operation and the non-paraxial and paraxial angular spectrum transfer function back-propagation approaches were compared. As propagation distance increases, the interference of all spherical wavefronts occurring along the path to the detector can be seen as a mixing operator. Incoherence among measurements is a function of the propagation distance.

At large distances, each pixel of the detector, which captures the intensity of the hologram, is uncorrelated with its neighbor and the hologram looks like circularly complex Gaussian noise for diffuse specimen or the object's Fourier transform for non-diffuse specimen. However, each of these measurements effectively records a part of the whole scene. The is natural mixing of source emitters is behind the rationale of holographic modalities, where each pixel effectively encodes a part of the whole scene information.

As the propagation distance increases, the coherence decreases. This effect is shown visually in Figure 5 with 633nm light source, corresponding to the "red" color. Sufficient conditions for the perfect reconstruction of sparse signals from undersampled linear measurements or hologram samples are well-known.<sup>27</sup> They reveal that the coherence among measurements should decrease as the sparsity of the scene increases. As such, the propagation distance should increase. This property stems from using the natural wave propagation phenomenon as a data mixing operator. As shown by Rivenson *et al.*, the propagation distance must be proportional to the

sparsity of the object for perfect reconstruction.<sup>28</sup> For their theoretical analysis, they limited themselves to the scope of reconstructing spatially sparse flat objects.<sup>29</sup>

In the Master thesis of Liu,<sup>30</sup> an experimental comparison of CS with the TwIST (iterative soft thresholding) algorithm<sup>31</sup> and a regular analytical inversion method using the Fresnel transform showed greater accuracy for both near and far field reconstructions. However, the CS approach consumed 30 times more computations, which is an unavoidable limitation of iterative solvers for problems with high condition numbers. In practice, we compensate for the slower iterative process using parallel computing or clever implementations based on brute-force general computing with graphics processing units (GPU) accelerators.<sup>32</sup>

A similar study considered two alternatives to TwIST, namely the projection onto convex set (POCS) and the projected gradient method (PGM).<sup>33</sup> These methods solve a strict basis pursuit problem and therefore implicitly assume that holograms are noise-free. Nevertheless, the sparse reconstructions were resilient to noise, suggesting that noise issues are not significant in compressed digital holography.

In the work of Katkovnik and others, a separable forward model is analyzed by constructing two joint matrices depending on the detector to sample distance.<sup>34</sup> The highest reconstruction accuracy was obtained when the rank of these matrices is maximal at the focus distance. Their study however, only evaluated rectangular objects in the scene. Simple closed-form equations were derived, which describe the conditions for perfectly reconstructing the scene from full hologram data over a small detector.

Beside rectilinear light paths in vacuum, the problem of reconstructing the spatial distribution of the disturbances in the case of scattering events has been tackled as well.<sup>35</sup> Scattering is an important phenomenon that arises in diffuse instead of purely translucent mediums. Scattering also occurs at the surface of or in optical elements such as diffusers and promising research is ongoing in using such optical components as perfect mixers for generating compressed samples in compressive holographic technologies.<sup>36</sup>

### 3.3 Sampling strategies

Once mixed data samples are formed on the detector, a decisive step is selecting fewer of these samples. In the case of a perfect mixing, any set of samples have equal probability to be selected. These sets contain approximately the same information on the imaged 3D scene. However, in practice perfect mixing is not realized and the specific sampling strategy becomes important.

Experiments by Rivenson, Stern and Javidi<sup>37,38</sup> have shown that using a non-uniform sampling strategy that increases the density of hologram samples near the center of the recording plane and decreases the density towards the edge of the recording plane improves the quality of the reconstruction for orthogonal reprojections. This is indeed a direct consequence of the geometry of holography in which the angle of incidence of point light sources increases with distance to the normal passing through the center of the detector.

While their work has shown the importance of selecting samples,<sup>39</sup> the reprojections of the hologram at different parallax angles would require shifting the disc-shaped sample selection window. In a following study, they generalized their theoretical study by applying the selection mask close to the object focus, hence in the half-way through propagation.<sup>40</sup> They evaluated the resilience to occlusions that raised with increasing propagation distance after the occlusion events.

Up to now, we considered parallel imaging strategies where the data subsampling is implemented by masking samples on the acquisition side. Hence, the measurements are performed simultaneously. The dual sequential concept of taking one single measurement at a time and multiplexing the measurements in time was developed at Rice University.<sup>41</sup> With such single pixel imaging modality, we only have access to a single intensity detector that captures the total intensity of the light that is reflected by a digital micro-mirror device (DMD), which acts like a programmable coded aperture. Programming the reflective mirror array allows combining measurements in a controlled sequential way. Therefore, one should design sampling sequences instead of sampling masks.

The system matrix  $A$ , which represents the measurement procedure, is thus dependent on a component we can steer such that the structure of  $A$  or  $\Phi\Psi$  is optimized, *i.e.*, by making the coherence among the hologram samples as small as possible. This way, less hologram samples are required for reconstructing a given sparse scene, but the acquisition time will also significantly increase. We can argue the scene has to be static for



making use of the benefits the single pixel camera measurement procedure offers, but for dynamic scenes (*i.e.*, video applications) its use is questionable.

The work of Clemente *et al.* adapted the single pixel imager to digital holography<sup>42</sup> using phase-shifting with a Mach–Zehnder interferometer and Hadamard patterns which are interleaved sets of well-separated matrix entries. The group of Li *et al.* devised a phase-shifted variant<sup>43</sup> where two batches of measurements are taken at different phase shifts. Then, the complex amplitude and phase information is recovered from the phase-shifted measurements. This approach has great potential to be combined with more phase-shifting steps for robustness and using different complementary sets of samples for each shifts. A recent variant uses a parallel phase-shifting technique to obtain spatially multiplexed phase-shifting holograms simultaneously.<sup>44</sup>

A future and logical extension is single photon imaging where each incident photon is recorded in a ultra-low-light imaging setup. Albeit the state, the state of research is currently at the numerical simulation stage.<sup>45</sup>

### 3.4 Tomographic imaging

The research group of Brady at Duke University has been very active in this new field and coined in 2009 the term "compressive holography" in their seminal paper.<sup>46</sup> The rationale behind their work is to see the hologram as a representation of a full 3D scattering density field and therefore, they represent the solution space in 3D space.<sup>47</sup> In compressive holography, all slices from a volume enclosing the sample under study are reconstructed at once, dynamically.<sup>48</sup> Independently, the work of Cull<sup>49</sup> derived an in all points, identical technique to Brady's Compressive holography.

The goal is to solve a full tomographic reconstruction problem from a the intensity of a single hologram: a challenging inverse problem. The very first contribution showed a reconstruction of spatially sparse scenes with only two point sources located at two well-separated distances from the detector and each other. A spatially sparse mask selected samples on the detector.<sup>50</sup> The reconstruction method used a sparsity prior in a Bayesian framework. Brady *et al.* used total-variation minimization and assumed diffuse surfaces for regularization.<sup>51</sup>

Simpler scene representations are possible, for instance assuming a joint intensity and injective depth field model allows for ignoring occlusion effects.<sup>52</sup> Another idea is assuming that the important depth planes where samples are lying are known in advance. In that case, it is possible to optimize the object representation by choosing adapted basis functions for emphasizing the regions of interest in scene space.<sup>53</sup>

Rivenson and co-authors proposed in 2011 a method for generating a hologram from a corpus of multiple view point photographs. A scanning process takes photographs along a linear parallax trajectory, from which 3D information on the geometry of the scene may be extracted.<sup>54</sup> In that work, the goal is not to reconstruct the 3D scene, but a 2D hologram subsuming all photographs. The thesis of Liu evaluated a parallel imaging variant where multiple holograms at different view angles are combined into a single shot acquisition.<sup>30</sup> Thereby, reducing the measurement time, but not the rather high measurement count.

Overall, the current techniques for tomographic reconstruction from a single hologram are characterized by severe limitations in terms of axial (depth) resolution.<sup>55</sup> This result seems paradoxical since axial resolution depends on the wavelength of the light source in holography and not on the pixel pitch of the detector. However, as the effect of two slices of a volume that are just a few wavelengths apart on the hologram is very subtle, it is also very hard to separate the information due each of those slices. Experiments from Tian, Liu and Barbastathis showed how sparsity may help to further improve axial resolution recovery<sup>56</sup> leading to high accuracy localization of objects in sparse scenes.<sup>57</sup> Their latest results demonstrated sub-pixel accurate localization accuracy.<sup>58</sup>

In the Master thesis of Williams<sup>59</sup> on digital tomographic compressive holographic reconstruction of three-dimensional objects, he applied the compressed sensing strategy and experimented with various acquisition schemes for multiple views acquisitions. The goal was to reconstruct the surface contour of opaque object in reflective holography configurations. From a single hologram in recording plane, any light wavefront at given propagation distances can be reconstructed. However, a twin image as well as a smooth first order term will create a mirror image and a glowing halo in the reconstruction. The principle of compressed sensing has been applied for decomposing the reprojected hologram and extracting the wanted term only.<sup>60</sup>

### 3.5 Superresolution and multidimensional imaging

A striking possibility with the compressed sensing framework is super-resolution imaging,<sup>61</sup> in the sense that it is possible to reconstruct smaller scene features than the pixel size on the digital detector, provided that the exact scene representation has a sparse representation. Indeed, in that case, an aliased signal response will be recorded, but still, this alias will be a unique specific signature of the sparse scene content.

This concept has been experimentally validated to reconstruct high density fringes in off-axis Fourier holography<sup>62</sup> where Fourier space measurements are provided by using a very large propagation distance in the geometry of the optical setup. Rivenson and his group have shown how sparsity in compressed sensing leads to improved depth instead of lateral resolution as well.<sup>63,64</sup>

The idea of multidimensional imaging<sup>65</sup> is to use optical masks on a detector for recording simultaneously several optical channels, such as different wavelengths, and different polarization states of light.<sup>66</sup> Then, compressed sensing is used to recover jointly this multi-channel image, using possibly side information from other channels for global regularization. This approach is a good fit for randomly selected measurements since it make use of all pixels on a CCD detector and thus provides parallel imaging possibilities. A demonstration for holographic color acquisitions has been conducted in simulation, using the Shepp-Logan phantom image.<sup>44</sup>

In the simple self-interference incoherent digital holography (SIDH), a curved mirror is used to deform the object wavefield so that the interference of this artificially modulated wavefront and the original planar wavefronts is recorded. This self-interference imaging modality is close in concept to differential digital holography where the interference of the wavefront with a shifted version of itself is recorded. In this modality, very recent work<sup>67</sup> has applied compressed sensing on experiments with LED point sources, therefore, sparsity was assumed directly in the scene space and the sparse solution can be represented by few emitting locations.

### 3.6 Statistical iterative methods

Few works have been dedicated to statistical iterative reconstruction approaches for noisy and incomplete data in digital holography. Assuming that the reference beam is known, it is possible to cast the scene reconstruction problem as a non-convex phase retrieval objective. The first study by Sotthivirat and Fessler<sup>68,69</sup> took a statistical stance on the problem and used a penalized likelihood objective with Huber edge-preserving priors for regularizing the solution image, assuming that measurements were corrupted by Poisson noise.

Poisson statistics arise in counting processes such as low-light acquisitions<sup>70</sup> where the integrated intensities on the detector depends on the distribution of photon arrival events. While no sparse prior is used in this work, their iterative framework could be adapted naturally to other regularization strategy. A simplified version of this method has been published later on,<sup>71</sup> using the optimization transfer technique for optimizing a simpler quadratic surrogate objective function.

Inspired by the work of Fessler and Sotthivirat, Bourquard proposed a two-steps iterative method using total variation regularization,<sup>72</sup> which is akin to a sparse prior.<sup>73</sup> They experimented on real off-axis holograms as well and demonstrated slight improvements in terms of resolution recovery, compared to the classical Fourier filtering technique. However, the data acquisition protocol has been optimized for the Fourier case. The dual-iterations scheme did not allowed to converge to a reconstruction that exactly matches the acquired data, suggesting that further new improvements with this approach are possible.

The total-variation prior has also been used in the method of Marim and co-authors<sup>74</sup> who demonstrated good reconstruction from few scattered random samples. They assumed that few samples from a complex-valued hologram are recorded and start from a rough direct reconstruction, then continue with iteratively minimizing the variation in the object space. Results demonstrated impressive downsampling rates of about 7% without compromising resolution.

### 3.7 Phase retrieval

The problem of recovering the phase and amplitude information from intensity measurements is related to the phase retrieval problem<sup>75</sup> that is inferring the phase from the modulus of complex values only. Off-axis holography is a particular instance of the phase retrieval problem where a reference beam is known and the relation between

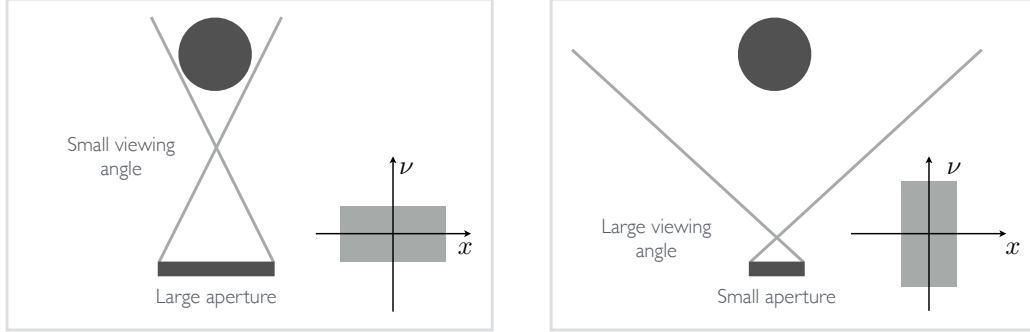

Figure 6. Change of the increasing field of view that can be captured correctly in the aliasing free zone as the detector aperture size diminishes. At large aperture on the left, the required bandwidth of the frequency spectrum is large while the spatial support is large, allowing for parallax experience. At smaller aperture on the right, it is possible to capture a wider field of view, but the aperture is relatively smaller too.

amplitude measurements and the focused object wavefront is represented by a model of light wave propagation model such as the angular spectrum method based on the paraxial approximation model. This phase retrieval problem has recently drawn interests in the compressed sensing community.<sup>76</sup>

Using sparsity as a regularization prior, it is possible to apply the compressed sensing principle to recover phase information from fewer intensity measurements.<sup>77</sup> The iterative Kaczmarz method has been applied as well to this problem,<sup>78</sup> in which a minimum energy prior instead of maximum sparsity is implicitly assumed. Since 2015, so many other important references have been published on compressed sensing for phase retrieval. These studies focus on retrieving the phase without the need for a reference beam as this is the main restriction in coherent diffraction imaging, which is the domain where the name "phase retrieval" stems from.

Schechtman and co-authors have published a review paper on coherent diffraction imaging in 2014 with the focus on measurements in the Fourier space.<sup>79</sup> In one of the closing paragraphs, they declare that other wave propagation models can be interesting to study as well. The research in this domain silently launching right now, but promising applications like desktop-size wavefield imaging devices are there to provide the necessary motivation to start with this work. We will not review this promising string of work in the present paper.

#### 4. TOWARDS THE MACROSCOPIC SCALE

For many, the long sought Graal of holography are holographic displays that allow for a full parallax experience where the perceived image depends on the viewer position, as well as accounting for subtle but important inner mechanics of the eye such as vergence and focusing distance. The present discussion explores the potential of applying compressed sensing to macroscopic scenes in digital holography. Unfortunately, direct applications of existing efforts in microscopy are unlikely to perform adequately without tackling supplemental problems.

There are key inter-related challenges to overcome for making practical holographic systems at the macroscopic scale. The following subsections nails three of them: the size and pixel density limitations of digital detectors, the speckle noise arising from diffuse reflective surfaces, and the more advanced scene modeling that is required for representing 3D scenes with large depth of field and for resolving non-linear effects such as visual occlusions between objects.

##### 4.1 Detector resolution limitations

Contrary to microscopic samples, the solid angle of captured objects are relatively much bigger than the camera sensor. Moreover, large viewing angles are often required to capture parallax information. This puts demanding constraints on the optical system, especially on the recording setup. A large coherence length for the laser light source should be enforced due to the big optical path differences. The stability of the recording setup is critical for mitigating vibrations and motion artifacts.

Light diffraction is characterized by the grating equation:  $\lambda\nu = \sin(\theta)$ , where  $\lambda$  is the wavelength,  $\nu$  is the spatial frequency and  $\theta$  is the diffraction angle. This means that if we want to capture viewing angles surpassing

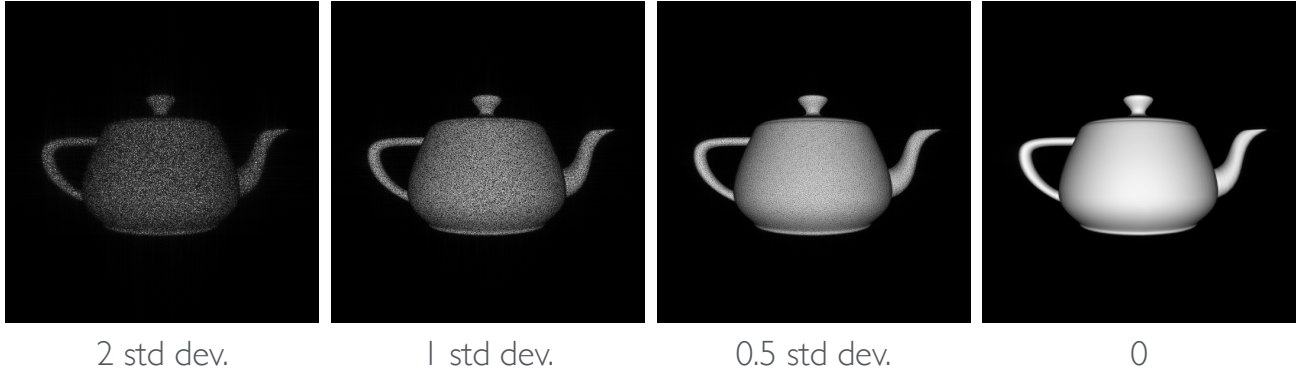

Figure 7. Variation of speckles with a simulated reflective mode hologram under coherent light illumination. We showed surface properties of diminishing roughness from diffuse to perfectly specular from left to right. When the surface is perfectly smooth, no phase shift occurs because of microscopic disturbances at the object surface. Therefore, speckles are invisible in this ideal case.

about  $20^\circ$ , we already need sub-micron pixel sizes. Note that today’s consumer grade sensors used in digital photography can go below two microns, we are not that far. Therefore, an important requirement for capturing or displaying high-quality holograms is the ability to capture or modulate optical signals at very high spatial frequencies.

Magnifying the scene is a possibility to trade off angular resolution for spatial support, as illustrated by the invariant space-bandwidth product in Figure 6. If we want to combine large viewing angles with holograms of a decent size, we need pixel counts approaching or even surpassing Gigapixels. Given the limitations of currently available sensors, compressed sensing becomes an attractive option. This would allow users to capture holograms using only a fraction of the bandwidth that would normally be imposed by the Shannon sampling theorem.

Besides the aforementioned physical challenges, large resolutions paired with significant computing requirements are present as well. The large data rates require powerful computing equipment and/or efficient (clever) algorithms.

## 4.2 Speckle noise mitigation

Speckle noise manifests itself when a coherent light source, such as a laser, interacts with a rough surface. A rough material exhibits surface variations at the scale of the optical wavelength. This rough surface will produce a multitude of random phase shifts, which will be integrated together on the detector. Because of the central limit theorem, the speckle noise will typically be distributed according to a complex normal distribution, that is characteristic of a random walk process.<sup>80</sup>

Most materials in macroscopic objects tend to have this microscopic roughness. This is why many surfaces appear diffuse. In the purely diffuse case, incident light will be reflected and diffracted uniformly in all directions. This can also be interpreted as all spatial frequencies of the holographic signal reflected by the surface will be excited. Some computer-generated holograms exhibiting various amounts of speckle noise are shown in Figure 7 as an illustration.

When visualizing holograms, speckle noise is undesirable and could be filtered out using both optical and signal processing methods. Optical methods typically involve the acquisition of multiple holograms for averaging out the speckle noise pattern. Examples include continuously rotating the illumination beam<sup>81</sup> or modulating the beam using a phase-only spatial light modulator (SLM).<sup>82</sup> Unfortunately, the use of many recordings would counteract the goal of using compressed sensing for macroscopic holograms, which would be precisely to reduce the amount of needed measurements. Moreover, this approach is impractical for studying dynamic systems.

On the other hand, signal processing methods try to reduce speckle by altering the hologram after its acquisition. Approaches include mean and median filtering, Fourier filtering, wavelets<sup>83</sup> or more advanced approaches consisting of filters applied on the 3D intensity volume generated from a single hologram.<sup>84</sup>

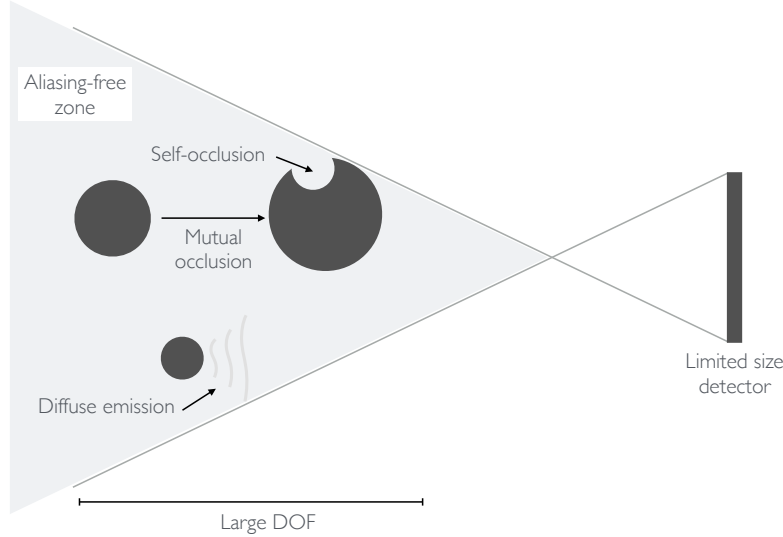

Figure 8. Challenges of volumetric scene model at the macroscopic scale. The large depth of field prevents far field scene approximations assuming that the scene consists of a flat plane with details encoded as a depth field. Occlusions caused by convexity as well as shadowing between objects must be accounted for as well. Finally, diffuse to specular emitting surfaces produces different wavefield disturbances for identical contour geometries. Finally, the detector size is typical smaller than the solid angle of the imaged 3D scene.

Even in metrology, we are typically not interested in the precise values of the random speckle pattern, but rather in the overall shape of the speckle noise distribution. For example, in the work of Brady *et al.*,<sup>51</sup> the incoherent 3D scattering density is computed using a constrained optimization technique inspired by compressed sensing theory. Because most surfaces are diffuse, light emission will be roughly equal in all directions, indicating that there will be a lot of redundant information present in the hologram. If the speckle noise model could be factored in a compressed sensing framework, this would be beneficial for the quality of the retrieved signal.

### 4.3 Volumetric scene modeling

Microscopic scenes are generally strictly limited in their depth extent because often samples are nearly flat. When a hologram of such a microscopic object is backpropagated to the sample location, its signal properties resemble that of natural images. Indeed, the phase image will provide a depth map of the recorded sample and the amplitude image will provide the intensity absorption following the shape of the object's contours. Thus, we can easily model the image using the same type of basis functions used to efficiently compress natural images.

For example, Wavelets combined with a backpropagation kernel are typically used as a sparsifying operator on the recorded hologram.<sup>20,33</sup> Unfortunately, this model is inadequate for macroscopic scenes for several reasons. First, large hologram apertures results in a small depth of field and the extended scene depth make it impossible to have the whole scene in focus simultaneously. Secondly, large diffraction angles correspond to high frequencies in the holographic signal, meaning that the frequency distribution will not match the  $1/f^2$  shape present in the characteristic power spectra of natural imagery. Wavelets and similar transforms will therefore perform sub-optimally for holograms. Finally, (self-)occlusion introduce nonlinearities in the wavefield propagation model which call for the inclusion of advanced data structures and geometrical methods in the forward model. Figure 8 illustrates these complex inter-related geometrical effects and limitations.

Different signal models are required for efficient sparse volumetric scene representations, without being so complicated as to be computationally intractable given the input size of the holograms. Potential solutions would involve point cloud models that are sparse in nature or multi-resolution sparse voxel octree representations. Customized adaptive transforms based on advanced lifting schemes are a promising potential research venue.<sup>22</sup> Other approaches based on dictionary learning and machine learning could be applied as well if the large dimensionality barrier can be overcome.

## 5. CONCLUSION

In section 3, we have overviewed the state of the art of compressed sensing for digital holography at the microscopic scale. A wide and rich variety of studies have been conducted in that area. On the other hand, few efforts have been dedicated in translating this attractive signal processing paradigm to the macroscopic scale. Section 4 presented an outlook of hurdles and challenges that should be overcome for making digital holography a high-quality imaging modality at the macroscopic scale. At large scales, the space-bandwidth product increases tremendously and more gain may be expected from compressed digital holography as the relative levels of details decrease with increasing scale. The definition of holograms required at the macroscopic scale could go up to Terapixels and we expect that future work will unveil the potential of sparse regularization techniques for representing, compressing and transmitting real-sized holograms.

## ACKNOWLEDGMENTS

The research leading to this article has received funding from the European Research Council under the European Union's Seventh Framework Programme (FP7/2007-2013)/ERC Grant Agreement nr. 617779 (INTERFERE).

## REFERENCES

- [1] Stern, A., August, I. Y., and Oiknine, Y., "Hurdles in the implementation of compressive sensing for imaging and ways to overcome them," in [*SPIE Commercial + Scientific Sensing and Imaging*], 987006–987006, International Society for Optics and Photonics (2016).
- [2] Rivenson, Y., Stern, A., and Javidi, B., "Overview of compressive sensing techniques applied in holography [invited]," *Applied optics* **52**(1), A423–A432 (2013).
- [3] Xing, Y., Kaaniche, M., Pesquet-Popescu, B., and Dufaux, F., [*Digital Holographic Data Representation and Compression*], Academic Press (2015).
- [4] Dufaux, F., Xing, Y., Pesquet-Popescu, B., and Schelkens, P., "Compression of digital holographic data: an overview," in [*Proc. SPIE Applications of Digital Image Processing XXXVIII*], **9599**, 95990I–11 (2015).
- [5] Tsang, P. W. M. and Poon, T.-C., "Review on the state-of-the-art technologies for acquisition and display of digital holograms," *IEEE Transactions on Industrial Informatics* **12**(3), 886–901 (2016).
- [6] McLeod, E. and Ozcan, A., "Unconventional methods of imaging: computational microscopy and compact implementations," *Reports on Progress in Physics* **79**(7), 076001 (2016).
- [7] Donoho, D. L. and Stark, P. B., "Uncertainty principles and signal recovery," *SIAM Journal on Applied Mathematics* **49**(3), 906–931 (1989).
- [8] Donoho, D. L. and Elad, M., "Maximal sparsity representation via l1 minimization," *submitted to IEEE Trans. Inf. Theory* (2002).
- [9] Daubechies, I., Defrise, M., and De Mol, C., "An iterative thresholding algorithm for linear inverse problems with a sparsity constraint," *Communications on pure and applied mathematics* **57**(11), 1413–1457 (2004).
- [10] Donoho, D., "Compressed sensing," *IEEE Transactions on Information Theory* **52**(4), 1289–1306 (2006).
- [11] Candès, E. J. and Romberg, J., "Sparsity and incoherence in compressive sampling," *Inverse Problems* **23**(3), 969–985 (2007).
- [12] Candès, E. J. and Wakin, M. B., "An introduction to compressive sampling," *IEEE Signal Processing Magazine* **25**, 21–30 (2008).
- [13] Romberg, J., "Imaging via compressive sampling," *IEEE Signal Processing Magazine* **25**(2), 14–20 (2008).
- [14] Foucart, S. and Rauhut, H., "A mathematical introduction to compressive sensing," *Springer* (2012).
- [15] Eldar, Y. C. and Kutyniok, G., eds., [*Compressed Sensing: Theory and Applications*], Cambridge University Press (2012).
- [16] Lucente, M., "Computational holographic bandwidth compression," *IBM Systems Journal* **35**(3.4), 349–365 (1996).
- [17] Cohen, A., Daubechies, I., and Feauveau, J.-C., "Biorthogonal bases of compactly supported wavelets," *Communications on Pure and Applied Mathematics* **45**(5), 485–560 (1992).
- [18] Daubechies, I. and Sweldens, W., "Factoring wavelet transforms into lifting steps," *J. Fourier Anal. Appl* **4**, 247–269 (1998).

- [19] Blinder, D., Bruylants, T., Ottevaere, H., Munteanu, A., and Schelkens, P., “JPEG 2000-based compression of fringe patterns for digital holographic microscopy,” *Optical Engineering* **53**(12), 123102–123102 (2014).
- [20] Yan, H., Blinder, D., Bettens, S., Ottevaere, H., Munteanu, A., and Schelkens, P., “CDF 9/7 wavelets as sparsifying operator in compressive holography,” in [*Image Processing (ICIP), 2015 IEEE International Conference on*], IEEE (2015).
- [21] Xing, Y., Kaaniche, M., Pesquet-Popescu, B., and Dufaux, F., “Vector lifting scheme for phase-shifting holographic data compression,” *Optical Engineering* **53**(11), 112312 (2014).
- [22] Xing, Y., Kaaniche, M., Pesquet-Popescu, B., and Dufaux, F., “Adaptive nonseparable vector lifting scheme for digital holographic data compression,” *Appl. Opt.* **54**(1), A98–A109 (2015).
- [23] Xing, Y., Kaaniche, M., Pesquet-Popescu, B., and Dufaux, F., “Sparse based adaptive non separable vector lifting scheme for holograms compression,” in [*3D Imaging (IC3D), 2015 International Conference on*], 1–8 (2015).
- [24] Chen, R. H.-Y. and Wilkinson, T. D., “Computer generated hologram from point cloud using graphics processor,” *Applied optics* **48**(36), 6841–6850 (2009).
- [25] Symeonidou, A., Blinder, D., Munteanu, A., and Schelkens, P., “Computer-generated holograms by multiple wavefront recording plane method with occlusion culling,” *Optics express* **23**(17), 22149–22161 (2015).
- [26] Banerjee, P., Liu, H., and Williams, L., “Experimental evaluation of digital holographic reconstruction using compressive sensing,” in [*SPIE OPTO*], 90060Y–90060Y, International Society for Optics and Photonics (2014).
- [27] Stern, A. and Rivenson, Y., “Theoretical bounds on fresnel compressive holography performance,” *Chinese Optics Letters* **12**(6), 060022 (2014).
- [28] Rivenson, Y. and Stern, A., “What is the reconstruction range for compressive Fresnel holography?,” in [*Computational Optical Sensing and Imaging*], CWB6, Optical Society of America (2011).
- [29] Rivenson, Y. and Stern, A., “Conditions for practicing compressive Fresnel holography,” *Optics letters* **36**(17), 3365–3367 (2011).
- [30] Liu, H., *Evaluation of Digital Holographic Reconstruction Techniques for Use in One-shot Multi-angle Holographic Tomography*, PhD thesis, University of Dayton (2014).
- [31] Bioucas-Dias, J. M. and Figueiredo, M. A., “A new TwIST: two-step iterative shrinkage/thresholding algorithms for image restoration,” *IEEE Transactions on Image processing* **16**(12), 2992–3004 (2007).
- [32] Endo, Y., Shimobaba, T., Kakue, T., and Ito, T., “GPU-accelerated compressive holography,” *Optics express* **24**(8), 8437–8445 (2016).
- [33] Bettens, S., Yan, H., Bundervoet, S., Schretter, C., Dooms, A., and Schelkens, P., “Reconstruction resilience to subsampling in compressive fresnel holography,” in [*Digital Holography and Three-Dimensional Imaging*], DT1A–3, Optical Society of America (2015).
- [34] Katkovnik, V., Migukin, A., and Astola, J., “Computational inverse holographic imaging: toward perfect reconstruction of wavefield distributions,” in [*Fringe 2009*], 1–8, Springer (2009).
- [35] Tian, L., Lee, J. W., and Barbastathis, G., “Compressive holographic inversion of particle scattering,” in [*Digital Holography and Three-Dimensional Imaging*], DMA6, Optical Society of America (2011).
- [36] Liutkus, A., Martina, D., Popoff, S., Chardon, G., Katz, O., Lerosey, G., Gigan, S., Daudet, L., and Carron, I., “Imaging with nature: Compressive imaging using a multiply scattering medium,” *Scientific reports* **4** (2014).
- [37] Rivenson, Y., Stern, A., and Javidi, B., “Compressive Fresnel holography,” *Journal of Display Technology* **6**(10), 506–509 (2010).
- [38] Rivenson, Y. and Stern, A., “Compressive sensing techniques in holography,” in [*Information Optics (WIO), 2011 10th Euro-American Workshop on*], 1–2 (2011).
- [39] Stern, A. and Rivenson, Y., “Compressive sensing in holography,” in [*5th International Universal Communication Symposium, Korea*], (2011).
- [40] Rivenson, Y., Rot, A., Balber, S., Stern, A., and Rosen, J., “Recovery of partially occluded objects by applying compressive fresnel holography,” *Optics letters* **37**(10), 1757–1759 (2012).
- [41] Duarte, M. F., Davenport, M. A., Takhar, D., et al., “Single-pixel imaging via compressive sampling,” *Signal Processing Magazine, IEEE* **25**(2), 83–91 (2008).

- [42] Clemente, P., Durán, V., Tajahuerce, E., Andrés, P., Climent, V., and Lancis, J., “Compressive holography with a single-pixel detector,” *Optics letters* **38**(14), 2524–2527 (2013).
- [43] Li, J., Li, Y., Wang, Y., Li, K., Li, R., Li, J., and Pan, Y., “Two-step holographic imaging method based on single-pixel compressive imaging,” *Journal of the Optical Society of Korea* **18**(2), 146–150 (2014).
- [44] Wan, Y., Man, T., Wu, F., Kim, M. K., and Wang, D., “Parallel phase-shifting self-interference digital holography with faithful reconstruction using compressive sensing,” *Optics and Lasers in Engineering* **86**, 38–43 (2016).
- [45] Li, J., Pan, Y., Li, J., Li, R., Yang, Z., Xu, K., Tang, Z., and Zhong, T., “Compressive holographic imaging based on single in-line hologram and superconducting nanowire single-photon detector,” *Optics Communications* **355**, 326 – 330 (2015).
- [46] Brady, D., Choi, K., Marks, D. L., Horisaki, R., and Lim, S., “Compressive holography,” *Optics express* **17**(15), 13040–13049 (2009).
- [47] Lim, S., Marks, D. L., and Brady, D. J., “Sampling and processing for compressive holography [invited],” *Applied optics* **50**(34), H75–H86 (2011).
- [48] Hahn, J., Lim, S., Choi, K., Horisaki, R., and Brady, D. J., “Video-rate compressive holographic microscopic tomography,” *Opt. Express* **19**(8), 7289–7298 (2011).
- [49] Cull, C. F., Wikner, D. A., Mait, J. N., Mattheiss, M., and Brady, D. J., “Millimeter-wave compressive holography,” *Applied optics* **49**(19), E67–E82 (2010).
- [50] Denis, L., Lorenz, D., Thiébaud, E., Fournier, C., and Trede, D., “Inline hologram reconstruction with sparsity constraints,” *Optics letters* **34**(22), 3475–3477 (2009).
- [51] Choi, K., Horisaki, R., Hahn, J., Lim, S., Marks, D. L., Schulz, T. J., and Brady, D. J., “Compressive holography of diffuse objects,” *Appl. Opt.* **49**(34), H1–H10 (2010).
- [52] Cao, X., Sang, X., Chen, Z., Zhang, Y., Leng, J., Guo, N., Yan, B., Yuan, J., Wang, K., and Yu, C., “Fresnel hologram reconstruction of complex three-dimensional object based on compressive sensing,” *Chinese Optics Letters* **12**(8), 080901 (2014).
- [53] Li, J., Wang, Z., Huang, J., Liu, Y., and Gao, J., “Optimization of the object function matrix to improve the reconstruction speed and quality in compressive holography,” *Optics Communications* (2016).
- [54] Rivenson, Y., Stern, A., and Rosen, J., “Compressive multiple view projection incoherent holography,” *Optics express* **19**(7), 6109–6118 (2011).
- [55] Rivenson, Y., Stern, A., and Rosen, J., “On the tomographic reconstruction resolution from compressive holography,” *OSA Computational Optical Sensing and Imaging, Arlington, Virginia* (2013).
- [56] Tian, L., Liu, Y., and Barbastathis, G., “Improved axial resolution of digital holography via compressive reconstruction,” in [*Digital Holography and Three-Dimensional Imaging*], DW4C–3, Optical Society of America (2012).
- [57] Liu, Y., Tian, L., Huang, Y., and Barbastathis, G., “Two dimensional sub-pixel movement detection using spiral phase filtering and compressive holography,” in [*Digital Holography and Three-Dimensional Imaging*], DW4C–4, Optical Society of America (2012).
- [58] Liu, Y., Tian, L., Hsieh, C.-H., and Barbastathis, G., “Compressive holographic two-dimensional localization with  $1/30$  2 subpixel accuracy,” *Optics express* **22**(8), 9774–9782 (2014).
- [59] Williams, L., Nehmetallah, G., and Banerjee, P. P., “Digital tomographic compressive holographic reconstruction of three-dimensional objects in transmissive and reflective geometries,” *Applied optics* **52**(8), 1702–1710 (2013).
- [60] Weng, J., Pan, Z., and Yang, C., “Reconstruction of three-dimensional sectioning of object by single off-axis Fresnel hologram with compressive sensing,” *Optik-International Journal for Light and Electron Optics* **126**(23), 4646–4650 (2015).
- [61] Song, J., Swisher, C. L., Im, H., Jeong, S., Pathania, D., Iwamoto, Y., Pivovarov, M., Weissleder, R., and Lee, H., “Sparsity-based pixel super resolution for lens-free digital in-line holography,” *Scientific reports* **6** (2016).
- [62] Deepan, B., Quan, C., and Tay, C., “Compressive sensing for digital holographic interferometry,” in [*International Conference on Experimental Mechanics 2013 and the Twelfth Asian Conference on Experimental Mechanics*], 923419–923419, International Society for Optics and Photonics (2014).



- [63] Rivenson, Y., Stern, A., and Javidi, B., “Improved depth resolution by single-exposure in-line compressive holography,” *Appl. Opt.* **52**(1), A223–A231 (2013).
- [64] Rivenson, Y., Stern, A., and Javidi, B., “Compressive sensing for improved depth discrimination in 3D holographic reconstruction,” in [*Proc. of SPIE Vol.*], **8738**, 87380P–1 (2013).
- [65] Javidi, B., Tajahuerce, E., and Andres, P., [*Multi-dimensional Imaging by Compressive Digital Holography*], 75–99, John Wiley & Sons, Ltd (2014).
- [66] Javidi, B., Mahalanobis, A., Xiao, X., Rivenson, Y., Horisaki, R., Stern, A., Latorre-Carmona, P., Martínez-Corral, M., Pla, F., and Tanida, J., “Multi-dimensional compressive imaging,” in [*SPIE Security+ Defence*], 889904–889904, International Society for Optics and Photonics (2013).
- [67] Weng, J., Clark, D. C., and Kim, M. K., “Compressive sensing sectional imaging for single-shot in-line self-interference incoherent holography,” *Optics Communications* **366**, 88–93 (2016).
- [68] Sotthivirat, S. and Fessler, J. A., “Reconstruction from digital holograms by statistical methods,” *Signals, Systems and Computers, 2004. Conference Record of the Thirty-Seventh Asilomar Conference on* **2**, 1928–1932 (2003).
- [69] Sotthivirat, S. and Fessler, J. A., “Penalized-likelihood image reconstruction for digital holography,” *JOSA A* **21**(5), 737–750 (2004).
- [70] Marim, M., Angelini, E., Olivo-Marin, J.-C., and Atlan, M., “Off-axis compressed holographic microscopy in low-light conditions,” *Optics letters* **36**(1), 79–81 (2011).
- [71] Fessler, J. A. and Sotthivirat, S., “Simplified digital holographic reconstruction using statistical methods,” in [*Image Processing, 2004. ICIP’04. 2004 International Conference on*], **4**, 2435–2438, IEEE (2004).
- [72] Rudin, L. I., Osher, S., and Fatemi, E., “Nonlinear total variation based noise removal algorithms,” *Physica D: Nonlinear Phenomena* **60**(1–4), 259–268 (1992).
- [73] Bourquard, A., Pavillon, N., Bostan, E., Depeursinge, C., and Unser, M., “A practical inverse-problem approach to digital holographic reconstruction,” *Optics Express* **21**(3), 3417–3433 (2013).
- [74] Marim, M. M., Atlan, M., Angelini, E., and Olivo-Marin, J.-C., “Compressed sensing with off-axis frequency-shifting holography,” *Optics letters* **35**(6), 871–873 (2010).
- [75] Fienup, J. R., “Phase retrieval algorithms: a comparison,” *Applied optics* **21**(15), 2758–2769 (1982).
- [76] Candes, E. J., Eldar, Y. C., Strohmer, T., and Voroninski, V., “Phase retrieval via matrix completion,” *SIAM review* **57**(2), 225–251 (2015).
- [77] Moravec, M. L., Romberg, J. K., and Baraniuk, R. G., “Compressive phase retrieval,” in [*Optical Engineering+ Applications*], 670120–670120, International Society for Optics and Photonics (2007).
- [78] Wei, K., “Solving systems of phaseless equations via Kaczmarz methods: A proof of concept study,” *Inverse Problems* **31**(12), 125008 (2015).
- [79] Shechtman, Y., Eldar, Y. C., Cohen, O., Chapman, H. N., Miao, J., and Segev, M., “Phase retrieval with application to optical imaging: A contemporary overview,” *IEEE Signal Processing Magazine* **32**(3), 87–109 (2015).
- [80] Goodman, J., [*Speckle Phenomena in Optics: Theory and Applications*], Roberts & Company (2007).
- [81] Kang, X., “An effective method for reducing speckle noise in digital holography,” *Chin. Opt. Lett.* **6**(2), 100–103 (2008).
- [82] Wang, Y., Meng, P., Wang, D., Rong, L., and Panzai, S., “Speckle noise suppression in digital holography by angular diversity with phase-only spatial light modulator,” *Opt. Express* **21**(17), 19568–19578 (2013).
- [83] Monaghan, D., Kelly, D., Hennelly, B., and Javidi, B., “Speckle reduction techniques in digital holography,” *Journal of Physics: Conference Series* **206**(1), 012026 (2010).
- [84] Maycock, J., McDonald, J. B., and Hennelly, B. M., “Speckle reduction of reconstructions of digital holograms using three dimensional filtering,” *Optics Communications* **300**, 142–155 (2013).