



HAL
open science

Fourth Century Black-glaze Ware from the Northern Periurban Sanctuary of Cumae

Priscilla Munzi, Vincenza Guarino, Alberto de Bonis, Vincenzo Morra, Celestino Grifa, Alessio Langella

► **To cite this version:**

Priscilla Munzi, Vincenza Guarino, Alberto de Bonis, Vincenzo Morra, Celestino Grifa, et al.. Fourth Century Black-glaze Ware from the Northern Periurban Sanctuary of Cumae. Giovanna Greco; Luigi Cicala. Archaeometry. Comparing Experiences, 19, Naus Editoria, 2014, Quaderni del Centro Studi Magna Grecia, 978-88-7478-035-8. hal-01435826

HAL Id: hal-01435826

<https://hal.science/hal-01435826v1>

Submitted on 27 Apr 2020

HAL is a multi-disciplinary open access archive for the deposit and dissemination of scientific research documents, whether they are published or not. The documents may come from teaching and research institutions in France or abroad, or from public or private research centers.

L'archive ouverte pluridisciplinaire **HAL**, est destinée au dépôt et à la diffusion de documents scientifiques de niveau recherche, publiés ou non, émanant des établissements d'enseignement et de recherche français ou étrangers, des laboratoires publics ou privés.

QUADERNI DEL CENTRO STUDI MAGNA GRECIA. 19

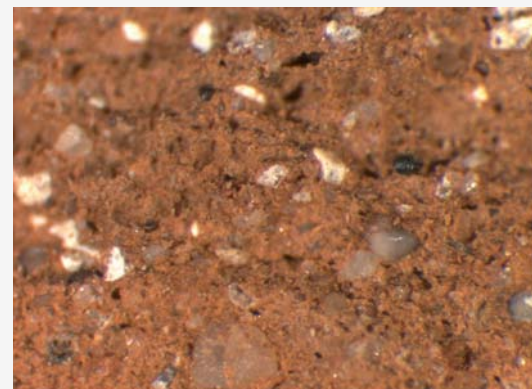
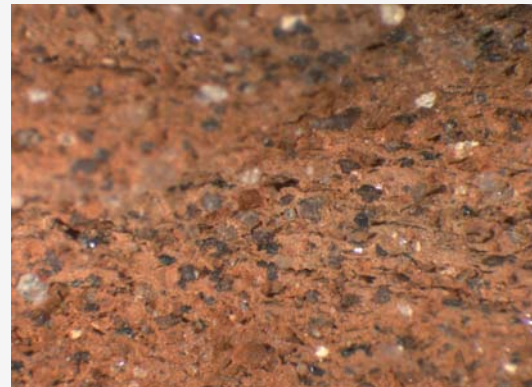

Archaeometry

Comparing experiences

Edited by Giovanna Greco and Luigi Cicala

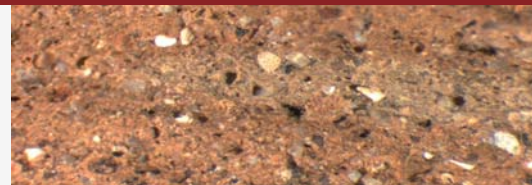

UNIVERSITÀ DEGLI STUDI DI NAPOLI FEDERICO II
DIPARTIMENTO DI STUDI UMANISTICI
CENTRO INTERDIPARTIMENTALE DI STUDI PER LA MAGNA GRECIA

Archaeometry. Comparing Experiences

edited by Giovanna Greco and Luigi Cicala

Naus Editoria
2014

Il volume è stato stampato con un contributo del Dipartimento di Studi Umanistici dell'Università degli Studi di Napoli Federico II. Hanno collaborato alle attività redazionali di questo volume Marialucia Giacco e Maria Luisa Tardugno.

Quaderni del Centro Studi Magna Grecia, collana a cura di Giovanna Greco.
Centro Interdipartimentale di Studi per la Magna Grecia, Dipartimento di Studi Umanistici,
Università degli Studi di Napoli Federico II

Comitato scientifico

Luisa Breglia, Carlo Gasparri, Giovanna Greco, Fabrizio Lo Monaco, Francesca Longo Auricchio

Redazione scientifica

Luigi Cicala, Bianca Ferrara, Luigi Vecchio

I volumi della collana sono sottoposti al Consiglio Scientifico del Centro Interdipartimentale di Studi per la Magna Grecia e al processo di *peer review*, affidato a specialisti anonimi, la cui documentazione è disponibile presso l'Editore.

Progetto grafico e realizzazione

Naus Editoria

Stampa

Grafica Elettronica, Napoli

Copyright © Pozzuoli 2014. Naus Editoria, www.naus.it

1. Archaeology 2. Archaeometry 3. Pottery production 4. Fabrics

ISBN 978-88-7478-035-8

È severamente vietata la riproduzione parziale o totale del testo e delle immagini.

Contents

- 7-15 G. GRECO, V. MORRA
The Beginning of Research
- 17-28 V. GASSNER, M. TRAPICHLER, with a contribution from K. SCHALLER†
A Web-based Information System of Pottery Fabrics in the Central Mediterranean (FACEM)
- 29-36 V. MORRA, A. DE BONIS, C. GRIFA
Geological Outlines of Studied Archaeological Sites
- 37-68 G. GRECO, A. TOMEO, B. FERRARA, V. GUARINO, A. DE BONIS, V. MORRA
Cumae, the Forum: Typological and Archaeometric Analysis of some Pottery Classes from Sondages inside the Temple with Portico
- 69-87 P. MUNZI, V. GUARINO, A. DE BONIS, V. MORRA, C. GRIFA, A. LANGELLA
Fourth Century Black-glaze Ware from the Northern Periurban Sanctuary of Cumae
- 89-109 D. GIAMPAOLA, S. FEBBRARO, A. DE BONIS, V. GUARINO, V. MORRA, C. GRIFA, A. LANGELLA
The Pottery Workshop Area at Piazza Nicola Amore, Naples. Black-glaze and Common Ware Production: Archaeology and Archaeometry
- 111-125 V. GASSNER, E. SCOPPETTA
Western Greek Amphorae from the Excavations at Piazza Nicola Amore, Naples
- 127-136 A. SERRITELLA, P. MONDA
Fratte: the Research Project
- 137-164 G. GRECO, G. PATERNOSTER, M. FRANCO, M. GIACCO, G. TROISI
Archaeometric Analysis of Ceramic and Bronze Artifacts from the Sanctuary of Hera at the Mouth of Sele River: New Results
- 165-189 B. FERRARRA, V. GUARINO, A. DE BONIS, V. MORRA, C. GRIFA, A. LANGELLA
The Sanctuary of Hera at the Mouth of the Sele River: Archaeometric Analyses for the Reconstruction of Black-glaze Ware Production at Paestum
- 191-269 V. GASSNER, M. TRAPICHLER, R. SAUER
Pottery Production at Velia: Archaeometric Analyses and the Typological Development of Glazed Ware, Coarse Wares and Transport Amphorae
- 271-292 L. CICALA, C. GRIFA, L. FRANCIOSI, A. LANGELLA, C. GERMINARIO, M. MERCURIO, V. MORRA
Ceramic Productions from Pian della Tirena, Nocera Terinese (Cz)

293-310 P. FRAGNOLI, C. CAPRIGLIONE, R. JUNG, M. PACCIARELLI
Before Sampling: Systematic Procedures of Macroscopic Pottery
Classification within the Punta Zambrone (VV) Research Project

Plates

Priscilla Munzi*, **Vincenza
Guarino****, **Alberto De
Bonis****, **Vincenzo Morra****,
Celestino Grifa***, **Alessio
Langella*****

Fourth Century Black-glaze Ware from the Northern Periurban Sanctuary of Cumae

Since 2001, the investigations of the Centre Jean Bérard (USR3133, CNRS - EFR) have concentrated on the outer urban perimeter of Cumae, within the area bounded to the N by the Southern shore of the ancient lake of Licola and to the S by the Northern walls of the lower town.

The investigations carried out in the field in front of the Median Gate, under the “Kyme 3” project, brought to light a complex of structures apparently belonging to a sacred area with different building phases, dated between the 6th and the 1st century BC (figs. 1-3).

The complex lies immediately E of the N/S road in front of the gate, approximately 50 m N of the town walls. All its structural elements lie on N/E-S/W orientation and are part of a wider and more ramified system.¹

We have undertaken an analytic study of the materials found in the destruction levels of the 5th to 4th century BC building in correlation with the different pottery classes documented in the sanctuary, which indicate a rather narrow time span coinciding with the second half of the 4th century BC. Here we will focus on the black-glaze ware.

1. The building complex

During the second half of the 6th century BC, the area in front of the gate was monumentalized by erecting one or more buildings. The complex of structures, whose ground plan is unfortunately only partially recognizable, is linked to a series of groundwater collection wells. Our analytical study of the ceramic material found here dates the last phase of use of the building within the first quarter of the 5th century BC.

Around the mid-5th century BC, the area shows signs of major renovation. New structures were built by reusing, in their foundations, part of the partition walls of the previous building phase. The building erected during this phase consists of a succession of at least three or perhaps four rectangular rooms, oriented E/W, and a large open space to the S. In the middle of one of the rooms of the new complex a low rectangular structure has been identified, consisting of a single block of tuff with significant traces of combustion. A thick layer of ash was deposited on it, and an ogival amphora with a flat bottom was half buried in the ground next to it. This hearth stood on a compact flooring

* Centre Jean Bérard (USR 3133 CNRS-EFR).

** Dipartimento di Scienze della Terra, dell’Ambiente e delle Risorse, Università degli Studi di Napoli Federico II.

*** Dipartimento di Scienze e Tecnologie, Università degli Studi del Sannio, Benevento.

¹ On the Northern periurban sanctuary of Cumae: BATS *et alii* 2010; DEWAILLY-MUNZI 2011; BRUN *et alii* forthcoming.



surface of tuff flakes. Several elements suggest that this room was used as a hestiatorion, and it seems plausible that the other rooms might have been used similarly, although the state of preservation of the structures makes it impossible to determine this with any certainty.

During the last decades of the 4th century BC the building was transformed. Some partition walls were dismantled and, at least in the N/W sector, replaced by a dump consisting of a thick layer of earth, stones, pottery fragments, and animal bones (US



1. Aerial photo of Cumae from the W.

2. Aerial view of the Northern suburban sanctuary of Cumae.

3. Northern suburban sanctuary of Cumae. Hellenistic building.

700138 and 700172). When the complex was transformed, a large pit, almost circular in shape (FS700114), in the S/W corner of the area with the fireplace, filled the spoliation cavity of part of the S and W walls and intact pots and architectural terracottas were deposited in it.

During the first half of the 3rd century BC a new building of limestone framework masonry was erected. This building ceased to exist during the first half of the 1st century BC and its vestiges were at least partly removed. Its abandonment was apparently celebrated with a new closing ceremony, which in this case is also archaeologically documented by some votive pits.

From the mid-1st century BC, the area was converted to a whole new purpose: it became a burial ground and was progressively occupied by funerary monuments.

2. The pottery

The destruction levels of the 5th to 4th century BC building yielded a significant amount of finds: roughly 27,500 sherds of approximately 6,000 individual artifacts.

The coarse ware (approximately 87% of diagnostic and 94% of total sherds) is

largely constituted by cooking ware, largely ollae, with far less frequent examples of lopades and caccabai, as well as some pans, many lids, and several sherds probably belonging to cooking bells. The coarse ware consists of ollae and amphorae, along with some fragments of mortars and lekanai for food preparation.

The context also yielded several black-glaze ware vessels (approximately 7% of diagnostic and 4% of total fragments), miniaturistic vessels (5% of diagnostic fragments) and some red-figured vases (less than 1% of diagnostic fragments).

The examples of black-glaze ware we examined mainly consist of drinking vases, closed forms being completely absent.² They date from the second half of the 4th century BC, the more recent *terminus ante quem* being provided by certain types, viz., series 4373 skyphoi, species 4240 kylikes with impressed decoration, species 6210 and 6230 one-handler cups, series 2586 cups and species 2780 cups with impressed decoration, series 2424, 2433, and 2435-2437 small concave-convex cups, and series 2971 small cups, all shapes with extensive parallels among materials from Cumae³ and other Campanian sites.

The most frequent types are skyphoi (approximately 38.5% of the total). This shape is mainly documented in series 4373. It is characterised by a slightly everted rounded rim, a sinuous profile leaning towards the concave-convex, horizontal handles, and a distinct ring foot (fig. 4, nos. 228 and 236). The examples from Cumae often show a reddish coating on the outer bottom, similar to that of milto Attic vases. The series has been defined by Morel as typical of the Apulian area.⁴ However, research over the past few decades has shown that such skyphoi are also widespread in Campania, Samnium, Southern Italy, and Sicily, especially from the last quarter of the 4th century BC to the following century.⁵ Within the context under study at Cumae there are also examples of series 4311, characterised by a thin rim, an ovoid profile sagging at the base, and a disc foot, as well as examples of series 4382, with a simple rim, sometimes thinned, a bowl with an almost frustoconical profile, and a large ring foot. The skyphoi belonging to these last two series are widely documented in Southern Italy and Sicily and date from the 5th century BC. While Attic-type skyphoi do not seem to extend much beyond the third quarter of the 4th century BC, series 4311 is well documented in the second half of the 4th and first quarter of the 3rd century BC.⁶

There are also several one-handler cups of species 6210 and 6230 (approximately 14% of the total), well known in Southern Italy, especially in Lucania and Apulia.⁷ The type represented by the largest number of examples is species 6230, characterised by a short plain lip with a rounded rim, a hemispheric bowl, a handle, circular in section, set below the rim, and a ring foot (fig. 4, no. 231). One of the examples from the sanctuary has a lug under the lip and an impressed decoration, only partially preserved, within at least three rows of rouletting. The type is well documented in series 6231 and 6232 from the old excavations in Capua.⁸

Species 6210 occurs in approximately the same percentage. It is characterised by a rounded rim, a convex profile, a handle, circular in section, set close to the rim, and a ring foot. The type is widespread in southern Italy, especially in Apulia and Campania, during the 4th century BC. The species was already known to be present in Cumae from an unpublished example from the necropolis.⁹ The type is also attested at Capua, in the San

² We used J.-P. Morel's typological classification of black-glaze ware (MOREL 1981).

³ GABRICI 1913, 707-708, tav. CV, 1 and 3; TOMEIO 2008, 49-74.

⁴ MOREL 1981, 311, pl. 131.

⁵ Most recently, SERRITELLA 2013, 134 and note 31, with extensive bibliography on the Campanian and Lucanian area.

⁶ SERRITELLA 2013, 132-134 and notes 27 (series 4311) and 28 (series 4382) on the spread of the series in Campania.

⁷ MOREL 1981, 394, pl. 194. On its spread in the Lucanian milieu, see SERRITELLA 2013, 137 and note 37.

⁸ MOREL 1981, 395, pls. 194-195; MINGAZZINI 1958, tav. 20, 3 and 7.

⁹ This specimen is discussed in BENASSAI 2004, 186 («grave goods in tomb 243»).

F4373

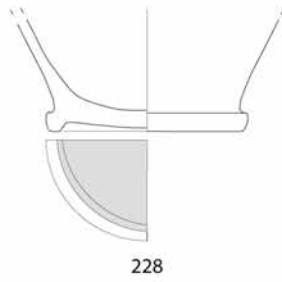

F4241

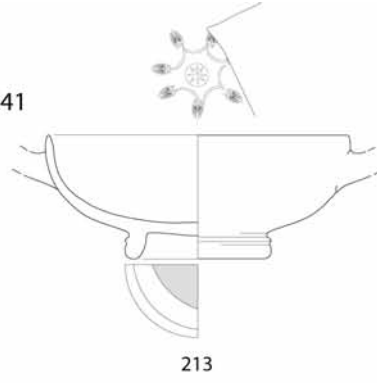

F6230

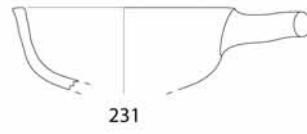

F2586



F2784

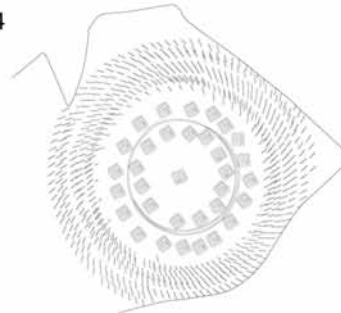

F2971



F2433

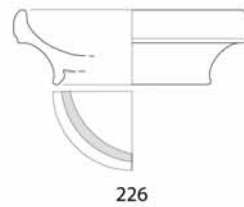

F2424

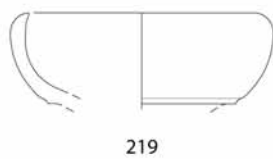
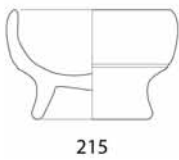

F2437

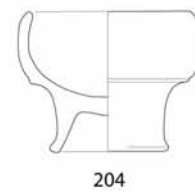
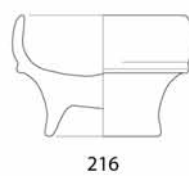

Prisco necropolis.¹⁰

There are also many small cups, especially of the concave-convex type (almost 12% of the diagnostics), documented in several series of species 2420 (series 2421, 2423, and 2424) and 2430 (series 2433, 2434, and 2435-2437). These small cups are characterised by a concave-convex profile with a fillet, a carination or an offset at the base, a moderately high foot, and a large diameter, with vertical or convex bowl.

Series 2433 (fig. 4, no. 226) and 2435-2437 (fig. 4, nos. 204, 216) are documented by a greater number of types. One is characterised by a low bowl with a convex profile, a fillet between the bowl and foot, and a low and large foot with a concave profile. The examples from Cumae often have a base covered by a thin reddish slip. According to Morel, this series is derived from Attic products and produced in Apulia and Campania.¹¹ The two examples used to illustrate the series come, respectively, from Ischia (Lacco Ameno) and Pompeii. The latter carries an impressed decoration, and is of a type whose production Morel situates in Capua.¹² This series, already known from the excavations of Stevens in Cumae,¹³ is widespread in southern Italy (especially in Puglia).¹⁴ In Campania it is also documented in Fratte, Pontecagnano - where it was produced beginning in the late 5th century BC - Paestum and, obviously Capua, where it was found both in the old excavations and in the necropolis of San Prisco.¹⁵

The classification of series 2435-2437 small cups is more complex because their fragmentary state does not allow precise typological definition. These series share some common features: a convex profile, a carination between the bowl and the foot, and a usually large foot with a concave profile. Unfortunately, it is only foot height that distinguishes the different types. These small cups do not seem widespread. They mostly occur in Campania, notably in Naples and its hinterland (Ponticelli, Qualiano), Cales, Capua, Teano and the Alifan area, as well as Fratte and Pontecagnano.¹⁶ Specimens from the second half of the 4th century BC have been discovered in both Capua and Pontecagnano, particularly those dating from the third quarter of the century. It should be noted that examples from Capua and Teano, for which a local production is assumed, often show an impressed decoration.¹⁷

Within the black-glaze morphological repertoire documented by the destruction levels of the periurban sanctuary of Cuma, kylikes and cups turned out to be particularly significant, both for their peculiar technical and decorative characteristics and for their range of distribution.

The typological classification of kylikes, 11.5% of the total, is problematic. The morphological characteristics and proportions of the examples we examined suggest that they belong to species 4240, and more specifically to series 4241. This series is characterised by a vertical or slightly inward bent rim, a shallow hemispherical bowl, a slightly molded foot ring, handles bent slightly inwards, and a rim that protrudes only slightly or not at all (figs. 4 and 5, no. 213). Morel, using an example from Capua to

¹⁰ MOREL 1981, 393, pl. 194. On the spread of the species in Campania and especially in Capua: BENASSAI 2004, 184-186.

¹¹ MOREL 1981, 170 and note 166.

¹² Morel 1981, note 167 for an identical specimen from the Marica sanctuary at the mouth of Garigliano River; MOREL 1965, 82-83, SHAPEE 109, fig. 1.1 and 3.1 (decoration), "protocampanienne" (second half of the 4th century BC?).

¹³ DE FILIPPIS 1996, 237, T. 36, n. 16.10 (last quarter of the 4th century BC); 240, T. 185, nn. 16.39-40 (late 4th - early 3rd century BC).

¹⁴ On the spread of the series in Southern Italy: SERRITELLA 1995, 92 and note 32 with extensive bibliography.

¹⁵ BENASSAI 2004, 186, fig. 144 and note 265.

¹⁶ MOREL 1981, 171, pl. 50. On the spread of these series in Campania: BENASSAI 2004, 186-188, fig. 144 and SERRITELLA 2013, 142, both with further references. On the Alifan territory: LISTA 1990, 82, nn. 292-293 (Loc. Dragoni), tav. II.

¹⁷ On the black-glaze ware production from Teano see the recent essay by Ilaria Manzini (MANZINI 2013).

illustrate the type, attributes it to Southern Italian productions, probably inspired by Greek prototypes.¹⁸ Not many parallels for series 4241 have been found in Campania or, more generally, in Southern Italy. In contemporary Campanian contexts, the kylix shape is primarily documented in series 4253, 4222, 4242 and 4284.¹⁹ The latest publication of finds from the Stevens excavation also documents its presence in Cumae.²⁰

A large number of sherds of Cumaean kylikes are characterised by a slightly molded ring foot with an external base with a thin red slip, decorated with impressed patterns inside the bowl (fig. 5, nos. 242, 243 and 250). These features can probably be attributed to species 4240, although they are also found in series 4253. The impressed decoration on the inside bottom of the base is generally formed of palmettes around small arches with central rosettes (a differentiated type) or multi-pointed stars, palmettes around small arches around a head/gorgoneion, or radial palmettes. In his 1965 article on the black-glaze ware from Pompeii, Morel associated these motifs with the shapes he defined, following Lamboglia, as Proto-Campanian pottery.²¹ Some Cumaean examples found parallels in the Campanian area as documented by the old excavations in Capua.²² The decorative scheme of a kylix bottom - a small face/mask (possibly a gorgoneion) within two rings of leaflets amidst five palmettes around small arches (fig. 5, no. 250) - has a parallel in a vase in the Museo Campano of Capua²³ and, only for the small face/mask motive, with a "bowl" from Cumae.²⁴ The decoration of another example, with the bottom decorated by an eight-pointed star surrounded by six palmettes around small arches (fig. 5, no. 243), is very similar to that of another vase from Capua.²⁵

Kylikes and cups with similar decorations are documented among grave-goods of the second half of the 4th century BC from the Cumaean necropolis.²⁶ Among the materials published by Gabrici in 1913, two kylix bottoms are of considerable interest. Both bear the Greek signature of their manufacturer.²⁷ The examples are described as follows: - «*N. 1. Kylix campana (diam. cm 12), che ha sul fondo cinque palmette impresse in giro ad una mascheretta (Gorgoneion?), sotto alla quale si legge il nome del fabbricante TIMOXENOs. - N.9. Simile kylix (diam. cm 12); del nome si legge TIMOXEN*». The Greek letters and the head/gorgoneion are part of the same stamp.

Cups are among the most frequent shapes, representing just over 11% of total. There are few types, essentially of series 2586 and species 2780, most notably series 2784, the most difficult to classify.

Cup series 2586 is documented by several examples (figs. 4-5, no. 211), characterised by a shallow, regularly curved bowl, an inwards slanting rim, and a high ring foot. In this type, the outer bowl is characterised by an offset at approximately the middle of the cup. These cups generally carry an impressed decoration on the inside of the bottom. The Cumaean example chosen to illustrate this type has a decoration on the bottom within

¹⁸ MOREL 1981, 296-297, pl. 121.

¹⁹ It is hard to typologically and more accurately assess the kylikes found in Campanian contexts without a graphic documentation. On the occurrence of kylikes in contemporary Campanian contexts see: BENASSAI 2004, 192-194 (Capua); DE FILIPPIS *et alii* 2013 (Sessa Aurunca); LISTA 1990 (Alifan territory); MINGAZZINI 1930 (Vitulazio); GIGLIOLI 1922 (Ponticelli); GIAMPAOLA 1985 a (Ponticelli); MINIERO *et alii* 1997 (Castellamare di Stabia).

²⁰ DE FILIPPIS 1996; C. Rescigno and L. Petacco, in ZEVI *et alii* 2008, 275-289.

²¹ MOREL 1965, 82-84, fig. 3. For a precise definition of "Protocampanian" and various general observations on this ware: LAMBOGLIA 1952 a, 74-75; LAMBOGLIA 1952 b, 165; LAMBOGLIA 1960, 293.

²² MINGAZZINI 1958, 36, tav. 16, nn. 1-3 (shapes) and above all tav. 25 on decorations.

²³ MINGAZZINI 1958, 20, 36, tav. 25, n. 2. Mingazzini attributes the decoration to a double-handled cup of the type represented on tav. 16. 1 (20, tav. 16, fig. 1b).

²⁴ GABRICI 1913, 702-703, tav. CVII, n. 2.

²⁵ MINGAZZINI 1958, 20, 36, tav. 25, n. 3. The decoration reproduction is attributed by Mingazzini to a double-handled cup of the type represented on tav. 16. 1 (20, tav. 16, fig. 1d).

²⁶ GABRICI 1913, 702-703, tav. CVII.

²⁷ GABRICI 1913, 703, tav. CVII, nn. 1 and 8.

5. Northern suburban sanctuary of Cumae. Some cups and kylixes.

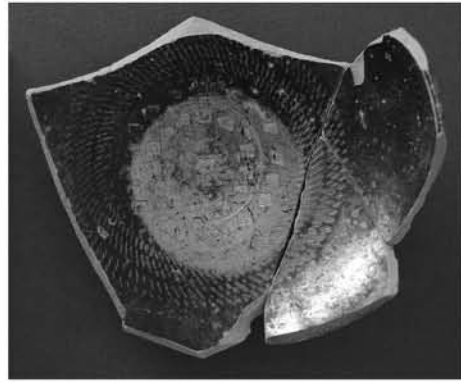

Coppa n. 209

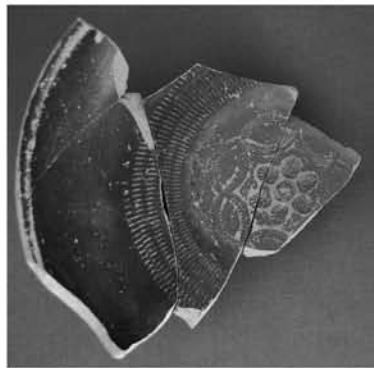

Coppa n. 211

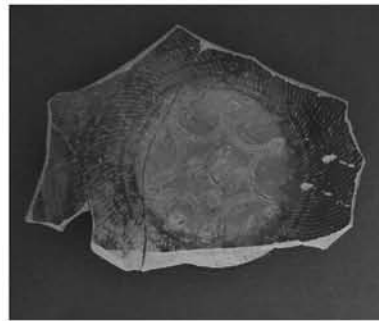

Coppa n. 241

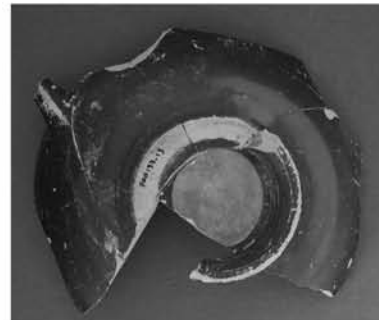
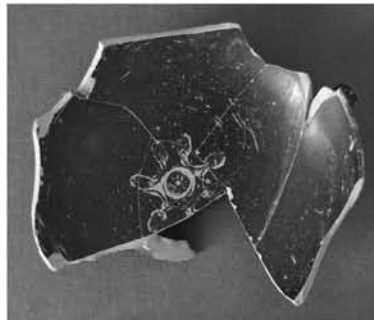

Kylix n. 213

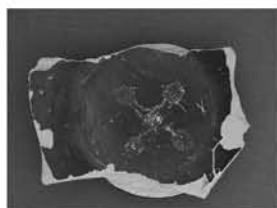

Kylix n. 242



Kylix n. 243



Kylix n. 250

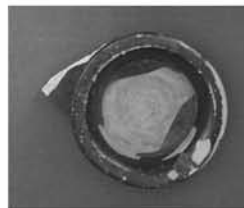

five rows of rouletting, surrounding six radial palmettes linked by seven elliptical festoons with corymbs, perhaps with a rosette in the middle. Morel defined this series as probably Capuan or at least from Northern or North-central Campania, using at least two cups, probably from Naples,²⁸ to illustrate it. The spread of this type of cup actually seems to be restricted to North-central Campania towns, where it is documented by several examples²⁹ besides the Cumaean ones, notably from recent excavations of Line 1 of the Metro, Duomo station, in Piazza Nicola Amore in Naples,³⁰ a tomb in the Ponte S. Prisco necropolis in Capua,³¹ the Loreto sanctuary, in Teano,³² and the Piscinola necropolis in the territory of Sessa Aurunca.³³ Another similar example with an almost identical decoration comes from S. Polo (Campono) in Sannio,³⁴ and there is an unprovenanced sample in Copenhagen.³⁵

A second set of cups is attributable, instead, to species 2780 and probably also to series 2784.³⁶ They are cups with a convex hemispherical bowl, a high and slanted ring foot, and an inward curved and slightly thinned rim. According to Morel, this series includes cups produced in central Italy, especially by the *Atelier des petites estampilles*, in the early 3rd century BC. Apart from Rome and Lazio, there are known examples in Campania, from Capua³⁷ and Naples,³⁸ as well as Fratte and Pontecagnano.³⁹ A local production is assumed for both Capua and Pontecagnano.

The only Cumaean specimen with an entirely reconstructible profile (figs. 4 and 5, no. 209) has an impressed decoration within seven or eight narrow rouletted bands on the bottom, enclosing two meandering rows divided by one line and a meander in the middle.

A consistent percentage of the whole fragments related to cups consist of bottoms with a ring foot with a stamped decoration (fig. 5, no. 241). These fragments are probably attributable to cups with regularly curved bowls and oblique rims curved inwards (series 2586) and to hemispherical cups with slightly thinned rounded rims (species 2780).

The decorative patterns on these vessels are rather complex, although the associations of stamps are quite repetitive. These consist of *guillochures* arranged in several registers, which frame a variety of motifs, such as: meanders, palmettes and meanders, palmettes and dotted festoons (arcs), and dotted ellipses associated with other elements (palmettes, meandering, gorgoneia, rosettes, etc.). Furthermore, our study of the stamps also shows that the punches used for the decoration of kylikes are not used for cups, whereas some motifs, such as *guillochures* and meanders, are found also on some one-handled and small concave-convex profile cups.

²⁸ MOREL 1981, 188, pl. 58. The specimens date to 290 ± 20 BC. See also HOLWERDA 1936, 18, nos. 156 and 158 (Naples), pls. II and X (decoration of no. 156).

²⁹ Centre Jean Bérard excavations within the area of the Middle Gate necropolis. See also: VAN INGEN 1933, 57, pl. XXXII, nos. 19, 21, 22 and 24 (shapes), with decorations on pl. XXXV, nos. 12 (shape no. 24) and 13 (shape no. 22), which combines ellipses, palmettes and guillochures; specimen no. 11 (shape no. 19) is without palmettes. These vessels come from the Canonico de Criscio Collection.

³⁰ The specimen is displayed in the hall inside the Museo Metro station in Naples (window 1, no. 36). On the inner bottom of the vase there is a decoration on several registers including guillochures and a dotted ellipses pattern.

³¹ BENASSAI 2004, 182, tomb 8 (mid 4th century BC, or even earlier). The specimen shows a complex stamped decoration: «in the middle of the body there is an unclear head, perhaps a Silenus, crowned by six radial palmettes, surrounded by ten more small palms linked by a double festoon decorated with dots».

³² MANZINI 2013, 202, fig. 3d and 207, note 19.

³³ DE FILIPPIS *et alii* 2013, 191-192, where the black-glaze shapes are assumed to come from workshops in Teano; in particular, see grave-goods 59, 88, 70, 84 and 78 (?), figg. 8-10, 16-17 for the presence of series 2586 cups and the association of materials.

³⁴ De Benedittis, in *Sannium* 1992, 173, d76 (4th-3rd century BC), tav. 14d.

³⁵ COOK *et alii* 1957, 225, pl. 287, 11a (shape) and b (decoration), unknown origin.

³⁶ MOREL 1981, 224.

³⁷ BENASSAI 2004, 183.

³⁸ The specimen from Naples (albeit with a degree of uncertainty) is in HOLWERDA 1936, 18, no. 157, pls. II and X (decoration). Oddly, it was not taken into account by Morel in his 1981 volume.

³⁹ SERRITELLA 1995, 93 and note 39, 110 on the spread.

The decorative motifs described above have plenty of parallels in Campania, where, however, the quality of the documentation does not always allow precise typological attributions to the singles series. These Cumaean cups, already known from earlier excavations,⁴⁰ find close parallels in some examples from Capua⁴¹ and Naples.⁴² In the Neapolitan inland, many examples are documented from the necropolis of Ponticelli,⁴³ while other samples come from Qualiano⁴⁴ and Vitulazio.⁴⁵ A very similar example is also documented in the Marica sanctuary at the mouth of the Garigliano River.⁴⁶

In 1965 J.-P. Morel, in an article on black-glaze ware from Pompeii, focusing on a bottom fragment showing an impressed decoration with a meander in the middle surrounded by festoons of double dotted arcs, observed that these stamps, which are countless in the Museum of Capua, constitute the elements of an extremely typical decoration of Proto-Campanian pottery in Campania. Their rare but significant occurrence on Campana A pottery indicates direct affiliation between the earliest shapes of this pottery and the later shapes of Proto-Campanian one, from which Campana A apparently borrowed some punches. This motif, on the Campana A, has to be dated no later than the mid-3rd century BC.⁴⁷

The small cups are less frequent, being fewer than 8% of the total. The most represented series is 2971, where the shape is characterised by a ring foot, a shallow bowl with an almost straight or slightly curved profile. A single example preserves on the inside bottom an impressed decoration consisting of multiple rows of *guillochures* with four palmettes in the middle (fig. 4, no. 51). Some miniaturistic examples may also be attributed to the same series. Morel suggests that these are from a production of Central-southern Italy and Sicily. One of those used to represent the series comes from Ischia.⁴⁸ The type is documented in the San Prisco necropolis in Capua.⁴⁹ Within this context some other small cups attributable to species 2730, series 2714, are also attested.

Our study of black-glaze ware from the destruction levels of the sanctuary in the second half of the 4th century BC, though still preliminary, has revealed, within a production zone in Southern Italy, morphological and decorative characteristics typical of inland Northern and coastal Campania.

From the morphological point of view, our study revealed a rather limited repertoire of types. The available data show that some of the shapes have a wide areal distribution - for example skyphoi, one-handler cups, and small cups-while others, such as kylikes and

⁴⁰ BENASSAI 2004 reports two specimens from Cumae (202 and note 380), with the same shape but a dotted-ellipse pattern combined with female or Silenus heads: MNA, inv. 128728 with female head; MNA, inv. 12893, with Silenus head. According to Benassai, the clay looks Capuan. Moreover, see the specimens belonging to the Canonico de Criscio Collection, probably coming from Cuma: VAN INGEN 1933, 57, pl. XXXII (shapes) and pls. XXXIII-XXXV (decorations).

⁴¹ Close parallels for decoration consisting of *guillochures*, ellipses, palmettes, and a central motif: BENASSAI 2004, 101-102, tomb 17 (territory of Ponte S. Prisco, N. De Angelis property, third quarter of the 4th century BC), inv. 184054, MOREL 1981, F2784, figs. 38a, 41c. For decoration consisting of *guillochures*, ellipses, palmettes, central motif: MINGAZZINI 1958, tav. 26, n. 2 (inv. 7690) and n. 8 (s.n.).

⁴² Cups without context showing an impressed decoration constituted by festoons and dotted palmettes are known in Naples: ROCCO 1954, Cales type pottery, 6, tav. 6.2 (inv. 83602) and tav. 7.2 (inv. 83702), both without origin.

⁴³ On the Ponticelli necropolis, see GIGLIOLI 1922, XIX, 257-286, and GIAMPAOLA 1985 a, 302-312. The Ponticelli necropolis revealed many cups ("bowls") in which the ellipsis motif ("oval rings" or "double festoons") is combined with other elements (gorgoneia, palmettes, meanders, etc.): GIGLIOLI 1922, 260, various tombs, n. 8; 262, T. IV, n. 10; 263, T. VIII, n. 4; 266, T. XIII, nn. 4-6; 268, T. XXIII, nn. 2-5, fig. 11; 278, T. LXX, n. 12; 279, T. LXXVII, n. 11; in general 286; GIAMPAOLA 1985 a, 306, T. 94 (about 340 BC), n. 88.6; 307, T. 2 (340-320 BC), n. 90.1, tav. XLV.

⁴⁴ GIAMPAOLA 1985 b, 318, T. 14 (about 350 BC), no. 96.3, tav. XLVII.

⁴⁵ MINGAZZINI 1930, 549, n. 4, fig. 2A.

⁴⁶ MINGAZZINI 1938, 897, n. 23, tav. XXXIX, 1.

⁴⁷ MOREL 1965, 87, no. 23, fig. 4, 10.

⁴⁸ MOREL 1981, 241.

⁴⁹ KEMP 1985, Crystallitic b-fabric (birefringent fabric) refers to the optically active portions of small crystals that are different from clay minerals.

cups, circulated over a smaller geographical area.

Our autoptic analysis, combined with a typological study, revealed technical characteristics (ceramic body, surface treatment, decoration, etc.) common to many distinct groups of shapes. Indeed, from a technological point of view, there is a certain resemblance between kylikes (species 4240, series 4253), skyphoi of series 4373 and some small cups, which led us to incorporate them into a single group characterised by higher quality, a clear (ocher) and more depurated ceramic body, thick coatings, reserved bases covered by a thin reddish coating similar to miltois Attic vases, quite thin walls, and a schematic use of impressed and repetitive motifs related to Attic models.

We also observed a certain technical homogeneity between series 2586 and 2784 cups, which appear to be generally coarser: darker (orange) ceramic body, thicker walls, and a generally opaque coatings, marked by patches with a metallic luster, greyish tones, uneven colouring, and reddish/orange zoning. The stacking disc on the inside bottom is often very marked, with colour fading to red or brown. The impressed decorative repertoire is homogeneous, the decorative syntax is quite complex, and the punches used are completely different from those used for the previous group.

A third group, characterised by a darker ceramic body, thicker walls, and a poor quality glaze, seems to be more more diversified. It includes species 2710 and series 2423 small cups, series 4382 skyphoi and some species 6210 and 6230 one-handler cups.

These initial observations, resulting from a cross-sectional study of morphological, decorative, and technological data, allow us to assume the existence of several pottery workshops, also including Cumaean ones. The data are accompanied by reflections on the spatial distribution of these artifacts and on the frequency of their occurrence not only in sanctuaries but also in necropoleis, and their contextual association. The non-discovery of archaeological evidence (furnaces, wastes, etc.) documenting a local production of this pottery class, however, is an obvious limit.⁵⁰

To complete our research, we started an archaeometric study to define, from a mineral-petrographic and chemical point of view, the black-glaze productions of the second half of the 4th century BC documented in the abandonment layers of the northern suburban sanctuary. The archaeometric investigation provided significant additional insights, both for the identification of sites of origin and for the tracing of short and medium-range commercial channels for the distribution of these wares (Campania).

3. Description of samples and methods of analysis

Thirteen samples (nine fragments of black-glaze ware and four fragments of coarse ware) from the Northern suburban sanctuary of Cumae (Hellenistic age, second half of the 4th century BC; tab. 1) were studied in this investigation. The two ceramic classes were found during the archaeological excavations and are representative of a large number of types. The nine fragments of black-glaze ware belonged to a patera (CUMN 1), a kylix (CUMN 2), small cups (CUMN 3 and 8), cups (CUMN 4 and 5), skyphoi (CUMN 6 and 7) and a one-handler cup (CUMN 9). The four coarse ware samples have a closed shape (CUMN 18, 19, 20, and 22).

We conducted mineral-petrographic tests on all pottery fragments in order to define their macroscopic, microscopic, and chemical features.

Macroscopic observation identified the colour of the ceramic pastes (using the Munsell Soil Colour Chart) and the surface, thickness, and manufacture of ceramic bodies.

Optical microscopy was used to investigate petrographic features such as texture, colour and matrix activity, and the mineralogy of the ceramic components.

⁵⁰ KEMP 1985. Speckled b-fabric (birefringent fabric) refers to the optically active portions of small crystals that are different from clay minerals.

Bulk chemical analyses were carried out by X-ray fluorescence (XRF) (Axios Panalytical instrument) at the Università degli Studi di Napoli “Federico II”. Analytical uncertainties are in the order of 1-2% for major elements (SiO₂, TiO₂, Al₂O₃, Fe₂O₃, MnO, MgO, CaO, Na₂O, K₂O and P₂O₅ in wt.%) and 5-10% for trace elements (Rb, Sr, Y, Zr, Nb, Ba, Cr, Ni, Sc, V, La and Ce in ppm).

Microchemical analyses of the thin black slips covering black-glaze ware and of mineral phases identified in pastes were conducted at the C.I.S.A.G. (Centro Interdipartimentale Strumentazioni per Analisi Geomineralogiche), Università degli Studi di Napoli Federico II, utilizing an Oxford Instruments Microanalysis Unit equipped with an INCA X-act detector and a JEOL JSM-5310 microscope. An accelerating voltage of 15 kV and a filament current of 50–100 µA were used for all of the analyses. Measuring times were 50 s. For calibration, both natural and synthetic standards were used.

Semi-quantitative X-ray powder diffraction analyses (XRPD) were carried out on some representative ceramic samples with a PANalytical X’Pert PRO 3040/60 PW diffractometer (CuK α radiation, 40 kV, 40 mA, scanning interval 4–50° 2 θ , step size 0.017° 2 θ , counting time 15.5 seconds/step), in order to identify the mineralogical composition of the potsherds, which depends on the base-clay and possible submicroscopic phases related to the firing dynamics (temperature, oxidizing or reducing conditions of the kiln atmosphere).

4. Results and Discussions

4.1. Macroscopic features

The ceramic pastes of black-glaze ware and coarse ware show a light brown colour; a few samples belonging to both pottery classes show a darker colour (tab. 1). All samples are characterised by a very fine and hard ceramic paste, with smooth surfaces.

The black-glaze ware is covered by a thin slip on the inside and outside. The CUMN 1, 3, and 5 samples have a metallic black slip, and the CUMN 4, 7, and 9 samples have visibly damaged surfaces. The CUMN 2 and 8 samples have a shiny black slip. The CUMN 6 sample has a shiny black slip and a red slip on its base.

4.2. Optical microscopy

The black-glaze wares have a light or deep brown matrix. Most of the samples (CUMN 3, 4, 7 and 9) show the presence of crystallitic calcite, which makes the matrix birefringent (crystallitic).⁵¹ Other samples have a birefringent matrix, including CUMN 2, due to the high presence of fine mica crystals, CUMN 8, which includes speckled calcite,⁵² and CUMN 6 with striated calcite.⁵³ Only the CUMN 1 and 5 samples have an isotropic matrix. All samples have low or medium porosity, with an oriented microstructure due to the presence of micas (white and brown). The voids are elongated and parallel to the pottery surface. The inclusions in the skeleton are very fine, with a seriate distribution, composed by minute crystals of quartz and micas (muscovite and subordinate biotite) (pl. IV, 1).

The first group (CUMN 1, 2, 3, 4, 5, 6, and 8) shows an amount of grains of 5-15%, while the second group (CUMN 7 and 9) has a higher amount (15-20%) of grains.

⁵¹ KEMP 1985. Striated b-fabric (birefringent fabric) refers to the optically active portions of small crystals that are different from clay minerals.

⁵² KEMP 1985. Speckled b-fabric (birefringent fabric) refers to the optically active portions of small crystals that are different from clay minerals.

⁵³ MIRTI-DAVIT 2001.

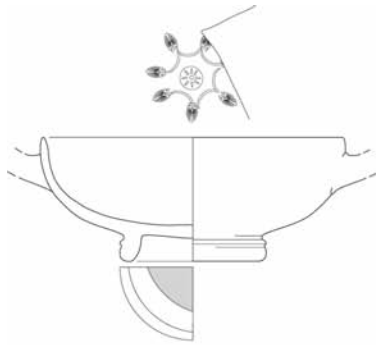

213

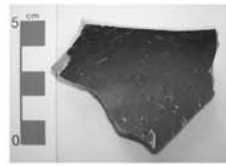

CUMN 2



214

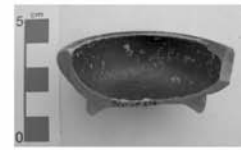

CUMN 8

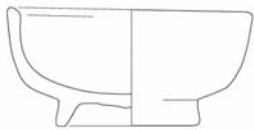

210

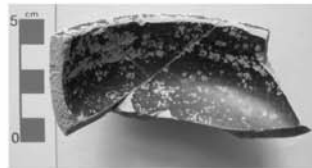

CUMN 9



202



CUMN 3

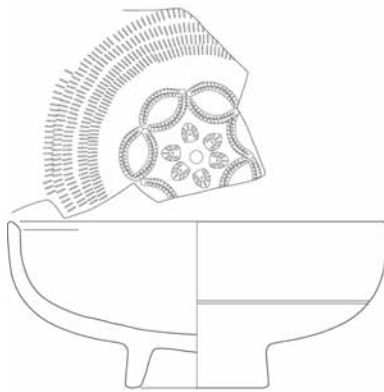

211

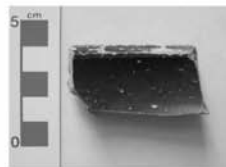

CUMN 5

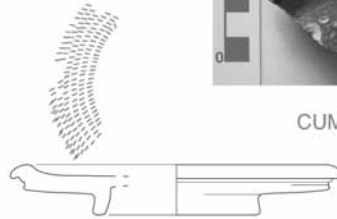

247

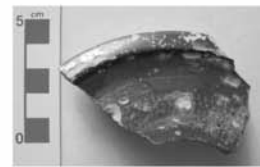

CUMN 1



53



CUMN 4



227

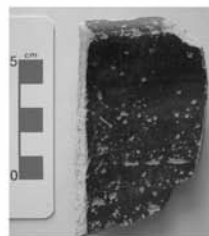

CUMN 7

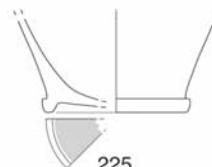

225

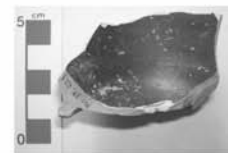

CUMN 6

The two groups contain smaller quantities of alkali feldspar, plagioclase, oxides, and rare clinopyroxene. Volcanic fragments (with plagioclase and clinopyroxene) and ARF (Argillaceous Rock Fragments) are rare. The thin black slip on these fragments is optical birefringent with a variable thickness (10-22 micron).

The four studied fragments of coarse ware show slight differences in their inclusion contents, lower than 10% for the CUMN 18 and 19 samples, lower than 20% for the CUMN 20 sample, and lower than 15% in the CUMN 22 sample. They have a light reddish or yellowish brown matrix, birefringent for the CUMN 18, 20, and 22 samples and with speckled calcite⁵⁴ for the CUMN 19 sample. The inclusions with a seriate distribution are composed by minute crystals of quartz and micas (muscovite and subordinate biotite) (pl. IV, 1). The other observed inclusions are alkali feldspar, plagioclase, clinopyroxene, oxides, and volcanic fragments formed by plagioclase, biotite, and oxides. In the CUMN 20 sample grog and fossil fragments were also observed. The CUMN 20 and 22 samples contain rare obsidian fragments.

4.3. Chemical Analyses

The black-glaze ware and coarse ware (tab. 2) have similar SiO₂, Fe₂O₃, Na₂O, and K₂O contents and slight differences in the chemical range of CaO (8.31-12.9 wt. % in black-glaze ware and 8.32-12.3 wt. % in coarse ware) and Al₂O₃ (15.6-16.9 wt. % in black-glaze ware and 16.4-17.3 wt. % in coarse ware).

In contrast, the chemical composition of the black slips (tab. 2) shows a strong chemical difference from ceramic bodies of black-glaze ware. The slips of black-glaze ware show higher Fe₂O₃ (12.8-16.1 wt. %), Al₂O₃ (28.0-30.6 wt. %) and lower SiO₂ (44.6-47.7 wt. %) and CaO (0.73-1 wt. %) contents than the clay bodies (tab. 2). Their Na₂O contents are similar to those of black-glaze ware. Finally, the high content of K₂O (5.12-6.08 wt. %) with respect to the ceramic bodies (K₂O 2.63-3.26 wt. %) is probably due to the addition of wood ash to the mixture⁵⁵ of slips. These slips could be the result of extensive depuration of a clayey raw material.

The black-glaze ware and coarse ware show little variation in trace element composition (tab. 2). The concentrations of Ba (313-535 ppm), Ni (53-73 ppm), Zr (149-253 ppm), and Sr (281-415 ppm) are similar in all ceramic bodies. Rb and Nb concentrations are slightly lower in the black-glaze ware than in the coarse ware (Rb = 152-172 ppm vs. 171-194 ppm and Nb = 20-30 ppm vs. 29-35 ppm respectively).

Representative binary diagrams are shown in fig. 7, which highlights similarities between black-glaze ware and coarse ware from the suburban sanctuary of Cumae, and the chemical differences between the black-glaze ware and its black slip. These diagrams (fig. 7) compare black-glaze ware (1) (or BGW1) from the same age (Hellenistic age, 4th to 2nd century BC) and pottery of the Archaic age (fine banded ware, Ionian cups, and some black-glaze ware, 7th to 5th century BC) from the Forum of Cumae.⁵⁶

Figure 7 shows the chemical similarity between the black-glaze ware from the suburban sanctuary and that from the Forum of Cumae. It shows that there are some slight differences in oxide content between the Archaic pottery and the black-glaze production (figs. 7, a-b), and higher differences in trace element contents (figs. 7, c-d).

4.4. Mineralogical Analysis

- XRPD

⁵⁴ KEMP 1985. Speckled b-fabric (birefringent fabric) refers to the optically active portions of small crystals that are different from clay minerals.

⁵⁵ MIRTI-DAVIT 2001.

⁵⁶ See the contribution by G. Greco, A. Tomeo, B. Ferrara, V. Guarino *et alii* in this volume.

Semi-quantitative mineralogical compositions of six representative ceramic fragments (CUMN 1, 4, 6, 7, 20, and 22) were carried out using X-ray powder diffraction (XRPD).

Quartz is abundant and occurs in all samples. Feldspar is scarce (except for coarse ware sample CUMN 22, where it is frequent). Sporadic calcite is found in CUMN 4 and 7. This phase was detected only in traces in samples CUMN 6, 7, and 22, whereas it is absent in CUMN 1. Pyroxene is sporadic (CUMN 1, 6, and 22) or in traces (CUMN 4, and 7), whereas it is absent in sample CUMN 20. Newly formed melilite (e.g., gehlenite) has been detected in scarce amounts (CUMN 1, 4, and 6) or as traces (CUMN 7, and 22). Traces of hematite are detectable in five samples (CUMN 1, 4, 6, 7, and 22). Minerals of the illite/muscovite group were detected as traces (CUMN 1, 4, 6, and 7) or in small amounts (CUMN 20, and 22). The presence of newly formed calcium silicates as pyroxene and gehlenite in samples CUMN 1, 4, 6, and 7 suggest a firing temperature higher than 850 °C. In these samples the remaining traces of illite/muscovite indicate an upper limit of approximately 950 °C. Furthermore, the CUMN 22 sample contains these minerals, but in this case the higher amount of illite/muscovite and the presence of only mere traces of gehlenite suggest a lower temperature range (800-900 °C). The sample CUMN 20 could have experienced firing temperatures not higher than 850 °C, due to the presence of illite/muscovite and the absence of newly formed calcium silicates.

7. Representative binary diagrams of major elements (wt. %) and trace elements (ppm) for the analysed ceramic classes and the chemical composition of black slips. The compositional field of BGW 1 (black-glaze ware 1) and the Archaic pottery of the Forum is also reported.

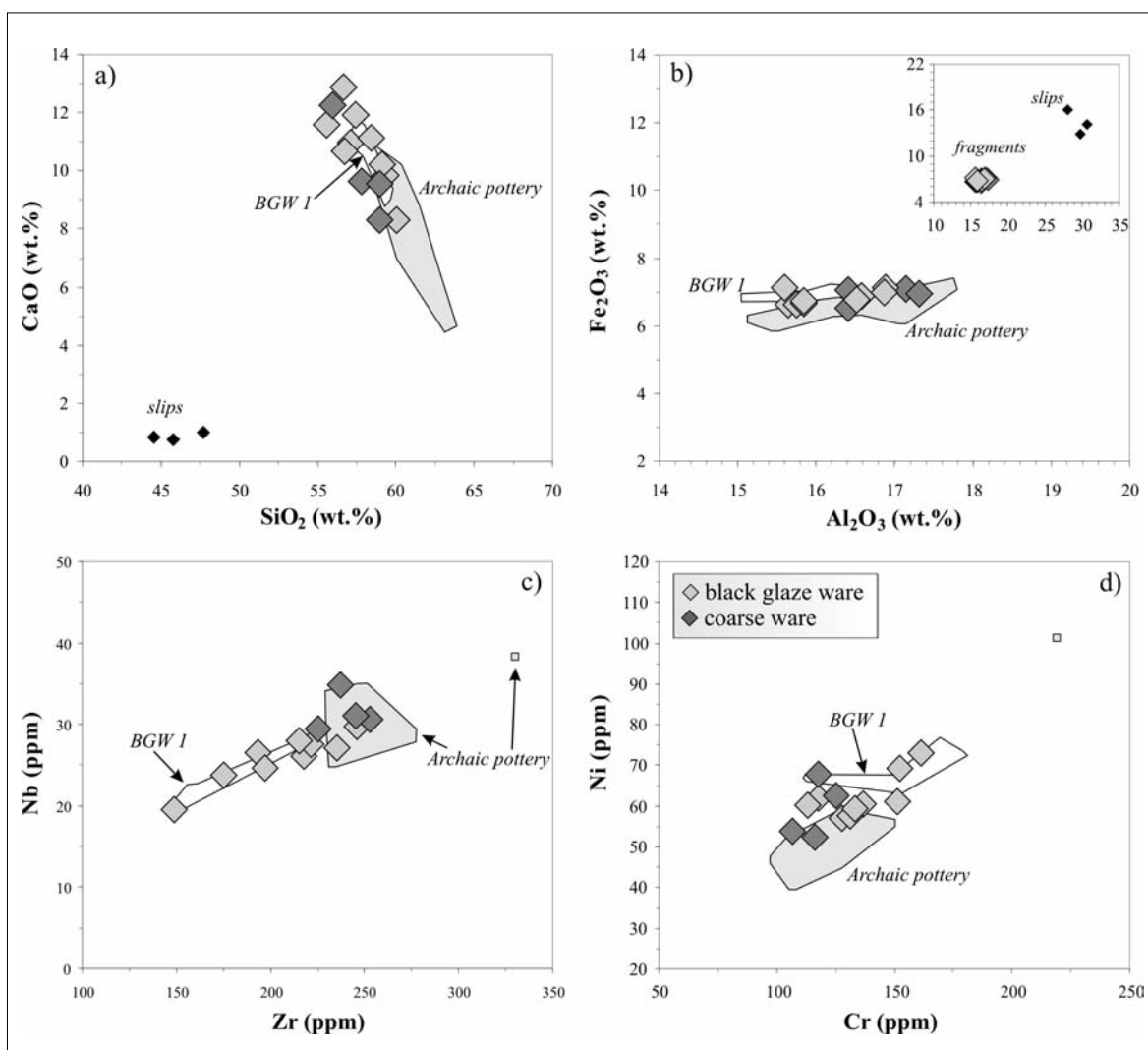

The minerals in black-glaze ware (CUMN 1, 4, and 6) are composed of quartz, alkali feldspar (sanidine), micas (muscovite and phlogopite), rare plagioclase (oligoclase), apatite, and zircon.

The mineral phases analysed in coarse ware (CUMN 20, and 22) are quartz, alkali feldspar (sanidine to anorthoclase), rare plagioclase (andesine to oligoclase), clinopyroxene (diopside), micas (muscovite and phlogopite), apatite, monazite, rutile, zircon; obsidian of trachytic compositions is also observed. Newly formed phase is melilite (as gehlenite and ferri-gehlenite). Minute crystals of garnet (andradite = 93-94 mol%)⁵⁷ are analysed in sample CUMN 22. The secondary phase analysed in the black-glaze ware and tableware is calcite.

Table 1 – Macroscopical features of black glaze ware and common ware of northern suburban sanctuary of Cuma

Sample	Class	Form	Type	Colour	Hardness	Feel	Surface Treatment	Average thickness (mm)	Weight (gr)	Manufacturing
CUMN 1	black-glaze ware	<i>patera</i>	F2222	7.5YR 6/3 - Light Brown	Hard	Smooth	Metallic Black Slip	8	31,17	potter's wheel
CUMN 2	black-glaze ware	<i>kylix</i>	F4241	7.5YR 6/4 - Light Brown	Hard	Smooth	Shiny Black Slip	4	14,93	potter's wheel
CUMN 3	black-glaze ware	small cup	F2423	7.5YR 6/4 - Light Brown	Hard	Smooth	Metallic Black Slip	5	17,29	potter's wheel
CUMN 4	black-glaze ware	cup	F2783	7.5YR 6/6 - Reddish Yellow	Hard	Smooth	Metallic Black Slip with damaged surface	6	44,54	potter's wheel
CUMN 5	black-glaze ware	cup	F2783	7.5YR 6/3 - Light Brown	Hard	Smooth	Metallic Black Slip	5	11,24	potter's wheel
CUMN 6	black-glaze ware	<i>skyphos</i>	F4373	7.5YR 6/4 - Light Brown	Hard	Smooth	Shiny Black Slip, the base is red	5	18,92	potter's wheel
CUMN 7	black-glaze ware	<i>skyphos</i>	F4382	7.5YR 5/6 - Strong Brown	Hard	Smooth	Metallic Black Slip with damaged surface	7	47,46	potter's wheel
CUMN 8	black-glaze ware	small cup	-	7.5YR 6/4 - Light Brown	Hard	Smooth	Shiny Black Slip	4	15,63	potter's wheel
CUMN 9	black-glaze ware	one-handler cup	F6220	7.5YR 6/4 - Light Brown	Hard	Smooth	Metallic Black Slip with damaged surface	5	34,27	potter's wheel
CUMN 18	tableware	closed form	disc foot	7.5YR 6/4 - Light Brown	Hard	Smooth	-	9	125,98	potter's wheel
CUMN 19	tableware	closed form	ring foot	7.5YR 6/4 - Light Brown	Hard	Smooth	-	10	100,14	potter's wheel
CUMN 20	tableware	closed form	flat bottom	7.5YR 6/4 - Light Brown	Hard	Smooth	-	8	55,12	potter's wheel
CUMN 22	tableware	closed form	flat bottom	7.5YR 5/6 - Strong Brown	Hard	Smooth	-	6	25,48	potter's wheel

Table 2 – Representative values for black-glaze ware and its black slips, and for tableware of northern suburban sanctuary of Cumae

	<i>black glaze ware (n=9)</i>				<i>tableware (n=4)</i>				<i>black slips (n=3)</i>			
	min (wt.%)	max (wt.%)	average	dev.st.	min (wt.%)	max (wt.%)	mean	dev.st.	min (wt.%)	max (wt.%)	average	dev.st.
SiO ₂	55,5	60,1	57,8	1,50	56,0	59,0	57,9	1,41	44,6	47,7	46,0	1,57
TiO ₂	0,78	0,82	0,80	0,02	0,78	0,83	0,81	0,02	0,51	1,02	0,69	0,29
Al ₂ O ₃	15,6	16,9	16,2	0,53	16,4	17,3	16,8	0,48	28,0	30,6	29,5	1,32
Fe ₂ O ₃	6,62	7,12	6,84	0,20	6,53	7,10	6,91	0,26	12,8	16,1	14,3	1,64
MnO	0,12	0,20	0,17	0,03	0,13	0,20	0,17	0,03	0,12	0,17	0,14	0,03
MgO	2,92	3,57	3,18	0,21	2,56	3,34	3,05	0,33	1,48	1,84	1,71	0,20
CaO	8,31	12,9	10,8	1,32	8,32	12,3	9,9	1,67	0,73	1,0	0,8	0,14
Na ₂ O	0,76	1,03	0,91	0,11	0,92	1,08	1,01	0,07	0,57	1,35	0,91	0,40
K ₂ O	2,63	3,26	2,96	0,22	2,69	3,59	3,11	0,42	5,12	6,08	5,51	0,50
P ₂ O ₅	0,23	0,40	0,30	0,06	0,22	0,35	0,27	0,06	0,30	0,46	0,36	0,09
	min (ppm)	max (ppm)	average	dev.st.	min (ppm)	max (ppm)	average	dev.st.				
Rb	152	172	163	7,96	171	194	181	9,57				
Sr	281	415	323	49,2	319	367	334	22,3				
Y	30	39	36	3,01	36	41	38	2,45				
Zr	149	246	206	30,3	225	253	240	11,8				
Nb	20	30	26	2,96	29	35	31	2,33				
Ba	313	524	422	60,0	326	535	474	99,5				
Cr	113	161	136	16,2	106	125	116	7,7				
Ni	57	73	62	5,39	53	68	59	7,27				
Sc	16	22	20	1,73	20	24	21	1,80				
V	98	149	120	19,5	92	114	102	9,5				
La	36	55	44	6,35	51	55	53	1,43				
Ce	65	86	81	6,25	88	105	98	7,47				

⁵⁷ LOCOCK 2008.

5. Conclusions

Our archaeometric study of the two ceramic classes (black-glaze ware and coarse ware) from the Northern suburban sanctuary of Cumae (second half of the 4th century BC) has highlighted comparable macro- and microscopic features and mineralogical and chemical compositions.

All the analysed samples from the suburban sanctuary show similar petrographic features to BGW 1 from the Forum⁵⁸ of Cumae, all characterised by a predominance of quartz, followed by micas (muscovite and biotite), alkali feldspar, plagioclase, rare clinopyroxene, and volcanic fragments. Moreover, the studied samples and the BGW 1 sample from the Forum⁵⁹ have similar chemical compositions, so we can hypothesize that the same raw material was used. Their chemical composition is similar to that of Ischia clays,⁶⁰ whose use is also hypothesized for more recent pottery from the same area (Byzantine tableware, 6th to 8th century AD).⁶¹

The trachytic composition of volcanic glasses (obsidians) in the paste of the coarse ware suggests that they may be of Phlegraean origin.⁶² The lack of pottery production indicators (e.g., kilns, wastes, misfired fragments), does not allow us to ascertain whether Cumae was a production site. However, the two ceramics classes show a certain compositional homogeneity connected to the Bay of Naples.

Finally, the archaeological investigation of pottery from the sanctuary of Cumae, along with the widespread distribution of similar objects, suggests the existence of several pottery workshops at Neapolis, Ischia, Cuma, and the surrounding area.

Tab. 1.
Macroscopical features of black-glaze ware and coarse ware of the Northern suburban sanctuary of Cumae.

Tab. 2.
Representative values for black-glaze ware and its black slip, and for tableware of the Northern suburban sanctuary of Cumae.

⁵⁸ See the contribution by G. Greco, A. Tomeo, B. Ferrara, V. Guarino *et alii* in this volume.

⁵⁹ See the contribution by G. Greco, A. Tomeo, B. Ferrara, V. Guarino *et alii* in this volume.

⁶⁰ DE BONIS 2013.

⁶¹ GRIFA *et alii* 2009.

⁶² MORRA 2013.

Bibliography

BATS et alii 2010

M. Bats - J. P. Brun - P. Munzi, *Ai margini della colonia greca di Cuma*, in *Cuma*, Atti del XLVIII Convegno di Studi sulla Magna Grecia, Taranto 2008, Taranto 2010, 525-552.

BENASSAI 2004

R. Benassai, *S. Prisco. La necropoli capuana di IV e III sec. a.C.*, in *Carta archeologica e ricerche in Campania, 2: comuni di Brezza, Capua, San Prisco*, L. Quilici, S. Quilici Gigli (eds.), Roma 2004, 73-229.

BRUN-MUNZI 2011

J. P. Brun - P. Munzi, *Les travaux du Centre Jean Bérard au nord de l'enceinte urbaine et au sud de l'acropole*, in *RA*, 51, 2011, 150-172.

BRUN et alii forthcoming

J. P. Brun - P. Munzi - M. Leguilloux - L. Cavassa, *Banquets rituels à Cumes au IV^e siècle avant J.-C.*, in *Contacts et acculturations en Méditerranée Occidentale. Hommages à Michel Bats*, Actes du Colloque International, Hyères-les-Palmiers 2011, forthcoming.

COOK et alii 1957

J. M. Cook - N. Breitenstein - K. F. Johansen, *CVA, Denmark, Copenhagen, National Museum*, 7, Copenhagen 1957.

DE BENEDITTIS 1992

DE BONIS 2013

A. De Bonis - C. Grifa - G. Cultrone - P. De Vita - A. Langella - V. Morra, *Raw Materials for Archaeological Pottery from the Campania Region of Italy: A Petrophysical Characterization*, in *Geoarchaeology: An International Journal* 28, 2013, 478-503.

DE FILIPPIS 1996

A. De Filippis, *Gli scavi cumani di Emilio Stevens e la Collezione Stevens*, in *I Greci in Occidente, La Magna Grecia nelle collezioni del Museo Archeologico di Napoli*, Napoli 1996, 233-240.

DE FILIPPIS et alii 2013

A. De Filippis - A. Mazzocchi - M. G. Ruggi D'Aragona, *Nota preliminare sulla necropoli in località Piscinola a Lauro di Sessa Aurunca (CE)*, in *OLCESE* 2013, 189-200.

DEWAILLY-MUNZI 2011

M. Dewailly - P. Munzi, *Cuma, un acroterio a disco con maschera di Gorgo. Dal ritrovamento all'ipotetica collocazione, Deliciae fictiles IV*,

Architectural Terracottas in Ancient Italy. Images of Gods, Monsters and Heroes, P. Lulof, C. Rescigno (eds.), Oxford 2011, 322-330.

GABRICI 1913

E. Gabrici, *Cuma*, in *MonAnt*, 22, 1913.

GIAMPAOLA 1985 a

D. Giampaola, *Ponticelli*, in *Napoli Antica* 1985, 302-312.

GIAMPAOLA 1985 b

D. Giampaola, *Qualiano*, in *Napoli Antica* 1985, 317-321.

GIGLIOLI 1922

G. Q. Giglioli, *Ponticelli (Napoli) - Necropoli del III secolo av. Cr. in località Purgatorio*, in *NSc*, 19, 1922, 257-286.

GRIFA et alii 2009

C. Grifa - V. Morra - A. Langella - P. Munzi, *Byzantine Ceramic Productions from Cuma (Campi Flegrei, Napoli)*, in *Archaeometry*, 51, 2009, 75-94.

HOLWERDA 1936

J. H. Holwerda, *Hetlaat-grieksche en romeinschegebruiksaardewerkuithetmiddel-landsche-zee-gebied in het Rijksmuseum van Oudheden*, La Haye 1936.

KEMP 1985

R. A. Kemp, *Soil Micromorphology and the Quaternary*, Quaternary Research Association Technical Guide, 2, Cambridge 1985.

LAMBOGLIA 1952 a

N. Lamboglia, *Apuntes sobre cronología cerámica*, in *Publicaciones del Seminario de Arqueología y Numismática Aragonesas*, 3, 1952, 73-90.

LAMBOGLIA 1952 b

N. Lamboglia, *Per una classificazione preliminare della ceramica campana*, in *Atti del I Congresso Internazionale di Studi Liguri*, Monaco-Bordighera-Genova 1950, Bordighera 1952, 139-206.

LAMBOGLIA 1960

N. Lamboglia, *Polemiche campane*, in *RStLig*, 26, 1960, 292-304.

LISTA 1990

M. Lista, *Contributo alla conoscenza della ceramica a vernice nera di età preromana nell'area Alifana*, in *Il territorio alifano: archeologia, arte, storia*, in L. Di Cosmo, A. M. Villucci (eds.), Atti del Convegno, S. Angelo d'Alife 1987, Minturno 1990, 75-90.

LOCOCK 2008

A. J. Locock, *An Excel Spreadsheet to Recast Analyses of Garnet into End-Member Components, and a Synopsis of the Crystal Chemistry of Natural Silicate Garnets*, in *Computers and Geosciences* 34, 2008, 1769-1780.

MANZINI 2013

I. Manzini, *La ceramica a vernice nera di Teano: nuovi dati sulle caratteristiche della produzione locale*, in *OLCESE* 2013, 201-208.

MINGAZZINI 1930

P. Mingazzini, *Vitulazio (Fraz. di Villa Volturno in Provincia di Napoli) - Tomba del IV secolo av. Cr. e via antica*, in *Nsc*, 6, 1930, 549-552.

MINGAZZINI 1938

P. Mingazzini, *Il santuario della dea Marica alle foci del Garigliano*, in *MonAnt*, 37, 1938, 693-957.

MINGAZZINI 1958

P. Mingazzini, *CVA Capua, Museo Campano*, 3, Roma 1958.

MINIERO et alii 1997

P. Miniero - A. D'Ambrosio - G. Bonifacio - V. Di Giovanni - G. Gasperetti - R. Cantilena, *Il santuario campano in località Privati presso Castellammare di Stabia. Osservazioni preliminari*, in *RStPomp*, 8, 1997, 11-56.

MIRTI-DAVIT 2001

J. Mirti - M. Davit, *Technological Characterization of Campanian Pottery of Type A, B, C and of Regional Products from Ancient Calabria (Southern Italy)*, in *Archaeometry*, 43, 2001, 19-33.

MOREL 1965

J. P. Morel, *La céramique à vernis noir de Pompéi*, in *ReiCretActa*, 7, 1965, 81-103.

MOREL 1981

J. P. Morel, *Céramique campanienne. Les formes*, Rome 1981.

MOREL 1994

J. P. Morel, *Céramique campanienne. Les formes*, 2nd ed., Rome 1994.

MORRA 2013

V. Morra - A. De Bonis - C. Grifa - A. Langella - L. Cavassa - R. Piovesan, *Minero-petrographic Study of Cooking Ware and Pompeian Red Ware (Rosso Pompeiano) from Cuma (Southern Italy)*, *Archaeometry* 55, 2013, 852-879.

Napoli antica 1985

Napoli antica, Catalogo della Mostra, Napoli 1985.

OLCESE 2013

Immensa Aequora, G. Olcese (ed.), Atti del

Workshop, Roma 2013.

ROCCO 1954

A. Rocco, *CVA Napoli, Museo Nazionale*, 3, Roma 1954.

Samnium 1992

Samnium. Archeologia del Molise, S. Capini, A. Di Niro (edd.), Roma 1992.

SERRITELLA 1995

A. Serritella, *Pontecagnano II, 3. Le nuove aree di una necropoli del IV e III secolo a.C.*, Napoli 1995.

SERRITELLA 2013

A. Serritella, *Un nucleo di tombe di armati tra IV e III sec. a.C. a Pontecagnano, Paestum* 2013.

TOMEIO 2008

A. Tomeo, *Doni votivi e suppellettili nel complesso culturale a S/E del Foro di Cuma*, in *Doni agli dei. Il sistema dei doni votivi nei santuari*, in G. Greco, B. Ferrara (eds.), Atti del Seminario, Napoli 2006, Pozzuoli 2008, 49-74.

VAN INGEN 1933

W. van Ingen, *CVA University of Michigan at Ann Arbor*, 1, Cambridge Mass. 1933.

ZEVI et alii 2008

Museo Archeologico dei Campi Flegrei. Catalogo generale. I. Cuma, F. Zevi, F. Demma, E. Nuzzo, C. Rescigno, C. Valeri (eds.), Napoli, 2008.

Image sources

CJB, USR 3133 CNRS-EFR: figs. 1-3, 5.

V. Guarino: fig. 7.

G. Stelo: figs. 4, 6.

