



HAL
open science

On the Integration of a Readout System Dedicated for Neutron Discrimination in Harsh Environment

S. Ben Krit, W. Rahajandraibe, K. Coulie-Castellani, G. Micolau, A. Lyoussi

► **To cite this version:**

S. Ben Krit, W. Rahajandraibe, K. Coulie-Castellani, G. Micolau, A. Lyoussi. On the Integration of a Readout System Dedicated for Neutron Discrimination in Harsh Environment. ISRD 15 - INTERNATIONAL SYMPOSIUM ON REACTOR DOSIMETRY, 2016, Unknown, Unknown Region. 10.1051/epjconf/201610605012 . hal-01434974

HAL Id: hal-01434974

<https://hal.science/hal-01434974v1>

Submitted on 2 Jun 2020

HAL is a multi-disciplinary open access archive for the deposit and dissemination of scientific research documents, whether they are published or not. The documents may come from teaching and research institutions in France or abroad, or from public or private research centers.

L'archive ouverte pluridisciplinaire **HAL**, est destinée au dépôt et à la diffusion de documents scientifiques de niveau recherche, publiés ou non, émanant des établissements d'enseignement et de recherche français ou étrangers, des laboratoires publics ou privés.

On the Integration of a Readout System Dedicated for Neutron Discrimination in Harsh Environment

S. Ben Krit¹, W. Rahajandraibe¹, K. Coulié-Castellani¹, G. Micolau², and A. Lyoussi³

¹ Aix-Marseille University, CNRS, IM2NP UMR 7334, 13451 Marseille, France

² Univeristy of Avignon, UMR 1114 EMMAH (INRA-UAPV), France

³ CEA/DEN/DER/SPE_x, Laboratoire Dosimétrie Capteurs Instrumentation, Bât. 238, CEA Cadarache, 13108 Saint-Paul-Lez-Durance, France

Abstract. New insights related to the integration of a readout system dedicated for the detection and discrimination of neutrons are presented here. This study takes place in the framework of the I_SMART European project. This system will have to work later in a harsh environment in terms of temperature and radiations, what makes not only the development of specifications for operation and reliability of the components necessary but also the investigation of margins for the interplay of the system. Implementation of the analog conditioning chain at transistor level (AMS (Analog/Mixed Signal) 0.35 μ m CMOS technology) is investigated here where electrical performances have been validated at SPICE-level simulations using “Spectre” simulator (SPICE-based) under Cadence DFII.

1. Introduction

Radiation detectors dedicated for safe operation under harsh environments (nuclear reactors) that are based on semi-conductor materials have received considerable attention in recent years due to their compact size and their fast charge collection time in comparison with other types of detectors (gas filled) [1–3]. Crossing a semi-conductor detector (p-n junction for example), a particle delivered by a source of radiation will generate a number of electron-hole pairs proportional to its own energy [4]. Then, electrons drift within the semi-conductor and diffuse towards a collecting anode inducing an output current (single effect) [5] (Fig. 1).

The low amplitude of the output current generated by the sensor necessitates the presence of one or many pulse processing chains in order to amplify the signal and to ensure available information about the incident particle.

The majority of the existing processing chains are providing a direct reading of the input current and are mainly composed by blocks ensuring (i) amplification, based on a charge sensitive amplifier (CSA), (ii) pulse-shaping that is ensured by a pulse shaping amplifier (PSA), (iii) an analog to digital conversion (ADC), which provides a digital data and a (iv) unit for further processing of the digital data (Discrimination by the Multichannel Analyser (MCA)) [6, 7].

This is an Open Access article distributed under the terms of the Creative Commons Attribution License 2.0, which permits unrestricted use, distribution, and reproduction in any medium, provided the original work is properly cited.

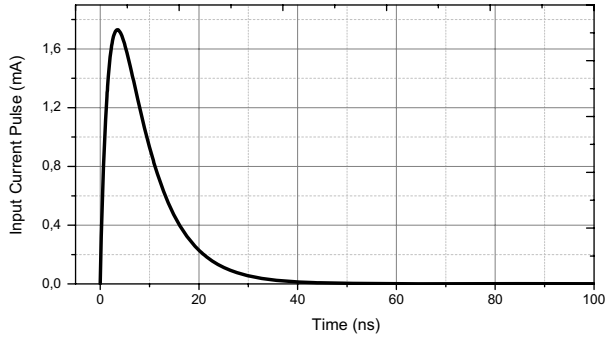

Figure 1. Calculated output current pulse delivered by the sensor versus time [5].

This study takes place in the framework of the I_SMART European project. The final I_SMART system will consist of one or more detectors in silicon carbide (spectroscopic detector, neutron, gamma etc.), processing chains and microprocessor for the signal recognition. The system will have to work later in harsh environments in terms of temperature and radiations. This necessitates the development of specifications for operation and reliability of the components and the investigation of margins for the interplay of the components. In a previous study, first investigations on the feasibility of integration of the system under harsh conditions have been presented [8]. A first prototype (system approach) of the analog processing chain based on a direct reading of the generated currents was characterized and evaluated. First evaluations of the designed system have shown a high sensitivity, high resolution and a good linearity of the response. In this context this work aims to investigate and characterize the analog chain that has been designed at transistor level using AMS 0.35 μm technology. Detailed simulations related to the characteristics of the developed chain are presented here. This detailed prototype will allow us to test the resistance of the chain later under harsh operating conditions and to define the high and low limits of the harsh environment integration.

2. Presentation of the Readout System

The readout system which is used here and which is based on a direct reading of the input current is divided in an analog processing block and a digital processing block (Fig. 2). The analog processing block will provide an analog output voltage; suitable for digital processing. Then, the digital processing block, which is ensured by an analog to digital convertor, a pile up rejector and finally a multi-channel analyzer (MCA) will provide a detailed spectrum related to the deposited energies of the detected particles [8, 9].

2.1 Analog Processing Block

The analog processing chain is composed by a charge sensitive amplifier (CSA) followed by a pulse shaping amplifier (PSA) (Fig. 3).

The CSA will convert the deposited charge on the sensor to an output voltage. The PSA, acting as a bandwidth filter, is added in order to minimize the noise contribution of the CSA and to improve the signal to noise ratio (SNR) in the output of the analog chain [8]. Finally, the output voltage is a semi-Gaussian pulse characterized by a good SNR that will allow a good digital resolution (Fig. 4).

Therefore, the equation used to describe the semi Gaussian pulse forms is [8]:

$$V_{out}(t) = \frac{Q}{C_f} e^{-t/\tau_f} \frac{A^n n^n}{n!} \left(\frac{t}{\tau_p} \right)^n e^{-nt/\tau_p}. \quad (1)$$

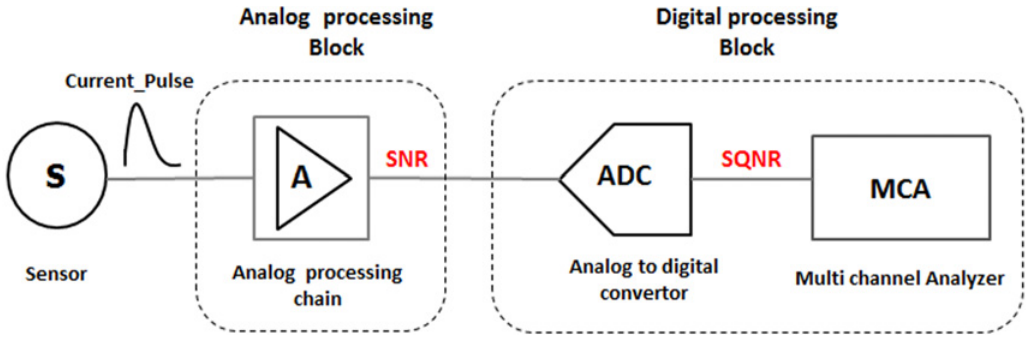

Figure 2. Block diagram of the processing chain.

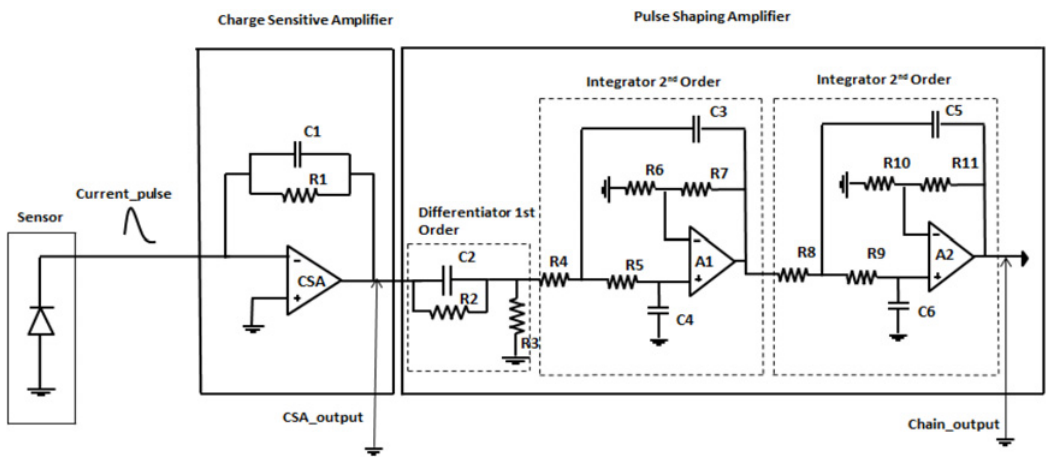

Figure 3. Electrical circuit diagram of the analog signal conditioning (1 channel).

Where Q is the deposited charge in the sensor,
 C_f is the feedback capacitance of the CSA,
 τ_f is the time constant of the CSA,
 A is the DC gain of the integrators of the PSA,
 n is the number of integrators,
 τ_p is the peaking time of the Gaussian pulse.

2.2 Digital Processing Block

Since the principle of discrimination is based here on the detection of height of the semi Gaussian-pulse that contains the information related to the deposited charge (1), the ADC placed at the head of the digital processing chain will have to convert the maximum of the coming pulse on a digital equivalent data.

The used ADC here is a sigma delta convertor. This choice is based on its high resolution and the ease of implementation that can be provided by this type of convertor. Once digital information is provided, further processing can be ensured such as i) the pile up rejection of the overlapped pulses [8] and the ii) discrimination of the remaining particles that is ensured by the multichannel analyzer (MCA).

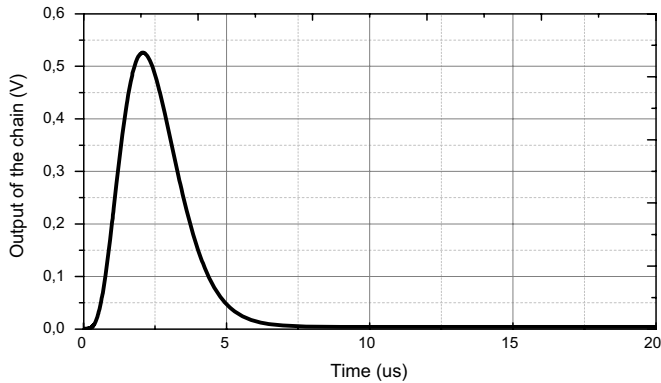

Figure 4. Electrical simulation of the output of the chain versus time for a single injected current pulse.

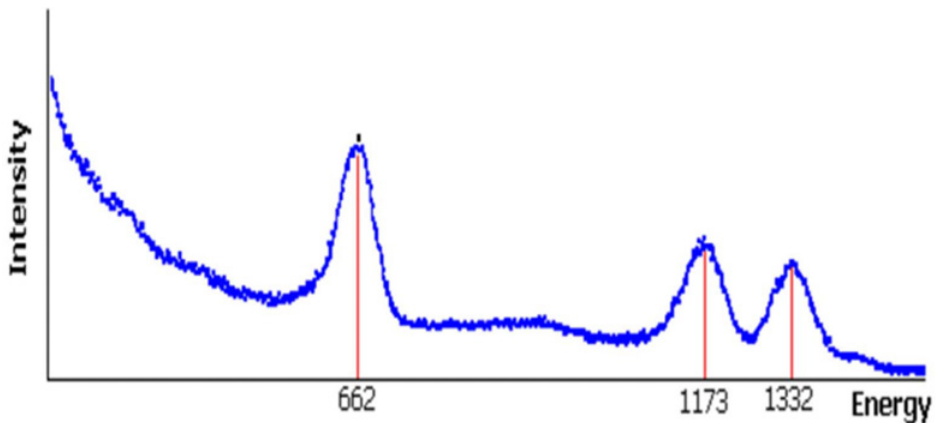

Figure 5. Intensity (number of events) of the detected pulses versus their deposited energies (gamma ray spectrum).

The final output of the readout system will be a detailed spectrum presenting the number of detected events over their deposited energies. An illustration of an output spectrum is presented in Fig. 5.

3. Characterization of the Analog Processing Chain

The analog processing chain is the most important block of the chain since it is responsible for providing an analog output voltage with extremely high linearity, good immunity against PVT (Process, Voltage, and Temperature) variations and low additional noise.

3.1 Linearity of the Chain

The linearity of the system is a very important characteristic of the analog chain since it reflects its ability to identify correctly the incident particle and to provide an output voltage, proportional to the deposited charge. From (1), the relation between the charge and the maximum value of the Gaussian pulse (occurring at $t = \tau_p$) is strictly linear. Thus, a factor of charge voltage conversion, related to the

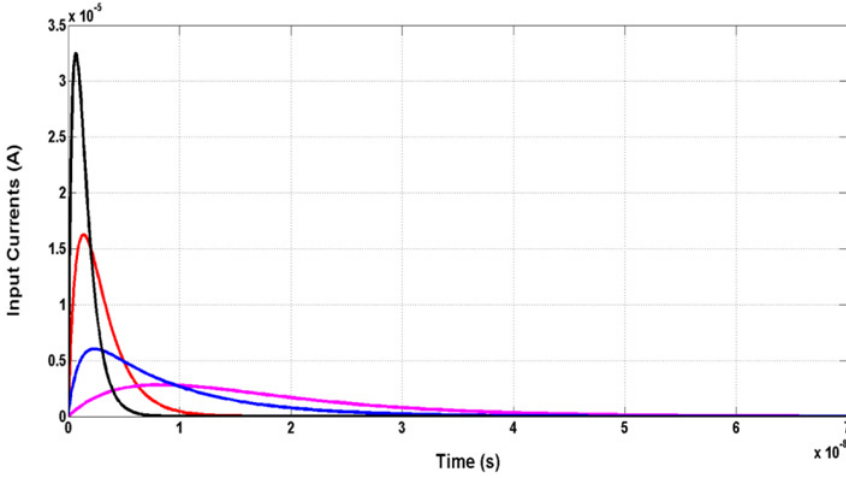

Figure 6. Input currents comprising the same value of charge, the value of the considered charge is about 65 fC.

characteristics of the chain can be defined as follows [8].

$$V_{out}(\tau_p) = \frac{QA^n n^n e^{-\tau_p/\tau_f}}{C_f n! e^n} = QA_{V/Q}. \quad (2)$$

Where $A_{V/Q} = \frac{A^n n^n e^{-\tau_p/\tau_f}}{C_f n! e^n}$ defines the voltage-to-charge conversion of the analog processing chain.

Then, by dividing the maximum of the output voltage by the factor of conversion, the deposited charge can be directly calculated and defined. Thus, from (1), every value of charge (whatever the characteristics of the input currents are) is then related to only one specific Gaussian pulse.

In order to check the ability of the equation to describe the presented chain correctly and the validity the method used for discrimination (the correspondence of the deposited charge to one specific Gaussian pulse), we have generated several currents with the same value of charge but with different forms (different rising and falling times). The simulated currents are presented in Fig. 6 and their corresponding outputs are presented in Fig. 7.

From Fig. 7 we can remark that the outputs of the analog processing chain related to the same value of the deposited charge are approximately identical. However, inspite of the huge similarity between the simulated forms, a little variation can be detected, especially at the maximum of the Gaussian pulses. This variation can be basically due to the noise of the electronic components. In order to define the limits of the used equation, we have defined a rate of variance related to a specific value of charge. This rate presents the average variance of the simulated outputs of the chain (related to the same charge) (Fig. 7) in comparison with the calculated ones described in (1). The values of the rate will be comprised between 0 and 1 where 0 presents the case where the simulated output is identical to the calculated one and 1 presents the case where the two considered outputs are completely different.

This rate was calculated for several values of charge. The results are shown in Fig. 8.

Thus, we remark from this figure (Fig. 8) that the error is increasing with the increase of the deposited charge value. However, the rate of variation is negligible as its highest value is lower than $1.6 \cdot 10^{-4}$. Therefore, from these observations, the used equation has been validated and its use on the charge value calculation is now argued.

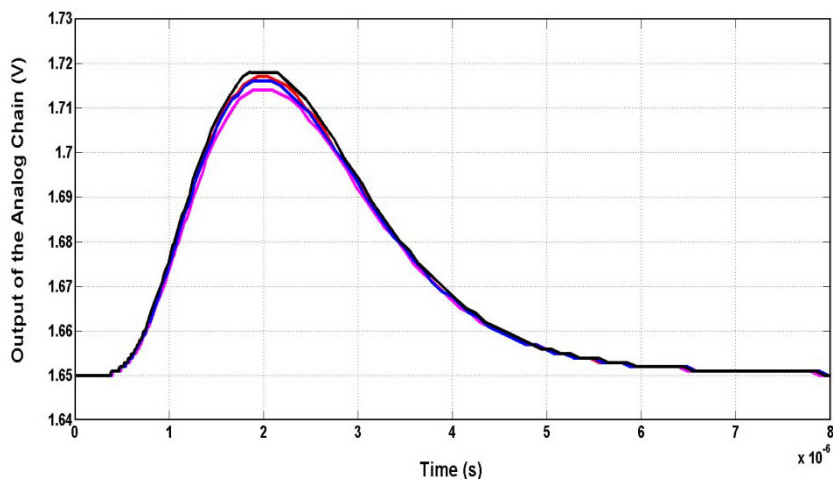

Figure 7. Outputs of the analog processing chain corresponding to the input currents shown in Fig. 6 (the currents have the same charge value (65fC)). Same lines colors are considered for each input current and its corresponding output voltage shape.

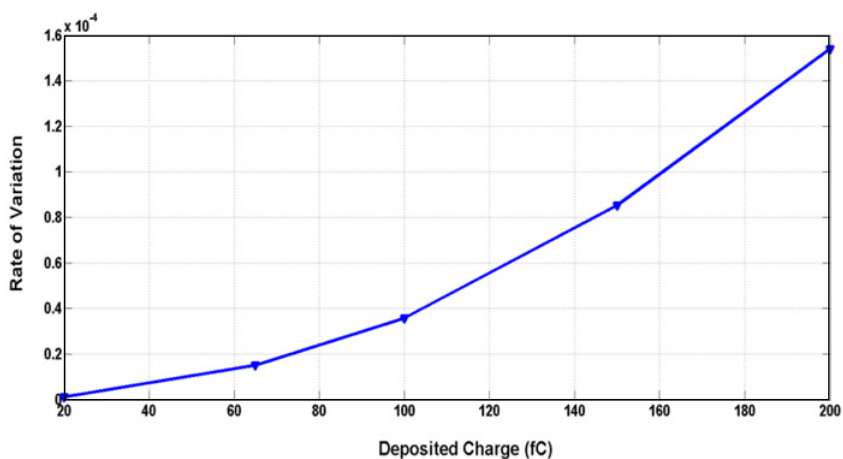

Figure 8. Rate of variance of the output simulated Gaussian pulses in comparison with the calculated ones for different values of deposited charge.

3.2 PVT Variations

Another important issue that has to be tested is the robustness of the analog chain over PVT (P=Process, V=Voltage, and T=Temperature) variations. For the technology used in the design (AMS 0.35 μm CMOS technology), two important corners have to be simulated which present the worst and the best case of operation for the system.

The worst case occurs when the used transistors in the analog chain operate in their worst speed, when the temperature of operation is relatively high (150 $^{\circ}\text{C}$) and when the used supply voltage is about 3V. The best case of operation is done by (P = Best speed, V = 3.6 V, T = -50 $^{\circ}$) and the typical one (normal conditions) is defined by (P = Typical, V = 3.3 V, T = 25 $^{\circ}$).

The outputs of the analog chain for the three considered cases are shown in Fig. 9.

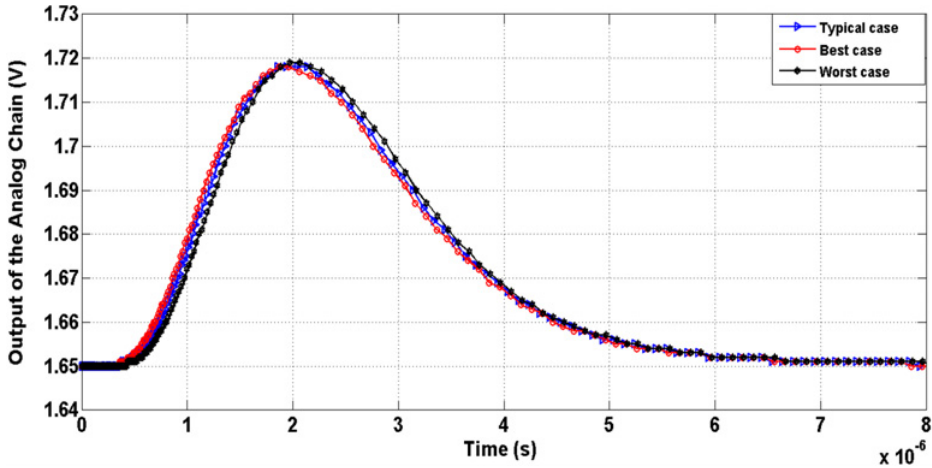

Figure 9. Output of the analog processing chain in the typical case of operation (blue), the best case of operation (red), and the worst case of operation (black).

We can remark from Fig. 9 that the characteristics of the output Gaussian pulse (amplitude, full width at half maximum) have not been obviously degraded for the best and the worst case of operation in comparison with the typical one.

Therefore, from these observations, we can conclude about the robustness of the analog chain that has proved its capacitance to operate normally and to provide a correct output in spite of the PVT variations.

4. Conclusion

The presented work is based on characterization of the analog block of a readout system dedicated for the detection and discrimination of neutrons. The whole system is composed of a sensor, followed by an analog processing chain (amplification + shaping) and a digital processing chain (ADC + MCA).

We have begun by detailing the several blocks comprising the system. Then, we focused on the analog part and especially on the evaluation of the output of the analog processing chain. Two important parameters were characterized which are the linearity of the chain and its robustness against PVT variations. The simulations performed using Cadence have proved a good linearity of the system as well as a high immunity to PVT variations.

As the system will have to work in harsh environments in terms of high temperatures and radiation flux, the perspectives of this work are to design the presented processing chain on CMOS SOI (Silicon On Insulator) technology. The choice of this technology is highly based on its ability to operate under harsh environment constraints.

References

- [1] A.L. Barry, B. Lehmann, D. Fritsch, D. Bräunig, “Energy dependence of electron damage and displacement threshold energy in 6H-SiC”, *IEEE Trans. Nucl. Sci.*, vol. **38**, no. 3, pp. 1111–1115, June, 1991
- [2] F.H. Ruddy, A.R. Dulloo, J.G. Seidel, S. Seshadri, L.B. Rowland, “Development of a silicon carbide radiation detector”, *IEEE Trans. Nucl. Sci.*, vol. **45**, no. 3, pp. 536–541, June, 1998

- [3] S. Seshadri, A. R. Dulloo, F.H. Ruddy, J.G. Seidel, L.B. Rowland, “Demonstration of a SiC Detector for High Radiation Environments”, IEEE Trans. Electron. Dev., vol. **46**, no. 3, pp. 567–571, 1999
- [4] E. Gatti, “The Quest for Low-Loise Processing of Random Signals, Integrated Circuits, and Nuclear Science”, J. Solid-State Circuits, vol. **4**, no. 3, 2012
- [5] K. Castellani-Coulié, H. Aziza, W. Rahajandraibe, G. Micolau, J-M. Portal, “Development of a CMOS Oscillator Concept for Particle Detection and Tracking”, IEEE Trans. Nucl. Sci., vol. **60**, no. 4, pp. 2450–2455, August, 2013
- [6] Vandenbussche et al., “Fully integrated low-power CMOS detector”, IEEE Trans. On Nucl. Sc., vol. **45**, no. 4, August, 1998
- [7] Sven P. Bonisch, “Current and charge sensitive signal conditioning for position determination”, in Semiconductor Radiation Detection Systems, Sidney, 2010
- [8] S. Ben Krit, W. Rahajandraibe, K. Castellani-Coulié, G. Micolau, A. Lyoussi, “First Investgations on the Feasibility of Integration of Smart Sensor in Harsh Environement”, presented at ANNIMA, Marseille, 2013
- [9] S. Ben Krit, W. Rahajandraibe, K. Castellani-Coulié, G. Micolau, A. Levisse, A. Lyoussi, “Development of a Digital Tool for the Simulation of a Readout System Dedicated for Neutrons Discrimination”, presented at LATW conference, Fortaleza, Brazil, 2014