



HAL
open science

Superparamagnetic nanoparticle detection using gradiometer induction sensors for intraoperative localization tumor tool

Kaveh Mohamadabadi, Hervé Simon, Christophe Coillot, Christophe
Goze-Bac, Geneviève Pourroy

► **To cite this version:**

Kaveh Mohamadabadi, Hervé Simon, Christophe Coillot, Christophe Goze-Bac, Geneviève Pourroy. Superparamagnetic nanoparticle detection using gradiometer induction sensors for intraoperative localization tumor tool. EMSA2014, Jul 2014, Vienne, Austria. 2014. hal-01420810

HAL Id: hal-01420810

<https://hal.science/hal-01420810>

Submitted on 21 Dec 2016

HAL is a multi-disciplinary open access archive for the deposit and dissemination of scientific research documents, whether they are published or not. The documents may come from teaching and research institutions in France or abroad, or from public or private research centers.

L'archive ouverte pluridisciplinaire **HAL**, est destinée au dépôt et à la diffusion de documents scientifiques de niveau recherche, publiés ou non, émanant des établissements d'enseignement et de recherche français ou étrangers, des laboratoires publics ou privés.

Superparamagnetic nanoparticle detection using gradiometer induction sensors for intraoperative localization tumor tool.

MOHAMADABADI Kaveh, SIMON Hervé, COILLOT Christophe, GOZE-BAC Christophe, POURROY Geneviève

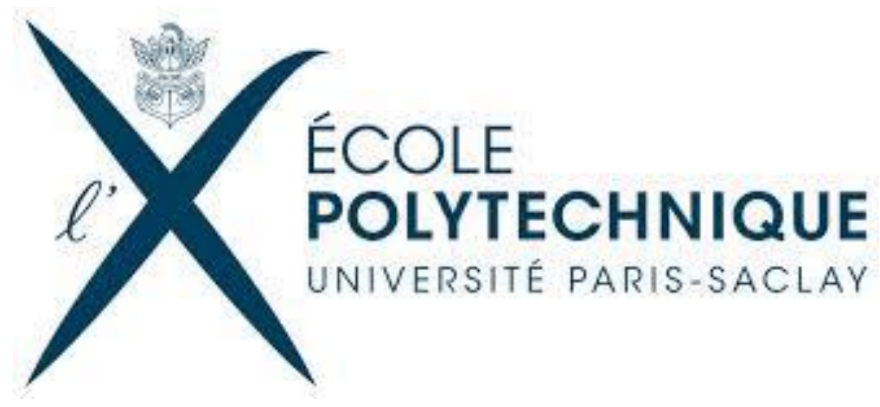

Abstract

Our study concerns nano-objects consisting in an iron oxide core of $10(\pm 2)$ nm or $20(\pm 5)$ nm size, which exhibit superparamagnetic behavior, whose shell is constituted of dendrons carrying a dye. The characterization of the magnetic properties of these nano-objects together with their relaxivity into MRI will be presented in this poster. Their detection in an intraoperative context requires an instrument able to detect the extremely weak magnetic signature of the superparamagnetic nanoparticle in a noisy environment.

A magnetic probe based on an AC magnetic field excitation of the nano-object coupled to an inductive gradiometer sensor has been designed to achieve this measurement. A conductive layer surrounding the probe is used to provide a shielding, thanks to the eddy current which will limit the leakage magnetic field outside of the probe. The principle of the probe and its ability to measure the magnetic signature of the magnetic nano-objects will be discussed.

The sensor consists of two parts: an excitation coil to produce uniform, time-varying magnetic field inside itself and two pickup coils. Both pickup coils are accommodated inside the excitation coil with the specific distance and they are reverse-coupled in series.

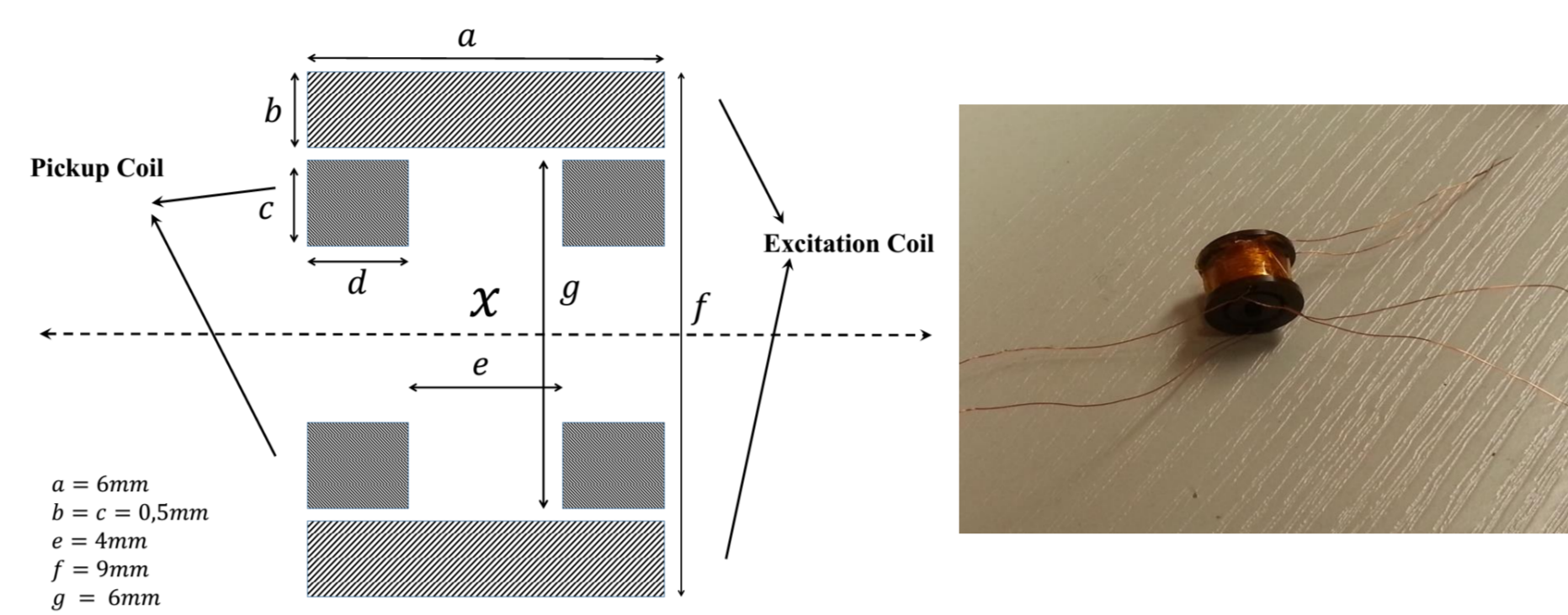

The excitation coil or outer coil has 200 turns in four layers of lacquered copper wire, 0.14 mm in diameter, 6mm in length and 9mm for the inner diameter. Each pickup (inner) coil of the first order gradiometer has also 50 turns in four layers with the identical wire diameter, 2mm in length and 6mm for inner diameter.

Note that here due to the sensor configuration, three coils are magnetically linked together and the mutual inductances are more complex.

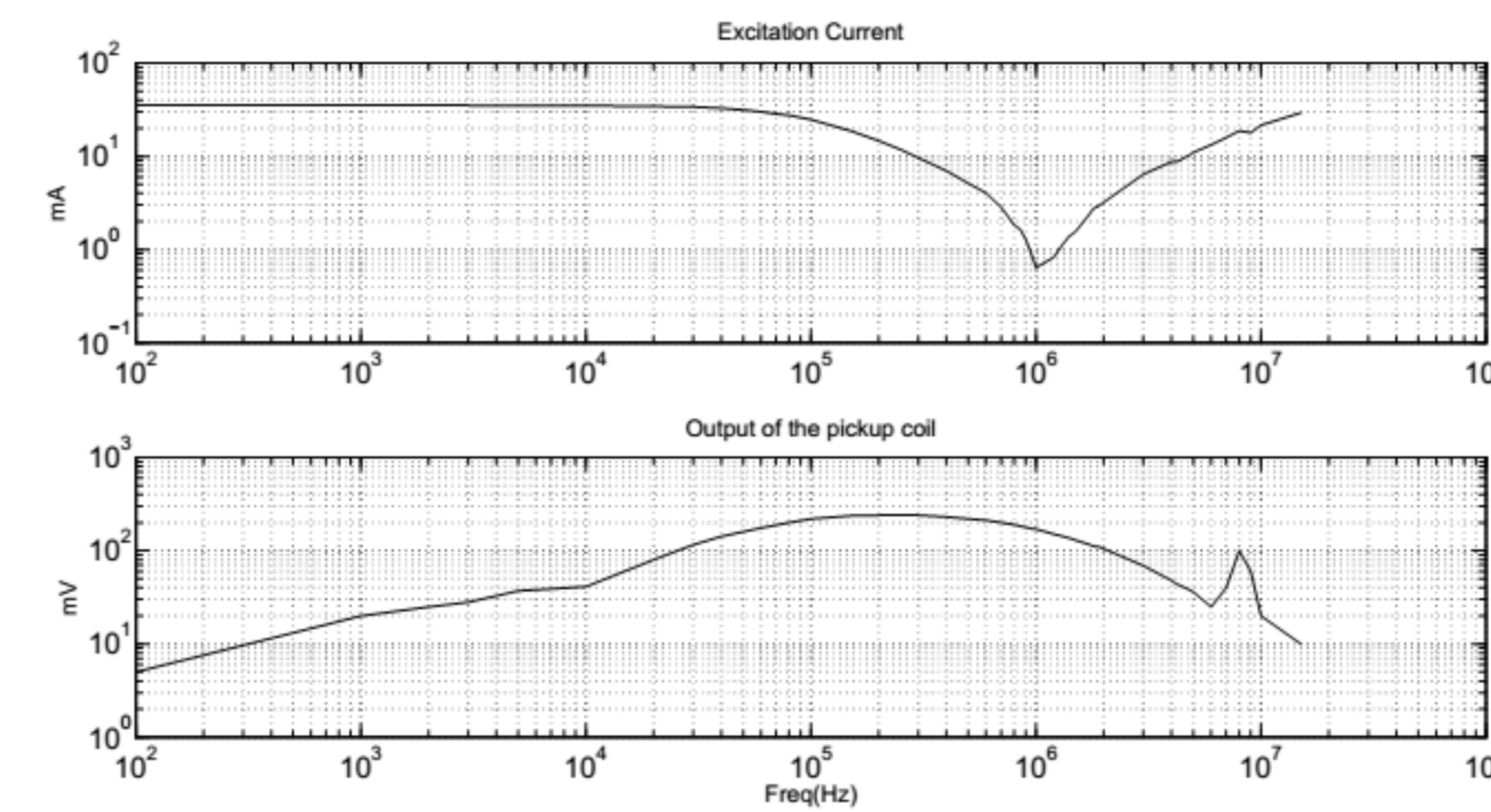

Read-out electronic

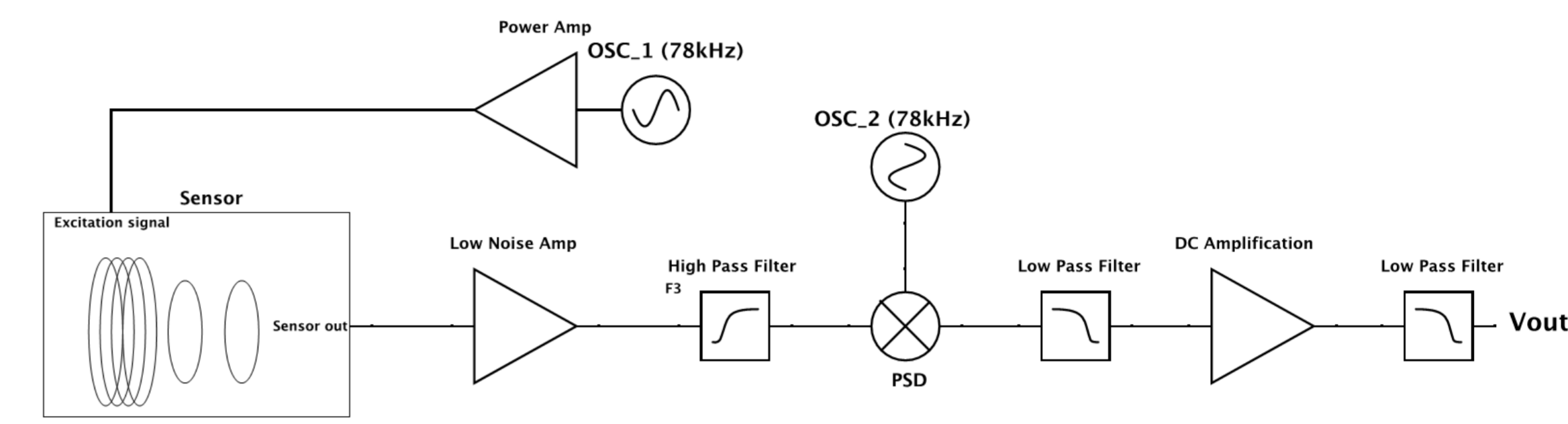

A high pass filter, will act to remove the low frequency signals and the bias on the output of the amplifier stage. Afterward a multiplier which is also known as the phase sensitive detector (PSD) or mixer, multiply the output of the AC amplifier by the external reference signal.

By feeding the PSD output into a low pass filter the AC part of the signal is strongly attenuated. Thus, the output of the lock-in amplifier can be expressed as:

$$V_{out} = \frac{1}{2} g_{ac} g_{dc} V_{sensor} V_m \cos(\varphi_1 - \varphi_2)$$

Equivalent magnetic noise

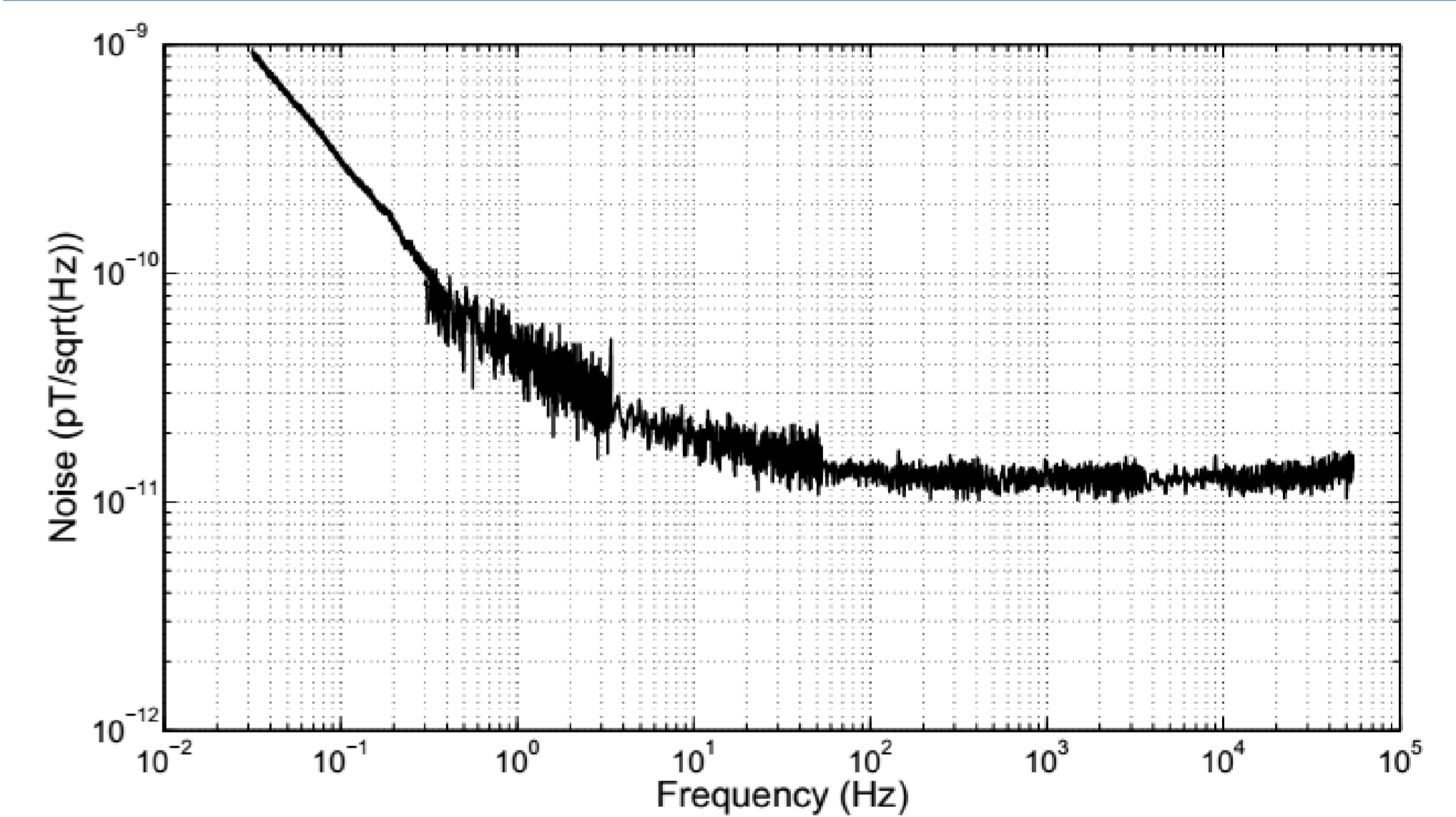

Modeling

Excitation coil:

the excitation coil can be assumed as a finite solenoid. As a result, the magnetic field produced by this coil can be formulated in below:

$$B_f = \frac{\mu_0 n I_f}{2L} \left[\frac{(L/2) + x}{\sqrt{(x + L/2)^2 + (D/2)^2}} + \frac{(L/2) - x}{\sqrt{(x - L/2)^2 + (D/2)^2}} \right] \quad (1)$$

where D , L and n , are the diameter, the length and the turn number of the solenoid respectively. I_f is the current as a function of frequency and x is the distance from the center of the solenoid.

Gradiometer:

Based on the Faraday's law, if the magnetic field lines pass through the pickup coil then the output signal depends on the rate of change of flux density.

$$V = -nA \frac{dB}{dt}$$

Since the nanoparticle has a small size then it can be assumed as a magnetic dipole. This magnetic dipole then can generate the magnetic flux density (B) as follows:

$$B(x) = \frac{\mu_0}{4\pi} \left(\frac{3mx^2}{(x^2 + y^2 + z^2)^{5/2}} - \frac{m}{(x^2 + y^2 + z^2)^{3/2}} \right)$$

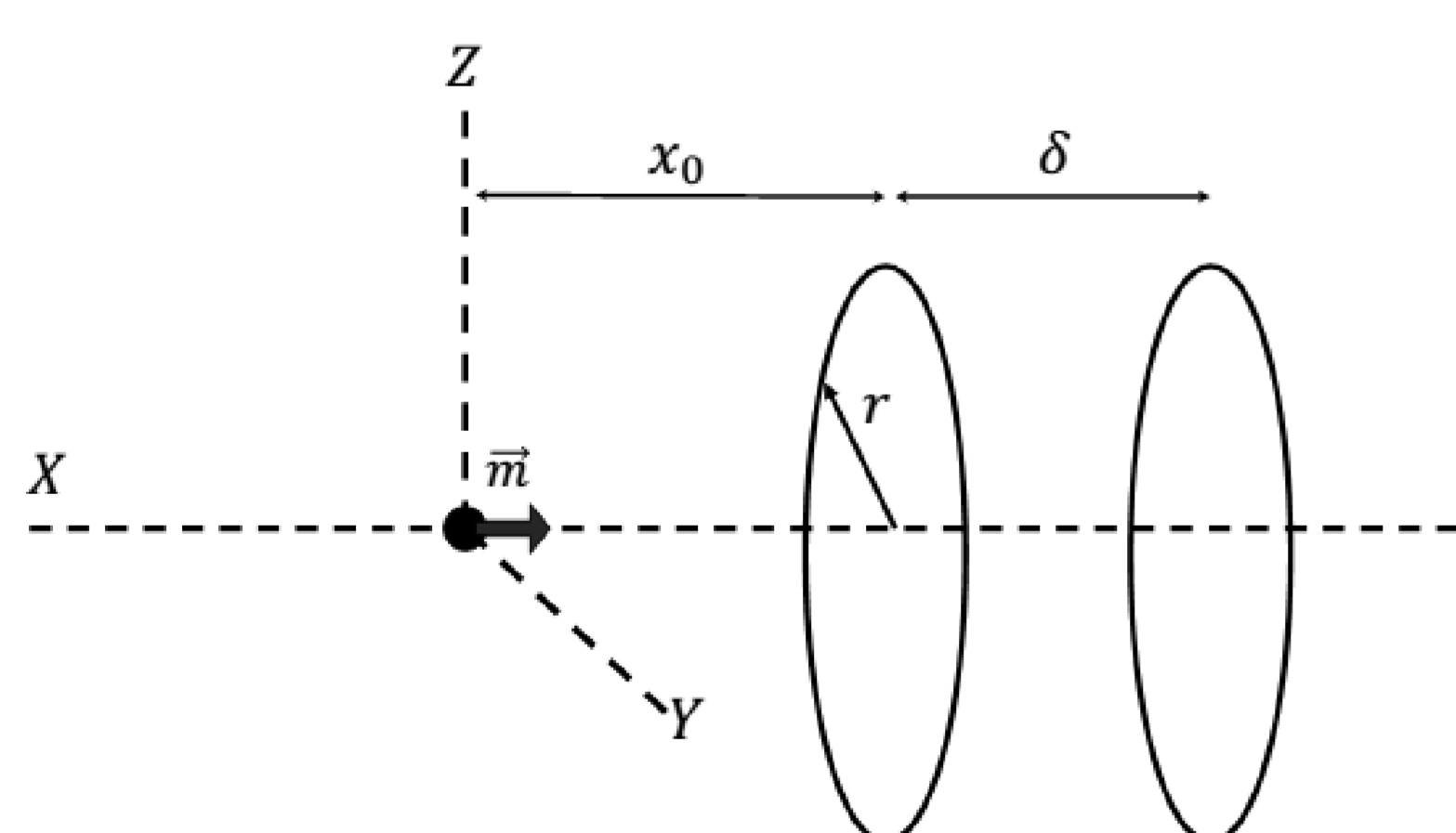

$$\phi = \int_{-r}^r \int_{-r}^r B(x) - B(x + \delta) dy dz$$

Theory of operation

When the ferromagnetic particle has a critical small size, then it can consist of a single uniformly magnetized domain. In other words, it will show the superparamagnetic behavior. In this case, this small enough particle or nanoparticle can be considered as a magnetic dipole. Therefore, the nanoparticle material changes the direction and magnitude of the magnetic field. As a result, this distortion of magnetic field can be used as a criterion to detect the nanoparticle material.

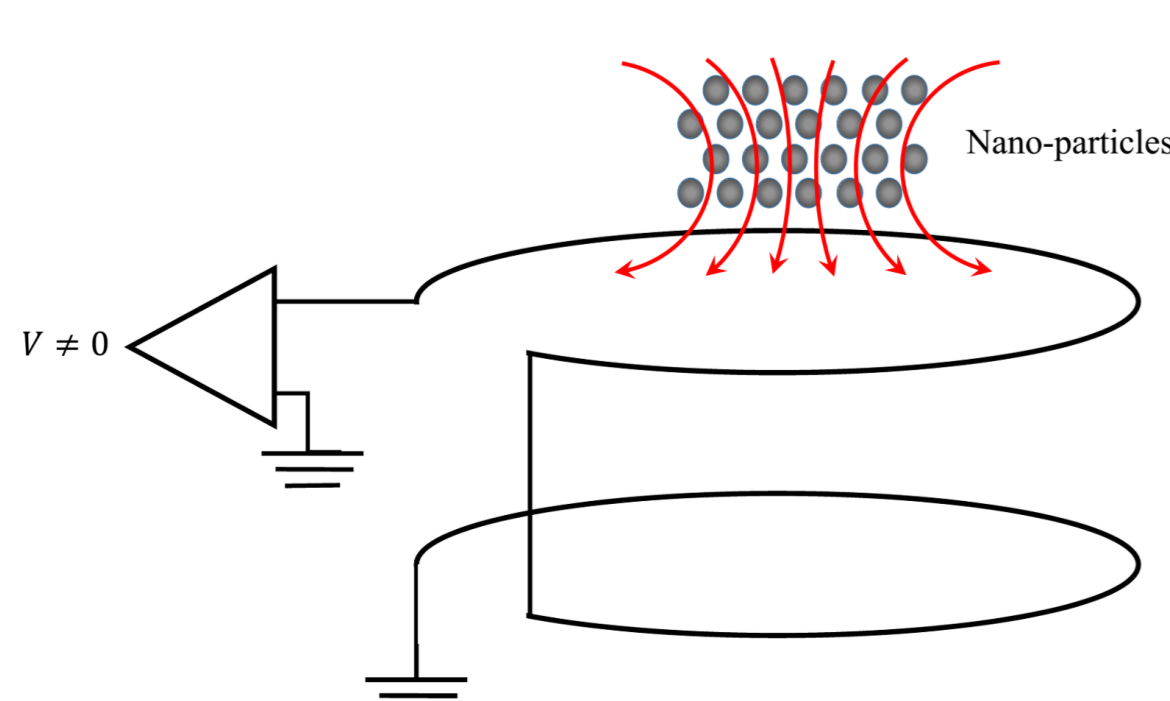

Results

