



HAL
open science

Linear Modeling of a Flexible Substructure Actuated through Piezoelectric Components for Use in Integrated Control/Structure Design

José Alvaro Perez Gonzalez, Thomas Loquen, Daniel Alazard, Christelle Pittet

► **To cite this version:**

José Alvaro Perez Gonzalez, Thomas Loquen, Daniel Alazard, Christelle Pittet. Linear Modeling of a Flexible Substructure Actuated through Piezoelectric Components for Use in Integrated Control/Structure Design. IFAC-PapersOnLine, 2016, vol. 49 (n° 17), pp. 281-6. <10.1016/j.ifacol.2016.09.051>. <hal-01413257>

HAL Id: hal-01413257

<https://hal.science/hal-01413257v1>

Submitted on 9 Dec 2016

HAL is a multi-disciplinary open access archive for the deposit and dissemination of scientific research documents, whether they are published or not. The documents may come from teaching and research institutions in France or abroad, or from public or private research centers.

L'archive ouverte pluridisciplinaire **HAL**, est destinée au dépôt et à la diffusion de documents scientifiques de niveau recherche, publiés ou non, émanant des établissements d'enseignement et de recherche français ou étrangers, des laboratoires publics ou privés.



HAL Authorization



Open Archive TOULOUSE Archive Ouverte (OATAO)

OATAO is an open access repository that collects the work of Toulouse researchers and makes it freely available over the web where possible.

This is an author-deposited version published in: <http://oatao.univ-toulouse.fr/>
Eprints ID: 16569

To link this article: <http://dx.doi.org/10.1016/j.ifacol.2016.09.051>

To cite this version: Perez Gonzalez, José Alvaro and Loquen, Thomas and Alazard, Daniel and Pittet, Christelle *Linear Modeling of a Flexible Substructure Actuated through Piezoelectric Components for Use in Integrated Control/Structure Design*. (2016) IFAC-PapersOnLine, vol. 49 (n° 17). pp. 1-6. ISSN 2405-8963

Any correspondence concerning this service should be sent to the repository administrator: staff-oatao@listes-diff.inp-toulouse.fr

Linear Modeling of a Flexible Substructure Actuated through Piezoelectric Components for Use in Integrated Control/Structure Design

J. Alvaro PEREZ* Thomas LOQUEN**
Daniel ALAZARD*** Christelle PITTET****

* ONERA System Control and Flight Mechanics Department,
Toulouse, 31000 France (e-mail: Jose-Alvaro.Perez_Gonzalez@onera.fr)

** ONERA System Control and Flight Mechanics Department,
Toulouse, 31000 France (e-mail: thomas.loquen@onera.fr)

*** ISAE System Control Department, Toulouse, 31000 France (e-mail: daniel.alazard@isae.fr)

**** CNES AOCS Department, Toulouse, 31000 France (e-mail: christelle.pittet@cnes.fr)

Abstract This study presents a generic TITOP (Two-Input Two-Output Port) model of a substructure actuated with embedded piezoelectric materials as actuators (PEAs), previously modeled with the FE technique. This allows intuitive assembly of actuated flexible substructures in large flexible multi-body systems. The modeling technique is applied to an illustrative example of a flexible beam with bonded piezoelectric strip and vibration attenuation of a chain of flexible beams.

Keywords: Finite Element, Piezoelectric actuators and sensors (PEAs), Multi-body Flexible Structures, Flexible Structures Control, TITOP modeling

1. INTRODUCTION

Piezoelectric actuators and sensors (PEAs) have been widely used in the field of system control design of large flexible structures. However, the design of control systems involving PEAs requires an accurate knowledge of the electro-mechanical behaviour of the system for vibration dynamics, transfers between the inputs and the outputs and non-linear effects such as hysteresis and creep effect. In order to integrate PEAs in the controlled structure, a design procedure including virtual prototyping of piezoelements integrated with the structure needs to be developed.

Macroscopic PEAs models are divided in two main categories. In the first category, the behaviour of a PEAs is decoupled in several contributions such as hysteresis, vibration dynamics and creep based on physical laws. The most well-known model structure of PEAs is the electro-mechanical model proposed in Goldfarb and Celanovic (1997), in which all effects are taken into account. In this category, other models only consider vibration dynamics with Finite Element (FE) models (Piefort and Preumont (2001)) or static behaviour (Smits et al. (1991)). The second category does not decouple the different behaviours of the PEA, all effects are considered simultaneously. However, they are only accurate over small frequency ranges, what seriously limit their usage.

This study presents a PEAs modelisation technique that allows considering piezoelectric actuated flexible substructures

linked with other substructures. Taking advantage of the TITOP modeling technique Perez et al. (2015b); Alazard et al. (2015); Perez et al. (2015a), the method casts in state-space form the FE model of an actuated flexible substructure in order to consider the acceleration-loads transfer within a flexible-multibody system. This supposes an extension of the TITOP modeling technique to piezoelectric materials, completing the available modeling techniques for flexible multibody control. Section 2 introduces the main equations of a piezoelectric FE model. Then, Section 3 explains how to obtain the Two-Input Two-Output Port(TITOP) model through Component Modes Synthesis (CMS) and the double-port approach. Then, an application for a beam with bonded piezoelectric strip is illustrated. Finally, application to vibration attenuation of a chain of flexible beams is performed and conclusions are stated.

2. FINITE ELEMENT MODELING OF A PIEZOELECTRIC COMPONENT

As stated in IEEE and Engineers (1988), the constitutive linear equations of an element piezoelectric material read:

$$\{T\} = [c^E] \{S\} - [e]^T \{E\} \quad (1)$$

$$\{D\} = [e] \{S\} + [\epsilon^S] \{E\} \quad (2)$$

where $\{T\}$ is the stress vector, $\{S\}$ the deformation vector, $\{E\}$ the electric field, $\{D\}$ the electric displacement, $[c]$ the elasticity constants matrix, $[\epsilon]$ the dielectric constants matrix, $[e]$ the piezoelectric constants, with superscripts E , S and T indicating static conditions for E , S and T respectively.

The dynamic equations of a piezoelectric continuum can be discretized in elements and written in the finite element formulation as follows (Piefort and Preumont, 2001):

$$[\mathcal{M}_{qq}] \{\ddot{q}\} + [\mathcal{K}_{qq}] \{q\} + [\mathcal{K}_{q\phi}] \{\phi\} = \{f\} \quad (3)$$

$$[\mathcal{K}_{\phi q}] \{q\} + [\mathcal{K}_{\phi\phi}] \{\phi\} = \{\gamma\} \quad (4)$$

where the element coordinates $\{q\}$, the applied voltage $\{\phi\}$, the electric charge $\{\gamma\}$ and external forces $\{f\}$ are related through the element mass matrix, $[\mathcal{M}_{qq}]$, the element stiffness matrix, $[\mathcal{K}_{qq}]$, the piezoelectric coupling matrix $[\mathcal{K}_{q\phi}]$ and the capacitance matrix $[\mathcal{K}_{\phi\phi}]$. Upon carrying out the assembly of each piezoelectric element, we get the global system of equations:

$$[M_{uu}] \{\ddot{u}\} + [K_{uu}] \{u\} + [K_{uv}] \{v\} = \{F\} \quad (5)$$

$$[K_{vu}] \{u\} + [K_{vv}] \{v\} = \{g\} \quad (6)$$

where the global coordinates $\{u\}$, the global applied voltage $\{v\}$, the electric charge $\{g\}$ and external forces $\{F\}$ are now related through the global mass matrix, $[M_{uu}]$, the global stiffness matrix, $[K_{uu}]$, the piezoelectric coupling matrix $[K_{uv}]$ and the capacitance matrix $[K_{vv}]$.

3. TITOP MODELING OF THE PIEZOELECTRIC COMPONENT

The Two-Input Two-Output Port (TITOP) model is a linear modeling tool developed with the objective of providing fundamental bricks for the modeling and assembly of flexible multibody systems. As demonstrated in Perez et al. (2015b), the TITOP model is as accurate as other accepted methods (the assumed modes method), more robust to variations in boundary conditions and it is applicable in cases of small deformation and large overall motion, as in a two-link flexible arm or a satellite with flexible appendages. In this study, an extension to the case of piezoelectric components is proposed in order to complete the modeling tools. This is done through the application of the Component Modes Synthesis (CMS) transformation to Eqns. (5) and (6), then casting the resulting transformation into a state-space representation for the desired inputs-outputs.

3.1 Component Modes Synthesis Transformation

The Component Modes Synthesis transformation allows separating the different contributions of elastic body displacements into rigid body, redundant boundaries and internal elastic displacements. The resulting equations are easier to manipulate since rigid-body and elastic displacements appear uncoupled in the transformed stiffness matrix. The fundamentals of Component Modes Synthesis were stated by Hurty (1965) in 1965 and then recalled later by Craig Jr (2000), the reader might consult those references if more information about CMS is desired.

The global coordinates $\{u\}$ are then partitioned into three main sets: rigid-body coordinates, r , redundant boundary coordinates, c , and fixed-interface normal modes, n . Applying this division, Eqns. (5) and (6) result:

$$\begin{bmatrix} M_{nn} & M_{nc} & M_{nr} \\ M_{cn} & M_{cc} & M_{cr} \\ M_{rn} & M_{rc} & M_{rr} \end{bmatrix}_{uu} \begin{Bmatrix} \ddot{u}_n \\ \ddot{u}_c \\ \ddot{u}_r \end{Bmatrix} + \begin{bmatrix} K_{nn} & K_{nc} & K_{nr} \\ K_{cn} & K_{cc} & K_{cr} \\ K_{rn} & K_{rc} & K_{rr} \end{bmatrix}_{uu} \begin{Bmatrix} u_n \\ u_c \\ u_r \end{Bmatrix} + \begin{bmatrix} K_{nv} \\ K_{cv} \\ K_{rv} \end{bmatrix} \{v\} = \begin{Bmatrix} F_n \\ F_c + \tilde{F}_c \\ F_r + \tilde{F}_r \end{Bmatrix} \quad (7)$$

$$[K_{vn} \ K_{vc} \ K_{vr}] \begin{Bmatrix} u_n \\ u_c \\ u_r \end{Bmatrix} + [K_{vv}] \{v\} = \{Q\} \quad (8)$$

where $[M]$, $[K]$, $\{u\}$ and $\{F\}$ have been partitioned into their contributions to rigid-body, redundant boundaries and fixed-boundary displacements. The ‘‘tilde’’ load term, \tilde{F}_r and \tilde{F}_c , denotes the force resulting from the connection to adjacent structures at the boundary points.

In CMS, physical displacements can be expressed in terms of generalized coordinates by the Rayleigh-Ritz coordinate transformation Craig Jr (2000):

$$\begin{Bmatrix} u_n \\ u_c \\ u_r \end{Bmatrix} = [\Phi] \begin{Bmatrix} \eta_n \\ \eta_c \\ \eta_r \end{Bmatrix} = \begin{bmatrix} \phi_{nn} & \phi_{nc} & \phi_{nr} \\ 0_{cn} & I_{cc} & \phi_{cr} \\ 0_{rn} & 0_{rc} & I_{rr} \end{bmatrix} \begin{Bmatrix} \eta_n \\ \eta_c \\ \eta_r \end{Bmatrix} \quad (9)$$

where the component-mode matrix $[\Phi]$ is a matrix of preselected component modes including: fixed-constraint modes, n , redundant boundary modes, c , and rigid-body modes, r . Pre-multiplying by $[\Phi]^T$, substituting Eqn. (9) into Eqns. (7) and (8) and considering that neither interior forces nor external forces apply ($F_n = F_c = F_r = 0$), Eqn. (7) yields:

$$\begin{bmatrix} \hat{M}_{nn} & \hat{M}_{nc} & \hat{M}_{nr} \\ \hat{M}_{cn} & \hat{M}_{cc} & \hat{M}_{cr} \\ \hat{M}_{rn} & \hat{M}_{rc} & \hat{M}_{rr} \end{bmatrix}_{\eta\eta} \begin{Bmatrix} \ddot{\eta}_n \\ \ddot{\eta}_c \\ \ddot{\eta}_r \end{Bmatrix} + \begin{bmatrix} \hat{K}_{nn} & 0_{nc} & 0_{nr} \\ 0_{cn} & \hat{K}_{cc} & 0_{cr} \\ 0_{rn} & 0_{rc} & 0_{rr} \end{bmatrix}_{\eta\eta} \begin{Bmatrix} \eta_n \\ \eta_c \\ \eta_r \end{Bmatrix} + \begin{bmatrix} \hat{K}_{nv} \\ \hat{K}_{cv} \\ \hat{K}_{rv} \end{bmatrix} \{v\} = \begin{Bmatrix} 0 \\ \tilde{F}_c \\ \tilde{F}_r + \phi_{cr}^T \tilde{F}_c \end{Bmatrix} \quad (10)$$

$$[\hat{K}_{nv} \ \hat{K}_{cv} \ \hat{K}_{rv}] \begin{Bmatrix} \eta_n \\ \eta_c \\ \eta_r \end{Bmatrix} + [K_{vv}] \{v\} = \{G\} \quad (11)$$

with the new coupling matrix coefficients:

$$\hat{K}_{nv} = \phi_{nn} K_{nv} \quad (12)$$

$$\hat{K}_{cv} = K_{cv} + \phi_{cn} K_{nv} \quad (13)$$

$$\hat{K}_{rv} = K_{rv} + \phi_{rc} K_{cv} + \phi_{rn} K_{nv} \quad (14)$$

Equations (10) and (11) are the most generalized expression for a FE model of a piezoelectric component transformed through the CMS method. Section 3.2 will show how to take advantage of this form in order to simply model an accurate piezoelectric component for control of flexible multi-body systems.

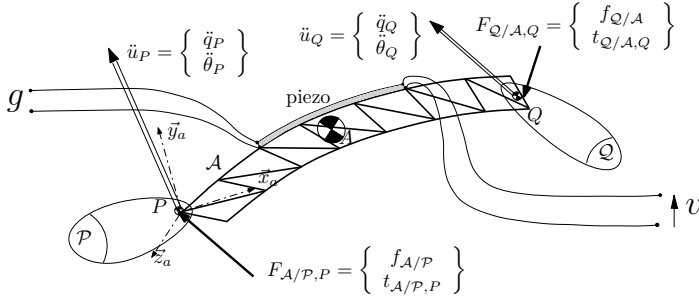

Figure 1. Illustration of a generic substructure with bonded piezoelectric material

3.2 Actuated TITOP State-Space Realization

The purpose of a TITOP state-space realization (Perez et al., 2015b) of Eqns. (10) and (11) is to model the piezoelectric component as a substructure connected with two different structures in chain-like assembly through two connection points, P and Q . This is useful in order to consider the actuation provoked by the piezoelectric component to the rest of the structure, modeled as a flexible multibody system.

As shown in Fig. 1, the flexible piezoelectric component \mathcal{A} is linked to the parent structure \mathcal{P} at the point P and to a child substructure \mathcal{Q} at the point Q . It is assumed that the only external loads applied to \mathcal{A} are the interactions with \mathcal{P} at point P and with \mathcal{Q} at point Q , as hypothesis on Eqn. (10) states. Voltage v can be applied to the piezo in order to provoke a electric field, and the electric charge g is an available measure.

The main problem is how to consider the electro-mechanical coupling between \mathcal{P} , \mathcal{A} , \mathcal{Q} and electric states. The mechanical overlapping between substructures is expressed as an acceleration-load transfer through the common boundaries, called the **double-port approach**, proposed by Alazard et al. (2015) and Perez et al. (2015a). With this approach, both points, P and Q , suffer an acceleration-load transfer, in such a way that the acceleration is transferred to the next substructure in the chain (\mathcal{Q} in this case) and the load is transmitted to the previous substructure in the chain (the parent \mathcal{P} structure).

A generalization of the double-port approach is presented in this study for the piezoelectric FE CMS transformation. The existing electro-mechanical coupling between loads-accelerations and voltage-charge is considered through the augmentation of the classic double-port model with an additional electric input, the applied voltage v , and with an additional output, the electric charge, g , such that:

$$\begin{Bmatrix} \ddot{u}_Q \\ F_{A/P,P} \\ g \end{Bmatrix} = [G_{P,Q}^A(s)] \begin{Bmatrix} F_{Q/A,Q} \\ \ddot{u}_P \\ v \end{Bmatrix} \quad (15)$$

Therefore Eqn. (15) relates the accelerations suffered at connection point P , loads at connection point Q and the applied voltage v to the acceleration at connection point Q , transmitted force to the previous substructure \mathcal{P} and the measured electric charge g . An assignment of the different degrees of freedom is performed in order to distribute the acceleration-load transfer: rigid-body displacements are those of connection point P and the redundant constraint

displacements those of connection point Q . Thus the accelerations read:

$$\begin{aligned} \ddot{u}_P &= \ddot{\eta}_r \\ \ddot{u}_Q &= \ddot{\eta}_c + \phi_{cr} \ddot{\eta}_r \end{aligned} \quad (16)$$

Equation (16) implies that the rigid motion is supported by point P and the constrained motion of connection point Q is a result of the rigid body motion in P transported to point Q ($\phi_{cr} \ddot{\eta}_r$) plus the constrained motion due to flexibility ($\ddot{\eta}_c$).

In the same way, loads are received and transmitted by appendage \mathcal{A} with the following directions:

$$\begin{aligned} F_{A/P,P} &= -\tilde{F}_r \\ F_{Q/A,Q} &= \tilde{F}_c \end{aligned} \quad (17)$$

Using the relations given in Eqns. (16) and (17) in combination with Eqn. (10), a state-space representation can be obtained for the piezoelectric component \mathcal{A} :

$$G_{P,Q}^A(s) \begin{cases} \begin{Bmatrix} \dot{\eta}_n \\ \dot{\eta}_c \\ \dot{\eta}_n \\ \dot{\eta}_c \end{Bmatrix} = A \begin{Bmatrix} \eta_n \\ \eta_c \\ \dot{\eta}_n \\ \dot{\eta}_c \end{Bmatrix} + B \begin{Bmatrix} F_{Q/A,Q} \\ \ddot{u}_P \\ v \end{Bmatrix} \\ \begin{Bmatrix} \ddot{u}_Q \\ F_{A/P,P} \\ g \end{Bmatrix} = C \begin{Bmatrix} \eta_n \\ \eta_c \\ \dot{\eta}_n \\ \dot{\eta}_c \end{Bmatrix} + (D + D_\delta) \begin{Bmatrix} F_{Q/A,Q} \\ \ddot{u}_P \\ v \end{Bmatrix} \end{cases} \quad (18)$$

where A , B , C , D and D_δ are the short hand notation of the following state-space matrices:

$$A = \begin{bmatrix} 0_{n+c} & I_{n+c} \\ -\hat{M}_Q^{-1} \hat{K}_Q & -\hat{M}_Q^{-1} \hat{D}_Q \end{bmatrix} \quad (19)$$

$$B = \begin{bmatrix} 0_{n+c,c+r+v} \\ \hat{M}_Q^{-1} \begin{bmatrix} 0_{nc} & -\hat{M}_{nr} & -\hat{K}_{nv} \\ I_{cc} & -\hat{M}_{cr} & -\hat{K}_{cv} \end{bmatrix} \end{bmatrix} \quad (20)$$

$$C = \begin{bmatrix} [0_{cn} & I_{cc}] [-\hat{M}_Q^{-1} \hat{K}_Q & -\hat{M}_Q^{-1} \hat{D}_Q] \\ [\hat{M}_{rn} & \hat{M}_{rc}] [\hat{M}_Q^{-1} \hat{K}_Q & \hat{M}_Q^{-1} \hat{D}_Q] \\ [\hat{K}_{vn} & \hat{K}_{vc}] [I_{n+c,n+c} & 0_{n+c,n+c}] \end{bmatrix} \quad (21)$$

$$D = \begin{bmatrix} [0_{cn} & I_{cc}] \hat{M}_Q^{-1} \begin{bmatrix} 0_{nc} & -\hat{M}_{nr} & -\hat{K}_{nv} \\ I_{cc} & -\hat{M}_{cr} & -\hat{K}_{cv} \end{bmatrix} \\ [\hat{M}_{rn} & \hat{M}_{rc}] \hat{M}_Q^{-1} \begin{bmatrix} 0_{nc} & -\hat{M}_{nr} & -\hat{K}_{nv} \\ I_{cc} & -\hat{M}_{cr} & -\hat{K}_{cv} \end{bmatrix} \\ 0_{vc} & 0_{vr} & K_{vv} \end{bmatrix} \quad (22)$$

with

$$\begin{aligned} \hat{M}_Q &= \begin{bmatrix} \hat{M}_{nn} & \hat{M}_{nc} \\ \hat{M}_{cn} & \hat{M}_{cc} \end{bmatrix}; \hat{K}_Q = \begin{bmatrix} \hat{K}_{nn} & 0_{nc} \\ 0_{cn} & \hat{K}_{cc} \end{bmatrix}; \\ \hat{D}_Q &= \begin{bmatrix} \hat{D}_{nn} & 0_{nc} \\ 0_{cn} & \hat{D}_{cc} \end{bmatrix}; D_\delta = \begin{bmatrix} 0_{cc} & \phi_{cr} & 0_{cv} \\ -\phi_{cr}^T & \hat{M}_{rr} & \hat{K}_{rv} \\ 0_{vc} & 0_{vr} & 0_{vv} \end{bmatrix}; \end{aligned} \quad (23)$$

Equation (18) with Eqns. (19), (20), (21), (22) and (23) form the double-port model, $[G_{P,Q}^A(s)]$, of the flexible piezoelectric component \mathcal{A} in chain-like assembly, called **actuated Two-Input Two-Output Port (TITOP)** model. This model allows to interconnect different flexible

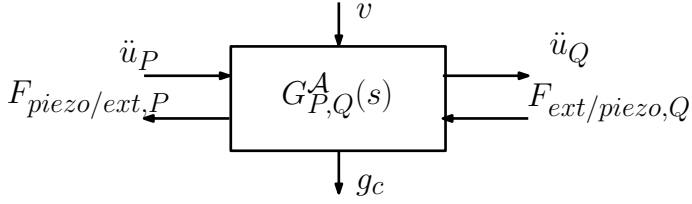

Figure 2. Block diagram of TITOP modeling of a substructure actuated with piezoelectric materials

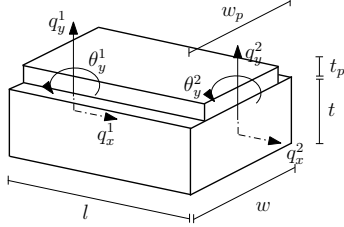

Figure 3. Beam element with bonded piezoelectric strap

substructures in chain-like assembly taking into account flexible motions. A simplified scheme of the TITOP model is shown in Fig. 2. In the 6 degrees of freedom case with one piezoelectric strip, $[G_{P,Q}^A(s)]$, of the flexible substructure \mathcal{A} is a 13×13 transfer matrix (that is, $r = 6$, $v = 1$, $c = 6$, $g = 1$). It should be noticed that the measured charge is denoted g_c and not g because only relative displacement between connection point P and connection point Q is measured for the sake of input/output simplicity.

The physical interpretation of Eqn. (18) is as follows. The rigid-body displacements of the appendage \mathcal{A} are transmitted by its connection point P through the whole of the appendage, and this excites the fixed-boundary natural modes (the modes obtained when clamping the appendage at point P and Q) through the modal participation matrices, $[\hat{M}_{rn}]$ and $[\hat{M}_{rc}]$, and thus the constraint point Q . These natural modes produce a load transmitted to substructure \mathcal{P} modifying the load that appendage \mathcal{A} will induce to \mathcal{P} , which depends on the load received at point Q , $F_{Q/\mathcal{A},P}$, the acceleration received at point P , $\{\ddot{u}_P\}$ and the natural modes. In addition, voltage v modifies these transfers by increasing or reducing the transferred loads at P and Q , and the measured electric charge g_c responds to displacements changes either by mechanical interaction (through load application) or by electric field application (voltage).

4. MODELING APPLICATION

As an illustrative example, let consider a beam linking two substructures at both ends with a piezoelectric strip which has been appropriately bonded to one side, as seen in Fig. 3. The thickness of the piezoelectric strip is t_p , with a width denoted by w_p , Young's modulus E_p , density ρ_p and cross-section inertia I_p . The piezoelectric strip is used as an actuator by controlling the voltage v applied to the electrodes creating a constant electric field $E_3 = v/t_p$ across the thickness of the laminate.

The beam is modeled with a classic FE decomposition in several beam elements of length l . The beam has the same geometrical properties as the piezoelectric strip but denoted without the p subindex: t, w, E, ρ and I . Since the

piezoelectric laminate is glued to the beam, the mass and stiffness matrices of a beam element can be obtained as a sum of the contributions of the beam and the piezoelectric material. Thus:

$$[\mathcal{M}_{qq}] = [\mathcal{M}_{qq}]_{beam} + [\mathcal{M}_{qq}]_{piezo} \quad (24)$$

$$[\mathcal{K}_{qq}] = [\mathcal{K}_{qq}]_{beam} + [\mathcal{K}_{qq}]_{piezo} \quad (25)$$

The matrices of Eqns. (24) and (25) are detailed in Appendix A, obtained with classical FE decomposition with beam elements. With further FE decomposition to the piezoelectric strip, the following coupling matrix and capacitance matrix are obtained:

$$[\mathcal{K}_{qv}] = \begin{bmatrix} -d_{31}E_p w_p & \\ 0 & \\ -d_{31}E_p w_p(t + \frac{t_p}{2}) & \\ d_{31}E_p w_p & \\ 0 & \\ d_{31}E_p w_p(t + \frac{t_p}{2}) & \end{bmatrix} \quad (26)$$

$$[\mathcal{K}_{vv}] = \frac{w_p l}{t_p} (\epsilon_{33}^T - d_{31}^2 E_p) \quad (27)$$

where d_{31} is the piezoelectric constant under constant stress which relates the shrinkage observed in the direction 1 when an electric field E_3 is applied along the direction of polarization 3. The coefficient ϵ_{33}^T is the dielectric constant of the material.

The global mass, stiffness, coupling and capacitance matrices are obtained by appending the elements matrices along the diagonal. Common node points between two points are simply added together. As an example the casting of stiffness matrices is given bellow for a 2×2 case:

$$[\mathcal{K}_{qq}]^1 = \begin{bmatrix} k_{11}^1 & k_{12}^1 \\ k_{21}^1 & k_{22}^1 \end{bmatrix}; \quad [\mathcal{K}_{qq}]^2 = \begin{bmatrix} k_{11}^2 & k_{12}^2 \\ k_{21}^2 & k_{22}^2 \end{bmatrix} \rightarrow \quad (28)$$

$$\rightarrow [K_{uu}] = \begin{bmatrix} k_{11}^1 & k_{12}^1 & 0 \\ k_{21}^1 & k_{22}^1 + k_{11}^2 & k_{12}^2 \\ 0 & k_{21}^2 & k_{22}^2 \end{bmatrix}$$

Obtaining the global piezoelectric coupling matrix is more complicated since it depends on the desired profile of voltages for the piezoelectric strips. If the same voltage is applied among all the strips then the assembly is straightforward:

$$[\mathcal{K}_{qv}]^1 = \begin{bmatrix} k_{1v}^1 \\ k_{2v}^1 \end{bmatrix}; \quad [\mathcal{K}_{qv}]^2 = \begin{bmatrix} k_{1v}^2 \\ k_{2v}^2 \end{bmatrix} \rightarrow [K_{uv}] = \begin{bmatrix} k_{1v}^1 \\ k_{2v}^1 + k_{1v}^2 \\ k_{2v}^2 \end{bmatrix} \quad (29)$$

$$[\mathcal{K}_{vv}]^1 = [k_{vv}^1]; \quad [\mathcal{K}_{vv}]^2 = [k_{vv}^2] \rightarrow [K_{vv}] = [k_{vv}^1 + k_{vv}^2] \quad (30)$$

After FE assembly, the complete FE model of the beam with bonded piezoelectric material is obtained. CMS is applied to the FE model as seen in Section 3.1 and the TITOP model is obtained following the indications in Section 3.2. Figures 4 and 5 show the frequency response of a beam with piezoelectric strip discretised in 3 elements and properties extracted from the data of Table B.1. The first resonant frequency appears at 68 Hz, fast enough for the majority of large flexible systems.

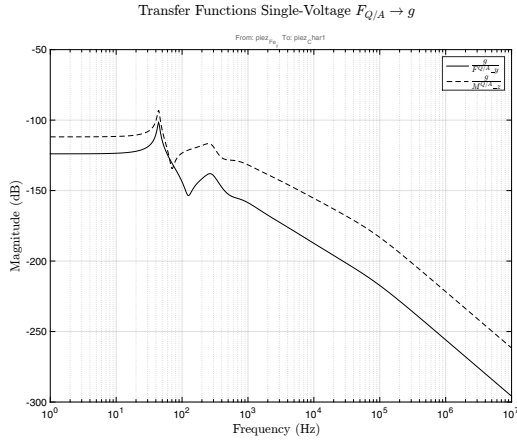

Figure 4. Transfer functions between applied loads at Q (vertical force in solid line, torque in dashed line) and measured electric charge

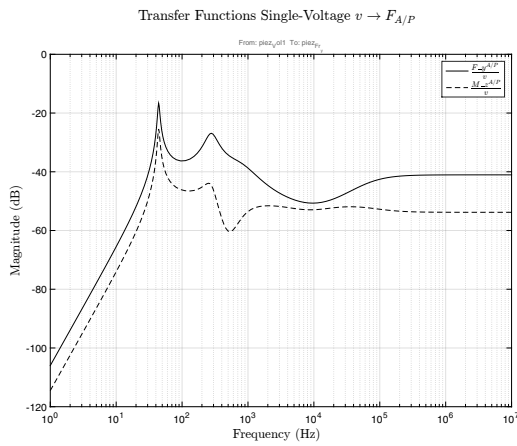

Figure 5. Transfer functions between applied voltage and loads transmitted at P (vertical force in solid line, torque in dashed line)

5. CONTROL APPLICATION

As an illustrative example of applications on control of flexible structures, let consider vibration attenuation of two flexible beams in chain-like assembly with the same properties as the one modelised in Section 4. The two flexible beams can be actuated with piezoelectric strips bonded at their surface as seen in Fig. 3, and their TITOP assembly is performed as depicted in Fig. 6.

After assembly, vibration attenuation is addressed with a rate feedback between the integration of the acceleration at the end of Beam II, \dot{q} , and the voltage applied at the piezoelectric strip in Beam I, v_1 . Controller gain is tuned so that the first flexible mode is maximally damped, which results in 0.2 damping ratio (see Fig. 7). Simulation of the system response to base acceleration excitation shows in Fig. 8 that vibrations at the end of Beam II are adequately attenuated when compared with the open loop response. Other controller inputs are possible, such as electric charges g_1 and g_2 and Beam I acceleration, but Beam II rate feedback acceleration was chosen since it offered more controllability.

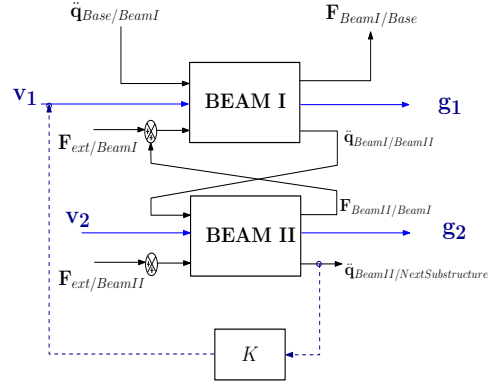

Figure 6. Assembly of two flexible beams actuated through piezoelectric components with TITOP modeling technique. Rate feedback through K ensures vibration attenuation.

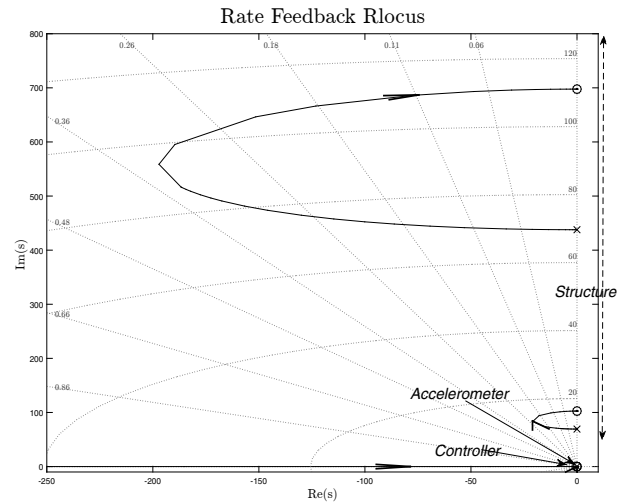

Figure 7. Root locus of the rate feedback of the flexible beams. Control is targeted at mode 1

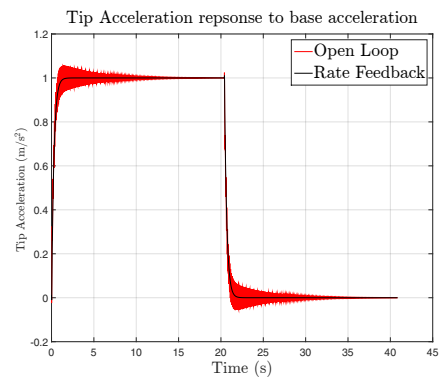

Figure 8. Tip response to base acceleration in open loop and with rate feedback controller

Therefore, the actuated TITOP model is a straightforward modeling tool for flexible structure control applications. Indeed, this model is used for piezoelectric component modelization in a Integrated Control/Structure Design of a Large Space Structure in Perez et al. (2016).

6. CONCLUSIONS AND PERSPECTIVES

This study has introduced a generic model for an actuated flexible structure with piezoelectric components. The model, derived from the finite element formulation, is an extension of the TITOP modeling technique (Perez et al., 2015b) which allows interconnection with different substructures through acceleration-load transfer among the connection points. This model inherits the TITOP model's accuracy and robustness to changes in boundary conditions, and includes the additional advantage of adding piezoelectric effects in flexible multibody system assembly. This has been demonstrated by modeling a beam with bonded piezoelectric strip and by performing vibration attenuation to a chain of flexible beams. This technique is used in different Integrated Control/Structure Design studies of Large Flexible Structures, such as in Perez et al. (2016).

ACKNOWLEDGEMENTS

Research efforts were supported by the kind financial support of the CNES AOCS Department and ONERA Flight Dynamics Department in Toulouse.

REFERENCES

- Alazard, D., Perez, J.A., Loquen, T., and Cumer, C. (2015). Two-Input Two-Output Port Model for Mechanical Systems. In *AIAA Science and Technology Forum and Exposition*. Kissimmee, Florida.
- Craig Jr, R.R. (2000). A Brief Tutorial on Substructure Analysis and Testing. In *Proceedings of the International Modal Analysis Conference-IMAC*, volume 1, 899–908.
- Goldfarb, M. and Celanovic, N. (1997). Modeling Piezoelectric Stack Actuators for Control of Micromanipulation. *Control Systems, IEEE*, 17(3), 69–79.
- Hurty, W.C. (1965). Dynamic Analysis of Structural Systems Using Component Modes. *AIAA Journal*, 3(4), 678–685.
- IEEE, I.o.E. and Engineers, E. (1988). IEEE Standard on Piezoelectricity. *ANSI/IEEE Std 176-1987*.
- Perez, J.A., Alazard, D., Loquen, T., Cumer, C., and Pittet, C. (2015a). Linear Dynamic Modeling of Spacecraft with Open-Chain Assembly of Flexible Bodies for ACS/Structure Co-Design. In *Advances in Aerospace Guidance, Navigation and Control*, 639–658. Springer.
- Perez, J.A., Alazard, D., Loquen, T., Pittet, C., and Cumer, C. (2015b). Flexible Multibody System Linear Modeling for Control using Component Modes Synthesis and Double-Port Approach. *arXiv preprint arXiv:1604.00259*. Submitted in ASME J. of Dynamic Systems, Measurement and Control (pending of minor revisions).
- Perez, J.A., Pittet, C., Alazard, D., and Loquen, T. (2016). Integrated Control/ Structure Design of a Large Space Structure using Structured \mathcal{H}_∞ Control. In *arXiv preprint arXiv:1604.00253*. To appear IFAC Symposium on Automatic Control in Aerospace - ACA 2016.
- Piefort, V. and Preumont, A. (2001). Modeling of Smart Piezoelectric Shell Structures with Finite Elements. In *Proceedings of the International Seminar on Modal Analysis*, volume 2, 869–876. KU Leuven; 1998.
- Smits, J.G., Dalke, S.I., and Cooney, T.K. (1991). The Constituent Equations of Piezoelectric Bimorphs. *Sensors and Actuators*, 28, 41–61.

Appendix A. MASS AND STIFFNESS MATRICES

The mass and stiffness matrices of each piezo element are written as:

$$[\mathcal{M}_{qq}]_{piezo} = \rho_p A_p l \begin{bmatrix} \frac{1}{3} & 0 & 0 & \frac{1}{6} & 0 & 0 \\ 0 & \frac{156}{420} & \frac{22}{4}l & 0 & \frac{54}{420} & -\frac{13}{420}l \\ 0 & \frac{22}{420}l & \frac{4}{420}l^2 & 0 & \frac{13}{420}l & -\frac{4}{420}l^2 \\ \frac{1}{6} & 0 & 0 & \frac{1}{3} & 0 & 0 \\ 0 & \frac{54}{420}l & \frac{13}{420}l & 0 & \frac{156}{420} & -\frac{22}{420}l \\ 0 & -\frac{13}{420}l & -\frac{4}{420}l^2 & 0 & -\frac{22}{420}l & \frac{4}{420}l^2 \end{bmatrix} \quad (\text{A.1})$$

$$[\mathcal{K}_{qq}]_{piezo} = \frac{E_p I_p}{l^3} \begin{bmatrix} \frac{A_p l^2}{I_p} & 0 & 0 & -\frac{A_p l^2}{I_p} & 0 & 0 \\ 0 & 12 & 6l & 0 & -12 & 6l \\ 0 & 6l & 4l^2 & 0 & -6l & 2l^2 \\ -\frac{A_p l^2}{I_p} & 0 & 0 & \frac{A_p l^2}{I_p} & 0 & 0 \\ 0 & -12 & -6l & 0 & 12 & -6l \\ 0 & 6l & 2l^2 & 0 & -6l & 4l^2 \end{bmatrix} \quad (\text{A.2})$$

where $I_p = w_p t_p (t^2 + t_p t + \frac{t_p^2}{2})$.

The mass and stiffness matrices of the beam element are identical as the ones denoted in Eqs. (A.1) and (A.2) but substituting the piezoelectric strip parameters by those of the beam.

Appendix B. BEAM PARAMETERS

Table B.1.

| Beam Parameters | Symbol | Value |
|------------------------|-------------------|----------------------------|
| Number of Elements | n | 3 |
| Total length | L | 0.50 m |
| Element length | $l = L/n$ | 0.17 m |
| Thickness | t | 9.53 mm |
| Width | w | 30.00 mm |
| Volumetric Density | ρ | 2600 Kg/m ³ |
| Elastic modulus | E | 60 GPa |
| Piezo Parameters | Symbol | Value |
| Number of Elements | n | 0.5 |
| Element length | $l = L/n$ | 0.17 m |
| Thickness | t_p | 2 mm |
| Width | w_p | 30 mm |
| Volumetric Density | ρ_p | 7600 Kg/m ³ |
| Elastic modulus | E_p | 50 GPa |
| Piezoelectric Constant | d_{31} | -150×10^{-12} m/V |
| Dielectric Constant | ϵ_{33}^T | 1.59×10^{-12} F/m |