



HAL
open science

Toward on-line robot vibratory modes estimation

Romain Delpoux, Richard Béarée, Adel Olabi, Olivier Gibaru

► **To cite this version:**

Romain Delpoux, Richard Béarée, Adel Olabi, Olivier Gibaru. Toward on-line robot vibratory modes estimation. American Control Conference (Portland: 2014), Jun 2014, Portland, United States. pp.4385 - 4390. hal-01410850

HAL Id: hal-01410850

<https://hal.science/hal-01410850v1>

Submitted on 6 Dec 2016

HAL is a multi-disciplinary open access archive for the deposit and dissemination of scientific research documents, whether they are published or not. The documents may come from teaching and research institutions in France or abroad, or from public or private research centers.

L'archive ouverte pluridisciplinaire **HAL**, est destinée au dépôt et à la diffusion de documents scientifiques de niveau recherche, publiés ou non, émanant des établissements d'enseignement et de recherche français ou étrangers, des laboratoires publics ou privés.

Toward on-line robot vibratory modes estimation

Romain Delpoux, Richard Béarée, Adel Olabi and Olivier Gibaru

Abstract— This paper is concerned with preliminary results on robot vibratory modes on-line estimation. The dominating oscillatory mode of the robot arm is isolated by comparing the robot position given by the motors encoders and an external measure at the tool-tip of the robot arm. In this article the external measurement is provided by a laser tracker. The isolation of the oscillation permits to identify the vibratory mode, *i.e.* the natural frequency and the damping ratio of the undesired phenomena. Here we propose a comparison between the algebraic method and the sliding modes for the parameter identification. This comparison is motivated by the fact that both methods provide finite time convergence. Experimental identifications are proposed on a 6 degrees of freedom (DOF) manipulator robot, Stäubli RX-170B.

Index Terms— Manipulator robots, dominating oscillatory mode, parameter estimation, algebraic approach, sliding modes.

I. INTRODUCTION

Manipulator robots are widely used in many fields of industry. Such processes can be used to carry out repetitive tasks, for example, pick and place or assembly tasks. However to improve the performance in terms of speed, such robots are becoming more lightweight and thus more flexible. Speed and accuracy require consideration of vibration of the end effector [21].

In the literature, solutions are proposed to guarantee trajectories which does not excite the vibration modes of the systems. Among these techniques it can be mentioned the Input Shaping (IS) [28]. IS methodology consists in the convolution of impulse sequences with a desired system command to produce a shaped input that is used to drive the system [29]. However, IS are designed for a given frequency. In industrial applications, where uncertain or time-varying parameters are considered, IS can lose efficiency. IS with parameter adaptations have been proposed, known as Adaptive Input Shaper (AIS). AIS solutions can be designed based on frequency domain [31] or time domain [5], [22]. The development of such algorithms has motivated the comparison of two methods for on-line parameter identification.

Many different methods for the parameter identification exist in the literature. One of the most popular concept is the regression (linear or nonlinear) [30]. Observer based

approaches can also be found, such as asymptotic observers using the extended Kalman filter [4] or finite time ones like sliding modes observers. Another approach for the parameter identification is based on an algebraic method. In this paper we propose to compare the algebraic method and the sliding modes for the parameter identification. The objective to characterize the oscillatory behaviour of manipulator robots, *i.e.* the natural frequency and damping ratio in order to compensate the vibrations. Both methods lead to non-asymptotic convergence estimation procedure.

The algebraic approach was introduced by M. Fliess and H. Sira-Ramírez in [14], [15]. The method is based on differential algebra and operational calculus. The desired parameters are expressed as a function of integrals of the measured outputs and inputs of the system. It does not need any statistical knowledge of the noise (for instance the assumption that the noise is Gaussian is not required). This method has already been successfully applied to parameter estimation [10], [18], [20], [23], to abrupt change detections and the efficient identification of time delays [2], [13]. Numerical differentiation of noisy signals may also benefit from this approach, as demonstrated in [19], [26].

Sliding modes have been popularized by the precursor article of V.-I. Utkin [32]. Their popularity is due to the robustness properties with respect to perturbations and uncertainties [12], [24]. Chattering phenomenon was a main drawback of the method, however the introduction of high-order sliding modes has overcome this problem. In this paper second order sliding modes observers are presented [7]. These observers ensure the finite time convergence to the observed variables, providing equivalent output injection (EOI). The EOI is exploited to obtain the desired parameter estimations [8]. Sliding modes have been used in a wide range of application for the control, the observation and the identification [1], [11], [16], [17], [25], [27].

The paper is organized as follows: Section II describes the problem statement, the robotic system and a description of vibratory phenomena. The algebraic and sliding mode identifications algorithms are presented III. Finally, the last section presents experimental results on the manipulator robot.

II. PROBLEM STATEMENT

A. Robotic system description

The vibratory study presented in this article is realized on a Stäubli RX-170. This manipulator, depicted in Fig. 1, is a 6 degrees of freedom (DOF) industrial robot with revolute joints. Industrial robots are known to have a good repeatability. The static and dynamic accuracy is far beyond,

R. Delpoux, R. Béarée, A. Olabi and O. Gibaru are with Laboratoire des Sciences de l'Information et des Systèmes (CNRS UMR 7296) INSM team, 8, Bd Louis XIV, 59046 Lille Cedex, France {romain.delpoux, richard.bearee, adel.olabi, olivier.gibaru}@ensam.eu

O. Gibaru is with Non-A project-team INRIA Lille-Nord-Europe, 40, avenue Halley. Bât. A 59650 Villeneuve d'Ascq, France.

The authors would like to thanks Julien Bancalín, engineer at Arts et Métiers ParisTech, for his support during experimentation on the manipulator robot.

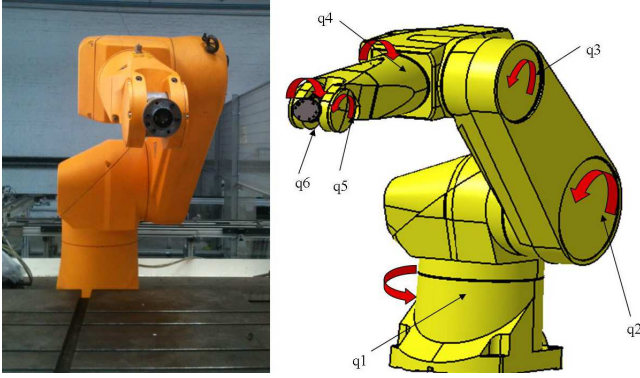

Fig. 1. Stäubli RX-170B robot arm.

typically around some millimeters. Dynamic accuracy is mainly deteriorated by joint deformations, which induced low-damped vibrations of the tip of the robot. Classically, each robot axis are submitted to a dominating flexible vibratory mode [21]. This paper focused on the fast estimation of this vibration for one axis of the robot.

The Stäubli CS8 controller provides access to the actual joints positions and velocities measured through encoders on the motor shafts. The controller is sampled at a sampling frequency of $4ms$ ($250Hz$). In order to measure the absolute position of the robot, a Laser Tracker from API inc. is used, where a retroreflector target is mounted on the tool-tip of the robot. The system resolution is $10\mu.m^{-1}$ and the sampling frequency is $3ms$ ($333Hz$).

B. Vibratory dynamics

Considering the first dominating flexible mode, robot axis can be considered as a two mass coupled system, having the rigid link driven by electrical motor through a rotational joint transmission undergoing a viscoelastic joint deformation with a constant stiffness K and a viscosity D (see Fig. 2).

The objective of the paper is to identify the flexible vibratory mode of this axis, i.e. the equivalent harmonic oscillator parameters between the gearbox output and the end of the axis. This behavior can be represented in continuous

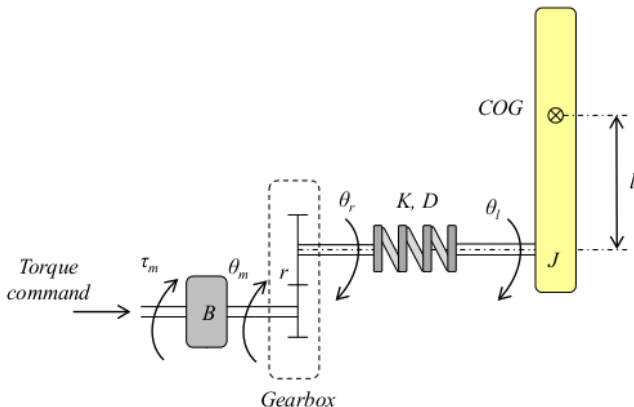

Fig. 2. Flexible mode interpretation.

time domain by the second order system:

$$\frac{\theta_l(s)}{\theta_r(s)} = \frac{Y(s)}{U(s)} = \frac{K\omega_n^2}{s^2 + 2\xi\omega_n s + \omega_n^2}, \quad (1)$$

where $Y(s)$ is the output (the angular position of the axis), $U(s)$ is the input (angular position of the gearbox output shaft), ξ is the damping ratio, ω_n is the natural frequency and K is the gain of the system. This model is considered with the assumption that the system is governed by one vibration mode and that the others have negligible contributions.

Consider the equation (1), expressed as a second order differential equation:

$$\ddot{y}(t) + 2\xi\omega_n\dot{y}(t) + \omega_n^2y(t) = K\omega_n^2u(t). \quad (2)$$

In order to simplify the following developments, equation (2) is expressed as:

$$\ddot{y}(t) + \alpha_2\dot{y}(t) + \alpha_1y(t) = \alpha_3u(t), \quad (3)$$

where:

$$\xi = \frac{\alpha_2}{2\sqrt{\alpha_1}}, \omega_n = \sqrt{\alpha_1}, K = \frac{\alpha_3}{\alpha_1}. \quad (4)$$

Introducing the variables $x_1 = y$, $x_2 = \dot{y}$, the model (3) can be rewritten under the state-space form:

$$\begin{aligned} \dot{x}_1 &= x_2, \\ \dot{x}_2 &= -\alpha_1x_1 - \alpha_2x_2 + \alpha_3u. \end{aligned} \quad (5)$$

The different representations introduced in this section will be thereafter used to develop the identification algorithms.

III. PARAMETERS ESTIMATION

A. Algebraic Approach

The algebraic estimator presented in this article is based on the basic approach introduced by M. Fliess and H. Sira-Ramírez and can be found in [22] for its application on a second order system. In this article a theoretical development was proposed with the objective to tune an Adaptive Input Shaping. Modifications are proposed to estimate the system's gain. Consider the differential equation (3). Its Laplace Transform is given by:

$$\begin{aligned} s^2Y(s) - sy(0) - \dot{y}(0) + \alpha_1(sY(s) - y(0)) \\ + \alpha_2Y(s) - \alpha_3U(s) = 0. \end{aligned} \quad (6)$$

The initial conditions which appear in the equation (6) are annihilated by taking two derivatives w.r.t the complex variable s . One obtains

$$\begin{aligned} s^2\frac{d^2Y}{ds^2} + 4s\frac{dY}{ds} + 2Y + \alpha_1\left(s\frac{d^2Y}{ds^2} + 2\frac{dY}{ds}\right) \\ + \alpha_2\frac{d^2Y}{ds^2} - \alpha_3\frac{d^2U}{ds^2} = 0. \end{aligned} \quad (7)$$

Recall that derivation w.r.t s in the operational domain translates into multiplication by $-t$ in the time domain. Multiplication by s in the operational domain corresponds to derivation in the time domain. Applying the linear estimator (7) is not appropriate. Derivation amplifies the high frequency components and consequently, the noise contribution. A simple solution is to make the estimator proper. It is

enough to multiply both sides of (7) by s^{-2} , to eliminate the derivation terms and obtain a relationship in function of integral operators.

After algebraic manipulations, one has:

$$\begin{aligned} & \frac{d^2 Y}{ds^2} + 4s^{-1} \frac{dY}{ds} + 2s^{-2} Y \\ & + \alpha_1 \left(s^{-1} \frac{d^2 Y}{ds^2} + 2s^{-2} \frac{dY}{ds} \right) \\ & + \alpha_2 \left(s^{-2} \frac{d^2 Y}{ds^2} \right) - \alpha_3 \left(s^{-2} \frac{d^2 U}{ds^2} \right) = 0. \end{aligned} \quad (8)$$

By application of the Laplace inverse, the equivalent time domain expression is:

$$\eta_1(t) + \alpha_1 \eta_2(t) + \alpha_2 \eta_3(t) - \alpha_3 \eta_4(t) = 0, \quad (9)$$

in which:

$$\begin{aligned} \eta_1(t) &= t^2 y(t) - 4 \int_0^t \sigma y(\sigma) d\sigma + 2 \int_0^t \int_0^\sigma y(\lambda) d\lambda d\sigma, \\ \eta_2(t) &= \int_0^t \sigma^2 y(\sigma) d\sigma - 2 \int_0^t \int_0^\sigma \lambda y(\lambda) d\lambda d\sigma, \\ \eta_3(t) &= \int_0^t \int_0^\sigma \lambda^2 y(\lambda) d\lambda d\sigma, \\ \eta_4(t) &= \int_0^t \int_0^\sigma \lambda^2 u(\lambda) d\lambda d\sigma. \end{aligned} \quad (10)$$

As mentioned in [22], the set of equations can be implemented by means of time varying linear (unstable) filters.

From equation (9) we have one equation for three unknown parameters. A solution would consist in integrating (9) successively twice to obtain a set of three independent equations linear with respect to the parameter to be identified.

The resulting equation (9), is linear in the unknown parameters. We rewrite it as:

$$p_1(t)\theta = q_1(t), \quad (11)$$

where $p_1(t) = [-\eta_1(t) \quad -\eta_2(t) \quad \eta_3(t)]$, $q_1(t) = \eta_1(t)$ and $\theta = [\alpha_1 \quad \alpha_2 \quad \alpha_3]$.

B. Sliding Modes Approach

Consider a second order system written under the state space form:

$$\begin{aligned} \dot{x}_1(t) &= x_2(t), \\ \dot{x}_2(t) &= f(t, x_1(t), x_2(t), u(t)) + \zeta(t, x_1(t), x_2(t), u(t)), \\ y(t) &= x_1(t), \end{aligned} \quad (12)$$

where $f(t, x_1(t), x_2(t), u(t))$ is a known function while the uncertainties are concerned in the term $\zeta(t, x_1(t), x_2(t), u(t))$.

1) *Observer design*: The proposed Super-Twisting observer has the form:

$$\begin{aligned} \dot{\hat{x}}_1(t) &= \hat{x}_2(t) + z_1(t), \\ \dot{\hat{x}}_2(t) &= f(t, x_1(t), \hat{x}_2(t), u) + z_2(t), \end{aligned} \quad (13)$$

where $\hat{x}_1(t)$ and $\hat{x}_2(t)$ are the state estimations, and the correction variables $z_1(t)$ and $z_2(t)$ are the output injections

of the form:

$$\begin{aligned} z_1(t) &= \lambda |x_1(t) - \hat{x}_1(t)|^{1/2} \text{sign}(x_1(t) - \hat{x}_1(t)), \\ z_2(t) &= \alpha \text{sign}(x_1(t) - \hat{x}_1(t)). \end{aligned} \quad (14)$$

At the initial moment, $\hat{x}_1(0) = x_1(0)$ and $\hat{x}_2(0) = 0$.

Taking $e_1(t) = x_1(t) - \hat{x}_1(t)$ and $e_2(t) = x_2(t) - \hat{x}_2(t)$ the error equations are given by:

$$\begin{aligned} \dot{e}_1(t) &= e_2(t) - \lambda |x_1 - \hat{x}_1|^{1/2} \text{sign}(x_1 - \hat{x}_1), \\ \dot{e}_2(t) &= F(t, x_1(t), \hat{x}_2(t), u(t)) - \alpha \text{sign}(x_1(t) - \hat{x}_1(t)), \end{aligned} \quad (15)$$

where $F(t, x_1(t), \hat{x}_2(t), u(t)) = f(t, x_1(t), x_2(t), u(t)) - f(t, x_1(t), \hat{x}_2(t), u(t)) + \zeta(t, x_1(t), x_2(t), u(t))$. Suppose that the system states can be assumed bounded then the existence is ensured for a constant f^+ , such that the inequality:

$$|F(t, x_1(t), \hat{x}_2(t), u(t))| < f^+, \quad (16)$$

holds for any possible $t, x_1(t), x_2(t)$ and $\hat{x}_2(t) < 2\text{sup}|x_2(t)|$.

Let α and λ satisfy the inequalities:

$$\begin{aligned} \alpha &> f^+, \\ \beta &> \sqrt{\frac{2}{\alpha - f^+} \frac{(\alpha + f^+)(1 + p)}{(1 - p)}}, \end{aligned} \quad (17)$$

where p is some chosen constant, $0 < p < 1$.

Theorem 3.1: Suppose that the parameters of the observer (13), (14) are selected according to (17) and condition (16) holds for system (12). Then, the variables of the observer converge in finite time to the states of the system, i.e. $(\hat{x}_1(t), \hat{x}_2(t)) \rightarrow (x_1(t), x_2(t))$.

Proof, see [7].

2) *Parameter Identification Formulation*: The parameter identification developed in this section comes from [9]. The finite time convergence to the second order sliding mode set ensures that there exists the time constant $t_0 > 0$ such that for all $t \geq t_0$, from (15) the following identity holds:

$$\begin{aligned} 0 &\equiv \dot{e}_2(t) \\ &\equiv F(t, x_1(t), \hat{x}_2(t), u(t)) - \alpha \text{sign}(x_1(t) - \hat{x}_1(t)), \end{aligned} \quad (18)$$

notice that $F(t, x_1(t), \hat{x}_2(t), u(t)) = \zeta(t, x_1(t), x_2(t), u(t))$ because $\hat{x}_2(t) = x_2(t)$. Then the equivalent output injection z_{eq} is given by:

$$z_{eq} \equiv \alpha_1 \text{sign}(e_1(t)) \equiv \zeta(t, x_1(t), \hat{x}_2(t), u(t)). \quad (19)$$

Consider that $\zeta(t, x_1(t), x_2(t), u(t))$ can be decomposed using the regressor notation [30] as:

$$\zeta(t, x_1(t), \hat{x}_2(t), u(t)) = \theta(t) \varphi(t, x_1(t), \hat{x}_2(t), u(t)), \quad (20)$$

where $\theta(t) \in \mathbb{R}^{n \times l}$ is a matrix composed by the value of the uncertain parameters and $\varphi(t, x_1(t), x_2(t), u(t)) \in \mathbb{R}^l$ is a known nonlinear function vector.

For the case where the system parameters are time invariant, i.e. $\theta(t) = \theta$, the equivalent output injection can be

represented in the form:

$$\zeta(t, x_1(t), x_2(t), u(t)) = \theta \varphi(t, x_1(t), x_2(t), u(t)). \quad (21)$$

Applied to the article configuration, none of the parameters are known. The equation (12) is expressed with:

$$\begin{aligned} f(t, x_1(t), x_2(t), u(t)) &= 0, \\ \zeta(t, x_1(t), x_2(t), u(t)) &= -\alpha_1 x_1(t) - \alpha_2 x_2(t) + \alpha_3 u(t). \end{aligned} \quad (22)$$

Equation (21) can then be expressed by

$$p_2(t)\theta = q_2(t), \quad (23)$$

where $p_2(t) = [-x_1(t) \ -x_2(t) \ u(t)]$, $q_2(t) = \zeta(t, x_1(t), x_2(t), u(t))$ and $\theta = [\alpha_1 \ \alpha_2 \ \alpha_3]$.

Remark 1: For the purpose of this article, we have considered that none of the parameters were known. Another configuration could have considered that we have nominal parameters expressed by $f(t, x_1(t), x_2(t), u(t))$ and parameter variations to be identified expressed by $\zeta(t, x_1(t), x_2(t), u(t))$.

C. Parameters Identification

The proposed approaches for the parameter identification based on an algebraic approach and on sliding modes led to the two similar linear expressions (11) and (23). The solution for θ is obtained as a classical solution given by the Least Squares method [6]

$$\hat{\theta}_i = \left[\int_0^t p_i^T(\sigma) p_i(\sigma) d\sigma \right]^{-1} \left[\int_0^t p_i^T(\sigma) q_i(\sigma) d\sigma \right]. \quad (24)$$

for $i \in \{1, 2\}$. The algebraic parameter estimation is given for $i = 1$ while the sliding modes parameters identification is given for $i = 2$.

In the next section, the algorithms for the parameter identification are applied experimentally for the robot system.

IV. EXPERIMENTAL RESULTS

A. Experimental setup

The experimental results are carried out on the manipulator robot described in the Section II. In order to exhibit the oscillatory behavior, the desired trajectory was planned as an angular motion of the first joint (30°), represented Fig. 1, while the five others are fixed. The positions measured by the encoders are collected during the displacement. The position of the robot in the cartesian frame is obtained using the kinematic model of the robot, which was previously identified. At the same time, a laser tracker measures the position of the tool-tip. The frames of the robot and the laser tracker have been matched using an Iterated Closest Points (ICP) algorithm [3]. The two trajectories are represented Fig. 3. Although the trajectories are close the figure exhibits the oscillatory behavior at the end effector.

B. Off-line deformation analysis

In this section is presented the identification of the parameters ω_n , ξ and K along the X position. Fig. 4 represents the temporal evolution of the X position. On top, the blue curve

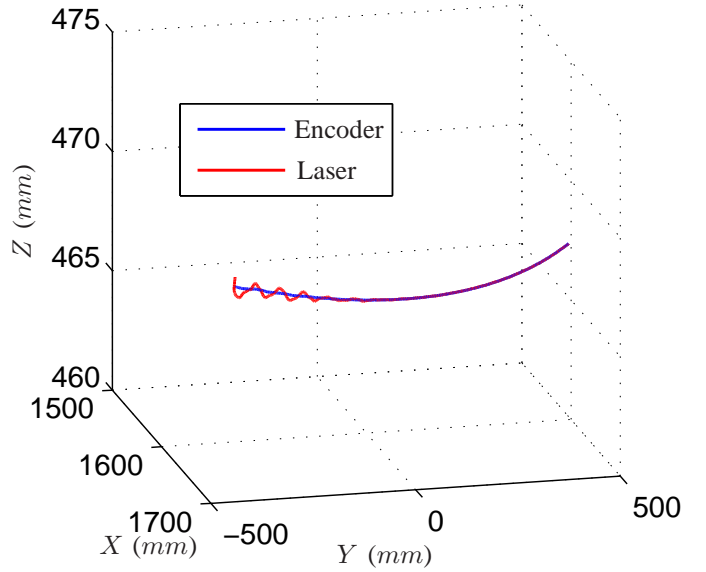

Fig. 3. Experimental measurement of the robot trajectory tracking in the (X, Y, Z) cartesian frame.

represents the encoder measure, the red one, the laser. In order to exhibit the oscillatory behavior, the second subplot represents the difference between the two measures whether the deformation noted $\Delta\theta$. This figure shows that indeed the assumption of a second order system for the modelling of the flexible mode makes sense. Using classical results on temporal response of second order system one can easily define the parameters to be compared with the ones identified using the on-line approaches. Indeed the damping ratio can be defined using the formula:

$$\xi = \frac{\ln\left(\frac{\Delta_1}{\Delta_2}\right)}{\sqrt{(2\pi)^2 + \ln\left(\frac{\Delta_1}{\Delta_2}\right)^2}}, \quad (25)$$

From Fig. 4 one has $d_1 = 0.74mm$ and $d_2 = 0.43mm$ thus from this response, we have a damping ratio $\xi = 8.6\%$. The figure also show a static gain close to zero. A measure of the oscillation period could give the natural frequency, however to be more precise we propose to compute the Fourier transform of the deformation. The analysis of the Fourier transform highlight the different frequencies. The Fourier transform of this signal is represented Fig. 5 and shows that dominating mode as a pure natural frequency of $8.13Hz$.

The off-line analysis previously presented gives an idea of the parameters to be estimated. Note that these parameters have been identified experimentally and cannot be considered as reference parameters. These values are used to give an order of magnitude to be compared with the online estimation presented in the next section.

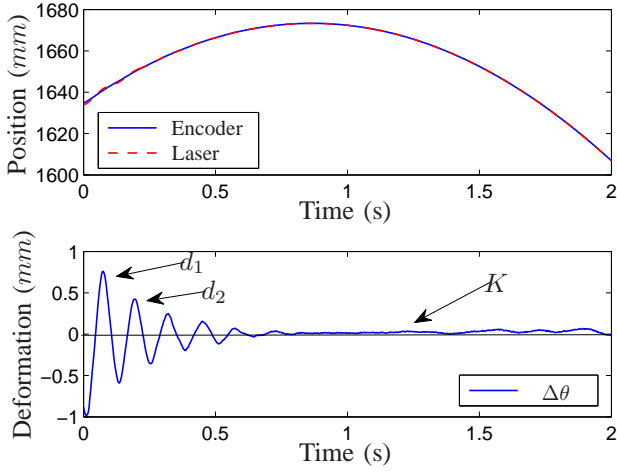

Fig. 4. Temporal evolution of the X position (top) and its deformation (bottom).

C. On-line parameter estimation

Before comparing the estimation results, it is important to show the convergence of the sliding mode observer. Indeed as mentioned in Section III, the estimation via sliding modes relies on the design of an observer. The finite time convergence of the observer is based on the assumption of bounded system states. Without loss of generalities, one can assume that the modal deformation of the robot axis is bounded (its derivative equally). The observer gains are chosen in accordance with equation (17). In Fig. 6 the axis deformation $\Delta\theta$ is represented with its estimation $\Delta\hat{\theta}$. The estimation error plotted in the second subplot show the good behavior of the proposed observer. Note that the observer tracking error represents an interesting criterion for the parameter estimation convergence.

The experimental comparison of the identification methods

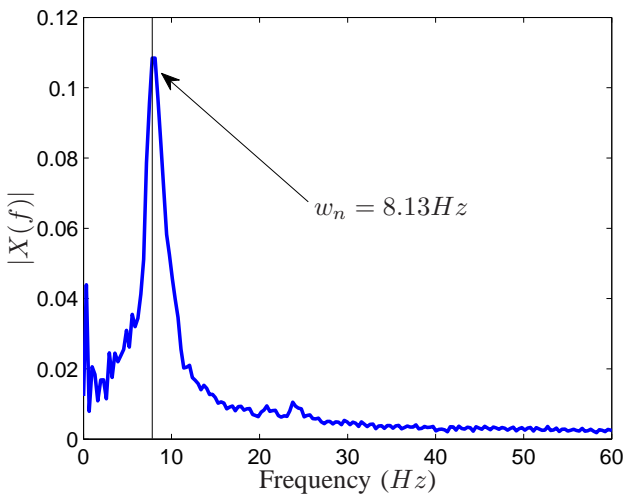

Fig. 5. Fourier transform of the X deformation.

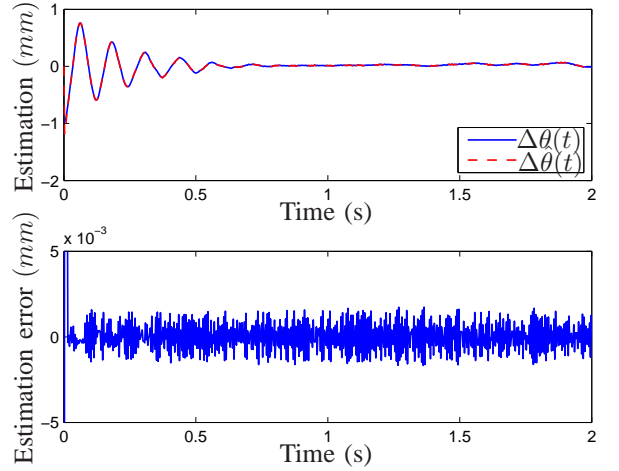

Fig. 6. Sliding mode deformation observation and its error.

is represented Fig. 7. The figure shows that after convergence, the estimations give the same results, whether $\xi = 8.4\%$, $\omega_n = 8.12Hz$ and $K = 0.02$ moreover the results are close to the ones obtained off-line. However, for the sliding mode approach, the convergence is faster (around $0.07s$ for the Sliding modes and $0.12s$ for the algebraic method). The algebraic approach does not require gain tuning, which can be a complicated task. Note that the parameter convergence time can be obtained using a method based on the standard deviation of the estimated parameters [22].

V. CONCLUSION

In this paper was proposed an experimental comparison between two on-line parameter estimation methods. The algebraic approach was compared to the sliding modes approach. The algorithms have been evaluated experimentally on an industrial robot axis. The objective was to identify

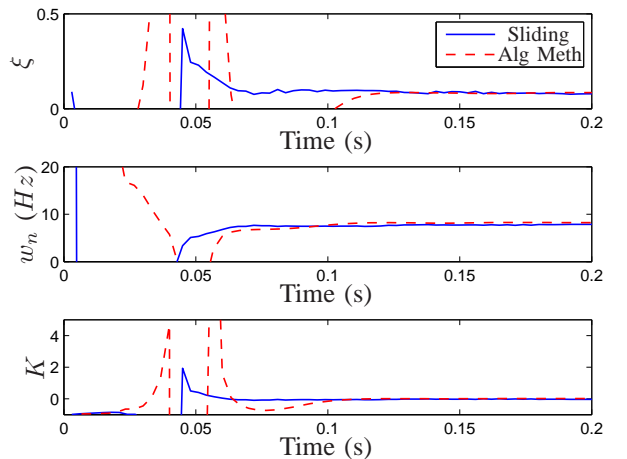

Fig. 7. On-line parameter estimation, (blue) sliding modes approach, (red) algebraic approach.

the first modal deformation of the robot axis. This vibratory dynamics were modelled by a second order system where the natural frequency and the modal damping were the parameters to be identified.

The comparison between both algorithms has shown similar results in terms of estimated parameter results although the time of convergence is faster for the sliding modes approach. The main difference between these algorithms concern the gains tuning and the algorithmic complexity. The sliding modes structure is simpler to implement, however observers are based on gains which depend on the perturbation amplitudes. The algebraic method, on the other hand, does not depend on parameter tuning but are more complex to implement.

Regarding the convergence time of both the algorithms, experimentations have pointed that around one period of the vibration signal was necessary for the estimators to converge. This result can be considered insufficient for most of the vibration shaping methods require half a period to be efficient. The observation can be relativized considering the sampling frequency of the sensor. Higher the sampling frequency is, the faster the estimation convergence will be. One can note that the sensing device used for these estimations, a 3d absolute position system, works at a maximum sampling frequency of 333Hz. A simpler and lower-cost vibration sensor, such as accelerometer, can be used with higher sampling frequency.

Future works on vibration control concern the on-line implementation of these estimation technics for real-time adaptation of input-shaping parameters.

REFERENCES

- [1] G. Bartolini and A. Pisano. Global output-feedback tracking and load disturbance rejection for electrically-driven robotic manipulators with uncertain dynamics. *International Journal of control*, 76(12):1201–1213, 2003.
- [2] L. Belkoura, J.-P. Richard, and M. Fliess. Parameters estimation of systems with delayed and structured entries. *Automatica*, 45(5):1117–1125, 2009.
- [3] P.-L. Besl and McKay N.-D. A Method for Registration of 3-D Shapes. *IEEE Transactions on Pattern Analysis and Machine Intelligence*, 14(2):239–256, 1992.
- [4] S. Bittanti and S.-M. Savaresi. On the parametrization and design of an extended Kalman filter frequency tracker. *IEEE Transactions on Automatic Control*, 45(9):1718–1724, September 2000.
- [5] M. Bodson. An Adaptive Algorithm for the Tuning of Two Input Shaping Methods. *Automatica*, 34(6):771–776, 1998.
- [6] J. Cortes-Romero, C. Garcia-Rodriguez, A. Luviano-Juarez, and H. Sira-Ramírez. Algebraic parameter identification for induction motors. In *37th Annual Conference on IEEE Industrial Electronics Society*, pages 1734–1740, 2011.
- [7] J. Davila, L. Fridman, and A. Levant. Second-order sliding-mode observer for mechanical systems. *IEEE Transactions on Automatic Control*, 50(11):1785–1789, 2005.
- [8] J. Davila, L. Fridman, and A. Poznyak. Observation and Identification of Mechanical Systems via Second Order Sliding Modes. *International Journal of Control*, 79(10):1251–1262, 2006.
- [9] J. Davila, L. Fridman, and A. Poznyak. Observation and Identification of Mechanical Systems via Second Order Sliding Modes. In *Variable Structure Systems, 2006. VSS'06. International Workshop on*, pages 232–237, 2006.
- [10] R. Delpoux and T. Floquet. On-line parameter estimation of a magnetic bearing. In *19th Mediterranean Conference on Control Automation*, pages 388–393, Corfu, Greece, 2011.
- [11] S.-V. Drakunov, T. Floquet, and W. Perruquetti. Stabilization and tracking control for an extended Heisenberg system with a drift. *Systems & Control Letters*, 54(5):435–445, 2005.
- [12] C. Edwards and S.-K. Spurgeon. *Sliding mode control - Theory and application*. Taylor & Francis, 1998.
- [13] M. Fliess, C. Join, and M. Mboup. Algebraic change-point detection. *Applicable Algebra in Engineering, Communication and Computing*, 21:131–143, 2010.
- [14] M. Fliess and H. Sira-Ramírez. An algebraic framework for linear identification. *ESAIM: Control, Optimisation and Calculus of Variations*, 9:151–168, January 2003.
- [15] M. Fliess and H. Sira-Ramírez. Closed-loop parametric identification for continuous-time linear systems via new algebraic techniques. In H Garnier & L Wang, editor, *Identification of Continuous-time Models from Sampled Data*, Advances in Industrial Control, pages 362–391. Springer, 2008.
- [16] T. Floquet, J.-P. Barbot, and W. Perruquetti. Higher-order sliding mode stabilization for a class of nonholonomic perturbed systems. *Automatica*, 39(6):1077–1083, 2003.
- [17] L. Fridman, J. Davila, and A. Levant. High-order sliding-mode observation and fault detection. In *46th IEEE Conference on Decision and Control*, pages 4317–4322, 2007.
- [18] M. Mboup. Parameter estimation for signals described by differential equations. *Applicable Analysis: An International Journal*, 88(1):29–52, 2009.
- [19] M. Mboup, C. Join, and M. Fliess. Numerical differentiation with annihilators in noisy environment. *Numerical Algorithms*, 50:439–467, 2009.
- [20] R. Morales, V. Feliu, and H. Sira-Ramírez. Nonlinear Control for Magnetic Levitation Systems Based on Fast Online Algebraic Identification of the Input Gain. *IEEE Transactions on Control Systems Technology*, 19(4):757–771, 2011.
- [21] A. Olabi, R. Béarée, O. Gibaru, and M. Damak. Feedrate planning for machining with industrial six-axis robots. *Control Engineering Practice*, 18(5):471–482, 2010.
- [22] E. Pereira, J.-R. Trapero, I.-M. Díaz, and V. Feliu. Adaptive input shaping for manoeuvring flexible structures using an algebraic identification technique. *Automatica*, 45(4):1046–1051, 2009.
- [23] E. Pereira, J.-R. Trapero, I.-M. Díaz, and V. Feliu. Adaptive input shaping for single-link flexible manipulators using an algebraic identification. *Control Engineering Practice*, 20(2):138–147, February 2012.
- [24] W. Perruquetti and J.-P. Barbot. *Sliding mode control in engineering*. Control Engineering Series, Marcel Dekker Inc, New York, 2002.
- [25] A. Pisano, A. Davila, L. Fridman, and E. Usai. Cascade control of PM-DC drives via second-order sliding mode technique. In *10th International Workshop on Variable Structure Systems*, pages 268–273, Antalya, Turkey, 2008.
- [26] S. Riachy, Y. Bachalany, M. Mboup, and J.-P. Richard. Différentiation numérique multivariable I : estimateurs algébriques et structure. In *6ième Conférence Internationale Francophone d'Automatique*, Nancy, France, 2010.
- [27] S. Riachy, Y. Orlov, T. Floquet, R. Santiesteban, and J.-P. Richard. Second order sliding mode control of underactuated Mechanical systems I: Local stabilization with application to an inverted pendulum. *International Journal of Robust and Nonlinear Control*, 18(4-5):529–543, 2008.
- [28] N.-C. Singer and W.-P. Seering. Preshaping Command Inputs to Reduce System Vibration. *ASME Journal of Dynamic Systems, Measurement, and Control*, 112:76–82, 1990.
- [29] W. Singhose and L. Pao. A comparison of input shaping and time-optimal flexible-body control. *Control Engineering Practice*, 5(4):459–467, 1997.
- [30] T. Söderström and P. Stoica. *System Identification*. Prentice-Hall International Editions, UK, 1989.
- [31] A. Tzes and S. Yurkovich. An adaptive input shaping control scheme for vibration suppression in slewing flexible structures. *IEEE Transactions on Control Systems Technology*, 1(2):114–121, 1993.
- [32] V.-I. Utkin. Variable structure systems with sliding modes. *IEEE Transactions on Automatic Control*, 22(2):212–222, 1977.