



**HAL**  
open science

## Comprehensive monitoring of MEA degradation in a post-combustion CO<sub>2</sub> capture pilot plant with identification of novel degradation products in gaseous effluents.

Ludovic Chahen, Thierry Huard, Lorena Cuccia, Vincent Cuzuel, José Dugay, Valérie Pichon, Jérôme Vial, Camille Gouédard, Leslie Bonnard, Pierre-Louis Carrette

### ► To cite this version:

Ludovic Chahen, Thierry Huard, Lorena Cuccia, Vincent Cuzuel, José Dugay, et al.. Comprehensive monitoring of MEA degradation in a post-combustion CO<sub>2</sub> capture pilot plant with identification of novel degradation products in gaseous effluents.. International Journal of Greenhouse Gas Control, 2016, 51, pp.305-316. 10.1016/j.ijggc.2016.05.020 . hal-01410521

**HAL Id: hal-01410521**

**<https://hal.science/hal-01410521>**

Submitted on 8 Dec 2016

**HAL** is a multi-disciplinary open access archive for the deposit and dissemination of scientific research documents, whether they are published or not. The documents may come from teaching and research institutions in France or abroad, or from public or private research centers.

L'archive ouverte pluridisciplinaire **HAL**, est destinée au dépôt et à la diffusion de documents scientifiques de niveau recherche, publiés ou non, émanant des établissements d'enseignement et de recherche français ou étrangers, des laboratoires publics ou privés.

13 **Comprehensive monitoring of MEA degradation in a post-**  
14 **combustion CO<sub>2</sub> capture pilot plant with identification of novel**  
15 **degradation products in gaseous effluents.**  
16

17 Ludovic Chahen <sup>a</sup>, Thierry Huard <sup>a</sup>, Lorena Cuccia <sup>b</sup>, Vincent Cuzuel <sup>b</sup>, José Dugay <sup>b</sup>, Valérie Pichon <sup>b</sup>,  
18 Jérôme Vial <sup>b</sup>, Camille Gouédard <sup>a</sup>, Leslie Bonnard <sup>a</sup> and Pierre-Louis Carrette <sup>a,\*</sup>

19  
20 <sup>a</sup> IFP Energies nouvelles, Rond-point de l'échangeur de Solaize, BP 3, 69360 SOLAIZE, France  
21 <sup>b</sup> Laboratoire Sciences Analytiques Bioanalytiques et Miniaturisation, UMR CBI 8231, ESPCI ParisTech  
22 - CNRS, 10 rue Vauquelin, 75005 PARIS, France  
23

24 **Abstract**

25 A pilot plant campaign was performed to study MEA degradation in CO<sub>2</sub> capture conditions and  
26 anticipate potential degradation products emissions to the atmosphere in industrial case. Aqueous  
27 30% wt MEA was cycled between absorption and regeneration steps during 1700 hours in the  
28 presence of a synthetic flue gas containing 81% of N<sub>2</sub>, 14% of CO<sub>2</sub>, 5% of O<sub>2</sub>, 97 ppm of NO, 9 ppm of  
29 SO<sub>2</sub> and 5 ppm of NO<sub>2</sub>. Specific methods (sampling, sample conditioning and analysis) were  
30 developed to improve degradation products identification and to provide a quantification of targeted  
31 compounds in liquid phase and above all in absorber and stripper gas effluents. Especially, trace  
32 elements were detected in liquid phase thanks to Head Space-Solid Phase MicroExtraction (HS-SPME)  
33 and liquid-liquid extraction with ChemElut cartridges and in gas phase thanks to adsorbent tubes of  
34 different type: Sep-Pak<sup>®</sup> for aldehydes and ketones, Orbo 60 for N-nitrosodimethylamine, Tenax and  
35 active charcoal for non-specific adsorption. 32 degradation products were identified in liquid phase  
36 and 38 in gas phase, 17 of which for the first time, especially derivatives of pyridine and oxazolidine,  
37 1H-pyrrole and a new nitrosamine, the N-nitroso-2-methyl-oxazolidine.

38 **Keywords**

39 Ethanolamine degradation products in gas effluents; pilot plant monitoring; novel analytical  
40 methods; solid phase extraction; nitrosamines; stripper gas effluents analysis.

41 **Introduction**

42 Most mature post-combustion CO<sub>2</sub> capture technology is based on CO<sub>2</sub> absorption by aqueous amine  
43 solutions. 2-ethanolamine (MEA) remains the benchmark solvent. When a new formulation is  
44 developed, it is always compared to MEA in terms of energy requirement of the process, in terms of  
45 corrosion and also in terms of degradation of the solvent. Indeed, a main problem associated with  
46 chemical absorption using amines is degradation through irreversible side reactions mainly with CO<sub>2</sub>  
47 and O<sub>2</sub> but also with NO<sub>x</sub> (Fostas et al., 2011) and SO<sub>x</sub> (Zhou et al., 2012). These reactions can lead to  
48 different consequences for the process: solvent loss causing cost (Carrette et al., 2013; Rao and

49 Rubin, 2012), formation of volatile compounds potentially unfriendly for environment (Thitakamol et  
50 al., 2007), corrosion (Lepaumier et al., 2010, Martin et al., 2012 ), foaming and fouling (Islam et al.,  
51 2011). It is important to list formed compounds and their concentration because some of them could  
52 be emitted to atmosphere and could be potentially a concern for human health like nitrosamines for  
53 instance (IARC, 1978; NTP, 2012; Thitakamol et al., 2007). Above all, the knowledge of their presence  
54 enables the development of adapted counter measures to avoid any risk for environment or human  
55 health.

56 Amine degradation is mainly due to oxidative degradation (Gouédard et al., 2012; Lepaumier et al.,  
57 2009b; Rooney et al., 1998; Sexton, 2008) but also to thermal degradation, which occurs at high  
58 temperature and high CO<sub>2</sub> partial pressure in the stripper (Davis, 2009; Holub et al., 1998; Lepaumier  
59 et al., 2008, 2009a). Oxidative degradation occurs because of a large amount of O<sub>2</sub> in flue gases.  
60 These two mechanisms of degradation have been studied mainly under laboratory conditions,  
61 sometimes on pilot plant (Reynolds et al., 2015; da Silva et al., 2012; Lepaumier et al., 2011; Strazisar  
62 et al., 2003) and rarely on real CO<sub>2</sub> capture process. Most of the studies were focused on solvent  
63 analysis. This approach is certainly the most adapted and the simplest method to study the  
64 degradation of the solvent. Nevertheless, a lot of degradation products are volatile and it is  
65 necessary to consider also gas effluents. Indeed, gas pollutions may have negative impacts on  
66 operator but also on the environment (nature or closed population). Environmental acceptance  
67 cannot be achieved without a thorough knowledge of all process effluents, gas or liquid, and  
68 eventually, adapted cleaning processes. Thus, in this work a complete study of all the effluents of a  
69 pilot plant was done during a dedicated campaign. This work exposes a global analytical  
70 methodology which can be adapted to the monitoring of any process with any solvent. Especially, a  
71 new sampling method based on solid sorbents was developed to identify trace compounds present in  
72 gaseous effluents.

## 73 **Material and Methods**

### 74 **Chemicals**

75 N,N'-(Bishydroxyethyl)oxalamide (**BHEOX**), N-(2-hydroxyethyl)acetamide (**HEA**) (90 %), N-(2-  
76 hydroxyethyl)formamide (**HEF**) (97 %), , 2-methyloxazoline (≥ 99 %) and 3-methylpyridine (99 %) were  
77 purchased from Alfa Aesar (Schiltigheim, France). Glycolic acid, potassium acetate, sodium formate,  
78 sodium propionate, sodium nitrite, magnesium sulphate, oxalic acid, lithium nitrate, potassium  
79 hydroxide, formic acid, formaldehyde (37%), dimethylamine solution (40 wt%), acetamide (99%),  
80 acetic acid (>99.7%), ethyleneglycol (**EG**) (99.8%), 1H pyrrole (98%), N,N-dimethylformamide (**DMF**)  
81 (99.8%), pyrazine (>99%), 2-oxazolidinone (**OZD**) (98%), 2-methylpyrazine (**2MP**) (>99%),  
82 diethyleneglycol (**DEG**) (>99%), triethyleneglycol (**TEG**) (>99%), 2-ethylpyrazine (>98%), 2,3-  
83 dimethylpyrazine (>95%), N-hydroxyethylimidazole (**HEI**) (97%), bicine, N-(2-  
84 hydroxyethyl)ethylenediamine (**HEEDA**), N,N-bis-2-(hydroxyethyl)ethylenediamine (**BHEEDA**) (97%),  
85 N-(2-hydroxyethyl)imidazolidin-2-one (**HEIA**), diethanolamine (**DEA**) (>98%), 2,5-dimethylpyrazine  
86 (>98%), ethanolamine (**MEA**) (98 %), N-nitrosodimethylamine (**NDMA**), N-nitrosodiethanolamine  
87 (**NDELA**), N-Nitroso-N,N-diethylamine (**NDEA**) and N-nitrosomorpholine (**NMOR**) were purchased  
88 from Sigma-Aldrich (Saint Quentin Fallavier, France). Oxazoline (96 %) was purchased from Interchim  
89 (France). 4-(2-hydroxyethyl)piperazin-2-one (**4HEPO**) and N-(2-hydroxyethyl)pyrrole (**HEPyr**) (99 %)  
90 were purchased from Tygersci (Hopkinsville, USA). N-(2-hydroxyethyl)glycine (**HEGly**) (95 %) was

91 purchased from Enamine (Kiev, Ukraine). Glycine (99.7 %) was purchased from Merck (Lyon, France).  
 92 Oxazolidine was purchased from Selectlab (Münster, Germany). 2,6-dimethylpyrazine, 2-ethyl-6-  
 93 methylpyrazine, 2-ethyl-5-methylpyrazine and 2-ethyl-3-methylpyrazine were purchased from SAFC  
 94 (Sigma-Aldrich, Saint Quentin Fallavier, France). N,N'-Bis-(2-hydroxyethyl)urea (**BHEU**) was purchased  
 95 from Chemos GMBH (Regenstauf, Germany). 1-(2-Hydroxyethyl)piperazinone hydrochloride (**1HEPO**)  
 96 was purchased from Ukrorgsyntez (Kiev, Ukraine). Methanol, acetonitrile and ethylacetate were  
 97 purchased from Carlo-Erba (Val de Reuil, France).

98 Ultra-pure water was produced using a Direct-Q UV 3 system (18.2 MΩ.cm) from Millipore  
 99 (Molsheim, France).

100 N-nitroso-2-methyl-oxazolidine was synthesized according to the protocol of Saavedra (Saavedra,  
 101 1981). N,N'-bis(2-hydroxyethyl)piperazin-2,5-dione (**2,5-BHEPDO**) and 2-methyloxazolidine were  
 102 synthesized according to Gouedard *et Al.* (Gouedard, 2014).

103 **Pilot plant description**

104 IFPEN pilot plant uses two columns of around 1 meter each with a diameter of 5 cm. The first one is  
 105 used as an absorber (C10) where the solvent (30 % wt of MEA in water) is loaded in CO<sub>2</sub> (Figure 1).  
 106 The second column is used as a stripper (C20) where the solvent is regenerated and CO<sub>2</sub> is released.  
 107 Each column is equipped with high performance packings for ensuring good gas/liquid mass transfer:  
 108 The absorber contains DX packing and the stripper contains BX packing.

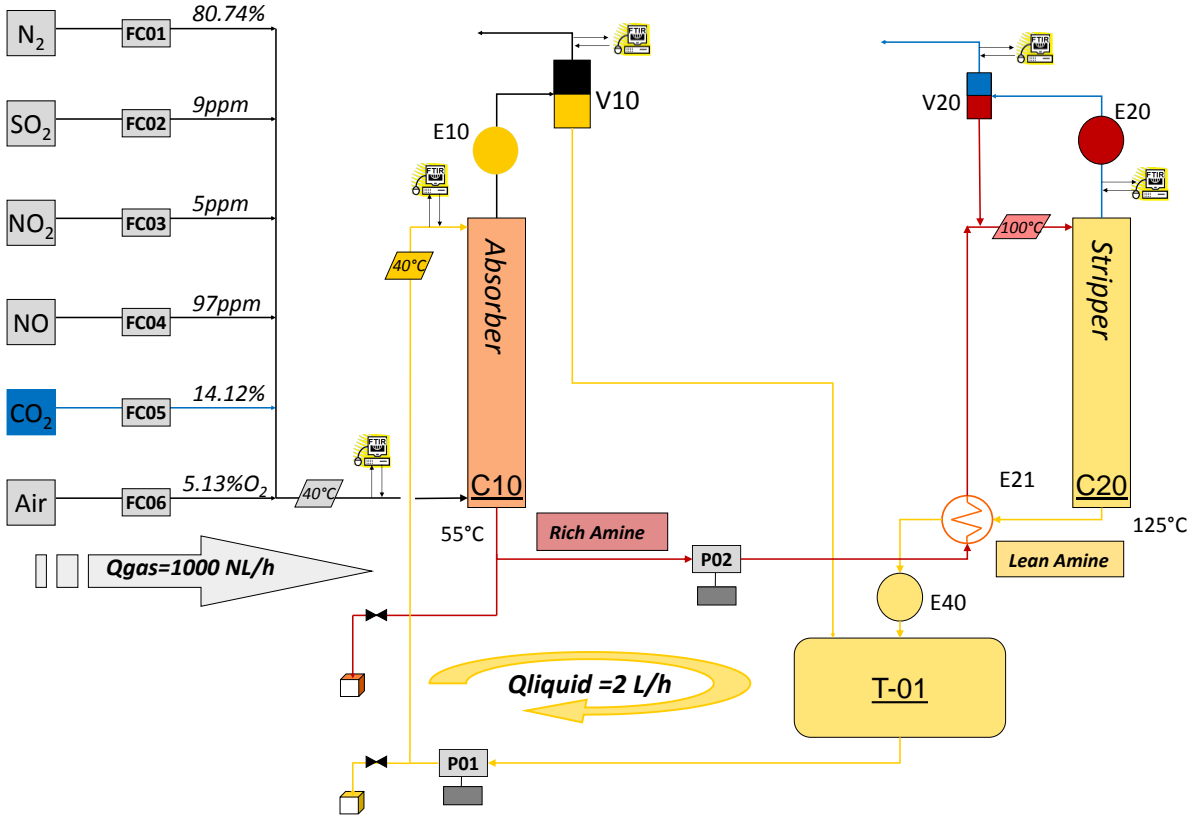

Figure 1. Scheme of IFPEN pilot plant

109  
 110  
 111 The campaign lasted around 1700 hours. Synthetic flue gas contained 80.7% of N<sub>2</sub>, 14.1% of CO<sub>2</sub>, 5.1  
 112 % of O<sub>2</sub>, 97 ppm of NO, 9 ppm of SO<sub>2</sub> and 5 ppm of NO<sub>2</sub>. Total absolute pressure of the absorber was  
 113 1,2 bar. The gas flow rate was 1000 NL/h at 40°C and the solvent flow rate was 2 L/h. The total

114 volume of solvent was 20 liters. Absorber outlet gas was directed to a heat exchanger (E10) to  
115 condensate water. Condensates was separated from gas phase in separator V10. Heat exchanger E10  
116 followed by separator V10 may be considered as a low efficiency water wash section: E10 cooling  
117 liquid temperature is 4°C and E10 outlet gas temperature is 15°C enabling large amount of water  
118 condensation and therefore partial MEA and degradation products dissolution. V10 condensates was  
119 mixed with CO<sub>2</sub> lean amine in tank T-01. Once loaded with CO<sub>2</sub>, CO<sub>2</sub> rich amine was pumped with P02  
120 and heated at 100°C in charge/effluent exchanger E21 before entering at the top of the stripper. The  
121 stripper was heated at 125°C which enabled the regeneration of the amine and the release of CO<sub>2</sub>.  
122 Released CO<sub>2</sub> was directed to a heat exchanger (E20) to condensate water. The condensate was  
123 separated in separator V20 and was reintroduced at the top of the stripper with the CO<sub>2</sub> rich amine.  
124 At the bottom of the stripper, the CO<sub>2</sub> lean amine was cooled in charge/effluent exchanger E21 then  
125 in exchanger E40 to be introduced in tank T-01 at a temperature close to room temperature. CO<sub>2</sub>  
126 lean amine is pumped from T-01 with P01 and heated at 40°C to be introduced at the top of  
127 absorber. MEA concentration was maintained between 30 and 35 % wt during the campaign by  
128 water addition in tank T-01. At the end of the campaign, concentrations of Iron, Nickel and  
129 Chromium, measured by Inductively Coupled Plasma with Optical Emission Spectroscopy (ICP-OES)  
130 were less than 5 mg/kg. Thus, corrosion was assumed negligible.

## 131 Analysis

### 132 Ionic chromatography

133 Ion chromatography was commonly used to quantify acids in their anionic form: glycolate, formate,  
134 acetate, oxalate, sulfate, nitrite, and nitrate ions. The concentration of CO<sub>2</sub>-species (carbamate,  
135 carbonate and bicarbonate ions and carbonic acid) was also determined by Ionic Chromatography to  
136 determine CO<sub>2</sub> loading of amine given as mol CO<sub>2</sub>/mol MEA. Samples were diluted in ultrapure  
137 water. 25 µL of solution were injected twice on a Dionex ICS-3000 ion chromatograph (ThermoFisher  
138 Scientific, Villebon-sur-Yvette, France). The column was an AS-15 (4 × 250 mm). Eluent was aqueous  
139 KOH solution with a concentration gradient (from 8 to 60 mM) at a flow rate of 1 mL.min<sup>-1</sup>. Detector  
140 was a conductimeter. A run of 60 minutes enabled an optimal separation. Some samples were pre-  
141 treated with HNO<sub>3</sub> 69 % to reach a pH below 4 to eliminate MEA carbamate peak which overlaps  
142 acetate and glycolate peaks. Quantification of anions was obtained with an uncertainty of ± 10%.  
143 Quantification of CO<sub>2</sub> loading was obtained with an uncertainty of ± 15%.

### 144 LC-MS/MS

145 Analyses were performed on a LC Thermo Scientific Dionex Ultimate 3000 (Analytical Autosampler  
146 WPS-3000SL, Quaternary Analytical Pump LPG-3400SD) coupled with a MS Thermo Scientific TSQ  
147 Quantum Access MAX with HESI-II source (ThermoFisher Scientific, Villebon-sur-Yvette, France). It  
148 was used in positive mode, probe in position C, electrospray voltage of 2500V and capillary  
149 temperature of 200°C. The sheath gas was nitrogen at a flow rate of 40mL/min and the auxiliary gas  
150 at 8 mL/min. Chromatographic separations were conducted on a Thermo HyperCarb column (PGC)  
151 150 mm x 3 mm, 5 µm-particles (ThermoFisher Scientific, Villebon-sur-Yvette, France). The mobile  
152 phase was a mixture of (A) water with 0.1% formic acid and (B) methanol with 0.1% formic acid at a  
153 flow rate of 350µL/min. 5 µL of sample were injected. A pre-run rinse of 100% A for 8 min was  
154 performed, then the solvent gradient started at 100% of A for 10 min before reaching a ratio of 80:20  
155 (A:B v:v) in 8 min. This ratio was maintained for 12 min. Samples had to be at least 1000-fold diluted  
156 before injection to prevent the mass spectrometer from being polluted by MEA. The MRM

157 transitions of the targeted compounds used are given in supplementary material. They are reported  
158 from the literature or determined with standards. Quantification was obtained with an uncertainty of  
159  $\pm 20\%$ . Two internal standards were used: Diethanolamine-d8 for DEA, HEGly and BHEU, and Glycine-  
160 d5 for Glygly and Gly. Compounds quantification method and performances are detailed in our  
161 previous work (Cuzuel et al., 2014).

#### 162 **GC-FID**

163 MEA concentration was determined by GC-FID performed on Agilent HP6890 chromatograph (Agilent  
164 Technologies, Massy, France) with a carbowax amines column (15 m x 0.53 mm, 1  $\mu\text{m}$ ) made by  
165 Supelco (Sigma-Aldrich, Saint Quentin Fallavier, France) and with triethyleneglycol as internal  
166 standard. The oven program started at 100 °C then the temperature was raised at 8°C/min to 200 °C  
167 and held for 5 min. 1  $\mu\text{L}$  of the sample was injected in the inlet at 250°C and the split flow was 100  
168 mL/min. The Helium gas flow was 8mL/min with a top column pressure of 4.2 psi. Quantification was  
169 obtained with an uncertainty of  $\pm 5\%$ .

#### 170 **GC-MS**

171 Analyses were performed on an Agilent 7890A gas chromatograph coupled with an Agilent 5975C  
172 inert XL MSD mass spectrometer (Agilent Technologies, Massy, France). The device was equipped  
173 with a MPS (MultiPurpose Sampler) auto sampler from Gerstel (RIC, Saint-Priest, France) that  
174 enabled fully automated HS-SPME analyses. Two columns (Chromoptic, Villejust, France) were used  
175 to separate all the target compounds, a non-polar fused silica capillary column CP-SIL8 CB-MS (30 m x  
176 0.25 mm, 1 $\mu\text{m}$ ) and a polar fused silica capillary column DB-WAX (30 m x 0.25 mm, 0.5 $\mu\text{m}$ ). For the  
177 non-polar column, initial temperature was 40°C held for 2 min then raised to 130°C at 7°C/min,  
178 increased to 280°C at 13°C/min and held for 10 min. For the polar column, oven temperature  
179 program started at 40°C, held for 2 min then raised to 130°C at 7°C/min, then increased to 200°C at  
180 10°C/min and held for 7 min. In both cases, helium was used as carrier gas in constant flow mode at 1  
181 mL/min. The transfer line temperature to the MS detector was set at 280°C. For liquid injection  
182 procedures, real samples were diluted 10 times in methanol before injecting 1 $\mu\text{L}$  in split mode (1:5)  
183 at 250°C. Quantification of a selection of products was obtained with an uncertainty of  $\pm 15\%$ .

184 For thermodesorption of tubes, gas flow rate of helium was 40 mL/min in splitless mode. Initial  
185 temperature of desorption was 35°C held for 2 min then raised to 300°C at 120°C/min and held  
186 for 6 min. Desorbed molecules were cryofocused in the injector at -40°C with liquid CO<sub>2</sub>. Then  
187 temperature increased from - 40°C to 300°C at 12°C/s and the molecules were injected in the  
188 column in splitless mode. The same GC/MS method as for liquid samples was used.

189 Detection was performed with a mass spectrometer using electronic ionization (EI) or chemical  
190 ionization (CI) source. The latter was both used in positive (PCI) and negative (NCI) mode. The EI  
191 source (70 eV) was heated to 250°C, the scan range was 25 to 250 amu. As for the CI source, it was  
192 heated to 300°C for positive mode and to 150°C for negative mode, CH<sub>4</sub> was used as reactant gas and  
193 the scan range was 50 to 250 amu.

194 Some complementary analyses were also performed on a Thermo Finnigan Tempus (GC-TOF (Time of  
195 flight)/MS) (Thermo Finnigan, Villebon-sur-Yvette, France), which was used with CP-SIL8 CB-MS (30 m  
196 x 0.25 mm, 1  $\mu\text{m}$ ) (Chromoptic, Villejust, France). Initial temperature was 35°C then raised to 230°C  
197 at 3°C/min and held for 50 min. Helium was used as carrier gas in constant flow mode at 0.9 mL/min.  
198 The transfer line temperature to the MS detector was set at 250°C. Mass spectrometer was used  
199 with the EI source (70 eV) heated at 200°C. The scan range was 10 to 350 amu.

## 200 GC-HRMS

201 Analyses were performed on an Agilent 7890A gas chromatograph (Agilent Technologies, Massy,  
202 France) coupled with Autospec Premier mass spectrometer from Waters (Saint-Quentin-en-Yvelines,  
203 France). A capillary column DB5-MS (30m x 0.25 mm, 0.50  $\mu$ m) (Chromoptic, Villejust, France) was  
204 used to separate target compounds. Initial temperature was 35°C held for 4 min then raised to 150°C  
205 at 10°C/min, increased to 250°C at 20°C/min. Helium was used as carrier gas in constant flow mode  
206 at 1.5 mL/min. Inlet temperature was 230°C, the split ratio was 1: 5 and the volume injected was 0.8  
207  $\mu$ L. The transfer line temperature to the MS detector was set at 260°C. Detection was performed  
208 with a magnetic sector mass spectrometer using electronic ionization (EI) source in positive mode.  
209 The EI source (35 eV with trap 450 $\mu$ A) was heated to 250°C. The mass spectrometer was used in a  
210 Single Ion Recording mode (SIR) with a scan rate of 0.5 s, an interscan of 0.2 s and a resolution  
211 comprised between 5000 and 6000. The recording ion mass were  $m/z = 74.0480$  Th for NDMA and  
212  $m/z = 116.0590$  Th for NMOR.

## 213 Head Space –SPME

214 For Head Space – SPME (HS-SPME) procedures, the volume of sample introduced in the 20 mL HS vial  
215 was 5 mL. The fully automated HS-SPME procedure was as follows. First, the vial was equilibrated at  
216 70°C during 5 min then the 75  $\mu$ m Carboxen/PDMS fibre SPME, obtained from Supelco (Sigma-  
217 Aldrich, Saint Quentin Fallavier, France) was placed into the head-space of the sample for the  
218 extraction, still maintained at 70°C for 30 min. At the end of the extraction, the fibre was desorbed  
219 directly in the injector set of the GC/MS at 250°C in split mode (1:5). This method was initially  
220 developed for identification and quantification of pyrazines (Rey et al., 2013). It is adapted here to  
221 the identification of other degradation products present in liquid phase.

## 222 FT-IR

223 A FT-IR disposal provided by GASMET (SISTEC, Vienne, France) was used to monitor different gas  
224 effluents (see the computer symbols on Figure 1). It enabled the monitoring of several products in  
225 gas phase, especially ammonia, CO<sub>2</sub>, NO, NO<sub>2</sub> and SO<sub>2</sub>. Limit of Detection (LOD) and uncertainties  
226 were determined by the equipment provider. The uncertainty is 2 % of the full scale. Used range and  
227 LOD are given in Table 1.

228

Table 1: Range and LOD values of FTIR analysis

| Gas             | Range (molar) | LOD     |
|-----------------|---------------|---------|
| NH <sub>3</sub> | 0-4000 ppm    | 0,3 ppm |
| CO <sub>2</sub> | 0-100 %       | 200 ppm |
| SO <sub>2</sub> | 0-10000 ppm   | 1 ppm   |
| NO              | 0-2500 ppm    | 4 ppm   |
| NO <sub>2</sub> | 0-200 ppm     | 1 ppm   |

## 229 Gas sampling

230 Gas sampling was performed to analyze degradation products which were not observed by FT-IR.  
231 Solid phase extraction (SPE) of gaseous compounds was performed during 1 or 19 hours in function  
232 of solid adsorbent type. During gas sampling, the gas flow in the absorber was reduced to 500 NL/h  
233 and the solvent flow was reduced to 1 L/h. Gas samplings have been done after the separator V10  
234 every two weeks and once after the separator V20 at the end of the campaign.



### 235 **Assisted Liquid-Liquid Extraction (ALLE)**

236 An original sample handling approach using assisted liquid-liquid extraction on diatomaceous earth  
237 cartridges (ChemElut) (Agilent Technologies, Massy, France) allowed to extract selectively  
238 nitrosamines from samples. This extraction on solid matrix allowed to eliminate a large amount of  
239 MEA and thus enhanced the extraction of nitrosamines (improvement in sensitivity of an order 5 to  
240 10). 2 mL of phosphate buffer (pH = 7.4) were mixed with 1 mL of sample. This mixture was adsorbed  
241 during 5 min on ChemElut (3mL). Then, elution was performed with 9 mL of ethyl acetate. Solution  
242 was smoothly evaporated with the help of a nitrogen flux gas to 0.25 mL and redissolved in 100  $\mu$ L of  
243 ultrapure water. Sample were then directly analyzed with LC-MS/MS.

### 244 **Solid phase extractions (SPE)**

245 A device enabling simultaneous adsorption on four different solid phase extraction tubes was  
246 implemented on outlet gas lines after V10 and V20. After V10 and V20, gas temperature (15°C) was  
247 below room temperature avoiding any water condensation in tubes. Gas flow rate was regulated  
248 with a flow meter in order to respect the maximum flow rate specified by tubes suppliers. For each  
249 adsorbent type, three tubes were used in series to enable quantification of the retained products in  
250 case of saturation or piercing of the two first tubes. The sampling conditions are given in Table 2.

251 **Table 2: Sampling conditions and SPE tubes according to target compounds**

| Target Compounds      | Tubes References          | Gas flow (NL/h) | Sampling time (h) |
|-----------------------|---------------------------|-----------------|-------------------|
| Aldehydes and ketones | Sep-Pak <sup>®</sup> DNPH | 6               | 1                 |
| Nitrosamines          | ORBO 60                   | 10              | 19                |
| Volatile compounds    | Tenax TA TDU              | 6               | 1                 |
| Volatile compounds    | Activated charcoal        | 6               | 1                 |

252

253 Sep-Pak<sup>®</sup> tubes (Sigma-Aldrich, Saint Quentin Fallavier, France) containing 2,4-  
254 Dinitrophénylhydrazine (DNPH) were analyzed by the French institute INERIS (Verneuil-en-Halatte,  
255 France). Sep-Pak<sup>®</sup> tubes were chemically desorbed with 2 mL of acetonitrile and products were  
256 analyzed by High Performance Liquid Chromatography (HPLC) with diode array detector (DAD).  
257 Aldehydes were quantified by external calibration according to the method INRS Métropol 001.  
258 Excepted for formaldehyde, all aldehydes were absorbed at more than 99% in the first tube.  
259 Quantification was obtained with an uncertainty of  $\pm 30\%$ .

260 Thermosorb/N are the best sorbents to analyze nitrosamines because they are free of artifacts  
261 formation (Roundbehrer et al., 1980). However, these sorbents were not available for our study.  
262 Therefore ORBO 60 tubes were used. They contain a Florisil phase (Sigma-Aldrich, Saint Quentin  
263 Fallavier, France) which is particularly efficient to adsorb nitrosamines and especially NDMA which is  
264 one of the most volatile and one of the most carcinogenic nitrosamine potentially present in CCS gas  
265 effluents. Florisil sorbent are known to form slightly NDMA artifacts (Roundbehrer et al., 1980). In  
266 this study, only NDMA was quantified. Orbo 60 tubes were chemically desorbed twice with 2 mL of  
267 ethylacetate. Results showed that 2mL were sufficient to elute more than 95% of NDMA. NDMA was  
268 quantified by GC/HRMS. NDMA was adsorbed at more than 90% in the first tube.

269 Tenax TA TDU tubes (Gerstel, Saint-Priest, France) were thermally desorbed. Tenax is a porous  
270 polymer widely used as an adsorbent in both air collection and purge and trap applications. Its



271 structure provides alternate adsorption/desorption of a wide variety of compounds. Quantification  
 272 of a selection of products was obtained with an uncertainty of  $\pm 30\%$ .  
 273 Activated charcoal tubes (Gerstel, Saint-Priest, France) were used as non-specific adsorbent such as  
 274 Tenax TA TDU tubes. The large surface area of this carbon form enables excellent  
 275 adsorption/desorption of a wide variety of volatile compounds. The activated charcoal tubes were  
 276 also thermally desorbed. Tenax TA TDU tubes enabled to adsorb larger amounts of products but  
 277 activated charcoal tubes were useful to confirm (or infirm) punctually the presence of some volatile  
 278 compounds observed with Tenax tubes. Indeed, some products detected on Tenax might be due only  
 279 to the degradation of the Tenax phase in gas effluent conditions and it was necessary to be able to  
 280 cross the results between the two different adsorbent phases.

## 281 Results and Discussion

### 282 Pilot plant monitoring

283 Gas online FTIR analyses enabled to study the composition of the gas, in terms of major compounds,  
 284 at the different point of the pilot plant Table 3 gives CO<sub>2</sub>, SO<sub>2</sub>, NO and NO<sub>2</sub> concentrations at the inlet  
 285 and outlet of absorber and stripper. NH<sub>3</sub> concentration was between 10 and 20 ppm vol at C10 exit  
 286 during the whole campaign.

287 **Table 3: Gas composition in C10 and C20 outlet gases after condensation step (LOD: Limit Of Detection).**

| Gas             | Inlet C10 | Exit C10 dry gas  | Exit C20 dry gas |
|-----------------|-----------|-------------------|------------------|
| CO <sub>2</sub> | 14,1 %    | 6,5 %             | 99,99 %          |
| SO <sub>2</sub> | 9 ppm     | 2 ppm             | < LOD            |
| NO <sub>2</sub> | 5 ppm     | < LOD             | < LOD            |
| NO              | 97 ppm    | 83 ppm            | 50 ppm           |
| O <sub>2</sub>  | 5,1 %     | 5,1 %             | Not analyzed     |
| N <sub>2</sub>  | 80,7%     | 88 % (calculated) | -                |

288  
 289 Based on the total inlet flow rate and assuming that nitrogen did not absorb and that O<sub>2</sub>  
 290 consumption was negligible, CO<sub>2</sub> capture yield was around 60 % which corresponds to 282 kg of CO<sub>2</sub>  
 291 treated in around 1700 hours. Solvent sampling was done three times a week at the bottom of the  
 292 absorber (C10) for the CO<sub>2</sub> rich amine and in the tank T-01 for the CO<sub>2</sub> lean amine. All samples were  
 293 stored in brown flaks between 4 and 8°C. The campaign monitoring consisted in analyzing the  
 294 concentrations of MEA, CO<sub>2</sub>-species and anions. The concentration of MEA was determined by GC-  
 295 FID enabling also an estimation of water loss (Figure 2). The pilot lost approximately 1,5 L of water  
 296 per week in V10 and V20 outlet gases. Water loss was compensated by water addition (Figure 2).  
 297 14,4 kg of water were added during the campaign. Some MEA was lost also because of sampling.  
 298 Initially 20 kg of 30% wt MEA in water was introduced in the pilot plant. 1,3 kg of 30 % wt MEA  
 299 solution were therefore added during the campaign. MEA concentration was then maintained  
 300 between 30% and 35% wt during the whole campaign. The concentration of CO<sub>2</sub>-species (carbamate,  
 301 carbonate and bicarbonate ions and carbonic acid) was determined by Ionic Chromatography to  
 302 determine CO<sub>2</sub> loading of amine given as mol CO<sub>2</sub>/ mol MEA. CO<sub>2</sub> loading was close to 0,3 for CO<sub>2</sub>  
 303 lean amine and 0,5 for CO<sub>2</sub> rich amine in stationary conditions (Figure 3). The concentration of

304 formate, acetate, oxalate, glycolate, propionate, nitrite, nitrate and sulfate (heat stable salts) was  
305 determined by ionic chromatography.

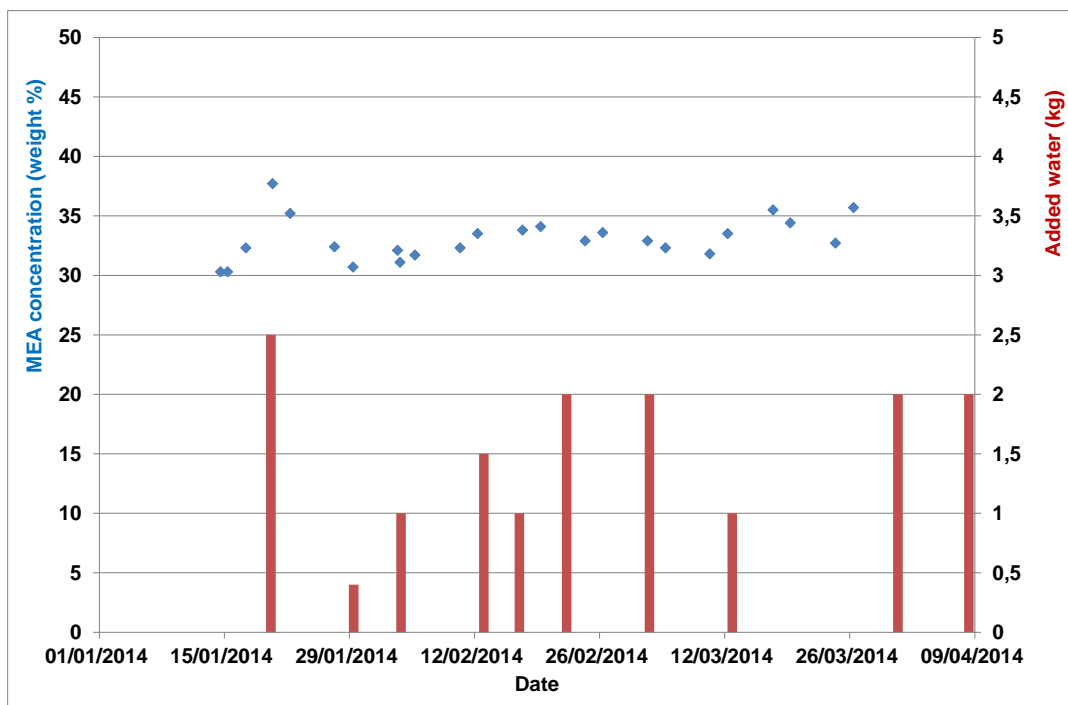

306

307

Figure 2. Evolution of MEA concentration in T01 (CO<sub>2</sub> lean amine) and added water quantities

308 Figure 3 shows that CO<sub>2</sub> loading in the solvent at the exit of absorber and stripper was quite stable at  
309 roughly 0,5 and 0,3 mol/mol respectively.

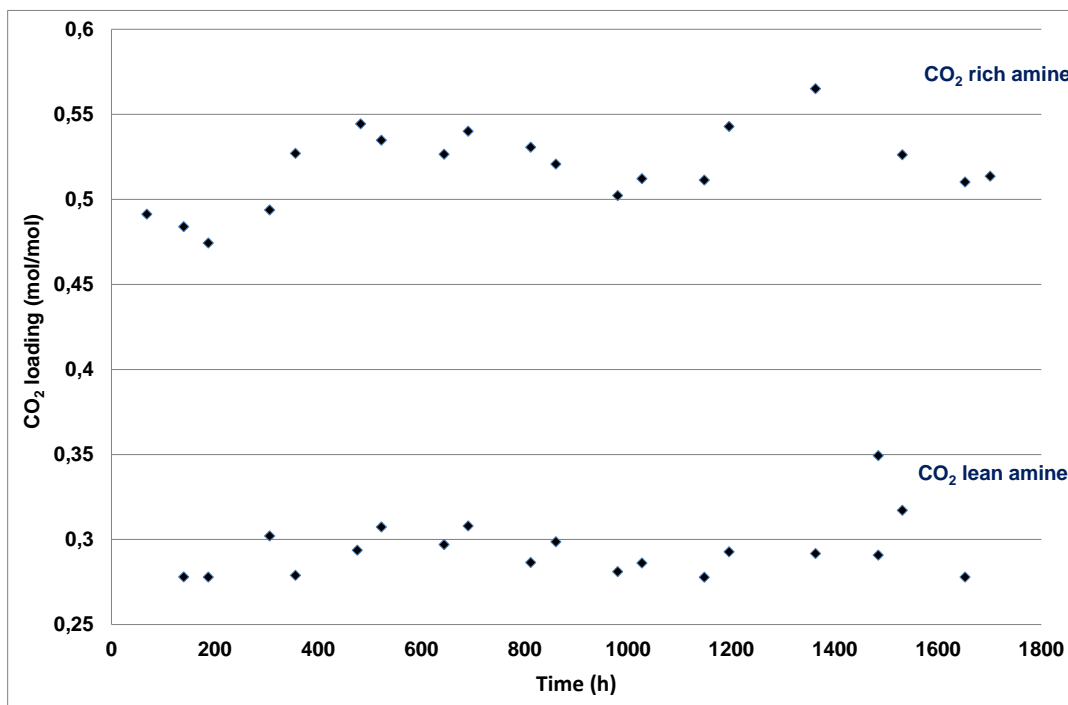

310

311

Figure 3. Evolution of CO<sub>2</sub> loading in CO<sub>2</sub> lean amine and in CO<sub>2</sub> rich amine

312 Two kinds of heat stable salts (HSS) were formed: the ones due to flue gas impurities such as NO<sub>2</sub> or  
 313 SO<sub>2</sub> and the organic ones due to solvent oxidative degradation. Figure 4 shows the evolution of  
 314 nitrates, nitrites and sulfates during the campaign.

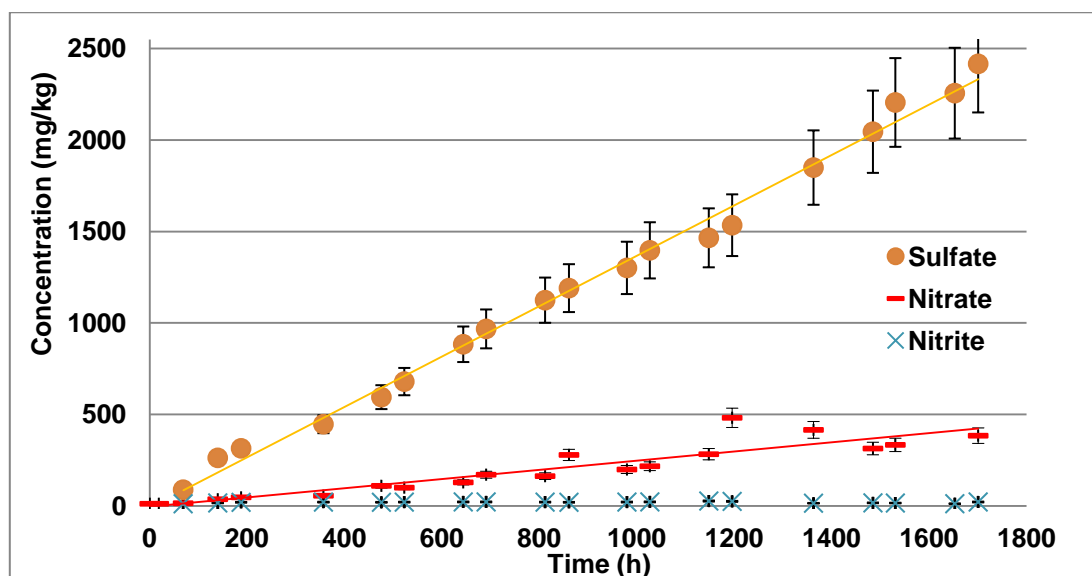

315

316

Figure 4. Evolution of nitrates, nitrites and sulfates

317 The evolution of sulfates was almost linear from the beginning to the end of the campaign as  
 318 expected. The concentration of sulfates reached 2416 mg/kg in 1701 hours. It means that 94 % of the  
 319 total amount of injected SO<sub>2</sub> gave sulfates if SO<sub>2</sub> concentration at absorber exit is taken equal to 2  
 320 ppm mol which is the detection limit of FTIR. Nitrites concentration was quite constant at around 19  
 321 ppm from 69 to 1701 hours which may indicate that nitrites are some kind of intermediates. They  
 322 were formed and consumed throughout the campaign, mainly due to their oxidation into nitrates  
 323 which reached 383 mg/kg at 1701 hours. Nitrates and nitrites are mainly due to the presence of NO<sub>2</sub>  
 324 and NO in flue gas but they may also be a resultant of MEA degradation. Table 4 gives the mass  
 325 balance between NO<sub>2</sub>/NO absorbed in solvent based on FTIR results and nitrates/nitrites  
 326 accumulation in the solvent at the middle and at the end of the campaign.

327 Table 4: Comparison of concentration of products formed from introduced NO<sub>x</sub> with nitrates and nitrites concentration

| Time (h) | Calculated concentration of products formed from introduced NO <sub>x</sub> (mol/kg) | Total concentration of analyzed nitrates and nitrites (mol/kg) | Ratio |
|----------|--|--|-------|
| 836      | 4,12E-02   | 4,23 ± 0,4 E-02  | 1,0   |
| 1701     | 8,39E-02   | 1,45 ± 0,15 E-01   | 1,7   |

328

329 In the middle of the campaign measured nitrites/nitrates are close to NO<sub>2</sub>/NO absorption. But at the  
 330 end of the campaign, the amount of nitrites/nitrates exceeds NO<sub>2</sub>/NO absorption because the  
 331 proportion due to MEA degradation increased. On the other hand, they may be also consumed to  
 332 form other degradation products like nitrosamines but this contribution is less important.

333 A quantitative monitoring of organic HSS was focused on formates, glycolates and oxalates (Figure 5).

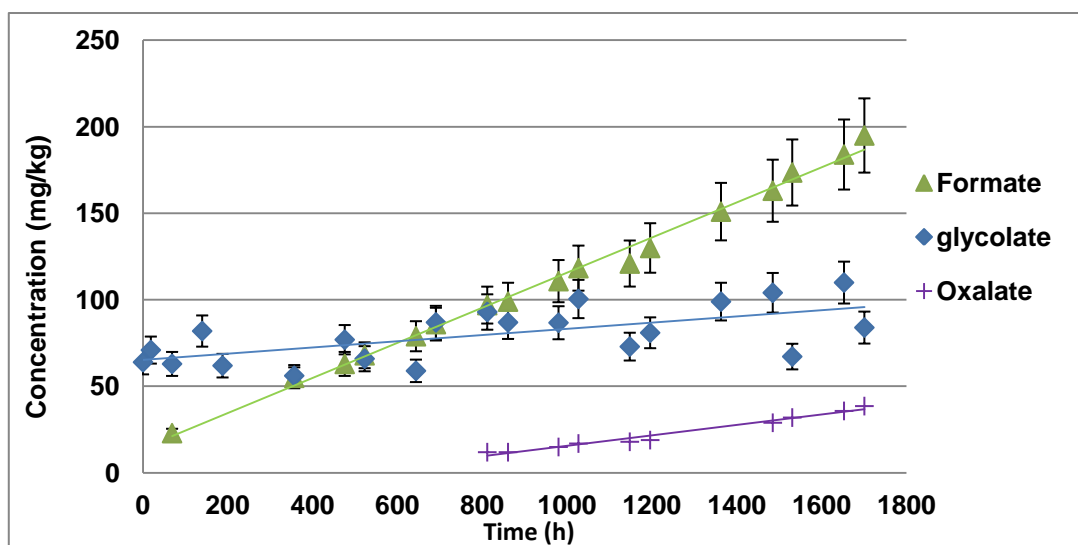

334

335

Figure 5. Evolution of formates, glycolates and oxalates

336 Evolution of formates was almost linear and the concentration reached 195 mg/kg at 1701 hours. It is  
 337 the main organic acid formed by MEA degradation as expected (Vevelstad et al., 2013). Glycolates  
 338 were already present in supplied MEA and their concentration fluctuated between 60 and 100 mg/kg  
 339 during the campaign without significant evolution. Organic acids are known to be starting material of  
 340 many degradation products (Gouedard et al., 2012) which may explain such a constant  
 341 concentration. On the other hand, oxalates concentration was lower than the limit of quantification  
 342 of the analytical method until 812 hours and reached 39 mg/kg at 1701 hours. Expected acetates and  
 343 propionates (Cuzuel et al., 2015) have not been detected at all during this campaign. Acetates are  
 344 assumed to have mainly reacted with MEA to form N-(2-hydroxyethylacetamid (HEA) (see table 4).  
 345 On the other hand propionic acid was not present neither as propionate nor as N-(2-  
 346 hydroxyethylpropanamide). In our previous work (Cuzuel et al., 2015) both were observed but MEA  
 347 was more concentrated than in the present work: 40% wt instead of 30% wt. Therefore, in present  
 348 work, degradation is slower and they might be detectable after a longer running time.

349

### 350 Degradation products in the solvent

351 Organic products identified in the solvent throughout the campaign are given in Table 5. The main  
 352 degradation products described in our previous paper (Cuzuel et al., 2015) were observed here.  
 353 Nevertheless, our previous pilot plant campaign was done with 40% wt MEA enabling higher  
 354 concentrations of degradation products. That is why less degradation products were observed in this  
 355 work but all should be observed after a longer running time. Each degradation product identification  
 356 was confirmed by corresponding standard analysis and a mechanism of formation was proposed for  
 357 each one (Gouedard et al., 2014a; Gouedard, 2014b; Rey et al., 2013). For each identified molecule,  
 358 the corresponding standard was purchased or synthesized. Identification was confirmed by obtaining  
 359 the same mass or NMR spectrum.

Table 5: Degradation products detected in the solvent

|  |          |            | Analysis methods |       |         |          |            |
|--|----------|------------|------------------|-------|---------|----------|------------|
|  |          |            | GC-MS TOF        | GC-MS |         | LC-MS-MS | GC-HRMS    |
| Specific sample treatment →                              |          |            | ∅                | ∅     | HS-SPME | ∅        | Extraction |
| Products   | Mw g/mol | CAS        |                  |       |         |          |            |
| Ethyleneglycol (EG)                                      | 62       | 107-21-1   |                  | X     |         |          |            |
| 1H-Pyrrole   | 67       | 109-97-7   |                  |       | X       |          |            |
| Oxazoline  | 71       | 504-77-8   |                  |       | X       |          |            |
| Oxazolidine  | 73       | 504-76-7   |                  | X     | X       | X        |            |
| N-nitrosodimethylamine (NDMA)                            | 74       | 62-75-9    |                  |       |         |          | X          |
| Glycine  | 75       | 56-40-6    |                  |       |         | X        |            |
| Pyrazine   | 80       | 290-37-9   | X                |       | X (*)   |          |            |
| 2-Methyloxazoline  | 85       | 1120-64-5  | X                |       |         |          |            |
| 2-Oxazolidinone (OZD)                                    | 87       | 497-25-6   | X                | X     | X (*)   |          |            |
| N-(2-hydroxyethyl)formamide (HEF)                        | 89       | 693-06-1   | X                | X     |         |          |            |
| 2-Methylpyrazine (2MP)                                   | 94       | 109-08-0   |                  |       | X (*)   |          |            |
| N-(2-hydroxyethyl) acetamide (HEA)                       | 103      | 142-26-7   |                  | X     |         |          |            |
| N-(2-hydroxyethyl) ethylenediamine (HEEDA)               | 104      | 111-41-1   |                  | X     |         | X        |            |
| Diethanolamine (DEA)                                     | 105      | 111-42-2   |                  |       |         | X        |            |
| 2,5-dimethylpyrazine                                     | 108      | 123-32-0   |                  |       | X       |          |            |
| 2-ethylpyrazine  | 108      | 13925-00-3 |                  |       | X       |          |            |
| N-(2-hydroxyethyl)pyrrole (HEPyr)                        | 111      | 6719-02-4  |                  |       | X       |          |            |
| N-(2-hydroxyethyl)imidazole (HEI)                        | 112      | 3699-54-5  |                  | X     |         |          |            |
| N-nitrosomorpholine                                      | 116      | 59-89-2    |                  |       |         |          | X          |
| N-(2-hydroxyethyl)glycine (HEGly)                        | 119      | 5835-28-9  |                  |       |         | X        |            |
| 2-ethyl-6-methylpyrazine                                 | 122      | 36731-41-6 |                  |       | X       |          |            |
| 2-ethyl-5-methylpyrazine                                 | 122      | 236-416-6  |                  |       | X       |          |            |
| 2-ethyl-3-methylpyrazine                                 | 122      | 15707-23-0 |                  |       | X       |          |            |
| N-(2-hydroxyethyl)imidazolidin-2-one (HEIA)              | 130      | 3699-54-5  |                  |       |         | X        |            |
| N-nitrosodiethanolamine (NDELA)                          | 134      | 1116-54-7  |                  |       |         | X        |            |
| 1-(2-hydroxyethyl) piperazin-2-one (1HEPO)               | 144      | 59702-23-7 |                  | X     |         |          |            |
| 4-(2-hydroxyethyl) piperazin-2-one (4HEPO)               | 144      | 23936-04-1 | X                | X     |         |          |            |
| N,N'-bis(2-hydroxyethyl) ethylenediamine (BHEEDA)        | 148      | 3197-06-6  |                  |       |         | X        |            |
| N,N'-Bis-(2-hydroxyethyl)urea (BHEU)                     | 148      | 15438-70-7 |                  |       |         | X        |            |
| Bicine   | 163      | 150-25-4   |                  |       |         | X        |            |
| N,N'-(Bishydroxyethyl)oxalamide (BHEOX)                  | 176      | 1871-89-2  |                  | X     |         |          |            |
| N,N'-bis(2-hydroxyethyl)piperazin-2,5-dione (2,5-BHEPDO) | 202      | 23936-14-3 |                  | X     |         |          |            |

361 (\*) present in initial solution at lower concentration

362 Some of these products were present at a high enough concentration to monitor them quantitatively  
 363 during the campaign. Diethanolamine (DEA), N-(2-hydroxyethyl)glycine (HEGly) and N,N'-Bis-(2-  
 364 hydroxyethyl)urea (BHEU) were quantified by LC-MS-MS (Figure 6). Ethyleneglycol (EG), N-(2-

365 hydroxyethyl)formamide (HEF), N-(2-hydroxyethyl)acetamide (HEA) and oxazolidinone (OZD) were  
366 quantified by GC/MS (Figure 7). Their proportions were globally in agreement with state of art (da  
367 Silva et al., 2012; Vevelstadt et al., 2013). Nevertheless, there were some differences. HEgly was not  
368 the main degradation product in our case. The first reason is that this compound is an intermediate  
369 to some other degradation products (Gouedard, 2014b) whose formation may be conditions  
370 dependent. The second reason is that the main product in our case was BHEU which was never  
371 quantified by other authors to the best of our knowledge. Its formation may be explained by a  
372 reaction between MEA carbamate and MEA: nucleophilic attack of MEA amine function on  
373 carbamate carbonyl group as in the case of imidazolidinones formation which are cyclic ureas  
374 (Lepaumier et al., 2009a). The high concentration of both reagents may explain the high  
375 concentration of BHEU.

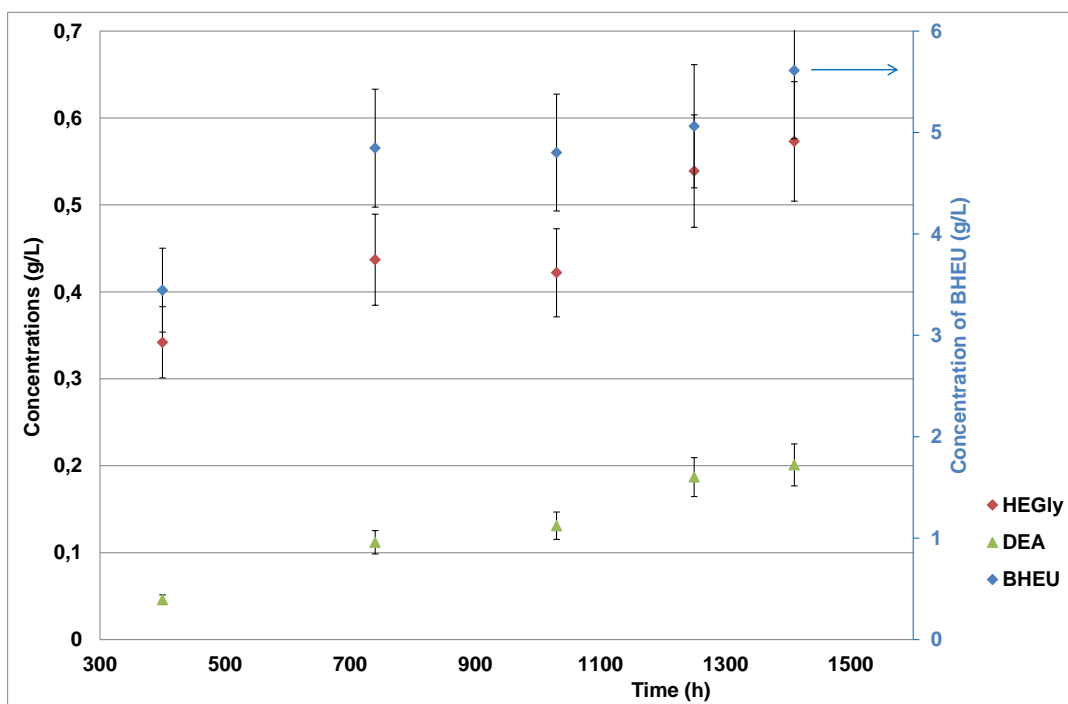

376

377

Figure 6. LC-MS-MS monitoring of DEA, HEGly and BHEU during the campaign.



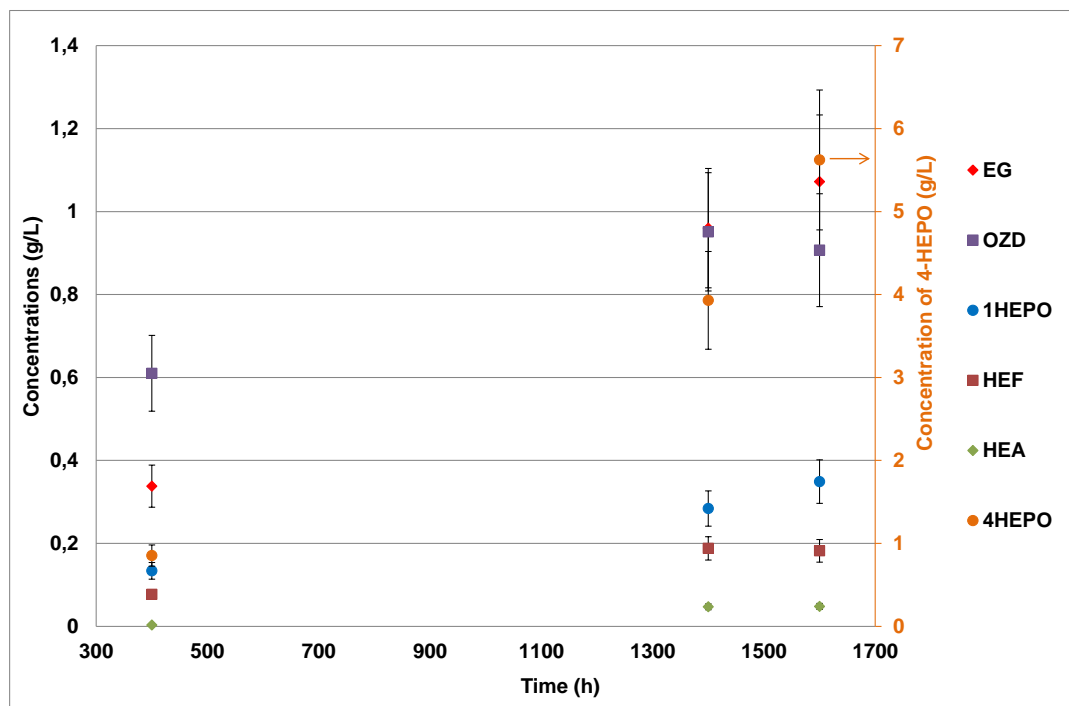

378

379

Figure 7. GC-MS monitoring of EG, HEF, HEA, 1HEPO, 4HEPO and OZD during the campaign

380 OZD concentration increased rapidly during the first 500 hours before reaching a kind of maximum at  
 381 0.9 g/L. OZD is an intermediate easily formed by carbamate cyclisation but it is also easily consumed  
 382 by reaction with nucleophilic compounds (Lepaumier et al., 2009c): it reacts especially with amine  
 383 functions of MEA and its degradation products. HEF was already present in supplied MEA at 0.2g/l  
 384 and kept quite constant during the campaign: it is formed from MEA and formic acid (Gouedard et  
 385 al., 2012) and is also an intermediate to other degradation products as oxazoline for example  
 386 (Gouedard et al., 2014a). On the contrary, 4HEPO started relatively slowly but seemed to increase  
 387 more rapidly after 1000 hours. Several mechanisms are proposed for 4HEPO formation (Gouedard,  
 388 2014b). In any case, starting material is a degradation product of MEA: HEEDA or HEGly. Therefore  
 389 their accumulation during the campaign may explain 4HEPO evolution. In this work 4HEPO  
 390 concentration was much higher than HEGly contrary to Da Silva et al. results (Da Silva et al., 2012)  
 391 suggesting that our conditions promoted HEGly consumption to form 4HEPO. 1HEPO was less  
 392 concentrated than 4HEPO because its formation is less favorable (Gouedard, 2014b).

393 Nitrosamines are the subject of a growing interest in the CCS literature due to their potential  
 394 carcinogenic properties. Three nitrosamines were identified in liquid phase in this work: N-  
 395 nitrosodiethanolamine (NDELA), N-nitrosomorpholine (NMOR) and N-nitrosodimethylamine (NDMA).  
 396 N-nitroso-HEGly observed by Morken et al. couldn't be confirmed here because the corresponding  
 397 standard couldn't be provided (Morken et al., 2014). Some other nitrosamines were only identified in  
 398 the gas phase as shown below. NDELA could not be quantified accurately by our method but its  
 399 concentration was definitely superior to our limit of detection 50 µg/kg. The NMOR was detected but  
 400 its concentration was inferior to our limit of quantification of 4 µg/kg. Finally, the concentration of  
 401 NDMA was determined in both CO<sub>2</sub> rich and CO<sub>2</sub> lean amine (Table 6).

402

Table 6: Concentration of NDMA in CO<sub>2</sub> lean and CO<sub>2</sub> rich amine determined by GC-HRMS

| Concentration of NDMA in µg/kg | 400 hours | 1400 hours |
|--------------------------------|-----------|------------|
| lean amine (T01)               | 317 ± 63  | 541 ± 108  |
| rich amine( C10)               | 265 ± 53  | 446 ± 89   |

403

404 Concentrations of NDMA in CO<sub>2</sub> rich and CO<sub>2</sub> lean amine are equivalent if higher loading of CO<sub>2</sub> in  
405 rich amine compared to lean amine (dilution of nitrosamine) and uncertainty of the method are  
406 taken into account. These concentrations are quite high comparing to other results in the literature  
407 (Einbu, 2013) and that could be due to the IFPEN pilot specifically. However, NDMA is known to be  
408 carcinogenic and volatile. Thus, the monitoring of the degradation products in the gas effluent in CCS  
409 plant is definitely needed.

### 410 **Degradation products in gas effluents**

411 The analysis of degradation products in gas effluent was based on different sampling methods using  
412 solid phase extraction. Tenax and activated charcoal adsorbents were used as non-selective  
413 adsorbents. Orbo 60 adsorbents were dedicated to the analysis of nitrosamines. Sep-Pak<sup>®</sup> tubes  
414 containing 2,4-Dinitrophenylhydrazine (DNPH) were used to adsorb aldehydes and ketones. These  
415 analytical campaigns were achieved on gas effluents after the condenser V10 of the absorber and  
416 after the condenser V20 of the stripper. Table 7 shows degradation products identified with Tenax,  
417 activated charcoal and Sep-Pak<sup>®</sup> tubes. Compounds written in bold are novel compounds which have  
418 never been detected in CCS literature so far to the best of our knowledge. Some of them were also  
419 identified in our previous work dedicated to liquid phase analysis (Cuzuel et al., 2015).

Table 7: Degradation products detected on Tenax, activated charcoal and Sep-Pak® tubes in gas effluents

| Products                              | CAS        | Mw (g/mol) | Absorber |                    |          | Stripper |          |
|---------------------------------------|------------|------------|----------|--------------------|----------|----------|----------|
|                                       |            |            | Tenax    | Activated charcoal | Sep-Pak® | Tenax    | Sep-Pak® |
| Formaldehyde                          | 50-00-0    | 30         |          |                    | X        |          | X        |
| Acetaldehyde                          | 75-07-7    | 44         | X        |                    | X        |          | X        |
| Dimethylamine                         | 124-40-3   | 45         | X        | X                  |          |          |          |
| Propionaldehyde                       | 123-38-6   | 58         |          |                    | X        |          | X        |
| <b>Acetamide</b>                      | 60-35-5    | 59         |          |                    |          | X        |          |
| Acetic acid                           | 64-19-7    | 60         | X        |                    |          |          |          |
| Ethyleneglycol (EG)                   | 107-21-1   | 62         | X        | X                  |          | X        |          |
| <b>1H-pyrrole</b>                     | 109-97-7   | 67         | X        | X                  |          | X        |          |
| 2-butenal                             | 4170-30-3  | 70         | X        |                    |          | X        |          |
| Oxazoline                             | 504-77-8   | 71         | X        | X                  |          |          |          |
| <b>Butyraldehyde</b>                  | 123-72-8   | 72         |          |                    |          |          | X        |
| <b>2-butanone</b>                     | 78-93-3    | 72         | X        | X                  |          | X        | X        |
| <b>N,N-dimethylformamide (DMF)</b>    | 68-12-2    | 73         | X        | X                  |          |          |          |
| <b>Oxazolidine</b>                    | 504-76-7   | 73         | X        | X                  |          | X        |          |
| Propionic acid                        | 79-09-4    | 74         | X        |                    |          |          |          |
| N-nitrosodimethylamine (NDMA)         | 62-75-9    | 74         | X        | X                  |          |          |          |
| Pyrazine                              | 290-37-9   | 80         | X        | X                  |          | X        |          |
| <b>2-methyloxazolidine</b>            | 16250-70-7 | 87         | X        |                    |          | X        |          |
| 2-oxazolidinone (OZD)                 | 497-26-6   | 87         | X        |                    |          | X        |          |
| <b>2-methylpyridine</b>               | 109-06-8   | 93         | X        |                    |          | X        |          |
| <b>3-methylpyridine</b>               | 108-99-6   | 93         | X        |                    |          | X        |          |
| 2-methylpyrazine (2MP)                | 109-08-0   | 94         | X        | X                  |          | X        |          |
| 2-ethyloxazolidine                    | 16250-71-8 | 101        | X        |                    |          | X        |          |
| <b>N-Nitrosodiethylamine</b>          | 62-75-9    | 102        | X        | X                  |          |          |          |
| Diethyleneglycol (DEG)                | 111-46-6   | 106        | X        |                    |          |          |          |
| <b>2-ethylpyridine</b>                | 100-71-0   | 107        |          |                    |          | X        |          |
| <b>2,3-dimethylpyridine</b>           | 583-61-9   | 107        |          |                    |          | X        |          |
| <b>3-ethylpyridine</b>                | 536-78-7   | 107        |          |                    |          | X        |          |
| 2,6-dimethylpyrazine                  | 108-50-9   | 108        | X        | X                  |          |          |          |
| 2-ethylpyrazine                       | 13925-00-3 | 108        | X        |                    |          |          |          |
| 2,3-dimethylpyrazine                  | 5910-89-4  | 108        | X        |                    |          | X        |          |
| N-(2-hydroxyethyl)pyrrole (HEPyr)     | 6719-02-4  | 111        | X        |                    |          |          |          |
| N-(2-hydroxyethylimidazole) (HEI)     | 3699-54-5  | 112        | X        |                    |          |          |          |
| <b>2-ethyl-2-methyloxazolidine</b>    | 17026-89-0 | 115        |          |                    |          | X        |          |
| <b>2-propyloxazolidine</b>            | 53019-51-5 | 115        |          |                    |          | X        |          |
| <b>N-nitroso-2-methyl-oxazolidine</b> | 39884-53-2 | 116        | X        |                    |          |          |          |
| <b>5-ethyl-2-methylpyridine</b>       | 104-90-5   | 121        |          |                    |          | X        |          |
| 2-ethyl-3-methylpyrazine              | 15707-23-0 | 122        |          |                    |          | X        |          |

422 Some volatile products observed in liquid phase (some pyrazines for example) were not detected in  
 423 gas phase because their concentration was likely too low. Nevertheless they must be considered as  
 424 potentially present in gas effluent of the pilot plant. On the other hand, several products were only  
 425 observed in gas phase: 2-butanone, DMF, oxazolidine, 2-methyloxazolidine, 2-methylpyridine, 3-  
 426 methylpyridine, N-nitrosodiethylamine, N-nitroso-2-methyl-oxazolidine and also acetamide,  
 427 butyraldehyde, 2-ethylpyridine, 2,3-dimethylpyridine, 3-ethylpyridine, 5-ethyl-2-methylpyridine, 2-  
 428 ethyl-2-methyloxazolidine and 2-propyloxazolidine only observed in stripper outlet gas. Two  
 429 explanations may be considered: matrix effect can prevent their observation in liquid phase and/or  
 430 they may be formed in gaseous phase. The latter may explain specific products formed in specific  
 431 conditions of stripper outlet gas (high CO<sub>2</sub> concentration and high temperature) unless their stripping  
 432 would be promoted by the higher temperature of stripper. Therefore, 38 degradation products were  
 433 identified in gas phase, 17 of which for the first time, especially derivatives of pyridine and  
 434 oxazolidine, 1H-pyrrole and a new nitrosamine, the N-nitroso-2-methyl-oxazolidine.  
 435 11 degradation products present in gas effluents were quantified in this work. Some aldehydes were  
 436 quantified in gas effluents with the help of DNPH Sep-Pak<sup>®</sup> tubes. 2 tubes were used in series.  
 437 Concentration profiles of these compounds in absorber outlet gas are given in Figure 8.

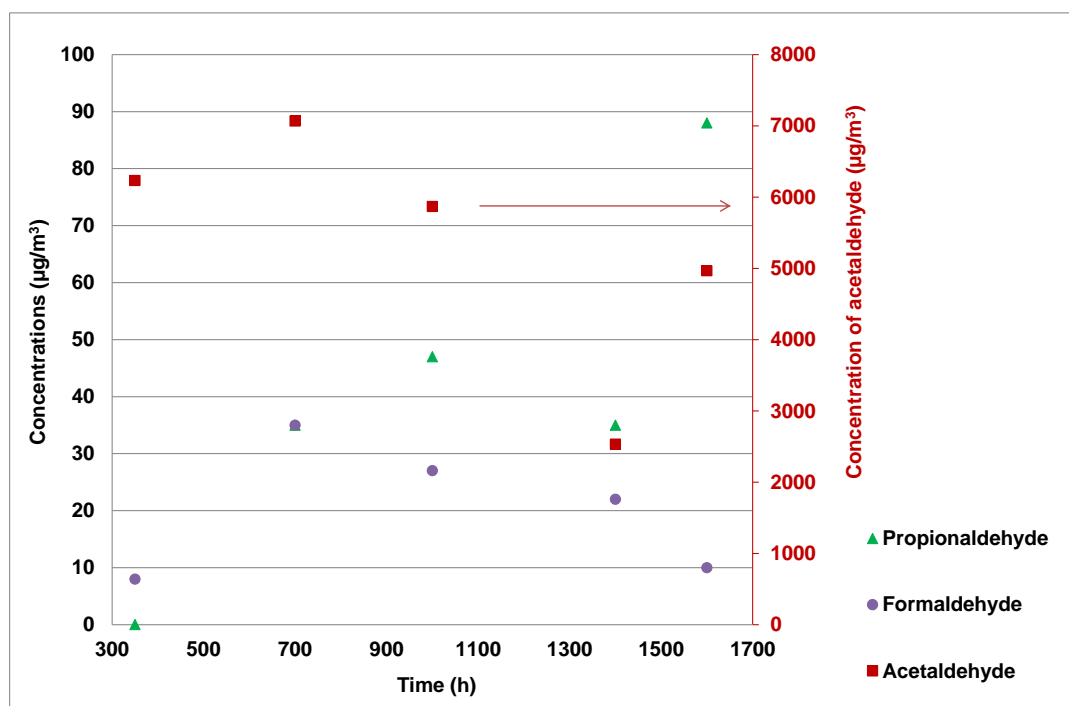

438

439

Figure 8. Quantification of aldehydes in absorber outlet gas.

440 The second tube contained some formaldehyde. Therefore, two consecutive tubes of Sep-Pak<sup>®</sup> with  
 441 DNPH were not sufficient to retain all the formaldehyde with a flow of 6 NL/h during 1 hour. Thus,  
 442 the quantification gave a minimum concentration of formaldehyde in gas effluent. Acetaldehyde was  
 443 the main aldehyde detected maybe because of the even higher reactivity of formaldehyde.  
 444 Propionaldehyde, likely formed from formaldehyde and acetaldehyde (Gouedard, 2014b) increased  
 445 slowly and remained at a low level. In stripper outlet gas, formaldehyde, acetaldehyde and  
 446 propionaldehyde were roughly one order of magnitude more concentrated than in absorber outlet  
 447 gas (Table 8). Two explanations may be considered: their formation is promoted by stripper  
 448 conditions and/or their stripping is promoted by the higher temperature of stripper.

Table 8: Concentrations of some aldehydes after 1600 hours in absorber and stripper outlet gases

| Aldehydes concentrations in g/L at 1600 h | Absorber | Stripper |
|---|----------|----------|
| Formaldehyde                              | 8        | 38       |
| Acetaldehyde                              | 4970     | 48000    |
| Propionaldehyde                           | 88       | 567      |

450

451 With the help of the Sep-Pak<sup>®</sup> DNPH tubes, it was also possible to detect the presence of butanone  
 452 and butyraldehyde in the stripper outlet gas exclusively. The concentrations of butanone and  
 453 butyraldehyde were both 40  $\mu\text{g}/\text{m}^3$ . However, neither traces of benzaldehyde nor linear carbonyl  
 454 compound (from five to eight carbons) were detected.

455 At the end of the campaign, three consecutive Tenax tubes were used to make a quantitative analysis  
 456 of ethyleneglycol (EG), pyrazine, 1H-pyrrole, dimethylformamide (DMF), 2-methylpyrazine (2MP), N-  
 457 nitrosodimethylamine (NDMA) and diethyleneglycol (DEG) in absorber outlet gas (Table 9).

458

Table 9: Concentration of a selection of degradation products in absorber gas effluent measured on Tenax tubes

| Adsorbed quantity (ng) | Molecular weight (g/mol) | Tube 1 | Tube 2 | Tube 3 | Total | Concentration in gas ( $\mu\text{g}/\text{m}^3$ ) |
|------------------------|--------------------------|--------|--------|--------|-------|---|
| EG                     | 62                       | 1469   | 851    | 193    | 2513  | 419   |
| Pyrrole                | 67                       | 60     | 16     | 8      | 84    | 14  |
| DMF                    | 73                       | 69     | 17     | 23     | 109   | 18  |
| NDMA                   | 74                       | 1000   | 397    | 187    | 1584  | 264   |
| Pyrazine               | 80                       | 850    | 203    | 53     | 1106  | 184   |
| 2MP                    | 94                       | 149    | 0      | 0      | 149   | 25  |
| DEG                    | 106                      | 114    | 57     | 0      | 171   | 29  |

459

460 For EG, pyrazine, pyrrole, NDMA and DMF, the third tube contained also these products which  
 461 means that three consecutive tubes of Tenax were not sufficient to adsorb all compounds with a flow  
 462 of 6 NL/h during 1 hour. However, the amount adsorbed on the third tube never exceeded 12% of  
 463 the total amount except in the case of DMF. The cases of DMF and NDMA are suspicious because  
 464 both of them are formed from dimethylamine. It is likely that dimethylamine reactions were still  
 465 going on in the gas phase. Dettmer and Engewald reported the formation of NDMA from  
 466 dimethylamine in the presence of nitrogen oxides on such tubes (Dettmer and Engewald, 2002).  
 467 Therefore concentrations of DMF and NDMA might be over evaluated, especially NDMA which  
 468 concentration was determined at much lower values by other techniques during the same pilot plant  
 469 campaign.

470 Orbo 60 tubes were used to quantify NDMA. At the end of the campaign, the analysis of the gas  
 471 effluent was done with two consecutive Orbo 60 tubes in absorber and stripper outlet gases: 75  
 472  $\mu\text{g}/\text{Nm}^3$  and 60  $\mu\text{g}/\text{Nm}^3$  respectively. On one hand the value for absorber outlet gas confirms that  
 473 value obtained with Tenax Tubes was over evaluated. On the other hand these values are one order  
 474 of magnitude higher than expected values considering NDMA in equilibrium with the liquid phase  
 475 (Table 10). Indeed, the concentration of NDMA measured in the solvent (Table 5) and the Henry's law

476 constant H of NDMA in water at 25°C ( $2.67 \times 10^{-7}$  atm m<sup>3</sup>/mol (EPA, 2008)) enable to calculate  
477 approximately NDMA concentration in gas phase (Table 9) by using the following equation:

$$P_i = P_t y_i = H_i C_i$$

478 **Table 10: Estimation of NDMA concentration in gas phase in equilibrium with liquid phase**

| Total pressure Pt (bara)                            | 1,2      | 400 hours | 1400 hours |
|---|----------|-----------|------------|
| Y <sub>NDMA</sub>                                   | absorber | 9,38E-10  | 1,60E-09   |
|   | stripper | 7,84E-10  | 1,32E-09   |
| C <sub>NDMA</sub> in gas phase (µg/m <sup>3</sup> ) | absorber | 3         | 5          |
|   | stripper | 2         | 4          |

479

480 Therefore, NDMA concentration values in gas phase should be considered with caution. The Tenax  
481 tubes enabled to detect in gas phase a novel nitrosamine: the N-nitroso-2-methyl-oxazolidine  
482 (NMOx). NMOx was detected by GC/MS on three different Tenax tubes and was certainly formed by  
483 nitrosation of 2-methyloxazolidine also detected on Tenax tubes. NMOx has been synthesized and  
484 used as a standard to confirm its presence in gas effluent (Gouedard, 2014b).

## 485 **Conclusion**

486 A pilot plant campaign was performed to study MEA degradation in CO<sub>2</sub> capture conditions. Specific  
487 methods were developed for sampling, sample conditioning and analysis of degradation products.  
488 This analytical methodology can be adapted to the monitoring of any process with any solvent,  
489 especially the new gaseous sampling method for trace compounds identification. The analysis of the  
490 liquid phase confirmed degradation products identified in our previous works. On the other hand,  
491 gas phase analysis went further than state of art enabling identification of 17 novel degradation  
492 products. In addition to pyrazines, highlighted in our previous work, several derivatives of pyridine  
493 and oxazolidine, 1H-pyrrole and a new nitrosamine, the N-nitroso-2-methyl-oxazolidine were  
494 identified here among some others. This is a very important point because these products may be  
495 emitted to the atmosphere. Nevertheless, the knowledge of their presence enables the development  
496 of adapted counter measures to avoid any risk for environment or human health.

## 497 **Acknowledgments**

498 We would like to acknowledge financial support from French ANR (Research Project DALMATIEN:  
499 Degradation of liquid amines and methods of analysis: toxicity or innocuousness for the  
500 environment?).

## 501 **References**

502 Carrette, P.-L., Lemaire, E., Raynal, L., 2013. How CO<sub>2</sub> capture cost could be reduced in short term?  
503 IFPEN solutions. L'Act. Chim., 371-372, 47-51.



504 Cuzuel, V., Dugay, J., Brunet, J., Rey, A., Vial, J., Pichon, V., Carrette, P.-L., 2014. Validation of a liquid  
505 chromatography tandem Mass spectrometry method for targeted degradation compounds of  
506 ethanolamine used in CO<sub>2</sub> capture: application to real samples. *Oil Gas Sci. Technol.* 69, 821–832.

507 Cuzuel, V., Gouedard, C., Cucia, L., Brunet, J., Rey, A., Dugay, J., Vial, J., Perbost-Prigent, F., Ponthus,  
508 J., Pichon, V., Carrette, P.-L., 2015. Amine degradation in CO<sub>2</sub> capture. 4. Development of  
509 complementary analytical strategies for a comprehensive identification of degradation compounds of  
510 MEA. *Int. J. Greenhouse Gas Control* 42, 439-453.

511 da Silva, E.F., Lepaumier, H., Grimstvedt, A., Vevelstad, S.J., Einbu, A., Vernstad, K., Svendsen, H.F.,  
512 Zahlisen, K., 2012. Understanding 2-Ethanolamine Degradation in Postcombustion CO<sub>2</sub> Capture. *Ind.*  
513 *Eng. Chem. Res.* 51, 13329-13338.

514 Davis, J.D., 2009. Thermal degradation of aqueous amines used for carbon dioxide capture. Thesis,  
515 University of Texas at Austin.

516 Davis, J., Rochelle, G., 2009. Thermal degradation of monoethanolamine at stripper conditions.  
517 *Energy Procedia* 1, 327-333.

518 Dettmer, K., Engewald, W., 2002. Adsorbent materials commonly used in air analysis for adsorptive  
519 enrichment and thermal desorption of volatile organic compounds. *Anal Bioanal Chem* 373, 490–500.

520 Einbu, A., da Silva, E.F., Haugen, G., Grimstvedt, A., Lauritsen, K. G., Zahlisen, K., Vassbotn, T., 2013. A  
521 new test rig for studies of degradation of CO<sub>2</sub> absorption solvents at process conditions; comparison  
522 of test rig results and pilot plant data for degradation of MEA. *Energy Procedia* 37, 717-726.

523 (EPA, 2008): Environment Protection Agency of the United States fact sheets, 2008, EPA 505-F-07-  
524 006.

525 Fostas, B., Gangstad, A., Nenseter, B., Pedersen, S., Sjøvoll, M., Sørensen, A.L., 2011. Effects of NO<sub>x</sub> in  
526 the flue gas degradation of MEA. *Energy Procedia* 4, 1566-1573.

527 Gouedard, C., Picq, D., Launay, F., Carrette, P.L., 2012. Amine degradation in CO<sub>2</sub> capture. I. A review.  
528 *Int. J. Greenhouse Gas Control* 10, 244-270.

529 Gouedard, C., Rey, A., Cuzuel, V., Brunet, J., Delfort, B., Picq, D., Dugay, J., Vial, J., Pichon, V., Launay,  
530 F., Assam, L., Ponthus, J., Carrette, P.-L., 2014a. Amine degradation in CO<sub>2</sub> capture. 3. New  
531 degradation products of MEA in liquid phase: amides and nitrogenous heterocycles. *Int. J.*  
532 *Greenhouse Gas Control* 29, 61–69,

533 Gouedard, C., 2014b. Novel Degradation Products of Ethanolamine (MEA) in CO<sub>2</sub> Capture Conditions:  
534 Identification, Mechanisms Proposal and Transposition to Other Amines. Université Pierre et Marie  
535 Curie, Paris, France.

536 Holub, P.E., Critchfield, J.E., Su, W.Y., 1998. Amine degradation chemistry in CO<sub>2</sub> service. 48th  
537 Lorraine Reid Gas Cond. Conf., 146-160.

538 IARC, 1978. Monographs on the Evaluation of Carcinogenic Risks to Humans. Some *N*-Nitroso  
539 Compounds. IARC, Lyon, Vol. 17.

- 540 Islam, M.S., Yusoff, R., Ali, B.S., Islam, M.N., Chakrabarti, M.H., 2011. Degradation studies of amines  
541 and alkanolamines during sour gas treatment process. *Int. J. Phys. Sci.* 6, 5883-5895.
- 542 Lepaumier, H., 2008. Étude des mécanismes de dégradation des amines utilisées pour le captage du  
543 CO<sub>2</sub> dans les fumées. Thesis, Laboratoire des matériaux organiques à propriétés spécifiques  
544 (Université de Savoie).
- 545 Lepaumier, H., Picq, D., Carrette, P.L., 2009a. New Amines for CO<sub>2</sub> Capture. I. Mechanisms of Amine  
546 Degradation in the Presence of CO<sub>2</sub>. *Ind. Eng. Chem. Res.* 48, 9061-9067.
- 547 Lepaumier, H., Picq, D., Carrette, P.L., 2009b. New Amines for CO<sub>2</sub> Capture. II. Oxidative Degradation  
548 Mechanisms. *Ind. Eng. Chem. Res.* 48, 9068-9075.
- 549 Lepaumier, H., Picq, D., Carrette, P.L., 2009c. Degradation study of new solvents for CO<sub>2</sub> capture in  
550 post-combustion. *Energy Procedia* 1, 893–900.
- 551 Lepaumier, H., Picq, D., Carrette, P.-L., 2010. CO<sub>2</sub> capture, why and how? What constraints? *L'Act.*  
552 *Chim.*, 337, 36-40.
- 553 Lepaumier, H., da Silva, E.F., Einbu, A., Grimstvedt, A., Knudsen, J.N., Zahlsen, K.r., Svendsen, H.F.,  
554 2011. Comparison of MEA degradation in pilot-scale with lab-scale experiments. *Energy Procedia* 4,  
555 1652-1659.
- 556 Martin, S., Lepaumier, H., Picq, D., Kittel, J., de Bruin, T., Faraj, A., Carrette, P.-L., 2012. New Amines  
557 for CO<sub>2</sub> Capture. IV. Degradation, Corrosion, and Quantitative Structure Property Relationship Model.  
558 *Ind. Eng. Chem. Res.* 51, 6283-6289.
- 559 Morken, A.K., Nenseter, B., Pedersen, S., Chhaganlal, M., Feste, J.K., Tyborgnes, R.B., Ullestad, O.,  
560 Ulvatn, H., Zhu, L., Mikoviny, T., Wisthaler, A., Cents, T., Bade, O.M., Knudsen, J., de Koeijer, G., Falk-  
561 Pedersen, O., Hamborg, E.S., 2014. Emission results of amine plant operations from MEA testing at  
562 the CO<sub>2</sub> Technology Centre Mongstad. *Energy Procedia*, 63, 6023 – 6038.
- 563 Rao, A.B., Rubin, E.S., 2002. A Technical, Economic, and Environmental Assessment of Amine-Based  
564 CO<sub>2</sub> Capture Technology for Power Plant Greenhouse Gas Control. *Environ. Sci. Technol.* 36, 4467-  
565 4475.
- 566 Rey, A., Gouedard, C., Ledirac, N., Cohen, M., Dugay, J., Vial, J., Pichon, V., Bertomeu, L., Picq, D.,  
567 Bontemps, D., Chopin, F., Carrette, P.L., 2013. Amine degradation in CO<sub>2</sub> capture. 2. New degradation  
568 products of MEA. Pyrazine and alkylpyrazines: Analysis, mechanism of formation and toxicity. *Int. J.*  
569 *Greenhouse Gas Control* 19, 576-583.
- 570 Reynolds, A.J., Verheyen, T.V., Adeloju, S.B., Chaffee, Meuleman, E., 2015. Monoethanolamine  
571 Degradation during Pilot-Scale Post-combustion Capture of CO<sub>2</sub> from a Brown Coal-Fired Power  
572 Station. *Energy Fuels*, 29, 7441–7455.
- 573 Rooney, P.C., Dupart, M.S., Bacon, T.R., 1998. Oxygen's role in alkanolamine degradation.  
574 *Hydrocarbon Process.* 77, 109-113.
- 575 Roundbehrer, D. P., Reisch, J. W., Coombs, J. R., Fine, D. H., 1980. Nitrosamine air sampling sorbents  
576 compared for quantitative collection and artifact formation. *Anal. Chem.* 52, 273-276.

- 577 Saavedra, J.E. 1981. Deamination of Primary Aminoalkanols. Formation of Substituted N-Nitroso-1,3-  
578 oxazolidines and N-Nitroso-1,3-tetrahydrooxazine. *J. Org. Chem.* 46, 2610-2614.
- 579 Sexton, A.J., 2008. Amine oxidation in carbon dioxide capture processes. Thesis, University of Texas  
580 at Austin.
- 581 Strazisar, B.R., Anderson, R.R., White, C.M., 2003. Degradation pathways for monoethanolamine in a  
582 CO<sub>2</sub> capture facility. *Energy Fuels* 17, 1034-1039.
- 583 Thitakamol, B., Veawab, A., Aroonwilas, A., 2007. Environmental impacts of absorption-based CO<sub>2</sub>  
584 capture unit for post-combustion treatment of flue gas from coal-fired power plant. *Int. J.*  
585 *Greenhouse Gas Control* 1, 318-342.
- 586 Vevelstad, S.J., Grimstvedt, A., Elnan, J., da Silva, E.F., Svendsen, H.F., 2013. Oxidative degradation of  
587 2-ethanolamine: the effect of oxygen concentration and temperature on product formation. *Int. J.*  
588 *Greenhouse Gas Control* 18, 88–100.
- 589 Zhou, S., Wang, S., Chen, C., 2012. Thermal Degradation of Monoethanolamine in CO<sub>2</sub> Capture with  
590 Acidic Impurities in Flue Gas. *Ind. Eng. Chem. Res.* 51, 2539-2547.

**Supplementary Material**

[Click here to download Supplementary Material: Supplementary material.docx](#)