



**HAL**  
open science

## Multi-level integrated optimal design for power systems of more electric aircraft

Houdhayfa Ounis, Bruno Sareni, Xavier Roboam, André de Andrade

► **To cite this version:**

Houdhayfa Ounis, Bruno Sareni, Xavier Roboam, André de Andrade. Multi-level integrated optimal design for power systems of more electric aircraft. *Mathematics and Computers in Simulation*, 2016, vol. 130, pp. 223-235. 10.1016/j.matcom.2015.08.016 . hal-01409149

**HAL Id: hal-01409149**

**<https://hal.science/hal-01409149>**

Submitted on 5 Dec 2016

**HAL** is a multi-disciplinary open access archive for the deposit and dissemination of scientific research documents, whether they are published or not. The documents may come from teaching and research institutions in France or abroad, or from public or private research centers.

L'archive ouverte pluridisciplinaire **HAL**, est destinée au dépôt et à la diffusion de documents scientifiques de niveau recherche, publiés ou non, émanant des établissements d'enseignement et de recherche français ou étrangers, des laboratoires publics ou privés.



## Open Archive Toulouse Archive Ouverte (OATAO)

OATAO is an open access repository that collects the work of Toulouse researchers and makes it freely available over the web where possible.

This is an author-deposited version published in: <http://oatao.univ-toulouse.fr/>  
Eprints ID: 16686

**To link to this article** : DOI: 10.1016/j.matcom.2015.08.016

URL : <http://dx.doi.org/10.1016/j.matcom.2015.08.016>

To cite this version: Ounis, Houdhayfa and Sareni, Bruno and Roboam, Xavier and De Andrade, André *Multi-level integrated optimal design for power systems of more electric aircraft*. (2016) *Mathematics and Computers in Simulation*, vol. 130. pp. 223-235. ISSN 0378-4754

Any correspondence concerning this service should be sent to the repository administrator:  
[staff-oatao@listes-diff.inp-toulouse.fr](mailto:staff-oatao@listes-diff.inp-toulouse.fr)

# Multi-level integrated optimal design for power systems of more electric aircraft

H. Ounis\*, B. Sareni, X. Roboam, A. De Andrade

*Université de Toulouse, LAPLACE, UMR CNRS-INPT-UPS, 2 rue Camichel, 31071 Toulouse, France*

## Abstract

This paper proposes a multi-level optimal design method for a complex actuation system of more electric aircraft. The multi-level structure consists in sharing the optimization process in several levels, here 2, a “system level” which involves main coupling variables and a “component level” with one optimization loop for each device. The interest of this method is to separate the optimal design of each component, making easier the convergence of loops. This method is applied to a relatively complex power conversion system including a high speed permanent magnet synchronous machine (HSPMSM) supplied by a pulse width modulation (PWM) voltage source inverter (VSI) associated with a DC-link filter. Its interest is shown through a comparison with classical design approaches employed in previous works.

*Keywords:* Optimal design; Multi-level optimization; ATC (analytical target cascading); Power integration

## 1. Introduction

Thanks to the significant advances in aircraft electric technologies, integration of electrical energy has significantly increased in the last century [3,4,10,16]. Fig. 1 shows the trend in the power demand in commercial aircrafts. The main advantage of more electrical architectures is related to energy management as electric generators are controlled to match exactly the demand of consumers, reducing thereby losses contrarily for example to pneumatic systems powered by bleed-air at the operating pressure of the engine, irrespective of the needs of the systems [9]. Additional advantages of electrical systems are due to the opportunity for an easier power management through shared sources [4]. Moreover, the potential of improvements in the power density (power to mass ratio) of electrical systems is seen as high [9] while hydraulic and pneumatic systems are stabilized being more mature. Table 1 resumes the benefits of electrical systems compared to hydraulic, mechanical and pneumatic systems [4]. However, a separate design process of all the different electrical systems would not lead to an important gain compared to conventional systems [1] (e.g. fuel burn, integrated mass and drag impact).

\* Corresponding author.

*E-mail addresses:* [ounis@laplace.univ-tlse.fr](mailto:ounis@laplace.univ-tlse.fr) (H. Ounis), [sareni@laplace.univ-tlse.fr](mailto:sareni@laplace.univ-tlse.fr) (B. Sareni), [roboam@laplace.univ-tlse.fr](mailto:roboam@laplace.univ-tlse.fr) (X. Roboam), [deandrade@laplace.univ-tlse.fr](mailto:deandrade@laplace.univ-tlse.fr) (A. De Andrade).

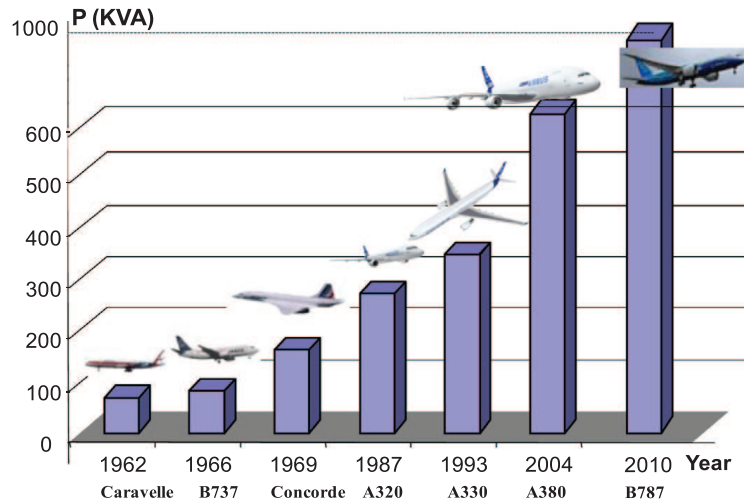

Fig. 1. Trend in commercial aircraft power demand.

Table 1  
Comparison of aircraft secondary power distribution systems [4].

System	Complexity	Maintenance	Technological maturity
Electrical	Complex	Simple	System—Mature New technologies—Immature
Hydraulic	Simple	Complex and hazardous	Mature
Mechanical	Very complex	Frequent and slow	Very mature
Pneumatic	Simple	Complex	Very mature

In order to maximize the gain of electrical systems, all couplings must be considered in the design process, which means that coordination between different partners is essential to have a global optimal design instead of a set of local optimal designs which cannot ensure the optimality of the overall system. However, in this range of application, the complexity of the global design problem (number of decision variables, number of constraints, limits of optimization algorithms, separated expertise, “confidentiality problems”) is far to be overcome by using simple design techniques involving an overall optimization (“all in one loop”). In this context, the interest of a multidisciplinary design optimization (MDO) has been proved [8,12]; it allows facing the needs of high-complex design problems by dividing the global system into subsystems that may correspond to different design teams which cooperate between them [12]. Several hierarchical formulations and coordination strategies are proposed in the literature: Cramer’s [8] and Sobieski’s [21] formulations, collaborative optimization [6,7], Wismer and Chattergy’s coordination [25], Nelson’s sequentially decomposed programming (SDP) [17] and target cascading [13,15,21] where local and global convergence are proved in [21].

In this paper, an integrated design problem of a complex multidisciplinary aircraft system is proposed. This system is composed of a HSPMSM (high speed permanent magnet synchronous machine) supplied by a pulse width modulation (PWM) voltage source inverter (VSI) associated with a DC-link filter. A multilevel formulation of the problem is proposed and results are compared to global and sequential formulations developed in [18]. Three parts are proposed:

- In the first part, we detail the analytical models of the different components of an electrical drive system for aircraft application (input filter, inverter and machine);
- In the second part, a “sequential” approach is applied to the aircraft system and compared to the global optimization approach;
- The last part deals with a multi-level optimization method applied to the aircraft system.

## 2. System model

This example refers to the integrated design of an electrical power system including a HSPMSM supplied by a VSI associated with an input filter (Fig. 1). The actuation mission is ensured by the HSPMSM motor which must operate

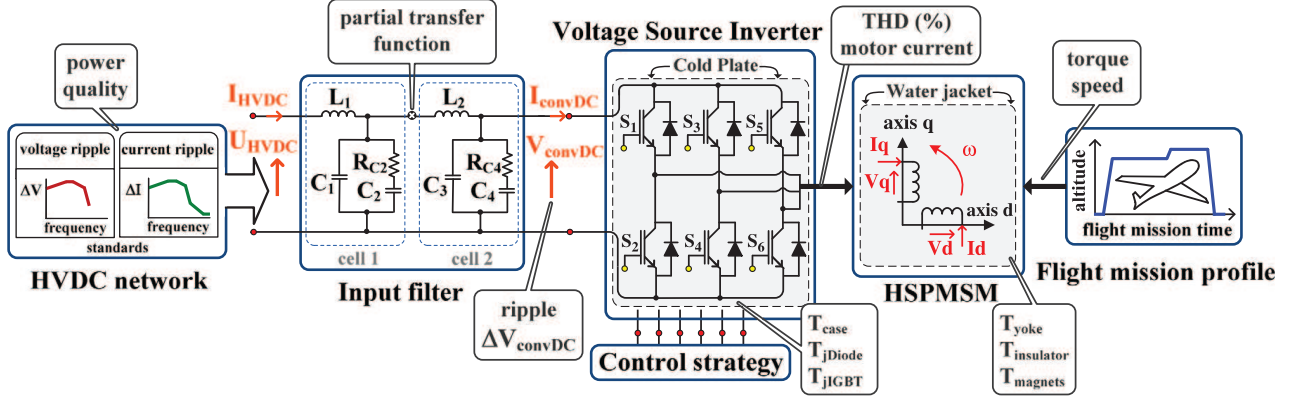

Fig. 2. Actuation system architecture.

at specific points in the torque-speed plane depending on the flight mission. On the other hand, the system has to comply with HVDC network standards [2] during its operation. Considering the main constraints at the device input and output, two design objectives are focused: the whole weight and power losses during the flight mission have to be minimized. In this context, an integrated design process based on the actuation system modeling and optimization has been investigated. Our approach particularly takes account of the mission profile in the integrated optimal design process. This model was developed in C language.

### 2.1. Flight mission profile

HSPMSM operating points have to be fulfilled in the Torque-Speed plane depending on the flight phases (climb, cruise and descent) and on the climatic conditions (i.e., international standard atmosphere, warm or cold weather conditions). These points are illustrated in Fig. 3 with their associated statistic occurrence. It should be noted that the maximum HSPMSM power which approximately corresponds to the maximum speed and maximum torque values is of small occurrence. Setting the HSPMSM base point close to this point would certainly lead to a system oversizing. This underlines the interest of exploiting field weakening and “over-torque” capabilities in the integrated design process.

### 2.2. HSPMSM model

A multi-physics model of the HSPMSM has been derived from a previous permanent magnet synchronous machine (PMSM) model devoted to ground applications [19,23]. This model has been extended in order to take account of all features related to the PMSM behavior at high speed operation (see Fig. 2). It includes (see Fig. 4):

- all characteristics related to the HSPMSM architecture: material types in each region (iron, magnet, sleeve, copper) and associated geometry parameters (i.e. radius length ratio, slot depth, slot width, number of pole pairs, number of slots per pole per phase, equivalent gap, magnet filling coefficient). This model also allows the computation of the HSPMSM mass from the mass density of each material and from the HSPMSM geometrical features;
- an electric model based on the HSPMSM electrical variables (resistance, leakage and main inductances, magnetic flux, voltage) calculated from the HSPMSM geometrical features;
- a magnetic model specifying HSPMSM electromagnetic behavior in each region (yoke, teethes, air gap, magnet) and magnet demagnetization characteristics;
- the computation of all HSPMSM power losses divided in Joule losses, iron losses [14], aerodynamic losses [24], magnet losses [11];
- a thermal model giving the temperature in each HSPMSM part (copper, insulator, yoke, sleeve, magnet) from the corresponding power losses and from the external temperature imposed by the cooling plate. This model also provides the mass estimation of the HSPMSM cooling system;
- a HSPMSM control strategy allowing maximum torque per Ampere with field weakening mode.

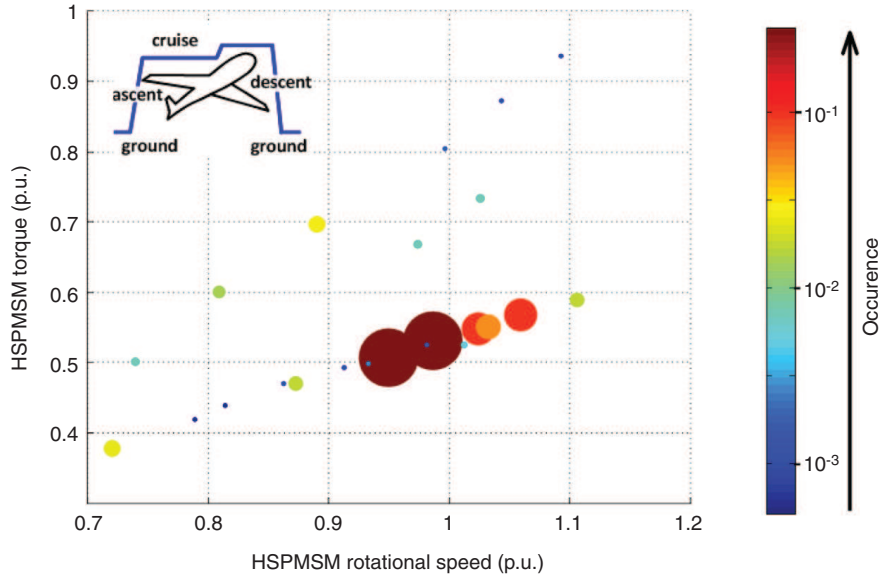
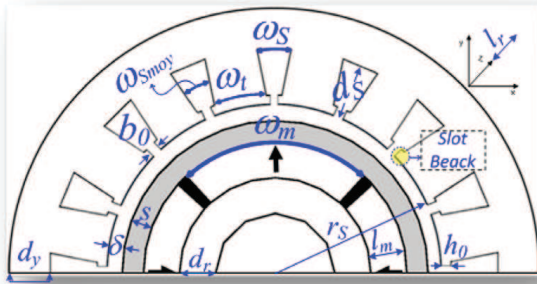
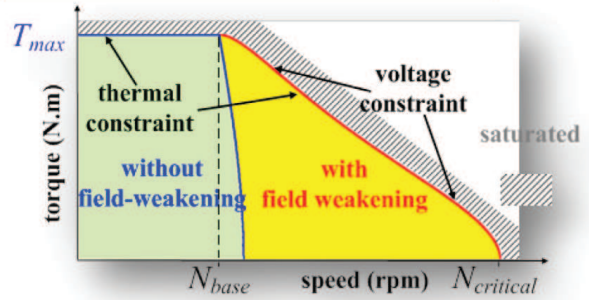

Fig. 3. Flight mission in the HSPMSM torque-speed plane.

**Geometric model**



**Control: field weakening in torque-speed plan**



**Thermal model**

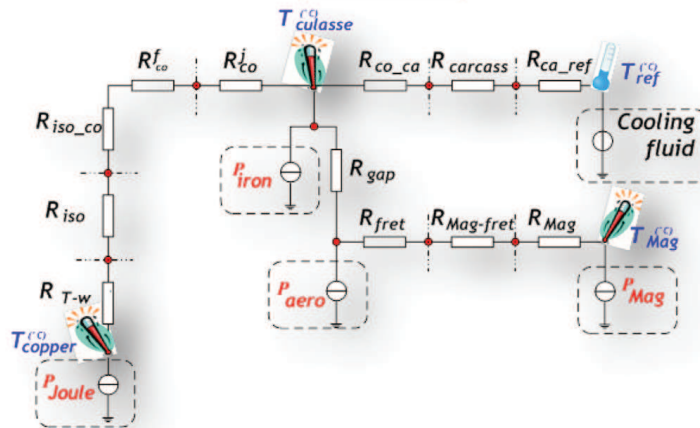

Fig. 4. Multi-physics HSPMSM model.

**2.3. Input filter model**

The input filter includes two cells as shown in Fig. 2. Its model contains:

- the geometrical and physical features of all filter components;
- a quadripole representation which allows the determination of electric variables at the filter input and output (Fig. 5). The HVDC input voltage is given by the HVDC standard and the output filter DC current results from



the VSI model. Considering those given variables, the other complementary variables (i.e., the input filter HVDC current and the output filter voltage) are found through the quadripole impedance matrix.

- The computation of power losses in the filter elements (inductances, capacitors and resistors).

#### 2.4. VSI model

The VSI (Voltage Source Inverter) is a classical two-level structure (Fig. 2) associated with a Space Vector Pulse Width Modulation (SVPWM) strategy. The multi-physics VSI model includes:

- A time–frequency approach which allows the determination of the electrical variables (currents and voltages) in time and frequency domains at the VSI input and output. In particular, this approach quickly computes the time evolution of electric variables over a period of the modulation signal at steady state operation. From the SVPWM strategy and the knowledge of VSI switching states, HSPMSM stator voltages are constructed. Then, HSPMSM line currents are easily computed in frequency domain from the HSPMSM impedance using the fast Fourier transform. The corresponding time evolution of HSPMSM currents can also be obtained over the modulation signal period with the inverse fast Fourier transform. Finally, the DC current at the VSI input is deduced from HSPMSM currents and VSI switching states;
- A model of inverter losses including switching losses and conduction losses in diodes and IGBTs;
- A geometrical model depending on the IGBT current rating, the dual pack component features and the cooling plate characteristics. This model gives an estimation of VSI and cooling plate masses;
- A thermal model providing the temperature in each component (diode, IGBT, casing) from the associated power losses and from the reference temperature imposed by the cooling plate.

### 3. Global and sequential system optimization

The actuation system optimization has been carried out using three different approaches. The first two approaches have previously been applied in [18].

- A local and sequential sizing of each part (i.e. the HSPMSM optimization followed by the VSI and input filter optimization);
- A global integrated design approach investigating the simultaneous sizing of all coupled components.
- A third optimization approach based on an original multi-level formulation of the problem is also presented in Section 4.

#### 3.1. Sequential optimization

- HSPMSM optimization.

The optimal sizing of the HSPMSM has been formulated into a local optimization problem with:

- 11 design variables related to the HSPMSM geometric features, electromagnetic variables and mechanical characteristics;
- 11 constraints associated with geometrical variables, technological limits and temperature limits in the different motor parts (rotor: magnet, sleeve; stator: insulator, yoke);
- 2 objectives to be minimized: the HSPMSM mass and the total losses estimated over the flight mission. Total HSPMSM losses are computed by weighting all losses on each mission point according to its occurrence during the flight.

- VSI and Input Filter optimization.

The optimal sizing of the “input filter + VSI” set has been formulated into an optimization problem with:

- 10 design variables related to the VSI (switching frequency, IGBT current rating) and the  $R$ ,  $L$ ,  $C$  components of the input filter;
- 11 constraints associated with the input filter features, with VSI semiconductors and quality standards on the electrical network (HVDC network quality of low and high frequency currents, maximum ripple of input VSI voltage, maximum harmonic distortion of the HSPMSM);

- 2 objectives to be minimized: the mass of the “input-filter + VSI” set and the total losses in this subsystem during the flight mission. The whole losses for this supply part include losses in the filter ( $R$ ,  $L$ , and  $C$  losses) and VSI (switching and conduction losses).

- Results.

We have previously performed the sequential optimization by determining HSPMSM Pareto-optimal configurations before optimizing the supply part. Those solutions are obtained from 10 independent runs of the NSGA-II (non-dominated sorting genetic algorithm) evolutionary algorithm with a population size of 100 and number of generation of 500 and using a self-adaptive recombination [20]. Fig. 6(a) compares the optimal tradeoffs found in the objective space (i.e. HSPMSM mass and losses) with a reference non-optimized solution. All variables are given in per unit (p.u) for confidentiality reason. Even if some important gains on both HSPMSM objectives can be observed, we point out they could not be considered as significant at the system level since the supply part is not designed at this step. Then, the multi-objective optimization of the “input filter + VSI” set is also performed with regards to three particular HSPMSM configurations extracted from the previous Pareto-optimal front. With respect to the reference HSPMSM solution, those configurations are chosen at the same level of mass (i.e. M1), at the same level of losses (i.e. M3), the “M2” motor being an intermediate dominant solution. Each HSPMSM solution is represented by its circuit parameters ( $p$ ,  $R_s$ ,  $L_{sync}$ ,  $\phi$ ) in the “input filter + VSI” problem. Pareto-optimal solutions of “input filter + VSI” set are obtained as previously from NSGA-II runs considering the three particular HSPMSM configurations. Results are illustrated in Fig. 6(b). The particular shape of the Pareto-optimal front clearly indicates “a weak front”, i.e. the lack of compromise between both objectives. Therefore, only “input filter + VSI” configurations with minimum mass are considered as optimal solutions.

### 3.2. Global optimization

The global multi-objective optimization of all components is investigated in a single optimization loop. In comparison with both component optimization problems described in the previous subsections, the complexity of this “global problem” is significantly increased since all design variables and constraints are aggregated. Therefore, this new problem includes 21 design variables, 22 constraints and same 2 objectives. It is then solved 10 times using the NSGA-II with a population size of 100 and a number of generations of 1000. Pareto-optimal solutions obtained from this system optimization are illustrated in Fig. 6(c) and compared with the three particular solutions resulting from the sequential optimization approach (combination by mass and losses additions of HSPMSM and VSI-input filter solutions of Fig. 6(a) and (b)). As expected, the global optimization of all components clearly outperforms the sequential optimization approach because it takes into account the different couplings between all the variables of the system which is not true in sequential approach. However, it should be mentioned that convergence on the global optimization problem can be obtained in a reasonable time only if the optimal components found by the sequential approach are inserted in the NSGA-II initial population.

## 4. Multi-level optimization

The optimal design of highly complex systems that involves many disciplines and many fields of expertise cannot be achieved by a single company and in a single optimization loop. Often, subcontractors are called for the design of certain components constituting the system, each one in its specific field. In this context, a global optimization appears very difficult to apply. However, the sequential approach provides certain flexibility by performing a separate optimization of each component, but the results obtained in Section 3.2 show a large difference between the global and sequential approaches. In this part, a “multi-level optimization” method is proposed in order to find compromise solutions that draw near the global solutions and which ensure good convergence of the optimization problem while preserving benefits of the sequential approach in terms of structure.

Several approaches of multi-level optimization have been proposed in [5]. Among the approaches cited in the introduction, Sobieski’s and collaborative optimization do not have convergence proofs and are currently limited to bi-level systems contrary to the target cascading approach where convergence and its advantages compared to the previous approaches in terms of convergence, simplicity of the formulation, and the number of the levels that can be achieved are proved in [13].



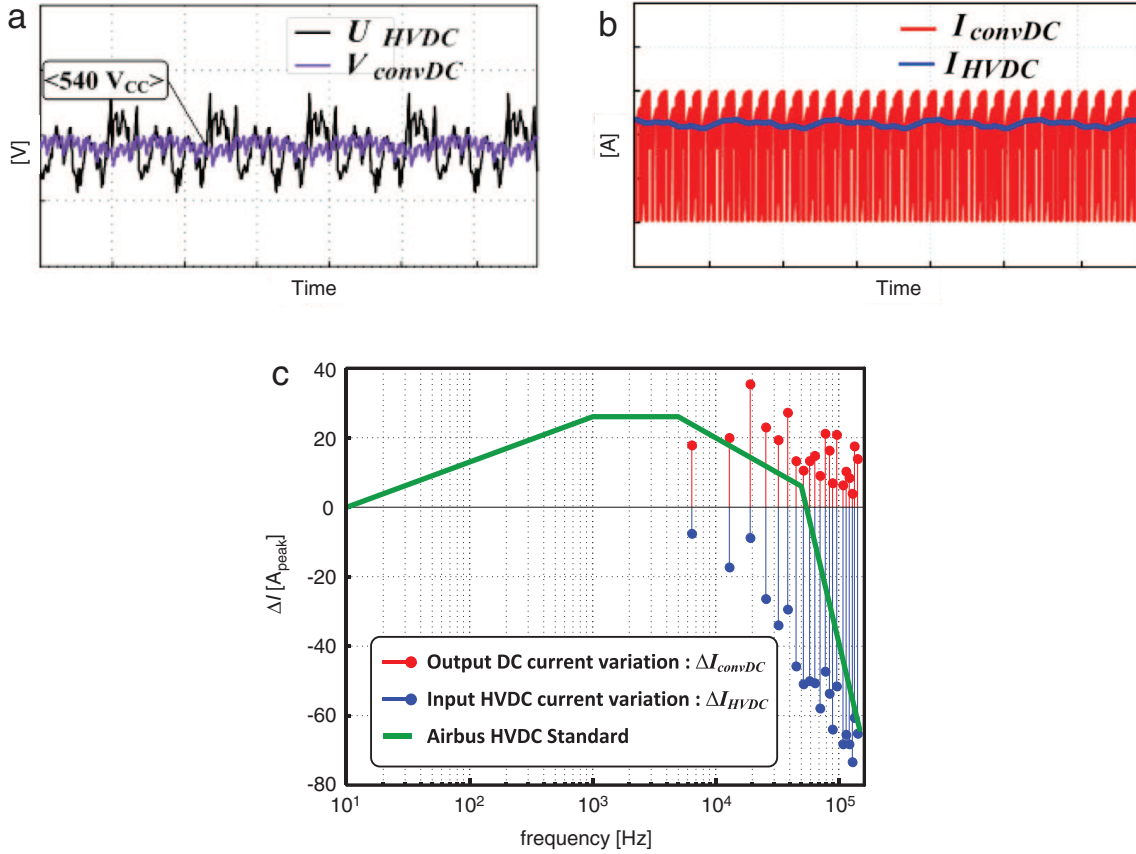

Fig. 5. Typical plots of electrical variables at the filter input and output. (a) Input and output voltages. (b) Input and output currents. (c) Input and output current harmonics compared to HVDC standards.

In the ATC (Analytical Target Cascading) formulation, the overall targets are cascaded from the top level to lowest levels of the hierarchy (Fig. 7). Four steps are involved [12]:

- Development of appropriate models;
- Partitioning of the system;
- Formulation of the target cascading problems for each element of the partition;
- Solving the partitioned problem through a coordination strategy to compute all stated targets.

The partitioning of the system can be done in several ways such as object or physics (discipline) based partitioning [22]. After having partitioned the original problem, the decision variables are categorized in “linking variables” common to two or more sub-problems and “local variables” specific to one of them.

The studied design problem is here divided into two levels: a “low level” (component or subsystem level) and an “upper level” (system level). The low level can contain two or more components. Here, we have considered two different formulations:

- Formulation with two subsystems (Fig. 8): the system is divided into two levels with two component problems in the lower level (HSPMSM and filter-VSI design problems). The upper level contains the common (coupling) variables between component problems as decision variables. In our case, the only common variables involved in the design of the HSPMSM and the “input filter + VSI” are the circuit parameters of the actuator ( $p$ ,  $R_s$ ,  $L_{sync}$ ,  $\phi$ ).
- Formulation with three subsystems (Fig. 9): the system is still divided in two levels but with three component problems in the lower level (HSPMSM, filter and VSI design problems). The upper level contains the same decision variables as in the first formulation ( $p$ ,  $R_s$ ,  $L_{sync}$ ,  $\phi$ ) with additionally the switching frequency ( $f_{sw}$ ) to coordinate between the filter and the VSI problems.

The Target Cascading approach as presented in the literature [5,12,13], assumes the knowledge of a system model to evaluate system objectives. Thus, a local optimization at this level without resorting to low levels is possible (Fig. 8).

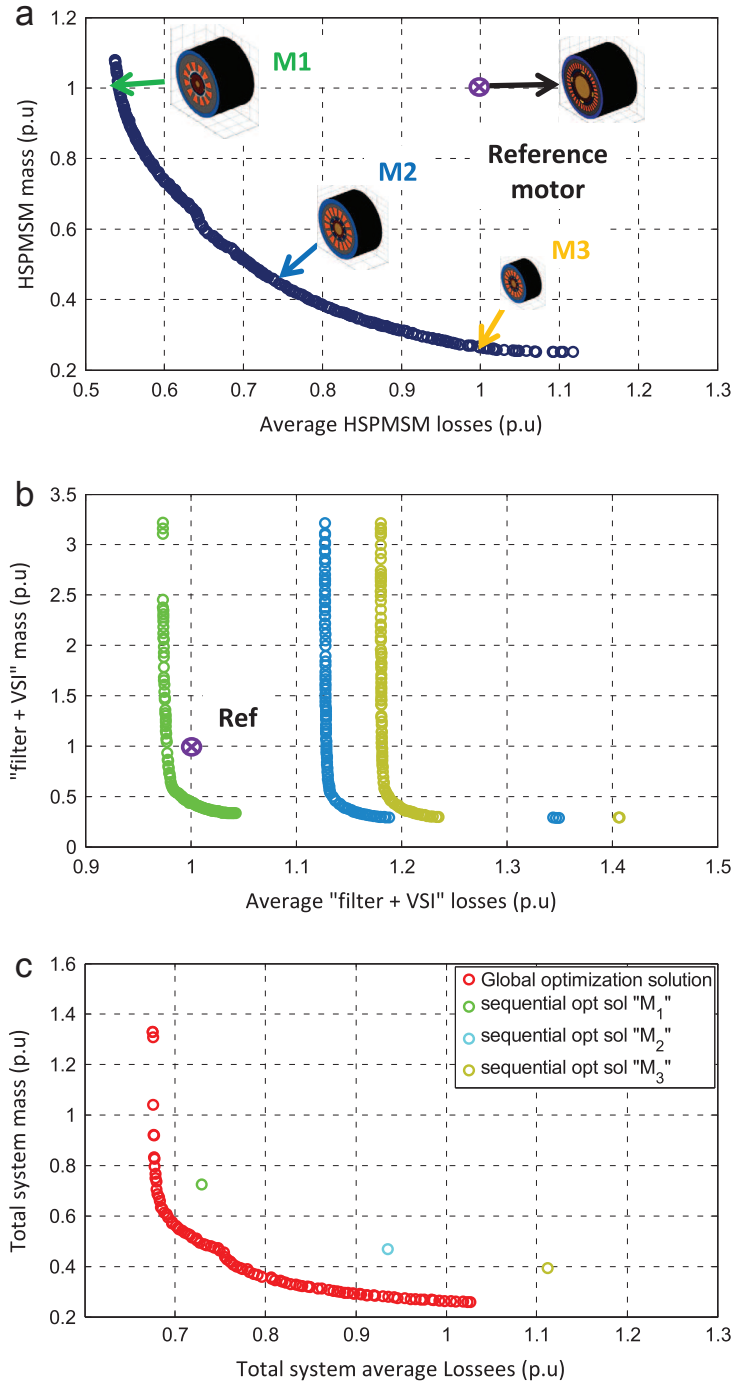

Fig. 6. Pareto-optimal configurations. (a) HSPMSM optimal configurations. (b) "Input filter + VSI" optimal configurations relative to three particular HSPMSM solutions (M1, M2, M3). (c) Optimal configurations obtained from sequential component or global system optimization.

In our example, there is no model that allows estimating the overall objectives (whole system mass and total losses) at the system level based on adopted system parameters ( $p$ ,  $R_s$ ,  $L_{sync}$ ,  $\phi$ ,  $f_{sw}$ ). Therefore, a modification is here proposed with respect to the basic ATC formulation: interactions between upper and low levels are clearly seen in Figs. 8 and 9.

#### 4.1. Formulation of the multi-level optimization problem

The optimization problem is divided into two levels:

- Upper (system) level: circuit parameters of the HSPMSM model are themselves the coupling variables between components. This makes appear a good reason to consider them as design parameters of the system level. In the

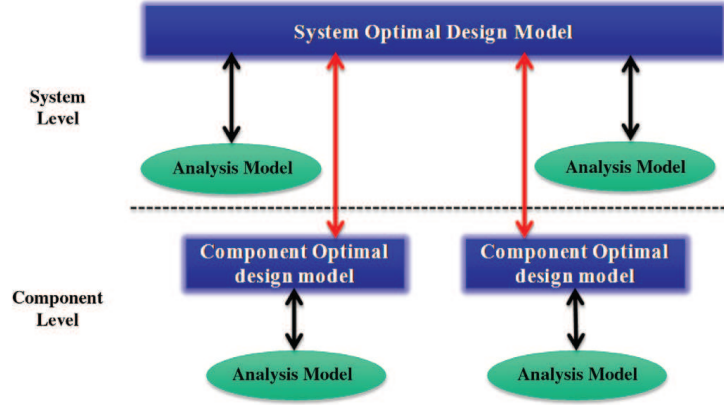

Fig. 7. ATC formulation (simplified vision).

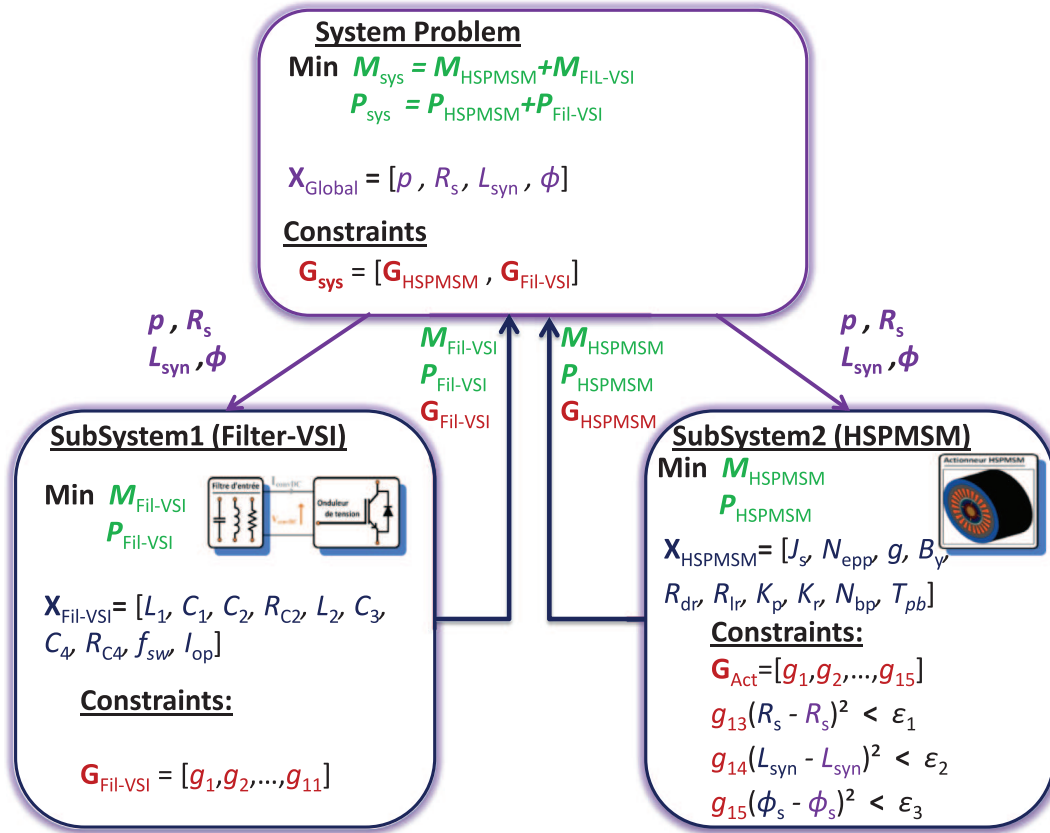

Fig. 8. Multi-level formulation with two components.

“three component” formulation, the switching frequency is added as decision variable of the upper level problem to coordinate between “filter” and “VSI” sub-problems. It is used to calculate electrical variables (current and voltage) between components and control sequences of the inverter which allows a considerable gain in computational time of the “input filter + VSI” problem when this calculation is done at the “system level”. At this level, mass and total losses of the whole system are optimized.

- Lower (component) level: the most important in this level is how to process targets cascaded from the system level. There are two distinguished cases:
  - If “system targets” are input variables in the original problem of a component model (Section 3.1), these targets are considered as data (i.e. known variables) in the multi-level formulation. The pole pairs ( $p$ ) in the HSPMSM problem is a typical example of this case;

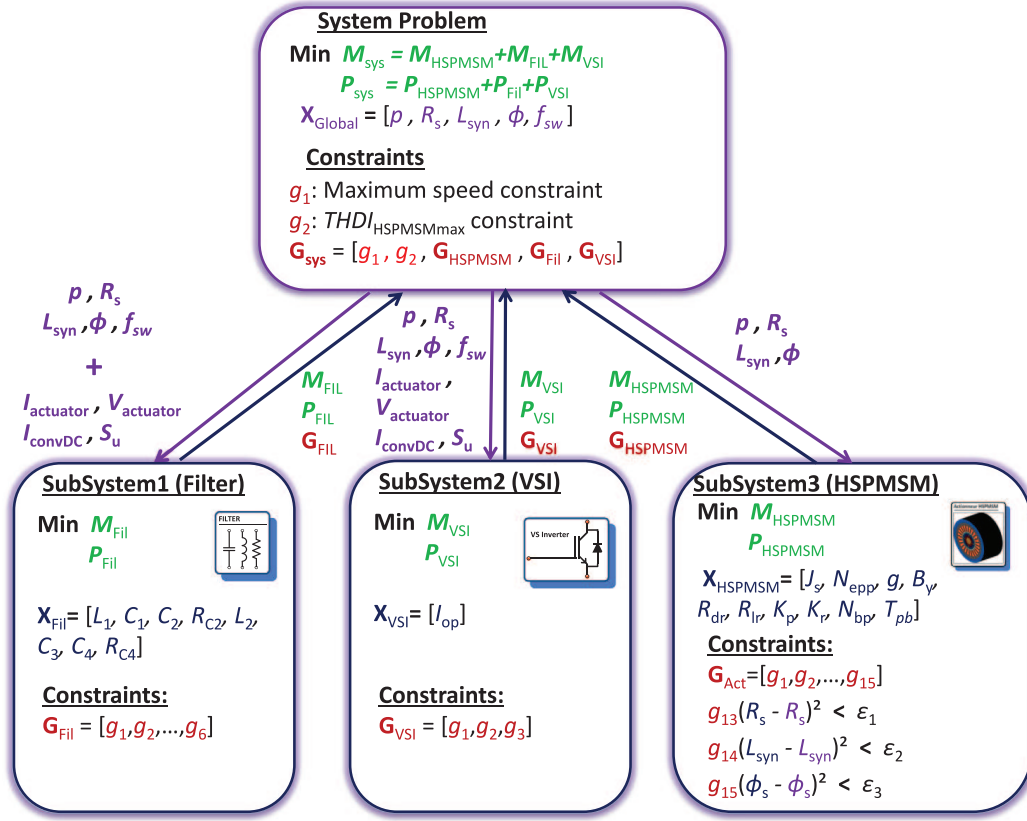

Fig. 9. Multi-level formulation with three components.

- On the contrary, for system targets which are outputs of the component problem (e.g.  $R_s, L_{sync}$  and  $\phi$  in the HSPMSM problem), the differences between system targets and local calculated values are minimized with additional equality constraints.

At “component level”, two or three component problems are optimized:

- Two component formulation: in this formulation, only the overall objectives are calculated in the upper level (total mass and total losses). Sub-problems are formulated as follows:
  - The “HSPMSM problem” is formulated in the same manner as in the sequential approach, with few differences: “10” decision variables instead of “11” (the number of pole pairs  $p$  is set as an input from the upper level), “15” constraints instead of “12” (three additional coordination constraints of targets:  $R_s, L_{sync}$  and  $\phi$ );
  - The “input filter + VSI” problem is formulated exactly in the same manner as in sequential approach. It requires “10” decision variables and “11” constraints.
- Three component formulation: here, the switching frequency is added to the decision variables of the upper level optimization problem to coordinate between “input filter” and “VSI” sub-problems. No changes are made on the “HSPMSM” formulation. The two other component problems are formulated as follows:
  - The “input filter problem” requires “9” decision variables (i.e. the  $R, L, C$  filter parameters) and “8” constraints.
  - The “VSI problem” requires one decision variable (the rating current  $I_{op}$ ) and 3 constraints.

The optimization process involves the following steps:

- Generate a system decision variables vector ( $p, R_s, L_{sync}, \phi, f_{sw}$ );
- Calculate the input currents and voltages of the HSPMSM, control inverter sequences and inverter input current (for three component formulation);
- Send targets to sub-problems;
- Run a local optimization of each component;
- Send local objectives (mass and total losses); and constraints to the upper “system” level;
- Calculate the global objectives at system level.

This loop is redone several times depending on the setting of the optimization algorithm.

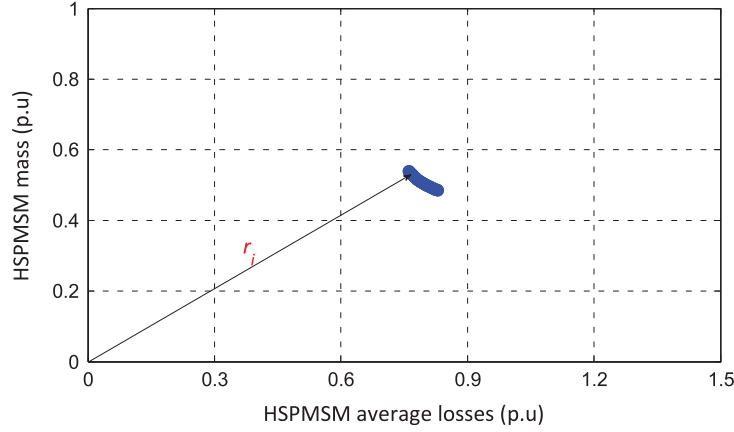

Fig. 10. Pareto front of the ‘‘HSPMSM problem’’ with equality constraints.

#### 4.2. Multi-level multi-objective optimization

Multi-objective optimization applied to the ‘‘component level’’ problems arises additional difficulties to the ‘‘system level’’ optimization algorithm. In the ordinary case, for a single individual there is only one solution returned by the analysis model to the algorithm. Conversely in the adopted multi-level formulation,  $N_1 \times N_2$  system solutions are returned for each vector of design system parameters (where  $N_1$  denotes the Pareto front size of the HSPMSM problem and  $N_2$  the Pareto front size of the ‘‘input filter + VSI’’ problem).

Nevertheless, by analyzing the Pareto fronts of component problems, specific properties can be observed for each case:

- In the HSPMSM problem, equality constraints added to ensure the coherence with the system level targets influence the solution distribution on the Pareto front which becomes a packed front corresponding to a certain class of circuit (Fig. 10). This characteristic allows considering only one particular solution per front. To select this particular solution, different criteria can be used, such as: the minimal error relative to system targets or the minimal distance from ideal objectives; in our case, we have used the second criteria:

$$\text{Solution} \equiv \min(r_i)$$

$$\text{where: } r_i = \sqrt{\left(\frac{M_i}{M_{\max}}\right)^2 + \left(\frac{P_i}{P_{\max}}\right)^2}.$$

$M_i$ : Mass of the  $i$ th solution ;

$M_{\max}$ : Maximal mass;

$P_i$ : Average losses of the  $i$ th solution;

$P_{\max}$ : Maximal average losses;

- In the ‘‘input filter + VSI’’ problem, as seen in Section 3.1, the Pareto front has a particular shape (weak front). Thus, only the optimal solution with minimum mass is returned to the system level (Fig. 6(b)).

#### 4.3. Comparative results

Both multi-level optimization problems are solved using the NSGA-II at each level (system and component).

In this sub-section, a comparative analysis of the obtained results by means of the three methods is proposed in the same conditions (same mission profile, etc.).

Table 2 shows the configuration of the genetic algorithm for each optimization problem. Pareto fronts of the multi-level formulation problems deal near global solution and clearly outperform the ‘‘sequential’’ approach (see Fig. 11). It should be mentioned that the 2-component formulation better converges than the 3-component formulation because of the number of decision variables of the system level which is greater in the second formulation. However, the time calculation per iteration is higher for the 2-components formulation (34 min vs. 9 min). The time calculation of one ‘‘system iteration’’ is more difficult to estimate because it depends on the feasibility rate of the component problems.

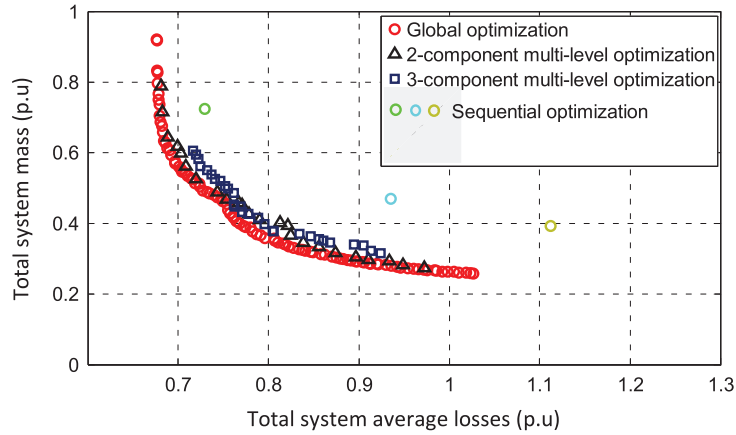

Fig. 11. Comparison of “sequential”, “global” and “multi-level” approaches.

Table 2  
NSGA-II configuration and time calculation of component problems.

	HSPMSM problem		Filter + VSI problem		Filter problem		VSI problem	
	Nb. Gen	Nb. Ind	Nb. Gen	Nb. Ind	Nb. Gen	Nb. Ind	Nb. Gen	Nb. Ind
2-component formulation	1000	100	500	100	–	–	–	–
3-component formulation	1000	100	–	–	300	50	100	20
CPU time per iteration	4 min		30 min		4 min		1 min	

In this example, results are obtained with only 100 generations for the 2-component formulation and 150 generations for the 3-component formulation and the time calculation is estimated respectively at 300 and 250 h of CPU time in a standard computer.

The difference between multi-level and global approach solutions can be explained by the limited number of generations of the system level optimization problem in the multi-level method. Nevertheless, multi-level optimization is highly expensive with regard to the computational time (the global optimization is achieved in 120 h). This drawback with regard to the global approach can be compensated by two aspects: first, splitting the optimized device into several parts (here 2 or 3 sub-systems) forces the optimization convergence which is not ensured in the global approach. Second, one great interest of the multi-level approach is due to its ability to manage projects with confidentiality issues between different project participants sometimes in a competitive context: indeed, if each supplier is responsible and proprietary of its own device (sub system), confidentiality issues are saved by means of black box or proprietary models. The remaining challenge of the proposed multi-level approach is to minimize the computational time by reducing the number of generations of the system level.

## 5. Conclusion

In this paper, three optimization approaches have been proposed: a sequential approach with two optimization loops separating power supply and actuation parts. Then, a global optimization with a unique loop integrating all couplings between HVDC network and actuation application with respect to the flight mission has been presented: the global optimization of all components clearly outperforms the sequential optimization approach but convergence is not ensured due to its complexity (higher number of decision variables). Furthermore, for the global approach, all models of all devices are integrated in a unique optimization process: confidentiality issues in a competitive context between suppliers of sub systems may become problematic.

In the last part, two multi-level formulations are presented and compared with both sequential and global approach. Results demonstrate the importance of the multi-level approach in terms of convergence. This proposition also helps to solve confidentiality issues between the different project participants but the computational time must be reduced. Some improvements in terms of generation number reduction are expectable but require future developments.



## References

- [1] Airbus and United Technologies, Final report joint UTC/Airbus ITAPS study, Technical report, May 2005.
- [2] Airbus Directives (ABD) and Procedures, ABD0100-Equipment-Design, General Requirements For Suppliers. Issue C, 1998.
- [3] M.J. Armstrong, Identification of emergent off-nominal operational requirements during conceptual architecting of the more electric aircraft (Ph.D. dissertation), Georgia Institute of Technology, 2011.
- [4] C. Avery, S. Burrow, P. Mellor, Electrical generation and distribution for the more electric aircraft, in: Univ. Power. Eng. Conf., 2007, pp. 1007–1012.
- [5] A.C. Berbecea, Multi-level approaches for optimal system design in railway applications (Ph.D. dissertation), Université des sciences et technologie de Lille, 2012.
- [6] R. Braun, Collaborative optimization: an architecture for large-scale distributed design (Ph.D. dissertation), Stanford University, 1996.
- [7] R. Braun, P. Gage, I. Kroo, I. Sobieski, Implementation and performance issues in collaborative optimization, *Am. Inst. Aeronaut. Astronaut.* (1996) 295–305.
- [8] E. Cramer, J. Dennis, P. Frank, R. Lewis, G. Shubin, Problem formulation for multidisciplinary optimization, *SIAM J. Optim.* 4 (1994) 754–776.
- [9] S.L. Hanke, A model-based methodology for integrated preliminary sizing and analysis of aircraft power system architectures (Ph.D. dissertation), Université de Toulouse, 2008.
- [10] M. Howse, All electric aircraft, *IEE Power Eng.* 17 (2003) 35–37.
- [11] D. Ishak, Z.Q. Zhu, D. Howe, Eddy-current loss in the rotor magnets of permanent-magnet brushless machines having a fractional number of slots per pole, *IEEE Trans. Magn.* 41 (2005) 2462–2469.
- [12] H.M. Kim, Target cascading in optimal system design (Ph.D. dissertation), Michigan University, 2001.
- [13] H.M. Kim, N. Michelena, P. Papalambros, T. Jiang, Target cascading in optimal system design, *Trans. ASME* 125 (2003) 474–480.
- [14] C. Mi, G.R. Slemon, R. Bonert, Modeling of iron losses of permanent magnet synchronous motors, *IEEE Trans. Ind. Appl.* 39 (2003) 734–741.
- [15] N. Michelena, H.M. Kim, P.Y. Papalambros, A system partitioning and optimization approach to target cascading, in: 12th Int. Conf. Eng. Des., 1999, pp. 1109–1112.
- [16] I. Moir, The all-electric aircraft—Major challenges, in: *IEE. Colloq. All. Electr. Aircr.*, 1998, pp. 2/1–2/6.
- [17] S. Nelson, Optimal hierarchical system design via sequentially decomposed programming (Ph.D. dissertation), Michigan University, 1997.
- [18] X. Roboam, B. Sareni, A. De Andrade, Integrated optimal design for power systems of more electrical aircraft, *IEEE. Ind. Electron. Mag.* 6 (2012) 6–17.
- [19] B. Sareni, A. Abdelli, X. Roboam, D.H. Tran, Model simplification and optimization of a passive wind turbine generator, *Renew. Energy* 4 (2009) 2640–2650.
- [20] B. Sareni, J. Regnier, X. Roboam, Recombination and self-adaptation in multi-objective genetic algorithms, in: *Lect. Notes. Comput. Sci.*, vol. 2936, 2004, pp. 115–126.
- [21] J.S. Sobieski, B. James, A.R. Dovi, Structural optimization by multilevel decomposition, *Am. Inst. Aeronaut. Astronaut.* 21 (1985) 1291–1299.
- [22] S. Tosserams, A.T. Hofkamp, L.F.P. Etman, J.E. Rooda, A specification language for problem partitioning in decomposition-based design optimization, *Struct. Multidiscip. Optim.* 42 (2010) 707–723.
- [23] D.H. Tran, B. Sareni, X. Roboam, C. Espanet, Integrated optimal design of a passive wind turbine system: an experimental validation, *IEEE Trans. Sustainable Energy* 1 (2010) 48–56.
- [24] J.E. Vrancik, Prediction of windage power loss in alternators, NASA Glenn research center. Technical note D-4849, USA, October 1968.
- [25] D. Wismer, R. Chattergy, *Introduction To Nonlinear Programming*, North-Holland, New York, 1978.