



HAL
open science

Combinatorial Decompositions, Kirillov-Reshetikhin Invariants, and the Volume Conjecture for Hyperbolic Polyhedra

Alexander Kolpakov, Jun Murakami

► **To cite this version:**

Alexander Kolpakov, Jun Murakami. Combinatorial Decompositions, Kirillov-Reshetikhin Invariants, and the Volume Conjecture for Hyperbolic Polyhedra. *Experimental Mathematics*, 2016, pp.1 - 15. <10.1080/10586458.2016.1242441>. <hal-01396113>

HAL Id: hal-01396113

<https://hal.science/hal-01396113v1>

Submitted on 14 Nov 2016

HAL is a multi-disciplinary open access archive for the deposit and dissemination of scientific research documents, whether they are published or not. The documents may come from teaching and research institutions in France or abroad, or from public or private research centers.

L'archive ouverte pluridisciplinaire **HAL**, est destinée au dépôt et à la diffusion de documents scientifiques de niveau recherche, publiés ou non, émanant des établissements d'enseignement et de recherche français ou étrangers, des laboratoires publics ou privés.



ETALAB - Open licence

Combinatorial decompositions, Kirillov-Reshetikhin invariants and the Volume Conjecture for hyperbolic polyhedra

Alexander Kolpakov

Jun Murakami

Abstract

We suggest a method of computing volume for a simple polytope P in three-dimensional hyperbolic space \mathbb{H}^3 . This method combines the combinatorial reduction of P as a trivalent graph Γ (the 1-skeleton of P) by $I - H$, or Whitehead, moves (together with shrinking of triangular faces) aligned with its geometric splitting into generalised tetrahedra. With each decomposition (under some conditions) we associate a potential function Φ such that the volume of P can be expressed through a critical values of Φ . The results of our numeric experiments with this method suggest that one may associated the above mentioned sequence of combinatorial moves with the sequence of moves required for computing the Kirillov-Reshetikhin invariants of the trivalent graph Γ . Then the corresponding geometric decomposition of P might be used in order to establish a link between the volume of P and the asymptotic behaviour of the Kirillov-Reshetikhin invariants of Γ , which is colloquially know as the Volume Conjecture.

Key words: hyperbolic polyhedron, quantum invariant, I-H move, Whitehead move, volume.

1 Introduction

In this paper we suggest a method of computing volume for a polytope P in three-dimensional hyperbolic space \mathbb{H}^3 . We require the polytope P to be simple, so that the computation of volumes may combine two processes of initially different nature. First, a reduction of P (as a trivalent graph) to the tetrahedron by a sequence of $I - H$ (or Whitehead) and so-called “capping” moves. And second, a decomposition of P into a number of generalised tetrahedra T_i , $i = 1, \dots, n$, such that T_i partition P into geometric parts, and $\text{Vol } P = \sum_{i=1}^n \text{Vol } T_i$.

With such a decomposition we associate a function $\Phi(\ell_1, \dots, \ell_m)$, $m \geq 1$, that depends on some additional geometric parameters of the decomposition (in fact. lengths of some common perpendiculars to the faces of P). Under some conditions, we show that $\text{Vol } P$ can be expressed through the value of $\Phi(\ell_1^*, \dots, \ell_m^*)$ at a critical point $(\ell_1^*, \dots, \ell_m^*)$.

Finally, we use our method in a large number of examples, by implementing it in Wolfram Mathematica[®] [?]. We also check our computations, where possible, with the Orb software [?].

This part of our work falls in line with the recent study on the Volume Conjecture for generalised tetrahedra by Costantino and Murakami [?] and for general hyperbolic polytopes by Costantino, Guéritaud and van der Veen [?].

Next, given a polytope P , we consider its 1-skeleton Γ as a trivalent graph, compute the Kirillov-Reshetikhin invariants of Γ with an appropriate colouring of its edges determined by the corresponding dihedral angles of P and study their asymptotic behaviour. We conjecture that the sequence of combinatorial moves that is used in order to compute the Kirillov-Reshetikhin invariants of the corresponding trivalent graph Γ is associated with the sequence of moves used in the combinatorial reduction of P . Then the geometric decomposition of P associated with the respective sequence of $I - H$ and capping moves might be used in order to establish a link between the volume of P and the asymptotic behaviour of the Kirillov-Reshetikhin invariants of Γ . Such a link has been colloquially named the Volume Conjecture by various authors, and is first established in [?].

A similar study of quantum invariants in the case of manifolds with boundary has been recently performed by Chen and Yang [?].

The paper is structured as follows: after recalling some preliminary results on the volume formulas for generalised hyperbolic tetrahedra (cf. [?, ?] and [?]), we proceed to the description of our method and formulate the main statement of the paper. We illustrate our method in two main working examples: computing the volume of a hyperbolic prism Π , and that of a hyperbolic “pleated” prism \mathcal{P} . Then, we provide a more computationally complicated example of a dodecahedron with various Coxeter dihedral angles. However, the method of present paper is not restricted to Coxeter polytopes. We expect it to work in a wide variety of dihedral angles, and expect that it can be generalised to allow computing volumes of knotted trivalent graphs.

Finally, we state a number of conjectures relating the volume of a hyperbolic polyhedron P to the Kirillov-Reshetikhin invariants of its 1-skeleton Γ , viewed as a trivalent graph in the topological 3-sphere. Various numeric

experiments are described, that corroborate our conjectures.

Acknowledgements. A.K. was supported by the Swiss National Science Foundation (SNSF project no. P300P2-151316) and the Japan Society for the Promotion of Science (Invitation Programs for Research project no. S-14021). A.K. is thankful to Waseda University for hospitality during his visit. J.M. was supported by Waseda University (Grant for Special Research Projects no. 2014A-345) and the Japan Society for the Promotion of Science (Grant-in-Aid projects no. 25287014, no. 25610022).

2 Preliminaries

Below, we describe a method to compute the volume of a simple polyhedron $P \subset \mathbb{H}^3$ that admits a decomposition into generalised hyperbolic tetrahedra. We recall, that a convex polytope P is *simple* if the valence of each vertex equals the dimension of P . Here, it means that each vertex of P is trivalent. Below we define a generalised tetrahedron, and the decomposition of a given polyhedron P into such generalised tetrahedra following a simple combinatorial procedure.

We shall consider a polyhedron P both as a combinatorial object, i.e. a trivalent planar graph, and a geometric object. First of all, we deal with combinatorial polyhedra and the associated combinatorial operations or “moves” that are applied to them as to graphs.

Namely, we describe two combinatorial operations on the one-skeleton of P , associated with a decomposition into generalised tetrahedra. The first is the classical $I - H$ move, and the second is capping a triangular face with a tetrahedron:

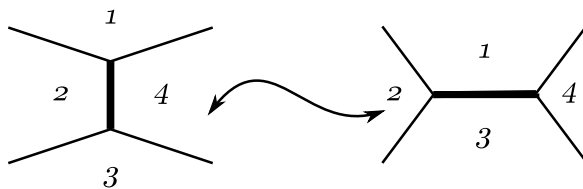

Figure 1: An $I - H$ move

1. $I - H$ move: depicted in Fig. ???. It consist of “switching” the edge between face 1 and face 3 to the edge between face 2 and face 4, and can be applied unless it collapses any of these faces.

- Capping: depicted in Fig. ???. It results in placing a tetrahedron over face 1, such that the faces 2, 3 and 4 continue until they reach the new vertex.

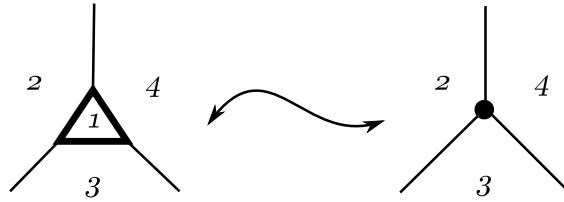

Figure 2: A “capping” move

These moves have been introduced in [?], and later used in [?, ?] for the purposes of defining a statistical sum over a spin network associated with a hyperbolic polyhedron. By following the general argument for trivalent knotted graphs in [?, §7], it’s not hard to see that the following statement holds.

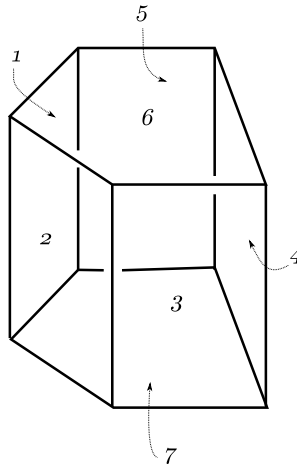

Figure 3: A pentagonal prism II

Lemma 1 *Suppose that P is a simple polyhedron, which is not a tetrahedron. Then there exists a sequence of $I-H$ moves and capping moves transforming P into a tetrahedron.*

Example. Let us take a pentagonal prism Π depicted in Fig. ?? and apply a sequence of combinatorial transformations to its one-skeleton, as shown in Fig. ??.

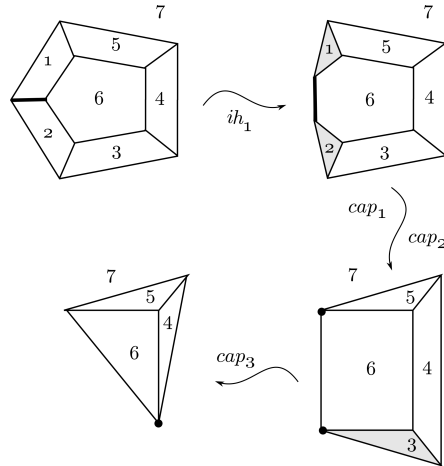

Figure 4: A sequence of $I - H$ and capping moves applied to the prism Π

Thus, having applied a short sequence of combinatorial moves we obtain a tetrahedron. \diamond

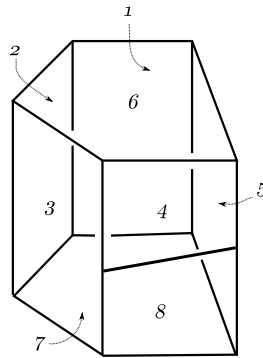

Figure 5: A pentagonal pleated prism \mathcal{P}

Example. Let us take a pentagonal pleated prism \mathcal{P} depicted in Fig. ?? and apply a sequence of combinatorial transformation to its one-skeleton, as shown in Fig. ??.

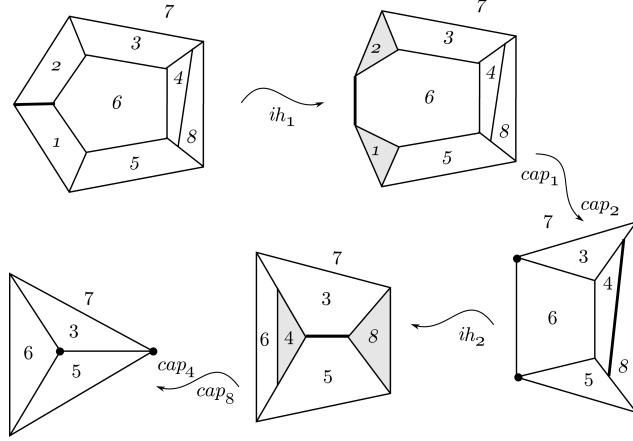

Figure 6: A sequence of $I - H$ and capping moves applied to the pleated prism \mathcal{P}

Let us define a generalised hyperbolic tetrahedron T . Let H_{n_k} , $k = \overline{1, 4}$, be four planes with the respective outer normal vectors n_k , $k = \overline{1, 4}$. We compose the generalised Gram matrix of T as the Gram matrix of the system of vectors n_k . From the matrix G we produce the dual (generalised) Gram matrix G^* of T , that corresponds to its “vertices” v_k , although some of them are outer normals to the respective polar planes P_{v_k} . We refer the reader to [?] for the standard definitions of the Gram matrices G and G^* , as well as relations between their entries.

If v_k is ultra-ideal, we associate with it a plane $H_{v_k} = P_{v_k}$, otherwise we put $H_{v_k} = \mathbb{H}^3$. Given a plane H_n with the outer normal n , let H_n^+ denote the half-space which n points to and let H_n^- denote the half-space which $-n$ points to. Then, the generalised hyperbolic tetrahedron T is defined as

$$T = \left(\bigcap_{k=1}^4 H_{n_k}^- \right) \cap \left(\bigcap_{k=1}^4 H_{v_k}^- \right).$$

Thus, each generalised tetrahedron T still can be characterised by six parameters a_1, a_2, \dots, a_6 , each of which corresponds to an edge of the “standard” tetrahedron. However, we have to distinguish two cases:

1. if the planes H_{n_i} and H_{n_j} intersect along an edge e_{ij} with parameter a_k , then we set $a_k = e^{i\alpha_k}$, where α_k is the *internal* dihedral angle along e_{ij} ;

2. if the planes H_{n_i} and H_{n_j} are ultra-parallel, then the vertices v_k and v_l are ultra-ideal and the planes H_{v_k} and H_{v_l} intersect along the common perpendicular p_{ij} to H_{n_i} and H_{n_j} : thus we set the respective parameter $a_k = e^{-\ell_k}$, where ℓ_k is the length of p_{ij} .

In Fig. ?? the case of a prism-truncated tetrahedron (see [?, ?] and [?]) is illustrated in detail. This type of generalised tetrahedron will appear quite often in the examples below, as well as several other types that we enumerate below.

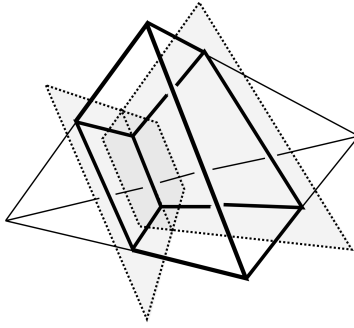

Figure 7: A prism-truncated tetrahedron

With each type of generalised tetrahedron T we associate a symbol $t|a\dots|p\dots$ where we indicate which parameters a_k correspond to dihedral angles (their indices follow the letter “a” in the symbol), and which parameters a_k correspond to common perpendiculars’ lengths (their indices follow the letter “p”). Thus, given a symbol $t|a\dots|p\dots$, we can produce the corresponding generalised tetrahedron T from the standard one by truncating the respective vertices and letting the corresponding polar planes intersect, c.f. Figures ??-?? as a source of graphical examples. Then we can recover the geometric parameters of T , such as its dihedral angles and/or edge lengths. The Gram matrix G of T in this case is still given by

$$G = \begin{pmatrix} 1 & -\frac{a_1+1/a_1}{2} & -\frac{a_2+1/a_2}{2} & -\frac{a_6+1/a_6}{2} \\ -\frac{a_1+1/a_1}{2} & 1 & -\frac{a_3+1/a_3}{2} & -\frac{a_5+1/a_5}{2} \\ -\frac{a_2+1/a_2}{2} & -\frac{a_3+1/a_3}{2} & 1 & -\frac{a_4+1/a_4}{2} \\ -\frac{a_6+1/a_6}{2} & -\frac{a_5+1/a_5}{2} & -\frac{a_4+1/a_4}{2} & 1 \end{pmatrix}, \quad (1)$$

as if T were a “usual” tetrahedron: it is still sufficient to determine T uniquely, up to an isometry (see [?, ?] and [?]).

Given a generalised hyperbolic tetrahedron T with Gram matrix (??), we define the following auxiliary quantities in order to state a formula for $\text{Vol } T$. Let $\mathcal{U} = \mathcal{U}(a_1, a_2, a_3, a_4, a_5, a_6, z)$ denote the function

$$\begin{aligned} \mathcal{U} = & \text{Li}_2(z) + \text{Li}_2(a_1 a_2 a_4 a_5 z) + \text{Li}_2(a_1 a_3 a_4 a_6 z) + \text{Li}_2(a_2 a_3 a_5 a_6 z) \\ & - \text{Li}_2(-a_1 a_2 a_3 z) - \text{Li}_2(-a_1 a_5 a_6 z) - \text{Li}_2(-a_2 a_4 a_6 z) - \text{Li}_2(-a_3 a_4 a_5 z) \end{aligned} \quad (2)$$

depending on seven complex variables a_k , $k = \overline{1, 6}$ and z , where $\text{Li}_2(\circ)$ is the dilogarithm function.

Let z_- and z_+ be two solutions to the equation $e^{z \frac{\partial \mathcal{U}}{\partial z}} = 1$ in the variable z . According to [?], these are

$$z_- = \frac{-q_1 - \sqrt{q_1^2 - 4q_0 q_2}}{2q_2} \quad \text{and} \quad z_+ = \frac{-q_1 + \sqrt{q_1^2 - 4q_0 q_2}}{2q_2}, \quad (3)$$

where

$$q_0 = 1 + a_1 a_2 a_3 + a_1 a_5 a_6 + a_2 a_4 a_6 + a_3 a_4 a_5 + a_1 a_2 a_4 a_5 + a_1 a_3 a_4 a_6 + a_2 a_3 a_5 a_6,$$

$$\begin{aligned} q_1 = & -a_1 a_2 a_3 a_4 a_5 a_6 \left(\left(a_1 - \frac{1}{a_1} \right) \left(a_4 - \frac{1}{a_4} \right) + \left(a_2 - \frac{1}{a_2} \right) \left(a_5 - \frac{1}{a_5} \right) \right. \\ & \left. + \left(a_3 - \frac{1}{a_3} \right) \left(a_6 - \frac{1}{a_6} \right) \right), \end{aligned} \quad (4)$$

$$\begin{aligned} q_2 = & a_1 a_2 a_3 a_4 a_5 a_6 (a_1 a_4 + a_2 a_5 + a_3 a_6 + a_1 a_2 a_6 + a_1 a_3 a_5 + a_2 a_3 a_4 + \\ & a_4 a_5 a_6 + a_1 a_2 a_3 a_4 a_5 a_6). \end{aligned}$$

Given a function $f(x, y, \dots, z)$, let $f(x, y, \dots, z) \Big|_{z=z_+}^{z=z_-}$ denote the difference $f(x, y, \dots, z_-) - f(x, y, \dots, z_+)$. Now we define the following function $\mathcal{V} = \mathcal{V}(a_1, a_2, a_3, a_4, a_5, a_6, z)$ by means of the equality

$$\mathcal{V} = \frac{i}{4} \left(\mathcal{U}(a_1, a_2, a_3, a_4, a_5, a_6, z) - z \frac{\partial \mathcal{U}}{\partial z} \log z \right) \Big|_{z=z_+}^{z=z_-}. \quad (5)$$

Depending on the type $t|a\dots|p\dots$ of the tetrahedron T , we consider the following cases.

1. *One pair of ultra-parallel faces.* This is a prism truncated tetrahedron T , that has the symbol $t|aijklm|pn$ for $i, j, k, l, m, n \in \{1, \dots, 6\}$. In Fig. ??, we illustrate the case $t|a12356|p4$.

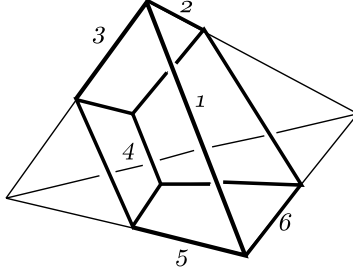

Figure 8: A tetrahedron of type $t|a12356|p4$

The volume of T can be expressed by the formula

$$\text{Vol } T = \Re \left(-\mathcal{V} + a_4 \frac{\partial \mathcal{V}}{\partial a_4} \log a_4 \right), \quad (6)$$

where $\mathcal{V} = \mathcal{V}(a_1, \dots, a_6)$ is the “volume function”, as described in [?].

2. *Two pairs of ultra-parallel faces.* In Fig. ??, illustrate the case $t|a2356|p14$. Here, all the vertices of T are ultra-ideal.

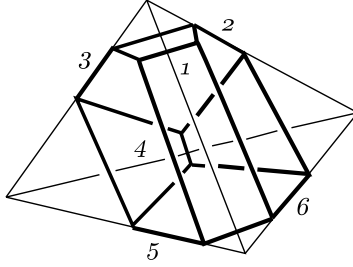

Figure 9: A tetrahedron of type $t|a2356|p14$

In complete analogy to the proof of [?, Proposition 3], we can show that the volume of T in this case equals

$$\text{Vol } T = \Re \left(-\mathcal{V} + \sum_{k \in \{1,4\}} a_k \frac{\partial \mathcal{V}}{\partial a_k} \log a_k \right). \quad (7)$$

3. *Two pairs of ultra-parallel faces, another configuration.* A tetrahedron of type $t|a1234|p56$ is depicted in Fig. ?. Here, three vertices v_1, v_2 and v_3 are ultra-ideal and the vertex v_4 is proper.

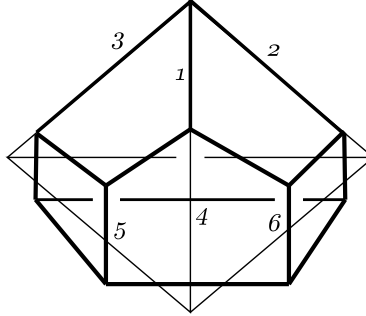

Figure 10: A tetrahedron of type $t|a1234|p56$

The volume of T is

$$\text{Vol} T = \Re \left(-\mathcal{V} + \sum_{k \in \{5,6\}} a_k \frac{\partial \mathcal{V}}{\partial a_k} \log a_k \right). \quad (8)$$

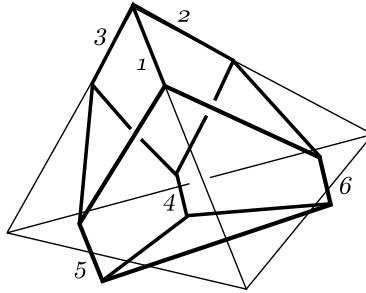

Figure 11: A tetrahedron of type $t|a123|p456$

4. *One face that is ultra-parallel to three others.* In Fig. ??, a tetrahedron of type $t|a123|p456$ is shown. Here, three faces are adjacent around the proper vertex v_4 , while three other vertices v_1 , v_2 and v_3 are ultra-ideal.

The volume of T is

$$\text{Vol} T = \Re \left(-\mathcal{V} + \sum_{k \in \{4,5,6\}} a_k \frac{\partial \mathcal{V}}{\partial a_k} \log a_k \right). \quad (9)$$

5. *Four pairs of ultra-parallel faces.* We illustrate the case $t|a14|p2356$ in Fig. ?. Here, T has only ultra-ideal vertices and its faces are arranged in

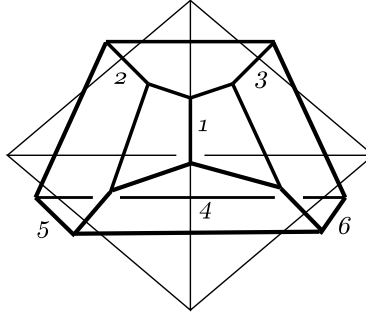

Figure 12: A tetrahedron of type $t|a14|p2356$

two groups: the faces 1 and 2 intersect along an edge, the faces 3 and 4 intersect along an edge, and each face in the pair $\{1, 2\}$ is ultra-parallel to any face in the pair $\{3, 4\}$.

The volume of T equals

$$\text{Vol } T = \Re \left(-\mathcal{V} + \sum_{k \in \{2,3,5,6\}} a_k \frac{\partial \mathcal{V}}{\partial a_k} \log a_k \right). \quad (10)$$

Lemma 2 *The volume of a generalised hyperbolic tetrahedron can be expressed by one of the formulae (??)-(??).*

The proof of the lemma above is analogous to the proof of [?, Proposition 3] (each of the above formulae are simplified versions of [?, Theorem 1]). We also refer the reader to [?] for a geometric interpretation of the extra terms involving derivatives of \mathcal{V} in the volume formulae above.

Let us now reconsider the previous examples of a pentagonal prism Π and a pleated prism \mathcal{P} . We shall derive a geometric decomposition for each of them from the associated sequence of combinatorial transformations.

Remark. The geometric decomposition may look quite different from the combinatorial picture. Although it is directed by a sequence of I_H and “capping” moves, each such a move result in “chopping off” a *generalised* tetrahedron from the polyhedron P . The geometric shapes of polyhedra in each step of such a decomposition will vary from what is present in the combinatorial picture where only the 1-skeleton of P is modified as a trivalent graph.

Example. Let us consider the first transformation ih_1 of the prism Π , as depicted in Fig. ??. Let us suppose that the common perpendicular p_{67} to

the plane 6 and the plane 7 is situated entirely inside Π . Then we draw two planes S_1 and S_2 orthogonal to the sides 1 and 2 of Π , and passing through p_{67} . Suppose these planes land on the sides of Π in its interior. Then we cut along Π along the planes S_1 and S_2 , and thus “chop off” a polyhedron T_1 bounded by the planes of the faces 1, 2, 6 and 7 intersecting along the respective edges (or, more precisely, parts of edges) of the initial prism Π , and the planes S_1 and S_2 intersecting along p_{67} . Let us note that T_1 is nothing but a generalised tetrahedron of type $t|a12345|p6$.

The capping transformations cap_1 , cap_2 and cap_3 in Fig. ?? correspond to further “chopping off” of generalised tetrahedra (of type $t|a12345|p6$):

- the tetrahedron T_2 , formed by the planes 2, 3, 6, 7, and the planes S_2 , S_3 (orthogonal to the faces 2 and 3, respectively),
- the tetrahedron the tetrahedron T_3 , formed by the planes 1, 5, 6, 7, and the planes S_3 , S_5 (orthogonal to the faces 1 and 5, respectively),
- the tetrahedron the tetrahedron T_4 , formed by the planes 3, 4, 6, 7, and the planes S_3 , S_4 (orthogonal to the faces 3 and 4, respectively).

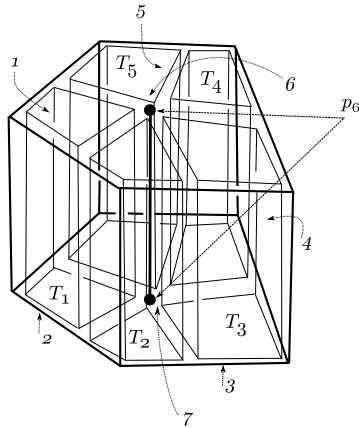

Figure 13: A geometric decomposition of Π into tetrahedra T_i , $i = 1, \dots, 5$, of type $t|a12345|p6$

In each case we assume that the plane S_k lands orthogonally on the k -th face of Π in its interior. Thus, the prism Π is divided into generalised tetrahedra. The last tetrahedron in Fig. ?? corresponds to the generalised tetrahedron T_5 formed by the planes 4, 5, 6, 7 and S_4 , S_5 .

The geometric decomposition of the prism Π following the combinatorial moves in Fig. ?? is depicted in Fig. ??, with all the tetrahedra T_i marked.

◇

Example. Let us consider the first transformation ih_1 of the pleated prism \mathcal{P} . Let us suppose that the common perpendiculars to any pairs of faces lie inside \mathcal{P} , if they exist. Let us take the common perpendicular p_{67} to the plane 6 and the plane 7. Then we perform the transformation ih_1 on the edge e_{12} (the intersection of the planes 1 and 2). This results in detaching a generalised tetrahedron T_1 , corresponding to the planes 1, 2, 6 and 7 (the normals to these planes determine T_1 completely through the corresponding Gram matrix, however there are two more polar planes bounding it), whose edges consist of the edges involved in the ih_1 move, and the edges coming from the intersection of the planes S_1 and S_2 , orthogonal to the faces 1 and 2, and passing through the common perpendicular p_{67} to the plane 6 and the plane 7. The planes S_1 and S_2 intersect along p_{67} and land on the faces 1 and 2, respectively, as well as they intersect the planes 6 and 7, yielding seven new edges in total.

Here and below we suppose that each plane S_k , orthogonal to the k -th face of \mathcal{P} , lands on it orthogonally and inside \mathcal{P} .

The transformations cap_1 and cap_2 , which result in capping the triangular faces in Fig. ?? mean further detaching of the generalised tetrahedra T_2 and T_3 , each defined by the outer normals to the four planes 2, 3, 6, 7 and 1, 5, 6, 7, respectively.

Now we consider the transformation ih_2 performed on the edge e_{48} (the intersection of planes 4 and 8). We take the common perpendicular p_{35} to the planes 3 and 5, and again suppose that it lies inside the pleated prism \mathcal{P} . We draw two planes passing through p_{35} : S_4 orthogonal to the face 4, and S_8 orthogonal to the face 8. Now, we detach one more generalised tetrahedron T_4 defined by the planes 3, 4, 5 and 8.

The transformation c_3 and c_4 correspond to detaching two more tetrahedra: T_5 defined by the planes 3, 5, 6 and 8, and T_6 defined by the planes 3, 5, 4 and 7.

Here we supposed that all possible common perpendiculars are situated inside \mathcal{P} , the planes coming through the common perpendiculars orthogonally to the faces of \mathcal{P} land in the interior of the faces, and the generalised tetrahedra T_k do not overlap. In other words, we suppose that the tetrahedra T_k form a decomposition of \mathcal{P} : we shall write $\mathcal{P} = \sqcup_k T_k$. ◇

Below we give examples where the above decomposition is realised for a concrete polyhedron, having the combinatorial type of a pentagonal prism

or a pleated prism and prescribed dihedral angles.

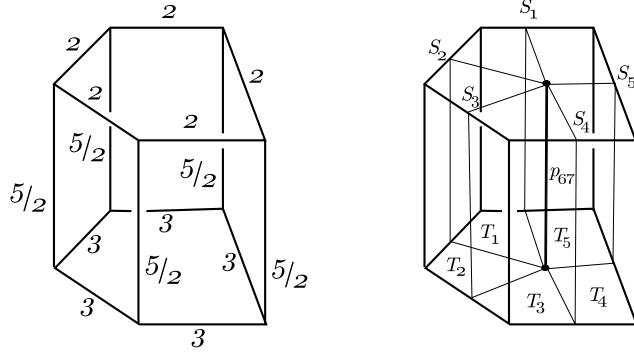

Figure 14: A geometric realisation of the prism Π with given dihedral angles, and its decomposition into generalised tetrahedra

Example. Let us consider the pentagonal prism Π depicted in Fig. ???. Each edge of Π is labelled with an label q/p , corresponding to a dihedral angle of $p\pi/q$. In this case, the common perpendicular p_{67} to the planes 6 and 7 lies entirely inside the prism Π , and the planes S_k , $k = 1, \dots, 5$ passing through p_{67} and orthogonal to the sides of Π subdivide the prism into five “prism truncated” tetrahedra T_k (i.e. tetrahedra of type $t|a12345|p6$), $k = \overline{1, 5}$, which are mutually isometric. In this decomposition all the generalised tetrahedra T_k have disjoint interiors, and $\Pi = \sqcup_{k=1}^5 T_k$. The volume of each T_k , as well as the volume of the prism Π is computed in [?]: $\text{Vol } T_k = 0.52639$, $\text{Vol } \Pi = 5 \cdot \text{Vol } T_k \approx 2.63200$. Here we use formula (??) to compute the volumes of all T_k , $k = 1, \dots, 5$.

As described in [?], the volume computation proceeds by defining the function

$$\Phi(\ell) = \sum_{k=1}^5 \text{Vol } T_k + \pi\ell,$$

where ℓ is the length of the common perpendicular p_{56} , and solving the equation

$$\frac{\partial \Phi(\ell)}{\partial \ell} = 0.$$

We can transform the last equation into an algebraic equation about $x = e^{-\ell}$:

$$e^{\frac{\partial \Phi}{\partial \ell}} = 1.$$

This equation can be easily solved, which allows us to determine the necessary parameter ℓ . \diamond

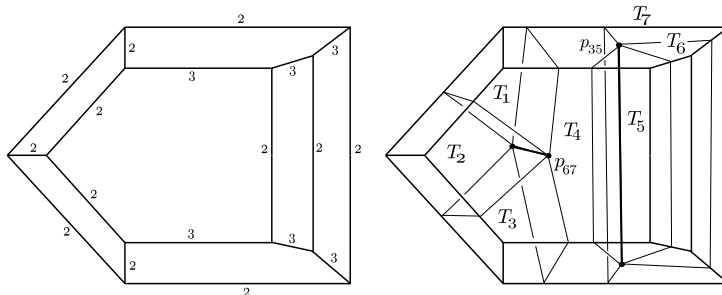

Figure 15: A geometric realisation of the prism \mathcal{P} with given dihedral angles, and its decomposition into generalised tetrahedra

Example. Now we consider the pleated prism \mathcal{P} depicted in Fig. ?? together with the labels for its dihedral angles. The common perpendiculars $p_1 = p_{67}$ (to the planes 6 and 7) and $p_2 = p_{35}$ (to the planes 3 and 5) in this case lie inside \mathcal{P} , and the planes S_k , $k = 1, \dots, 8$, passing through each of them, respectively, land orthogonally into the interior of the k -th face. Then the pleated prism \mathcal{P} is decomposed into seven generalised tetrahedra T_k : six are of type $t|a12345|p6$ (the tetrahedra 1-3 and 5-7), and one is of type $t|a2356|p14$ (the tetrahedron 4 in the middle).

We compute the volume of \mathcal{P} . In order to do so, let ℓ_k , $k = 1, 2$, denote the length of p_k . Then we have

$$\text{Vol } \mathcal{P} = \sum_{k=1}^7 \text{Vol } T_k,$$

where we use formula (??) for the tetrahedra T_k , $k \in \{1, 2, 3, 5, 6, 7\}$ (of type $t|a12345|p6$) and formula (??) for the tetrahedron T_4 (of type $t|a2356|p14$). The tetrahedra T_k form the pleated prism \mathcal{P} when the angle sum around each p_l equals 2π . The dihedral angle along the edge playing the role of p_l in each generalised tetrahedron equals

$$\alpha_{p_l}(T_k) = 2a_6 \frac{\partial \mathcal{V}}{\partial a_6}(T_k) \pmod{\pi},$$

with $l = 1$ for the tetrahedra T_k , $k \in \{1, 2, 3\}$ and $l = 2$ for the tetrahedra T_k , $k \in \{5, 6, 7\}$, while

$$\alpha_{p_1}(T_4) = 2a_1 \frac{\partial \mathcal{V}}{\partial a_1}(T_4) \pmod{\pi}, \quad \alpha_{p_2}(T_4) = 2a_4 \frac{\partial \mathcal{V}}{\partial a_4}(T_4) \pmod{\pi}.$$

Let us put

$$\Phi(\ell_1, \ell_2) = \sum_{k=1}^7 \text{Vol } T_k + \pi \sum_{k \in \{1,2\}} \ell_k.$$

Then, from the above equations, we deduce that ℓ_k is a solution to the system of equations

$$\frac{\partial \Phi}{\partial \ell_k} = 0, \quad k = 1, 2.$$

We can transform the above equations into a system of algebraic equations in the variables $x_k = e^{-\ell_k}$:

$$e^{\frac{\partial \Phi}{\partial \ell_k}} = 1, \quad k = 1, 2.$$

This equation is as a polynomial equation in the variables x_k , and can be easily solved by computer. Moreover, the functions $\frac{\partial \Phi}{\partial \ell_k}$ are monotone in each variable ℓ_k , $k = 1, 2$, while keeping the other variable fixed (in the domain where the function Φ is defined). This follows from the fact that the respective dihedral angles of the tetrahedra T_k , $k = 1, \dots, 7$, are monotone functions of ℓ_k , $k = 1, 2$ (cf. Fig. ??).

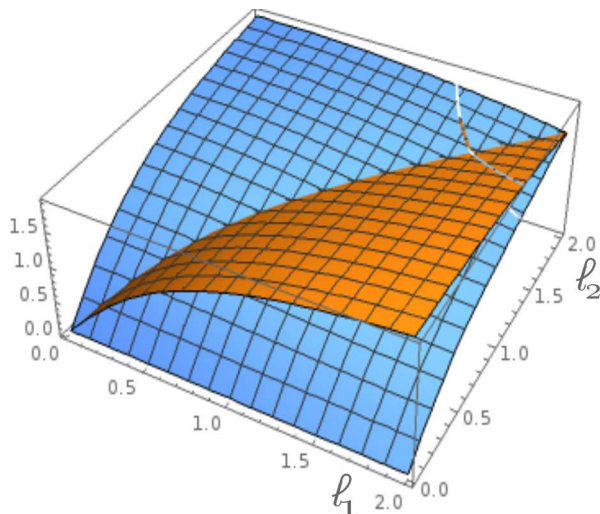

Figure 16: The dihedral angles of the tetrahedron T_4 as functions of edge lengths ℓ_1 and ℓ_2 (the graph is symmetric under exchanging ℓ_1 and ℓ_2)

Solving the above equations about ℓ_k , we obtain that they have a unique common solution $(\ell_1, \ell_2) \approx (0.383438, 1.06239)$, and the volume of \mathcal{P} is

consequently equal to ~ 2.34308 . Here we use formula (??) to compute the volumes of T_k , $k \in \{1, 2, 3, 5, 6, 7\}$, and formula (??) to compute the volume of T_4 . \diamond

3 Volume of a polyhedron

We prove the following theorem, that allows us for computing the volume of a finite-volume simple polyhedron P , provided it has a decomposition into generalised tetrahedra, e.g. produced by a sequence of $I - -H$ and “capping” moves. Here, by a decomposition we mean a subdivision of P into non-overlapping generalised tetrahedra. An analogous synthesis of a combinatorial decomposition followed by a geometric volume computation may be found in [?, ?] as applied to Euclidean polyhedra.

Theorem 1 *Let $P \subset \mathbb{H}^3$ be a finite-volume simple polyhedron that admits a decomposition into generalised tetrahedra T_k . Then the volume of P can be expressed as*

$$\text{Vol } P = \sum_k \text{Vol } T_k(a_{k1}, \dots, a_{k6}), \quad (11)$$

where a_{kl} are the six angle/length parameters corresponding to each generalised tetrahedron, the angle parameters $a_{kl} = e^{i\alpha_{kl}}$ come from the original dihedral angles of the polyhedron, and the edge parameters $a_{kl} = e^{-\ell_{kl}}$ are determined from a solution to the system of algebraic equations, in which each equation is associated with a common perpendicular p_{kl} to some faces F_k and F_l of P serving as an edge for a number of generalised tetrahedra T_m ,

$$e^{\frac{\partial \Phi_{kl}(\ell_{kl})}{\partial \ell_{kl}}} = 1, \quad (12)$$

with

$$\Phi_{kl}(\ell_{kl}) = \sum_{p_{kl} \cap T_m \neq \emptyset} \text{Vol } T_m(a_{m1}, \dots, a_{m6}) + \pi \sum \ell_{kl}, \quad (13)$$

where each monomial in the variables a_{kl} has degree at most four.

Proof. We have that

$$\frac{\partial \Phi_{kl}(\ell_{kl})}{\partial \ell_{kl}} = - \sum_{p_{kl} \cap T_m \neq \emptyset} \frac{\alpha_{kl}}{2} + \pi, \quad (14)$$

where α_{kl} is the dihedral angle along an edge of a generalised tetrahedron T_m , corresponding to a common perpendicular p_{kl} to some faces F_k and F_l of P .

Since the polyhedron P admits a decomposition into generalised tetrahedra T_k , then for some length parameters ℓ_{kl} (which will be the same for each tetrahedron T_m whose edge ℓ_{kl} coincides with the common perpendicular p_{kl}) we have

$$\sum_{p_{kl} \cap T_m \neq \emptyset} \alpha_{kl} = 2\pi. \quad (15)$$

Thus, (??) implies (??) for these length ℓ_{kl} .

Looking at the expression for the function $\text{Vol } T_k$, we observe that $\frac{\partial \Phi_{kl}(\ell_{kl})}{\partial \ell_{kl}}$ consists of expressions having the form $\log(1 + m_t)$, where m_t is a monomial in the parameters a_{kl} . The longest monomial m has the form $a_{k_1 l_1} a_{k_2 l_2} a_{k_3 l_3} a_{k_4 l_4}$. Thus, if all $a_{k_m k_n}$ happen to be edge parameters (i.e. $a_{k_m k_n} = e^{-\ell_{k_m k_n}}$) then we have an equation of degree four, at most. \square

Let us call a finite-volume polyhedron $P \subset \mathbb{H}^3$ “width uniform” if all the common perpendiculars to its facets lie inside P . We also recall that $P \subset \mathbb{H}^3$ is called a Coxeter polyhedron if all its dihedral angles are integer sub-multiples of π , i.e. have the form π/m , for an integer $m \geq 2$. These polyhedra form an important class widely used in further constructions of hyperbolic orbifolds and manifolds [?]. The following fact obviously holds as a consequence of geodesic convexity.

Lemma 3 *Every Coxeter polytope (or, more generally, every acute-angled polyhedron) is width uniform.*

A width uniform polyhedron has a geometric decomposition into generalised tetrahedra. We also notice that each polytope P may be decomposed into a number of generalised tetrahedra T_k following a sequence of $I - H$ and “capping” moves, although Theorem ?? may not apply directly. E.g. some of the T_k ’s may overlap, and thus we shall need to use the “inclusion-exclusion” formula in order to express the volume of P through the volumes of T_k . As well, some of the polar hyperplanes bounding T_k may land on the faces of P entirely or partially outside P forming “butterfly” generalised tetrahedra, some of which are depicted in Fig. ??, c.f. [?].

The volume formula of [?] works in either case, however, the glueing equations (??)-(??) will not have a unique solution. Still, the value of the volume of P can be found by using *some* solution among (usually few) solutions of the glueing equations.

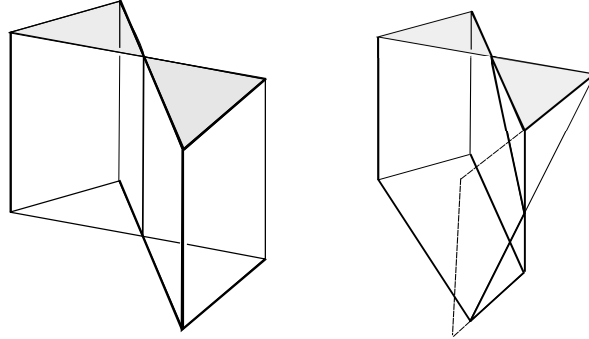

Figure 17: Some examples of “butterfly” generalised tetrahedra

4 Further computational examples

Below we give more numeric examples of volume computation for several polytopes. We start with the pleated prism \mathcal{P} , and then proceed to a dodecahedron \mathcal{D} . We shall use Coxeter dihedral angles (i.e. dihedral angles of the form π/n , for n a natural number ≥ 2), so we can “double-check” the volume of each polytope P with the following procedure: the volume of P equals the volume of the reflection orbifold obtained from P by mirroring all its faces. We create a “double” of the respective reflection orbifold, which is an orientable orbifold $\mathcal{O}(P)$ with underlying space the three-sphere \mathbb{S}^3 , and singular set combinatorially isomorphic to the 1-skeleton of P . Each singular edge e carries an angle of $2\pi/n$, corresponding to the angle of π/n in the original polytope P . The volume of $\mathcal{O}(P)$ can be computed by the “Orb” software [?], and $\text{Vol } \mathcal{O}(P) = 2 \text{Vol } P$.

First, we pick the pleated prism \mathcal{P} from our previous example, and reduce it to a tetrahedron by a different sequence of $I - H$ and capping moves depicted in Fig. ???. Thus, the position of the common perpendiculars in the new subdivision will be different.

As shown in Fig. ??, we have again 7 tetrahedra to consider, five of which are of the type $t|a12356|p4$ (the tetrahedra T_i , $i \in \{1, 2, 3, 6, 7\}$), and two are of the type $t|a1234|p56$ (the tetrahedra T_i , $i \in \{4, 5\}$). Here, our computations find that the length of the common perpendicular $p_1 = p_{67}$ to the planes 6 and 7 is $\ell_1 \approx 0.383438$, and the length of the common perpendicular $p_2 = p_{47}$ to the planes 4 and 7 is $\ell_2 \approx 0.626516$. The volume of the prism \mathcal{P} equals, as before, $\text{Vol } \mathcal{P} \approx 2.34308$.

By using various sequences of $I - H$ and capping moves, and therefore

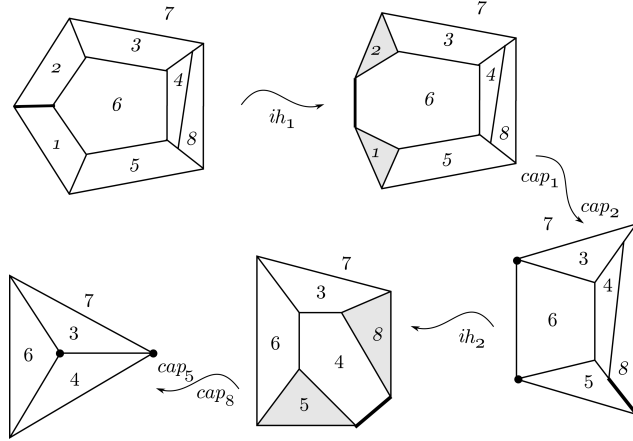

Figure 18: Another sequence of $I - H$ and capping moves reducing the pleated prism \mathcal{P} to a tetrahedron

various geometric decompositions, we also found the volumes of pleated prisms depicted in Fig. ??.

Finally, we use our method to compute the volume of a hyperbolic dodecahedron \mathcal{D} . The sequence of $I - H$ and capping moves is presented in Fig. ??-Fig. ??, and leads to the following generalised tetrahedra in the geometric decomposition:

- 6 generalised tetrahedra of type $t|a12356p4$,
- 6 generalised tetrahedra of type $t|a1234p56$,
- 2 generalised tetrahedra of type $t|a123p456$,
- 2 generalised tetrahedra of type $t|a14p2356$.

We consider three distinct dodecahedra: \mathcal{D}_1 with all right angles, \mathcal{D}_2 with all dihedral angles equal to $\pi/3$, and \mathcal{D}_3 with angles from the set $\{\pi/2, \pi/3, \pi/4\}$ distributed as depicted in Fig. ?. The volumes of these dodecahedra equal respectively $\text{Vol } \mathcal{D}_1 \approx 4.30621$, $\text{Vol } \mathcal{D}_2 \approx 20.5802$, $\text{Vol } \mathcal{D}_3 \approx 5.70085$.

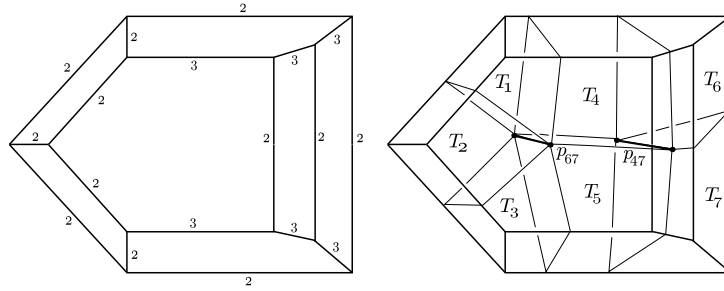

Figure 19: A geometric realisation of the pleated prism \mathcal{P} with given dihedral angles, and its decomposition into generalised tetrahedra

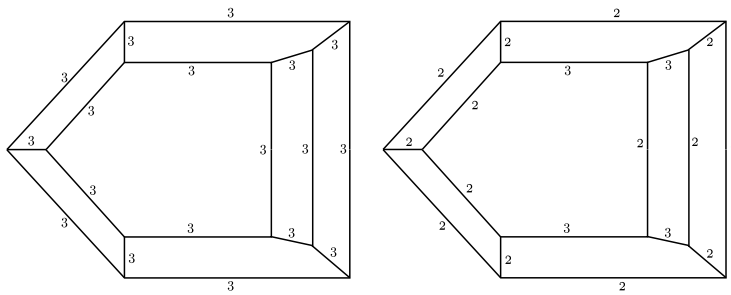

Figure 20: Various pleated prisms with volumes ~ 9.52855 (left: this one has all ideal vertices) and ~ 1.792925 (right: it has many right angles and thus considerably smaller volume)

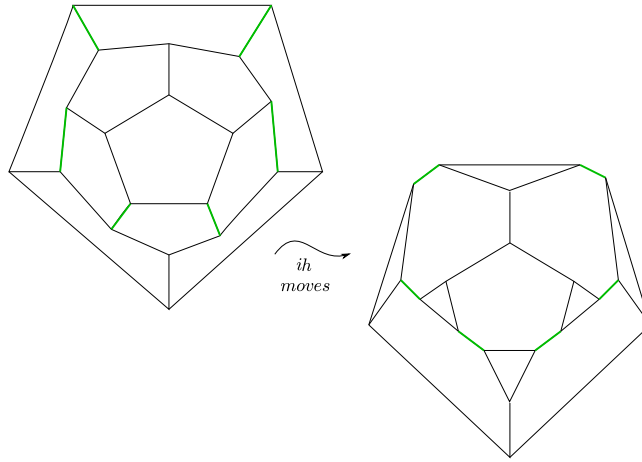

Figure 21: The sequence of $I - H$ and capping moves for a dodecahedron

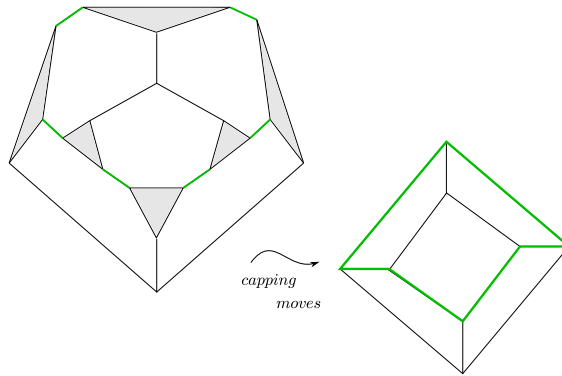

Figure 22: The sequence of $I - H$ and capping moves for a dodecahedron

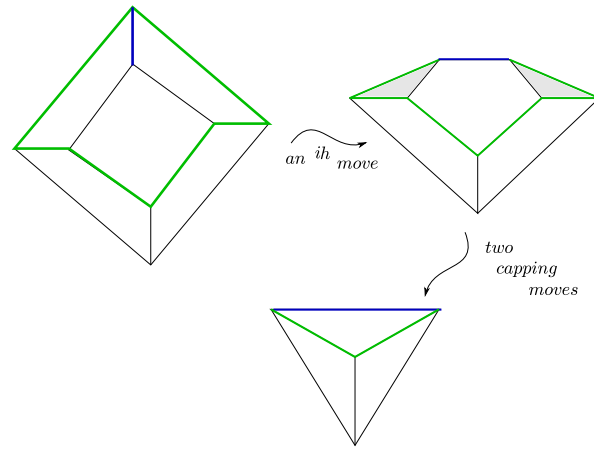

Figure 23: The sequence of $I - H$ and capping moves for a dodecahedron

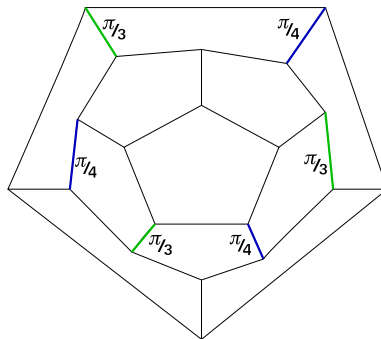

Figure 24: A geometric realisation of the dodecahedron \mathcal{D}_3 with a rotational symmetry of order 3. All unlabelled edges have dihedral angles $\pi/2$, the labelled ones have dihedral angles $\pi/3$ and $\pi/4$ in the alternating fashion.

5 Computing Kirillov-Reshetikhin invariants and the Volume Conjecture

We conjecture that the way in which a width-uniform polytope $P \subset \mathbb{H}^3$ is decomposed into generalised tetrahedra may be related to the sequence of combinatorial moves in which the Kirillov-Reshetikhin invariants [?] of the corresponding trivalent graph Γ (given by the 1-skeleton of P) are computed. The following conjecture relating the volume $\text{Vol } P$ to the asymptotic behaviour of the Kirillov-Reshetikhin invariants of Γ has been corroborated by the results of our numerical experiments.

Conjecture 1 *Let $P \subset \mathbb{H}^3$ be a hyperbolic polyhedron with edges e_1, \dots, e_m and dihedral angle along each edge e_i , $i = 1, \dots, m$, respectively, α_i . Let Γ be the planar graph represented by the 1-skeleton of P . Let $c^{(r)}$ be a sequence of admissible colourings $s_i^{(r)}$ ($1 \leq i \leq m, r = 3, 5, 7, \dots$) for the edges e_1, \dots, e_m of Γ such that*

$$4\pi \lim_{n \rightarrow \infty} \frac{s_i^{(r)}}{r} = \pi - \alpha_i,$$

then

$$2\pi \lim_{r \rightarrow \infty} \frac{\log \langle \Gamma, c^{(r)} \rangle}{r} = \text{Vol } P,$$

where $\langle \Gamma, c^{(r)} \rangle$ is the unitary spin network (the Kirillov-Reshetikhin invariant with framing $c^{(r)}$, $r = 3, 5, \dots$) associated with Γ , c.f. [?, ?] and the root of unity is specified at $q = \exp\left(\frac{4\pi i}{r}\right)$.

First we recall some necessary basic definition that are used in our computation below. Let $r \geq 3$ be a odd integer, $q = \exp(4\pi i/r)$ and the quantum number $\{n\}$ and factorial $\{n\}!$ be defined as

$$\{n\} = q^{n/2} - q^{-n/2}, \quad \{n, k\} = \{n\} \{n-1\} \cdots \{n-k+1\}, \quad \{n\}! = \{n, n\}.$$

The Racah-Wigner quantum $6j$ -symbol is defined for six half-integers a, b, c, d, e, f in the set $\{0, 1/2, 1, 3/2, \dots, (r-2)/2\}$ and the actual formula is given by [?] as follows:

$$\left\{ \begin{array}{ccc} a & b & e \\ d & c & f \end{array} \right\}_q^{RW} = \Delta(a, b, e) \Delta(a, c, f) \Delta(b, d, f) \Delta(c, d, e) \times$$

$$\sum_z \frac{(-1)^z \{z+1\}!}{\{1\} \{z-A_1\}! \{z-A_2\}! \{z-A_3\}! \{z-A_4\}! \{B_1-z\}! \{B_2-z\}! \{B_3-z\}!},$$

where

$$A_1 = a + b + e, \quad A_2 = a + c + f, \quad A_3 = b + d + f, \quad A_4 = c + d + e,$$

$$B_1 = a + b + c + d, \quad B_2 = a + d + e + f, \quad B_3 = b + c + e + f,$$

$$\Delta(x, y, z) = \sqrt{\frac{\{-x + y + z\}! \{x - y + z\}! \{x + y - z\}! \{1\}}{\{x + y + z + 1\}!}}.$$

and z runs from $\max(A_1, A_2, A_3, A_4)$ to $\min(B_1, B_2, B_3)$.

Above we suppose that the triples (a, b, e) , (a, c, f) , (b, d, f) and (c, d, e) are all *admissible*. Here, a triple of half integers (x, y, z) in $\{0, 1/2, \dots, (r-2)/2\}$ is said to be admissible if x, y, z satisfy

$$x + y + z \in \mathbb{Z}, \quad x + y + z \leq r - 2, \quad 0 \leq x + y - z, \quad x - y + z, \quad -x + y + z.$$

The actual computation of the Kirillov-Reshetikhin invariant of a coloured trivalent graph Γ with colouring c follows the skein relations (4.1)-(4.13) and (5.4), (5.6) described in [?].

Example. Let Π be the pentagonal prism depicted in Fig. ?? . Let Γ be the planar graph given by the 1-skeleton of Π , with edges e_1, \dots, e_{15} , and the corresponding dihedral angles $\alpha_1, \dots, \alpha_{15}$ along them. Here, we have that $\alpha_i \in \{\frac{\pi}{2}, \frac{\pi}{3}, \frac{2\pi}{5}\}$. Let $c^{(r)}$ be the sequence of colourings $s_i^{(r)}$, $i = 1, \dots, 15$, $r = 3, 5, 7, \dots$ of the edges e_i of Γ such that the conditions of Conjecture ?? are satisfied. This means that we have $s_i^{(r)} = \lfloor \frac{r-3}{4} \rfloor$ for each $\alpha_i = \frac{\pi}{2}$, $s_i^{(r)} = \lfloor \frac{r-3}{3} \rfloor$ for each $\alpha_i = \frac{\pi}{3}$, and $s_i^{(r)} = \lfloor \frac{3(r-3)}{10} \rfloor$ for each $\alpha_i = \frac{2\pi}{5}$.

Then the unitary spin network associated with Γ evaluates into

$$\langle \Gamma, c^{(r)} \rangle = \sum_k (-1)^k \frac{\{k+1\}}{\{1\}} \left(\left\{ \left\{ \begin{matrix} \lfloor \frac{r-3}{3} \rfloor & \lfloor \frac{r-3}{3} \rfloor & \lfloor \frac{3(r-3)}{10} \rfloor \\ \lfloor \frac{r-3}{4} \rfloor & \lfloor \frac{r-3}{4} \rfloor & k \end{matrix} \right\} \right\}_{q=\exp(\frac{4\pi i}{r})}^{RW} \right)^5.$$

In Table ?? we collect the results of numerical computations of the quantity $V(r) = \frac{2\pi}{r} \log \langle \Gamma, c^{(r)} \rangle$ for various odd values of r .

r	483	963	1923	3843	Vol Π
$V(r)$	2.27094	2.42388	2.51421	2.56627	≈ 2.63200

Table 1: The values of Kirillov-Reshetikhin invariants for Π

We also perform numerical computations for the pleated prism \mathcal{P} depicted in Fig. ?? . The numeric values of its Kirillov-Reshetikhin invariants are given in Table ?? for various odd values of r .

r	483	963	1923	3843	Vol \mathcal{P}
$V(r)$	1.89647	2.08527	2.19702	2.26150	≈ 2.34308

Table 2: The values of Kirillov-Reshetikhin invariants for \mathcal{P}

Analogous, however way more tedious computations may be carried out in the case of the hyperbolic dodecahedra \mathcal{D}_i , $i = 1, 2, 3$, described in Section ?? . \diamond

Each time an $I - H$ move or a capping move is performed on Γ , we have a generalised tetrahedron detached from the polyhedron P . As a step towards verification of Conjecture ?? we suggest investigating if the following statements hold.

Conjecture 2 *Let $\alpha, \beta, \gamma, \delta, \epsilon, \phi$ be the dihedral angles of a generalised hyperbolic tetrahedron T , which may have ideal and ultra-ideal vertices, though no truncating polar planes determined by its ultra-ideal vertices intersect. Let $a^{(r)}, b^{(r)}, \dots, f^{(r)}$, $r = 3, 5, 7, \dots$ be sequences of integers satisfying*

$$4\pi \lim_{r \rightarrow \infty} \frac{a^{(r)}}{r} = \pi - \alpha, \quad 4\pi \lim_{r \rightarrow \infty} \frac{b^{(r)}}{r} = \pi - \beta, \quad 4\pi \lim_{r \rightarrow \infty} \frac{c^{(r)}}{r} = \pi - \gamma,$$

$$4\pi \lim_{r \rightarrow \infty} \frac{d^{(r)}}{r} = \pi - \delta, \quad 4\pi \lim_{r \rightarrow \infty} \frac{e^{(r)}}{r} = \pi - \epsilon, \quad 4\pi \lim_{r \rightarrow \infty} \frac{f^{(r)}}{r} = \pi - \phi,$$

where r is always an odd integer. Then*

$$2\pi \lim_{r \rightarrow \infty} \frac{1}{r} \log \left\{ \begin{matrix} a^{(r)} & b^{(r)} & e^{(r)} \\ d^{(r)} & c^{(r)} & f^{(r)} \end{matrix} \right\}_{q=\exp(\frac{4\pi i}{r})}^{RW} = \text{Vol}(T). \quad (16)$$

In Fig. ?? we illustrate the values of $V(\alpha) = \text{Vol } T_\alpha$, for a regular tetrahedron with all dihedral angles equal to α . The tetrahedron T_α is spherical for $\alpha > \arccos(1/3)$, Euclidean for $\alpha = \arccos(1/3)$, and hyperbolic for $\pi/3 < \alpha < \arccos(1/3)$. It is ideal for $\alpha = \pi/3$, truncated (i.e. has ultra-ideal vertices) hyperbolic for $0 < \alpha < \pi/3$, and it deforms into a regular ideal octahedron O for $\alpha = 0$. The octahedron O has all dihedral angles equal to $\pi/2$ and its volume is $\text{Vol } O \approx 3.663\dots$

Let us notice that the tetrahedron considered in the above conjecture is supposed to have only *mild* vertex truncations, c.f. [?]. Another conjecture considers a generalised hyperbolic tetrahedron T with some vertices

*We suppose that the sequences $a^{(r)}, \dots, f^{(r)}$ are such that the corresponding $6j$ -symbol is well-defined.

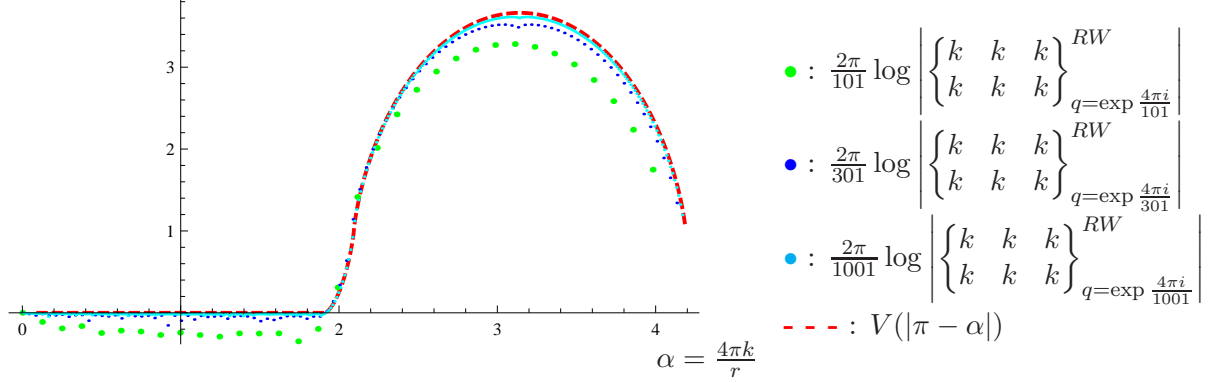

Figure 25: Values of the quantum 6j-symbol and $V(\alpha)$.

intensely truncated. We specify this conjecture for the case of a prism truncated tetrahedron, considered in [?, ?]. Although, one may state an analogous conjecture for a generalised tetrahedron of any type considered in Section ??.

Conjecture 3 *Let $\alpha, \beta, \gamma, \delta, \epsilon, \phi$ be the dihedral angles of a prism truncated hyperbolic tetrahedron T , which may have ideal or ultra-ideal vertices.[†] Let the parameter ϕ represent the dihedral angle at the edge arising from intense truncation. Let $a^{(r)}, b^{(r)}, \dots, f^{(r)}$ ($r = 3, 5, 7, \dots$) be sequences of integers satisfying*

$$4\pi \lim_{r \rightarrow \infty} \frac{a^{(r)}}{r} = \pi - \alpha, \quad 4\pi \lim_{r \rightarrow \infty} \frac{b^{(r)}}{r} = \pi - \beta, \quad 4\pi \lim_{r \rightarrow \infty} \frac{c^{(r)}}{r} = \pi - \gamma,$$

$$4\pi \lim_{r \rightarrow \infty} \frac{d^{(r)}}{r} = \pi - \delta, \quad 4\pi \lim_{r \rightarrow \infty} \frac{e^{(r)}}{r} = \pi - \epsilon, \quad 4\pi \lim_{r \rightarrow \infty} \frac{f^{(r)}}{r} = \pi - \phi,$$

where r is always an odd integer. Then[‡]

$$2\pi \lim_{r \rightarrow \infty} \sum_{j \text{ odd}} \frac{1}{r} \log \left\{ \begin{matrix} a^{(r)} & b^{(r)} & e^{(r)} \\ d^{(r)} & c^{(r)} & \frac{j-1}{2} \end{matrix} \right\}_{q=\exp(\frac{4\pi i}{r})}^{RW} \frac{\{(j+1)(2f^{(r)}+1)\}}{\{j\}} = \text{Vol}(T). \quad (17)$$

[†]However, only two truncating polar planes determined by its ultra-ideal vertices intersect.

[‡]We suppose that the sequences $a^{(r)}, \dots, f^{(r)}$ are such that the corresponding 6j-symbol is well-defined.

Let $T_{\alpha,\beta}$ be the doubly truncated tetrahedron with dihedral angle α at its usual five edges and β at the edge arising from intense truncation. Let

$$U(k, l) = \sum_j \left\{ \begin{matrix} k & k & k \\ k & k & j \end{matrix} \right\}_{q=\exp(\frac{4\pi i}{r})}^{RW} \frac{\{(2j+1)(2l+1)\}}{\{2j+1\}}.$$

In Fig. ?? the values of $U((r-3)/3, l)$ and $V(\beta) = \text{Vol } T_{\pi/3, \beta}$ are shown.

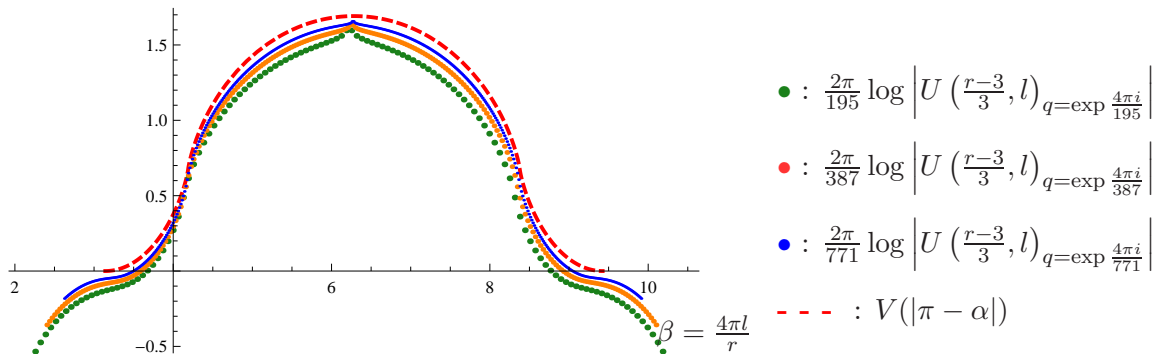

Figure 26: Values of $U(\frac{r-3}{3}, l)$ and $V(\beta)$.

Since the volume of P is a sum of volumes of the generalised tetrahedra T_i composing it, we hope that there might be a correspondence between the asymptotic behaviour of the sums (??)-(??) associated with each tetrahedron T_i , and the asymptotic behaviour of the Kirillov-Reshetikhin invariant $\langle \Gamma, c^{(r)} \rangle$ of the whole polyhedron P .

References

- [1] Q. CHEN, T. YANG “A volume conjecture for a family of Turaev-Viro type invariants of 3-manifolds with boundary”, [arXiv:1503.02547](https://arxiv.org/abs/1503.02547)
- [2] Y. CHO, H. KIM “Geometric and analytic interpretation of orthoscheme and Lambert cube in extended hyperbolic space”, *J. Korean Math. Soc.* **50** (6), 1223-1256 (2013).
- [3] F. COSTANTINO, J. MURAKAMI “On $SL(2, \mathbb{C})$ quantum $6j$ -symbol and its relation to the hyperbolic volume”, *Quantum Topology* **4** (3), 303-351 (2013).

- [4] F. COSTANTINO, F. GUÉRITAUD, R. VAN DER VEEN “On the volume conjecture for polyhedra”, *Geom. Dedicata* **179** (1), 385-409 (2015).
- [5] P. FILLIMAN “The volume of duals and sections of polytopes”, *Mathematika* **39** (1), 67-80 (1992).
- [6] D. HEARD “Orb”, An interactive software for finding hyperbolic structures on 3-dimensional orbifolds and manifolds, available from <http://www.ms.unimelb.edu.au/~snap/orb.html>
- [7] M. JACQUEMET “The inradius of a hyperbolic truncated n -simplex”, *Discrete Comput. Geom.* **51**, 997-1016 (2014).
- [8] R.M. KASHAEV “The hyperbolic volume of knots from the quantum dilogarithm”, *Lett. Math. Phys.* **39** (3), 269-275 (1997).
- [9] A.N. KIRILLOV, N. YU. RESHETIKHIN “Representations of the algebra $U_q(sl(2))$, q -orthogonal polynomials and invariants of links”, in: *Infinite-dimensional Lie algebras and groups (Luminy-Marseille, 1988)*, pp. 285–339, *Adv. Ser. Math. Phys.*, **7**, World Sci. Publ., Teaneck, NJ, 1989.
- [10] A. KOLPAKOV, J. MURAKAMI “Volume of a doubly truncated hyperbolic tetrahedron”, *Aequationes Math.*, **85** (3), 449-463 (2013).
- [11] A. KOLPAKOV, J. MURAKAMI “Erratum to: Volume of a doubly truncated hyperbolic tetrahedron”, *Aequationes Math.*, **88** (1-2), 199-200 (2014).
- [12] A. KOLPAKOV, J. MURAKAMI “The dual Jacobian of a generalised tetrahedron, and volumes of prisms”, *Tokyo J. of Math.* **39** (1), 45-67 (2016).
- [13] J. LAWRENCE “Polytope volume computation”, *Mathematics of Computation* **57** (195), 259-271 (1991).
- [14] A.D. MEDNYKH, M.G. PASHKEVICH “Elementary formulas for a hyperbolic tetrahedron”, *Sib. Math. J.* **47** (4), 687-695 (2006).
- [15] J. MURAKAMI, M. YANO “On the volume of hyperbolic and spherical tetrahedron”, *Comm. Annal. Geom.* **13** (2), 379-400 (2005).
- [16] WOLFRAM RESEARCH, “Mathematica 9”, a computational software; <http://www.wolfram.com/mathematica/>

- [17] W.P. THURSTON, “Geometry and Topology of 3-Manifolds”, mimeographed notes, Princeton University, 1979; available from www.msri.org/publications/books/gt3m/

Alexander Kolpakov
Department of Mathematics
University of Toronto
40 St. George Street
Toronto ON
M5S 2E4 Canada
kolpakov.alexander(at)gmail.com

Jun Murakami
Department of Mathematics
Faculty of Science and Engineering
Waseda University
3-4-1 Okubo Shinjuku-ku
169-8555 Tokyo, Japan
murakami(at)waseda.jp