



**HAL**  
open science

# Meta-Optimization and Scattering Parameters Analysis for Improving On Site Building Model Identification for Optimal Operation

Quang Nguyen-Hong, Audrey Le Mounier, van Binh Dinh, Benoit Delinchant, Stéphane Ploix, Wurtz Frederic

## ► To cite this version:

Quang Nguyen-Hong, Audrey Le Mounier, van Binh Dinh, Benoit Delinchant, Stéphane Ploix, et al.. Meta-Optimization and Scattering Parameters Analysis for Improving On Site Building Model Identification for Optimal Operation. Building simulation 2017, International building performance simulation association, Aug 2017, San Francisco, United States. hal-01395599

**HAL Id: hal-01395599**

**<https://hal.science/hal-01395599>**

Submitted on 21 Apr 2020

**HAL** is a multi-disciplinary open access archive for the deposit and dissemination of scientific research documents, whether they are published or not. The documents may come from teaching and research institutions in France or abroad, or from public or private research centers.

L'archive ouverte pluridisciplinaire **HAL**, est destinée au dépôt et à la diffusion de documents scientifiques de niveau recherche, publiés ou non, émanant des établissements d'enseignement et de recherche français ou étrangers, des laboratoires publics ou privés.

# Meta-Optimization and Scattering Parameters Analysis for Improving On Site Building Model Identification for Optimal Operation

Quan Nguyen-Hong<sup>1</sup>, Audrey Le Mounier<sup>1,2</sup>, Van-Binh Dinh<sup>1</sup>,  
Benoit Delinchant<sup>1</sup>, Stephane Ploix<sup>2</sup>, Frédéric Wurtz<sup>1</sup>

<sup>1</sup> G2Elab, Univ. Grenoble Alpes, CNRS, Grenoble INP, F-38000 Grenoble, France

<sup>2</sup> G-Scop, Univ. Grenoble Alpes, CNRS, Grenoble INP, F-38000 Grenoble, France

## ABSTRACT

This paper presents an approach which is called meta - optimization combining with scattering analysis used to enhance on-site real-time temperature anticipation for energy management. The aim of this approach is to analyse the sensitivity of the parameters in order to simplify, and then attain, the best reduced model able to match with measurements regularly in a robust manner. This will be done with the effort of keeping their physical properties. Indeed, parameter identification is a key challenge for modelling system that are used with many uncertainties such as construction and material quality, weather conditions, and occupant behaviour that are changing during building life. This method is applied for a nearly-zero energy building in France to validate our approach.

## INTRODUCTION

The current energy estimation methods for building are based on simulation: typical values are introduced in a model but the gap with reality is approximately between 50% and 200% (C. Turner et al., 2008). Nevertheless, calibration allows reducing this error while keeping a physical meaning to parameters and models. It is indeed very useful when purpose is to use models for energy management. Many kinds of knowledge models (sometimes called forward or physical models) are proposed in literature but models are related to a specific goal with a specific time scale. Consequently, assessing the relevance of a reduced order model for a specific goal is a key issue. Even if it may reduce model explanatory capabilities, reductions based on a simplified physics are useful to reduce the number of variables and then to improve the efficiency of the parameter estimation.

The knowledge models (sometimes called white box models) exclusively rely on general physical knowledge, which generally does not fit a specific building context. The universal models (sometimes called black box models, or data-driven model), such as polynomial models (ARX, ARMAX...) are built from measurements without using a priori physical knowledge. Even if these models may be far from relevant model structures, there are chosen so that the optimization related to parameter estimation is globally convex and easy to carry out. In addition, quality of universal models depends both on the richness of the dataset and on how much the

standardized model structure matches with the reality. Adjusted knowledge model (sometimes called “grey-box” model) offers a good alternative because model structure comes from physical knowledge and can therefore better match with observations. Nevertheless, the optimization processes implied by parameter estimation are usually much more complex for knowledge models, because universal model structures are properly chosen for optimization whereas knowledge models are generally parametrically non-linear.

In studying thermal behaviour of building, electrical network equivalence is widely used:

- with quite big structures (15R13C for G.G.J., Achterbosch et al., 1985 ; 38R35C for G. Fraisse et al., 2002, or 48R37C for Deng et al., 2010)
- with small structures (2R2C for Nielsen and Nielsen, 1984, 2R2C for Madsen and Holst, 1995, 4R4C for Bacher et Madsen, 2011, and 2R2C for Parker et al., 2013)

On the one hand, it is usual to try to reach a good accuracy by increasing the number of parameters, but it leads to identification issues and to non-robust predictions. On the other hand, using very small structure is good for robust prediction but very simple phenomenon is captured. Our purpose in this paper, is to use physical knowledge and sensitivity study for parameter estimation in order to improve robustness identification strategies. A meta-optimisation approach, with the help of scattering parameters analysis, is proposed to reach a reduced number of parameter to be identified. It has been applied to a nearly-zero energy household to confirm that our approach is better than a classical identification. It has been done more specifically for the prediction of inside air temperature for energy management systems that is our main interest as described in literature review (Li et al, 2014).

## CASE STUDY

Our case study is a modern building located in South of France. This household has one main zone which is regulated by a heating system, two basements and one garage zone. Total surface area is about 200 m<sup>2</sup>. It has been built to be a positive energy building, with high insulation materials to ensure thermal comfort without cooling system in summer.

## Building thermal model

A detailed dynamic thermal model has been built with EnergyPlus<sup>1</sup> software by our colleges in LOCIE<sup>2</sup> laboratory.

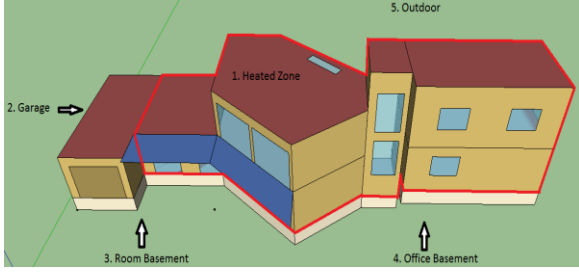

Figure 1: Overview of studied building

In our study, an electrical equivalent circuit has been done (Dinh et al., 2016), in which the thermal - electrical analogy has been used to produce a reduced order model for optimization purpose. This electrical circuit can be seen in Figure 2, with understanding that electrical components like voltage sources, current sources, resistors and capacitors are respectively corresponding to temperatures, heat gains, thermal resistances and capacitances.

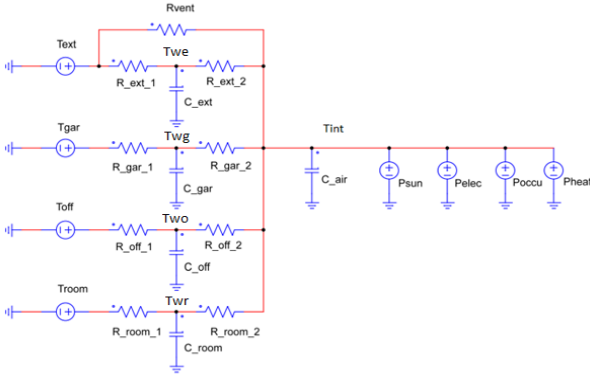

Figure 2: Thermal - electrical network of Heated Zone

Where  $T_{ext}$ ,  $T_{gar}$ ,  $T_{off}$ ,  $T_{room}$  and  $T_{int}$  are external, garage, office, and room basement zone air temperature.  $P_{sun}$ ,  $P_{elec}$ ,  $P_{occu}$  and  $P_{heat}$  are internal heat gains inside the main zone. The others components are thermal resistances and capacitances of envelope, which have physical meanings below:

- $C_{air}$ : thermal capacity of air;
- $C_{ext}$ ,  $C_{gar}$ ,  $C_{off}$ ,  $C_{room}$ : thermal capacity of wall linked to external, garage, office basement and room basement;
- $R_{ext1}$ ,  $R_{gar1}$ ,  $R_{off1}$ ,  $R_{room1}$ : external resistance of wall link to external, garage, office basement and room basement;
- $R_{ext2}$ ,  $R_{gar2}$ ,  $R_{off2}$ ,  $R_{room2}$ : internal resistance of wall link to external, garage, office basement and room basement;

Physical analytical values of these parameters are expressed in table 1

Equations from (1) to (5) are from Ohm and Kirchoff's laws and thermal - electrical equivalent transformation.

$$C_{ext} * T'_{we} = \frac{T_{ext}-T_{we}}{R_{ext_1}} + \frac{T_{int}-T_{we}}{R_{ext_2}} \quad (1)$$

$$C_{gar} * T'_{wg} = \frac{T_{ext}-T_{wg}}{R_{gar_1}} + \frac{T_{int}-T_{wg}}{R_{gar_2}} \quad (2)$$

$$C_{off} * T'_{wo} = \frac{T_{off}-T_{wo}}{R_{off_1}} + \frac{T_{int}-T_{wo}}{R_{off_2}} \quad (3)$$

$$C_{room} * T'_{wr} = \frac{T_{room}-T_{wr}}{R_{room_1}} + \frac{T_{int}-T_{wr}}{R_{room_2}} \quad (4)$$

$$C_{int} * T'_{int} = \frac{T_{ext}-T_{int}}{R_{vent}} + \frac{T_{we}-T_{int}}{R_{ext_2}} + \frac{T_{wg}-T_{int}}{R_{gar_2}} + \frac{T_{wo}-T_{int}}{R_{off_2}} + \frac{T_{wr}-T_{int}}{R_{room_2}} + P_{sun} + P_{elec} + P_{occu} + P_{heat} \quad (5)$$

Equation from (1) to (5) can be described in state system form:

$$\frac{dX}{dt} = A * X(t) + B * U(t) \quad (6)$$

Where:  $X$  is state vector of 5 temperatures.

$U$  is 4 temperatures and 4 heat gain inputs

We emphasize that matrix  $A_{5 \times 5}$  and  $B_{5 \times 8}$  are state matrices, which consist of the resistances and capacitances corresponding to physical knowledge of construction. For instances:

$$A(5,5) = -\frac{1}{C_{air}} * \left( \frac{1}{R_{vent}} + \frac{1}{R_{ext_2}} + \frac{1}{R_{gar_2}} + \frac{1}{R_{off_2}} + \frac{1}{R_{room_2}} \right);$$

$$B(5,1) = \frac{1}{C_{air}} * \frac{1}{R_{vent}}$$

State system (6) is solved using numerical integration scheme (Heun's scheme) with hourly time step.

Characteristic	Parameter	Analytic value
Resistance (9 parameters) (J°K)	$R_{vent}$	0.00700
	$R_{ext1}$	0.00350
	$R_{ext2}$	0.01020
	$R_{gar1}$	0.06830
	$R_{gar2}$	0.30950
	$R_{off1}$	0.18910
	$R_{off2}$	0.00170
	$R_{room1}$	0.08930
	$R_{room2}$	0.00078
Capacitance (5 parameters) (°K/W)	$C_{ext}$	73273763
	$C_{gar}$	1947600
	$C_{off}$	7899650
	$C_{room}$	16731307
	$C_{air}$	4400000

Table 1: Analytic value for thermal parameters

<sup>1</sup> <http://apps1.eere.energy.gov/buildings/energyplus>

<sup>2</sup> [www.polytech.univ-savoie.fr/locie](http://www.polytech.univ-savoie.fr/locie)

## CLASSICAL FORECASTING METHOD

### Classical Prediction Diagram

In forecasting, the model identification and prediction process are combined together and repeated as it can be shown in figure 3. Thermal model in this case contains 14 thermal parameters as mentioned above. 8 days for identification and 2 days for prediction have been chosen as a compromise between anticipation accuracy and calculation time.

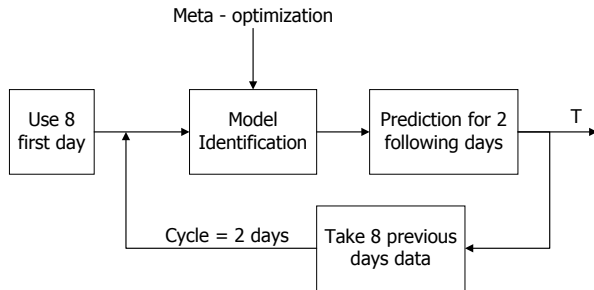

Figure 3: Classical prediction diagram

### Multi-start parameter identification

It is obvious that the identification process always plays an important role in this work, because its good or bad achievement will directly influence the results of prediction. For now, the optimization procedure is driven by Sequential Quadratic Programming (SQP, Boggs 1996) algorithm that can be introduced here:

- SQP algorithm is a classical Quasi-Newton Method, based on quadratic approximation using gradients. It is excellent for finding local optimum of many parameters and constraints, but it is especially sensitive to initial value. To overcome this issue and keep taking advantage of SQP, a multi-start strategy is applied. This type of algorithm allows driving the optimization with several initial values, to compare the results and to provide a set of local optimal solutions.

- Validity range: The bounds for optimizing parameters  $p$  are a pre-defined range  $[p_{\min}, p_{\max}]$ . It is considered as an acceptable searching range for each parameter that still maintaining its own physical properties. In fact, the nominal value of each parameter is obtained using analytical model based on physical properties of material, and geometry. Then  $p_{\min}$  and  $p_{\max}$  are obtained with an estimation of uncertainties.

- Initial guess: 10 optimizations have been done with different initial values for each R and C parameters. Excepted ones from the analytic values, all others are created randomly in the validity range.

### Results

In order to apply the identification procedure, the building measures are simulated using EnergyPlus simulation results obtained with OpenStudio modelling that is shown in Figure 1. One room is controlled based on the air temperature of the zone considered previously. Then, the identification procedure has been done according to the model predictive control horizon of 2 days. It means that the identification is done using 8 days

extracted for the one year EnergyPlus simulation, but only sequences of 2 days are remaining which corresponds to the prediction parts, while the identification parts are erased. Figure 4 shows the best result from the ones obtained for 10 sets of RC parameters initial values.

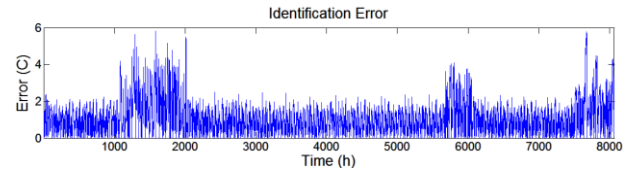

Figure 4: Identification errors

A two days prediction horizon for one year is shown in figure 5 where the mean absolute error (MAE) of room air temperature over the year is quite acceptable (1.07-degree C). But many high errors still exist (max error 5.82°C), which greatly deteriorate overall performance. Calculating time for whole process is about 8240 seconds, equivalent to 2 hours and 20 minutes.

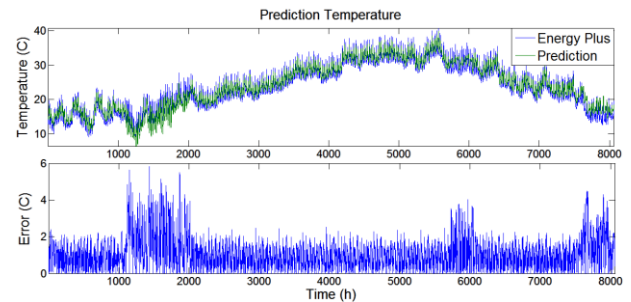

Figure 5: Prediction air temperature of controlled zone, and error through - out one year

To conclude, we can say that although multi-start algorithm can boost up the strengths of SQP optimization, the complexity of RC thermal circuit is significant regarding identification and anticipation efficiency. Hence the sensitivity of parameters should be taken under consideration as a solution for reducing model order.

## META-OPTIMIZATON AND SCATTERING PARAMETERS ANALYSIS METHOD

As it has been seen previously, the use of whole parameters of Heat Zone for prediction is not efficient. Indeed, the optimizing task with 14 parameters, with multi-start strategy, needs computing time and even could not achieve the best result. It is now necessary to introduce a new methodology that keeps the same order of model but with faster and more robust results.

The main idea of scattering parameters analysis initially introduced by (A. Le Mounier, 2014) is to find which parameters are the most scattering and hard to converge through optimization. After that, they are fixed to their physical value, hence decreasing the number of dependent parameters and hopefully, the optimization process could converge easier.

### Scattering Parameters Analysis

It is considered that the dataset is not rich enough to adjust the values of all the parameters. Because identifiability is related to parameter sensitivity, the idea is to use a sensitivity analysis to priority determine the parameters that should be considered for parameter adjustment.

First, a scattering index for each parameter is introduced. The index corresponds to the standard deviation of all the identification values in the multi-start strategy, divided by the width of validity range in order to obtain normalized results.

$$index_i = \frac{std(param_i)}{p_{min}^i - p_{max}^i} \quad (1)$$

with  $p_{min}^i$  and  $p_{max}^i$  respectively the lower and upper bounds for the parameter  $i$  acceptable range.

By observing the scattering index of parameters, one can indicate which parameters are struggling to converge and find optimal value inside their own acceptable range.

Using this scattering information not only enhances efficiency of searching and model robustness, but also reduces computing time.

### Model Pre-training

Firstly, from initial model with 14 parameters, one should define how many parameters would be fixed. To obtain that, weather data sets are used to pre-train model and analyse parameters deviation using statistics.

First of all, with a specific data set, 20 optimizations have run with the 14 parameters model, the best optimum is then recorded. After that, one may assess parameters based on their scattering indices.

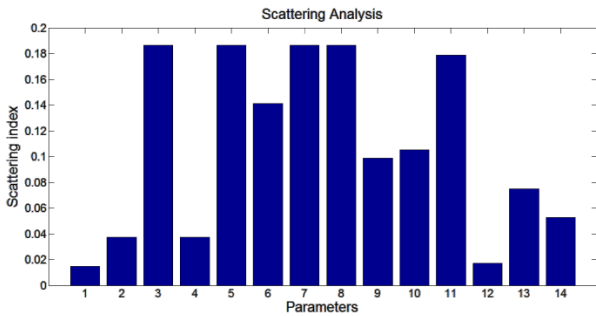

Figure 6: Scattering index for 14 parameters

As shown in figure 6, parameters 3,5,7,8 and 11 have a high scattering index, meaning that inside the searching range, they are hard to converge. Therefore, in order to enhance the optimization efficiency, the more scattered is fixed to reduce the number of parameter to be optimized (13 parameters)

This process is repeated until the reduced model contains only 5 parameters to identify. Another dataset is used as a new training data, and the process starts again from 14 parameters, then descending gradually. The final result after that model pre-training process is introduced in figure 7. The mean square error (MSE) between EnergyPlus and the reduced model is plotted regarding the number of fixed parameters (from 0 to 9).

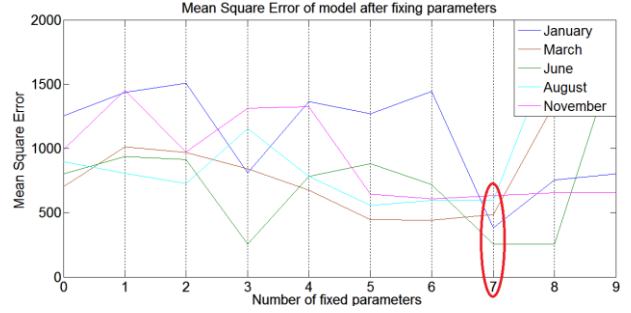

Figure 7: Mean square error observation after training with 5 month data sets

It can be noticed that with 7 fixed parameters, the best MSE is reached. So, it could be a good idea to simplify the model with 7 constants and 7 parameters to identify.

We also emphasize that for different months, parameters list to be identified is quite disparate because they might depend on data input. Consequently, we are proposing a meta-optimization combining multi-start with scattering parameters analysis, that find the best reduce model of 7 fixed parameters. It also determines the 7 other parameters which have to be fixed. It is done once per three months, as to adapt the variation of seasonal weather.

### New Model Predictive Control

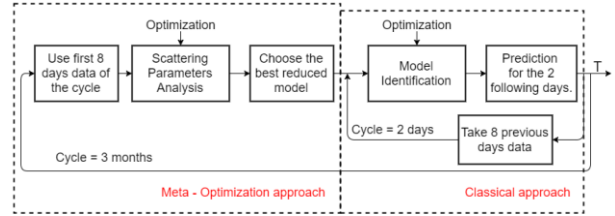

Figure 8: Prediction with meta-optimization

The synoptic of the new anticipation approach is presented in Figure 8. The meta-optimization process is operated firstly, to define the best reduced model (7 fixed and 7 dependent parameters), then use a classical approach to make re-identification based on the reduced model. This classical approach is based on a calibration using 8 previous days, for a prediction horizon of 2 days. This optimal control runs as a three-month cycle for a good trade-off between the accuracy, the robustness, and the computation time.

Figure 9 shows prediction throughout one year, constituted from all cycles of 2 days prediction.

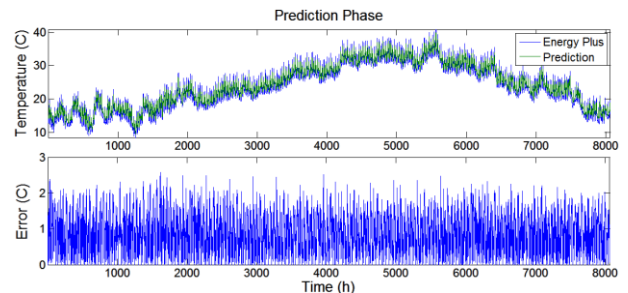

Figure 9: Prediction results throughout one year

Comparing to classical approach, this new approach enhances the absolute mean error for a year (from 1.06-degree C to 0.88-degree C) and the numbers and amplitudes of high errors have been decreased significantly (from 5.5-degree C to 2.5-degree C).

Moreover, the time consumption for whole year anticipation has been reduced from 2h20 to 1h40. It can be noticed that this time, in the case of meta-optimization approach, does not include the time for pre-training model, which could be estimated to 20 minutes, done by a regular user.

One can conclude that the identification performance is boosted up, and the robustness of identification model is better.

Main properties of both approaches are summarized in table 5:

Properties		Classical Approach	Meta-optimization Approach
Number of parameters to-be-optimized		14	7
Time consumption for whole year anticipation		8240 seconds ~ 2 hrs 20m	5883 second ~ 1 hr 40m
Identification	Mean error	1.08 °C	0.88 °C
	Max error	5.80 °C	2.57 °C
Prediction	Mean error	1.07 °C	0.88 °C
	Max error	5.82 °C	2.51 °C

Table 2: Classical and Meta-optimization approach results

## CONCLUSIONS AND PERSPECTIVES

The classical way to predict inside building temperature using all model parameters identification is not convenient with optimization process. The methodology integrating meta-optimization and scattering analysis improves the model identification process. It also decrease the calculation time by providing a logical way to simplify the model.

Some aspects could be improved, such as the numbers and procedures of meta-optimization progress per cycle, which are still the most consuming processes. Improving parameters initial values sets distribution in the searching range could also enhance optimization performances.

Furthermore, the algorithm should be tested in other contexts and be integrated into a model-based anticipative energy management system to ensure its applicable ability in real buildings.

## REFERENCES

- Turner, C., Frankel, M., Energy Performance of LEED for New Construction Buildings, Final Report, March 4, 2008.
- G.G.J. Achterbosch, P.P.G. de Jong, C.E. Krist-Spit, S.F. Van Der Meulen, J. Verberne, The development of a convenient thermal dynamic building model, Energy Build. (1985).
- G. Fraisse, C.Viardot, O. Lafabrie, G. Achard, Development of a simplified and accurate building model based on electrical analogy, Energy Build, (2002).
- K. Deng, P. Barooah, P.G. Mehta, S.P. Meyn, Building thermal model reduction via aggregation of states, Proceedings of American Control Conference (ACC), (2010).
- A.A. Nielsen, B.K. Nielsen, A dynamic test method for the thermal performance of small houses, Proceedings of ACEEE (1984).
- H. Madsen, J. Holst, Estimation of continuous-time models for the heat dynamics of a building, Energy Build, (1995).
- P. Bacher, H. Madsen, Identifying suitable models for the heat dynamics of buildings, Energy Build, (2011).
- H. Park, N. Martaj, M. Ruellan, R. Bennacer, E. Monmasson, Modeling of a Building System and its Parameter Identification, J Electr Eng Technol (2013).
- V.B. Dinh, B. Delinchant, F. Wurtz. The importance of derivatives for simultaneous optimization of sizing and operation strategies: Application to buildings and HVAC systems. Building Simulation and Optimization, Newcastle, United Kingdom, Sep 2016.
- A. Le Mounier, B. Delinchant, S. Ploix, Determination of relevant model structures for self-learning energy management system, Building Simulation and Optimization Conference, 23-24 June, London, England, 2014.
- Li, X., Wen, J., 2014. Review of building energy modeling for control and operation. Renew. Sustain. Energy Rev. 37, 517–537. 2014
- Boggs, P.T.. Sequential Quadratic, National Institute of Standards and Technology, Gaithersburg, Maryland 20899, USA. (1996)