



HAL
open science

Convex projective generalized Dehn filling

Suhyoung Choi, Gye-Seon Lee, Ludovic Marquis

► **To cite this version:**

Suhyoung Choi, Gye-Seon Lee, Ludovic Marquis. Convex projective generalized Dehn filling. *Annales Scientifiques de l'École Normale Supérieure*, 2020, 53 (1), pp.217-266. 10.24033/asens.2421. hal-01393971v2

HAL Id: hal-01393971

<https://hal.science/hal-01393971v2>

Submitted on 11 Apr 2018

HAL is a multi-disciplinary open access archive for the deposit and dissemination of scientific research documents, whether they are published or not. The documents may come from teaching and research institutions in France or abroad, or from public or private research centers.

L'archive ouverte pluridisciplinaire **HAL**, est destinée au dépôt et à la diffusion de documents scientifiques de niveau recherche, publiés ou non, émanant des établissements d'enseignement et de recherche français ou étrangers, des laboratoires publics ou privés.

CONVEX PROJECTIVE GENERALIZED DEHN FILLING

SUHYOUNG CHOI, GYE-SEON LEE, AND LUDOVIC MARQUIS

ABSTRACT. For $d = 4, 5, 6$, we exhibit the first examples of complete finite volume hyperbolic d -manifolds M with cusps such that infinitely many d -orbifolds M_m obtained from M by generalized Dehn filling admit properly convex real projective structures. The orbifold fundamental groups of M_m are Gromov-hyperbolic relative to a collection of subgroups virtually isomorphic to \mathbb{Z}^{d-2} , hence the images of the developing maps of the projective structures on M_m are new examples of divisible properly convex domains of the projective d -space which are not strictly convex, in contrast to the previous examples of Benoist.

CONTENTS

1. Introduction	1
2. Preliminary	11
3. Dehn fillings of Coxeter polytopes	19
4. Labeled polytopes \mathcal{G}_m^i	19
5. Prime examples in dimension 4	22
6. Geometric description	22
7. Deformation spaces $\mathcal{C}(\mathcal{G}_m^i)$	23
8. Limits of P_m	27
9. A necessary condition for Dehn fillings	28
10. How to make more examples	31
11. Higher dimensional examples	35
12. Proof of the main theorems	38
Appendix A. A Coxeter polytope with a non-truncatable vertex	41
Appendix B. Useful Coxeter diagrams	42
References	43

1. INTRODUCTION

1.1. Motivation. Hyperbolic Dehn filling theorem proven by Thurston [Thu02] is a fundamental theorem of hyperbolic 3-manifold theory. It states that if the interior of a compact 3-manifold M with toral boundary admits a complete hyperbolic structure of finite volume, then except for finitely many Dehn fillings on each boundary component, all other Dehn fillings of M admit hyperbolic structures.

Within the realm of hyperbolic geometry, this phenomenon happens only for *three*-manifolds even though there is a notion of topological Dehn filling for every compact d -manifold M with

2010 *Mathematics Subject Classification.* 20F55, 22E40, 51F15, 53A20, 53C15, 57M50, 57N16, 57S30.

Key words and phrases. Dehn filling, Real projective structure, Orbifold, Coxeter group, Hilbert geometry.

boundary homeomorphic to the $(d-1)$ -dimensional torus \mathbb{T}^{d-1} . Let \mathbb{D}^n be the closed n -ball. Since the compact d -manifold $\mathbb{D}^2 \times \mathbb{T}^{d-2}$ has also a torus boundary component, if we glue M and $\mathbb{D}^2 \times \mathbb{T}^{d-2}$ together along their boundaries, then we obtain closed d -manifolds, called *Dehn fillings of M* . In a similar way we can deal with compact d -manifolds with multiple torus boundary components. Now even if we assume that the interior of M admits a finite volume hyperbolic structure, no Dehn fillings of M admit a hyperbolic structure when $d \geq 4$ (see Theorem 1.7).

Although Dehn fillings in dimension bigger than 3 admit no hyperbolic structure, they can admit a geometric structure which is “larger” than a hyperbolic structure. A main aim of this article is to show that a real projective structure can be a good candidate for this purpose. In a similar spirit, Anderson [And06] and Bamler [Bam12] proved that many aspects of Dehn filling theory for hyperbolic 3-manifolds can be generalized to Einstein d -manifolds in every dimension $d \geq 3$. More precisely, if the interior of a compact d -manifold M with toral boundary admits a finite volume hyperbolic structure, then except for finitely many Dehn fillings on each boundary component, all other Dehn fillings of M admit Einstein metrics.

Let \mathbb{S}^d be the d -dimensional projective sphere¹ and note that the group $\mathrm{SL}_{d+1}^{\pm}(\mathbb{R})$ of linear automorphisms of \mathbb{R}^{d+1} with determinant ± 1 is the group of projective automorphisms of \mathbb{S}^d . We say that a d -dimensional manifold N admits a *properly convex real projective structure* if N is homeomorphic to Ω/Γ with Ω a properly convex subset of \mathbb{S}^d and Γ a discrete subgroup of $\mathrm{SL}_{d+1}^{\pm}(\mathbb{R})$ acting properly discontinuously on Ω . Now we can ask the following question:

Question 1.1. *Is there a compact manifold M of dimension $d \geq 4$ with toral boundary such that the interior of M admits a finite volume hyperbolic structure, and except for finitely many Dehn fillings on each boundary component, all other Dehn fillings of M admit properly convex real projective structures?*

Remark 1.2. We can generalize Question 1.1 only requiring the interior of M to admit a properly convex real projective structure of finite volume.

1.2. Evidence. In this paper, we give an evidence towards a positive answer to Question 1.1. It is difficult for us to find such a manifold directly, and hence we begin with Coxeter orbifold, also called reflection orbifold or reflectofold (see [Thu02, ALR07, Cho12] for the definition of orbifold). The definition of Coxeter orbifold is somewhat more complicated than the definition of manifold, however it turns out that convex projective Coxeter orbifolds are easier to build than convex projective manifolds. The first examples towards Question 1.1 are hyperbolic Coxeter d -orbifolds for $d = 4, 5, 6$.

The projective model of the hyperbolic d -space \mathbb{H}^d is a round open ball in the projective d -sphere \mathbb{S}^d . Consider a (convex) polytope P in an affine chart of \mathbb{S}^d such that every facet² of P has a non-empty intersection with \mathbb{H}^d and all dihedral angles of P are submultiples of π , i.e. each dihedral angle is $\frac{\pi}{m}$ with an integer $m \geq 2$ or $m = \infty$. We call such a polytope a *hyperbolic Coxeter polytope*. The group Γ generated by the reflections about the facets of P is a discrete subgroup of the group $\mathrm{Isom}(\mathbb{H}^d)$ of isometries of \mathbb{H}^d , which is isomorphic to $\mathrm{O}_{d,1}^+(\mathbb{R})$, and the quotient \mathbb{H}^d/Γ is a hyperbolic Coxeter d -orbifold. Hyperbolic Coxeter orbifolds are useful

¹The projective d -sphere \mathbb{S}^d is the space of half-lines of \mathbb{R}^{d+1} .

²A facet of a polytope is a face of codimension 1.

objects that we can concretely construct. For example, the first example of a closed orientable hyperbolic 3-manifold is an eight-fold cover of a right-angled hyperbolic Coxeter 3-orbifold with 14 faces, which was constructed by Löbell [Löb31] in 1931.

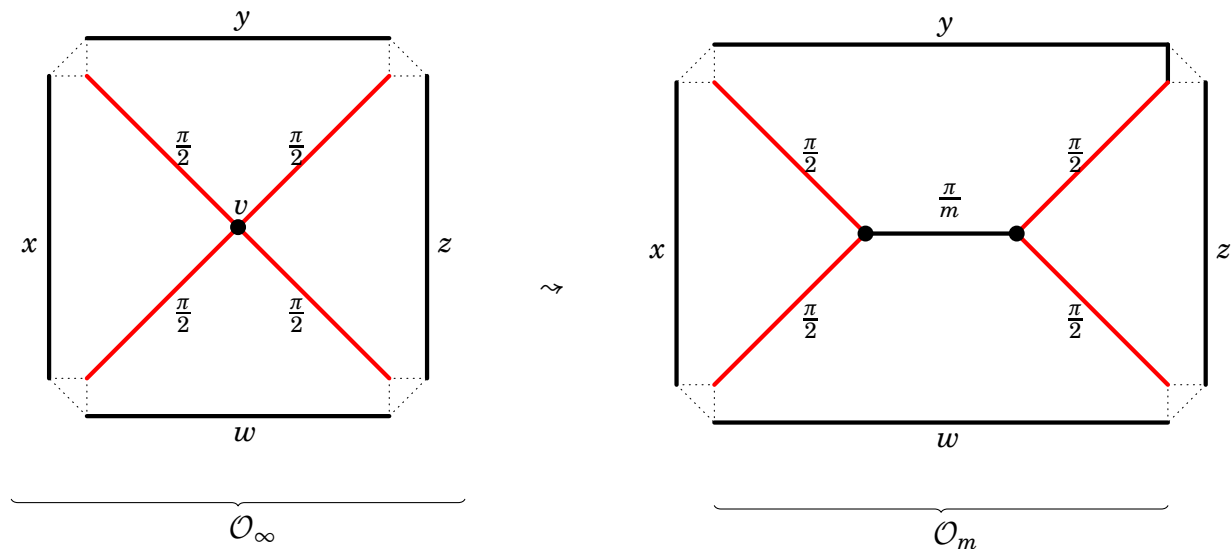

FIGURE 1. Hyperbolic Dehn fillings in dimension 3.

By Andreev's theorems [And70a, And70b], there is a version of Dehn filling theorem for hyperbolic Coxeter 3-orbifolds (see Chapter 7 of Vinberg and Shvartsman [VS93] and Proposition 2 of Kolpakov [Kol12]): Let \mathcal{O}_∞ be a compact Coxeter 3-orbifold with boundary $\partial\mathcal{O}_\infty$ that is a closed Coxeter 2-orbifold admitting a Euclidean structure. An *m-generalized Dehn filling* \mathcal{O}_m of \mathcal{O}_∞ , or simply an *m-Dehn filling*, is a closed Coxeter 3-orbifold \mathcal{O}_m such that \mathcal{O}_∞ is orbifold diffeomorphic³ to the complement of an open neighborhood of an edge r of order⁴ m of \mathcal{O}_m (see Figure 1 and Definition 3.1). A corollary of Andreev's theorems says that if the interior of \mathcal{O}_∞ admits a hyperbolic structure of finite volume, then there exists a natural number N such that for each $m > N$, the 3-orbifold \mathcal{O}_m admits a hyperbolic structure. Note that the existence of a hyperbolic *m-Dehn filling* implies that the boundary $\partial\mathcal{O}_\infty$ of \mathcal{O}_∞ must be a quadrilateral with four right angles as one can see on Figure 1 (see Proposition 9.1 for a higher dimensional and projective version of this statement).

Now we can state the main theorem of the paper: Let \mathcal{O}_∞ be a compact Coxeter d -orbifold with boundary $\partial\mathcal{O}_\infty$ that is a closed Coxeter $(d-1)$ -orbifold admitting a Euclidean structure. An *m-Dehn filling* \mathcal{O}_m of \mathcal{O}_∞ is a Coxeter d -orbifold such that \mathcal{O}_∞ is orbifold diffeomorphic to the complement of an open neighborhood of a ridge⁵ r of \mathcal{O}_m , and each interior point of r has a neighborhood modeled on $(\mathbb{R}^2/D_m) \times \mathbb{R}^{d-2}$. We abbreviate a connected open set to a *domain*.

³See Davis [Dav14] or Wiemeler [Wie13].

⁴An edge r of \mathcal{O}_m is said to be of order m if each interior point of r has a neighborhood modeled on $(\mathbb{R}^2/D_m) \times \mathbb{R}$, where D_m is the dihedral group of order $2m$ generated by reflections in two lines meeting at angle $\frac{\pi}{m}$.

⁵A ridge of a polytope is a face of codimension 2.

Theorem A. *In dimension $d = 4, 5, 6$ (resp. $d = 7$), there exists a complete finite volume hyperbolic Coxeter d -orbifold \mathcal{O}_∞ with orbifold fundamental group W_∞ and holonomy representation $\rho_\infty : W_\infty \rightarrow \mathrm{O}_{d,1}^+(\mathbb{R}) \subset \mathrm{SL}_{d+1}^\pm(\mathbb{R})$ such that there are a natural number N and a sequence of representations*

$$(\rho_m : W_\infty \rightarrow \mathrm{SL}_{d+1}^\pm(\mathbb{R}))_{m>N}$$

satisfying the following:

- *The image $\rho_m(W_\infty)$ is a discrete subgroup of $\mathrm{SL}_{d+1}^\pm(\mathbb{R})$ acting properly discontinuously and cocompactly (resp. with finite covolume) on the unique $\rho_m(W_\infty)$ -invariant properly convex domain $\Omega_m \subset \mathbb{S}^d$.*
- *The induced representation $W_\infty / \ker(\rho_m) \rightarrow \mathrm{SL}_{d+1}^\pm(\mathbb{R})$ is the holonomy representation of a properly convex real projective structure on a Dehn filling \mathcal{O}_m of \mathcal{O}_∞ .*⁶
- *The representations $(\rho_m)_{m>N}$ converge algebraically to ρ_∞ .*
- *The convex sets $(\overline{\Omega_m})_{m>N}$ converge to $\overline{\Omega_\infty} = \overline{\mathbb{H}^d} \subset \mathbb{S}^d$ in the Hausdorff topology.*

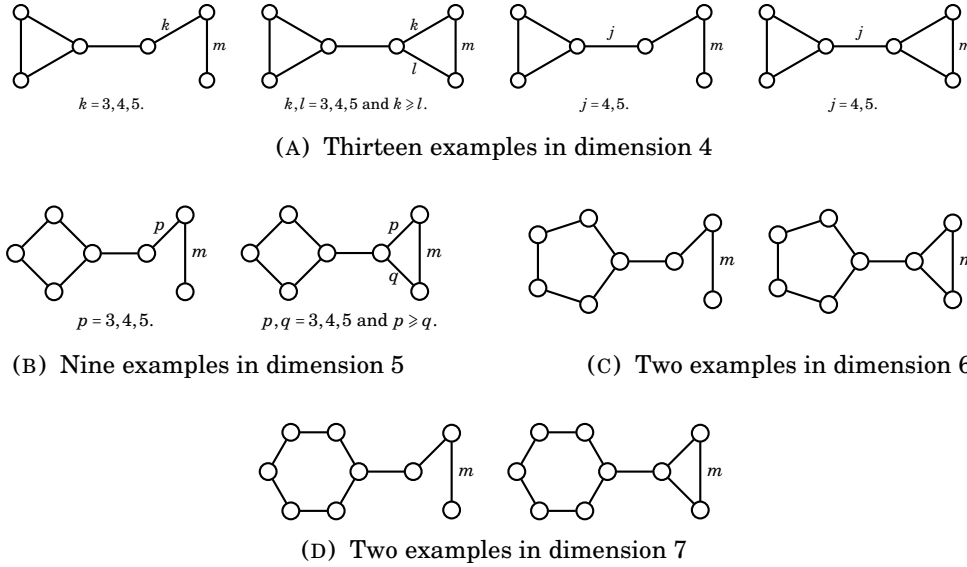

TABLE 1. Examples for Theorem A

Remark 1.3. The authors conjecture that the sequence $(\mathcal{O}_m)_m$ of convex projective orbifolds with Hilbert metric converges to the convex projective orbifold \mathcal{O}_∞ in the Gromov-Hausdorff topology.

Remark 1.4. In hyperbolic geometry, a standard assumption to study hyperbolic Coxeter polytopes (in particular, to build compact or finite volume hyperbolic Coxeter polytopes) is that all the open edges of the polytope P of \mathbb{S}^d intersect the hyperbolic space $\mathbb{H}^d \subset \mathbb{S}^d$ (see [Vin85] or [VS93]). Under this assumption, the geometry of P is governed by the position of its vertices in \mathbb{S}^d .

⁶More precisely, the Coxeter orbifold \mathcal{O}_m is an m -Dehn filling of a compact Coxeter d -orbifold $\overline{\mathcal{O}_\infty}$ with boundary such that the interior of $\overline{\mathcal{O}_\infty}$ is orbifold diffeomorphic to \mathcal{O}_∞ .

Namely, a vertex v of P is either (i) inside the hyperbolic space \mathbb{H}^d i.e. *elliptic*, (ii) on the boundary of the hyperbolic space $\partial\mathbb{H}^d$, i.e. *ideal*, or (iii) outside the compactification of the hyperbolic space $\overline{\mathbb{H}^d} := \mathbb{H}^d \cup \partial\mathbb{H}^d$, i.e. *hyperideal*. An important observation is that if v is ideal, then v is *cusped*, which means that the intersection of P with a neighborhood of v has finite volume, and that if v is hyperideal, then v is *truncatable*, which means that the dual hyperplane of v with respect to the quadratic form defining \mathbb{H}^d intersects perpendicularly all the open edges emanating from v . The main benefit of v being hyperideal is to guarantee the possibility of truncating⁷ the vertex v of P via the dual hyperplane (see Proposition 4.4 of [Vin85]). If all the hyperideal vertices of P are truncated, then the resulting polytope P^\dagger is of finite volume, and if, in addition, P contains no ideal vertices, then the truncated polytope P^\dagger is compact. Moreover, if we begin with two hyperbolic Coxeter polytopes each of which has a hyperideal vertex, then after truncating the hyperideal vertices, we may glue the pair of truncated polytopes along their new facets in place of the hyperideal vertices in order to obtain a new hyperbolic Coxeter polytope, assuming that the new facets match each other.

By the work of Vinberg [Vin71] and the third author [Mar17], one can give a sense to those definitions in the context of projective geometry. The standard assumption for (projective) Coxeter polytope P is the “2-perfectness” of P (see Section 2.9). In this new context, the notion of ideal (resp. hyperideal) vertex is replaced by the notion of parabolic (resp. loxodromic) vertex, however the terminology for an elliptic vertex is unchanged. A Coxeter polytope with only elliptic vertices is said to be *perfect*, and a Coxeter polytope with only elliptic or parabolic vertices is *quasi-perfect*.

Remark 1.5. The examples in Table 1 are not of the same nature. Namely, all of them are 2-perfect but not all are perfect or quasi-perfect.

Firstly, assuming $j \neq 5$ and $p = q = 3$ in Tables 1(A), 1(B) or 1(C), the corresponding Coxeter polytopes P_m are perfect for $N < m < \infty$ and quasi-perfect for $m = \infty$. Those are “prime” examples satisfying Theorem A.

Secondly, assuming $j = 5$, $p = 5$ and $q = 3, 5$ in Tables 1(A) or 1(B), the corresponding Coxeter polytopes P_m are 2-perfect with no parabolic vertices for $N < m < \infty$ and with one parabolic vertex for $m = \infty$, but not perfect for any m . We use those examples in Section 10 to build infinitely many Coxeter orbifolds \mathcal{O}_∞ satisfying Theorem A via a gluing procedure. Note that this gluing trick can be applied only in dimensions 4 and 5 (see Remark 11.4).

In any of the two previous cases, the Dehn filling operation happens at the unique parabolic vertex of P_∞ .

Thirdly, the assumption that $p = 4$ or $q = 4$ in Tables 1(B) or 1(D) provides examples of Coxeter polytopes P_∞ with multiple parabolic vertices. The Dehn filling operation happens at a specific parabolic vertex. See Section 11.2 for more details about those examples.

Remark 1.6. The reader might wonder what “prime” means in this paper. As an ad-hoc definition, a Coxeter d -orbifold is *prime* if it arises from a d -polytope with $d + 2$ facets, or as a bit more interesting definition, if it cannot be obtained by the gluing procedure described in Section 10.

In Theorem A, changing the target Lie group of representations from $O_{d,1}^+(\mathbb{R})$ to $SL_{d+1}^\pm(\mathbb{R})$ is essential because of the following theorem:

⁷This procedure “truncation” is called an *excision* by Vinberg [Vin85].

Theorem 1.7 (Garland and Raghunathan [GR70]). *Let d be an integer bigger than 3. Assume that Γ is a lattice in $O_{d,1}^+(\mathbb{R})$ and $\rho_\infty : \Gamma \rightarrow O_{d,1}^+(\mathbb{R})$ is the natural inclusion. Then there is a neighborhood U of ρ_∞ in $\text{Hom}(\Gamma, O_{d,1}^+(\mathbb{R}))$ such that every $\rho \in U$ is conjugate to ρ_∞ .*

In other words, every sufficiently small deformation of ρ_∞ in $\text{Hom}(\Gamma, O_{d,1}^+(\mathbb{R}))$ is trivial (see also Bergeron and Gelander [BG04] for an alternative proof).

By (a refined version of) Selberg’s lemma, Theorem A also allows us to find properly convex projective structures on Dehn fillings of a manifold:

Theorem B. *In dimension $d = 4, 5, 6$, there exists a finite volume hyperbolic d -manifold M_∞ such that infinitely many closed d -orbifolds M_m obtained by generalized Dehn fillings of M_∞ admit properly convex real projective structures. Moreover, the singular locus of M_m is a disjoint union of $(d - 2)$ -dimensional tori, and hence the orbifold fundamental group of M_m is not Gromov-hyperbolic.*

Remark 1.8. Recently, Martelli and Riolo [MR16] introduced an interesting concept of “hyperbolic Dehn filling” in dimension 4, not violating Theorem 1.7. In order to do so, they change the *domain group* of the holonomy representation instead of the *target group* $O_{4,1}^+(\mathbb{R})$. More precisely, they found a group $\tilde{\Gamma}$ and a one-parameter family of representations $(\tilde{\rho}_t : \tilde{\Gamma} \rightarrow O_{4,1}^+(\mathbb{R}))_{t \in [0,1]}$ such that for every $t \in (0, 1)$, $\tilde{\rho}_t$ is the holonomy representation of a complete finite volume hyperbolic cone-manifold, and for each $t \in \{0, 1\}$, the induced representation $\tilde{\Gamma}/\ker(\tilde{\rho}_t) \rightarrow O_{4,1}^+(\mathbb{R})$ is the holonomy of a complete finite volume hyperbolic 4-manifold. A key observation is that the group $\tilde{\Gamma}$ is the fundamental group of an *incomplete* hyperbolic manifold.

There is another difference between the Dehn fillings presented in this paper and the ones presented by Martelli and Riolo. In [MR16], the authors manage to hyperbolize some Dehn fillings obtained by closing a cusp of type $\mathbb{S}^1 \times \mathbb{S}^1 \times \mathbb{S}^1$ via collapsing a $\mathbb{S}^1 \times \mathbb{S}^1$ factor. In this paper, we geometrize only Dehn fillings obtained by collapsing a “ \mathbb{S}^1 factor” of the cusp.⁸

1.3. Another novelty of the examples in Theorem A. A properly convex domain Ω in \mathbb{S}^d is *divisible* if there exists a discrete subgroup Γ of $\text{SL}_{d+1}^\pm(\mathbb{R})$ such that Γ preserves Ω and the quotient Ω/Γ is compact. In that case, we say that Γ *divides* Ω . We call Ω *decomposable* if there exist non-empty closed convex subsets $A, B \subset \mathbb{S}^d$ such that the spans of A and B are disjoint and the convex hull of $A \cup B$ is the closure $\overline{\Omega}$ of Ω , i.e. $\overline{\Omega}$ is the join of A and B . Otherwise, Ω is called *indecomposable*. Note that a strictly convex domain must be indecomposable.

The real hyperbolic space \mathbb{H}^d thanks to the projective model is the simplest example of divisible properly convex domain. Note that the existence of a group Γ dividing \mathbb{H}^d , i.e. a uniform lattice of $O_{d,1}^+(\mathbb{R})$, is already a non-trivial problem solved by Poincaré [Poi82] in dimension 2, Löbell [Lob31] in dimension 3, Lannér [Lan50] in dimensions 4 and 5, and Borel [Bor63] in any dimension.

Second, the existence of a divisible strictly convex domain not projectively equivalent to the real hyperbolic space, i.e. not an ellipsoid, was first discovered in dimension 2 by Kac and Vinberg in [KV67] and then extended to any dimension $d \geq 2$ by the works of Koszul

⁸We work only on Coxeter orbifolds, so the precise statement is that we collapse one ridge to a vertex but do not collapse a face of codimension bigger than 2 to a vertex.

[Kos68], Johnson and Millson [JM87] and Benoist [Ben04a]. All those examples are obtained by deforming a uniform lattice of $O_{d,1}^+(\mathbb{R})$ in $SL_{d+1}^\pm(\mathbb{R})$, so in particular the divisible convex domains of dimension d obtained by those techniques are all quasi-isometric to the real hyperbolic space \mathbb{H}^d , by Švarc–Milnor lemma.

Third, the existence of a divisible strictly convex domain of dimension d not quasi-isometric to the hyperbolic space \mathbb{H}^d was first discovered in dimension 4 by Benoist [Ben06b] and then extended to any dimension $d \geq 4$ by M. Kapovich [Kap07].⁹

Now, let us turn to the problem of the existence of an indecomposable non-strictly convex divisible properly convex domain. In [Ben60], Benzécri showed that an indecomposable divisible properly convex domain of dimension 2 must be strictly convex. So, the quest starts in dimension 3.

At the time of writing this paper, the only known examples of inhomogeneous¹⁰ indecomposable divisible properly convex domains which are not strictly convex are the examples introduced by Benoist [Ben06a] in dimension $d = 3, \dots, 7$.¹¹ The construction of Benoist has been explored by the third author in [Mar10] and by the second author with Ballas and Dangiger in [BDL15], both in dimension $d = 3$. Afterwards, the authors [CLMa] study further these kinds of examples in dimension $d = 4, \dots, 7$. Moreover, the construction in this paper is inspired by the work of Benoist [Ben06b]. To find more details on the history of divisible convex domains, see [Ben08, Mar14, CLMb].

The difference between the previously known examples and the examples in Theorem A can be visually seen from the notion of properly embedded simplex of dimension e (shorten to e -simplex). An open simplex Δ is *properly embedded* in a properly convex domain Ω if $\Delta \subset \Omega$ and $\partial\Delta \subset \partial\Omega$. A properly embedded e -simplex Δ of a convex domain Ω is *tight* if Δ is not included in an e' -properly embedded simplex Δ' of Ω with $e' > e$.

All the pairs (Γ, Ω) built in [Ben06a, Mar10, BDL15, CLMa], assuming that Γ divides Ω , satisfy the three following properties (\star):

- The d -dimensional convex domain Ω contains a properly embedded $(d - 1)$ -simplex.
- The group Γ is Gromov-hyperbolic relative to a finite collection of subgroups of Γ virtually isomorphic to \mathbb{Z}^{d-1} .
- The quotient orbifold Ω/Γ *decomposes into hyperbolic pieces*, i.e. it is homeomorphic to the union along the boundaries of finitely many (but more than one) d -orbifolds each of which admits a finite volume hyperbolic structure on its interior.

Remark 1.9. If Ω is a divisible properly convex domain of dimension 3 which is not strictly convex and Γ is a group dividing Ω , then by Theorem 1.1 of Benoist [Ben06a], the pair (Γ, Ω) satisfies the three properties (\star) mentioned above. So the quest for more exotic examples starts in dimension 4.

⁹Note that a divisible strictly convex domain of dimension 2 (resp. 3) must be quasi-isometric to \mathbb{H}^2 (resp. \mathbb{H}^3), for trivial reason in dimension 2, and because any closed 3-manifold whose fundamental group is Gromov-hyperbolic must carry a hyperbolic metric by Perelman’s solution of Thurston’s geometrization conjecture.

¹⁰The classification of homogeneous divisible properly convex domains follows from work of Koecher [Koe99], Borel [Bor63] and Vinberg [Vin65].

¹¹The existence of indecomposable divisible properly convex domains of every dimension d which are not strictly convex is an open question.

Theorem C. Assume that $d = 4, 5, 6$, $\Gamma = \rho_m(W_\infty)$, $\Omega = \Omega_m$ and $N < m < \infty$ in Theorem A. Then (Γ, Ω) satisfies the following:

- The d -dimensional convex domain Ω contains a properly embedded tight $(d-2)$ -simplex.
- The group Γ is Gromov-hyperbolic relative to a finite collection of subgroups virtually isomorphic to \mathbb{Z}^{d-2} .
- The quotient orbifold Ω/Γ does not decompose into hyperbolic pieces.

The computations involved in the proof of Theorem A in fact easily extend to give two (small) new families of pairs (Γ, Ω) (see the Coxeter graphs in Table 2 for Theorem D and in Table 3 for Theorem E).

Theorem D. For each $(d, e) \in \{(5, 2), (6, 2), (7, 3), (8, 4)\}$, there exists a discrete group $\Gamma \subset \mathrm{SL}_{d+1}^\pm(\mathbb{R})$ which divides $\Omega \subset \mathbb{S}^d$ such that:

- The d -dimensional convex domain Ω contains a properly embedded tight e -simplex.
- The group Γ is Gromov-hyperbolic relative to a finite collection of subgroups virtually isomorphic to \mathbb{Z}^e .
- The quotient orbifold Ω/Γ does not decompose into hyperbolic pieces.

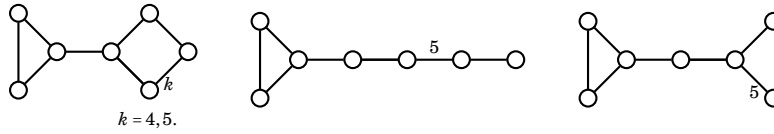

(A) Four examples in dimension 5

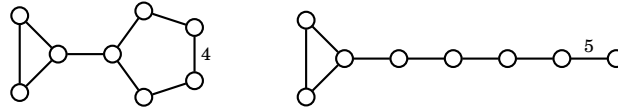

(B) Two examples in dimension 6

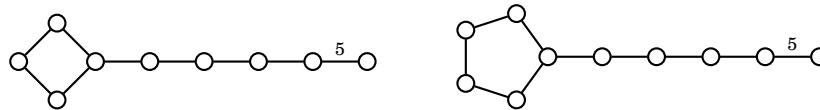

(C) One example in dimension 7 and one example in dimension 8

TABLE 2. Coxeter groups for Theorem D

Theorem E. For each $d = 5, 6$, there exists a discrete group $\Gamma \subset \mathrm{SL}_{d+1}^\pm(\mathbb{R})$ which divides $\Omega \subset \mathbb{S}^d$ such that:

- The d -dimensional convex domain Ω contains a properly embedded tight $(d-2)$ -simplex and a properly embedded tight triangle.
- The group Γ is Gromov-hyperbolic relative to a finite collection of subgroups virtually isomorphic to \mathbb{Z}^2 or \mathbb{Z}^{d-2} .
- The quotient orbifold Ω/Γ does not decompose into hyperbolic pieces.

Finally, we would like to propose the following question:

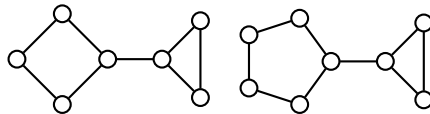

TABLE 3. Coxeter groups for Theorem E

Question 1.10. For which integers (d, m, e_1, \dots, e_m) with $m \geq 1$ and $2 \leq e_1 < e_2 < \dots < e_m \leq d-1$, is there a d -dimensional divisible convex domain $\Omega \subset \mathbb{S}^d$ which contains a properly embedded tight e_i -simplex for all $i = 1, \dots, m$?

Remark 1.11. Theorems C, D and E are reminiscent of CAT(0) spaces with isolated flats studied by Hruska and Kleiner [HK05], in which the authors proved that if X is a CAT(0) space and Γ is a group acting geometrically on X , then the following are equivalent: (i) X has isolated flats, and (ii) Γ is a relatively Gromov hyperbolic group with respect to a collection of virtually abelian subgroups of rank at least two. By Kelly and Straus [KS58], any properly convex domain Ω with the simplest distance, namely the Hilbert distance, is CAT(0) if and only if Ω is an ellipsoid. Nevertheless, Hilbert geometries and CAT(0) spaces have a similar flavor in spirit, and so one can ask whether the groups dividing inhomogeneous indecomposable properly convex domains are always relatively Gromov-hyperbolic with respect to a (possibly empty) collection of virtually abelian subgroups of rank at least two. The examples “à la Benoist” and our new examples provide an evidence towards the positive answer to the question.

Note that Corollary D of Caprace [Cap09] (or Theorem 10.5) gives a characterization of the Coxeter groups W which are relatively Gromov-hyperbolic with respect to a collection of virtually abelian subgroups of rank at least 2. As a consequence, the Davis complex (i.e. a CAT(0) space on which W acts geometrically) of such a Coxeter group W has isolated flats.

1.4. Strategy to find the examples in Theorem A. The simplest d -polytope is the d -simplex Δ_d , however we will see in Proposition 9.1 that a hyperbolic Coxeter d -polytope which allows us to get Dehn fillings must have a vertex whose link is a Coxeter $(d-1)$ -prism with Coxeter group $\tilde{A}_1 \times \tilde{A}_{d-2}$,¹² but the link of every vertex of a d -simplex is a $(d-1)$ -simplex.

The next simplest polytopes have $d+2$ facets, and Tumarkin [Tum04] classified all finite volume hyperbolic Coxeter d -polytopes with $d+2$ facets: They exist only in dimension $d \leq 17$, and among them, hyperbolic Coxeter d -polytopes P_∞ with a $\tilde{A}_1 \times \tilde{A}_{d-2}$ cusp exist only in dimension $d \leq 7$. In this paper (for prime examples), we restrict ourselves to d -polytopes with $d+2$ facets, and thus Proposition 9.1 (or the work of Tumarkin) implies that the underlying polytope of P_∞ is the pyramid over $\Delta_1 \times \Delta_{d-2}$. We will see that the underlying polytopes of the Dehn fillings P_m of P_∞ are $\Delta_2 \times \Delta_{d-2}$ (see Theorem 11.2).

In the paper [Ben06b], Benoist uses Coxeter polytopes whose underlying polytopes are $\Delta_2 \times \Delta_2$ in order to obtain closed 4-manifolds which admit strictly convex real projective structures but no hyperbolic structure. The computation in Section 7 is inspired by his paper.

1.5. Organization of the paper. In Section 2, we recall definitions and results essentially due to Tits and Vinberg around the notion of projective Coxeter groups [Bou68, Vin71]. In

¹²We refer to Appendix B for the classical names of the spherical and affine Coxeter groups.

Section 3, we give the definition of projective generalized Dehn filling. In Section 4, we explain on three examples (see Table 4) how to build the labeled polytope \mathcal{G}_m (see Section 2.10 for the definition of labeled polytope) that will support the Coxeter polytopes P_m .

In Sections 5 and 6, we give the list of all the prime examples we are able to get in dimension 4, state Theorems 5.1 and 5.2, which describe the deformation space $\mathcal{C}(\mathcal{G}_m)$ of \mathcal{G}_m and the limit of P_m , respectively, and explain the geometry of the different examples. In particular, we explain that the examples fall into three classes. One type (superscript $i = 1$ in Table 4) will give examples with deformation space of \mathcal{G}_m consisting of two points and with deformation space of \mathcal{G}_∞ consisting of one point. In that case, the interior Ω_∞ of the Γ_∞ -orbit of P_∞ is an ellipsoid, where Γ_∞ is the subgroup of $\mathrm{SL}_{d+1}^\pm(\mathbb{R})$ generated by the reflections in the facets of P_∞ , and the action of Γ_m on Ω_m is cocompact, i.e. \mathcal{G}_m is perfect (see Section 2.9). Second type (superscript $i = 2$ in Table 4) will give examples with deformation space of \mathcal{G}_m being two points and with deformation space of \mathcal{G}_∞ being one point, but this time the action of Γ_m on Ω_m is not cocompact, but we will be able to truncate some vertices of \mathcal{G}_m and to glue copies of \mathcal{G}_m in order to get infinitely many solutions to Theorems A and C. In that case, \mathcal{G}_m will be 2-perfect (see Section 2.9). Third type (superscript $i = 3$ in Table 4) will give examples with deformation space of \mathcal{G}_m being two lines and with deformation space of \mathcal{G}_∞ being one line. In that case, the action of Γ_m on Ω_m is cocompact, and Ω_∞ is an ellipsoid if and only if the specific parameter $\mu > 0$ of the deformation space is 1.

In Section 7, we do the actual computation proving the existence of non-empty deformation spaces of \mathcal{G}_m and of \mathcal{G}_∞ . In Section 8, we understand the behavior of P_m as the parameter $m \rightarrow \infty$. These sections together will show Theorems 5.1 and 5.2. Note that we have chosen to present the details of this computation only for the Coxeter groups in Table 4. The computations for the Coxeter groups in Tables 1, 2 and 3 are similar, but nevertheless we explain how to transfer the four-dimensional argument to the higher dimensional ones in the proof of Theorems 11.1 and 11.2.

In Section 9, we show that in order to find Dehn fillings of a Coxeter polytope at a vertex v , we need a condition on the link of v . This section is logically independent from the rest of the paper. Proposition 9.1 together with Tumarkin's list [Tum04] is the starting point of our inspiration to find the list of examples presented in this article.

In Section 10, we explain how from examples with $i = 2$ in Table 4, we can build infinitely many examples by a general procedure: basically cutting two examples around vertices and then gluing them together. In this part, on the way, we find an example of Coxeter polytope whose deformation space is a circle (see Theorem 10.7). First, this is surprising since the deformation space of every known example is non-compact if its dimension is bigger than 0. Second, this example will allow us to build even more "exotic" solutions to Theorem C (see Remark 1.2).

In Section 11, we study the higher dimensional cases. In Section 12, we give the proof of the main theorems.

An experienced reader can skim through the preliminary, read Sections 3, 4, 5, 6 and then jump to Section 12, to have a good overview of the paper.

Acknowledgements. We are thankful for helpful conversations with Yves Benoist, Seon-hee Lim and Anna Wienhard. We also would like to thank the referee for carefully reading this paper, suggesting several improvements and providing us an interesting point of view, which is Remark 1.11. This work benefited from the ICERM 2013 semester workshop on Exotic Geometric Structures, attended by the all three authors, from the MSRI semester on Dynamics on Moduli Spaces of Geometric Structures during Spring 2015, during which the first and second authors were in residence, and from many visits of the second author to the third author, which were supported by the Centre Henri Lebesgue ANR-11-LABX-0020-01.

S. Choi was supported by the National Research Foundation of Korea (NRF) grant funded by the Korea government (MEST) (No.2013R1A1A2056698). G.-S. Lee was supported by the European Research Council under ERC-Consolidator Grant 614733, by the DFG research grant ‘‘Higher Teichmüller Theory’’ and by the National Research Foundation of Korea (NRF) grant funded by the Korea government (MEST) (No. 2011-0027952), and he acknowledges support from U.S. National Science Foundation grants DMS 1107452, 1107263, 1107367 ‘‘RNMS: Geometric structures And Representation varieties’’ (the GEAR Network). L. Marquis was supported by the ANR Facets grant and the ANR Finsler grant during the preparation of this paper.

2. PRELIMINARY

2.1. Coxeter groups. A *Coxeter system* is a pair (S, M) of a finite set S and a symmetric matrix $M = (M_{st})_{s,t \in S}$ with diagonal entries $M_{ss} = 1$ and off-diagonal entries $M_{st} \in \{2, 3, \dots, m, \dots, \infty\}$. To a Coxeter system (S, M) we can associate a *Coxeter group*, denoted by W_S (or simply W): the group generated by S with the relations $(st)^{M_{st}} = 1$ for every $(s, t) \in S \times S$ such that $M_{st} \neq \infty$. The *rank* of W is the cardinality $|S|$ of S .

The *Coxeter diagram* (or *Coxeter graph*) of W is a labeled graph, also denoted by W , such that the set of vertices (i.e. nodes) of W is S , an edge \overline{st} connects two distinct vertices $s, t \in S$ if and only if $M_{st} \neq 2$, and the label of the edge \overline{st} is $M_{st} \in \{3, \dots, m, \dots, \infty\}$. It is customary to omit the label of the edge \overline{st} when $M_{st} = 3$. A Coxeter group W is *irreducible* if the Coxeter graph W is connected. The *Gram matrix* of W , denoted by $\text{Cos}(W)$, is an $S \times S$ symmetric matrix whose entries are given by

$$(\text{Cos}(W))_{st} = -2 \cos\left(\frac{\pi}{M_{st}}\right) \quad \text{for every } s, t \in S.$$

An irreducible Coxeter group W (or a connected Coxeter graph W) is *spherical* (resp. *affine* resp. *Lannér*) if for every $s \in S$, the submatrix of $\text{Cos}(W)$ formed by deleting the s -th row and s -th column is positive definite and the determinant of $\text{Cos}(W)$ is positive (resp. zero, resp. negative). If an irreducible Coxeter group W is not spherical nor affine, then W is *large*, i.e. there is a homomorphism of a finite index subgroup of W onto a non-abelian free group (see Margulis and Vinberg [MV00]). For example, any Lannér Coxeter group is large. Remark that an irreducible affine Coxeter group is virtually isomorphic to $\mathbb{Z}^{|S|-1}$. A Coxeter graph W (or a Coxeter group W) is called *spherical* (resp. *affine*) if each connected component of W is spherical (resp. affine). Note that a Coxeter group W is spherical if and only if W is a finite group.

We refer to Appendix B for the list of all the irreducible spherical, irreducible affine and Lannér Coxeter groups, which we will use frequently.

2.2. Coxeter polytopes. Let V be a $(d + 1)$ -dimensional vector space over \mathbb{R} , and let $\mathbb{S}(V)$ be the projective sphere, i.e. the space of half-lines in V . In order to indicate the dimension of $\mathbb{S}(V)$, we use the notation \mathbb{S}^d instead of $\mathbb{S}(V)$. Denote by $\mathrm{SL}^\pm(V)$ (resp. $\mathrm{SL}(V)$) the group of linear automorphisms of V with determinant ± 1 (resp. 1). The projective sphere $\mathbb{S}(V)$ and $\mathrm{SL}^\pm(V)$ are two-fold covers of the real projective space $\mathbb{P}(V)$ and the group $\mathrm{PGL}(V)$ of projective transformations of $\mathbb{P}(V)$, respectively.

The natural projection of $V \setminus \{0\}$ onto $\mathbb{S}(V)$ is denoted by \mathbb{S} , and for every subset W of V , $\mathbb{S}(W)$ denotes $\mathbb{S}(W \setminus \{0\})$ for the simplicity of the notation. A subset P of $\mathbb{S}(V)$ is *convex* if there exists a convex cone¹³ W of V such that $P = \mathbb{S}(W)$, and moreover a convex subset P is *properly convex* if the closure \overline{P} of P does not contain a pair of antipodal points. In other words, P is properly convex if and only if there is an affine chart \mathbb{A} of $\mathbb{S}(V)$ such that $\overline{P} \subset \mathbb{A}$ and P is convex in \mathbb{A} in the usual sense. A properly convex set P is *strictly convex* if there is no non-trivial segment in the boundary ∂P of P . We note that if Ω is a properly convex subset of $\mathbb{S}(V)$, then the subgroup $\mathrm{SL}^\pm(\Omega)$ of $\mathrm{SL}^\pm(V)$ preserving Ω is naturally isomorphic to a subgroup $\mathrm{PGL}(\Omega)$ of $\mathrm{PGL}(V)$ preserving $p(\Omega)$, where p is the natural projection of $\mathbb{S}(V)$ onto $\mathbb{P}(V)$. We may therefore regard the action of $\mathrm{SL}^\pm(\Omega)$ on Ω as the action of $\mathrm{PGL}(\Omega)$ on $p(\Omega)$ when convenient.

A *projective polytope* is a properly convex subset P of $\mathbb{S}(V)$ such that P has a non-empty interior and

$$P = \bigcap_{i=1}^r \mathbb{S}(\{v \in V \mid \alpha_i(v) \leq 0\})$$

where α_i , $i = 1, \dots, r$, are linear forms on V . We always assume that the set of linear forms is *minimal*, i.e. none of the half space $\mathbb{S}(\{v \in V \mid \alpha_i(v) \leq 0\})$ contains the intersection of all the others. A *facet* (resp. *ridge*) of a polytope is a face of codimension 1 (resp. 2). Two facets s, t of a polytope P are *adjacent* if $s \cap t$ is a ridge of P .

A *projective reflection* is an element of $\mathrm{SL}^\pm(V)$ of order 2 which is the identity on a hyperplane. Each projective reflection σ can be written as:

$$\sigma = \mathrm{Id} - \alpha \otimes b$$

where α is a linear form on V and b is a vector in V such that $\alpha(b) = 2$. The projective hyperplane $\mathbb{S}(\ker(\alpha))$ is the *support* of σ and the projective point $\mathbb{S}(b)$ the *pole* of σ . A *projective rotation* is an element of $\mathrm{SL}(V)$ which is the identity on a subspace H of codimension 2 and which is conjugate to a matrix $\begin{pmatrix} \cos \theta & -\sin \theta \\ \sin \theta & \cos \theta \end{pmatrix}$ on V/H with $0 < \theta < 2\pi$. The real number θ is called the *angle* of rotation.

A *mirror polytope* is a pair of a projective polytope P of $\mathbb{S}(V)$ and a finite number of projective reflections $(\sigma_s = \mathrm{Id} - \alpha_s \otimes b_s)_{s \in S}$ with $\alpha_s(b_s) = 2$ such that:

- The index set S consists of all the facets of P .
- For each facet $s \in S$, the support of σ_s is the supporting hyperplane of s .
- For every pair of distinct facets s, t of P , $\alpha_s(b_t)$ and $\alpha_t(b_s)$ are either both negative or both zero, and $\alpha_s(b_t)\alpha_t(b_s) \geq 4$ or equals $4 \cos^2 \theta$ with $0 < \theta \leq \frac{\pi}{2}$.

¹³By a *cone* of V , we mean a subset of V which is invariant under multiplication by positive scalars.

In fact, $\alpha_s(b_t)\alpha_t(b_s) = 4\cos^2\theta$ if and only if the product $\sigma_s\sigma_t$ is a rotation of angle 2θ . The definition of mirror polytope does not come out of the blue: It is motivated by Theorem 2.1 of Tits and Vinberg (see Proposition 6 of Vinberg [Vin71] or Lemma 1.2 of Benoist [Ben04b] for more details).

The *dihedral angle* of a ridge $s \cap t$ of a mirror polytope P is θ if $\sigma_s\sigma_t$ is a rotation of angle 2θ , and 0 otherwise. A *Coxeter polytope* is a mirror polytope whose dihedral angles are submultiples of π , i.e. each dihedral angle is $\frac{\pi}{m}$ with an integer $m \geq 2$ or $m = \infty$. If P is a Coxeter polytope, then the *Coxeter system of P* is the Coxeter system (S, M) such that S is the set of facets of P and for every pair of distinct facets s, t of S , $M_{st} = m_{st}$ if $\sigma_s\sigma_t$ is a rotation of angle $\frac{2\pi}{m_{st}}$, and $M_{st} = \infty$ otherwise. We denote by W_P (or simply W) the *Coxeter group of P* , and we call P *irreducible* if W_P is irreducible.

2.3. Tits-Vinberg's Theorem. Let (S, M) be a Coxeter system. For each subset S' of S , we consider the Coxeter group $W_{S'}$ of the Coxeter subsystem (S', M') , where M' is the restriction of M to $S' \times S'$. Theorem 2.1 shows that the natural homomorphism $W_{S'} \rightarrow W_S$ is injective, and therefore $W_{S'}$ can be identified with the subgroup of W_S generated by S' . These subgroups $W_{S'}$ are called *standard subgroups of W_S* . If P is a Coxeter polytope and f is a proper face of P (i.e. $f \neq \emptyset, P$), then we write $S_f = \{s \in S \mid f \subset s\}$ and $W_f := W_{S_f}$.

Theorem 2.1 (Tits, Chapter V of [Bou68] for Tits simplex, and Vinberg [Vin71]). *Let P be a Coxeter polytope of $\mathbb{S}(V)$ with Coxeter group W_P and let Γ_P be the subgroup of $\mathrm{SL}^\pm(V)$ generated by the projective reflections $(\sigma_s)_{s \in S}$. Then:*

- *The homomorphism $\sigma : W_P \rightarrow \Gamma_P$ defined by $\sigma(s) = \sigma_s$ is an isomorphism.*
- *The family of polytopes $(\gamma(P))_{\gamma \in \Gamma_P}$ is a tiling of a convex subset \mathcal{C}_P of $\mathbb{S}(V)$.*
- *The group Γ_P is a discrete subgroup of $\mathrm{SL}^\pm(V)$ acting properly discontinuously on the interior Ω_P of \mathcal{C}_P .*
- *An open proper face f of P lies in Ω_P if and only if the Coxeter group W_f is finite.*

We call Γ_P the *projective Coxeter group of P* . Theorem 2.1 tells us that Ω_P is a convex domain of $\mathbb{S}(V)$ and Ω_P/Γ_P is a convex real projective Coxeter orbifold.

2.4. Tits simplex. To a Coxeter group W is associated a Coxeter simplex Δ_W of $\mathbb{S}(\mathbb{R}^S)$, called the *Tits simplex of W* , as follows:

- For each $s \in S$, we set $\alpha_t = e_t^*$, where $(e_t^*)_{t \in S}$ is the canonical dual basis of \mathbb{R}^S .
- For each $t \in S$, we take the unique vector $b_t \in \mathbb{R}^S$ such that $\alpha_s(b_t) = \mathrm{Cos}(W)_{st}$ for all $s \in S$.
- The *Tits simplex Δ_W* is the pair of the projective simplex $\cap_{s \in S} \mathbb{S}(\{v \in \mathbb{R}^S \mid \alpha_s(v) \leq 0\})$ and the set of reflections $(\sigma_s = \mathrm{Id} - \alpha_s \otimes b_s)_{s \in S}$.

If Γ_W denotes the subgroup of $\mathrm{SL}^\pm(\mathbb{R}^S)$ generated by the reflections $(\sigma_s)_{s \in S}$ and $\mathrm{span}(b_S)$ the linear span of $(b_s)_{s \in S}$, then by Theorem 6 of Vinberg [Vin71], there exists a Γ_W -invariant scalar product B_W on $\mathrm{span}(b_S)$, called the *Tits bilinear form of W* , such that $B_W(b_s, b_t) = \mathrm{Cos}(W)_{st}$ for every $s, t \in S$.

2.5. The link of a Coxeter polytope at a vertex. Given a mirror polytope P of dimension d in \mathbb{S}^d , we can associate to a vertex v of P a new mirror polytope P_v of dimension $d - 1$ which is “ P seen from v ”. We call P_v the *link of P at v* . In order to build P_v , firstly, look at

the projective sphere $\mathbb{S}_v = \mathbb{S}(\mathbb{R}^{d+1}/\langle v \rangle)$, where $\langle v \rangle$ is the subspace spanned by v , and secondly, observe that the reflections $(\sigma_s)_{s \in S_v}$ induce reflections on \mathbb{S}_v . Finally, we can construct a projective polytope in \mathbb{S}_v :

$$\bigcap_{s \in S_v} \mathbb{S}(\{x \in \mathbb{R}^{d+1} \mid \alpha_s(x) \leq 0\} / \langle v \rangle).$$

This projective polytope together with the reflections induced by $(\sigma_s)_{s \in S_v}$ on \mathbb{S}_v gives us the link P_v of P at v , which is a mirror polytope of dimension $d - 1$. It is obvious that if P is a Coxeter polytope, then P_v is also a Coxeter polytope. Note that if W_v denotes W_{P_v} , then the Coxeter graph W_v is obtained from the Coxeter graph W_P by keeping only the vertices in S_v and the edges connecting two vertices of S_v .

2.6. The Cartan matrix of a Coxeter polytope. An $m \times m$ matrix $A = (a_{ij})_{i,j=1,\dots,m}$ is a *Cartan matrix* if every diagonal entry of A is 2, every off-diagonal entry is negative or zero, and for all $i, j = 1, \dots, m$, $a_{ij} = 0$ if and only if $a_{ji} = 0$.

A Cartan matrix A is *irreducible* if there are no simultaneous permutations of the rows and the columns of A such that A is a non-trivial block diagonal matrix, i.e. it is not a direct sum of two matrices. Every Cartan matrix A decomposes into a direct sum of irreducible matrices, which are called the *components* of A . By the Perron–Frobenius theorem, an irreducible Cartan matrix A has a real eigenvalue. An irreducible Cartan matrix A is of *positive type*, *zero type* or *negative type* when the smallest real eigenvalue of A is positive, zero or negative, respectively. If A^+ (resp. A^0 , resp. A^-) denotes the direct sum of the components of positive (resp. zero, resp. negative) type of a Cartan matrix A , then $A = A^+ \oplus A^0 \oplus A^-$, i.e. the direct sum of A^+ , A^0 and A^- .

For each Coxeter polytope P , we define the *Cartan matrix* A_P of P by $(A_P)_{st} = \alpha_s(b_t)$. Note that A_P is irreducible if and only if P is irreducible. The pairs $(\alpha_s, b_s)_{s \in S}$ that determine the Coxeter polytope P are unique up to the action of $|S|$ positive numbers $(\lambda_s)_{s \in S}$ given by:

$$(1) \quad (\alpha_s, b_s)_{s \in S} \mapsto (\lambda_s \alpha_s, \lambda_s^{-1} b_s)_{s \in S}$$

This leads to an equivalence relation on Cartan matrices: Two Cartan matrices A and A' are equivalent if there exists a positive diagonal matrix D such that $A' = DAD^{-1}$. We denote by $[A]$ the equivalence class of the Cartan matrix A .

For every sequence (s_1, \dots, s_k) of distinct elements of S , the number $A_{s_1 s_2} A_{s_2 s_3} \cdots A_{s_k s_1}$ is independent of the choice of a Cartan matrix in the class $[A]$. These invariants are called the *cyclic products* of A , which determine $[A]$ (see Proposition 16 of [Vin71]). The importance of Cartan matrix can be seen from:

Theorem 2.2 (Corollary 1 of Vinberg [Vin71]). *Let A be an irreducible Cartan matrix of negative type and of rank $d + 1$. Then there exists a mirror polytope P of dimension d such that $A_P = A$. Moreover, P is unique up to conjugations by $\mathrm{SL}^\pm(V)$.*

2.7. Elliptic and parabolic Coxeter polytopes. A Coxeter polytope P is *elliptic* (resp. *parabolic*) if the projective Coxeter group Γ_P of P is derived from a discrete cocompact group generated by reflections in the sphere (resp. the Euclidean space). These polytopes were classified by Coxeter:

Theorem 2.3 (Coxeter [Cox49] and Propositions 21 and 22 of Vinberg [Vin71]). *Let P be a Coxeter polytope with Coxeter group W . Then P is elliptic if and only if $A_P = A_P^+$. If this is the case, then P is isomorphic to the Tits simplex Δ_W .*

In order to describe parabolic Coxeter polytopes, we need to introduce a notation: If W is an irreducible affine Coxeter group, then Ω_{Δ_W} is an affine chart of dimension $\text{rank}(W) - 1$ on which W acts properly and cocompactly, and W preserves an Euclidean norm on Ω_{Δ_W} induced by the Tits bilinear form B_W . Now let W be an affine Coxeter group. If we decompose W into irreducible components $(W_i)_{i=1,\dots,r}$ and write $W = W_1 \times \dots \times W_r$, then the Coxeter polytope

$$\hat{\Delta}_W := \Delta_{W_1} \times \dots \times \Delta_{W_r} \subset \Omega_{\Delta_{W_1}} \times \dots \times \Omega_{\Delta_{W_r}}$$

is a Coxeter polytope in the Euclidean space \mathbb{E}^e of dimension $e = \text{rank}(W) - r$, where the symbol \times stands for the usual Cartesian product. The Euclidean norm on the affine space $\Omega_{\Delta_{W_1}} \times \dots \times \Omega_{\Delta_{W_r}}$ is the Euclidean norm induced by the Euclidean norms on the factors, and the action of W on \mathbb{E}^e is again proper and cocompact.

Theorem 2.4 (Coxeter [Cox49] and Propositions 21 and 23 of Vinberg [Vin71]). *Let P be a Coxeter polytope of dimension d with Coxeter group W . Then P is parabolic if and only if $A_P = A_P^0$ and A_P is of rank d . If this is the case, then P is isomorphic to $\hat{\Delta}_W$.*

2.8. Hilbert geometry. A Coxeter polytope P of \mathbb{S}^d is said to be *loxodromic* if $A_P = A_P^-$ and A_P is of rank $d + 1$. Before going any further, we remark that if P is an irreducible loxodromic Coxeter polytope of dimension d , then the representation $\sigma : W_P \rightarrow \text{SL}_{d+1}^{\pm}(\mathbb{R})$ in Theorem 2.1 is irreducible and the convex domain Ω_P is properly convex (see Lemma 15 of Vinberg [Vin71]). This situation leads us to study Hilbert geometry.

Given a properly convex domain Ω , we can use the cross-ratio to define a metric d_{Ω} on Ω : For any two distinct points x, y in Ω , the line l passing through x and y meets the boundary $\partial\Omega$ of Ω in two other points p and q . Assume that p and q separate x and y on the line l (see Figure 2). The *Hilbert metric* $d_{\Omega} : \Omega \times \Omega \rightarrow [0, +\infty)$ is defined by:

$$d_{\Omega}(x, y) = \frac{1}{2} \log([p : x : y : q]) \quad \text{for every } x, y \in \Omega,$$

where $[p : x : y : q]$ is the cross-ratio of the points p, x, y, q . The metric topology of Ω is the same as the one inherited from $\mathbb{S}(V)$. The metric space (Ω, d_{Ω}) is complete, the closed balls are compact, the group $\text{Aut}(\Omega)$ of projective transformations that preserve Ω acts by isometries on Ω , and therefore acts properly.

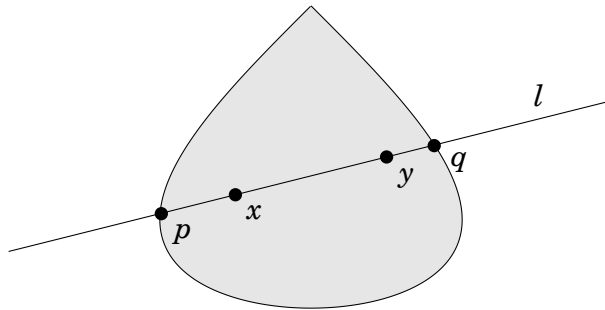

FIGURE 2. The Hilbert metric

The Hilbert metric is a Finsler metric on Ω , hence it gives rise to an absolutely continuous measure μ_Ω with respect to Lebesgue measure, called the *Busemann measure*. We refer to de la Harpe [dlH93] or Vernicos [Ver05] for more details on Hilbert geometry.

2.9. Perfect, quasi-perfect and 2-perfect Coxeter polytopes. Vinberg [Vin71] also shows that if P is a Coxeter polytope, then the following are equivalent:

- For every vertex v of P , the standard subgroup W_v of W is finite.
- The convex subset \mathcal{C}_P of $\mathbb{S}(V)$ is open, i.e. $\mathcal{C}_P = \Omega_P$.
- The action of Γ_P on Ω_P is cocompact.

Following him, we call such a Coxeter polytope P *perfect* (see Definition 8 of [Vin71]). It is known that a perfect Coxeter polytope is either elliptic, parabolic, or irreducible loxodromic (see Proposition 26 of [Vin71]).

A Coxeter polytope P is *2-perfect* if every vertex link of P is perfect, and it is *quasi-perfect* if every vertex link of P is either elliptic or parabolic. It is obvious that a quasi-perfect Coxeter polytope is 2-perfect. In order to describe the geometric property of irreducible loxodromic 2-perfect projective Coxeter groups, we introduce the following terminology: Let $C(\Lambda_P)$ be the convex hull of the limit set¹⁴ Λ_P of Γ_P . The action of Γ_P on Ω_P is *geometrically finite* if $\mu_{\Omega_P}(C(\Lambda_P) \cap P) < \infty$, *finite covolume* if $\mu_{\Omega_P}(P) < \infty$, and *convex-cocompact* if $C(\Lambda_P) \cap P \subset \Omega_P$.

Theorem 2.5 (Theorem A of Marquis [Mar17]). *Let P be an irreducible, loxodromic, 2-perfect Coxeter polytope, let Γ_P be the projective Coxeter group of P , and let Ω_P be the interior of the Γ_P -orbit of P . Then the action of Γ_P on Ω_P is*

- *geometrically finite,*
- *of finite covolume if and only if P is quasi-perfect,*
- *convex-cocompact if and only if every vertex link of P is elliptic or loxodromic.*

In Remark 1.4, we explain the version of Theorem 2.5 in hyperbolic geometry.

2.10. Deformation spaces of marked Coxeter polytopes. Two (convex) polytopes \mathcal{G} and \mathcal{G}' are *combinatorially equivalent* if there exists a bijection δ between the set \mathcal{F} of all faces of \mathcal{G} and the set \mathcal{F}' of all faces of \mathcal{G}' such that δ preserves the inclusion relation, i.e. for every $F_1, F_2 \in \mathcal{F}$, $F_1 \subset F_2$ if and only if $\delta(F_1) \subset \delta(F_2)$. We call δ a *lattice isomorphism* between \mathcal{G} and \mathcal{G}' . A *combinatorial polytope* is a combinatorial equivalence class of polytopes. A *labeled polytope* is a pair of a combinatorial polytope \mathcal{G} and a ridge labeling on \mathcal{G} , which is a function on the set of ridges of \mathcal{G} to $\{\frac{\pi}{m} \mid m = 2, 3, \dots, \infty\}$.

Let \mathcal{G} be a labeled d -polytope. A *marked Coxeter polytope realizing \mathcal{G}* is a pair of a Coxeter d -polytope P of \mathbb{S}^d and a lattice isomorphism ϕ between \mathcal{G} and P such that the label of each ridge r of \mathcal{G} is the dihedral angle of the ridge $\phi(r)$ of P . Two marked Coxeter polytopes $(P, \phi: \mathcal{G} \rightarrow P)$ and $(P', \phi': \mathcal{G} \rightarrow P')$ realizing \mathcal{G} are *isomorphic* if there is a projective automorphism ψ of \mathbb{S}^d such that $\psi(P) = P'$ and $\hat{\psi} \circ \phi = \phi'$, where $\hat{\psi}$ is the lattice isomorphism between P and P' induced by ψ .

Definition 2.6. The *deformation space* $\mathfrak{C}(\mathcal{G})$ of a labeled d -polytope \mathcal{G} is the space of isomorphism classes of marked Coxeter d -polytopes realizing \mathcal{G} .

¹⁴The limit set of Γ_P is the closure of the set of attracting fixed points of loxodromic elements of Γ_P . It is also the smallest closed Γ_P -invariant subset of the projective space. See Lemmas 2.9 and 3.3 of Benoist [Ben00].

A labeled polytope \mathcal{G} is *rigid* if the deformation space $\mathfrak{C}(\mathcal{G})$ is the singleton. Otherwise, \mathcal{G} is *flexible*.

Remark 2.7. A labeled polytope \mathcal{G} and the deformation space $\mathfrak{C}(\mathcal{G})$ can be thought of as a Coxeter orbifold \mathcal{O} and the deformation space of marked convex real projective structures on \mathcal{O} , respectively (see Thurston [Thu02]).

In a way similar to Coxeter polytopes, we can associate to a labeled polytope \mathcal{G} a Coxeter system and therefore a Coxeter group $W_{\mathcal{G}}$: the generators and the relations of $W_{\mathcal{G}}$ correspond to the facets and the ridge labeling of \mathcal{G} , respectively. We can also define the *link* \mathcal{G}_v of a labeled polytope \mathcal{G} at a vertex v using the usual notion of the link of a combinatorial polytope and labeling \mathcal{G}_v accordingly.

A labeled d -polytope \mathcal{G} is *spherical* (resp. *affine*) if it is the underlying labeled polytope of an elliptic (resp. a parabolic) Coxeter d -polytope, and it is *Lannér* if the underlying combinatorial polytope of \mathcal{G} is a d -simplex and $W_{\mathcal{G}}$ is a Lannér Coxeter group. A labeled polytope \mathcal{G} is *irreducible* (resp. *large*) if $W_{\mathcal{G}}$ is irreducible (resp. large), and it is *perfect* (resp. *2-perfect*) if every vertex link of \mathcal{G} is spherical (resp. perfect). An easy observation is:

Remark 2.8. In the case where \mathcal{G} is a labeled d -simplex, the polytope \mathcal{G} is perfect if and only if $W_{\mathcal{G}}$ is spherical, irreducible affine or Lannér. If \mathcal{G} is a labeled d -prism with Coxeter group $W_{\mathcal{G}} = \tilde{A}_1 \times \tilde{A}_{d-1}$ (see Section 2.13 for the definition of d -prism), then \mathcal{G} is perfect.

Note that we *cannot* define the notion of quasi-perfect labeled polytope because, for example, the labeled triangle $(\frac{\pi}{\infty}, \frac{\pi}{\infty}, \frac{\pi}{\infty})$ admits a realization for which the link of every vertex is parabolic (e.g. an ideal triangle of \mathbb{H}^2) or loxodromic (e.g. a hyperideal triangle of \mathbb{H}^2).

To be short, we say that a vertex v of a Coxeter (or labeled) polytope is \mathcal{A} if the corresponding link is \mathcal{A} . Here, the word \mathcal{A} can be: irreducible, spherical, affine, large, Lannér, rigid, flexible, perfect, 2-perfect, loxodromic and so on.

2.11. The space of Cartan matrices. Let (S, M) be a Coxeter system with Coxeter group W . A Cartan matrix $A = (a_{st})_{s, t \in S}$ realizes (S, M) (or simply W) if $a_{st}a_{ts} = 4 \cos^2(\frac{\pi}{M_{st}})$ when $M_{st} \neq \infty$, and $a_{st}a_{ts} \geq 4$ when $M_{st} = \infty$. The space of Cartan matrices of W of rank $d+1$, denoted by $\mathfrak{C}(W, d)$, is the space of equivalence classes of Cartan matrices of rank $d+1$ which realize W (see (1) in Section 2.6 for the equivalence relation).

If \mathcal{G} is a labeled d -polytope with Coxeter group $W_{\mathcal{G}}$, then there is a map

$$\Lambda: \mathfrak{C}(\mathcal{G}) \rightarrow \bigcup_{e \leq d} \mathfrak{C}(W_{\mathcal{G}}, e)$$

given by $\Lambda(P) = [A_P]$. We will see that in the cases we are interested in, the image of $\mathfrak{C}(\mathcal{G})$ under Λ is exactly $\mathfrak{C}(W_{\mathcal{G}}, d)$ and moreover $\mathfrak{C}(\mathcal{G})$ is homeomorphic to $\mathfrak{C}(W_{\mathcal{G}}, d)$.

2.12. Various results of Vinberg. In order to prove Proposition 7.1 and others, we need Theorem 2.9, which tells us how the combinatorial structure of a Coxeter polytope P is influenced by the Cartan matrix of P . Recall that S is the set of facets of P , $A = A_P$ the Cartan matrix of P and for every face f of P , $S_f = \{s \in S \mid f \subset s\}$. Let $\sigma(P) = \{S_f \mid f \text{ is a face of } P\} \subset 2^S$. If the dihedral angle between the facets s and t is $\frac{\pi}{2}$, then we express this fact by writing $s \perp t$. For each $T \subset S$,

$$Z(T) = \{s \in S \mid s \perp t \text{ for all } t \in T\} \quad \text{and} \quad A_T = (A_{st})_{s, t \in T}.$$

We denote by T^+ (resp. T^0 , resp. T^-) the subset of T such that $A_{T^+} = A_T^+$ (resp. $A_{T^0} = A_T^0$, resp. $A_{T^-} = A_T^-$).

Theorem 2.9 (Theorems 4 and 7 of Vinberg [Vin71]). *Let P be a Coxeter d -polytope with Coxeter group W and let T be a proper subset of S .*

- *If W_T is spherical, then $T \in \sigma(P)$ and $\bigcap_{t \in T} t$ is a face of dimension $d - |T|$.*
- *If $A_T = A_T^0$ and $A_{Z(T)}^0 = \emptyset$, then $T \in \sigma(P)$.*
- *If W_T is virtually isomorphic to \mathbb{Z}^{d-1} , $A_T = A_T^0$ and P is not parabolic, then $T \in \sigma(P)$ and $\bigcap_{t \in T} t$ is a vertex of P .*
- *If $T^0 \cup T^- \in \sigma(P)$, then $T \in \sigma(P)$.*

In order to prove Proposition 9.1, we will need the following lemma:

Lemma 2.10 (Lemma 13 and Proposition 21 of Vinberg [Vin71]). *Let W be an irreducible affine Coxeter group. If A_0 is the Gram matrix of W and A is a Cartan matrix realizing W , then the following are true:*

- $\text{rank}(A) \leq \text{rank}(A_0) + 1$.
- $\text{rank}(A) \geq \text{rank}(A_0)$, and the equality holds if and only if A and A_0 are equivalent.
- If A is not of zero type, then $W = \tilde{A}_k^{15}$ for some $k \geq 1$.

Theorem 2.11 (Theorem 6 of Vinberg [Vin71]). *Let P be a loxodromic Coxeter polytope. Then the group Γ_P preserves a bilinear form if and only if A_P is equivalent to a symmetric Cartan matrix.*

2.13. Combinatorial 4-polytopes with 6 facets. By taking a cone with basis a polytope Q of dimension $d - 1$, we obtain a polytope $\text{Pyr}(Q)$ of dimension d . Every non-trivial choice of apex of the cone gives the same combinatorial structure for $\text{Pyr}(Q)$. Such a polytope $\text{Pyr}(Q)$ is called the *pyramid over Q* . We use the notation Δ_d to denote the simplex of dimension d . A polytope P is *simple* if every vertex link of P is a simplex.

There are 4 different combinatorial polytopes of dimension 4 with 6 facets (see e.g. Paragraph 6.5 of Ziegler [Zie95]). Two of them are simple: $\Delta_1 \times \Delta_3$ and $\Delta_2 \times \Delta_2$, and two others are pyramids: $\text{Pyr}(\Delta_1 \times \Delta_2)$ and $\text{Pyr}(\text{Pyr}(\Delta_1 \times \Delta_1))$.

We emphasize the following distinction between these four polytopes.

- In $\Delta_1 \times \Delta_3$: *there are two disjoint facets.*
- In $\Delta_2 \times \Delta_2$: *any two facets are adjacent.*
- In $\text{Pyr}(\Delta_1 \times \Delta_2)$ and $\text{Pyr}(\text{Pyr}(\Delta_1 \times \Delta_1))$: *any two facets intersect.*
- In $\text{Pyr}(\Delta_1 \times \Delta_2)$: *there is exactly one pair of non-adjacent facets.*
- In $\text{Pyr}(\text{Pyr}(\Delta_1 \times \Delta_1))$: *there are exactly two pairs of non-adjacent facets.*

A *triangular prism* (or simply *prism*) is the combinatorial polytope $\Delta_1 \times \Delta_2$, and hence $\text{Pyr}(\Delta_1 \times \Delta_2)$ is the 4-pyramid over the prism. More generally, $\Delta_1 \times \Delta_{d-1}$ is a *d -prism* (or a *simplicial prism*).

¹⁵See Appendix B for the notation of the spherical and affine Coxeter groups.

3. DEHN FILLINGS OF COXETER POLYTOPES

Let P_∞ be a Coxeter d -polytope and let $\mathcal{V} = \{v_1, \dots, v_k\}$ be a non-empty subset of the set \mathcal{V}_P of all parabolic vertices of P_∞ .

Definition 3.1. A *projective generalized Dehn filling* (or simply *Dehn filling*) of P_∞ at \mathcal{V} is a Coxeter d -polytope P_{m_1, \dots, m_k} with $m_i \in \mathbb{N} \setminus \{0, 1\}$, $i = 1, \dots, k$, such that the underlying labeled polytope of P_∞ is obtained from the underlying labeled polytope of P_{m_1, \dots, m_k} by collapsing a ridge r_i of label $\frac{\pi}{m_i}$ to the vertex v_i for each $i = 1, \dots, k$ (see Figure 1 for Dehn filling in dimension 3).

Remark 3.2. Since every vertex $v \in \mathcal{V}$ is parabolic, if P_∞ is irreducible and loxodromic, then we know from Marquis [Mar17] that v is *cusped*, i.e. there exists a neighborhood \mathcal{U} of v such that

$$\mu_{\Omega_{P_\infty}}(P_\infty \cap \mathcal{U}) < \infty.$$

In Section 9, we show that the existence of Dehn fillings *implies some condition on the cusp*: Let P_∞ be an irreducible Coxeter d -polytope with Coxeter group W_∞ . If there are Dehn fillings of P_∞ at $\mathcal{V} \subset \mathcal{V}_P$, then for each $v \in \mathcal{V}$, the Coxeter group $W_{\infty, v}$ of the link of P_∞ at v is equal to $\tilde{A}_1 \times \tilde{A}_{d-2}$.

 4. LABELED POLYTOPES \mathcal{G}_m^i

In Sections 4, 6, 7 and 8, for the sake of demonstrating the construction of the examples in Theorem A without too many technical details, we concentrate our attention on three families of labeled 4-polytopes \mathcal{G}_m^i with $i = 1, 2, 3$ for $3 \leq m \leq \infty$. The arguments can easily be extended to cover the other families in Table 1.

The examples we will present fall into three kinds, indexed by superscript i in Table 4. The labeled polytope \mathcal{G}_m^1 is perfect, the deformation space $\mathcal{C}(\mathcal{G}_m^1)$ with $m > 6$ consists of two points and the deformation space $\mathcal{C}(\mathcal{G}_\infty^1)$ is a singleton. The labeled polytope \mathcal{G}_m^2 is 2-perfect but not perfect, the deformation space $\mathcal{C}(\mathcal{G}_m^2)$ with $m > 6$ consists of two points, and the deformation space $\mathcal{C}(\mathcal{G}_\infty^2)$ is a singleton. The labeled polytope \mathcal{G}_m^3 is perfect and the deformation spaces $\mathcal{C}(\mathcal{G}_m^3)$ with $m > 3$ and $\mathcal{C}(\mathcal{G}_\infty^3)$ are homeomorphic to the disjoint union of two lines and to one line, respectively.

Hence, the first case is the simplest way for us to build examples in Theorems A and C. The second case does not build directly examples in Theorems A and C: One needs to truncate some vertices first, then one can glue together (see Section 10) the truncated polytopes in order to obtain infinitely many examples in Theorems A and C. The third case builds directly examples in Theorems A and C, but this time examples with deformation, so in particular it gives examples with Ω_∞ not an ellipsoid. See Section 6 for more details on the geometric properties of all examples.

If m is finite, then the underlying polytope of \mathcal{G}_m^i is the product of two triangles, and if $m = \infty$, then the underlying polytope of \mathcal{G}_∞^i is the pyramid over the prism (see Figure 3 for the Schlegel diagrams of these polytopes, and refer to Chapter 5 of Ziegler [Zie95] for more details about Schlegel diagram). We explain below how to give labels on the ridges of \mathcal{G}_m^i using the Coxeter groups W_m^i in Table 4.

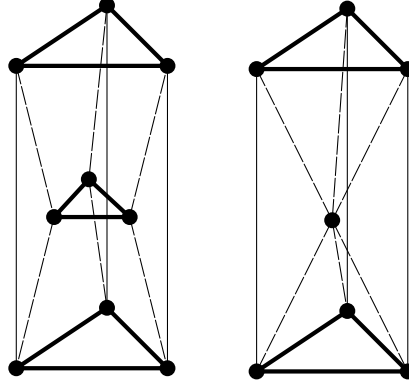

FIGURE 3. The Schlegel diagrams of the product of two triangles and of a pyramid over a prism.

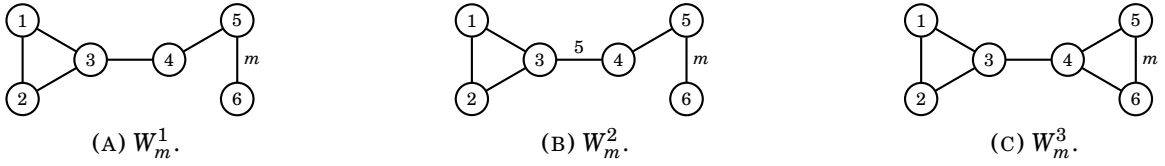

TABLE 4. The Coxeter graphs of W_m^1 , W_m^2 , W_m^3

4.1. **The labeled polytopes \mathcal{G}_m^i for m finite.** The underlying polytope of \mathcal{G}_m^i is the Cartesian product \mathcal{G} of two triangles. It is a 4-dimensional polytope with 6 facets, 15 ridges and 9 vertices.

We describe more precisely the combinatorial structure of \mathcal{G} : Let T_1, T_2 be two triangles and let $\mathcal{G} = T_1 \times T_2$. Denote the edges of T_1 by e_1, e_2, e_3 and the edges of T_2 by e_4, e_5, e_6 . The 6 facets of \mathcal{G} are $F_k = e_k \times T_2$, $k = 1, 2, 3$, and $F_l = T_1 \times e_l$, $l = 4, 5, 6$, and the 15 ridges of \mathcal{G} can be divided into 2 families:

- 9 ridges (quadrilaterals): $e_k \times e_l$ for every $k = 1, 2, 3$ and $l = 4, 5, 6$.
- 6 ridges (triangles): $T_1 \times w$ and $v \times T_2$ for every vertex w (resp. v) of T_2 (resp. T_1).

The ridge $F_k \cap F_l$ is $(e_k \cap e_l) \times T_2$ if $(k, l) \in \{(1, 2), (2, 3), (3, 1)\}$, $T_1 \times (e_k \cap e_l)$ if $(k, l) \in \{(4, 5), (5, 6), (6, 4)\}$, and $e_k \times e_l$ if $k = 1, 2, 3$ and $l = 4, 5, 6$. Finally, the 9 vertices of \mathcal{G} are $v_{klst} = F_k \cap F_l \cap F_s \cap F_t$ for $(k, l) \in \{(1, 2), (2, 3), (3, 1)\}$ and $(s, t) \in \{(4, 5), (5, 6), (6, 4)\}$.

Note that every two distinct facets of \mathcal{G} are adjacent, and hence we can label the ridges of \mathcal{G} according to the Coxeter graph W_m^i in Table 4 to obtain the labeled polytope \mathcal{G}_m^i .

Proposition 4.1. *Let \mathcal{G}_m^i be the labeled polytope with m finite. Then:*

- *The labeled polytopes \mathcal{G}_m^1 and \mathcal{G}_m^3 are perfect.*
- *The labeled polytope \mathcal{G}_m^2 is 2-perfect with exactly two Lannér vertices v_{1345} and v_{2345} .*

Proof. First, remark that \mathcal{G}_m^i is simple, and so every vertex link is a 3-simplex. Hence, by Remark 2.8, the proof immediately follows from comparing the Coxeter diagrams of the links

of \mathcal{G}_m^i and the Coxeter diagrams in Appendix B. For example, on the one hand, the Coxeter group of the link of \mathcal{G}_m^1 (or \mathcal{G}_m^3) at the vertex v_{1345} is:

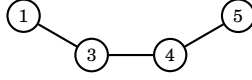

which is the spherical Coxeter diagram A_4 in Table 6, and on the other hand, the Coxeter group of the link of \mathcal{G}_m^2 at the vertex v_{1345} is:

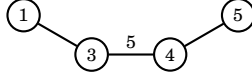

which is a Lannér Coxeter diagram in Table 9. □

4.2. The labeled polytopes \mathcal{G}_m^i for m infinite. The underlying polytope of the labeled polytope \mathcal{G}_∞^i , $i = 1, 2, 3$, is the pyramid \mathcal{G}_∞ over the prism. It is a 4-dimensional polytope with 6 facets, 14 ridges and 7 vertices.

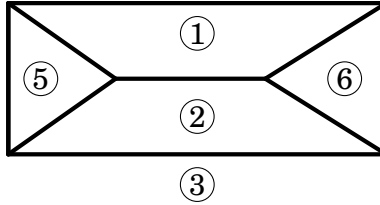

FIGURE 4. The basis of \mathcal{G}_∞

A more precise description of the combinatorial structure of \mathcal{G}_∞ is as follows: Let I be a segment with two endpoints a_5 and a_6 , and Δ be a triangle with three edges b_1 , b_2 and b_3 . The prism $I \times \Delta$ has 5 faces labeled in the obvious way (see Figure 4). Let $\mathcal{G}_\infty = \text{Pyr}(I \times \Delta)$. Among the 6 facets of \mathcal{G}_∞ , the five of them, F_i , $i = 1, 2, 3, 5, 6$, correspond to the faces of $I \times \Delta$, and F_4 denotes the remaining one. The 14 ridges of \mathcal{G}_∞ can be divided into 2 families:

- 5 ridges correspond to the faces of $I \times \Delta$ and these ridges are in the facet F_4 .
- 9 ridges correspond to the edges of $I \times \Delta$ and these ridges are $F_1 \cap F_2$, $F_2 \cap F_3$, $F_3 \cap F_1$ and $F_k \cap F_l$ with $k = 1, 2, 3$ and $l = 5, 6$.

We remark that every pair of facets F_k and F_l are adjacent except for $\{k, l\} = \{5, 6\}$ and $F_5 \cap F_6$ is the apex s of the pyramid \mathcal{G}_∞ , and therefore we can label the ridges of \mathcal{G}_∞ according to the Coxeter graph W_∞^i in Table 4 to obtain \mathcal{G}_∞^i .

Proposition 4.2. *Let \mathcal{G}_∞^i be the labeled polytope \mathcal{G}_m^i with m infinite. Then:*

- For every $i = 1, 2, 3$, the labeled polytope \mathcal{G}_∞^i is 2-perfect.
- For each $i = 1, 3$, the only non-spherical vertex of \mathcal{G}_∞^i is the apex s , which is affine of type $\tilde{A}_1 \times \tilde{A}_2$.
- The labeled polytope \mathcal{G}_∞^2 has 3 non-spherical vertices v_{1345} , v_{2345} and the apex s . Two of them, v_{1345} and v_{2345} , are Lannér, and s is affine of type $\tilde{A}_1 \times \tilde{A}_2$.

Proof. Remark that except the apex s of \mathcal{G}_∞^i , every vertex link is a 3-simplex, and the link of s is a prism. Once again, by Remark 2.8, the proof follows from comparing the Coxeter diagrams of the links of \mathcal{G}_∞^i and the Coxeter diagrams in Appendix B. For the apex s , the Coxeter group of the link of \mathcal{G}_∞^i at $s = F_1 \cap F_2 \cap F_3 \cap F_5 \cap F_6$ is:

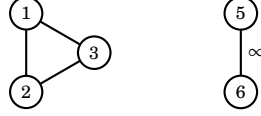

which is the affine Coxeter group $\tilde{A}_2 \times \tilde{A}_1$ (see Table 7) virtually isomorphic to $\mathbb{Z}^2 \times \mathbb{Z}^1 = \mathbb{Z}^3$, and hence s is perfect. \square

Remark 4.3. We stress that the labeled polytope \mathcal{G}_m^i is a Dehn filling of \mathcal{G}_∞^i at its apex at the level of labeled polytope. The main point to prove Theorem A is now to show that the deformation spaces of \mathcal{G}_m^i and \mathcal{G}_∞^i are not empty. This is the content of Theorems 5.1 and 5.2. See Theorems 11.1 and 11.2 for the higher dimensional cases.

5. PRIME EXAMPLES IN DIMENSION 4

In Table 1(A), we give a list of Coxeter groups W_m , which is not redundant but contains the previous three examples of Table 4. For each of them, we let m be an integer bigger than 6, and we label the product of two triangles in order to obtain a labeled polytope \mathcal{G}_m . The technique we will describe easily extends to show:

Theorem 5.1. *Choose one of the 13 families $(W_m)_{m>6}$ in Table 1(A). If the Coxeter graphs of the family have one loop, then $\mathcal{C}(\mathcal{G}_m)$ consists of two points. If the Coxeter graphs of the family have two loops, then $\mathcal{C}(\mathcal{G}_m)$ consists of two disjoint lines.*

If $m = \infty$, then we can label a pyramid over a prism in order to obtain a labeled polytope \mathcal{G}_∞ . Eventually, we can show:

Theorem 5.2. *Choose one of the 13 families $(W_m)_{m>6}$ in Table 1(A).*

- *Assume that the Coxeter graphs of the family have one loop. If P_m is one of the two points of $\mathcal{C}(\mathcal{G}_m)$, then the sequence $(P_m)_m$ converges to the unique hyperbolic polytope P_∞ whose Coxeter graph is W_∞ .*
- *Assume that the Coxeter graphs of the family have two loops. If $\mu > 0$ and P_m is one of the two points of $\mathcal{C}(\mathcal{G}_m)$ with $\mu(P_m) = \mu$, then $(P_m)_m$ converges to P_∞ which is the unique Coxeter 4-polytope such that $\mu(P_\infty) = \mu$ and $W_{P_\infty} = W_\infty$.*

Moreover, the underlying polytope of P_∞ is the pyramid over the prism.

The definition of $\mu(P_\infty)$ will be given in Section 7.1. Theorems 5.1 and 5.2 will be proved in Sections 7 and 8 in the case of the examples of Table 4. The general case is analogous.

6. GEOMETRIC DESCRIPTION

In this section, we assume Theorems 5.1 and 5.2 and we explain the geometric properties of the Coxeter polytopes P_m and of the action of the projective reflection groups Γ_{P_m} of P_m on Ω_{P_m} . To do so, we need the following theorem:

Theorem 6.1 (Theorem E of Marquis [Mar17] using Benoist [Ben04a] and Cooper, Long and Tillmann [CLT15]). *Let P be a quasi-perfect loxodromic Coxeter polytope. Then the following are equivalent:*

- *The group W_P is Gromov-hyperbolic relative to the standard subgroups of W_P corresponding to the parabolic vertices of P .*
- *The convex domain Ω_P is strictly convex.*
- *The boundary $\partial\Omega_P$ of Ω_P is of class \mathcal{C}^1 .*

6.1. Description of the geometry of the first example. Assume $i = 1$. The Coxeter polytope P_∞^1 is a quasi-perfect hyperbolic polytope of dimension 4, listed in Tumarkin [Tum04]. In particular, P_∞^1 is a hyperbolic Coxeter polytope of finite volume, i.e. the projective Coxeter group of P_∞^1 is a non-uniform lattice of $O_{d,1}^+(\mathbb{R})$.

The Coxeter 4-polytope P_m^1 is perfect. The group $\Gamma_m^1 := \Gamma_{P_m^1}$ is not Gromov-hyperbolic since the group generated by the reflections corresponding to $\{1, 2, 3\}$ is an affine Coxeter group virtually isomorphic to \mathbb{Z}^2 , and so by Theorem 6.1, the convex domain Ω_m^1 is not strictly convex nor with \mathcal{C}^1 boundary.

6.2. Description of the geometry of the second example. Assume $i = 2$. The Coxeter polytope P_∞^2 is a 2-perfect hyperbolic polytope of dimension 4 with four spherical vertices, one parabolic vertex and two loxodromic vertices, and the Coxeter polytope P_m^2 is a 2-perfect Coxeter polytope of dimension 4 with seven spherical vertices and two loxodromic vertices (see Figure 5(B)). We will come back on these examples in Section 10.

6.3. Description of the geometry of the third example. Assume $i = 3$. The Coxeter polytope P_∞^3 is a quasi-perfect polytope of dimension 4 with six spherical vertices and one parabolic vertex (see Figure 5(A)). Moreover, Γ_∞^3 is a non-uniform lattice of $O_{d,1}^+(\mathbb{R})$ if and only if $\mu(P_\infty^3) = 1$, by Theorem 2.11 and Corollary 8.2. In other words, if $\mu(P_\infty^3) \neq 1$, then P_∞^3 is not a hyperbolic Coxeter polytope and the convex domain $\Omega_\infty^3 := \Omega_{P_\infty^3}$ is not an ellipsoid, however by Theorem 6.1, it is strictly convex with \mathcal{C}^1 boundary.

The Coxeter polytope P_m^3 is a perfect Coxeter polytope of dimension 4. Once again, by Theorem 6.1, the convex domain Ω_m^3 is not strictly convex nor with \mathcal{C}^1 boundary. Note that in contrast to Section 6.1, in the case when $i = 3$, there is a one-parameter family of deformations of the convex domains.

7. DEFORMATION SPACES $\mathcal{C}(\mathcal{G}_m^i)$

This section is devoted to the proof of the following proposition:

Proposition 7.1. *Let $\mathcal{C}(\mathcal{G}_m^i)$ be the deformation space of the labeled polytope \mathcal{G}_m^i for m finite. Then:*

- *The deformation space $\mathcal{C}(\mathcal{G}_m^i)$, $i = 1, 2$, consists of two points for every $6 < m < \infty$.*
- *The deformation space $\mathcal{C}(\mathcal{G}_m^3)$ consists of two disjoint lines for every $3 < m < \infty$.*

7.1. Preparation of the computation. If ι is a pair of integers (resp. an integer), then let $c_\iota := \cos(\frac{\pi}{m_\iota})$ (resp. $:= \cos(\frac{\pi}{\iota})$) and $s_\iota := \sin(\frac{\pi}{m_\iota})$ (resp. $:= \sin(\frac{\pi}{\iota})$). We introduce the following matrix:

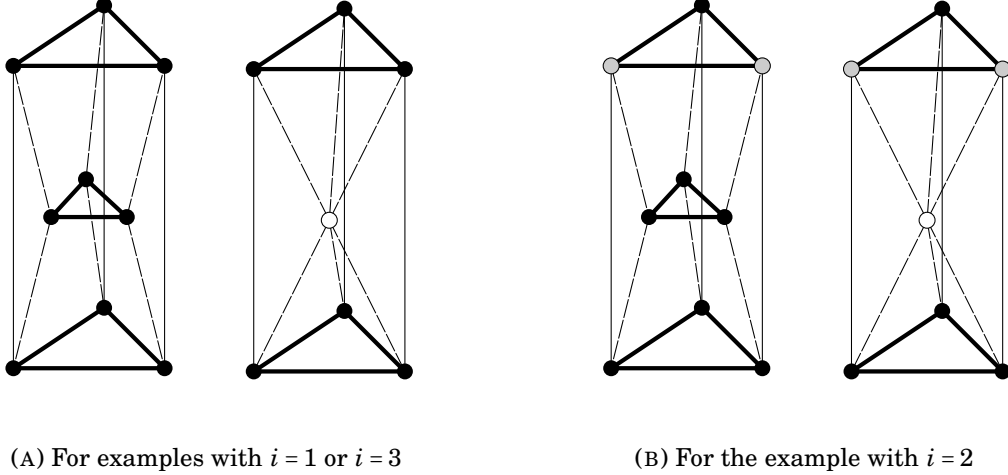

FIGURE 5. The spherical vertices are in black, the parabolic vertices are in white, and the loxodromic vertices are in gray.

$$A_{\lambda,\mu} = \begin{pmatrix} 2 & -1 & -\lambda^{-1} & & & & \\ -1 & 2 & -1 & & & & \\ -\lambda & -1 & 2 & -2c_{34} & & & \\ & & -2c_{34} & 2 & -2c_{45} & -2\mu^{-1}c_{64} & \\ & & & -2c_{45} & 2 & -2c_{56} & \\ & & & -2\mu c_{64} & -2c_{56} & 2 & \end{pmatrix}$$

with $\lambda, \mu > 0$. If $(S = \{1, 2, 3, 4, 5, 6\}, M_m^i = (m_{st})_{s,t \in S})$ is the Coxeter system associated to W_m^i , then the following hold:

- If $(m_{34}, m_{45}, m_{56}, m_{64}) = (3, 3, m, 2)$, then $A_\lambda := A_{\lambda,1}$ realizes W_m^1 .
- If $(m_{34}, m_{45}, m_{56}, m_{64}) = (5, 3, m, 2)$, then A_λ realizes W_m^2 .
- If $(m_{34}, m_{45}, m_{56}, m_{64}) = (3, 3, m, 3)$, then $A_{\lambda,\mu}$ realizes W_m^3 .

If $i = 1, 2$ (resp. 3), then the equivalence class of Cartan matrices realizing W_m^i is determined by exactly one (resp. two) cyclic product(s): (123) (resp. (123) and (456)). In other words, every Cartan matrix A realizing W_m^i is equivalent to a unique $A_{\lambda,\mu}$, and so we call $A_{\lambda,\mu}$ the *special form* of A .¹⁶

Proposition 7.2. *Suppose $3 \leq m < \infty$. Then $\mathcal{C}(\mathcal{G}_m^i)$ is homeomorphic to:*

- $\{\lambda \in \mathbb{R} \mid \lambda > 0 \text{ and } \det(A_\lambda) = 0\}$ for $i = 1, 2$.
- $\{(\lambda, \mu) \in \mathbb{R}^2 \mid \lambda, \mu > 0 \text{ and } \det(A_{\lambda,\mu}) = 0\}$ for $i = 3$.

Proof. We begin with the fact that the rank of $A_{\lambda,\mu}$ is always greater than or equal to 5 by computing the (6, 6)-minor¹⁷ of $A_{\lambda,\mu}$:

$$-24c_{34}^2 - 4s_{45}^2 \left(\sqrt{\lambda} - \frac{1}{\sqrt{\lambda}} \right)^2 < 0$$

¹⁶More precisely, let $Q = \{(1, 2), (2, 3), (3, 4), (4, 5), (5, 6)\}$. If a Cartan matrix A realize W_m^i , then there exists a unique positive diagonal matrix D (up to scaling) so that $(DAD^{-1})_{st} = (DAD^{-1})_{ts}$ for every $(s, t) \in Q$ and so A is equivalent to a special form $A_{\lambda,\mu}$. Of course, there are several choices for Q and we make one *special* choice.

¹⁷In fact, except the case $i = m = 3$, the (3, 3)-minor of $A_{\lambda,\mu}$ is always non-zero.

and therefore the image of the map

$$\Lambda : \mathcal{C}(\mathcal{G}_m^i) \rightarrow \bigcup_{e \leq 4} \mathcal{C}(W_m^i, e)$$

given by $P \mapsto [A_P]$ lies in $\mathcal{C}(W_m^i, 4)$. Moreover, we know from Theorem 2.2 that Λ is injective. Now let us prove that the image of $\mathcal{C}(\mathcal{G}_m^i)$ under Λ is exactly $\mathcal{C}(W_m^i, 4)$: Once again, by Theorem 2.2, every Cartan matrix A in $\mathcal{C}(W_m^i, 4)$ is realized by a Coxeter 4-polytope P . We need to check that the underlying combinatorial polytope of P is the product of two triangles.

For every two distinct facets s, t of P , the standard subgroup generated by s, t is a finite dihedral group, which is a spherical Coxeter group, and hence by the first item of Theorem 2.9, the facets s, t are adjacent. Finally, we know from Section 2.13 that the product of two triangles is the only 4-polytope with 6 facets such that every two distinct facets are adjacent, which completes the proof. \square

7.2. The computation. For $\alpha, \beta, \gamma \in \mathbb{R}$, let:

$$\Psi_{\alpha, \beta, \gamma} = 1 - \cos(\alpha)^2 - \cos(\beta)^2 - \cos(\gamma)^2 - 2 \cos(\alpha) \cos(\beta) \cos(\gamma)$$

The following equality is remarkable (see e.g. (3.1) of Roeder, Hubbard and Dunbar [RHD07] or (1) of Section I.2 of Fenchel [Fen89]):

$$\Psi_{\alpha, \beta, \gamma} = -4 \cos\left(\frac{\alpha + \beta + \gamma}{2}\right) \cos\left(\frac{-\alpha + \beta + \gamma}{2}\right) \cos\left(\frac{\alpha - \beta + \gamma}{2}\right) \cos\left(\frac{\alpha + \beta - \gamma}{2}\right)$$

If $\alpha, \beta, \gamma \in (0, \frac{\pi}{2}]$, then $\Psi_{\alpha, \beta, \gamma} < 0$ (resp. $= 0$, resp. > 0) if and only if $\alpha + \beta + \gamma < \pi$ (resp. $= \pi$, resp. $> \pi$). We introduce the following two matrices:

$$A_\lambda^1 = \begin{pmatrix} 1 & -c_{12} & -\lambda^{-1}c_{31} \\ -c_{12} & 1 & -c_{23} \\ -\lambda c_{31} & -c_{23} & 1 \end{pmatrix} \quad \text{and} \quad A_\mu^2 = \begin{pmatrix} 1 & -c_{45} & -\mu^{-1}c_{64} \\ -c_{45} & 1 & -c_{56} \\ -\mu c_{64} & -c_{56} & 1 \end{pmatrix}$$

Implicitly, we assume that $m_{12} = m_{23} = m_{13} = m_{45} = 3$, but we keep the notation of double indices in order to use the remarkable equality. By a direct computation, we have:

$$\frac{1}{64} \det(A_{\lambda, \mu}) = \det(A_\lambda^1) \det(A_\mu^2) - s_{12}^2 c_{34}^2 s_{56}^2$$

Another direct computation gives us:

$$\det(A_\lambda^1) = 1 - (c_{12}^2 + c_{23}^2 + c_{31}^2) - c_{12}c_{23}c_{31}(\lambda + \lambda^{-1}) = \Psi_{123} - c_{12}c_{23}c_{31}(\lambda + \lambda^{-1} - 2)$$

$$\det(A_\mu^2) = 1 - (c_{45}^2 + c_{56}^2 + c_{64}^2) - c_{45}c_{56}c_{64}(\mu + \mu^{-1}) = \Psi_{456} - c_{45}c_{56}c_{64}(\mu + \mu^{-1} - 2)$$

where Ψ_{123} (resp. Ψ_{456}) is $\Psi_{\alpha, \beta, \gamma}$ with $(\alpha, \beta, \gamma) = (\frac{\pi}{m_{12}}, \frac{\pi}{m_{23}}, \frac{\pi}{m_{31}})$ (resp. $(\frac{\pi}{m_{45}}, \frac{\pi}{m_{56}}, \frac{\pi}{m_{64}})$).

Remark 7.3. The quantity Ψ_{123} is negative (resp. zero, resp. positive) if and only if the triangle $(\frac{\pi}{m_{12}}, \frac{\pi}{m_{23}}, \frac{\pi}{m_{31}})$ is hyperbolic (resp. affine, resp. spherical). Of course, the analogous statement is true for the quantity Ψ_{456} and the triangle $(\frac{\pi}{m_{45}}, \frac{\pi}{m_{56}}, \frac{\pi}{m_{64}})$.

7.3. Proof of Proposition 7.1.

Proof of Proposition 7.1. Assume that $i = 1, 2$. By Proposition 7.2, we know that $\mathcal{C}(\mathcal{G}_m^i)$ is homeomorphic to:

$$\{\lambda \in \mathbb{R} \mid \lambda > 0 \text{ and } \det(A_\lambda) = 0\}$$

Moreover, since $c_{64} = 0$ and the triangle $(\frac{\pi}{3}, \frac{\pi}{3}, \frac{\pi}{3})$ is affine, i.e. $\Psi_{123} = 0$, we have:

$$(2) \quad \frac{1}{64} \det(A_\lambda) = \frac{1}{8} \left(2 - (\lambda + \lambda^{-1}) \right) \Psi_{456} - s_{12}^2 c_{34}^2 s_{56}^2$$

Observe that $m > 6$ if and only if the triangle $(\frac{\pi}{3}, \frac{\pi}{m}, \frac{\pi}{2})$ is hyperbolic, i.e. $\Psi_{456} < 0$. Let $x = \lambda + \lambda^{-1}$. The function $[2, +\infty) \ni x \mapsto \det(A_\lambda) \in \mathbb{R}$ is an unbounded strictly increasing function. If $x = 2$, i.e. $\lambda = 1$, then $\det(A_\lambda) = -64s_{12}^2 c_{34}^2 s_{56}^2 < 0$. Hence, there is a unique $x > 2$ and exactly two $\lambda \in \mathbb{R}_+^* \setminus \{1\}$ such that $\det(A_\lambda) = 0$.

Now assume that $i = 3$. Once again, by Proposition 7.2, we need to solve the equation:

$$(3) \quad \frac{1}{64} \det(A_{\lambda, \mu}) = \frac{1}{8} (\lambda + \lambda^{-1} - 2) (c_{45} c_{56} c_{64} (\mu + \mu^{-1} - 2) - \Psi_{456}) - s_{12}^2 c_{34}^2 s_{56}^2 = 0$$

on the set $\{(\lambda, \mu) \in \mathbb{R}^2 \mid \lambda, \mu > 0\}$. Let $x = \lambda + \lambda^{-1}$ and $y = \mu + \mu^{-1}$. The equation is of the form:

$$(x - 2)(y - A) = B$$

with $B > 0$ and $A < 2$, since $m > 3$ and so $\Psi_{456} < 0$. Thus, the solution space of the equation on $\{(x, y) \in \mathbb{R}^2 \mid x, y \geq 2\}$ is homeomorphic to a closed half-line whose extremity E is a point $(x_0, 2)$ with $x_0 > 2$ (see the blue curve in Figure 6(A)). It follows that the set of solutions in (λ, μ) is homeomorphic to two disjoint lines (see the two blue curves in Figure 6(B)), which completes the proof. \square

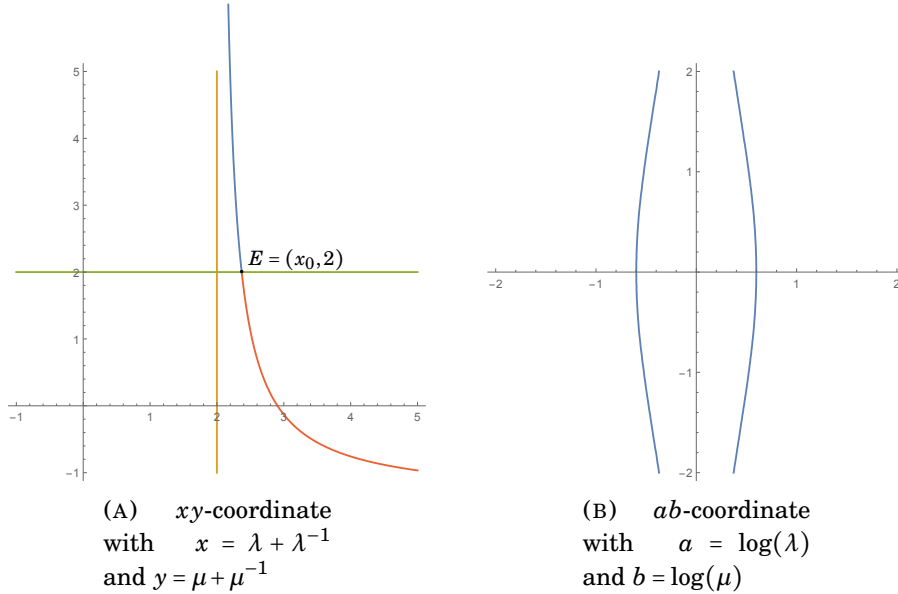

FIGURE 6. The deformation space $\mathcal{C}(\mathcal{G}_m^3)$ with $m = 7$

Remark 7.4. If $i \in \{1, 2\}$ and $3 \leq m \leq 6$, then $\mathcal{C}(\mathcal{G}_m^i) = \emptyset$.

Remark 7.5. If $i = 3$ and $m = 3$, then the equation to solve is of the form:

$$(x - 2)(y - 2) = B$$

with $B > 0$, and thus the set of solutions in (λ, μ) is homeomorphic to four disjoint lines.

Definition 7.6. For each Coxeter polytope $P \in \mathcal{C}(\mathcal{G}_m^3)$, the Cartan matrix A_P is equivalent to the unique special form $A_{\lambda,\mu}$, and thus the real number μ is an invariant of P . It is called *the μ -invariant of P* and denoted by $\mu(P)$.

By the parametrization of $\mathcal{C}(\mathcal{G}_m^3)$, the map $\mathcal{C}(\mathcal{G}_m^3) \rightarrow \mathbb{R}_+^*$ given by $P \mapsto \mu(P)$ is a two-to-one covering map. More precisely, for any $\mu > 0$, there exist exactly two Coxeter polytopes P_m and P'_m in $\mathcal{C}(\mathcal{G}_m^3)$ such that $A_{P_m} = A_{\lambda,\mu}$ and $A_{P'_m} = A_{\lambda^{-1},\mu}$ with some $\lambda > 0$.

Remark 7.7 (Duality). If $i = 1, 2$, then $\mathcal{C}(\mathcal{G}_m^i) = \{P, P^\sharp\}$ and A_{P^\sharp} is the transpose of A_P , and so P and P^\sharp are *dual* in a sense that there is an outer automorphism of $\mathrm{SL}_5^\pm(\mathbb{R})$ which exchanges Γ_P and Γ_{P^\sharp} . If $i = 3$, then the analogous statement is true for each pair $\{P, P^\sharp\}$ of Coxeter polytopes in $\mathcal{C}(\mathcal{G}_m^i)$ such that $A_P = A_{\lambda,\mu}$ and $A_{P^\sharp} = A_{\lambda^{-1},\mu^{-1}}$ (up to equivalence).

8. LIMITS OF P_m

In this section, we study the limit of the sequence $(P_m)_m$.

Proposition 8.1.

- Let $i = 1, 2$. Assume P_m^i is one of the two points of $\mathcal{C}(\mathcal{G}_m^i)$. If $A_{P_m^i}$ has the special form, then as m goes to infinity, $A_{P_m^i}$ converges to the symmetric matrix:

$$A_\infty^i = \begin{pmatrix} 2 & -1 & -1 & & & \\ -1 & 2 & -1 & & & \\ -1 & -1 & 2 & -2c_{34} & & \\ & & -2c_{34} & 2 & -1 & \\ & & & -1 & 2 & -2 \\ & & & & -2 & 2 \end{pmatrix}$$

- Let $i = 3$ and $\mu > 0$. Assume P_m^i is one of the two points of $\mathcal{C}(\mathcal{G}_m^3)$ such that $\mu(P_m^i) = \mu$. If $A_{P_m^i}$ has the special form, then as m goes to infinity, $A_{P_m^i}$ converges to the matrix:

$$A_{\infty,\mu}^3 = \begin{pmatrix} 2 & -1 & -1 & & & \\ -1 & 2 & -1 & & & \\ -1 & -1 & 2 & -1 & & \\ & & -1 & 2 & -1 & -\mu^{-1} \\ & & & -1 & 2 & -2 \\ & & & -\mu & -2 & 2 \end{pmatrix}$$

Proof. For the case $i = 1, 2$, recall that $m_{45} = 3$, $m_{56} = m$ and $m_{64} = 2$ (see Table 4). Since $s_{56} \rightarrow 0$, we obtain Ψ_{456} converges to a negative number $\Psi_{\frac{\pi}{3}, 0, \frac{\pi}{2}}$ as $m \rightarrow \infty$. Remember also Equation (2) claiming that

$$0 = \frac{1}{64} \det(A_{P_m^i}) = \frac{1}{8} (2 - (\lambda + \lambda^{-1})) \Psi_{456} - s_{12}^2 c_{34}^2 s_{56}^2$$

So $\lambda \rightarrow 1$ as $m \rightarrow \infty$. The case $i = 3$ is similar, using Equation (3) instead. \square

For each $m \in \mathbb{N} \cup \{\infty\} \setminus \{0, 1\}$, let P_m be a Coxeter polytope with Coxeter group W_m and Coxeter system (S_m, M_m) , and let $\rho_m : W_m \rightarrow \mathrm{SL}^\pm(V)$ be the corresponding representation. A sequence of Coxeter polytopes $(P_m)_m$ converges to P_∞ as $m \rightarrow \infty$ if:

- There is a bijection $\hat{\phi} : S_\infty \rightarrow S_m$ which induces the homomorphism $\phi : W_\infty \rightarrow W_m$.

· The representations $(\rho_m \circ \phi)_m$ converge algebraically to $\rho_\infty \in \text{Hom}(W_\infty, \text{SL}^\pm(V))$.

Note that $\text{Hom}(W_\infty, \text{SL}^\pm(V))$ is the space of all homomorphisms of W_∞ into $\text{SL}^\pm(V)$ with the topology of pointwise convergence.

Corollary 8.2. *Let $i = 1, 2$ or 3 and $\mu > 0$. Let P_m^i be one of the two points of $\mathcal{C}(\mathcal{G}_m^i)$ (such that $\mu(P_m^i) = \mu$ if $i = 3$). As m goes to infinity, the sequence $(P_m^i)_m$ converges to a Coxeter polytope P_∞^i whose Cartan matrix is A_∞^i if $i = 1, 2$ and $A_{\infty, \mu}^3$ if $i = 3$. Moreover, the underlying polytope of P_∞^i is the pyramid over the prism.*

Proof. We ignore the superscript i and the index μ because the proof does not depend on i and μ .

The Cartan matrix A_∞ is irreducible, of negative type and of rank $d + 1$. By Theorem 2.2, there exists a unique Coxeter polytope P_∞ realizing A_∞ . The obvious bijection between S_∞ and S_m and Proposition 8.1 immediately tell us that the sequence $(P_m)_m$ converges to a Coxeter polytope P_∞ . The only remaining part is to prove that the underlying polytope of P_∞ is the pyramid over the prism. Let $T = \{1, 2, 3, 5, 6\}$. The Cartan matrix $A_T = A_T^0$ and $W_T = \tilde{A}_1 \times \tilde{A}_2$ is virtually isomorphic to \mathbb{Z}^3 , and thus the third part of Theorem 2.9 shows that $T \in \sigma(P_\infty)$ and the intersection of the five facets corresponding to T is a vertex v of P_∞ . By Theorem 2.4, the link of P_∞ at v is a parabolic Coxeter 3-polytope whose underlying polytope is a prism, and so P_∞ is indeed the pyramid over the prism. \square

9. A NECESSARY CONDITION FOR DEHN FILLINGS

Let P_∞ be a Coxeter polytope with Coxeter group W_∞ and for some $m_i \in \mathbb{N} \setminus \{0, 1\}$, let P_{m_1, \dots, m_k} be a Dehn filling of P_∞ at a non-empty set $\mathcal{V} = \{v_1, \dots, v_k\}$ of some parabolic vertices of P_∞ , i.e. the underlying labeled polytope of P_∞ is obtained from P_{m_1, \dots, m_k} by collapsing a ridge r_i of label $\frac{\pi}{m_i}$ to the vertex v_i for every $v_i \in \mathcal{V}$. If A_S is a Cartan matrix and $T \subset S$, then A_T denotes the restriction of A_S to $T \times T$, and T^0 the subset of T such that $A_{T^0} = A_T^0$.

Proposition 9.1. *Let $d \geq 3$, and let P_∞ be an irreducible Coxeter polytope of dimension d . If there exists a Dehn filling P_{m_1, \dots, m_k} of P_∞ at \mathcal{V} with $m_i \geq 3$, $i = 1, \dots, k$, then for every $v \in \mathcal{V}$, the link $P_{\infty, v}$ of P_∞ at v is a Coxeter $(d - 1)$ -prism with Coxeter group $W_{\infty, v} = \tilde{A}_1 \times \tilde{A}_{d-2}$.*

Proof. For the simplicity of the notation, we assume that $|\mathcal{V}| = 1$ and denote by P_m the m -Dehn filling of P_∞ at \mathcal{V} . The proof of the general case is similar.

Let S_v be the set of facets of P_∞ containing $v \in \mathcal{V}$. First, look at the v -link Coxeter group $W_{\infty, v}$ of W_∞ , i.e. the Coxeter group of the link $P_{\infty, v}$ of P_∞ at v . Since v is a parabolic vertex, each component of the decomposition of the Coxeter group $W_{\infty, v}$:

$$W_{\infty, v} = W_{\infty, v}^1 \times \cdots \times W_{\infty, v}^l \quad \text{for some } l \in \mathbb{N} \setminus \{0\}$$

is an irreducible affine Coxeter group (see Table 7) and $W_{\infty, v}$ is virtually isomorphic to \mathbb{Z}^{d-1} .

The facets of P_∞ are in correspondence with the facets of P_m , and so we can consider the Coxeter subgroup $W_{m, v}$ of W_m corresponding to the set S_v . Moreover, two adjacent facets of S_v in P_∞ are also adjacent in P_m with the same dihedral angle. Remark that the converse statement is false. Also, the decomposition of $W_{\infty, v}$ gives a partition of the set $S_v = S_v^1 \sqcup \cdots \sqcup S_v^l$, where $W_{\infty, v}^i$ corresponds to S_v^i for each $i = 1, \dots, l$, with the geometric interpretation that if

$s \in S_v^i$ and $t \in S_v^j$ with $i \neq j$, then s and t are adjacent in P_∞ and the dihedral angle is $\frac{\pi}{2}$. As a consequence, the decomposition of $W_{\infty,v}$ induces a decomposition of the Coxeter group $W_{m,v}$:

$$W_{m,v} = W_{m,v}^1 \times \cdots \times W_{m,v}^l$$

At this moment, it is not obvious that each factor $W_{m,v}^i$ of this decomposition is irreducible; however, we will see in the next paragraph that this is the case.

Let r be the ridge of P_m that collapses to the vertex v to obtain P_∞ , and let $r = s \cap t$ with two facets $s, t \in S_v$. Then $W_{\{s,t\}} = I_2(m)$ in W_m and $W_{\{s,t\}} = \tilde{A}_1$ in W_∞ , and so we can assume that $W_{m,v}^1 = I_2(m)$ and $W_{\infty,v}^1 = \tilde{A}_1$. Finally, collapsing the ridge r is the only change of the adjacency rule, and hence for all $i = 2, \dots, l$, we have $W_{m,v}^i = W_{\infty,v}^i$.

Let $A_{\infty,v}$ (resp. $A_{m,v}$) be the Cartan submatrix of $A_\infty := A_{P_\infty}$ (resp. $A_m := A_{P_m}$) corresponding to S_v . According to the decomposition of $W_{\infty,v}$, we can decompose $A_{\infty,v}$ and $A_{m,v}$ as the direct sums:

$$A_{\infty,v} = A_{\infty,v}^1 \oplus \cdots \oplus A_{\infty,v}^l \quad \text{and} \quad A_{m,v} = A_{m,v}^1 \oplus \cdots \oplus A_{m,v}^l$$

where each $A_{\infty,v}^i$ and $A_{m,v}^i$, $i = 1, \dots, l$, correspond to S_v^i , respectively, i.e. each $A_{\infty,v}^i$ (resp. $A_{m,v}^i$) is a component of $A_{\infty,v}$ (resp. $A_{m,v}$). Observe that $l \geq 2$: Otherwise,

$$d - 1 = \text{rank}(A_{\infty,v}) = \text{rank}(A_{\infty,v}^1) = 1,$$

which contradicts to the fact that $d \geq 3$.

Now, we have the following equalities or inequalities for rank:

- $\text{rank}(A_{m,v}) \leq \text{rank}(A_m) \leq d + 1$,
- $\text{rank}(A_{\infty,v}) = d - 1$,
- $\text{rank}(A_{m,v}^1) = \text{rank}(A_{\infty,v}^1) + 1$,
- $\text{rank}(A_{m,v}^i) \geq \text{rank}(A_{\infty,v}^i)$ for every $i \in \{2, \dots, l\}$,
- $\text{rank}(A_{m,v}^i) = \text{rank}(A_{\infty,v}^i) + 1$ for at least one $i \in \{2, \dots, l\}$.

The first item is trivial. The second item follows from the fact that v is a parabolic vertex of P_∞ . The third item is also trivial. The fourth item is a consequence of the second item of Lemma 2.10 and the fact that $W_{m,v}^i = W_{\infty,v}^i$ for every $i \in \{2, \dots, l\}$.

In order to prove the fifth item, we assume on the contrary that for every $i \in \{2, \dots, l\}$, $\text{rank}(A_{m,v}^i) = \text{rank}(A_{\infty,v}^i)$. Let $T = S_v^2 \sqcup \cdots \sqcup S_v^l$. First, by the second item of Lemma 2.10, for each $i \in \{2, \dots, l\}$, the Cartan matrix $A_{m,v}^i$ is of zero type, and hence $A_{m,T} = A_{m,T}^0$.

We claim that $Z(T)^0 = \emptyset$. Indeed, suppose by contradiction that $Z(T)^0 \neq \emptyset$. Let $U = S_v^1 \sqcup Z(T)^0$. Note that $\text{rank}(A_{m,v}^1) = 2$ and $\text{rank}(A_{m,U}) \neq 2$, hence $\text{rank}(A_{m,U}) \geq 3$. Moreover,

$$\begin{aligned} \text{rank}(A_{m,T}) &= \sum_{i=2}^l \text{rank}(A_{m,v}^i) = \sum_{i=2}^l \text{rank}(A_{\infty,v}^i) = \text{rank}(A_{\infty,T}) \quad \text{and} \\ \text{rank}(A_{\infty,T}) &= \text{rank}(A_{\infty,v}) - \text{rank}(A_{\infty,v}^1) = d - 2. \end{aligned}$$

It therefore follows that:

$$d + 1 \leq \text{rank}(A_{m,U}) + \text{rank}(A_{m,T}) = \text{rank}(A_{m,U \sqcup T}) \leq \text{rank}(A_m) \leq d + 1,$$

and so $\text{rank}(A_m) = \text{rank}(A_{m,U \sqcup T}) = d + 1$. Now, consider the Cartan matrix A_m :

$$A_m = \begin{pmatrix} A_{m,U} & 0 & C_U \\ 0 & A_{m,T} & C_T \\ D_U & D_T & B \end{pmatrix}$$

where C_U, D_U, C_T, D_T and B are some matrices. First, all entries of C_U, D_U, C_T and D_T are negative or null. Second, since $A_{m,T}$ is of zero type, there is a vector $X_T > 0$ such that $A_{m,T}X_T = 0$ (see e.g. Theorem 3 of Vinberg [Vin71]). Recall that $X > 0$ if every entry of X is positive. Moreover, since $\text{rank}(A_m) = \text{rank}(A_{m,U \sqcup T})$, we also have that

$$\text{rank} \begin{pmatrix} A_{m,T} \\ D_T \end{pmatrix} = \text{rank}(A_{m,T})$$

and so the vector $D_T X_T$ should be zero. Therefore, D_T is a zero matrix, and so is C_T . However, it is impossible since A_m and A_∞ are irreducible.

As a consequence, $T \in \sigma(P_m)$, i.e. $T = \{s \in S \mid f \subset s\}$ for some face f of P_m , by the second item of Theorem 2.9, and so $S_v = S_v^1 \sqcup T \in \sigma(P_m)$ by the fourth item of Theorem 2.9. Since the face $\cap_{s \in S_v} s$ is of dimension $d - \dim(\text{span}(\alpha_s)_{s \in S_v})$ and $\dim(\text{span}(\alpha_s)_{s \in S_v}) \geq \text{rank}(A_{m,v}) = d$, the face $\cap_{s \in S_v} s$ is in fact a vertex of P_m , which contradicts the combinatorial structure of the Dehn filling P_m .

From the fifth item, we can assume without loss of generality that:

$$\text{rank}(A_{m,v}^2) = \text{rank}(A_{\infty,v}^2) + 1.$$

Now we have to show that $l = 2$. Suppose for contradiction that $l \geq 3$. Since

$$\text{rank}(A_{\infty,v}) = \sum_{i=1}^l \text{rank}(A_{\infty,v}^i) \quad \text{and} \quad \text{rank}(A_{m,v}) = \sum_{i=1}^l \text{rank}(A_{m,v}^i),$$

the previous five equalities and inequalities imply that:

$$\text{rank}(A_m) = \text{rank}(A_{m,v}) = d + 1 \quad \text{and} \quad \text{rank}(A_{m,v}^i) = \text{rank}(A_{\infty,v}^i) \quad \text{for every } i \in \{3, \dots, l\}$$

and hence by the second item of Lemma 2.10, we conclude that for every $i = 3, \dots, l$, $A_{m,v}^i$ is equivalent to $A_{\infty,v}^i$, which is of zero type.

Now look at the Cartan matrix A_m :

$$A_m = \begin{pmatrix} A_{m,v}^1 & 0 & 0 & \dots & 0 & C_1 \\ 0 & A_{m,v}^2 & 0 & \dots & 0 & C_2 \\ 0 & 0 & A_{m,v}^3 & \dots & 0 & C_3 \\ \dots & \dots & \dots & \dots & 0 & \dots \\ 0 & 0 & 0 & 0 & A_{m,v}^l & C_l \\ D_1 & D_2 & D_3 & \dots & D_l & F \end{pmatrix}$$

where $C_i, D_i, i = 1, \dots, l$, and F are some matrices. As in the proof of the previous claim, we can show that for every $i = 3, \dots, l$, the matrices D_i and C_i are zero, which contradicts the fact that A_m and A_∞ are irreducible. Finally, we prove that $l = 2$.

In the previous paragraph, we show that $A_{m,v}^2$ cannot be of zero type, and therefore the Coxeter group $W_{\infty,v}^2 = W_{m,v}^2$ must be an irreducible affine Coxeter group which can be realized by a Cartan matrix not of zero type. By the third item of Lemma 2.10, only one family of

irreducible affine Coxeter group satisfies this property: \tilde{A}_k (see Table 7). After all, $W_{\infty, v} = \tilde{A}_1 \times \tilde{A}_k$ virtually isomorphic to \mathbb{Z}^{k+1} , and therefore $k = d - 2$.

Finally, the Coxeter polytope $P_{\infty, v}$ satisfies the hypothesis of Theorem 2.4, and so $P_{\infty, v}$ is isomorphic to $\hat{\Delta}_{\tilde{A}_1 \times \tilde{A}_{d-2}}$, which is a $(d - 1)$ -prism. \square

10. HOW TO MAKE MORE EXAMPLES

10.1. Some definitions.

Truncation. Let \mathcal{G} be a combinatorial polytope, and let v be a vertex of \mathcal{G} . A (combinatorial) truncation of \mathcal{G} at v is the operation that cuts the vertex v (without touching the facets not containing v) and that creates a new facet in place of v (see Figure 7). The truncated polytope of \mathcal{G} at v is denoted by $\mathcal{G}^{\dagger v}$. If \mathcal{G} is a labeled polytope, then we attach the labels $\frac{\pi}{2}$ to all new ridges of $\mathcal{G}^{\dagger v}$, and we denote this new labeled polytope again by $\mathcal{G}^{\dagger v}$. Given a set \mathcal{V} of vertices of \mathcal{G} , in a similar way, we define the truncated polytope $\mathcal{G}^{\dagger \mathcal{V}}$ of \mathcal{G} at \mathcal{V} .

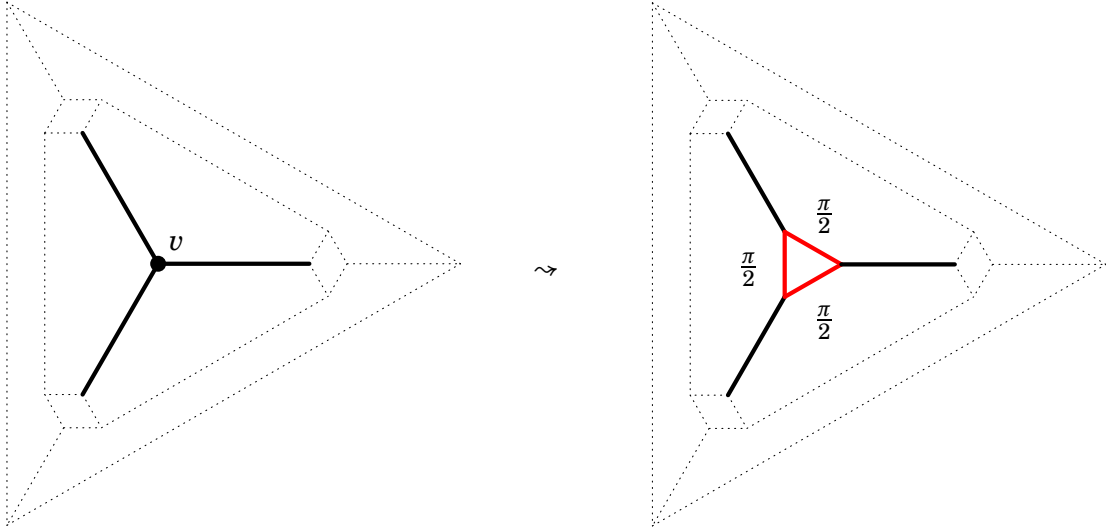

FIGURE 7. An example of truncation: $\mathcal{G} \rightsquigarrow \mathcal{G}^{\dagger v}$

If P is a Coxeter polytope of \mathbb{S}^d and v is a vertex of P , then we can also define a (geometric) truncation applied to P in the case when:

Definition 10.1. The vertex v of P is *truncatable* if the projective subspace Π_v spanned by the poles $[b_s]$ for all facets s of P containing v is a hyperplane such that for every (closed) edge e containing v , the set $\Pi_v \cap e$ consists of exactly one point in the interior of e .

Assume that a vertex v of P is truncatable. Then a new Coxeter polytope $P^{\dagger v}$ can be obtained from P by the following operation of *truncation*: Let Π_v^- (resp. Π_v^+) be the connected component of $\mathbb{S}^d \setminus \Pi_v$ which does not contain v (resp. which contains v), and let $\overline{\Pi_v^-}$ be the closure of Π_v^- . The underlying polytope of $P^{\dagger v}$ is $\overline{\Pi_v^-} \cap P$, which has one *new facet* given by the

hyperplane Π_v and the *old facets* given by P . The reflections about the old facets of $P^{\dagger v}$ are unchanged, and the reflection about the new facet is determined by the support Π_v and the pole v . It is easy to see that the dihedral angles of the ridges in the new facet of $P^{\dagger v}$ are $\frac{\pi}{2}$.

Remark 10.2. The hyperplane Π_v is invariant by the reflections about the facets of P containing v , and thus the intersection $\Pi_v \cap P$ is a Coxeter polytope of Π_v isomorphic to P_v . Also, note that the polytope $\overline{\Pi_v^+} \cap P$ is the pyramid over $\Pi_v \cap P$.

In a similar way, if \mathcal{V} is a subset of the set of truncatable vertices of P , then we may define the truncated Coxeter polytope $P^{\dagger \mathcal{V}}$ of P at \mathcal{V} . The following lemma is an easy corollary of Proposition 4.14 and Lemma 4.17 of Marquis [Mar17].

Lemma 10.3. *Let \mathcal{G} be a labeled polytope with Coxeter group W , and let \mathcal{V} be a subset of the set of simple vertices of \mathcal{G} . Assume that W is irreducible and for every $v \in \mathcal{V}$, the v -link Coxeter group W_v is Lannér. Then the map $\chi: \mathfrak{C}(\mathcal{G}) \rightarrow \mathfrak{C}(\mathcal{G}^{\dagger \mathcal{V}})$ given by $\chi(P) = P^{\dagger \mathcal{V}}$ is well-defined and χ is a homeomorphism.*

Remark 10.4. If \mathcal{G} is a labeled polytope with only spherical and Lannér vertices and \mathcal{V} is the set of Lannér vertices, then $\mathcal{G}^{\dagger \mathcal{V}}$ is perfect.

Gluing. Let \mathcal{G}_1 and \mathcal{G}_2 be two labeled d -polytopes, and let v_i , $i = 1, 2$, be a vertex of \mathcal{G}_i . If there is an isomorphism $f: (\mathcal{G}_1)_{v_1} \rightarrow (\mathcal{G}_2)_{v_2}$ as labeled polytope, then we can construct a new labeled d -polytope, denoted by $\mathcal{G}_1 \#_{v_1 \# v_2} \mathcal{G}_2$ (or simply $\mathcal{G}_1 \# \mathcal{G}_2$), by gluing together two truncated polytopes $\mathcal{G}_1^{\dagger v_1}$ and $\mathcal{G}_2^{\dagger v_2}$ via f (see Figure 8).

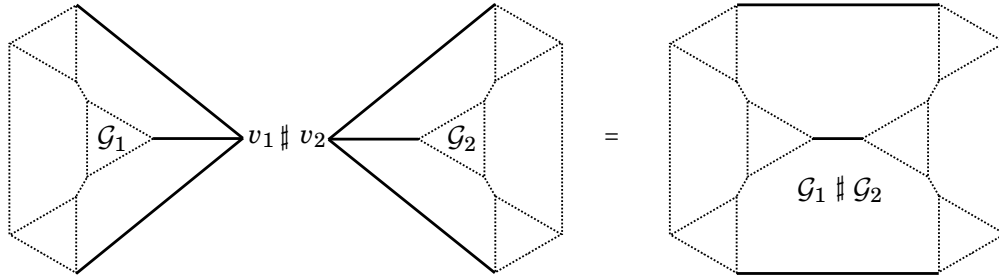

FIGURE 8. Gluing two 3-polytopes \mathcal{G}_1 and \mathcal{G}_2 along v_1 and v_2

Similarly, we can also define a (geometric) gluing applied to Coxeter polytopes: Let P_1 and P_2 be Coxeter polytopes of \mathbb{S}^d and let v_i , $i = 1, 2$, be a truncatable vertex of P_i . If there is an isomorphism $g: (P_1)_{v_1} \rightarrow (P_2)_{v_2}$ as Coxeter polytopes, then the Coxeter polytope $P_1 \# P_2$ is obtained by gluing two truncated polytopes $P_1^{\dagger v_1}$ and $P_2^{\dagger v_2}$ via g . For more details about truncation, we refer to [CLMa].

10.2. Examples of truncatable polytopes. In order to check whether the Coxeter group is relatively Gromov-hyperbolic or not, we need the following theorem. Recall that if (S, M) is a Coxeter system, then a subset T of S gives us a Coxeter subsystem (T, M_T) , where M_T is the restriction of M to $T \times T$. Here, we abbreviate (T, M_T) to T . If $s, t \in S$ are commuting elements of W_S , then we express this fact by writing $s \perp t$. In a natural way, we may understand the following notations: $S_1 \perp S_2$ for $S_1, S_2 \subset S$, and U^\perp for $U \subset S$.

Theorem 10.5 (Moussong [Mou88] and Caprace [Cap09, Cap15]). *Let (S, M) be a Coxeter system, and let \mathcal{T} be a collection of subsets of S . Then the group W_S is Gromov-hyperbolic relative to $\{W_T \mid T \in \mathcal{T}\}$ if and only if the following hold:*

- *If U is an affine subsystem of S of rank ≥ 3 , then $U \subset T$ for some $T \in \mathcal{T}$.*
- *If S_1, S_2 are irreducible non-spherical subsystems such that $S_1 \perp S_2$, then $S_1 \cup S_2 \subset T$ for some $T \in \mathcal{T}$.*
- *If T, T' are two distinct elements of \mathcal{T} , then $T \cap T'$ is a spherical subsystem of S .*
- *If $T \in \mathcal{T}$ and U is an irreducible non-spherical subsystem of T , then $U^\perp \subset T$.*

10.2.1. *First example.* Let $P \in \mathcal{C}(\mathcal{G}_m^2)$ and let \mathcal{V} be the set of the two Lannér vertices of P . By Lemma 10.3, every vertex $v \in \mathcal{V}$ is truncatable, and hence we obtain a perfect polytope $P^{\dagger\mathcal{V}}$.

10.2.2. *Second example.* Take the Coxeter group U in the left diagram of Table 5. As in Section 4, we can label the product of two triangles according to the Coxeter diagram U to obtain a labeled 4-polytope \mathcal{G}_U , which has 5 spherical vertices and 4 Lannér vertices. By Moussong's criterion (see Theorem 10.5), the Coxeter group U is Gromov-hyperbolic; however, we will see that U is not hyperbolizable, i.e. U cannot be the Coxeter group of a hyperbolic Coxeter 4-polytope, by computing the deformation space of \mathcal{G}_U .

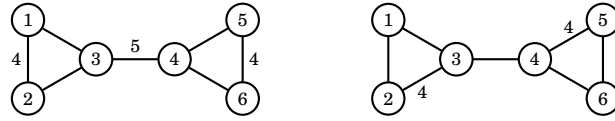

TABLE 5. The Coxeter diagrams of U and V

We will compute the deformation space $\mathcal{C}(\mathcal{G}_U)$ of \mathcal{G}_U and see that $\mathcal{C}(\mathcal{G}_U)$ satisfies the surprising property of being homeomorphic to a circle. In a way similar to Section 7, the deformation space $\mathcal{C}(\mathcal{G}_U)$ is homeomorphic to $\{(\lambda, \mu) \in \mathbb{R}^2 \mid \lambda, \mu > 0 \text{ and } \det(A_{\lambda, \mu}) = 0\}$, where:

$$A_{\lambda, \mu} = \begin{pmatrix} 2 & -\sqrt{2} & -\lambda^{-1} & & & & \\ -\sqrt{2} & 2 & -1 & & & & \\ -\lambda & -1 & 2 & -2c_5 & & & \\ & & -2c_5 & 2 & -1 & -\mu^{-1} & \\ & & & -1 & 2 & -\sqrt{2} & \\ & & & -\mu & -\sqrt{2} & 2 & \end{pmatrix}$$

A straightforward computation gives us:

$$\begin{aligned} \frac{1}{64} \det(A_{\lambda, \mu}) &= \left(1 - \frac{1}{4} - \frac{1}{4} - \frac{1}{2} - \frac{11}{22} \frac{\sqrt{2}}{2} (\lambda + \lambda^{-1})\right) \left(-\frac{\sqrt{2}}{8} (\mu + \mu^{-1})\right) - c_5^2 s_4^2 s_4^2 \\ \frac{1}{2} \det(A_{\lambda, \mu}) &= (\lambda + \lambda^{-1})(\mu + \mu^{-1}) - 8c_5^2 \end{aligned}$$

In other words, the deformation space $\mathcal{C}(\mathcal{G}_U)$ is homeomorphic to:

$$\{(\lambda, \mu) \in \mathbb{R}^2 \mid \lambda, \mu > 0 \text{ and } (\lambda + \lambda^{-1})(\mu + \mu^{-1}) - 8c_5^2 = 0\}$$

which is homeomorphic to a circle (see Figure 9).

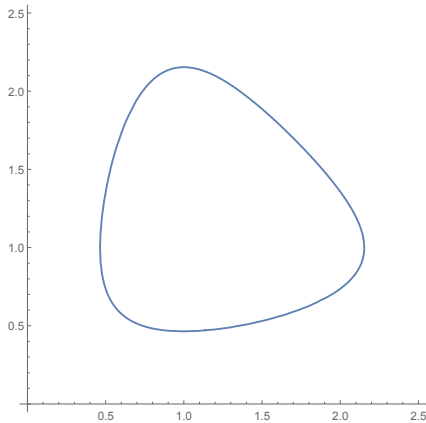

FIGURE 9. The deformation space of \mathcal{G}_U

As a consequence, first \mathcal{G}_U is not hyperbolizable by Theorem 2.11 since $\lambda = \mu = 1$ is not in $\mathcal{C}(\mathcal{G}_U)$, and second we can answer the following question asked by Benoist if we weaken slightly the assumption:

Question 10.6. *Is there a perfect labeled polytope \mathcal{G} such that \mathcal{G} can be realized as a hyperbolic Coxeter polytope and the deformation space $\mathcal{C}(\mathcal{G})$ is compact and is of dimension ≥ 1 ?*

Theorem 10.7. *There exists a perfect labeled 4-polytope \mathcal{G} such that $W_{\mathcal{G}}$ is Gromov-hyperbolic and $\mathcal{C}(\mathcal{G})$ is homeomorphic to the circle.*

Proof. Let \mathcal{V} be the set of all Lannér vertices of \mathcal{G}_U . Then the truncated polytope $\mathcal{G}_U^{\dagger\mathcal{V}}$ is perfect, and by Lemma 10.3, $\mathcal{C}(\mathcal{G}_U^{\dagger\mathcal{V}}) = \mathcal{C}(\mathcal{G}_U)$, which is homeomorphic to the circle. \square

Remark that if we take the Coxeter group V in the right diagram of Table 5, then $\mathcal{C}(\mathcal{G}_V)$ is also homeomorphic to a circle and every Coxeter polytope $P \in \mathcal{C}(\mathcal{G}_V)$ is quasi-perfect and of finite volume. Note that the link of \mathcal{G}_V at the vertex v_{2345} has the Coxeter group:

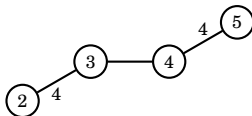

which is the affine Coxeter group \tilde{C}_3 virtually isomorphic to \mathbb{Z}^3 (see Table 7).

10.3. Playing Lego.

First game. Let N be an integer ≥ 2 , let T be a linear tree with N vertices, i.e. each vertex of T is of valence 1 or 2, and enumerate the vertices t_1, t_2, \dots, t_N of T .

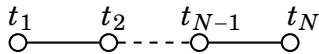

FIGURE 10. The first game

Choose N integers $m_1, \dots, m_N > 6$, and for each $i = 1, \dots, N$, select a Coxeter polytope P_i from the two polytopes in $\mathcal{C}(\mathcal{G}_{m_i}^2)$ (see Section 7). Each P_i has two truncatable vertices whose links are isomorphic as Coxeter polytope because every Lannér vertex of $\mathcal{G}_{m_i}^2$ is rigid. Let \mathcal{V}_i be the set of truncatable vertices of P_i . If each vertex t_i of T corresponds to P_i , then the tree

T naturally gives us a pattern to glue the Coxeter polytopes $P_i^{\dagger\mathcal{V}_i}$, $i = 1, \dots, N$, along the new facets of $P_i^{\dagger\mathcal{V}_i}$ in order to obtain a perfect Coxeter 4-polytope P_{m_1, \dots, m_N} . Remark that for each t_i , there may be several possible positions of P_i .

If we make every m_i go to infinity, then the limit $P_{\infty, \dots, \infty}$ is a finite volume hyperbolic Coxeter 4-polytope with N cusps. In other words, the Coxeter polytopes P_{m_1, \dots, m_N} are Dehn fillings of $P_{\infty, \dots, \infty}$. An important remark is that since the choice of the integers $m_1, \dots, m_N > 6$ are independent each other, we can apply the Dehn filling operation to each cusp of $P_{\infty, \dots, \infty}$ *independently*.

Second game. Choose two integers $N, N' \geq 1$ and a tree T with $N + N'$ vertices such that N vertices, denoted by $\{\tau_1, \dots, \tau_N\} =: \tau$, are of valence 1 or 2 and N' vertices, denoted by $\{\tau'_1, \dots, \tau'_{N'}\} =: \tau'$, are of valence 1, 2, 3 or 4. Select N integers $m_1, \dots, m_N > 6$.

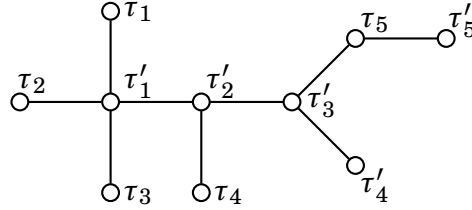

FIGURE 11. The second game with $N = N' = 5$

For each vertex $t \in \tau$ (resp. τ'), we put a Coxeter polytope P_i (resp. Q_j) among the polytopes in $\mathcal{C}(\mathcal{G}_{m_i}^2)$ (resp. $\mathcal{C}(\mathcal{G}_U)$). Each Coxeter polytope P_i (resp. Q_j) has two (resp. four) truncatable rigid vertices, and all the links of P_i and Q_j at the truncatable vertices are isomorphic to each other. Let \mathcal{V}_i (resp. \mathcal{V}'_j) be the set of truncatable vertices of P_i (resp. Q_j). Then the tree T gives us a pattern to glue the Coxeter polytopes $P_i^{\dagger\mathcal{V}_i}$, $i = 1, \dots, N$, and $Q_j^{\dagger\mathcal{V}'_j}$, $j = 1, \dots, N'$, along their new facets in order to obtain a perfect Coxeter 4-polytope P'_{m_1, \dots, m_N} .

Once again, if every m_i goes to infinity, then by Theorem 2.5, the limit polytope $P'_{\infty, \dots, \infty}$ is of finite volume in $\Omega_{P'_{\infty, \dots, \infty}}$. Remark that by Theorem 10.5 of Caprace, the Coxeter group of $P'_{\infty, \dots, \infty}$ is Gromov-hyperbolic relative to the standard subgroups corresponding to the parabolic vertices of $P'_{\infty, \dots, \infty}$, however $P'_{\infty, \dots, \infty}$ *cannot* be a hyperbolic Coxeter polytope since \mathcal{G}_U is not hyperbolizable.

11. HIGHER DIMENSIONAL EXAMPLES

11.1. The deformation spaces and the limits. As in Section 4, we can label the product of a $(d-2)$ -simplex and a triangle according to each of the 13 families of Coxeter groups $(W_m)_{m>6}$ in Tables 1(B), 1(C), 1(D) in order to obtain a labeled polytope \mathcal{G}_m .

First, let a_1, \dots, a_{d-1} be the vertices in the loop \tilde{A}_{d-2} of W_m , and b_1, b_2, b_3 the remaining vertices of W_m . Next, denote the facets of the $(d-2)$ -simplex by the same symbols a_1, \dots, a_{d-1} and the edges of the triangle by the symbols b_1, b_2, b_3 . Then the symbols $a_1, \dots, a_{d-1}, b_1, b_2, b_3$ are naturally assigned to the facets of $\Delta_{d-2} \times \Delta_2$. Finally, we obtain the labeled polytopes \mathcal{G}_m with a ridge labeling on $\Delta_{d-2} \times \Delta_2$ according to W_m . We extend the technique in Sections 7 and 8 to show:

Theorem 11.1. *Choose one of the 13 families $(W_m)_{m>6}$ in Tables 1(B), 1(C), 1(D). If the Coxeter graphs of the family have one loop, then $\mathcal{C}(\mathcal{G}_m)$ consists of two points. If the Coxeter graphs of the family have two loops, then $\mathcal{C}(\mathcal{G}_m)$ consists of two disjoint lines.*

If $m = \infty$, then we can label a pyramid over a $(d-1)$ -prism according to W_∞ in order to obtain a labeled polytope \mathcal{G}_∞ . Eventually, we can show:

Theorem 11.2. *Choose one of the 13 families $(W_m)_{m>6}$ in Tables 1(B), 1(C), 1(D).*

- *Assume that the Coxeter graphs of the family have one loop. If P_m is one of the two points of $\mathcal{C}(\mathcal{G}_m)$, then the sequence $(P_m)_m$ converges to the unique hyperbolic polytope P_∞ whose Coxeter graph is W_∞ .*
- *Assume that the Coxeter graphs of the family have two loops. If $\mu > 0$ and P_m is one of the two points of $\mathcal{C}(\mathcal{G}_m)$ such that $\mu(P_m) = \mu$, then $(P_m)_m$ converges to P_∞ which is the unique Coxeter polytope such that $\mu(P_\infty) = \mu$ and whose Coxeter graph is W_∞ .*

In any case, the underlying polytopes of P_m , for $m < \infty$, are $\Delta_2 \times \Delta_{d-2}$.

Proof of Theorems 11.1 and 11.2. We first need to compute $\mathcal{C}(\mathcal{G}_m)$. The proof is identical to the proof of Proposition 7.1, so we leave it to the reader. To help the reader do the actual computation, we remark that if c_1, \dots, c_n are real numbers and D_λ is the determinant of the following matrix M_λ :

$$M_\lambda = \begin{pmatrix} 1 & -c_1 & & & & -c_n \lambda^{-1} \\ -c_1 & 1 & -c_2 & & & \\ & -c_2 & 1 & -c_3 & & \\ & & -c_3 & 1 & \ddots & \\ & & & \ddots & 1 & -c_{n-1} \\ -c_n \lambda & & & & -c_{n-1} & 1 \end{pmatrix}$$

then we have the following equality:

$$D_\lambda = D_1 - c_1 c_2 \cdots c_n (\lambda + \lambda^{-1} - 2)$$

Now we need to check that \mathcal{G}_m is the underlying labeled polytope of any Coxeter polytopes realizing W_m . In the case when $m = \infty$, there is a standard subgroup of W_∞ that is an affine Coxeter group $\tilde{A}_1 \times \tilde{A}_{d-2}$, and hence as in the proof of Corollary 8.2, P_∞ is a pyramid over a prism (see also Proposition 9.1).

In the case when $m < \infty$, we need to be more careful, and we will separate the case of dimension 5 from the case of dimensions 6 and 7. If we denote by $\text{Pyr}^g(Q)$ the polytope obtained from Q by iterating the construction $R \mapsto \text{Pyr}(R)$ g times, then every d -polytope with $d+2$ facets is of the form $\text{Pyr}^g(\Delta_e \times \Delta_f)$ with $e+f+g=d$ (see Section 6.5 of Ziegler [Zie95]). It is easy to show that $\text{Pyr}^g(\Delta_e \times \Delta_f)$ is a polytope with $(e+1)(f+1)+g$ vertices and among them exactly $(e+1)(f+1)$ vertices are simple. Moreover, the number of edges of $\text{Pyr}^g(\Delta_e \times \Delta_f)$ is $(e+1)(f+1)(g + \frac{e+f}{2}) + \frac{g(g-1)}{2}$.

First in dimension $d = 6$ or 7 , the $3(d-1)$ standard subgroups of W_m given by deleting one node of the \tilde{A}_{d-2} loop and one node of the remaining part are spherical Coxeter groups of rank d (or irreducible affine Coxeter groups \tilde{E}_6 of rank d if $d = 7$). It follows that the Coxeter group W_m contains at least $3(d-1)$ standard subgroups of rank d which are spherical (or

irreducible affine of type \tilde{E}_6 if $d = 7$), and so by the first and third items of Theorem 2.9, P_m has at least $3(d - 1)$ simple vertices.

Now, a careful inspection shows that: *if $d = 6$ or 7 , then the only d -polytopes with at least $3(d - 1)$ simple vertices are: $\Delta_2 \times \Delta_4$, $\Delta_3 \times \Delta_3$, $\Delta_2 \times \Delta_5$ and $\Delta_3 \times \Delta_4$.* In particular, P_m must be simple, and we just have to eliminate the possibility of $\Delta_3 \times \Delta_3$ and $\Delta_3 \times \Delta_4$.

In order to do so, we need to introduce the following: Let S be the set of facets of a polytope P . A subset A of $(k + 1)$ elements of S is *prismatic* if the intersection of the facets in A is empty, and for every subset B of k elements of A , the intersection of the facets in B is a $(d - k)$ -dimensional face of P . Notice that for the polytope $\Delta_e \times \Delta_f$ with $e \leq f$, there exists a prismatic subset of $(f + 1)$ facets but no prismatic subset of $(f + 2)$ facets.

We denote by T the set of nodes of the \tilde{A}_{d-2} loop of W_m , and by U the set of two nodes of W_m connected by the edge of label m . For every subset T' of $(d - 2)$ elements of T , the intersection of the facets of P_m in T' is a 2-dimensional face of P_m by the first item of Theorem 2.9. We now claim that T is a prismatic subset of $(d - 1)$ facets of P_m , i.e. the intersection q of the facets in T is empty. Indeed, suppose by contradiction that $q \neq \emptyset$. Then $T \in \sigma(P_m)$, i.e. $T = \{s \in S \mid q \subset s\}$, because P_m is a simple polytope. Since (i) $T \perp U$, (ii) $U = U^+$, and (iii) $T = T^0$ or $T = T^-$, we have that $T = (T \sqcup U)^0$ or $T = (T \sqcup U)^-$, and so $(T \sqcup U)^0 \cup (T \sqcup U)^- = T \in \sigma(P_m)$. Now, by the fourth item of Theorem 2.9, $T \sqcup U \in \sigma(P_m)$, which is impossible, because P_m is a simple d -polytope and $|T \sqcup U| = d + 1$. As a consequence, P_m must be $\Delta_2 \times \Delta_{d-2}$.

Second, in dimension $d = 5$, we should remark that the 30 standard subgroups of W_m given by deleting one node (resp. two nodes) of the \tilde{A}_3 loop and two nodes (resp. one node) of the remaining part are spherical of rank $d - 1$. So the Coxeter group W_m contains at least 30 standard spherical subgroups of rank $d - 1$. By Theorem 2.9, this implies that P_m has at least 30 edges. Finally, a careful inspection shows that the only 5-polytope with 7 facets and with at least 30 edges is $\Delta_2 \times \Delta_3$. \square

Remark 11.3. The following is the reason why we separate the arguments for dimension 5 and dimensions 6 and 7: On the one hand, the right Coxeter group in Table 1(B) with $p = q = 5$ has only 6 standard spherical subgroups of rank 5. On the other hand, the polytope $\text{Pyr}(\Delta_3 \times \Delta_3)$ has 64 edges, however $\Delta_2 \times \Delta_5$ has only 63 edges.

11.2. Nine examples in dimension 5. See the left diagram in Table 1(B). If $p = 3$, then the Coxeter polytopes P_m with m finite are perfect and Ω_{P_m} is not strictly convex nor with \mathcal{C}^1 boundary. The polytope P_∞ is a quasi-perfect hyperbolic Coxeter polytope with one parabolic vertex.

If $p = 4$, then the polytopes P_m with m finite are quasi-perfect with one parabolic vertex and Ω_{P_m} is not strictly convex nor with \mathcal{C}^1 boundary. The polytope P_∞ is a quasi-perfect hyperbolic Coxeter polytope with two parabolic vertices.

If $p = 5$, then the polytopes P_m with m finite are 2-perfect with three rigid loxodromic vertices and Ω_{P_m} is not strictly convex. The polytope P_∞ is a 2-perfect hyperbolic Coxeter polytope with one parabolic vertex and three rigid loxodromic vertices.

Now look at the right diagram in Table 1(B). Here we will only mention the properties of the Coxeter polytope P_m when m is finite. When $(p, q) = (3, 3)$, the Coxeter polytopes P_m are perfect. When $(p, q) = (4, 3)$, the Coxeter polytopes P_m are quasi-perfect with one

parabolic vertex. When $(p, q) = (4, 4)$, the Coxeter polytopes P_m are quasi-perfect with two parabolic vertices. When $(p, q) = (5, 3)$, the Coxeter polytopes P_m are 2-perfect with three rigid loxodromic vertices. When $(p, q) = (5, 4)$, the Coxeter polytopes P_m are 2-perfect with one parabolic vertex and three rigid loxodromic vertices. Finally, when $(p, q) = (5, 5)$, the Coxeter polytopes P_m are 2-perfect with six rigid loxodromic vertices.

An important remark is that when $p = 5$, we can apply the operation of truncation to P_m and of gluing in order to build infinitely many non-prime examples.

11.3. Two examples in dimension 6. The two Coxeter polytopes we find in dimension 6 are perfect when m is finite (see Table 1(C)). The following remark explains why we *cannot* construct infinitely many non-prime examples in dimension ≥ 6 . In other words, it is hard to find truncatable vertices of polytopes of dimension ≥ 6 .

Remark 11.4. By the work of Lannér, we know that large perfect Coxeter simplex, which corresponds to Lannér Coxeter group, exists only up to dimension 4. However, Lemma 10.3 which is the starting point for truncation requires a truncatable vertex to be simple, and hence the operation of truncation and gluing easily works only up to dimension 5.

Remark 11.5. There exists a Coxeter polytope with a *non-truncatable non-simple* loxodromic perfect vertex (See Appendix A for more details).

11.4. Two examples in dimension 7. The two Coxeter polytopes we find in dimension 7 are quasi-perfect when m is finite (see Table 1(D)). Note P_m is *not* perfect.

12. PROOF OF THE MAIN THEOREMS

12.1. Proof of Theorem A.

Proof of Theorem A. As mentioned in Remark 4.3, Theorems 5.1, 5.2, 11.1 and 11.2 provide finite volume hyperbolic Coxeter polytopes P_∞ of dimension $d = 4, 5, 6, 7$ that admit Dehn fillings $(P_m)_{m>6}$.

For each $m > 6$ or $m = \infty$, let (S_m, M_m) be the Coxeter system of P_m , let $W_m := W_{P_m}$, and let $\sigma_m : W_m \rightarrow \mathrm{SL}_{d+1}^\pm(\mathbb{R})$ be the faithful representation of W_m obtained from P_m as in Tits-Vinberg's Theorem 2.1. The image $\Gamma_m := \Gamma_{P_m} = \sigma_m(W_m)$ is a discrete subgroup of $\mathrm{SL}_{d+1}^\pm(\mathbb{R})$ acting properly discontinuously on the properly convex domain Ω_m of \mathbb{S}^d . We denote by $\phi : W_\infty \rightarrow W_m$ the natural surjective homomorphism induced by the obvious bijection between S_∞ and S_m , and set $\rho_m := \sigma_m \circ \phi$.

Since the Coxeter polytopes $(P_m)_{m>6}$ and P_∞ are quasi-perfect, the action of Γ_m on Ω_m and of Γ_∞ on Ω_∞ is of finite covolume by Theorem 2.5. In fact, in the case where P_m is perfect, the action is cocompact by definition of the perfectness (see Section 2.9).

We denote by \mathcal{O}_m the underlying smooth orbifold of the convex real projective d -orbifold Ω_m/Γ_m for $m > 6$ or $m = \infty$. Then the induced representation $W_\infty/\ker(\rho_m) \rightarrow \mathrm{SL}_{d+1}^\pm(\mathbb{R})$ of ρ_m , which may be identified with σ_m , is the holonomy representation of the properly convex real projective structure on the m -Dehn filling \mathcal{O}_m of \mathcal{O}_∞ , by the first paragraph of this proof.

By Corollary 8.2, the sequence of Coxeter polytopes $(P_m)_{m>6}$ converges to P_∞ , hence the sequence of representations $(\rho_m)_{m>6}$ converges algebraically to ρ_∞ .

Since the Coxeter polytopes $(P_m)_{m>6}$ and P_∞ are quasi-perfect, the convex domains $(\Omega_m)_{m>6}$ (resp. Ω_∞) that are different from \mathbb{S}^d and that are invariant by $\rho_m(W_\infty)$ (resp. $\rho_\infty(W_\infty)$) are unique by Theorem 8.2 of [Mar17].

Eventually, the properly convex closed subsets $(\overline{\Omega_m})_{m>6}$ of \mathbb{S}^d converges to a convex closed set K in some affine chart of \mathbb{S}^d (up to subsequence), and so the uniqueness of the $\rho_\infty(W_\infty)$ -invariant convex domain Ω_∞ implies that $K = \overline{\Omega_\infty}$. As a consequence, the sequence of convex sets $(\overline{\Omega_m})_{m>6}$ converges to $\overline{\Omega_\infty}$ in the Hausdorff topology. \square

12.2. Proof of Theorem B.

Proof of Theorem B. Let W_∞ (resp. W_m) be the orbifold fundamental group of \mathcal{O}_∞ (resp. \mathcal{O}_m). By (a refined version of) Selberg's Lemma (see for example Theorem 3.1 of McReynolds, Reid and Stover [MRS13]), there is a torsion-free finite-index normal subgroup Γ_∞ of W_∞ such that the quotient $M_\infty = \Omega_\infty/\Gamma_\infty$ is a manifold *with toral boundary*. Let Γ_m be the projection of Γ_∞ by the surjective homomorphism $W_\infty \rightarrow W_m$. The subgroup Γ_m of W_m is of finite index bounded above by the index of Γ_∞ in W_∞ , and the closed d -orbifolds $M_m = \Omega_m/\Gamma_m$ are Dehn fillings of M_∞ . \square

Remark 12.1. In the proof of Theorem B, if m is sufficiently big, then the orbifold M_m is not a manifold.

Proof of Remark 12.1. Assume for contradiction that Γ_m is torsion-free. Since Γ_m is torsion-free, the restriction of the map $W_m \rightarrow W_m/\Gamma_m$ to D_m is injective. This implies that the index of Γ_m inside W_m is unbounded, which is a contradiction. \square

12.3. Proof of Theorems C, D and E. The main tools to prove Theorem C are Theorem 10.5 of Moussong and Caprace and Theorem 12.2 of Druţu and Sapir [DS05]. We state a simplified version of the main theorem in [DS05]. Recall the definition of quasi-isometry: Let (X, d_X) and (Y, d_Y) be metric spaces. A map $f : X \rightarrow Y$ is called a (c, D) -quasi-isometric embedding if there exist constants $c \geq 1$ and $D \geq 0$ such that for all $x, x' \in X$,

$$\frac{1}{c}d_X(x, x') - D \leq d_Y(f(x), f(x')) \leq cd_X(x, x') + D.$$

Moreover, a quasi-isometric embedding $f : X \rightarrow Y$ is a *quasi-isometry* if there is $E > 0$ such that the E -neighborhood of $f(X)$ is Y .

Theorem 12.2 (Druţu and Sapir [DS05]). *Let Γ be a finitely generated Gromov hyperbolic group relative to a family A_1, \dots, A_r of virtually abelian subgroups of rank at least two. Let Λ be a finitely generated group and B a virtually abelian group of rank at least two.*

- *For every quasi-isometric embedding of B into Γ , the image of B is at bounded distance from a coset γA_i for some $\gamma \in \Gamma$ and some $i \in \{1, \dots, r\}$.*
- *If Λ is quasi-isometric to Γ , then Λ is Gromov-hyperbolic relative to a family B_1, \dots, B_s of subgroups, each of which is quasi-isometric to A_i for some $i \in \{1, \dots, r\}$.*

Proof of Theorem C. The fact that the Coxeter group Γ is Gromov-hyperbolic relative to a family of standard subgroups H_1, \dots, H_k isomorphic to \tilde{A}_{d-2} is an easy consequence of Theorem 10.5 of Caprace. Recall that the Coxeter group \tilde{A}_{d-2} is a virtually abelian group of rank $d-2$.

By Lemma 8.19 of Marquis [Mar17], the convex domain Ω contains a properly embedded $(d-2)$ -simplex. Now, we show that the convex domain Ω does not contain a properly embedded $(d-1)$ -simplex.

First, note that a $(d-1)$ -simplex equipped with Hilbert metric is bilipshitz equivalent to the Euclidean space \mathbb{R}^{d-1} (see de la Harpe [dlH93]). Second, since Γ divides Ω , by Švarc-Milnor lemma, the group Γ is quasi-isometric to the metric space (Ω, d_Ω) . Hence, any properly embedded $(d-1)$ -simplex induces a quasi-isometric embedding f of \mathbb{R}^{d-1} into Γ , which is Gromov-hyperbolic relative to a family of subgroups H_1, \dots, H_k virtually isomorphic to \mathbb{Z}^{d-2} . By the first item of Theorem 12.2, the embedding f induces a quasi-isometric embedding of \mathbb{R}^{d-1} into a coset γH_i for some $\gamma \in \Gamma$ and some $i \in \{1, \dots, k\}$, which is quasi-isometric to \mathbb{Z}^{d-2} , but there is no quasi-isometric embedding of \mathbb{R}^{d-1} into \mathbb{Z}^{d-2} .

Finally, the quotient orbifold Ω/Γ does not decompose into hyperbolic pieces, i.e. it is not homeomorphic to a union along the boundaries of finitely many d -orbifolds each of which admits a finite volume hyperbolic structure on its interior, because otherwise Γ would be Gromov-hyperbolic relative to a finite collection of subgroups virtually isomorphic to \mathbb{Z}^{d-1} , and Γ is Gromov-hyperbolic relative to a finite collection of subgroups virtually isomorphic to \mathbb{Z}^{d-2} , which would contradict the item 2 of Theorem 12.2. \square

Proof of Theorem D. See the Coxeter graphs of Table 2. Each of those Coxeter graph W is obtained by linking a Coxeter subgraph W_{left} which is an \tilde{A}_2, \tilde{A}_3 or \tilde{A}_4 Coxeter graph to a disjoint Coxeter subgraph W_{right} which is Lannér, by an edge with no label.

One can label the product \mathcal{G} of two simplex $\Delta_e \times \Delta_f$ with e (resp. f) being the rank of W_{left} (resp. W_{right}) minus one using W as in Section 4. After that, the same computation as the one in Section 7 shows that $\mathcal{C}(\mathcal{G})$ consists of two points if W has one loop, and two disjoint lines if W has two loops.

In the case when W is the left Coxeter diagram with $k=4$ in Table 2(A) or a Coxeter diagram in Tables 2(B) or 2(C), the labeled polytope \mathcal{G} is perfect: It is a consequence of the fact that for every node s of W_{left} , and every node t of W_{right} , the Coxeter group obtained by deleting the nodes s and t of W is spherical. However, in the case when W is the left Coxeter diagram with $k=5$, or the middle or the right Coxeter diagram in Table 2(A), the labeled polytope \mathcal{G} is *not* perfect, but 2-perfect with two Lannér vertices v and w . The truncated polytope $\mathcal{G}^{\dagger\mathcal{V}}$ with $\mathcal{V} = \{v, w\}$ is perfect and $\mathcal{C}(\mathcal{G}^{\dagger\mathcal{V}}) = \mathcal{C}(\mathcal{G})$. In particular, $\mathcal{C}(\mathcal{G}^{\dagger\mathcal{V}})$ is non-empty. Let P be a Coxeter polytope in $\mathcal{C}(\mathcal{G})$ (in the first case) or in $\mathcal{C}(\mathcal{G}^{\dagger\mathcal{V}})$ (in the second case), let $\Gamma := \Gamma_P$, and let $\Omega := \Omega_P$.

The same arguments as for Theorem C show that the group W , which is isomorphic to Γ , is Gromov-hyperbolic relative to the virtually abelian subgroup W_{left} , that Ω contains only tight properly embedded simplex of the expected dimension and that the quotient orbifold Ω/Γ does not decompose into hyperbolic pieces. \square

Proof of Theorem E. See the Coxeter graphs of Table 3. The only difference with Theorem D is that the computation for the existence of the Coxeter polytopes P which give the discrete subgroups $\Gamma := \Gamma_P$ of $\mathrm{SL}_{d+1}^\pm(\mathbb{R})$ acting cocompactly on convex domains $\Omega := \Omega_P$ of \mathbb{S}^d is this time an extension of the computation of Remark 7.5. \square

APPENDIX A. A COXETER POLYTOPE WITH A NON-TRUNCATABLE VERTEX

In this appendix, we will construct 2-perfect Coxeter polytopes of dimension 3 with a *non-truncatable* loxodromic perfect vertex (see also Proposition 4 of Choi [Cho06]).

Let P_λ be a Coxeter 3-polytope of \mathbb{S}^3 defined by (see Figure 12):

$$\begin{aligned} \alpha_1 &= (1, 0, 0, 0) & b_1 &= (2, -1, 0, 0)^T \\ \alpha_2 &= (0, 1, 0, 0) & b_2 &= (-1, 2, -2\lambda, 0)^T \\ \alpha_3 &= (0, 0, 1, 0) & b_3 &= (0, -2\lambda, 2, -1)^T \\ \alpha_4 &= (0, 0, 0, 1) & b_4 &= (0, 0, -1, 2)^T \\ \alpha_5 &= \left(0, 1, \frac{1}{\lambda}, -\frac{2(\lambda^2-1)}{\lambda}\right) & b_5 &= \left(-1, 0, 0, -\frac{\lambda}{\lambda^2-1}\right)^T \end{aligned}$$

where $\lambda > 1$ and row vectors v (resp. column vectors v^T) mean linear forms of \mathbb{R}^4 (resp. vectors of \mathbb{R}^4). Then the Cartan matrix A_λ of P_λ is:

$$A_\lambda = \begin{pmatrix} 2 & -1 & 0 & 0 & -1 \\ -1 & 2 & -2\lambda & 0 & 0 \\ 0 & -2\lambda & 2 & -1 & 0 \\ 0 & 0 & -1 & 2 & -\frac{\lambda}{\lambda^2-1} \\ -1 & 0 & 0 & \frac{3}{\lambda} - 4\lambda & 2 \end{pmatrix}$$

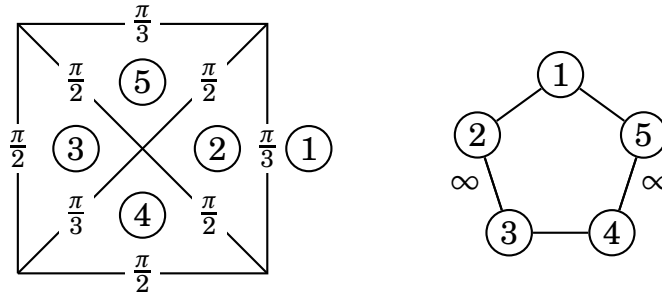

FIGURE 12. A Coxeter 3-pyramid P_λ over a quadrilateral

It is easy to check that P_λ is a 2-perfect Coxeter 3-pyramid over a quadrilateral such that the only non-spherical vertex of P_λ is the apex of P_λ , which is loxodromic and perfect. Moreover, a computation shows that:

$$\det(b_2, b_3, b_4, b_5) = 0 \Leftrightarrow \lambda = \sqrt{\frac{3}{2}} \Leftrightarrow A_\lambda \text{ is symmetric} \Leftrightarrow P_\lambda \text{ is hyperbolic.}$$

It therefore follows that if P_λ is *not* a hyperbolic Coxeter polytope, then the apex of P_λ is a *non-truncatable* loxodromic perfect vertex.

APPENDIX B. USEFUL COXETER DIAGRAMS

B.1. Spherical and affine Coxeter diagrams. The irreducible spherical and irreducible affine Coxeter groups were classified by Coxeter [Cox34]. We reproduce the list of those Coxeter diagrams in Figures 6 and 7. We use the usual convention that an edge that should be labeled by 3 has in fact no label.

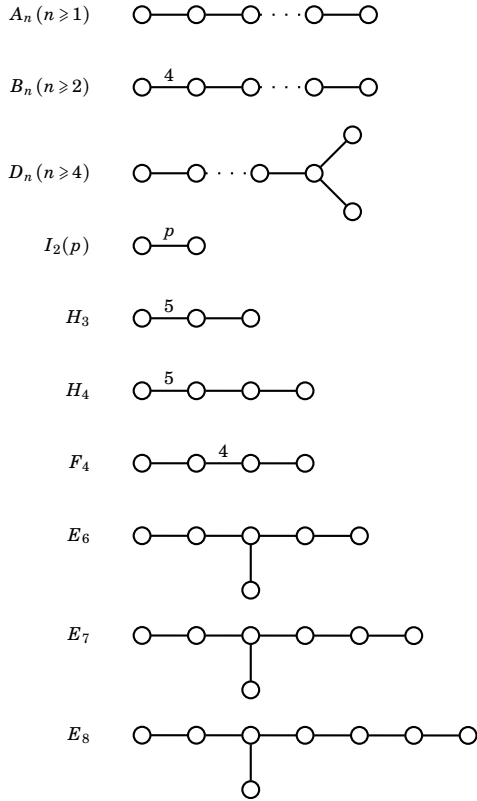

TABLE 6. The irreducible spherical Coxeter diagrams

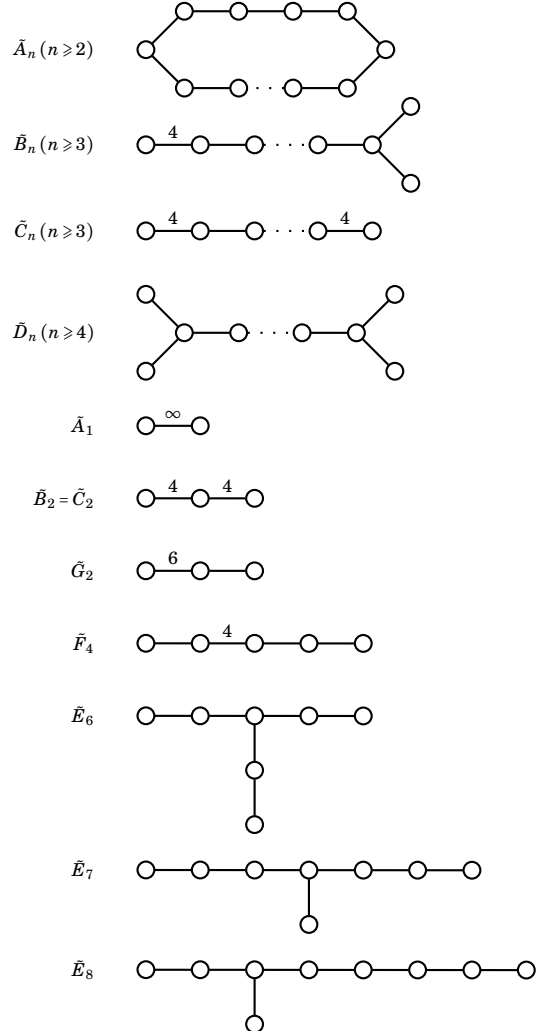

TABLE 7. The irreducible affine Coxeter diagrams

B.2. Lannér Coxeter groups. A Coxeter group associated to a large irreducible perfect simplex is called a Lannér Coxeter group, after Lannér [Lan50] first enumerated them in 1950. These groups are very limited, for example they exist only in dimension 2, 3, 4, and there exist infinitely many in dimension 2, 9 in dimension 3, and 5 in dimension 4.

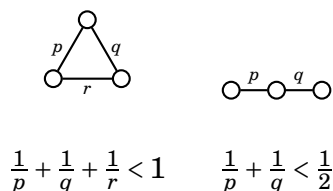

TABLE 8. The Lannér Coxeter groups of the Lannér polygons

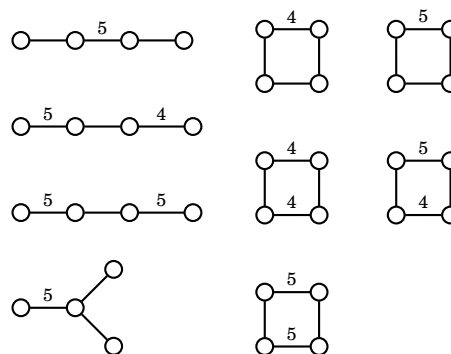

TABLE 9. The Lannér Coxeter groups of the Lannér polyhedra

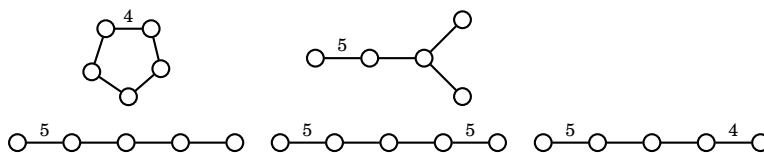

TABLE 10. The Lannér Coxeter groups of the Lannér 4-polytopes

REFERENCES

[ALR07] Alejandro Adem, Johann Leida, and Yongbin Ruan. *Orbifolds and stringy topology*, volume 171 of *Cambridge Tracts in Mathematics*. Cambridge University Press, Cambridge, 2007. **2**

[And70a] Evgeny Andreev. Convex polyhedra in Lobačevskii spaces. *Mat. Sb. (N.S.)*, 81 (123):445–478, 1970. **3**

[And70b] Evgeny Andreev. Convex polyhedra of finite volume in Lobačevskii space. *Mat. Sb. (N.S.)*, 83 (125):256–260, 1970. **3**

[And06] Michael Anderson. Dehn filling and Einstein metrics in higher dimensions. *J. Differential Geom.*, 73(2):219–261, 2006. **2**

[Bam12] Richard Bamler. Construction of Einstein metrics by generalized Dehn filling. *J. Eur. Math. Soc. (JEMS)*, 14(3):887–909, 2012. **2**

[BDL15] Samuel A. Ballas, Jeffrey Danciger, and Gye-Seon Lee. Convex projective structures on non-hyperbolic three-manifolds. *ArXiv1508.04794, to be published in Geometry & Topology*, 2015. **7**

[Ben60] Jean-Paul Benzécri. Sur les variétés localement affines et localement projectives. *Bull. Soc. Math. France*, 88:229–332, 1960. **7**

[Ben00] Yves Benoist. Automorphismes des cônes convexes. *Invent. Math.*, 141(1):149–193, 2000. **16**

[Ben04a] Yves Benoist. Convexes divisibles. I. In *Algebraic groups and arithmetic*, pages 339–374. Tata Inst. Fund. Res., Mumbai, 2004. **7, 23**

[Ben04b] Yves Benoist. Five lectures on lattices in semisimple Lie groups. Summer school in Grenoble, 2004. **13**

- [Ben06a] Yves Benoist. Convexes divisibles. IV. Structure du bord en dimension 3. *Invent. Math.*, 164(2):249–278, 2006. [7](#)
- [Ben06b] Yves Benoist. Convexes hyperboliques et quasiisométries. *Geom. Dedicata*, 122:109–134, 2006. [7](#), [9](#)
- [Ben08] Yves Benoist. A survey on divisible convex sets. In *Geometry, analysis and topology of discrete groups*, volume 6 of *Adv. Lect. Math. (ALM)*, pages 1–18. Int. Press, Somerville, MA, 2008. [7](#)
- [BG04] Nicolas Bergeron and Tsachik Gelander. A note on local rigidity. *Geom. Dedicata*, 107:111–131, 2004. [6](#)
- [Bor63] Armand Borel. Compact Clifford-Klein forms of symmetric spaces. *Topology*, 2:111–122, 1963. [6](#), [7](#)
- [Bou68] Nicolas Bourbaki. *Éléments de mathématique. Fasc. XXXIV. Groupes et algèbres de Lie. Chapitre IV: Groupes de Coxeter et systèmes de Tits. Chapitre V: Groupes engendrés par des réflexions*. Actualités Scientifiques et Industrielles, No. 1337. Hermann, Paris, 1968. [9](#), [13](#)
- [Cap09] Pierre-Emmanuel Caprace. Buildings with isolated subspaces and relatively hyperbolic Coxeter groups. *Innov. Incidence Geom.*, 10:15–31, 2009. [9](#), [33](#)
- [Cap15] Pierre-Emmanuel Caprace. Erratum to “Buildings with isolated subspaces and relatively hyperbolic Coxeter groups”. *Innov. Incidence Geom.*, 14:77–79, 2015. [33](#)
- [Cho06] Suhyoung Choi. The deformation spaces of projective structures on 3-dimensional Coxeter orbifolds. *Geometriae Dedicata*, 119(1):69–90, 2006. [41](#)
- [Cho12] Suhyoung Choi. *Geometric structures on 2-orbifolds: exploration of discrete symmetry*, volume 27 of *MSJ Memoirs*. Mathematical Society of Japan, Tokyo, 2012. [2](#)
- [CLMa] Suhyoung Choi, Gye-Seon Lee, and Ludovic Marquis. Deformation spaces of Coxeter truncation polytopes. *In preparation*. [7](#), [32](#)
- [CLMb] Suhyoung Choi, Gye-Seon Lee, and Ludovic Marquis. Deformations of convex real projective structures on manifolds and orbifolds. In *(to appear) Handbook of group actions, edited by Lizhen Ji, Athanase Papadopoulos and Shing-Tung Yau*. [7](#)
- [CLT15] Daryl Cooper, Darren Long, and Stephan Tillmann. On convex projective manifolds and cusps. *Adv. Math.*, 277:181–251, 2015. [23](#)
- [Cox34] Harold Coxeter. Discrete groups generated by reflections. *Ann. of Math. (2)*, 35(3):588–621, 1934. [42](#)
- [Cox49] Harold Coxeter. *Regular Polytopes*. Methuen & Co., Ltd., London; Pitman Publishing Corporation, New York, 1948; 1949. [15](#)
- [Dav14] Michael W. Davis. When are two Coxeter orbifolds diffeomorphic? *Michigan Math. J.*, 63(2):401–421, 2014. [3](#)
- [dIH93] Pierre de la Harpe. On Hilbert’s metric for simplices. In *Geometric group theory, Vol. 1 (Sussex, 1991)*, volume 181 of *London Math. Soc. Lecture Note Ser.*, pages 97–119. Cambridge Univ. Press, Cambridge, 1993. [16](#), [40](#)
- [DS05] Cornelia Druțu and Mark Sapir. Tree-graded spaces and asymptotic cones of groups. *Topology*, 44(5):959–1058, 2005. With an appendix by Denis Osin and Mark Sapir. [39](#)
- [Fen89] Werner Fenchel. *Elementary geometry in hyperbolic space*, volume 11 of *De Gruyter Studies in Mathematics*. Walter de Gruyter & Co., Berlin, 1989. With an editorial by Heinz Bauer. [25](#)
- [GR70] Howard Garland and Madabusi Raghunathan. Fundamental domains for lattices in \mathbb{R} -rank 1, semisimple Lie groups. *Ann. of Math. (2)*, 92:279–326, 1970. [6](#)
- [HK05] G. Christopher Hruska and Bruce Kleiner. Hadamard spaces with isolated flats. *Geom. Topol.*, 9:1501–1538, 2005. [9](#)
- [JM87] Dennis Johnson and John J. Millson. Deformation spaces associated to compact hyperbolic manifolds. In *Discrete groups in geometry and analysis (New Haven, Conn., 1984)*, volume 67 of *Progr. Math.*, pages 48–106. Birkhäuser Boston, Boston, MA, 1987. [7](#)
- [Kap07] Michael Kapovich. Convex projective structures on Gromov-Thurston manifolds. *Geom. Topol.*, 11:1777–1830, 2007. [7](#)
- [Koe99] Max Koecher. *The Minnesota notes on Jordan algebras and their applications*, volume 1710 of *Lecture Notes in Mathematics*. Springer-Verlag, Berlin, 1999. Edited, annotated and with a preface by Aloys Krieg and Sebastian Walcher. [7](#)
- [Kol12] Alexander Kolpakov. Deformation of finite-volume hyperbolic Coxeter polyhedra, limiting growth rates and Pisot numbers. *European J. Combin.*, 33(8):1709–1724, 2012. [3](#)

- [Kos68] Jean-Louis Koszul. Déformations de connexions localement plates. *Ann. Inst. Fourier (Grenoble)*, 18:103–114, 1968. **7**
- [KS58] Paul Kelly and Ernst Straus. Curvature in Hilbert geometries. *Pacific J. Math.*, 8:119–125, 1958. **9**
- [KV67] Victor Kac and Èrnest Vinberg. Quasi-homogeneous cones. *Mat. Zametki*, 1:347–354, 1967. **6**
- [Lan50] Folke Lannér. On complexes with transitive groups of automorphisms. *Comm. Sém., Math. Univ. Lund [Medd. Lunds Univ. Mat. Sem.]*, 11:71, 1950. **6, 43**
- [Löb31] Frank Löbell. Beispiele geschlossener dreidimensionaler Clifford-Kleinscher Räume negativer Krümmung. *Ber. Verh. Sächs. Akad. Leipzig 83, 167-174*, 1931. **3, 6**
- [Mar10] Ludovic Marquis. Espace des modules de certains polyèdres projectifs miroirs. *Geom. Dedicata*, 147:47–86, 2010. **7**
- [Mar14] Ludovic Marquis. Around groups in Hilbert geometry. In *Handbook of Hilbert geometry*, volume 22 of *IRMA Lect. Math. Theor. Phys.*, pages 207–261. Eur. Math. Soc., Zürich, 2014. **7**
- [Mar17] Ludovic Marquis. Coxeter group in Hilbert geometry. *Groups Geom. Dyn.*, 11(3):819–877, 2017. **5, 16, 19, 23, 32, 39, 40**
- [Mou88] Gabor Moussong. *Hyperbolic Coxeter groups*. ProQuest LLC, Ann Arbor, MI, 1988. Thesis (Ph.D.)—The Ohio State University. **33**
- [MR16] Bruno Martelli and Stefano Riolo. Hyperbolic Dehn filling in dimension four. *ArXiv:1608.08309, to be published in Geometry & Topology*, 2016. **6**
- [MRS13] D. B. McReynolds, Alan W. Reid, and Matthew Stover. Collisions at infinity in hyperbolic manifolds. *Math. Proc. Cambridge Philos. Soc.*, 155(3):459–463, 2013. **39**
- [MV00] Gregory Margulis and Èrnest Vinberg. Some linear groups virtually having a free quotient. *J. Lie Theory*, 10(1):171–180, 2000. **11**
- [Poi82] Henri Poincaré. Théorie des groupes fuchsien. *Acta Math.*, 1(1):1–76, 1882. **6**
- [RHD07] Roland K. W. Roeder, John H. Hubbard, and William D. Dunbar. Andreev’s theorem on hyperbolic polyhedra. *Ann. Inst. Fourier (Grenoble)*, 57(3):825–882, 2007. **25**
- [Thu02] William Thurston. The geometry and topology of three-manifolds. <http://library.msri.org/nonmsri/gt3m>, Electronic version 1.1, March 2002. **1, 2, 17**
- [Tum04] Pavel Tumarkin. Hyperbolic Coxeter n -polytopes with $n+2$ facets. *Mat. Zametki*, 75(6):909–916, 2004. **9, 10, 23**
- [Ver05] Constantin Vernicos. Introduction aux géométries de Hilbert. In *Actes de Séminaire de Théorie Spectrale et Géométrie. Vol. 23. Année 2004–2005*. Univ. Grenoble I, 2005. **16**
- [Vin65] Èrnest Vinberg. Structure of the group of automorphisms of a homogeneous convex cone. *Trudy Moskov. Mat. Obšč.*, 13:56–83, 1965. **7**
- [Vin71] Èrnest Vinberg. Discrete linear groups that are generated by reflections. *Izv. Akad. Nauk SSSR Ser. Mat.*, 35:1072–1112, 1971. **5, 9, 13, 14, 15, 16, 18, 30**
- [Vin85] Èrnest Vinberg. Hyperbolic reflection groups. *Uspekhi Mat. Nauk*, 40(1(241)):29–66, 255, 1985. **4, 5**
- [VS93] Èrnest Vinberg and O. V. Shvartsman. Discrete groups of motions of spaces of constant curvature. In *Geometry, II*, volume 29 of *Encyclopaedia Math. Sci.*, pages 139–248. Springer, Berlin, 1993. **3, 4**
- [Wie13] Michael Wiemeler. Exotic torus manifolds and equivariant smooth structures on quasitoric manifolds. *Math. Z.*, 273(3-4):1063–1084, 2013. **3**
- [Zie95] Günter Ziegler. *Lectures on polytopes*, volume 152 of *Graduate Texts in Mathematics*. Springer-Verlag, New York, 1995. **18, 19, 36**

DEPARTMENT OF MATHEMATICAL SCIENCES, KAIST, REPUBLIC OF KOREA
E-mail address: schoi@math.kaist.ac.kr

MATHEMATISCHES INSTITUT, UNIVERSITÄT HEIDELBERG, GERMANY
E-mail address: lee@mathi.uni-heidelberg.de

UNIV RENNES, CNRS, IRMAR - UMR 6625, F-35000 RENNES, FRANCE
E-mail address: ludovic.marquis@univ-rennes1.fr