



HAL
open science

A Speech Distortion Weighting Based Approach to Integrated Active Noise Control and Noise Reduction in Hearing Aids

Romain Serizel, Marc Moonen, Jan Wouters, Søren Holdt Jensen

► **To cite this version:**

Romain Serizel, Marc Moonen, Jan Wouters, Søren Holdt Jensen. A Speech Distortion Weighting Based Approach to Integrated Active Noise Control and Noise Reduction in Hearing Aids. *Signal Processing*, 2013, 93 (9), pp.2440-2452. hal-01393931

HAL Id: hal-01393931

<https://hal.science/hal-01393931>

Submitted on 8 Nov 2016

HAL is a multi-disciplinary open access archive for the deposit and dissemination of scientific research documents, whether they are published or not. The documents may come from teaching and research institutions in France or abroad, or from public or private research centers.

L'archive ouverte pluridisciplinaire **HAL**, est destinée au dépôt et à la diffusion de documents scientifiques de niveau recherche, publiés ou non, émanant des établissements d'enseignement et de recherche français ou étrangers, des laboratoires publics ou privés.

A Speech Distortion Weighting Based Approach to
Integrated Active Noise Control and Noise Reduction in
Hearing Aids¹

Romain Serizel², Marc Moonen²,
Jan Wouters³ and Søren Holdt Jensen⁴

Accepted for publication in *Signal Processing (EURASIP)*

¹This report is available by anonymous ftp from *ftp.esat.kuleuven.be* in the directory *pub/sista/rserizel/reports/12-155.pdf*

²K.U.Leuven, Dept. of Electrical Engineering (ESAT), Research group SCD (SISTA) Kasteelpark Arenberg 10, 3001 Leuven, Belgium, Tel. +32 16 32 9607, Fax +32 16 321970, E-mail: *romain.serizel@esat.kuleuven.be*. This research work was carried out at the ESAT laboratory of the Katholieke Universiteit Leuven, in the frame of the Marie-Curie Fellowship EST-SIGNAL program (<http://est-signal.i3s.unice.fr>) under contract No. MEST-CT-2005-021175, and the Concerted Research Action GOA-AMBioRICS. The scientific responsibility is assumed by its authors.

³Katholieke Universiteit Leuven, Department of Neurosciences, Exp-ORL, O. & N2, Herestraat 49/721, 3000 Leuven, Belgium, E-mail: *Jan.Wouters@med.kuleuven.be*

⁴Aalborg University, Department of Electronic Systems, MISP, Niels Jernes Vej 12 A6-3, 9220 Aalborg, Denmark, E-mail: *shj@es.aau.dk*

Abstract

This paper presents weighted approaches for integrated active noise control and noise reduction in hearing aids. The unweighted integrated active noise control and noise reduction scheme introduced in previous work does not allow to trade-off between the active noise control and the noise reduction. In some circumstances it will however be useful to emphasize one of the functional blocks.

Changing the original optimisation problem to a constrained optimisation problem leads to a scheme based on a weighted mean squared error criterion that allows to focus either on the active noise control or on the noise reduction. It is similarly possible to derive a scheme that allows to focus either on reducing the speech distortion or on reducing the residual noise at the eardrum. In a single speech source scenario and when the number of sound sources (speech plus noise sources) is less than or equal to the number of microphones, it is possible to derive a simple formula for the output signal-to-noise ratio of the latter scheme. It can then be shown that this scheme delivers a constant signal-to-noise ratio at the eardrum for any weighting factor.

A Speech Distortion Weighting Based Approach to Integrated Active Noise Control and Noise Reduction in Hearing Aids

Romain Serizel^{a,1}, Marc Moonen^a, Jan Wouters^b, Søren Holdt Jensen^c

^a*KULeuven Department of Electrical Engineering, ESAT-SCD, and IBBT Future Health Research Department, Kasteelpark Arenberg 10, B-3001 Leuven, Belgium*

^b*KULeuven, Department of Neurosciences, Research Group ExpORL, O.& N2, Herestraat 49/721, B-3000 Leuven, Belgium*

^c*Department of Electronic Systems, Aalborg University, Niels Jernes Vej 12, DK-9220 Aalborg, Denmark*

1. Introduction

One of the major challenges for hearing impaired persons is understanding speech in a noisy environment [1]. Noise reduction (NR) has therefore been an important research topic for years [2]. Modern hearing aids usually include several microphones and adopt multichannel NR schemes such as the Generalized Sidelobe Canceller (GSC) [3] or techniques based on the Multichannel Wiener Filter (MWF) [4]. However, over the past years, the usage of hearing aids with a so-called open fitting has become more common, mainly owing to

¹Corresponding author. Tel.: +32 16 32 9607; fax: +32 16 321970. E-mail address: romain.serizel@esat.kuleuven.be (R. Serizel).

²Non-standard abbreviations:

- ANC: Active Noise Control
- FxMWF: Filtered-x Multichannel Wiener Filter
- MWF: Multichannel Wiener Filter
- NR: Noise Reduction
- SD: Speech Distortion
- SDW-ANC/NR: Speech Distortion Weighted integrated ANC and NR
- SDW-MWF: Speech Distortion Weighted Multichannel Wiener Filter
- SIW-SNR: Speech Intelligibility Weighted SNR

the availability of more efficient feedback control schemes and fast signal processing units. Whereas removing the earmold reduces the occlusion effect and improves the physical comfort [5], one major drawback is that the leakage of the environmental or background noise through the fitting cannot be neglected anymore.

One efficient way to cancel this undesired noise leakage is to use Active Noise Control (ANC) [6][7]. In the hearing aids framework, ANC then has to be performed together with a NR. A scheme integrating the two functional blocks and based on a filtered-x [8][9][10] version of the Multichannel Wiener Filter (MWF) algorithm (the so-called FxMWF) has been introduced in [11]. The objectives of this algorithm are to attenuate the noise component of the leakage (*i.e.*, ANC) and to minimize the difference between an unknown desired speech signal and the signal delivered at the eardrum (*i.e.*, NR), the trade-off between these two objectives being fixed. In some cases however, it would be useful to emphasize either the ANC or the NR, *e.g.*, when the input signal does not contain any speech or when the ANC is found to be inefficient.

The concept of weighted NR has been introduced in [12] and later applied in the MWF framework to derive the so-called Speech Distortion Weighted Multichannel Wiener Filter (SDW-MWF) [4][13][14]. A similar approach is used in [15] to derive a weighted version of the integrated ANC and NR scheme based on FxMWF. The weighted scheme then allows to emphasize either the ANC or the NR providing an improved signal-to-noise ratio (SNR) or a lower speech distortion (SD) depending of the weight applied.

Focusing on the NR allows to reduce the SD compared to the unweighted integrated ANC and NR but the NR itself still introduces SD. Similarly to SDW-MWF, a speech distortion weighted integrated ANC and NR scheme (SDW-ANC/NR) is derived in this paper that truly allows to trade-off between reducing the SD and reducing the residual noise at the eardrum. In the single speech source scenario and when the number of sound sources (speech plus noise sources) is less than or equal to the number of microphones, it is possible to derive theoretically the output SNR of the frequency-domain implementation

of the SDW-ANC/NR scheme at the eardrum as in [16]. The SDW-ANC/NR scheme is then shown to deliver a constant SNR at the eardrum for any weighting factor.

This paper also presents a performance comparison between the original unweighted integrated ANC and NR scheme and the weighted approaches formulated here, all of them based on FxMWF and applied in hearing aids with an open fitting. The signal model, the MWF-based NR and the unweighted integrated ANC and NR are described in Section 2. Section 3 introduces a first weighted approach to integrated ANC and NR. The SDW-ANC/NR is then presented and its theoretical output SNR is derived in a single speech source scenario in Section 4. The performance of the original unweighted integrated ANC and NR scheme, the first weighted approach to integrated ANC and NR, and the SDW-ANC/NR formulated here, all of them applied in hearing aids with an open fitting, are compared in Section 5. Finally, Section 6 presents a summary of the paper.

2. Background and problem statement

2.1. Signal model

Let M be the number of hearing aid microphones (channels). The frequency-domain signal $X_m(\omega)$ for microphone m has a desired speech part $X_m^s(\omega)$ and an additive noise part $X_m^n(\omega)$, i.e.:

$$X_m(\omega) = X_m^s(\omega) + X_m^n(\omega) \quad m \in \{1 \dots M\} \quad (1)$$

where $\omega = 2\pi f$ is a frequency-domain variable. For conciseness, ω will be omitted in all subsequent equations.

In practice the frequency-domain signal X_m is obtained by taking the discrete-time Fourier transform (DTFT) of the time-domain signal $x_m[k]$, where k is the time index.

In the sequel, superscripts s and n will also be used for other signals and vectors, to denote their speech and noise component, respectively. Signal model (1)

holds for so-called “speech plus noise periods”. There are also “noise only periods” (*i.e.* speech pauses), during which only a noise component is observed.

In practice, in order to distinguish “speech plus noise periods” from “noise only periods” it is necessary to use a voice activity detector (VAD). The performance of the VAD can affect the performance of the ANC and the NR. In this paper however, a perfect VAD is assumed, so as to focus uniquely on the performance improvement owing to the weighted approaches.

The compound vector gathering all microphone signals is:

$$\mathbf{X} = [X_1 \dots X_M]^T \quad (2)$$

A MWF $\mathbf{W} = [W_1 \dots W_M]^T$ will be designed and applied to these signals, which minimises a Mean Squared Error (MSE) criterion:

$$\min \quad J_{\text{MSE}} \quad (3)$$

$$J_{\text{MSE}} = \mathbb{E}\{|E|^2\} \quad (4)$$

where $\mathbb{E}\{\cdot\}$ is the expectation operator and E is an error signal to be defined next, depending on the scheme applied.

The filter output signal Z (*i.e.*, the signal to be fed into the hearing aid loudspeaker) is defined as:

$$Z = \mathbf{W}^H \mathbf{X} \quad (5)$$

where H denotes the Hermitian transpose.

The desired speech signal, as defined in [11], is arbitrarily chosen to be the (unknown) speech component of the first microphone signal ($m = 1$), up to a delay Δ . This can be written as:

$$D_{\text{NR}} = \mathbf{G}_{1,\Delta}^H \mathbf{X}^s \quad (6)$$

$$\mathbf{G}_{1,\Delta} = [Ge^{-j\omega\Delta} | 0 \dots 0] \quad (7)$$

where the gain G is the amplification that compensates for the hearing loss.

The power spectral density (PSD) matrices of the speech component and

the noise component of the microphone signals are respectively given by:

$$\mathbf{R}_{X^s} = \mathbb{E}\{\mathbf{X}^s \mathbf{X}^{sH}\} \quad (8)$$

$$\mathbf{R}_{X^n} = \mathbb{E}\{\mathbf{X}^n \mathbf{X}^{nH}\} \quad (9)$$

In a stationary scenario, and if the speech signal and the noise signal are uncorrelated, \mathbf{R}_{X^n} can be estimated during "noise only periods" and \mathbf{R}_{X^s} can be estimated during "speech plus noise periods" using:

$$\mathbf{R}_X = \mathbb{E}\{\mathbf{X}\mathbf{X}^H\} \quad (10)$$

$$\mathbf{R}_{X^s} = \mathbf{R}_X - \mathbf{R}_{X^n} \quad (11)$$

In practice, the PSD matrices are estimated recursively as explained in [16].

2.2. MWF-based noise reduction, secondary path and signal leakage

Hearing impairments causes a reduction of speech understanding performance. A person affected by a mild to severe hearing loss may need a signal-to-noise ratio (SNR) up to 10dB to understand speech, when normal hearing persons are able to understand speech with a SNR down to -5 dB [17, 18]. Therefore, there is obviously a need for NR algorithms in hearing aids [19, 20].

Modern hearing aids usually include several microphones and adopt multichannel NR schemes such as MWF-based-NR [4]. The MWF-based NR is designed to minimise the squared distance between the filtered microphone signal Z and the desired speech signal D_{NR} . Therefore, the MSE criterion to be minimised is:

$$J_{\text{MSE}} = \mathbb{E}\{|E_{\text{NR}}|^2\} \quad (12)$$

$$E_{\text{NR}} = Z - D_{\text{NR}} \quad (13)$$

$$= \mathbf{W}^H \mathbf{X} - \mathbf{G}_{1,\Delta}^H \mathbf{X}^s$$

If speech and noise are uncorrelated, the corresponding Wiener filter is:

$$\boxed{\mathbf{W}_{\text{NR}} = \mathbf{R}_X^{-1} \mathbf{R}_{X^s} \mathbf{G}_{1,\Delta}} \quad (14)$$

The filter (14) is designed without taking the effects of the secondary path and the signal leakage into account. Figure 1 presents a behind-the-ear (BTE) hearing aid with an open fitting, *i.e.*, where the secondary path and the signal leakage are taken into account. It is assumed that a microphone is present in the ear canal to provide an estimate of the signal reaching the eardrum. Commercial hearing aids currently do not have an ear canal microphone, therefore the artificial ear canal microphone is used to generate the error signal in our experimental setup. As will also be mentioned in Section 2.3, the filter coefficients are computed in the frequency-domain, while the filtering operation itself is performed in the time-domain.

This secondary path then usually acts as an attenuation. Assuming that the loudspeaker characteristic is approximately linear, the secondary path can be represented by a filter coefficient vector $\mathbf{c}[k]$ of length P . The frequency-domain representation of $\mathbf{c}[k]$ is then denoted by C (Figure 2). The frequency-domain representation of the leakage signal $l[k]$ is denoted by L . In literature this leakage signal is also referred to as vent-through or direct sound [1][21].

It has been shown in [16] that taking both the leakage signal and the secondary path effect into account, leads to the following output signal model :

$$\tilde{Z} = C \cdot Z + L \quad (15)$$

For small amplification gains G the leakage signal SNR may affect the output SNR thus partly cancelling the improvement achieved with the NR.

2.3. Integrated active noise control and noise reduction

This section reviews the frequency-domain description of the integrated ANC and NR scheme introduced in [11][16] to compensate for the signal leakage while still delivering the desired speech signal at the user's eardrum.

The performance of feedforward ANC schemes is highly dependent on the causality of the system [6][22]. In this paper, to ensure causality (Figure 3), the filter coefficients are computed in the frequency-domain while the filtering operation itself is performed in the time-domain (Figure 4), in a similar way as

presented in [23]. The time-domain delayless ANC filter is obtained by taking the $2N$ -IDFT of the frequency-domain vector coefficient. The resulting time-domain filter contains an N -dimensional causal part and a N -dimensional anticausal part. The time-domain filter effectively applied to the microphone signals is truncated to the N -dimensional causal part.

Note that, due to the inverse DFT and the truncation, the effect of causality on the frequency-domain version of the ANC schemes is unclear and difficult to analyse. Therefore, in this article the hearing aid processing delay Δ_{HA} (*i.e.*, Analog-to-Digital converter delay, Digital-to-Analog converter delay...) is neglected such that the ANC schemes to be designed are causal and the effect of the truncation is limited. All the subsequent theoretical expressions of the output SNR are then valid only when the system is causal. A study of the impact of causality on the performance of the integrated ANC and NR scheme can be found in [11].

In practice neglecting the processing delay Δ_{HA} corresponds to a system with a causality margin arounds 3 taps (at 16 kHz), depending on the localisation of the sources. This means that for a delay $\Delta_{\text{HA}} \leq 3$ the system is causal.

The desired signal to be used here is chosen similarly as in [16]:

$$D_{\text{Int}} = D_{\text{NR}} + L^s \quad (16)$$

and the MSE criterion to be minimized is:

$$J_{\text{MSE}} = \mathbb{E}\{|E_{\text{Int}}|^2\} \quad (17)$$

$$\begin{aligned} E_{\text{Int}} &= \tilde{Z} - D_{\text{Int}} \\ &= C \cdot \mathbf{W}^H \mathbf{X} + \underbrace{L^n}_{L-L^s} - \mathbf{G}_{1,\Delta}^H \mathbf{X}^s \end{aligned} \quad (18)$$

The optimal filter (FxMWF) minimizing (17) is:

$$\mathbf{W}_{\text{Int}} = \frac{C}{|C|^2} \mathbf{R}_X^{-1} (\mathbf{R}_{X^s} \mathbf{G}_{1,\Delta} - \mathbf{r}_{X^n L^n}) \quad (19)$$

where $\mathbf{r}_{X^n L^n}$ is the cross-PSD vector between the noise component of the microphone signal and the noise component of the leakage signal defined as:

$$\mathbf{r}_{X^n L^n} = \mathbb{E}\{\mathbf{X}^n L^n\} \quad (20)$$

The secondary path can be estimated (estimate \hat{C}) off-line using classic identification methods based for example on Least Mean Squares (LMS) algorithms, or on-line by adding random noise to the signal exciting the secondary path, as introduced by Eriksson et al. in [24] and later refined by Kuo et al. [25] and Zhang et al. [26].

Note that this filter \mathbf{W}_{Int} can be separated into two filters, as in [11]:

$$\mathbf{U} = \frac{C}{|C|^2} \mathbf{R}_X^{-1} \mathbf{R}_{X^s} \mathbf{G}_{1,\Delta} \quad (21)$$

$$\mathbf{V} = -\frac{C}{|C|^2} \mathbf{R}_X^{-1} \mathbf{r}_{X^n L^n} \quad (22)$$

The first filter \mathbf{U} is an MWF-based NR filter that also compensates for the effects of the secondary path. Expression (21) is indeed very similar to (14). If the secondary path is estimated on-line, the compensation is then adaptive and robust to changes of scenarios (hearing aid slightly moving, ear becoming partly obstructed. . .).

The second filter \mathbf{V} is an ANC filter that aims to cancel the noise component of the leakage signal.

2.4. Fixed trade-off between active noise control and noise reduction

The integrated scheme minimizes an MSE criterion (17) which can be viewed as the sum of an ANC (23) term and a SD term (24). Therefore, the integrated ANC and NR scheme may exhibit lower noise attenuation performance than an ANC filter alone, minimizing the MSE criterion (23). On the other hand, the integrated ANC and NR scheme may be found to introduce more SD than a standard NR scheme minimizing the MSE criterion (25).

$$\mathbb{E}\{|E_{\text{ANC}}|^2\} = \mathbb{E}\{|C * \mathbf{W}^H \mathbf{X}^n + L^n|^2\} \quad (23)$$

$$\mathbb{E}\{|E_{\text{SD}}|^2\} = \mathbb{E}\{|C * \mathbf{W}^H \mathbf{X}^s - D_{\text{NR}}|^2\} \quad (24)$$

$$\mathbb{E}\{|E_{\text{NR}}|^2\} = \mathbb{E}\{|C * \mathbf{W}^H \mathbf{X} - D_{\text{NR}}|^2\} \quad (25)$$

When the input signal does not contain any speech, the NR is not needed and the ANC alone can perform better than the integrated ANC and NR scheme and deliver lower residual noise at the ear canal microphone.

On the other hand, *e.g.*, if the background noise is high-frequency noise when typically the ANC is found to be inefficient, using a NR alone may reduce the SD introduced by the integrated ANC and NR scheme (see also Section 5).

3. Weighted integrated active noise control and noise reduction

The integrated ANC and NR scheme introduced in [11] and reviewed in the previous section imposes a fixed trade-off between the NR and the ANC. It is possible, however, to modify the optimisation problem in order to derive a filter with a variable ANC/NR trade-off. A time-domain version of the scheme described below has been previously introduced in [15]. The frequency-domain implementation allows to derive theoretically the output SNR and to express it in a simple form.

3.1. Constrained problem formulation

The algorithm described in this section applies a different weight to the ANC objective (23) and to the NR objective (25) of the integrated ANC and NR scheme.

The overall objective can be seen as minimizing the residual noise at the ear canal microphone (*i.e.*, ANC) under the constraint that the difference between the desired signal and the filtered signal, as delivered to the ear canal microphone (*i.e.*, NR), is kept below a given threshold:

$$\min_{\mathbf{w}} \mathbb{E}\{|E_{\text{ANC}}|^2\}, \text{ subject to } \mathbb{E}\{|E_{\text{NR}}|^2\} \leq T \quad (26)$$

Introducing the Lagrange-multiplier $\mu > 0$, the MSE criterion to be minimized is then :

$$J_{\text{MSE}} = \mathbb{E}\{|E_{\text{ANC}}|^2\} + \mu \mathbb{E}\{|E_{\text{NR}} - T|^2\} \quad (27)$$

The Lagrange-multiplier $\mu \in]0, \infty[$ then acts as a trade-off parameter between the ANC and the NR. Intuitively, for a small μ the system performs more

ANC than NR and when μ increases, the amount of ANC performed reduces while the NR becomes more important.

- When $\mu \rightarrow 0$, the MSE in (27) reduces to (23). The system behaves like a standard ANC algorithm. The algorithm then achieves high noise attenuation performance but it also introduces extensive SD, as the speech component is not taken into account in the optimization process.
- When $\mu \rightarrow \infty$, the MSE in (27) reduces to (25). The system then behaves as a MWF-based NR algorithm. The algorithm introduces less SD but the noise attenuation performance is decreased. The signal leakage is not compensated for anymore.

The optimal filter (FxMWF) minimizing the MSE criterion (27) is then:

$$\mathbf{W}_\mu = \frac{C}{|C|^2} \mathbf{R}_\mu^{-1} \mathbf{r}_\mu \quad (28)$$

Here \mathbf{R}_μ is the weighted PSD matrix of the microphone signal \mathbf{X} and \mathbf{r}_μ is the weighted cross-PSD vector between the microphone signal \mathbf{X} and the desired signal D_{Int} :

$$\mathbf{R}_\mu = \mu \mathbf{R}_{X^s} + (1 + \mu) \mathbf{R}_{X^n} \quad (29)$$

$$\mathbf{r}_\mu = \mu \mathbf{R}_{X^s} \mathbf{G}_{1,\Delta} - \mathbf{r}_{X^n L^n} \quad (30)$$

Note that the weighted PSD matrix can be estimated using:

$$\mathbf{R}_\mu = \mu \mathbf{R}_X + \mathbf{R}_{X^n} \quad (31)$$

By substituting (30) and (31) in (28):

$$\boxed{\mathbf{W}_\mu = \frac{C}{|C|^2} (\mu \mathbf{R}_X + \mathbf{R}_{X^n})^{-1} (\mu \mathbf{R}_{X^s} \mathbf{G}_{1,\Delta} - \mathbf{r}_{X^n L^n})} \quad (32)$$

From (32) it appears that the two extreme cases for the filter \mathbf{w}_μ are given by:

$$\lim_{\mu \rightarrow 0} \mathbf{W}_\mu = -\frac{C}{|C|^2} \mathbf{R}_{X^n}^{-1} \mathbf{r}_{X^n L^n} \quad (33)$$

$$\lim_{\mu \rightarrow \infty} \mathbf{W}_\mu = \frac{C}{|C|^2} \mathbf{R}_X^{-1} \mathbf{R}_{X^s} \mathbf{G}_{1,\Delta} \quad (34)$$

Here (33) is the expression of an ANC scheme which minimizes the noise at the ear canal microphone and (34) is the expression of a FxMWF-based NR scheme that compensates for the secondary path. The filter described in (32) therefore integrates the two functional blocks with the coefficient μ used as a trade-off parameter between the ANC and the NR.

3.2. Single speech source case

In the single speech source case it is possible to derive simpler formulae for the above filters. The PSD matrix \mathbf{R}_{X^s} is then rank-1 and can be rewritten as:

$$\mathbf{R}_{X^s} = P^s \mathbf{A} \mathbf{A}^H \quad (35)$$

where P^s is the power of the speech signal and \mathbf{A} is the steering vector, which contains the acoustic transfer functions from the speech source position to the hearing aid microphones (including room acoustics, microphone characteristics, and head shadow effect).

The leakage signal can be approximated (estimated) by a linear combination of the input signals:

$$L = \tilde{\mathbf{P}}^H \mathbf{X} + e_L \quad (36)$$

where e_L is the estimation error and $\tilde{\mathbf{P}}$ is the estimated leakage path from the input microphones to the ear canal microphone.

The weighted MSE criterion (27) can then be rewritten as follows:

$$\begin{aligned} J_{\mu, \text{MSE}} = & \mathbb{E}\{|C\mathbf{W}^H \mathbf{X}^n + \tilde{\mathbf{P}}^H \mathbf{X}^n + e_L^n|^2\} \\ & + \mu \mathbb{E}\{|C\mathbf{W}^H \mathbf{X} - \mathbf{G}_{1,\Delta}^H \mathbf{X}^s|^2\} \end{aligned} \quad (37)$$

The estimation error e_L is orthogonal to the microphone signals and to the microphone signals filtered by $\tilde{\mathbf{P}}$ and by \mathbf{W} [27]:

$$\mathbb{E}\{\mathbf{X} e_L^*\} = 0 \quad (38)$$

$$\mathbb{E}\{\tilde{\mathbf{P}}^H \mathbf{X} e_L^*\} = 0 \quad (39)$$

$$\mathbb{E}\{\mathbf{W}^H \mathbf{X} e_L^*\} = 0 \quad (40)$$

The weighted integrated ANC and NR filter (32) can then be rewritten as follows:

$$\begin{aligned} \mathbf{W}_\mu &= \frac{C}{|C|^2} [\mathbf{R}_{X^s} + \nu \mathbf{R}_{X^n}]^{-1} \mathbf{R}_{X^s} \mathbf{G}_{1,\Delta} \\ &\quad - \nu \eta \frac{C}{|C|^2} [\mathbf{R}_{X^s} + \nu \mathbf{R}_{X^n}]^{-1} \mathbf{R}_{X^n} \tilde{\mathbf{P}} \end{aligned} \quad (41)$$

with

$$\nu = \frac{\mu + 1}{\mu} \quad \nu \in]1, \infty[\quad (42)$$

$$\eta = \frac{1}{\mu + 1} \quad \eta \in]0, 1[\quad (43)$$

The matrix pencil $(\mathbf{R}_{X^s} + \nu \mathbf{R}_{X^n})$ can then be inverted by applying the Woodbury identity and the filter (32) can be expressed as follows:

$$\boxed{\mathbf{W}_\mu = \frac{C}{|C|^2} \left[\frac{\mathbf{R}_{X^n}^{-1} \mathbf{R}_{X^s}}{\nu + \rho} (\mathbf{G}_{1,\Delta} + \eta \tilde{\mathbf{P}}) - \eta \tilde{\mathbf{P}} \right]} \quad (44)$$

with

$$\rho = P^s \mathbf{A}^H \mathbf{R}_{X^n}^{-1} \mathbf{A} \quad (45)$$

The expression is very similar to the expression for the so-called MWF- η in [28]. The weighted integrated ANC and NR scheme can then be seen as an SDW-MWF with partial production of anti-noise. When $\eta \rightarrow 0$ no anti-noise is produced and the weighted integrated ANC and NR scheme behaves as a FxMWF-based NR. Increasing η will introduce the anti-noise and when $\eta \rightarrow 1$ the weighted integrated ANC and NR scheme tends to produce only anti-noise, *i.e.*, the filter acts as an ANC scheme.

4. Speech distortion weighted integrated active noise control and noise reduction

The MSE criterion minimised by the weighted integrated ANC and NR scheme introduced in Section 3 does not relate directly to the MSE criterion minimised by the unweighted integrated ANC and NR introduced in Section 2. Therefore, the weighted integrated ANC and NR scheme does not reduce to the

original unweighted integrated ANC and NR scheme for any weighting factor. Besides, focusing on the NR allows to reduce the SD compared to unweighted integrated ANC and NR, but the NR itself still introduces SD [14]. In this section a speech distortion weighted integrated ANC and NR (SDW-ANC/NR) scheme is derived that allows for a trade-off between reducing the SD and reducing the residual noise at the ear canal microphone, *i.e.*, ANC.

4.1. Constrained problem formulation

Similarly to SDW-MWF in [4][13][14], it is possible to derive an integrated ANC and NR scheme that applies a different weight to the ANC objective and to the SD objective. The overall objective can be seen as minimising the residual noise at the ear canal microphone (*i.e.*, ANC) under the constraint that the difference between the desired speech signal and the speech component of the filtered signal, as delivered to the ear canal microphone (*i.e.*, SD), is kept below a given threshold:

$$\min_{\mathbf{w}} \mathbb{E}\{|E_{\text{ANC}}|^2\}, \text{ subject to } \mathbb{E}\{|E_{\text{SD}}|^2\} \leq T \quad (46)$$

where E_{ANC} and E_{SD} are defined in (23) and (24).

Introducing the Lagrange-multiplier $\mu > 0$, the MSE criterion to be minimised is then :

$$J_{\mu, \text{MSE}} = \mathbb{E}\{|E_{\text{ANC}}|^2\} + \mu \mathbb{E}\{|E_{\text{SD}} - T|^2\} \quad (47)$$

The Lagrange-multiplier $\mu \in]0, \infty[$ acts as a trades-off parameter between the ANC and the SD:

- When $\mu \rightarrow 0$, the MSE criterion in (47) reduces to (23). The system then behaves as a standard ANC algorithm. The algorithm then achieves a high noise attenuation performance but it may also introduce significant SD.
- When $\mu \rightarrow \infty$, the MSE criterion in (47) reduces to (24). The system then minimizes the SD but the noise attenuation performance is decreased. The signal leakage is not compensated for any more.

The optimal filter, minimising the MSE criterion in (47), is then:

$$\mathbf{W}_{\text{SDW}} = \frac{C}{|C|^2} \mathbf{R}_{\text{SDW}}^{-1} \mathbf{r}_{\text{SDW}} \quad (48)$$

Here \mathbf{R}_{SDW} is the speech distortion weighted PSD matrix of the microphone signal \mathbf{X} and \mathbf{r}_{SDW} is the weighted cross-PSD vector between the microphone signal \mathbf{X} and the desired signal D_{Int} :

$$\mathbf{R}_{\text{SDW}} = \mu \mathbf{R}_{X^s} + \mathbf{R}_{X^n} \quad (49)$$

$$\mathbf{r}_{\text{SDW}} = \mu \mathbf{R}_{X^s} \mathbf{G}_{1,\Delta} - \mathbf{r}_{X^n L^n} \quad (50)$$

The optimal filter can then be rewritten as follows:

$$\boxed{\mathbf{W}_{\text{SDW}} = \frac{C}{|C|^2} (\mu \mathbf{R}_{X^s} + \mathbf{R}_{X^n})^{-1} (\mu \mathbf{R}_{X^s} \mathbf{G}_{1,\Delta} - \mathbf{r}_{X^n L^n})} \quad (51)$$

This will be referred to as speech distortion weighted integrated ANC and NR (SDW-ANC/NR). Note that for $\mu = 1$ the filter (51) then reduces to the unweighted integrated ANC and NR (19).

From (51) it appears clearly that the two extreme cases for the filter \mathbf{W}_{SDW} are given by:

$$\lim_{\mu \rightarrow 0} \mathbf{W}_{\text{SDW}} = -\frac{C}{|C|^2} \mathbf{R}_{X^n}^{-1} \mathbf{r}_{X^n L^n} \quad (52)$$

$$\lim_{\mu \rightarrow \infty} \mathbf{W}_{\text{SDW}} = \frac{C}{|C|^2} \mathbf{G}_{1,\Delta} \quad (53)$$

Here (52) is the expression of an ANC filter, which minimises the residual noise at the ear canal microphone, and (53) is the expression of a filter that minimizes the SD at the ear canal microphone. The filter described in (51) therefore integrates the two functional blocks with the coefficient μ used as a trade-off parameter between the ANC and the SD.

4.2. Single speech source case

In the single speech source case it is possible to derive simpler formulae for the above filters and for their SNR performance.

The leakage signal can be approximated (estimated) by a linear combination of the input signals (36). The weighted MSE criterion (47) can then be rewritten as follows:

$$J_{\mu, \text{MSE}} = \mathbb{E}\{|C\mathbf{W}^H \mathbf{X}^n + \tilde{\mathbf{P}}^H \mathbf{X}^n + e_L^n|^2\} + \mu \mathbb{E}\{|C\mathbf{W}^H \mathbf{X}^s - \mathbf{G}_{1,\Delta}^H \mathbf{X}^s|^2\} \quad (54)$$

The estimation error e_L is orthogonal to the microphone signals (38) and to the microphone signals filtered by $\tilde{\mathbf{P}}$ (39) and by \mathbf{W} (40).

The SDW-ANC/NR filter (51) can then be rewritten as follows:

$$\mathbf{W}_{\text{SDW}} = \mu \frac{C}{|C|^2} [\mu \mathbf{R}_{X^s} + \mathbf{R}_{X^n}]^{-1} \mathbf{R}_{X^s} \mathbf{G}_{1,\Delta} - \frac{C}{|C|^2} [\mu \mathbf{R}_{X^s} + \mathbf{R}_{X^n}]^{-1} \mathbf{R}_{X^n} \tilde{\mathbf{P}} \quad (55)$$

The matrix pencil $(\mu \mathbf{R}_{X^s} + \mathbf{R}_{X^n})$ can then be inverted by applying the Woodbury identity and the filter (51) can be expressed as follows:

$$\mathbf{W}_{\text{SDW}} = \frac{C}{|C|^2} \left[\frac{\mathbf{R}_{X^n}^{-1} \mathbf{R}_{X^s}}{\frac{1}{\mu} + \rho} (\mathbf{G}_{1,\Delta} + \tilde{\mathbf{P}}) - \tilde{\mathbf{P}} \right] \quad (56)$$

The expression is very similar to the single speech source expression for the integrated ANC and NR in [16] with a scaling factor in the numerator.

4.3. Output signal-to-noise ratio when the number of sources is less than or equal to the number of microphones

When the number of sources (speech plus noise sources) is less than or equal to the number of microphones ($Q \leq M$) the leakage signal can be rewritten as a linear combination of the microphone signals.

$$L = \mathbf{P}^H \mathbf{X} \quad (57)$$

The filter (56) then becomes:

$$\mathbf{W}_{\text{SDW}} = \frac{C}{|C|^2} \left[\frac{\mathbf{R}_{X^n}^{-1} \mathbf{R}_{X^s}}{\frac{1}{\mu} + \rho} (\mathbf{G}_{1,\Delta} + \mathbf{P}) - \mathbf{P} \right] \quad (58)$$

The output SNR of a filter \mathbf{W} is defined as follows:

$$\text{SNR}_{\mathbf{W}}(\omega) = \frac{\mathbf{W}^H \mathbf{R}_{X^s} \mathbf{W}}{\mathbf{W}^H \mathbf{R}_{X^n} \mathbf{W}} \quad (59)$$

The output SNR of the SDW-ANC/NR scheme at the ear canal microphone can then be expressed as follows:

$$\boxed{\text{SNR}_{\text{SDW},(Q \leq M)} = \frac{\rho^2 (P_{D_{\text{NR}}} + \alpha + P_{L^s})}{\rho (P_{D_{\text{NR}}} + \alpha + P_{L^s})} = \rho} \quad (60)$$

where $P_{D_{\text{NR}}}$ is the power of the desired speech signal, P_{L^s} is the power of the speech component of the leakage signal, and α is defined as follows:

$$\alpha = \mathbf{G}_{1,\Delta}^H \mathbf{R}_{X^s} \mathbf{P} + \mathbf{P}^H \mathbf{R}_{X^s} \mathbf{G}_{1,\Delta} \quad (61)$$

It is shown in [29][30], that in a single speech source scenario the weighting factor μ of an SDW-MWF scheme merely acts as a scaling factor on the obtained filter and that the frequency-domain output SNR is therefore independent of this weighting factor μ . In the case of the SDW-ANC/NR the weighting factor μ does not merely act as a scaling factor, see (51) and (56). In the single speech source scenario and when the number of sources (speech source plus noise sources) is less than or equal to the number of microphone, however, the weighting factor μ is found to act as a scaling factor on the power of the speech signal at the ear canal microphone and the power of the noise signal at the ear canal microphone. Therefore, the SNR at the ear canal microphone is again independent of the weighting factor μ (60).

The weighting factor μ , however, has an effect on the SD and the residual noise power at the ear canal microphone which can be expressed as follows:

$$\text{SD}_{\text{SDW},(Q \leq M)} = \frac{1}{(1 + \rho\mu)^2} (P_{D_{\text{NR}}} + \alpha + P_{L^s}) \quad (62)$$

$$P_{\text{SDW},(Q \leq M)}^n = \frac{\mu^2 \rho}{(1 + \rho\mu)^2} (P_{D_{\text{NR}}} + \alpha + P_{L^s}) \quad (63)$$

It appears from the previous equations that when $\mu \rightarrow 0$ the SDW-ANC/NR scheme behaves as an ANC scheme and the residual noise power at the ear canal

microphone tends to 0. When $\mu \rightarrow \infty$, the SDW-ANC/NR scheme minimizes the SD and so the SD at the ear canal microphone tends to 0.

5. Experimental results

The weighted integrated ANC and NR scheme and the SDW-ANC/NR scheme introduced in this paper have been tested experimentally and their performances have been compared with the performance of the unweighted integrated ANC and NR scheme described in [11][16].

The weighted integrated ANC and NR scheme is first considered and then the SDW-ANC/NR scheme is analysed. For both of the weighted schemes, the influence of the weighting factor μ on the power of the residual noise at the ear canal microphone and on the SD of the desired signal is first examined. The impact of μ on the output SNR at the ear canal microphone is then considered. Note that the weighting factor is chosen to be constant for all frequencies.

5.1. Experimental setup

The simulations were run on acoustic path measurements obtained with a CORTEX MK2 manikin head and torso equipped with artificial ears and a two-microphone BTE hearing aid. The sound sources (FOSTEX 6301B loudspeakers) were positioned at 1 meter from the center of the head. The speech source was located at 0° and the noise source at 270° . The BTE was worn on the left ear, facing the noise source.

The tests were run on 22 seconds long signals. The speech was composed of three sentences from the HINT database [31] concatenated with silence periods. The noise was either the multitalker babble from Auditec [32] (Figure 5) or the car noise from the NOISEX-92 database [33] (Figure 6). All the signals were sampled at 16kHz.

The filter lengths were set to $N = 128$, and the NR delay was set to half of the NR filter length ($\Delta = 64$). The secondary path $\mathbf{c}[k]$ was estimated off-line using an identification technique based on the NLMS algorithm. The length of the estimated path $\hat{\mathbf{c}}[k]$ was set to $\hat{P} = 32$.

The position of the sources and the SNR for the source signals resulted in a so-called leakage SNR (which corresponds to the SNR when the hearing aid is turned off) equal to $-1.3dB$. The system was calibrated so that for $G = 0dB$, for a source at 0° , the leakage and the signal fed in the loudspeaker have equal power at the ear canal microphone.

5.2. Performance measures

In order to compare the weighted integrated ANC and NR schemes with the unweighted integrated ANC and NR scheme, the following performance measures are defined.

The *normalised noise power* (in dB) is defined as

$$\overline{POW} = 10 \log_{10} \frac{POW_{\text{weight}}}{POW_{\text{unweight}}} \quad (64)$$

where POW_{weight} and POW_{unweight} are the broadband power of the noise signal at the ear canal microphone obtained with one of the weighted integrated ANC and NR schemes and with the unweighted integrated ANC and NR scheme, respectively.

An intelligibility weighted SD measure is used defined as

$$SD_{\text{intellig}} = \sum_i I_i SD_i \quad (65)$$

where I_i is the band importance function defined in [34] and SD_i the average SD (in dB) in the i -th one third octave band,

$$SD_i = \frac{1}{(2^{1/6} - 2^{-1/6})f_i^c} \int_{2^{-1/6}f_i^c}^{2^{1/6}f_i^c} |10 \log_{10} G^s(f)| df \quad (66)$$

with center frequencies f_i^c and $G^s(f)$ the squared magnitude of the transfer function for the speech component from the input of the weighted ANC and NR to the ear canal microphone.

The *normalised SD* (in dB) is then defined as

$$\overline{SD} = SD_{\text{intellig,weight}} - SD_{\text{intellig,unweight}} \quad (67)$$

where $SD_{\text{intellig,weight}}$ and $SD_{\text{intellig,unweight}}$ represent the output SD (in dB) at the ear canal microphone for one of the weighted integrated ANC and NR schemes and for the unweighted integrated ANC and NR scheme, respectively.

The speech intelligibility-weighted SNR (SIW-SNR) [35] is used here to compute the *SIW-SNR improvement* which is defined as

$$\Delta SNR_{\text{intellig}} = \sum_i I_i(SNR_{i,\text{weight}} - SNR_{i,\text{unweight}}) \quad (68)$$

where $SNR_{i,\text{weight}}$ and $SNR_{i,\text{unweight}}$ represent the output SNR at the ear canal microphone of one of the weighted integrated ANC and NR schemes and of the unweighted integrated ANC and NR scheme of the i th band, respectively.

The *output SIW-SNR* is similarly defined as:

$$SNR_{\text{intellig}} = \sum_i I_i(SNR_{i,\text{out}} - SNR_{i,\text{leak}}) \quad (69)$$

where $SNR_{i,\text{out}}$ and $SNR_{i,\text{leak}}$ represent the output SNR at the ear canal microphone of one of the integrated ANC and NR schemes and of the leakage signal of the i th band, respectively.

5.3. Weighted integrated active noise control and noise reduction

In this subsection, the performance of the weighted integrated ANC and NR scheme introduced in Section 3 is analysed and compared to the performance of the unweighted integrated ANC and NR scheme presented in [11].

5.3.1. Noise power and speech distortion performance

In order to analyse the impact of the weighting factor μ on the NR criterion and on the ANC criterion, the SD at the ear canal microphone and the residual noise power at the ear canal microphone are computed when the weighted integrated ANC and NR scheme is applied on babble noise signal and on car noise signal.

Figures 7 and 8 present the noise power attenuation and the SD attenuation, for the weighted integrated ANC and NR scheme applied on babble noise signal compared against the unweighted integrated ANC and NR scheme, as a function of μ and for different values of the gain G .

When $\mu \rightarrow 0$, the weighted integrated ANC and NR scheme is attenuating the noise at the ear canal microphone more efficiently than the unweighted integrated ANC and NR scheme (Figure 7), *i.e.*, it behaves as an ANC algorithm.

When μ increases, the noise power attenuation vanishes (Figure 7) while the SD decreases (Figure 8). When $\mu \rightarrow \infty$, the weighted integrated ANC and NR scheme behaves as a standard NR and some attenuation can be done in terms of the SD compared against the unweighted integrated ANC and NR scheme. The unweighted integrated ANC and NR scheme already introduce 6dB to 8dB SD depending on the gain G . It is usually assumed that introducing up to 10dB SD is still acceptable [36]. Therefore, for low gain (up to $G = 10\text{dB}$) there is no particular restriction on the value to choose for μ . Whereas for higher values of the gain G it is safer to choose a value of $\mu > 0.5$ in order to avoid introducing too much SD.

Figures 9 and 10 present the noise power attenuation and the SD attenuation, for the weighted integrated ANC and NR scheme applied on car noise signal compared against the unweighted integrated ANC and NR scheme, as a function of μ and for different values of the gain G .

The weighted integrated ANC and NR scheme behaves similarly as on babble noise signal except that in this case, the switch between the ANC behaviour and the NR behaviour happens for lower values of the weighting parameter μ . When applied on car noise, the unweighted integrated ANC and NR scheme introduce about 4dB SD. This means that it is not recommended to set μ at a value that would lead the weighted integrated ANC and NR scheme to introduce more than 6dB \overline{SD} , *i.e.*, to introduce more than 10dB SD. This would lead to choose $\mu < 0.01$ (Figure 10).

5.3.2. Signal-to-noise ratio performance

For all values of the gain G , the unweighted integrated ANC and NR scheme provides a SIW-SNR improvement of about 10dB. Figure 11 presents the SIW-SNR improvement of the weighted integrated ANC and NR scheme applied on babble noise signal compared against the SIW-SNR performance of the un-

weighted integrated ANC and NR scheme as a function of μ and for different values of the gain G .

For small μ (up to around 0.5), the weighted integrated ANC and NR scheme provides an SIW-SNR improvement that can be 4dB higher than the SIW-SNR improvement obtained with the unweighted integrated ANC and NR scheme. When μ increases, the weighted scheme behaves more like a standard NR scheme, and the unweighted integrated ANC and NR scheme exhibits a better SIW-SNR performance for gains G up to 20dB. When μ is set so that the weighted integrated ANC and NR scheme does not introduce more than 10dB (see above), the weighted integrated ANC and NR can still improve the SIW-SNR improvement by 4dB for low gain ($G \leq 10$ dB) and by 2 to 3dB for higher gains.

Figure 12 presents the SIW-SNR improvement of the weighted integrated ANC and NR scheme applied on car noise signal compared against the SIW-SNR performance of the unweighted integrated ANC and NR scheme as a function of μ and for different values of the gain G . For small μ (up to around 0.05), the weighted integrated ANC and NR scheme provides an SIW-SNR improvement that can be 7dB higher than the SIW-SNR improvement obtained with the unweighted integrated ANC and NR scheme depending on the gain G . When μ increases, the weighted integrated ANC and NR scheme exhibits similar SIW-SNR performance as the unweighted integrated ANC and NR scheme. When μ is set so that the weighted integrated ANC and NR scheme does not introduce more than 10dB ($\mu \geq 0.01$), the weighted integrated ANC and NR can still improve the SIW-SNR by 2dB compared to the unweighted integrated ANC and NR scheme.

5.4. *Speech distortion weighted integrated active noise control and noise reduction*

In this subsection, the performance of the SDW-ANC/NR scheme introduced in Section 4 is analysed and compared to the performance of the unweighted integrated ANC and NR scheme.

5.4.1. Noise power and speech distortion performance

Figures 13 and 14 present the noise power attenuation and the SD attenuation, for the SDW-ANC/NR scheme compared against the unweighted integrated ANC and NR scheme as a function of μ and for different values of the gain G .

When $\mu \rightarrow 0$, the SDW-ANC/NR scheme is attenuating the noise at the ear canal microphone more efficiently than the unweighted integrated ANC and NR scheme (Figure 13), *i.e.*, it behaves as an ANC algorithm. This also means that the algorithm introduces up to 50dB of SD (Figure 14).

When μ increases, the noise power attenuation vanishes (Figure 13) while the SD decreases (Figure 17). When $\mu \rightarrow \infty$, the SDW-ANC/NR scheme minimizes the SD at the ear canal microphone. The unweighted integrated ANC and NR scheme already introduce 6dB to 8dB SD depending on the gain G . Therefore, for high values of the gain ($G \geq 15$ dB) it is safer to choose a value of $\mu > 0.1$ in order to avoid the overall SD to exceed 10dB. For lower values of the gain on the other hand, there is no particular restriction on the value to choose for μ .

Figures 15 and 16 present the noise power attenuation and the SD attenuation, for the SDW-ANC/NR scheme applied on car noise signal compared against the unweighted integrated ANC and NR scheme, as a function of μ and for different values of the gain G . The SDW-ANC/NR behaves similarly as the weighted integrated ANC and NR scheme on car noise signal. This would mean that it is then again not recommended to choose $\mu < 0.01$ (Figure 16).

5.4.2. Signal-to-noise ratio performance

Figure 17 and 18 presents the SIW-SNR improvement (68) of the SDW-ANC/NR scheme applied on babble noise signal and on car noise signal, respectively, compared against the SIW-SNR performance of the unweighted integrated ANC and NR scheme as a function of μ and for different values of the gain G .

For all values of the weighting factor, the SDW-ANC/NR scheme delivers a SIW-SNR improvement that is almost constant and equal to the SIW-SNR

improvement obtained with the unweighted integrated ANC and NR scheme. In terms of the SIW-SNR at the ear canal microphone, the SDW-ANC/NR scheme therefore maintains the performance of the unweighted integrated ANC and NR scheme (*i.e.*, the performance of a MWF-based NR when signal leakage and the secondary path are not taken into account) while allowing to focus on reducing the SD or on minimizing the residual noise at the ear canal microphone.

Note that the assertion made in Section 4 that for $\mu = 1$ the filter (51) then reduces to the unweighted integrated ANC and NR (19) is verified here. On figures 13-18, $\mu = 1$ corresponds to the point where the curves are crossing 0, *i.e.*, the SDW-ANC/NR delivers the same performance as the unweighted ANC and NR.

6. Conclusion

A FxMWF-based integrated ANC and NR scheme has been introduced in previous work to tackle the secondary path effects and the effects of signal leakage in the framework of hearing aids with an open fitting. The objectives of the integrated ANC and NR scheme are to attenuate the noise component of the leakage signal and to minimise the difference between the desired speech signal and the signal delivered at the ear canal microphone, the trade-off between these two objectives being fixed.

The concept of weighted NR applied in the MWF framework to derive the SDW-MWF has been extended here to derive weighted versions of the integrated ANC and NR scheme.

The first weighted integrated ANC and NR scheme introduced in this paper allows to emphasise either the ANC or the NR. When the signal does not contain any speech, the weighted integrated ANC and NR scheme allows to focus on ANC and minimises the power of the residual noise signal at the ear canal microphone. On the other hand, if the ANC is found to be inefficient for the considered background noise scenario the emphasis can be put on the NR. The weighted integrated ANC and NR scheme then exhibits improved SD performance compared to the unweighted integrated ANC and NR scheme.

This weighted ANC and NR scheme, however, does not reduce to the original unweighted integrated ANC and NR scheme for any weighting factor. Besides, focusing on the NR allows to reduce the SD compared to unweighted integrated ANC and NR, but the NR itself is still introducing SD. A SDW-ANC/NR scheme has then been derived, which allows to trade-off between reducing the SD at the ear canal microphone and minimising the residual noise at the ear canal microphone (*i.e.*, ANC). In the single speech source scenario and when the number of sound sources (speech plus noise sources) is less than or equal to the number of microphones, a formula for the output SNR of the SDW-ANC/NR scheme at the ear canal microphone has been derived. The SDW-ANC/NR scheme has then been shown to deliver a constant SNR at the ear canal microphone for any weighting factor.

Acknowledgements

This research work was carried out at the ESAT Laboratory of KULeuven, in the frame of KULeuven Research Council CoE EF/05/006 Optimization in Engineering (OPTEC), PFV/10/002 (OPTEC), Concerted Research Action GOA-MaNet, the Belgian Programme on Interuniversity Attraction Poles initiated by the Belgian Federal Science Policy Office IUAP P6/04 (DYSCO, ‘Dynamical systems, control and optimization’, 2012-2017), Research Project IBBT, Research Project FWO nr. G.0763.12 (‘Wireless Acoustic Sensor Networks for Extended Auditory Communication’) and EC-FP6 project SIGNAL: ‘Core Signal Processing Training Program’. The scientific responsibility is assumed by its authors.

References

- [1] H. Dillon, *Hearing Aids*. Thieme, 2001.
- [2] V. Hamacher, J. Chalupper, J. Eggers, E. Fischer, U. Kornagel, H. Puder, and U. Rass, “Signal processing in high-end hearing aids: state of the

- art, challenges, and future trends,” *EURASIP Journal on Applied Signal Processing*, vol. 2005, pp. 2915–2929, 2005.
- [3] L. J. Griffiths and C. W. Jim, “An alternative approach to linearly constrained adaptive beamforming,” *IEEE Transactions on Antennas and Propagation*, vol. 30, pp. 27–34, 1982.
- [4] S. Doclo, A. Spriet, J. Wouters, and M. Moonen, “Frequency-domain criterion for the speech distortion weighted multichannel wiener filter for robust noise reduction,” *Elsevier Speech Communication*, vol. 49, no. 7-8, pp. 636–656, 2007.
- [5] J. Kiessling, “Sounds towards the tympanic membrane,” in *8th EFAS Congress*. Heidelberg: European Federation of Audiological Societies, June 2007.
- [6] S. J. Elliott and P. A. Nelson, *active control of sound*. Cambridge: Academic press, 1993.
- [7] S. M. Kuo and D. R. Morgan, “Active noise control: a tutorial review,” *Proceedings of the IEEE*, vol. 87, Issue: 6, no. 0018-9219, pp. 943–973, Jun 1999.
- [8] E. Bjarnason, “Analysis of the filtered-x lms algorithm,” *IEEE Transactions on Speech and Audio Processing*, vol. 3, no. 6, pp. 504–514, 1995.
- [9] J. C. Burgess, “Active adaptive sound control in a duct: a computer simulation,” *The Journal of the Acoustical Society of America*, vol. 70, Issue 3, pp. 715–726 715–726, September 1981.
- [10] B. Widrow and S. D. Stearns, *Adaptive signal processing*. Englewood Cliffs,N J: Prentice-Hall, 1985.
- [11] R. Serizel, M. Moonen, J. Wouters, and S. H. Jensen, “Integrated active noise control and noise reduction in hearing aids,” *IEEE Transactions on Speech Audio and Language*, vol. 18, no. 6, pp. 1137–1146, August 2010.

- [12] Y. Ephraim and H. L. Van Trees, “A signal subspace approach for speech enhancement,” *IEEE Transactions on Speech and Audio Processing*, vol. 3, no. 4, pp. 251–266, 1995.
- [13] S. Doclo and M. Moonen, “GSVD-based optimal filtering for single and multimicrophone speech enhancement,” *IEEE Transactions on Signal Processing* [see also *IEEE Transactions on Acoustics, Speech, and Signal Processing*], vol. 50, no. 9, pp. 2230–2244, 2002.
- [14] K. Ngo, A. Spriet, M. Moonen, J. Wouters, and S. H. Jensen, “Incorporating the conditional speech presence probability in multi-channel wiener filter based noise reduction in hearing aids,” *EURASIP Journal on Advances in Signal Processing, Special Issue on Digital Signal Processing for Hearing Instruments*, vol. 2009, 2009.
- [15] R. Serizel, M. Moonen, J. Wouters, and S. H. Jensen, “A weighted approach integrated active noise control and noise reduction in hearing aids,” in *The 17th European Signal Processing Conference (EUSIPCO-2009)*, August 2009.
- [16] —, “Output snr analysis of integrated active noise control and noise reduction in hearing aids under a single speech source,” *EURASIP Signal Processing*, vol. 91, no. 8, pp. 1719–1729, August 2011.
- [17] A. J. Duquesnoy and R. Plomp, “The effect of a hearing aid on the speech-reception threshold of hearing-impaired listeners in quiet and in noise,” *The Journal of the Acoustical Society of America*, vol. 73, p. 2166, 1983.
- [18] R. Plomp, “Auditory handicap of hearing impairment and the limited benefit of hearing aids,” *The Journal of the Acoustical Society of America*, vol. 63, p. 533, 1978.
- [19] J. R. Deller, J. G. Proakis, and J. H. L. Hansen, *Discrete-time processing of speech signals*. Wiley-Interscience, 2000.

- [20] P. C. Loizou, *Speech Enhancement: Theory and Practice*. Boca Raton, FL: CRC Press, 2007.
- [21] J. M. Kates, *Digital hearing aids*. Cambridge Univ Press, 2008.
- [22] X. Kong and S. M. Kuo, "Study of causality constraint on feedforward active noise controlsystems," *IEEE Transactions on Circuits and Systems II: Analog and Digital Signal Processing*, vol. 46, no. 2, pp. 183–186, 1999.
- [23] D. R. Morgan and J. C. Thi, "A delayless subband adaptive filter architecture," *IEEE Transactions on Signal Processing*, vol. 43, no. 8, pp. 1819–1830, 1995.
- [24] L. J. Eriksson and M. C. Allie, "Use of random noise for on-line transducer modeling in an adaptive active attenuation system," *The Journal of the Acoustical Society of America*, vol. 85, no. 2, pp. 797–802, February 1989.
- [25] S. M. Kuo and D. Vijayan, "A secondary path modeling technique for active noise controlsystems," *IEEE Transactions on Speech and Audio Processing*, vol. 5, no. 4, pp. 374–377, 1997.
- [26] M. Zhang, H. Lan, and W. Ser, "Cross-updated active noise control system with online secondarypath modeling," *IEEE Transactions on Speech and Audio Processing*, vol. 9, no. 5, pp. 598–602, 2001.
- [27] S. Haykin, *Adaptive Filter Theory (4th Edition)*. Prentice Hall, September 2001.
- [28] B. Cornelis, S. Doclo, T. Van den Bogaert, M. Moonen, and J. Wouters, "Theoretical analysis of binaural multi-microphone noise reduction techniques," *IEEE Transactions on audio, speech and language processing*, vol. 18, no. 2, pp. 342–355, February 2010.
- [29] A. Spriet, S. Doclo, M. Moonen, and J. Wouters, "A unification of adaptive multi-microphone noise reduction systems," in *10th International Workshop on Acoustic Echo and Noise Control (IWAENC'06)*, 2006, pp. 1–4.

- [30] A. Spriet, M. Moonen, and J. Wouters, “Spatially pre-processed speech distortion weighted multi-channel wiener filtering for noise reduction,” *EURASIP Signal Processing*, vol. 84, no. 12, pp. 2367–2387, 2004.
- [31] M. Nilsson, S. D. Soli, and A. Sullivan, “Development of the Hearing in Noise Test for the measurement of speech reception thresholds in quiet and in noise,” *The Journal of the Acoustical Society of America*, vol. 95, no. 2, pp. 1085–1099, Feb. 1994.
- [32] Auditec, “Auditory Tests (Revised), Compact Disc, Auditec, St. Louis,” St. Louis, 1997.
- [33] A. Varga and H. J. Steeneken, “Assessment for automatic speech recognition: Ii. noisex-92: A database and an experiment to study the effect of additive noise on speech recognition systems,” *Speech Communication*, vol. 12, no. 3, pp. 247 – 251, 1993.
- [34] A.-S. (1997), “ANSI S3.5-1997 American National Standard Methods for calculation of the speech intelligibility index,” *Acoustical Society of America*, June 1997.
- [35] J. E. Greenberg, P. M. Peterson, and P. M. Zurek, “Intelligibility-weighted measures of speech-to-interference ratio and speech system performance,” *The Journal of the Acoustical Society of America*, vol. 94, no. 5, pp. 3009–3010, Nov. 1993.
- [36] S. Wang, A. Sekey, and A. Gersho, “An objective measure for predicting subjective quality of speech coders,” *Selected Areas in Communications, IEEE Journal on*, vol. 10, no. 5, pp. 819–829, 1992.

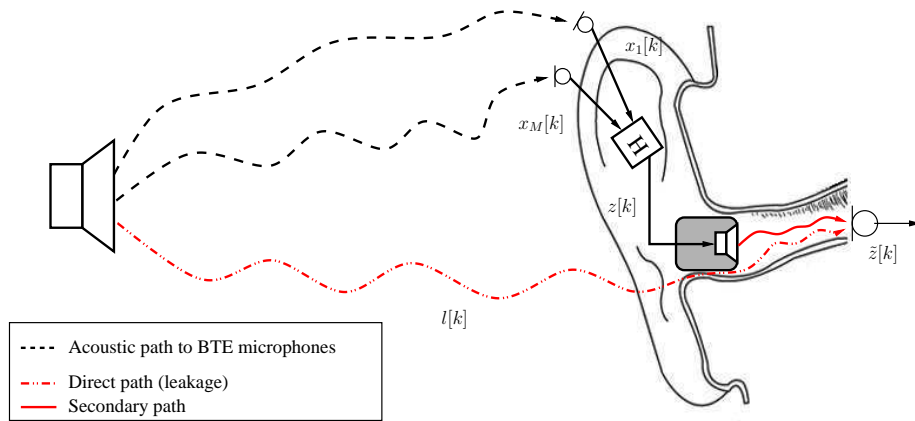

Figure 1: Hearing aid with an open fitting

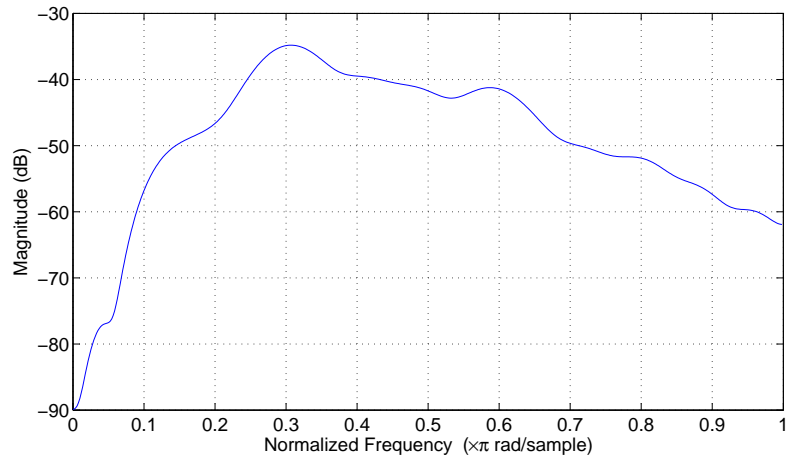

Figure 2: Frequency response of the secondary path filter $c[k]$ at 16kHz

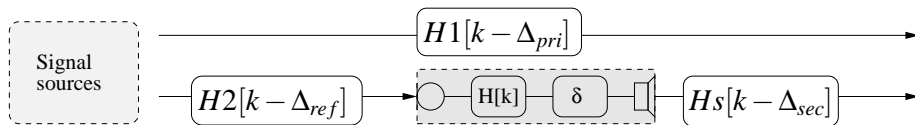

Figure 3: Delays in hearing aid system environment

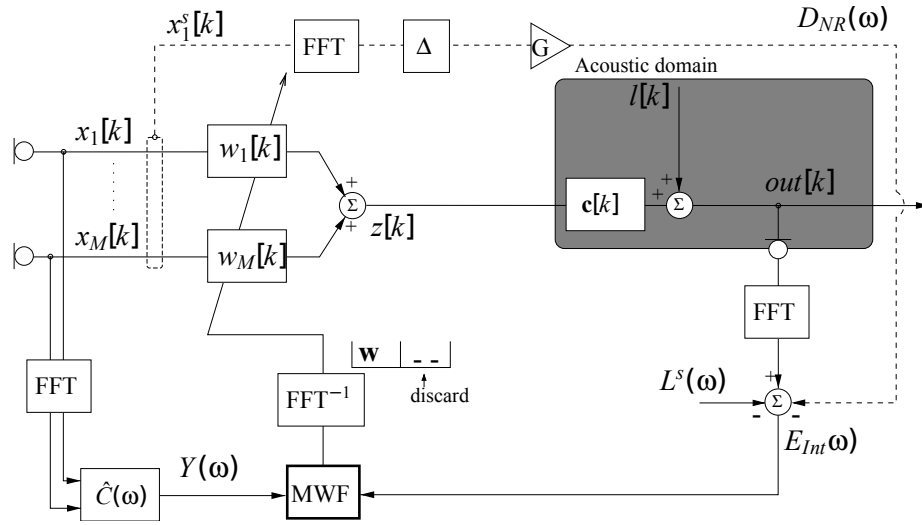

Figure 4: Integrated ANC and NR in the hearing aids context

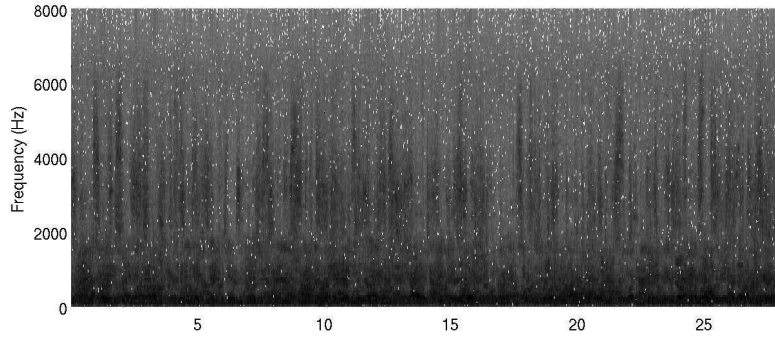

Figure 5: Spectrogram of the babble noise signal

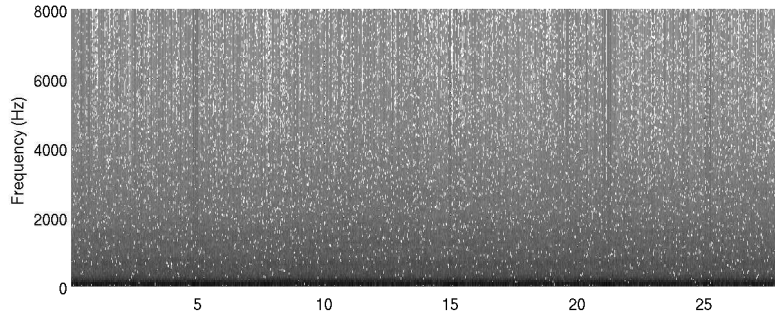

Figure 6: Spectrogram of the car noise signal

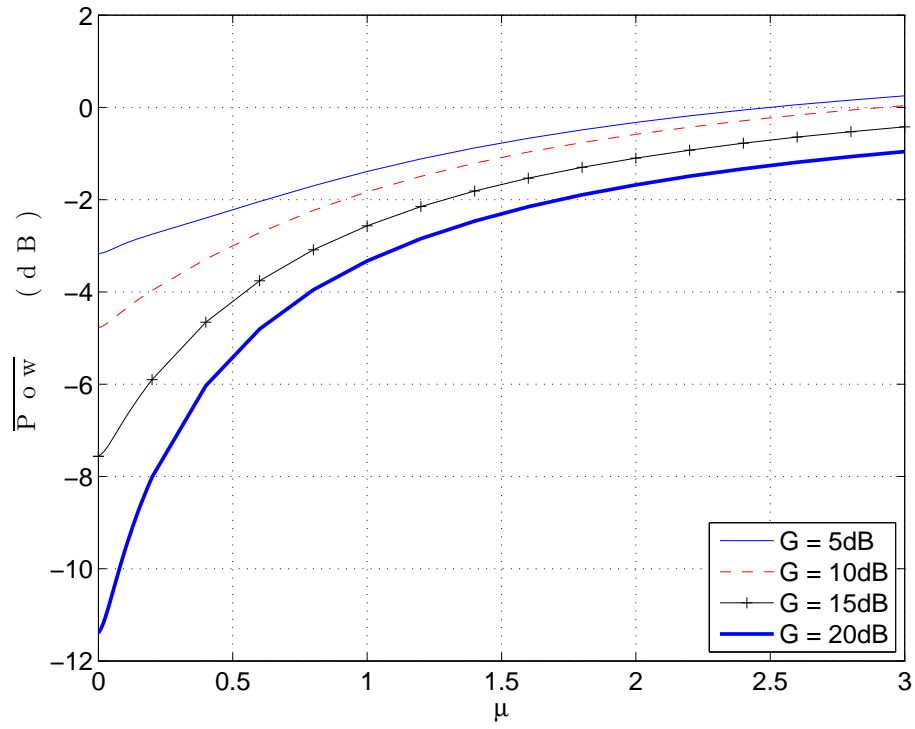

Figure 7: Normalised output noise power of the weighted integrated ANC and NR scheme (babble noise)

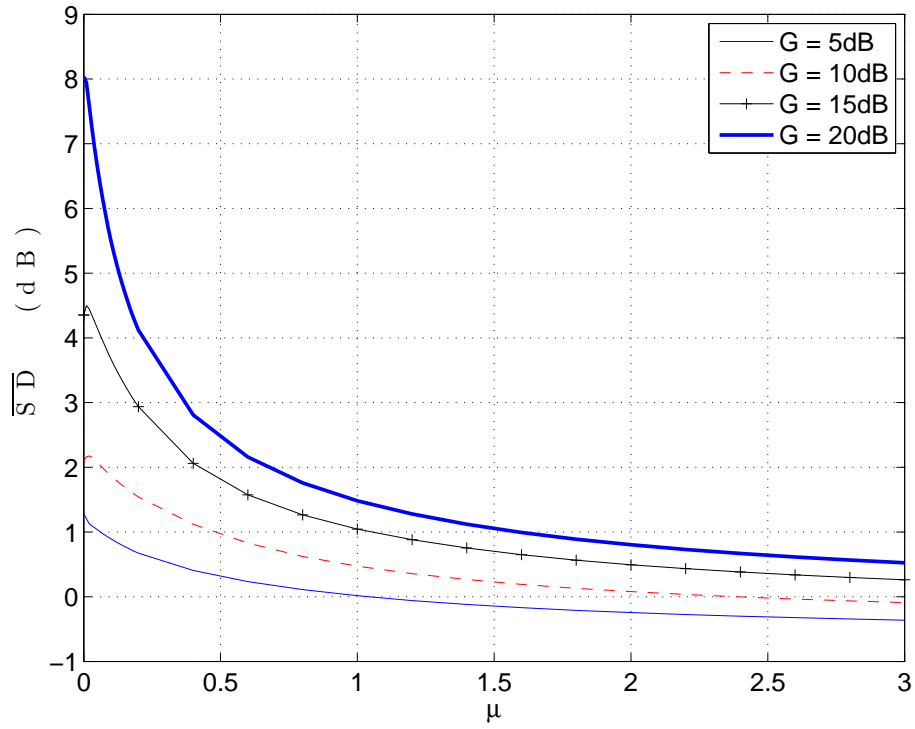

Figure 8: Normalised speech distortion introduced by the weighted integrated ANC and NR scheme (babble noise)

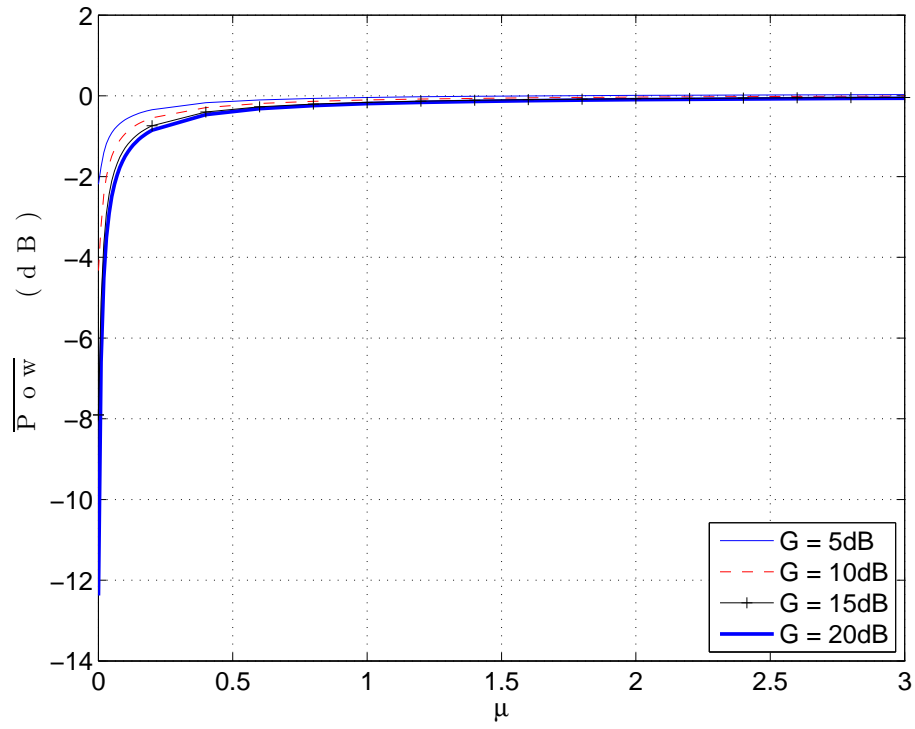

Figure 9: Normalised output noise power of the weighted integrated ANC and NR scheme (car noise)

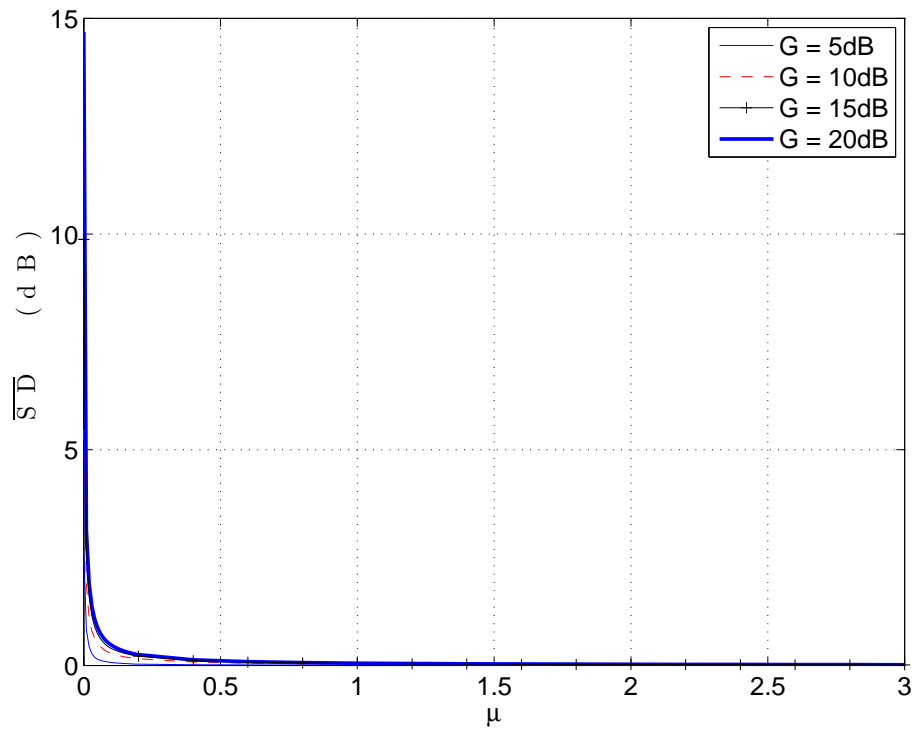

Figure 10: Normalised speech distortion introduced by the weighted integrated ANC and NR scheme (car noise)

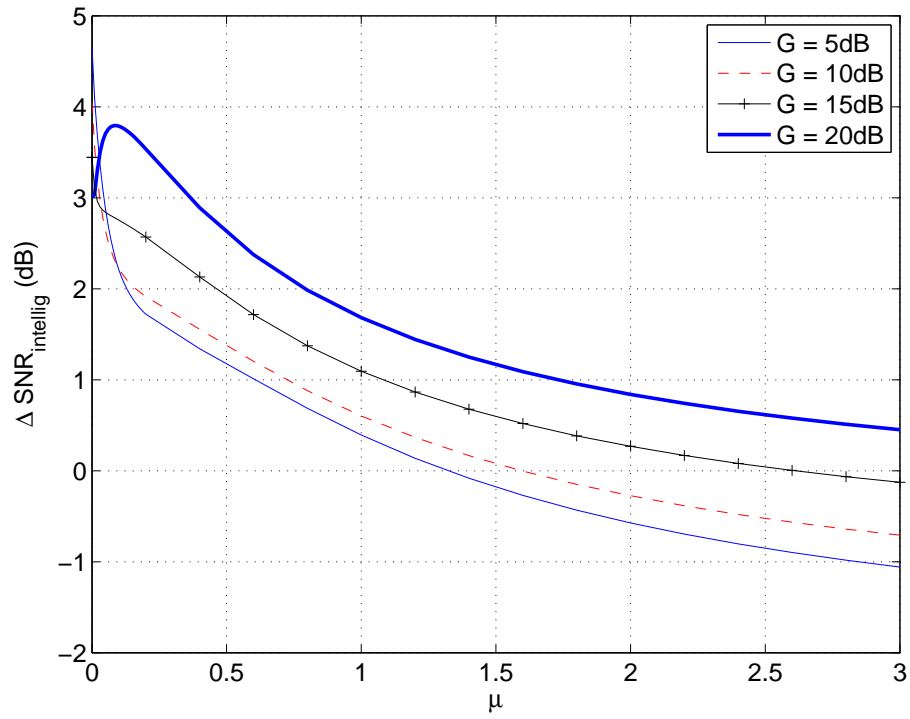

Figure 11: SIW-SNR improvement of the weighted integrated ANC and NR scheme compared to the unweighted integrated active noise control and noise reduction scheme (babble noise)

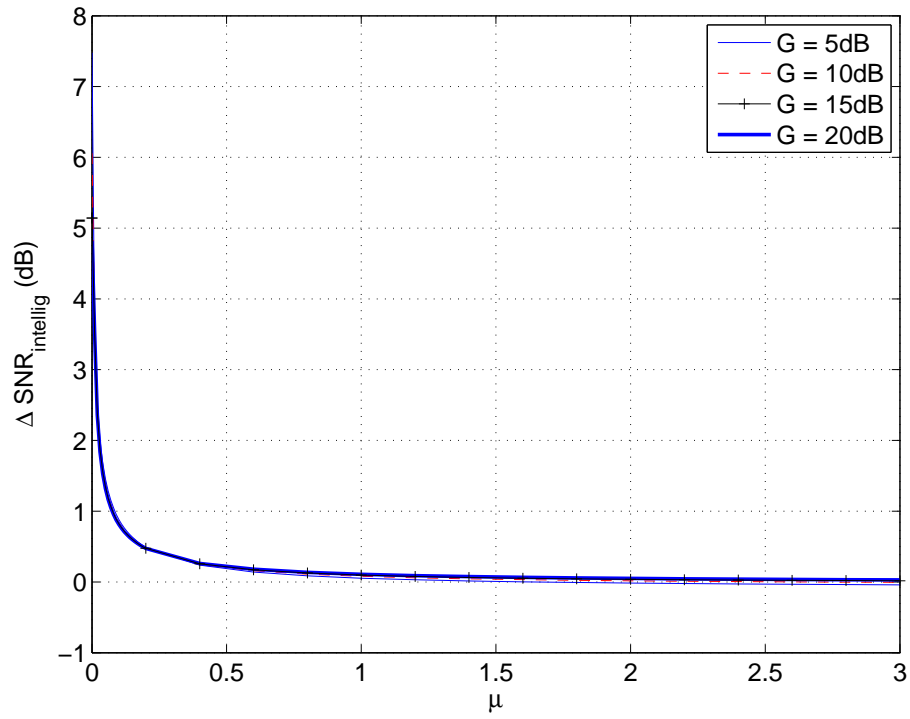

Figure 12: SIW-SNR improvement of the weighted integrated ANC and NR scheme compared to the unweighted integrated active noise control and noise reduction scheme (car noise)

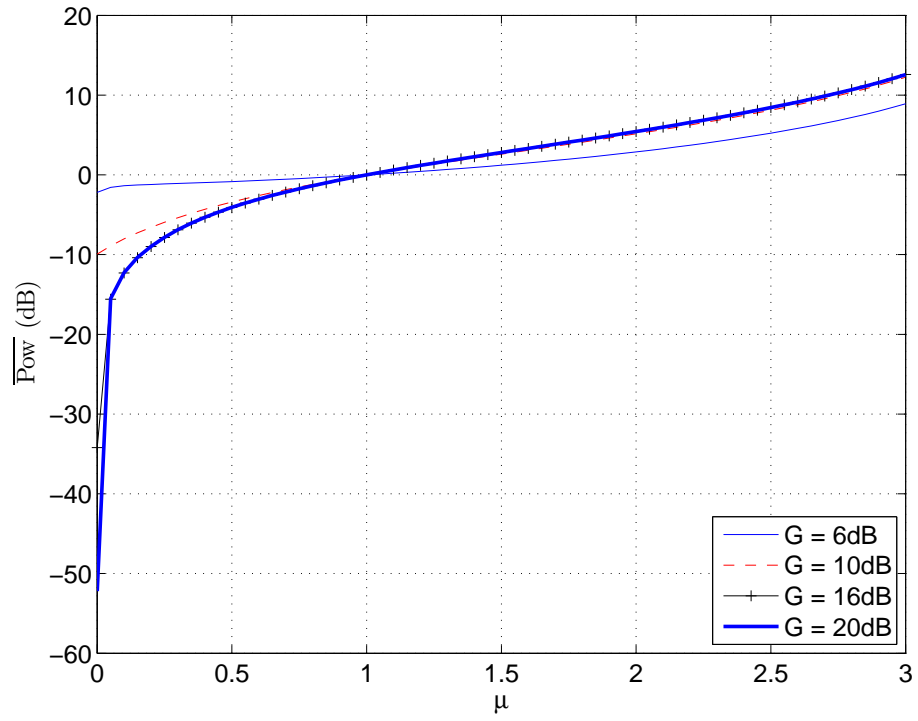

Figure 13: Normalised output noise power attenuation of the SDW-ANC/NR scheme (babble noise)

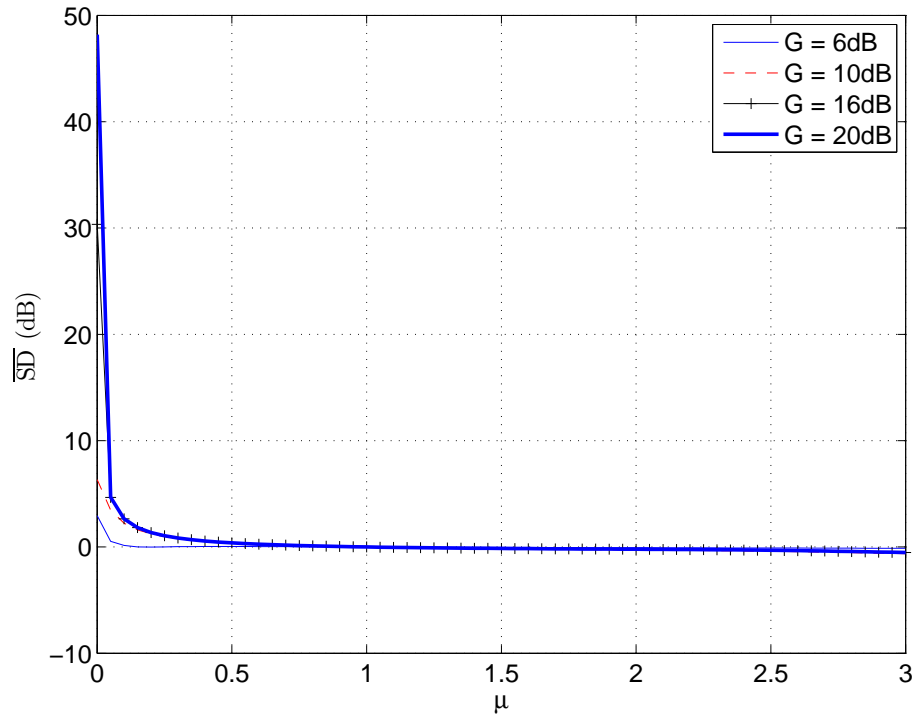

Figure 14: Normalised speech distortion introduced by the SDW-ANC/NR scheme (babble noise)

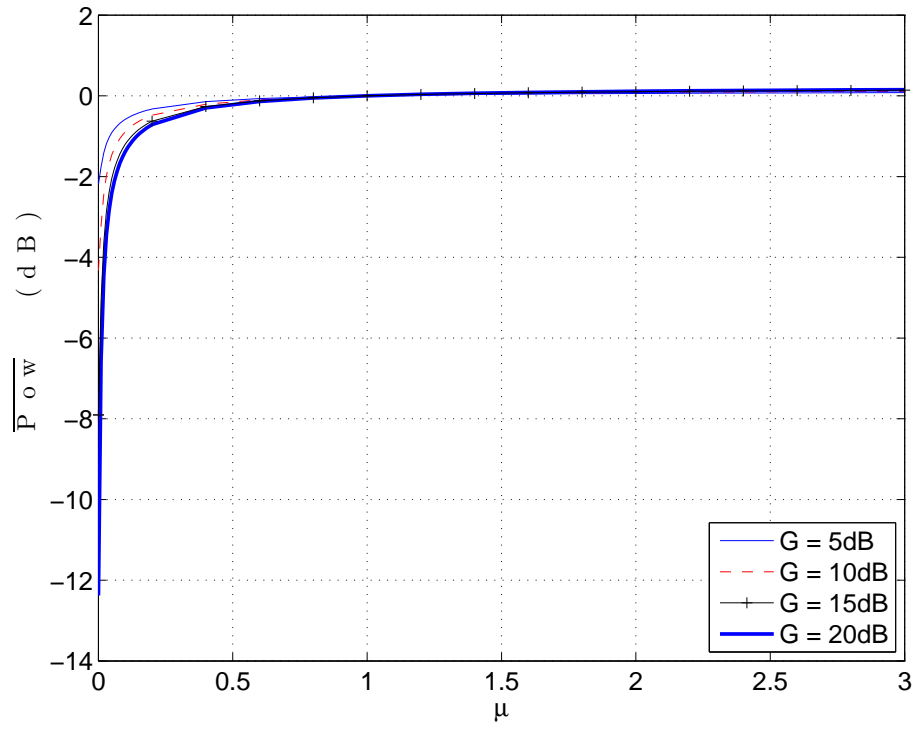

Figure 15: Normalised output noise power attenuation of the SDW-ANC/NR scheme (car noise)

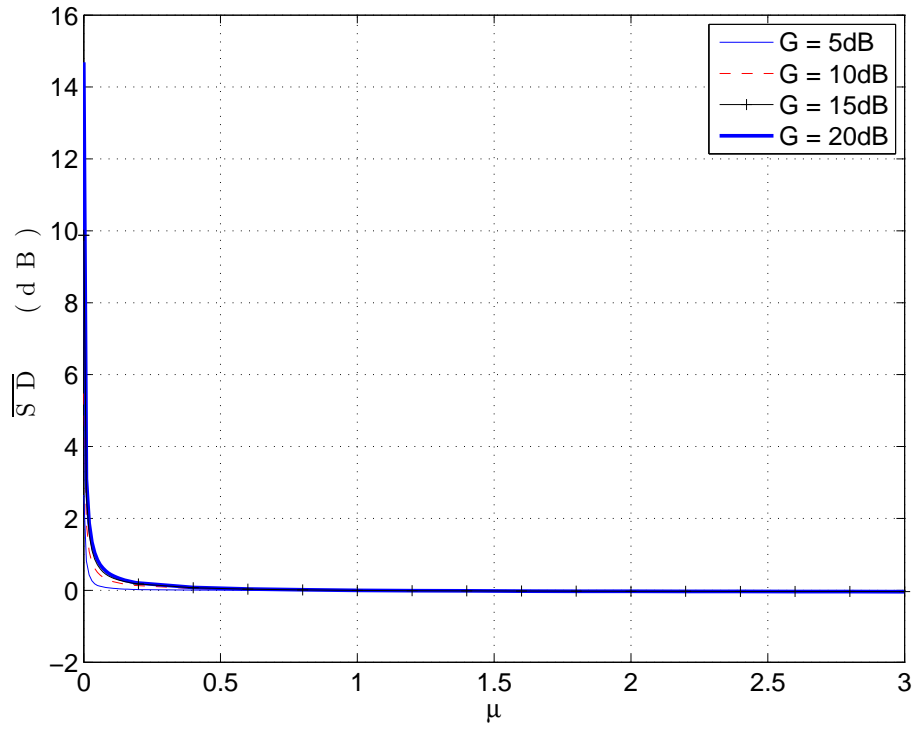

Figure 16: Normalised speech distortion introduced by the SDW-ANC/NR scheme (car noise)

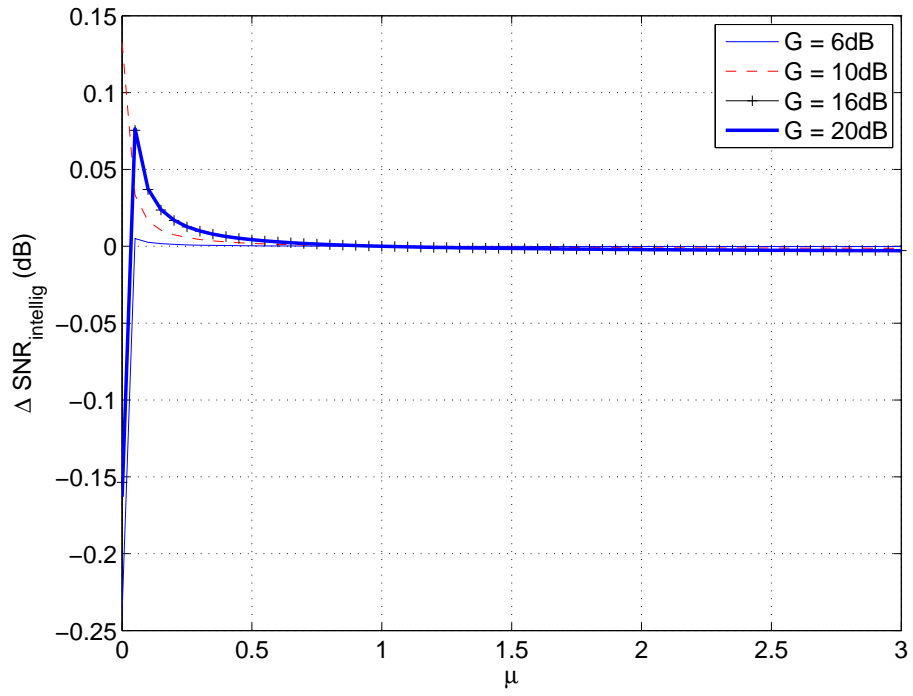

Figure 17: SIW-SNR improvement of the SDW-ANC/NR scheme compared to the unweighted integrated ANC and NR scheme (babble noise)

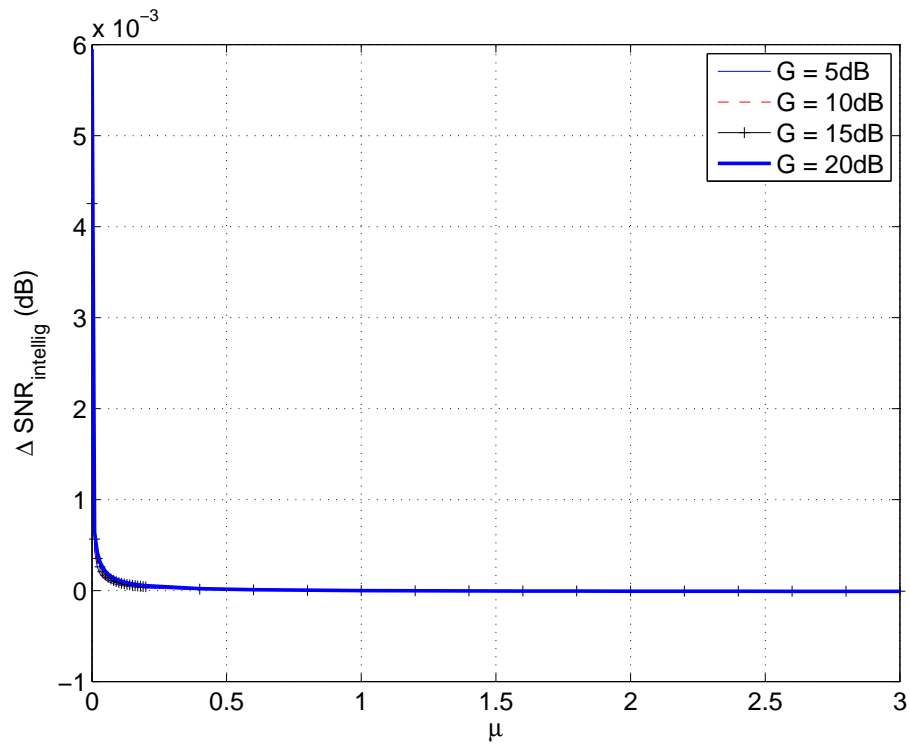

Figure 18: SIW-SNR improvement of the SDW-ANC/NR scheme compared to the unweighted integrated ANC and NR scheme (car noise)