

Optimal Energy Management of Hybride Renewable Energy System for Isolated Area in Vietnam

Keywords : *Micro Hydro Power, Solar Power, Optimisation, Control.*

Director of Thesis : Frédéric NOLLET, Najib ESSOUNBOULI.

Starting date : 1 February 2015

Name : PHAM Duy An

PhD Student in second year

***Research Centre in Information and
Communication Science and Technologies
(CRESTIC)- University of Reims Champagne
Ardenne***

***Clean Energy and Sustainable Development
(CleanED) lab - Vietnam France University
(USTH)***

Email: phamduyan.iph@gmail.com

**Seminar PhD students USTH
Amiens- France
3-5 Octobre 2016**

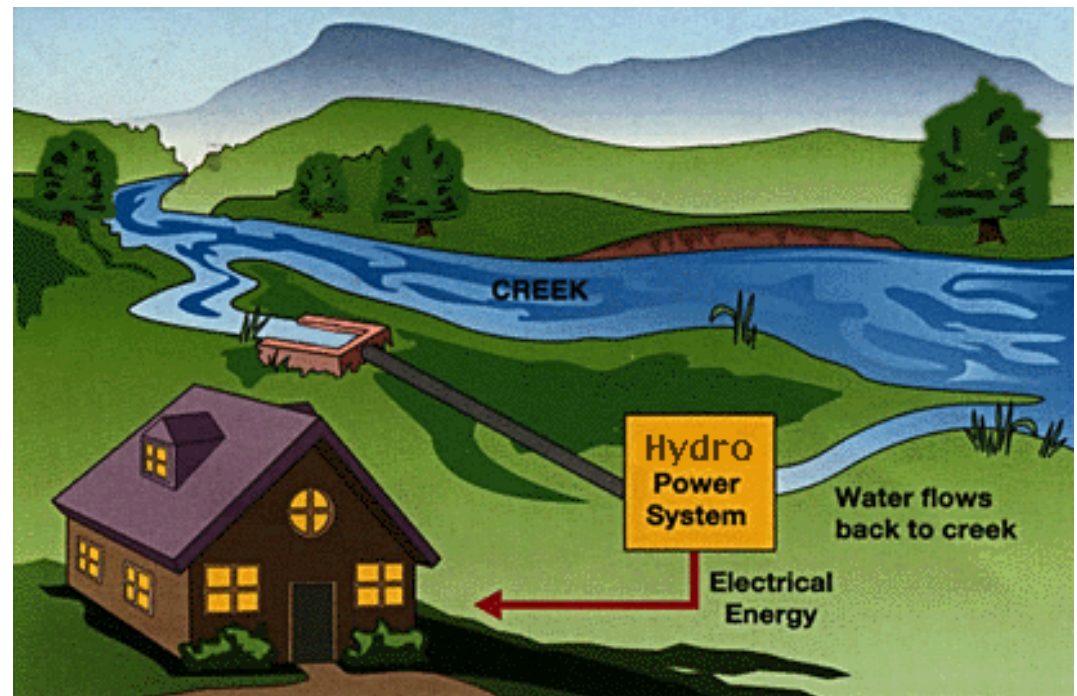

Outline

- ❑ **The Vietnam Electric Dilemma**
- ❑ **Off-Grid Opportunities in Vietnam**
- ❑ **Renewable Energy (RE) Opportunities for the Off-Grid Communities in Vietnam**
- ❑ **Solar potential in Vietnam**
- ❑ **Hydropower potential in Vietnam**
- ❑ **Objective of Thesis**
- ❑ **Planning**

The Vietnam Electric Dilemma

**Demand 15%/ year
Supply 13% / year**

- Electric price up 15 %
- Off power in peak hrs, Hanoi, HCMC, 1-2 hrs
- 26 power plants, import power

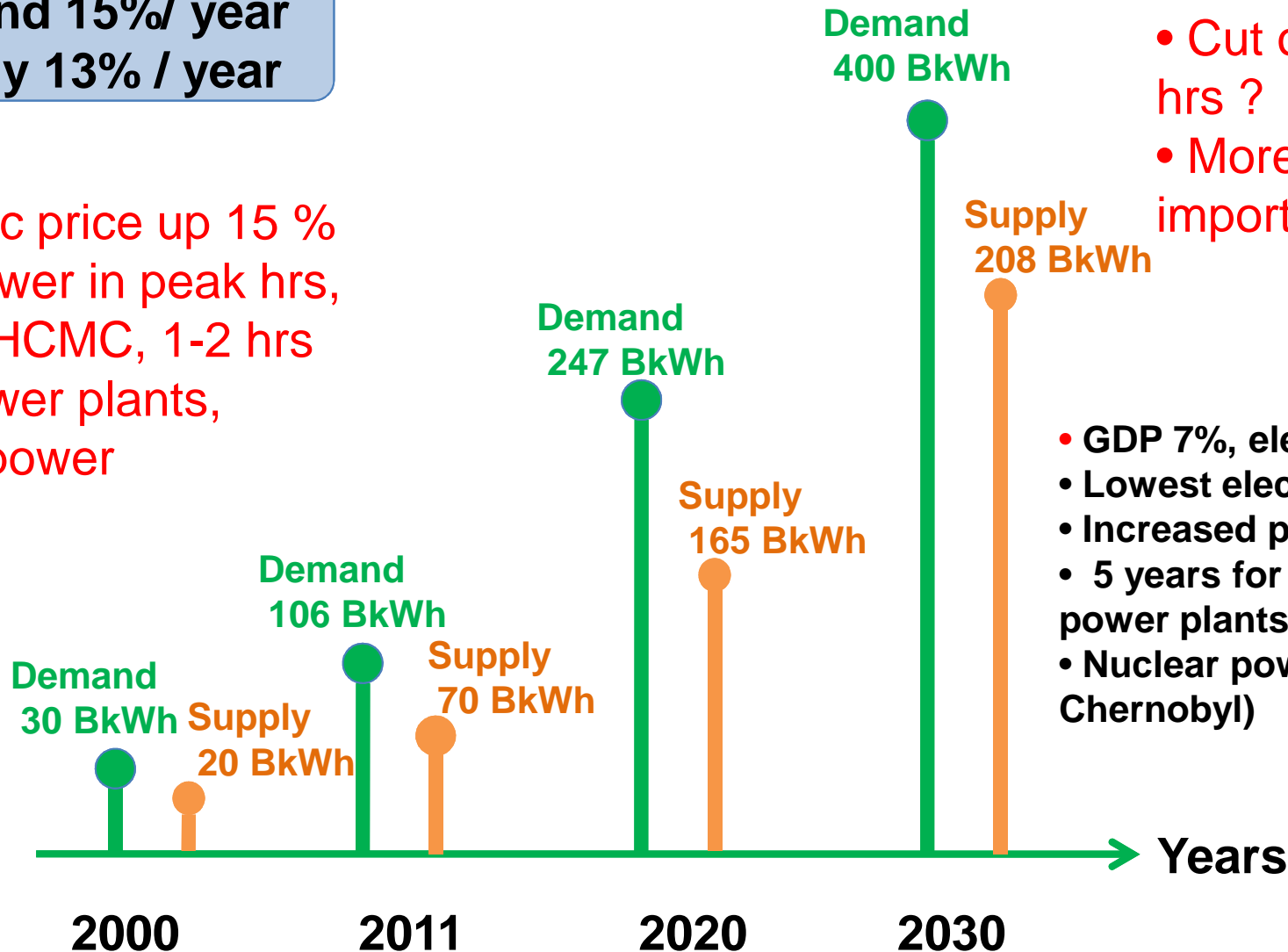

- Electric price up ?
- Cut off power in peak hrs ?
- More power plants ? import power ?

- GDP 7%, electricity demand 15%
- Lowest electric price in SEA
- Increased price is a must trend
- 5 years for construction 01 power plants
- Nuclear power plant (Fukushima, Chernobyl)

The Vietnam Electric Dilemma

A huge dilemma but equation is simple

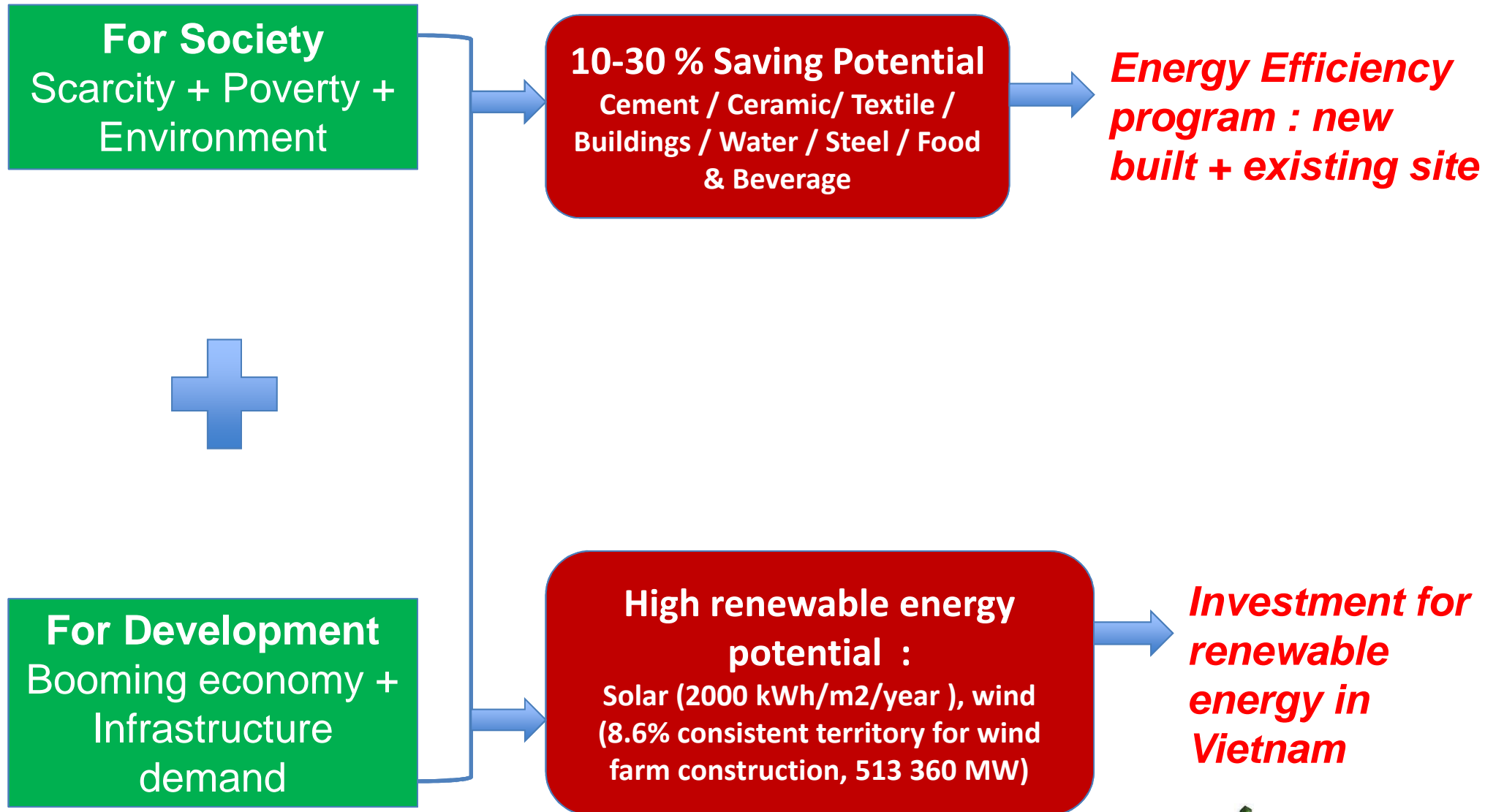

Off-grid Opportunities in Vietnam

In 2009, on districts level

- National power grid covered 63 provinces , and 536/547 districts (98%)

In 2009 , on community level

- 8931/9120 communes have the access to electricity (97,93%)
- 189 communes left living without electricity. and, 41 communes with off grid solutions

In 2012, on households level

- 20,758,415 households in Vietnam (VN)
- 549,131 household don't have access to electricity (2,64%)

GiS map of the number of households that don't have access to the national Grid

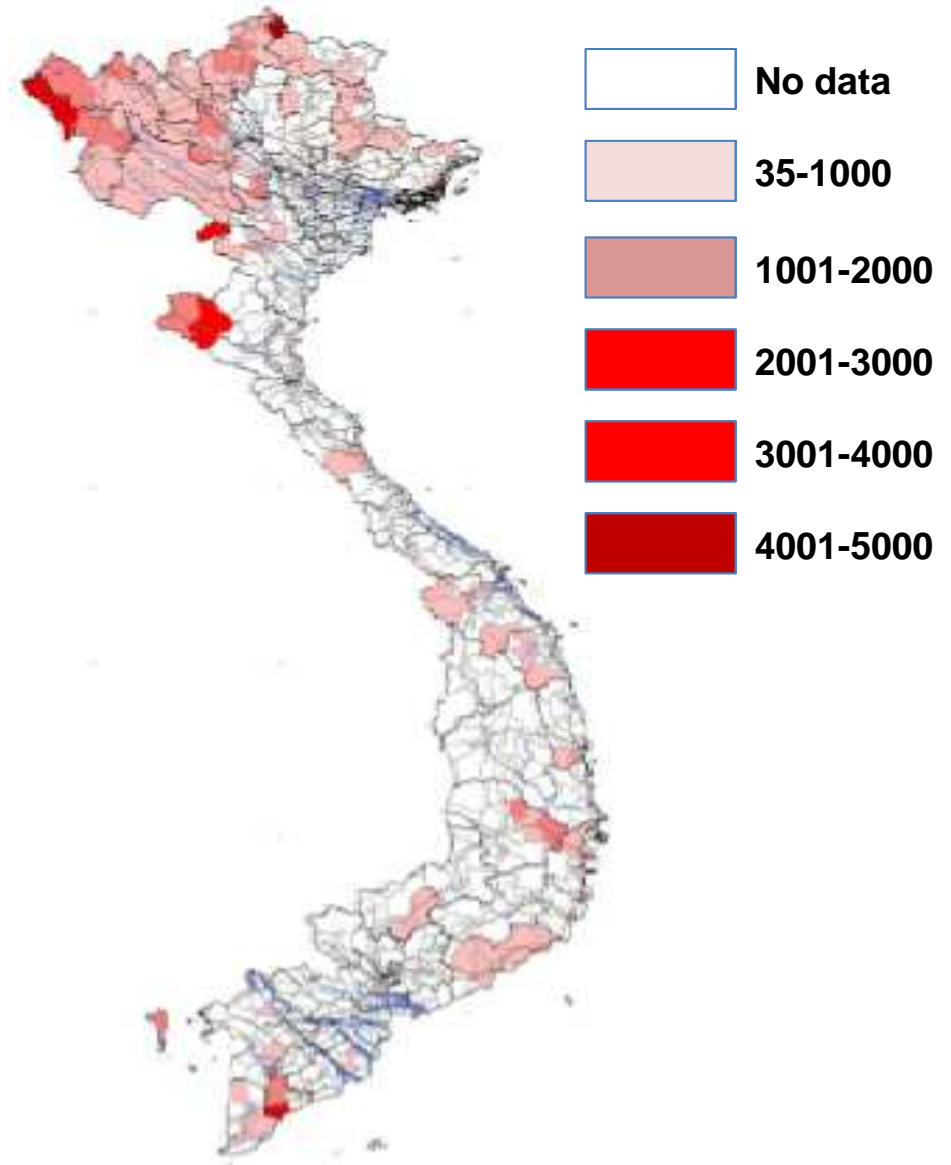
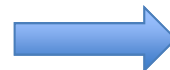

RE Opportunities for the Off-Grid Communities

Vietnam

- An agricultural country
- Monsoon tropical climate
- 3200 km long coast receiving winds from the ocean
- A vast sea area



High potential on RE

- Wind power
- Solar PV
- Geothermal Power
- Hydro Power (mini, micro, pico)
- Biomass to electricity



Focus on

Micro hydro power

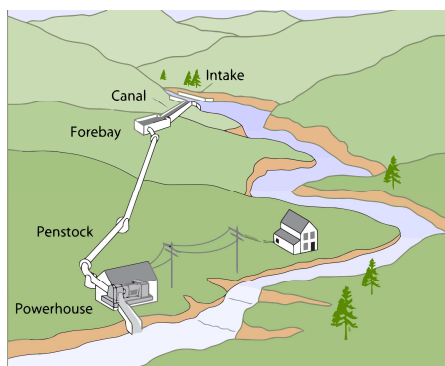

Solar power



Solar potential in Vietnam

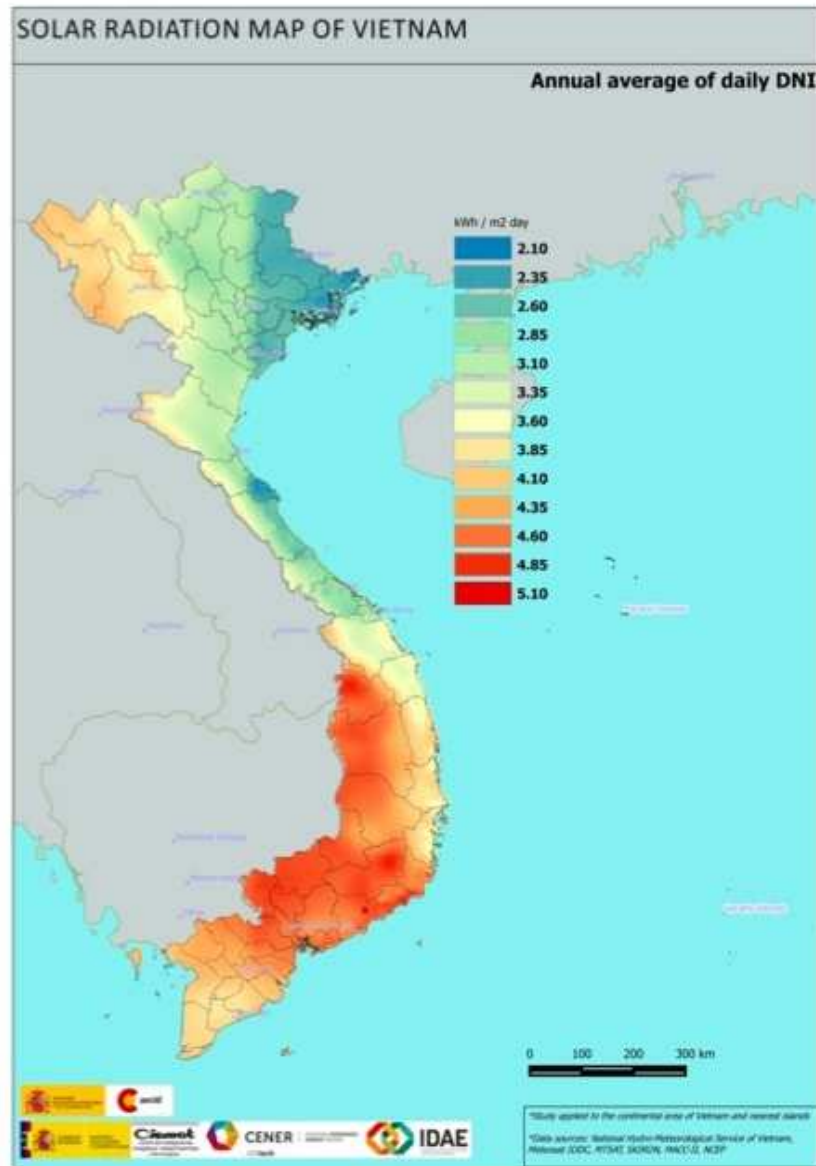

- Average solar radiation of 3- 4.5 kWh/m²/day in winter, of 4.5- 6.5 kWh/m²/day in summer
- Southern and central regions : 300 days sunshine per year.
- Northeast and northwest : 250-280 days sunshine per year

In off-grid areas solar PV off grid system is considered to be one of the most feasible options to bring electricity to local people

6000 smalls solar power station of 750 kW installed in the mountains and islands (telecommunication, community centers, schools, clinics, household)

Hydropower potential in Vietnam

9 basin in Vietnam, cover areas of > 10000 km², rich of water resources.

Pico, micro and mini hydropower is the most effective technology applied popularly in VN for off-grid areas , potential stream energy in the north of Vietnam (Lao Cai, Son La province...)

- 120000 pico and micro hydropower household installed, ranging from 0.2 to 5kW, total capacity 30-60 MW, 50% located in the north of VN.
- 60 MW grid connected mini-hydropower at 48 sites through in VN, ranging from 100 to 7500 kW.

Location of the main river basins in Vietnam

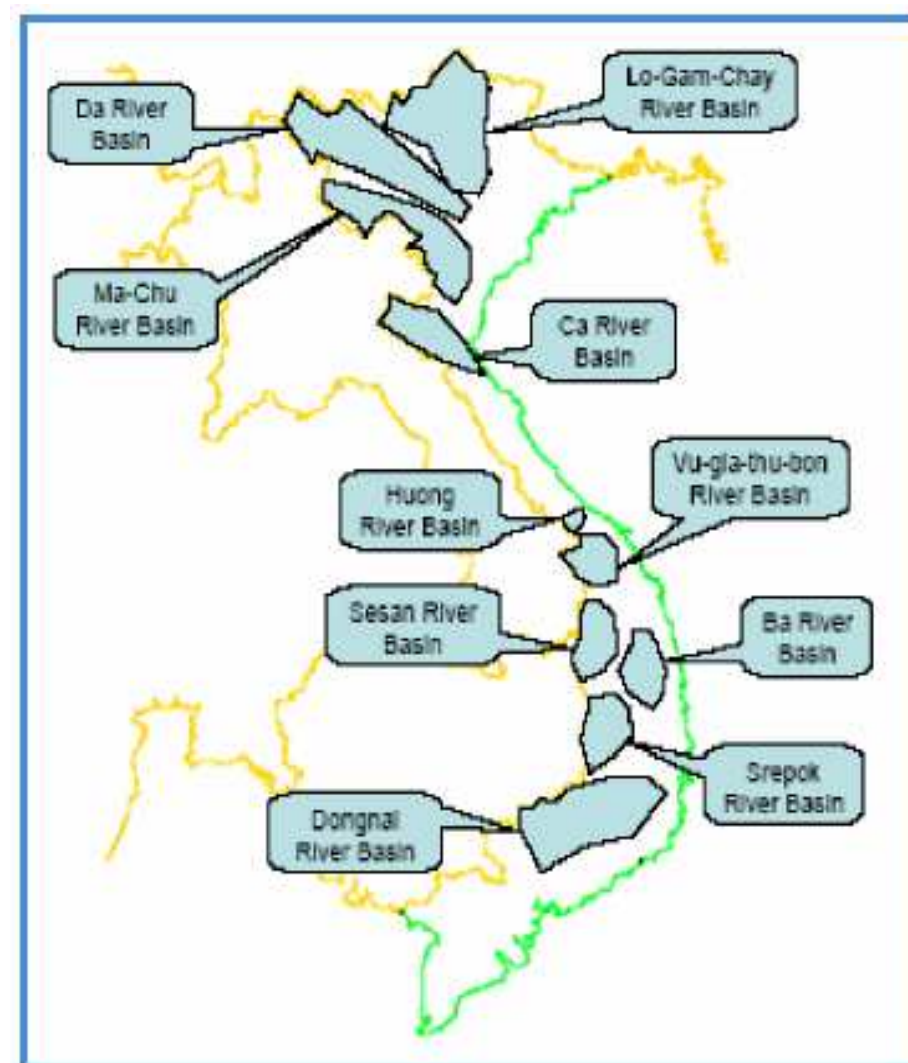

Objective of the thesis

Electrical supply solution for off-grid location in Vietnam (village, mountain, island) where have good potential hydro power and solar power ?

- Small hybrid power generation system consisting :
- PV generating unit with storage
 - A micro hydro generation
 - Diesel generator

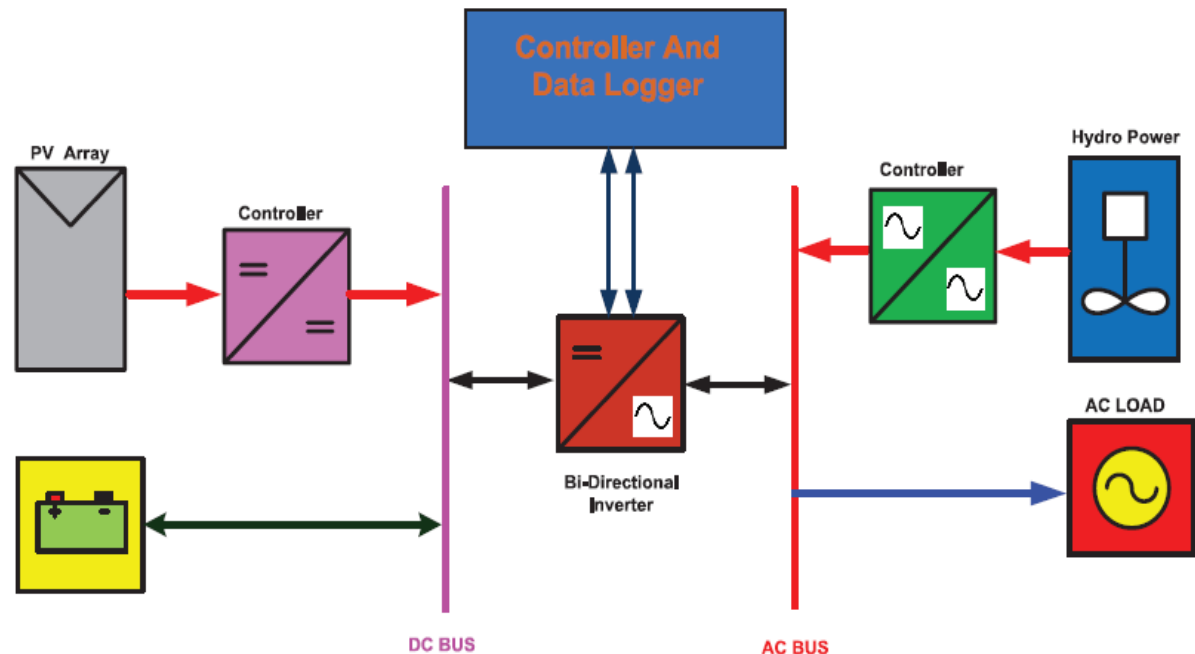

Objective of the thesis

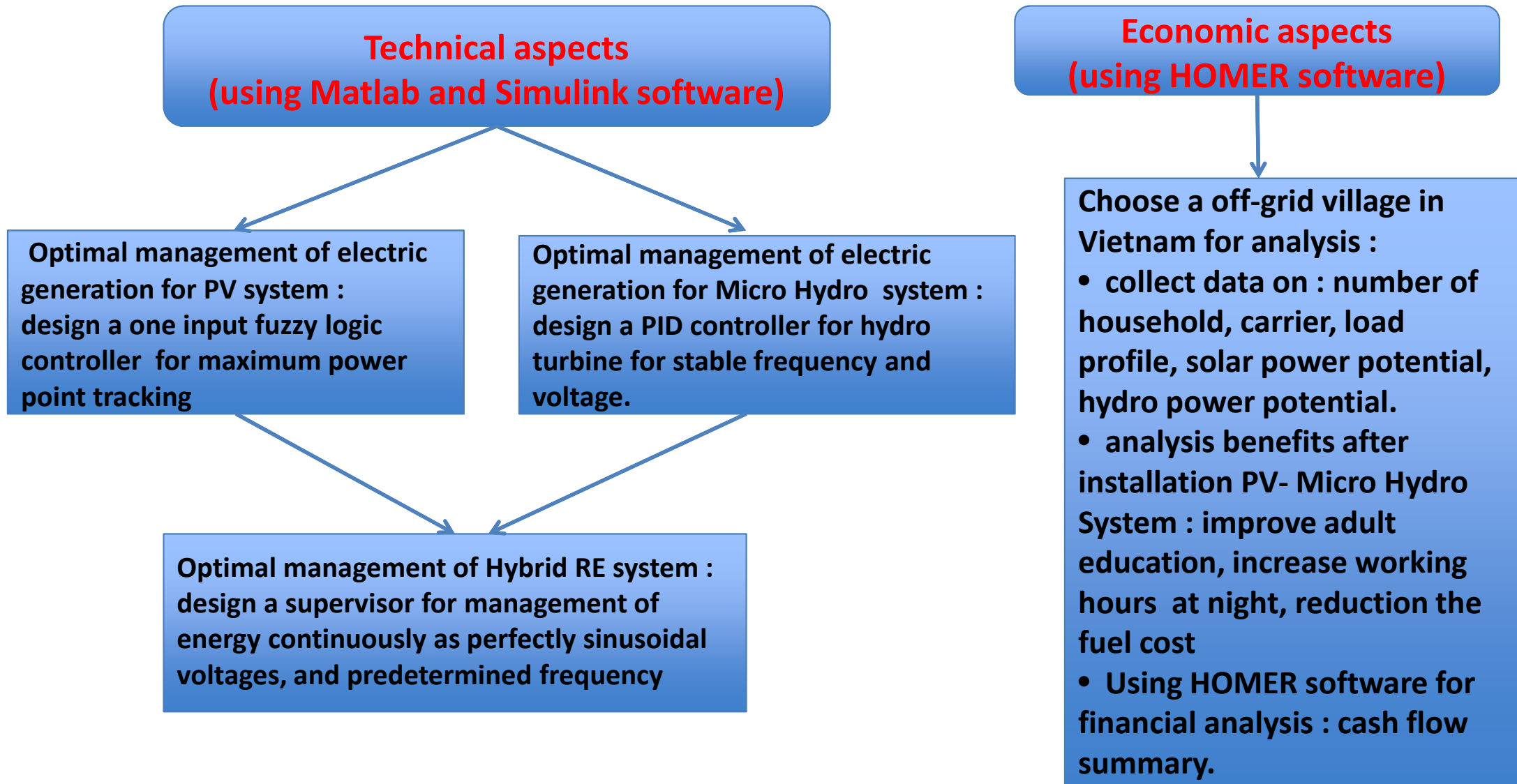

Modeling and control PV system

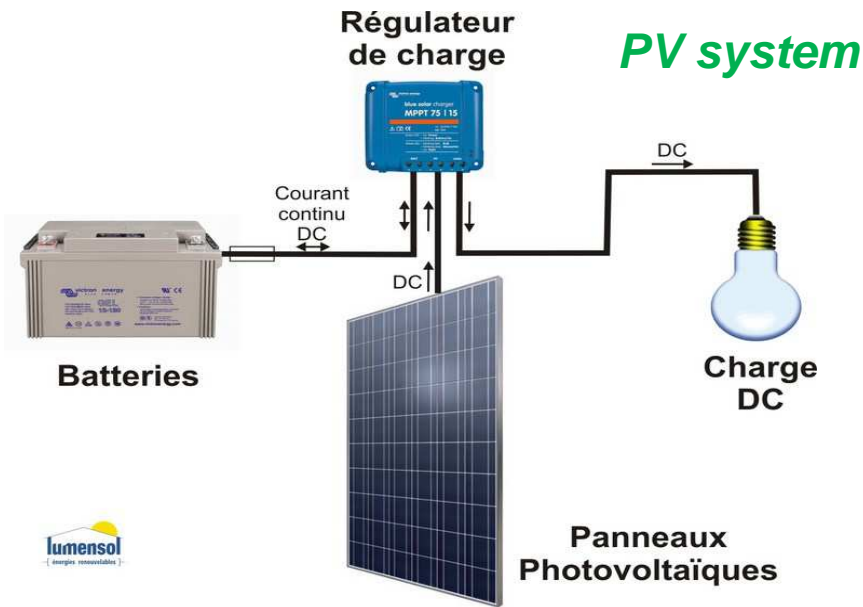

Optimal management of electric generation for PV system :
design a one input fuzzy logic controller for maximum power point tracking

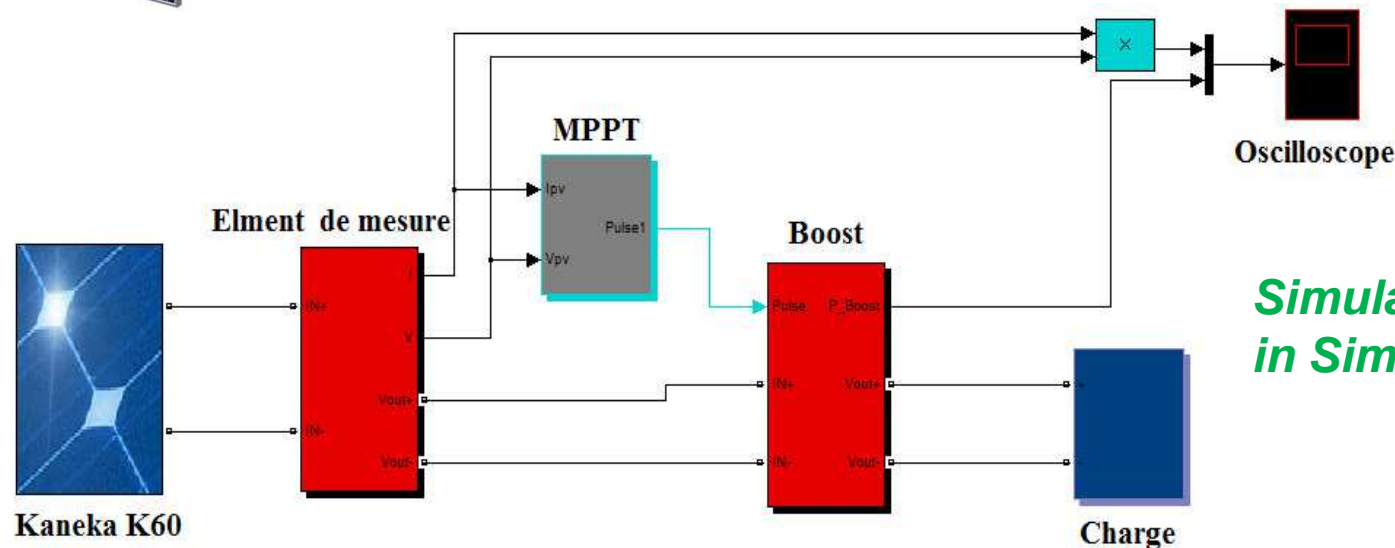

Simulation PV system in Simulink

Modeling and control Micro Hydro Plant

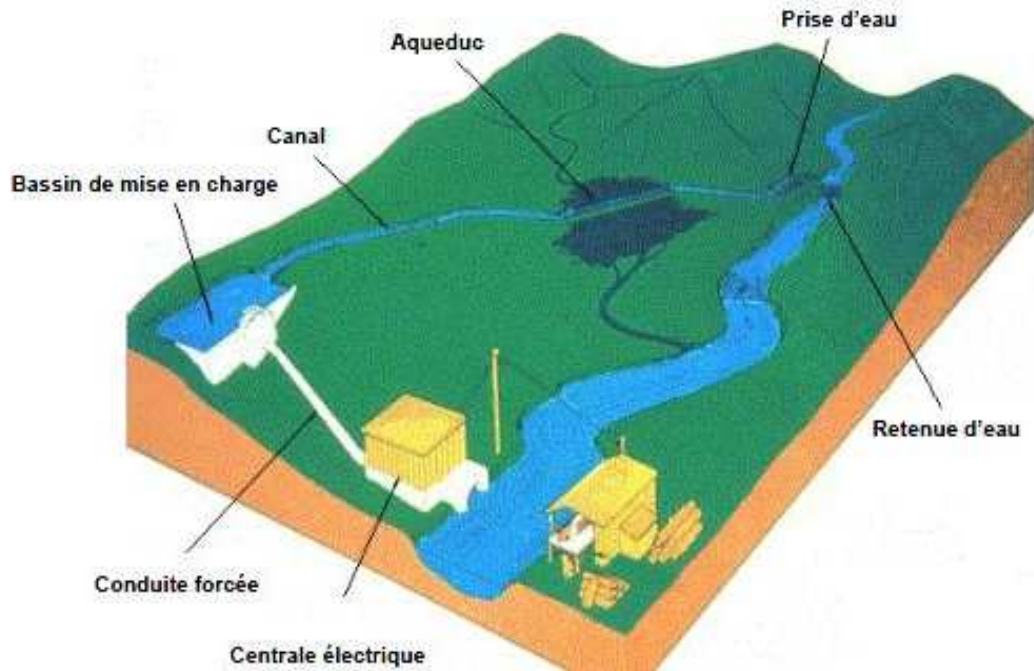

Micro Hydro Plant

Simulation Micro Hydro Plant in simulink software

Optimal management of electric generation for Micro Hydro system : design a PID controller for hydro turbine for stable frequency and voltage.

Synchronous Machine

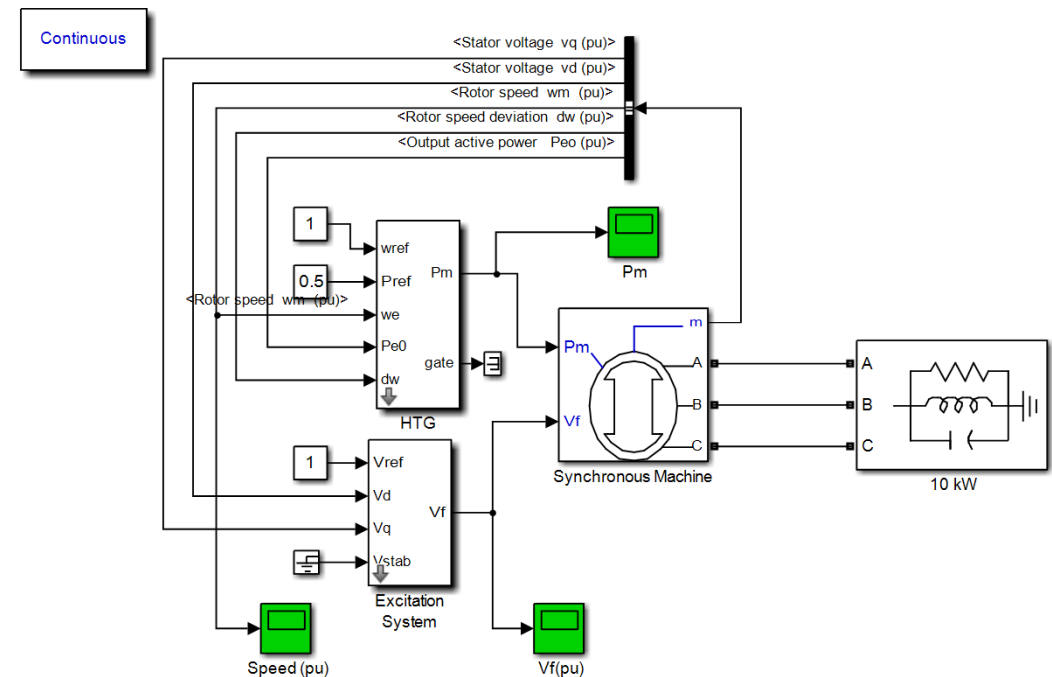

The Cooperation

**Clean Energy and Sustainable
Development (CleanED) lab -
Vietnam France University (USTH)**



**My thesis
The Cooperation between the two labs
in the field of renewable energies**



**Research Centre in Information and Communication
Science and Technologies (CRESTIC)- University of
Reims Champagne Ardenne**

Reference

- ❖ Off-Grid Opportunities and Challenges in Vietnam final report. USAID Vietnam Clean Energy Program. 24 January 2014.
- ❖ World Small Hydropower Development Report 2013 in Vietnam. United Nations Industrial Development Organization (UNIDO) and International Center on Small Hydro Power (ICSHP).2013.
- ❖ J. Polo , A. Bernardos , A.A. Navarro , C.M. Fernandez-Peruchena , L. Ramírez , María V. Guisado , S. Martínez. *Solar resources and power potential mapping in Vietnam using satellite-derived and GIS-based information*. Energy Conversion and Management 98(2015) 348-358.
- ❖ Duy An PHAM, Frédéric NOLLET ,Najib ESSOUNBOULI . ‘A One Input Fuzzy Logic Controller for Maximum Power Point Tracking of a Photovoltaic System’. International Conference on Renewable Energy Generation and Applications . Belfort, France, Feb 2016.
- ❖ Huynh Quang M. *Optimisation de la production de l'électricité renouvelable pour site isolé (optimization the production of renewable power for isolated area)*. Thesis, Automatic, University of Reims Champagne-Ardenne, 2012.

THANK YOU VERY MUCH!