



**HAL**  
open science

## $\mu$ -Bicomplete Categories and Parity Games

Luigi Santocanale

► **To cite this version:**

Luigi Santocanale.  $\mu$ -Bicomplete Categories and Parity Games. [Research Report] RR-1281-02, LaBRI - Laboratoire Bordelais de Recherche en Informatique. 2002. <hal-01376731>

**HAL Id: hal-01376731**

**<https://hal.science/hal-01376731v1>**

Submitted on 20 Oct 2016

**HAL** is a multi-disciplinary open access archive for the deposit and dissemination of scientific research documents, whether they are published or not. The documents may come from teaching and research institutions in France or abroad, or from public or private research centers.

L'archive ouverte pluridisciplinaire **HAL**, est destinée au dépôt et à la diffusion de documents scientifiques de niveau recherche, publiés ou non, émanant des établissements d'enseignement et de recherche français ou étrangers, des laboratoires publics ou privés.



Copyright - All rights reserved

*Laboratoire Bordelais de Recherche en Informatique*  
UMR 5800 - Université Bordeaux I, 351, cours de la Libération,  
33405 Talence CEDEX, France

Research Report RR-1281-02

# $\mu$ -Bicomplete Categories and Parity Games

by Luigi Santocanale

September, 2002



# $\mu$ -Bicomplete Categories and Parity Games

Luigi Santocanale  
LaBRI - Université Bordeaux 1.  
santocan@labri.fr.

## Abstract

For an arbitrary category, we consider the least class of functors containing the projections and closed under finite products, finite coproducts, parameterized initial algebras and parameterized final coalgebras, i.e. the class of functors that are definable by  $\mu$ -terms. We call the category  $\mu$ -bicomplete if every  $\mu$ -term defines a functor. We provide concrete examples of such categories and explicitly characterize this class of functors for the category of sets and functions. This goal is achieved through parity games: we associate to each game an algebraic expression and turn the game into a term of a categorical theory. We show that  $\mu$ -terms and parity games are equivalent, meaning that they define the same property of being  $\mu$ -bicomplete. Finally, the interpretation of a parity game in the category of sets is shown to be the set of deterministic winning strategies for a chosen player.

**Keywords:** parity games, bicomplete categories, initial algebras, final coalgebras, inductive and coinductive types.

## 1 Introduction

Several set-theoretic structures of relevance to computer science can be described either by using the language of initial algebras or by using the language of final coalgebras. For example, sets of finite trees, the set of terms over a signature and, more in general, inductively defined sets are initial algebras of some functor and this property characterizes these sets up to canonical isomorphism. Similarly, sets of trees with possibly infinite branches, sets of objects which are canonical solutions of systems of equations, coinductively defined sets or coinductive types, can be characterized up to isomorphism by the property of being final coalgebras of some functor. Thus the study of initial algebras in connection with data structures is a well developed subject and dates back at least twenty five years [3, 22]. The interest in final coalgebras is more recent, but is nowadays grown up to a well established discipline [1, 6, 28]. Despite the existence of programming languages and proof assistants that implement both inductive and coinductive types [11, 16], it appears to us that initial algebras and final coalgebras are not often studied simultaneously in the literature. Thus

we are led to the problem of understanding what kind of structures arise from both initial algebras and final coalgebras and whether these structures are of any interest in computer science.

This paper is therefore meant to be an introduction to the theory of categories having the following completeness properties: they have finite *sums*, finite *products* and all the *initial algebras* and *final coalgebras* of the functors which can be constructed out of these four operations, using projection functors as building blocks. These categories generalize  $\mu$ -lattices [31, 29] and  $\mu$ -algebras [26] on one side, on the other side they partially generalize bicomplete categories [18]. For this reason we call them  $\mu$ -bicomplete.

A first concern is to show that many common categories are  $\mu$ -bicomplete. It is well known that an accessible unary endofunctor of a locally presentable category has both an initial algebra and a final coalgebra. We adapt ideas existing in the literature to prove that locally presentable categories are  $\mu$ -bicomplete. Among the locally presentable categories is the category of sets and functions, which is therefore  $\mu$ -bicomplete.

As it is often the case for existence theorems, the mere knowledge that a category is  $\mu$ -bicomplete is unsatisfactory. The principal goal of this paper is that of giving an explicit description of the functors on the category of sets that arise out of those four operations, i.e. of the functors that are definable by  $\mu$ -terms. We achieve this goal by translating the algebraic language of  $\mu$ -bicomplete categories into the combinatorial language of *parity games*, cf. [5, §4]. These games are a standard tool in the theory of automata recognizing infinite objects [33]. A central notion in this theory is that of an acceptance condition, essentially a method for specifying a set of infinite paths in a graph. The acceptance condition by which the set of infinite winning plays in a parity game is defined was introduced in [25] to construct automata in normal form. Thus it should not come as a surprise that several combinatorial problems of the theory can be reduced to the problem of finding winning strategies in a parity game. For example, the properties of transition systems that are definable by alternating fixed point expressions can be checked using algorithms designed and proved correct by means of game-theoretic ideas and analogies [12].

Generalizing ideas that relate the theory of two persons games with the theory of bicomplete categories [18, 19], we show that it is possible to endow parity games with an algebraic meaning, so that they can be considered to be terms of a categorical theory. We show then the equivalence of this meaning to the one of  $\mu$ -terms defining  $\mu$ -bicomplete categories. On the combinatorial side, parity games can be considered as recognizers of infinite objects in a natural way: they recognize the set of deterministic winning strategies for a chosen player. The two different meanings of parity games, the algebraic one and the combinatorial one, are then shown to coincide if the category of sets and functions is being considered. This leads to the characterization of functors denoted by  $\mu$ -terms in the category of sets: a  $\mu$ -term is translated into a parity game and its denotation in this category is the set of deterministic winning strategies for the chosen player.

This result supports the claim that the algebra of parity games is the one of

$\mu$ -bicomplete categories and that the combinatorics of  $\mu$ -bicomplete categories is the one of parity games, a claim which is meant to emphasize two possible directions of research. One goes from the algebra to the combinatorics: for example, this work should provide a starting point for elaborating game semantics of programming languages that implement both inductive and coinductive types. The other direction goes from the combinatorics to the algebra: we are proposing an alternative algebraic interpretation of the alternation between “finitely many times” and “infinitely often” which occurs so often in the theory of automata recognizing infinite objects. The alternation is usually analyzed by means of complete lattices, of ordinals and of approximants of least fixed points that occur nested within greatest fixed points. Our interpretation requires induction and coinduction, that is, initial algebras and final coalgebras of functors which are natural generalizations of least and greatest fixed points. A particular motivation for developing this work has been the possibility of describing transformations of winning strategies by means of arrows definable in every  $\mu$ -bicomplete category. We have reported partial results on the structure of arrows of  $\mu$ -bicomplete categories in [30].

On several occasions categories with similar completeness properties have been proposed. For example, in [15] a category  $\mathcal{C}$  is defined to be algebraically complete if every unary endofunctor has an initial algebra. This requirement appears to be too strong, since the only complete categories with this property turn out to be the complete quasi-orders. It is possible to relax the requirement and ask only a given class of functors of the form  $F : \prod_{i \in I} \mathcal{C} \longrightarrow \mathcal{C}$  to be closed under parameterized initial algebras. This approach is the one proposed in [14] and leads to define 2-iteration theories [8]. This is also our approach with the proviso that we are interested in a specific class which is required to be closed under parameterized final coalgebras as well. In [15] final coalgebras are considered too, but they are flattened into initial algebras: an algebraically compact category is defined there to be an algebraically complete category such that the inverse of every initial algebra is also a final coalgebra of the same functor.

In these and other contexts the equational properties of categorical fixed points have been studied. Our aim here is to see these properties at work. Our starting point will be the Bekič property. In its simplest form it is an inductive method for showing that a system of equations admits a unique solution: a sufficient condition for the system of equations

$$\left\{ \begin{array}{l} x = f(x, y) \\ y = g(x, y) \end{array} \right\}$$

to admit a unique solution is that the system

$$\{ x = f(x, y) \}$$

admits a unique solution  $x = f^\dagger(y)$  for each choice of  $y$  and that either of the two equivalent systems

$$\left\{ \begin{array}{l} x = f^\dagger(y) \\ y = g(x, y) \end{array} \right\} \quad \{ y = g(f^\dagger(y), y) \}$$

admits a unique solution. The analogy of the Bekič property with Gaussian elimination has been pointed in [32, 5]. The equivalence between the last two systems is moreover the root of our algebraic interpretation of parity games. We shall state a categorical version of the Bekič property; the property stated above is recovered when considering that a set is a poset with a discrete order, and that a poset is a category with at most one arrow between any two objects: an initial algebra of an endofunctor of a discrete category is nothing else but a unique fixed point. The Bekič property allows to prove the equivalence between  $\mu$ -terms and systems of functorial equations. These seem to be better suited than  $\mu$ -terms for an analysis that emphasizes the operational aspects.

The paper is structured as follows. In section 2 we explain the notation, introduce the principal concepts and state the Bekič property. In section 3 we define categorical  $\mu$ -terms and  $\mu$ -bicomplete categories. We prove that locally presentable categories are  $\mu$ -bicomplete. In section 4 we define parity games and their algebraic interpretation. We show that it is possible to interpret every parity game on a category if and only if the category is  $\mu$ -bicomplete, by giving a translation of parity games into  $\mu$ -terms and vice-versa. In section 5 we prove that the algebraic interpretation of a parity game in the category of sets is the set of winning strategies for a chosen player. We add some examples and applications of the theory so far developed. Finally, in section 6, we add concluding remarks.

## 2 Notation and Preliminaries

### 2.1 Notation

We will use different notations for the categorical composition. Given two arrows  $f : A \longrightarrow B$  and  $g : B \longrightarrow C$  of a category  $\mathcal{C}$ , we use the notation  $f \cdot g : A \longrightarrow C$  for their composition. However, when dealing with functors  $F : \mathcal{C} \longrightarrow \mathcal{D}$  and  $G : \mathcal{D} \longrightarrow \mathcal{E}$ , we prefer the notation  $G \circ F$ , or simply  $GF$ . In a similar way, if  $f : A \longrightarrow B$  is a set-theoretic function, we use  $f(a)$ ,  $fa$  and  $f_a$  for evaluation at  $a \in A$ .

If  $w : I \longrightarrow \mathcal{W}$  is a functor, we use the notation  $(\mathbf{in}_i : w_i \longrightarrow \text{colim } w)_{i \in I}$  for a chosen colimiting cocone. If  $(f_i : w_i \longrightarrow c)_{i \in I}$  is another cocone, then we let  $\{f_i\}_{i \in I} : \text{colim } w \longrightarrow c$  be the unique arrow such that  $\mathbf{in}_i \cdot \{f_i\}_{i \in I} = f_i$ , for

all objects  $i$  of  $I$ . We use analogous notations  $\text{pr}_i, \text{lim}$ , and  $\langle f_i \rangle_{i \in I}$  for chosen limiting cones.

We use the symbols  $\partial_0, \partial_1$  for the domain and codomain functions of graphs and categories. Given a graph  $S = \langle \partial_0, \partial_1 : M \longrightarrow P \rangle$ , we write  $m : p \rightarrow q$  to mean that  $m \in M$ ,  $\partial_0 m = p$  and  $\partial_1 m = q$ . The free category over the graph  $S$  is described as follows: its set of objects is  $P$  and an arrow from  $p$  to  $q$  is a sequence of transitions  $\gamma = \{m_i\}_{i=1, \dots, n}$  such that  $\partial_0 m_1 = p$ ,  $\partial_0 m_{i+1} = \partial_1 m_i$ ,  $i = 1, \dots, n-1$  and  $\partial_1 m_n = q$ , that is, it is a path in  $S$  from  $p$  to  $q$ ; we say in this case that  $n = \#\gamma$  is the length of  $\gamma$ . Given two paths  $\delta$  from  $p$  to  $q$  and  $\gamma$  from  $q$  to  $r$  in  $S$ , we use the notation  $\delta \star \gamma$  for their composition. The identity of a vertex  $p$  is the path  $1_p$  from  $p$  to  $p$  having null length. A path  $\delta$  is a prefix of  $\gamma$  if there exists a path  $\gamma'$  such that  $\gamma = \delta \star \gamma'$ .

A morphism of graphs  $\Phi : \langle P_1, M_1, \partial_0, \partial_1 \rangle \longrightarrow \langle P_2, M_2, \partial_0, \partial_1 \rangle$  is a pair of functions  $\Phi : P_1 \longrightarrow P_2, \Phi : M_1 \longrightarrow M_2$  such that  $\partial_i \Phi(m) = \Phi(\partial_i m)$ , for  $i = 0, 1$  and  $m \in M_1$ . We can describe a path in  $S$  as a morphism of graphs  $\gamma : \hat{n} \longrightarrow S$ , where  $\hat{n}$  is the graph  $0 \rightarrow 1 \rightarrow \dots \rightarrow n$ . An infinite path in  $S$  is a morphism of graphs  $\gamma : \hat{\omega} \longrightarrow S$ , where  $\hat{\omega}$  is the graph  $0 \rightarrow 1 \rightarrow \dots \rightarrow n \rightarrow \dots$ . If  $\delta$  is a finite path from  $p$  to  $q$  and  $\gamma$  is an infinite path such that  $\gamma_0 = q$ , then we write  $\delta \star \gamma$  for the resulting infinite path. A morphism of graphs  $\Phi : S_1 \longrightarrow S_2$  induces a functor between the respective free categories, which we will denote by the same letter  $\Phi$ . Observe that if  $\gamma$  is a path in  $S_1$ , then  $\Phi(\gamma)$  is the morphism of graphs  $\gamma \cdot \Phi$ , thus we extend the same notation to infinite paths, letting in this case  $\Phi(\gamma) = \gamma \cdot \Phi$ .

## 2.2 Initial Algebras of Functors

Let  $\mathcal{C}$  be a category and  $F : \mathcal{C} \longrightarrow \mathcal{C}$  be an endofunctor, an *F-algebra* is a pair  $(c, \gamma)$ , where  $c$  is an object of  $\mathcal{C}$  and  $\gamma : Fc \longrightarrow c$  is an arrow of  $\mathcal{C}$ . A morphism of *F-algebras*  $f : (c, \gamma) \longrightarrow (d, \delta)$  is an arrow  $f : c \longrightarrow d$  of  $\mathcal{C}$  such that  $\gamma \cdot f = Ff \cdot \delta$ . *F-algebras* and their morphisms form a category  $\mathcal{C}^F$  and we define an initial *F-algebra* to be an initial object in this category. More explicitly, an *F-algebra*  $(\mathbf{x}, \chi)$  is initial if for each *F-algebra*  $(c, \gamma)$  there exists a unique arrow  $f : \mathbf{x} \longrightarrow c$  such that  $\chi \cdot f = Ff \cdot \gamma$ . We remark that if an *F-algebra*  $(\mathbf{x}, \chi)$  is initial, then the arrow  $\chi$  is invertible [21].

*F-coalgebras* and their morphisms are defined dually and form a category  $\mathcal{C}_F$ . We recall that a coalgebra  $\xi : \mathbf{y} \longrightarrow F\mathbf{y}$  is final if for each coalgebra  $\gamma : c \longrightarrow Fc$  there exists a unique arrow  $g : c \longrightarrow \mathbf{y}$  such that  $g \cdot \xi = \gamma \cdot Fg$ .

If  $F : \mathcal{C} \times \mathcal{D} \longrightarrow \mathcal{C}$  is such that for every object  $d$  of  $\mathcal{D}$  there exists an initial algebra  $(F^\mu(d), \chi_d)$  of the functor  $F(-, d)$ , then there exists a unique way to turn the collection of objects  $F^\mu(d)$  into a functor so that  $\chi_d : F(F^\mu(d), d) \longrightarrow F^\mu(d)$  is a natural isomorphism: for  $f : d \longrightarrow d'$ ,  $F^\mu(f)$  is the unique  $F(-, d)$ -algebra morphism from the initial one  $(F^\mu(d), \chi_d)$  to  $(F^\mu(d'), F(F^\mu(d'), f) \cdot \chi_{d'})$ . We call the arising functor  $F^\mu : \mathcal{D} \longrightarrow \mathcal{C}$  a *parameterized initial algebra* of  $F$ . A parameterized final coalgebra  $F^\nu$  of  $F$  is defined similarly.

### 2.3 The Bekič Property

We state here the Bekič property for initial algebras of functors, a proof of which is found in [22, §4.2]. This property will be a major tool in the proofs that follow. Thus we add here a proof, with the aim of making this report self contained.

**Proposition 2.1.** *Consider two functors  $F : \mathcal{C} \times \mathcal{D} \longrightarrow \mathcal{C}$ ,  $G : \mathcal{C} \times \mathcal{D} \longrightarrow \mathcal{D}$ , and for each object  $d$  of  $\mathcal{D}$  let  $(F^\mu(d), \chi_d)$  be an initial  $F(-, d)$ -algebra. Suppose moreover that there exists an initial algebra*

$$\xi : F^\mu(\mathbf{z}) \longrightarrow \mathbf{y} \qquad \zeta : G(\mathbf{y}, \mathbf{z}) \longrightarrow \mathbf{z}$$

of the functor  $\langle F^\mu \circ \text{pr}_{\mathcal{D}}, G \rangle : \mathcal{C} \times \mathcal{D} \longrightarrow \mathcal{C} \times \mathcal{D}$ . Then the pair

$$\chi_{\mathbf{z}} : F(F^\mu(\mathbf{z}), \mathbf{z}) \longrightarrow F^\mu(\mathbf{z}) \qquad G(\xi, \mathbf{z}) \cdot \zeta : G(F^\mu(\mathbf{z}), \mathbf{z}) \longrightarrow \mathbf{z}$$

is an initial algebra of the functor  $\langle F, G \rangle : \mathcal{C} \times \mathcal{D} \longrightarrow \mathcal{C} \times \mathcal{D}$ .

*Proof.* Given an  $\langle F, G \rangle$ -algebra  $((c, d), \langle \gamma, \delta \rangle)$ , let  $\gamma^!$  be the unique arrow such that  $\chi_d \cdot \gamma^! = F(\gamma^!, d) \cdot \gamma$ . Then the pair  $((c, d), \langle \gamma^!, \delta \rangle)$  is an  $\langle F^\mu \circ \text{pr}_{\mathcal{D}}, G \rangle$ -algebra and therefore we can find a pair of arrows  $f : \mathbf{y} \longrightarrow c$  and  $g : \mathbf{z} \longrightarrow d$  satisfying the equations

$$\begin{aligned} \xi \cdot f &= F^\mu(g) \cdot \gamma^! \\ \zeta \cdot g &= G(f, g) \cdot \delta \end{aligned}$$

and unique with this property. By inspecting the two diagrams

$$\begin{array}{ccccc} F(F^\mu(\mathbf{z}), \mathbf{z}) & \xrightarrow{F(F^\mu(g), g)} & F(F^\mu(d), d) & \xrightarrow{F(\gamma^!, d)} & F(c, d) \\ \downarrow \chi_{\mathbf{z}} & & \downarrow \chi_d & & \downarrow \gamma \\ F^\mu(\mathbf{z}) & \xrightarrow{F^\mu(g)} & F^\mu(d) & \xrightarrow{\gamma^!} & c \\ \\ G(F^\mu(\mathbf{z}), \mathbf{z}) & \xrightarrow{G(\xi, \mathbf{z})} & G(\mathbf{y}, \mathbf{z}) & \xrightarrow{\zeta} & \mathbf{z} \\ \downarrow G(F^\mu(g), \mathbf{z}) & & \downarrow G(f, g) & & \downarrow g \\ G(F^\mu(d), \mathbf{z}) & \xrightarrow{G(\gamma^!, g)} & G(c, d) & \xrightarrow{\delta} & d \end{array}$$

we deduce that the relations

$$\begin{aligned} \chi_{\mathbf{z}} \cdot (F^\mu(g) \cdot \gamma^!) &= F(F^\mu(g) \cdot \gamma^!, g) \cdot \gamma \\ (G(\xi, \mathbf{z}) \cdot \zeta) \cdot g &= G(F^\mu(g) \cdot \gamma^!, g) \cdot \delta \end{aligned}$$

hold. On the other hand, suppose that

$$\begin{aligned}\chi_{\mathbf{z}} \cdot h &= F(h, k) \cdot \gamma \\ (G(\xi, \mathbf{z}) \cdot \zeta) \cdot k &= G(h, k) \cdot \delta\end{aligned}$$

hold, then  $h$  is the unique morphism of  $F(-, \mathbf{z})$ -algebras from the initial one to  $(c, F(c, k) \cdot \gamma)$ . If we take  $k$  in place of  $g$  in the first diagram, we obtain that  $F^\mu(k) \cdot \gamma^\dagger$  is also a morphism of  $F(-, \mathbf{z})$ -algebras from the initial one to  $(c, F(c, k) \cdot \gamma)$  and therefore

$$h = F^\mu(k) \cdot \gamma^\dagger.$$

The two equations

$$\begin{aligned}\xi \cdot (\xi^{-1} \cdot h) &= F^\mu(k) \cdot \gamma^\dagger \\ \zeta \cdot k &= G(\xi^{-1} \cdot h, k) \cdot \delta\end{aligned}$$

hold and show that  $\xi^{-1} \cdot h = f$  and  $k = g$ , since a pair satisfying the above relations is unique.  $\square$

The following proposition is needed to obtain the Bekič lemma in its usual form, see [22] or the pairing identity in [7, §5.3.9].

**Proposition 2.2.** *Consider two functors  $F : \mathcal{D} \longrightarrow \mathcal{C}$ ,  $G : \mathcal{C} \times \mathcal{D} \longrightarrow \mathcal{D}$ , and let  $(\mathbf{y}, \xi)$  be an initial algebra of the functor  $G(F-, -) : \mathcal{D} \longrightarrow \mathcal{D}$ . Then the pair*

$$\text{id}_{F(\mathbf{y})} : F(\mathbf{y}) \longrightarrow F(\mathbf{y}) \qquad \xi : G(F(\mathbf{y}), \mathbf{y}) \longrightarrow \mathbf{y}$$

*is an initial algebra of the functor  $\langle F \circ \text{pr}_{\mathcal{D}}, G \rangle : \mathcal{C} \times \mathcal{D} \longrightarrow \mathcal{C} \times \mathcal{D}$ . Conversely, if*

$$\chi : F(\mathbf{y}) \longrightarrow \mathbf{x} \qquad \xi : G(\mathbf{x}, \mathbf{y}) \longrightarrow \mathbf{y}$$

*is an initial algebra of the functor  $\langle F \circ \text{pr}_{\mathcal{D}}, G \rangle$ , then*

$$G(\chi, \mathbf{y}) \cdot \xi : G(F(\mathbf{y}), \mathbf{y}) \longrightarrow \mathbf{y}$$

*is an initial algebra of the functor  $G(F-, -) : \mathcal{D} \longrightarrow \mathcal{D}$ .*

*Proof.* Let  $(\langle c, d \rangle, \langle \gamma, \delta \rangle)$  be an  $\langle F \circ \text{pr}_{\mathcal{D}}, G \rangle$ -algebra and observe that if the relations

$$\begin{aligned}\text{id}_{F(\mathbf{y})} \cdot f &= Fg \cdot \gamma \\ \xi \cdot g &= G(f, g) \cdot \delta\end{aligned}$$

hold, then the relation

$$\begin{aligned}\xi \cdot g &= G(Fg \cdot \gamma, g) \cdot \delta \\ &= G(Fg, g) \cdot G(\gamma, d) \cdot \delta\end{aligned}$$

shows that  $g$  is the unique morphism of  $G(F-, -)$ -algebras from the initial one to  $(d, G(\gamma, d) \cdot \delta)$ . Since moreover  $f = Fg \cdot \gamma$ , then a pair  $(f, g)$  with these properties is uniquely determined. Hence let  $g$  be this unique morphism and let  $f = Fg \cdot \gamma$ , then

$$\begin{aligned}\xi \cdot g &= G(Fg, g) \cdot G(\gamma, d) \cdot \delta \\ &= G(Fg \cdot \gamma, g) \cdot \delta \\ &= G(f, g) \cdot \delta\end{aligned}$$

so that the pair  $(f, g)$  is the required morphism of  $\langle F \circ \mathbf{pr}_{\mathcal{D}}, G \rangle$ -algebras.

For the converse, let  $\delta : G(Fd, d) \longrightarrow d$  be a  $G(F-, -)$ -algebra and suppose that we can find an arrow  $g$  such that

$$G(\chi, \mathbf{y}) \cdot \xi \cdot g = G(Fg, g) \cdot \delta.$$

Let  $f = \chi^{-1} \cdot Fg$ , then the two relations

$$\begin{aligned}\chi \cdot f &= Fg \\ \xi \cdot g &= G(f, g) \cdot \delta\end{aligned}$$

hold, so that the pair  $(f, g)$  is a morphism of  $\langle F \circ \mathbf{pr}_{\mathcal{D}}, G \rangle$ -algebras from an initial one to  $(\langle Fd, d \rangle, \langle \mathbf{id}_{Fd}, \delta \rangle)$ . It follows that such a  $g$  is uniquely determined. On the other hand, if  $(f, g)$  is this unique morphism of  $\langle F \circ \mathbf{pr}_{\mathcal{D}}, G \rangle$ -algebras, then

$$\begin{aligned}G(\chi, \mathbf{y}) \cdot \xi \cdot g &= G(\chi, \mathbf{y}) \cdot G(f, g) \cdot \delta \\ &= G(\chi \cdot f, g) \cdot \delta \\ &= G(Fg, g) \cdot \delta,\end{aligned}$$

i.e.  $g$  is the required  $G(F-, -)$ -algebra morphism.  $\square$

The reader will have no difficulties to adapt the statements and the proofs of propositions 2.1 and 2.2 to construct a *parameterized* initial algebra of a functor  $\langle F, G \rangle : \mathcal{C} \times \mathcal{D} \times \mathcal{E} \longrightarrow \mathcal{C} \times \mathcal{D}$ , given a parameterized initial algebra  $F^\mu : \mathcal{D} \times \mathcal{E} \longrightarrow \mathcal{C}$  of the functor  $F : \mathcal{C} \times \mathcal{D} \times \mathcal{E} \longrightarrow \mathcal{C}$  and a parameterized initial algebra of the functor  $G \circ \langle F^\mu, \mathbf{id}_{\mathcal{D} \times \mathcal{E}} \rangle : \mathcal{D} \times \mathcal{E} \longrightarrow \mathcal{D}$ .

### 3 $\mu$ -Bicomplete Categories

We define  $\mu$ -bicomplete categories by mimicking the definition of  $\mu$ -algebras [26] at the level of categories:  $\mu$ -terms are defined and an algebra is a  $\mu$ -algebra if it is possible to interpret all the  $\mu$ -terms as expected. In a categorical context a  $\mu$ -term is to be interpreted as a functor, which generalizes the usual interpretation of a  $\mu$ -term as an order preserving function.

In the following definition we explicitly keep track of free variables in a  $\mu$ -term by means of a context  $X$ : this is simply a finite set (of variables). Later we shall use the notation  $\mathcal{C}^X$  to denote the  $X$ -fold product of a category  $\mathcal{C}$  with itself.

**Definition 3.1.** The set  $\mu\mathcal{T}(X)$  of  $\mu$ -terms over a context  $X$  is defined as follows:

1. For each pair  $(X, x)$ , where  $X$  is a finite set and  $x \in X$ ,  $x \in \mu\mathcal{T}(X)$ .
2. If  $I$  is a finite set and  $s : I \longrightarrow \mu\mathcal{T}(X)$ , then  $\bigwedge_I s, \bigvee_I s \in \mu\mathcal{T}(X)$ .
3. If  $s \in \mu\mathcal{T}(X)$  and  $x \in X$ , then  $\mu_x.s, \nu_x.s \in \mu\mathcal{T}(X \setminus \{x\})$ .

**Definition 3.2.** Let  $\mathcal{C}$  be a category with finite products and finite coproducts. We define a partial interpretation of  $\mu$ -terms  $s \in \mu\mathcal{T}(X)$  over a context  $X$  as functors of the form  $\|s\| : \mathcal{C}^X \longrightarrow \mathcal{C}$ .

1. For  $x \in X$ , we let  $\|x\| = \text{pr}_x : \mathcal{C}^X \longrightarrow \mathcal{C}$ .
2. We let  $\|\bigwedge_I s\| = \prod_{i \in I} \|s_i\|$  and  $\|\bigvee_I s\| = \coprod_{i \in I} \|s_i\|$ , given that all the  $\|s_i\|$  are defined.
3. We let  $\|\mu_x.s\|$  be the parameterized initial algebra of

$$\|s\| : \mathcal{C}^{\{x\}} \times \mathcal{C}^{X \setminus \{x\}} \longrightarrow \mathcal{C},$$

given that  $\|s\|$  is defined. Similarly we let  $\|\nu_x.s\|$  be the parameterized final coalgebra of  $\|s\|$ . If  $\|s\|$  is not defined or if the desired initial algebras (final coalgebras) do not exist, then we leave  $\|\mu_x.s\|$  ( $\|\nu_x.s\|$ ) undefined.

**Definition 3.3.** A category with finite products and finite coproducts  $\mathcal{C}$  is said to be  $\mu$ -bicomplete if for each finite set of variables  $X$  and  $\mu$ -term  $s \in \mu\mathcal{T}(X)$  the interpretation  $\|s\|$  is defined.

An alternative point of view emphasizes the class of functors which are definable by means of  $\mu$ -terms in a  $\mu$ -bicomplete category. Thus we are lead to give the following definition.

**Definition 3.4.** We say that a functor  $F : \mathcal{C}^X \longrightarrow \mathcal{C}^Y$  is a  $\mu$ -functor if there exist a collection of  $\mu$ -terms  $\{s_y \in \mu\mathcal{T}(X)\}_{y \in Y}$  and a natural isomorphism  $F \cong \langle \|s_y\| \rangle_{y \in Y}$ .

**Proposition 3.5.**  $\mu$ -functors are closed under composition.

*Proof.* Let  $s \in \mu\mathcal{T}(X)$  and  $z \notin X$ , we first define  $s^z \in \mu\mathcal{T}(\{z\} \cup X)$  with the property that  $\|s^z\| = \|s\| \circ \text{pr}_X$ , by induction on the structure of  $s$ . We let  $x^z = x$ ,  $(\bigwedge_I s)^z = \bigwedge_I s^z$  and  $(\bigvee_I s)^z = \bigvee_I s^z$ , where  $(s^z)_i = (s_i)^z$ ,  $(\mu_x.s)^z = \mu_x.(s^z)$  and  $(\nu_x.s)^z = \nu_x.(s^z)$ . In the last two cases we have supposed that the variable  $x \notin \{z\} \cup X$ , otherwise we can rename  $x$  in  $s$  to a variable  $x' \notin \{z\} \cup X$  and obtain a  $\mu$ -term  $t \in \mu\mathcal{T}(\{x'\} \cup X)$  such that  $\|t\| = \|s\|$  and  $\|\mu_{x'}.t\| = \|\mu_x.s\|$  and then we can define  $(\mu_x.s)^z = \mu_{x'}.(t^z)$ .

Let  $s : Y \longrightarrow \mu\mathcal{T}(X)$  be a collection of  $\mu$ -terms and let  $t \in \mu\mathcal{T}(Y)$ . We define now a  $\mu$ -term  $t[s] \in \mu\mathcal{T}(X)$  with the property that  $\|t[s]\| \cong \|t\| \circ \langle \|s_y\| \rangle_{y \in Y}$ , by induction of the structure of  $t$ . We let  $y[s] = s_y$ ,  $(\bigwedge_I t)[s] =$

$\bigwedge_I(t[s]), (\bigvee_I t)[s] = \bigvee_I(t[s])$  where  $t[s]_i = t_i[s]$ . Eventually, we let  $(\mu_x.t)[s] = \mu_x.(t[x, s^x])$  and  $(\nu_x.t)[s] = \nu_x.(t[x, s^x])$ , where  $(x, s^x) : \{x\} \cup Y \longrightarrow \mu\mathcal{T}(\{x\} \cup X)$  is such that  $(x, s^x)_y = s_y^x$  if  $y \in Y$  and  $(x, s^x)_x = x$ . We have supposed again and without loss of generality that  $x \notin X$ . The desired statement follows.  $\square$

Let  $Y$  be a set of variables and suppose that it is the disjoint union of  $X$  and  $Z$ . We can extend every collection  $s : Z \longrightarrow \mu\mathcal{T}(X)$  indexed by  $Z$  to a collection  $s' : Y \longrightarrow \mu\mathcal{T}(X)$  by letting  $s'_y = s_y$  if  $y \in Z$  and  $s'_y = y$  if  $y \in X$ . Thus if  $t \in \mu\mathcal{T}(Y)$  then we let

$$t[s_z/z]_{z \in Z} = t[s']$$

where  $t[s']$  has been defined in the proof of the above proposition. We observe that the interpretation of  $\|t[s_z/z]_{z \in Z}\|$  is

$$\mathfrak{C}^X \xrightarrow{\langle \langle \|s_z\| \rangle_{z \in Z}, \text{id}_{\mathfrak{C}^X} \rangle} \mathfrak{C}^Z \times \mathfrak{C}^X \xrightarrow{\|t\|} \mathfrak{C}$$

according to the previous proposition.

**Proposition 3.6.**  *$\mu$ -functors are closed under parameterized initial algebras and parameterized final coalgebras.*

By this property we mean that if  $F : \mathfrak{C}^Y \longrightarrow \mathfrak{C}^X$  is a  $\mu$ -functor and  $X \subseteq Y$ , so that we can represent  $\mathfrak{C}^Y$  as the product  $\mathfrak{C}^X \times \mathfrak{C}^{Y \setminus X}$ , then we can find a collection of  $\mu$ -terms  $\{t_x \in \mu\mathcal{T}(Y \setminus X)\}_{x \in X}$  so that  $\langle \|t_x\| \rangle_{x \in X} : \mathfrak{C}^{Y \setminus X} \longrightarrow \mathfrak{C}^X$  is a parameterized initial algebra of  $F$  and, similarly, it is possible to find an analogous representation for a parameterized final coalgebra of  $F$ . The proposition is an immediate consequence of the Bekić property and its dual for final coalgebras. It will also be evident from the representation of  $\mu$ -functors by means of parity functors that we describe in the next section.

We want to find concrete examples of  $\mu$ -bicomplete categories. To achieve this goal, we shall look at locally presentable categories which, in some sense, generalize complete lattices. We briefly recall the principal concepts that define these categories, their properties being described in the monographs [23, 4].

Let  $\lambda$  be a regular cardinal. A poset is  $\lambda$ -directed if every subset of cardinality less than  $\lambda$  has an upper bound. If  $D : J \longrightarrow \mathfrak{C}$  is a diagram whose index  $J$  is a  $\lambda$ -directed poset, then we say that  $D$  is  $\lambda$ -directed and that its colimit, whenever it exists, is  $\lambda$ -directed. A functor  $T : \mathfrak{C} \longrightarrow \mathfrak{D}$  is said to be  $\lambda$ -accessible if it preserves  $\lambda$ -directed colimits. An object  $c$  of a category  $\mathfrak{C}$  is  $\lambda$ -presentable if the hom-functor  $\mathfrak{C}(c, -) : \mathfrak{C} \longrightarrow \text{Set}$  is  $\lambda$ -accessible. Thus: a category  $\mathfrak{C}$  is locally  $\lambda$ -presentable if (1) it is cocomplete and (2) it has a set  $\mathcal{A}$  of  $\lambda$ -presentable objects such that every object of  $\mathfrak{C}$  is the  $\lambda$ -directed colimit of objects from  $\mathcal{A}$ . We can relax condition (1) to: (1') it has all the  $\lambda$ -directed colimits, in which case conditions (1') and (2) define a  $\lambda$ -accessible category. Finally: a functor is said to be *accessible* if it is  $\lambda$ -accessible for some regular cardinal  $\lambda$ . A category is said to be *locally presentable (accessible)* if it is locally  $\lambda$ -presentable ( $\lambda$ -accessible) for some regular cardinal  $\lambda$ .

Most of the common categories are locally presentable: the category of sets and functions, categories of presheaves and sheaves, varieties and quasivarieties of algebras. Thus, in the rest of this section, we shall prove:

**Theorem 3.7.** *Every locally presentable category is  $\mu$ -bicomplete.*

In order to show that a category  $\mathcal{C}$  is  $\mu$ -bicomplete, it suffices to find a class of functors of the form  $\mathcal{C}^J \longrightarrow \mathcal{C}$ , where  $J$  ranges on finite sets, that contains the projections and is closed under finite products, finite coproducts, and formation of parameterized initial algebras and parameterized final coalgebras. We recall the following facts about accessible functors:

- Left and right adjoints between accessible categories are accessible [4, §2.23].
- If  $\mathcal{D}$  has an initial and a final object, then a projection  $\text{pr}_{\mathcal{C}} : \mathcal{C} \times \mathcal{D} \longrightarrow \mathcal{C}$  is both a left and a right adjoint.
- Coproducts, diagonals and products are adjoints, since  $\coprod \dashv \Delta \dashv \prod : \mathcal{C}^J \longrightarrow \mathcal{C}$ .

Knowing that locally presentable categories are closed under finite products, we conclude that if  $\mathcal{C}$  is such a category, then the class of accessible functors  $F : \mathcal{C}^J \longrightarrow \mathcal{C}$  contains the projections and is closed under finite products and finite coproducts. It is well known that initial algebras and final coalgebras of  $\lambda$ -accessible unary functors exist in locally presentable categories [3, 6]; moreover if  $F : \mathcal{C} \times \mathcal{D} \longrightarrow \mathcal{C}$  is  $\lambda$ -accessible, so is the unary functor  $F(-, d) : \mathcal{C} \longrightarrow \mathcal{C}$  for each object  $d$  of  $\mathcal{D}$ . Thus, in order to conclude that locally presentable categories are  $\mu$ -bicomplete, we need the following proposition:

**Proposition 3.8.** *If  $\mathcal{C}$  and  $\mathcal{D}$  are locally presentable categories and  $F : \mathcal{C} \times \mathcal{D} \longrightarrow \mathcal{C}$  is an accessible functor, then both the parameterized initial algebra  $F^\mu : \mathcal{D} \longrightarrow \mathcal{C}$  and the parameterized final coalgebra  $F^\nu : \mathcal{D} \longrightarrow \mathcal{C}$  are accessible.*

We are thankful to Alex Simpson for pointing out the following short proof that relies on general properties of locally presentable categories and accessible functors.

*Proof.* We only prove that  $F^\nu$  is accessible, since the proof for  $F^\mu$  is dual. Consider the category  $\mathcal{E}$  with objects  $(c, d, \zeta)$ , where  $c \in \mathcal{C}$ ,  $d \in \mathcal{D}$ , and  $\zeta : c \longrightarrow F(c, d)$ , and with morphisms  $(f, g) : (c, d, \zeta) \longrightarrow (c', d', \zeta')$  being maps  $f : c \longrightarrow c'$  and  $g : d \longrightarrow d'$  such that  $\zeta \cdot F(f, g) = f \cdot \zeta'$ . Observe that there is an obvious forgetful functor  $\mathcal{E} \longrightarrow \mathcal{C} \times \mathcal{D}$  as well as a natural transformation

$$\begin{array}{ccc}
 & \mathcal{C} \times \mathcal{D} & \xrightarrow{\text{pr}_{\mathcal{C}}} \mathcal{C} \\
 \mathcal{E} & \begin{array}{c} \curvearrowright \\ \zeta \Downarrow \\ \curvearrowleft \end{array} & \\
 & \mathcal{C} \times \mathcal{D} & \xrightarrow{F} \mathcal{C}
 \end{array}$$

The 2-categorical diagram above is the inserter – cf. [20, §4] – of  $\mathbf{pr}_{\mathcal{C}}$  and  $F$  and this implies that  $\mathcal{E}$  is accessible, since accessible categories are closed under lax limits [23, §5.1.8]. Also, it is easily verified that the forgetful functor  $\mathcal{E} \rightarrow \mathcal{C} \times \mathcal{D}$  creates colimits, so that  $\mathcal{E}$  is cocomplete, hence locally presentable.

There is a functor  $G : \mathcal{D} \rightarrow \mathcal{E}$  mapping an object  $d$  of  $\mathcal{D}$  to  $(F^\nu d, d, \zeta_d)$  where  $\zeta_d : F^\nu d \rightarrow F(F^\nu d, d)$  is a final coalgebra. Then  $G$  is right adjoint to the accessible functor  $\mathcal{E} \rightarrow \mathcal{C} \times \mathcal{D} \rightarrow \mathcal{D}$ , hence  $G$  is accessible. But  $F^\nu$  is simply

$$\mathcal{D} \xrightarrow{G} \mathcal{E} \longrightarrow \mathcal{C} \times \mathcal{D} \xrightarrow{\mathbf{pr}_{\mathcal{C}}} \mathcal{C}$$

which, as a composite of accessible functors, is accessible.  $\square$

We are going to give an alternative proof of proposition 3.8, along the lines of [6]. The proof that follows will show in particular that if  $\mathcal{C}$  is a locally  $\lambda$ -presentable category, where  $\lambda > \omega$  is a regular cardinal, then the class of  $\lambda$ -accessible functors of the form  $\mathcal{C}^J \rightarrow \mathcal{C}$  is closed under formation of parameterized final coalgebras. The condition  $\lambda > \omega$  is necessary, cf. [2]: the interpretation of the  $\mu$ -term  $\nu_y.(x \vee (y \wedge y))$  in the category of sets is the functor that associates to each set  $X$  the set of infinite binary trees with leaves labeled in  $X$ . Letting  $X$  be the set  $\mathbb{N}$  of natural numbers, we observe that there are infinitely many binary trees whose leaves are labeled by an infinite subset of  $\mathbb{N}$ , thus the set of this infinite binary tree is not the inductive limit of the sets of infinite trees whose leaves are labeled by a finite subset of  $\mathbb{N}$ . Since  $\mathbb{N}$  is the inductive limit of its finite subsets, we see that this functor is not  $\omega$ -accessible.

Since it is well known that finite products are  $\lambda$ -accessible in locally  $\lambda$ -presentable categories, cf. for example [4, §1.59], this result will also imply the following fact:

**Proposition 3.9.** *If  $\lambda > \omega$ , then every  $\mu$ -functor on a locally  $\lambda$ -presentable category is  $\lambda$ -accessible.*

To prove proposition 3.8, we rely on standard properties and language of locally presentable categories, cf. [4]. We begin from initial algebras.

**Proposition 3.10.** *Let  $\mathcal{C}, \mathcal{W}$  be a locally  $\lambda$ -presentable categories and  $T : \mathcal{C} \times \mathcal{W} \rightarrow \mathcal{C}$  be a  $\lambda$ -accessible functor. Then, for each object  $w$  of  $\mathcal{W}$  an initial  $T(-, w)$ -algebra  $(\mathbf{x}_w, \chi_w)$  exists and the induced functor  $\mathbf{x} : \mathcal{W} \rightarrow \mathcal{C}$  is again  $\lambda$ -accessible.*

*Proof.* It is well known that such an initial algebra exists, see for example [3]. Let  $I$  be a  $\lambda$ -directed poset,  $w : I \rightarrow \mathcal{W}$  a functor with colimiting cocone

$$(\mathbf{in}_{w_i} : w_i \rightarrow w)_{i \in I}.$$

We shall show first that  $\text{colim } \mathbf{x}_{w_i}$  has a  $T(-, w)$ -algebra structure which is moreover initial. Recall that the arrow

$$\{T(\mathbf{in}_{\mathbf{x}_{w_i}}, \mathbf{in}_{w_i})\} : \text{colim } T(\mathbf{x}_{w_i}, w_i) \rightarrow T(\text{colim } \mathbf{x}_{w_i}, w)$$

is invertible, since  $T$  is  $\lambda$ -accessible, and thus construct a  $T(-, w)$ -algebra as follows:

$$T(\operatorname{colim} \mathbf{x}_{w_i}, w) \cong \operatorname{colim} T(\mathbf{x}_{w_i}, w_i) \xrightarrow{\operatorname{colim} \chi_{w_i}} \operatorname{colim} \mathbf{x}_{w_i}.$$

Let  $\alpha : T(a, w) \longrightarrow a$  be a  $T(-, w)$ -algebra, and, for each  $i \in I$ , form the  $T(-, w_i)$ -algebra

$$T(a, \mathbf{in}_{w_i}) \cdot \alpha : T(a, w_i) \longrightarrow T(a, w) \longrightarrow a.$$

Let  $f_i : \mathbf{x}_{w_i} \longrightarrow a$  be such that

$$\chi_{w_i} \cdot f_i = T(f_i, w_i) \cdot T(a, \mathbf{in}_{w_i}) \cdot \alpha,$$

and argue that  $f_i = \mathbf{x}_{w_{ij}} \cdot f_j$  - i.e.  $(f_i : \mathbf{x}_{w_i} \longrightarrow a)_{i \in I}$  is a cocone - by means of the following diagram

$$\begin{array}{ccccc}
 & & T(a, w_i) & & \\
 & \nearrow^{T(\mathbf{x}_{w_{ij}} \cdot f_j, w_i)} & & \searrow^{T(a, w_{ij})} & \\
 T(\mathbf{x}_{w_i}, w_i) & \xrightarrow{T(\mathbf{x}_{w_{ij}}, w_{ij})} & T(\mathbf{x}_{w_j}, w_j) & \xrightarrow{T(f_j, w_j)} & T(a, w_j) \\
 \downarrow \chi_{w_i} & & \downarrow \chi_{w_j} & & \downarrow T(a, \mathbf{in}_{w_j}) \cdot \alpha \\
 \mathbf{x}_{w_i} & \xrightarrow{\mathbf{x}_{w_{ij}}} & \mathbf{x}_{w_j} & \xrightarrow{f_j} & a
 \end{array}$$

The relation

$$\operatorname{colim} \chi_{w_i} \cdot \{f_i\} = \{T(\mathbf{in}_{\mathbf{x}_{w_i}}, \mathbf{in}_{w_i})\} \cdot T(\{f_i\}, a) \cdot \alpha,$$

is easily deduced as follows:

$$\begin{aligned}
 \mathbf{in}_{T(\mathbf{x}_{w_i}, w_i)} \cdot \operatorname{colim} \chi_{w_i} \cdot \{f_i\} & \\
 &= \chi_{w_i} \cdot f_i \\
 &= T(f_i, w_i) \cdot T(a, \mathbf{in}_{w_i}) \cdot \alpha \\
 &= T(\mathbf{in}_{\mathbf{x}_{w_i}} \cdot \{f_i\}, \mathbf{in}_{w_i}) \cdot \alpha \\
 &= T(\mathbf{in}_{\mathbf{x}_{w_i}}, \mathbf{in}_{w_i}) \cdot T(\{f_i\}, w) \cdot \alpha \\
 &= \mathbf{in}_{T(\mathbf{x}_{w_i}, w_i)} \cdot \{T(\mathbf{in}_{\mathbf{x}_{w_i}}, \mathbf{in}_{w_i})\} \cdot T(\{f_i\}, w) \cdot \alpha
 \end{aligned}$$

and hence we obtain

$$\{T(\mathbf{in}_{\mathbf{x}_{w_i}}, \mathbf{in}_{w_i})\}^{-1} \cdot \operatorname{colim} \chi_{w_i} \cdot \{f_i\} = T(\{f_i\}, w) \cdot \alpha. \quad (1)$$

On the other hand, if a relation like (1) with  $g$  in place of  $\{f_i\}$  holds, then we obtain

$$\begin{aligned}\chi_{w_i} \cdot \mathbf{in}_{\mathbf{x}_{w_i}} \cdot g &= T(\mathbf{in}_{\mathbf{x}_{w_i}}, \mathbf{in}_{w_i}) \cdot T(g, w) \cdot \alpha \\ &= T(\mathbf{in}_{\mathbf{x}_{w_i}} \cdot g, w_i) \cdot T(a, \mathbf{in}_{w_i}) \cdot \alpha\end{aligned}$$

for each  $i \in I$ . Therefore  $\mathbf{in}_{\mathbf{x}_{w_i}} \cdot g = f_i$  and  $g = \{f_i\}$ .

In order to conclude the argument, observe that for the particular case of the given initial algebra  $\chi_w : T(\mathbf{x}_w, w) \longrightarrow w$ , the  $f_i$ 's are the  $\mathbf{x}_{\mathbf{in}_{w_i}}$ 's, since  $\chi_{w_i} \cdot \mathbf{x}_{\mathbf{in}_{w_i}} = T(\mathbf{x}_{\mathbf{in}_{w_i}}, w_i) \cdot T(\mathbf{x}_w, \mathbf{in}_{w_i}) \cdot \chi_w$ . It follows that  $\{\mathbf{x}_{\mathbf{in}_{w_i}}\}$  is a morphism of  $T(-, w)$ -algebras between two initial ones, and henceforth it is invertible.  $\square$

We analyze next parameterized final coalgebras.

**Proposition 3.11.** *Let  $\lambda > \omega$  be a regular cardinal and  $T : \mathcal{C} \longrightarrow \mathcal{C}$  be a  $\lambda$ -accessible functor of a locally  $\lambda$ -presentable category. Call  $\mathcal{A}_T$  the class of  $T$ -coalgebras  $(a, \alpha)$  such that  $a$  is  $\lambda$ -presentable as an object of  $\mathcal{C}$ . Then, up to isomorphism,  $\mathcal{A}_T$  is a set and moreover it is a strong generator for the category of  $T$ -coalgebras  $\mathcal{C}_T$ .*

We observe that the above proposition does not imply that  $\mathcal{C}_T$  is locally  $\lambda$ -presentable since a coalgebra  $(a, \alpha) \in \mathcal{A}_T$  need not be  $\lambda$ -presentable in the category  $\mathcal{C}_T$ .

*Proof.* It is easily shown that  $\mathcal{A}_T$  is, up to isomorphism, a set, so that we will show that each coalgebra  $(c, \gamma)$  is the colimit of the canonical diagram  $\partial_0 : \mathcal{A}_T/(c, \gamma) \longrightarrow \mathcal{C}_T$ .

To this end, fix the coalgebra  $\gamma : c \longrightarrow Tc$ , let  $\mathcal{A}$  be the class of  $\lambda$ -presentable objects in  $\mathcal{C}$  and call  $U_c$  the lifting of the forgetful functor  $U : \mathcal{C}_T \longrightarrow \mathcal{C}$  to the comma categories:

$$\begin{array}{ccc} \mathcal{A}_T/(c, \gamma) & \xrightarrow{U_c} & \mathcal{A}/c \\ \downarrow \partial_0 & & \downarrow \partial_0 \\ \mathcal{C}_T & \xrightarrow{U} & \mathcal{C} \end{array} .$$

We shall show that the functor  $U_c$  is cofinal, from which it follows

$$\begin{aligned}c &= \operatorname{colim} \partial_0 \\ &= \operatorname{colim} (\partial_0 \circ U_c) \quad \text{since } U_c \text{ is cofinal} \\ &= \operatorname{colim} (U \circ \partial_0),\end{aligned}$$

and

$$(c, \gamma) = \operatorname{colim} \partial_0,$$

since the functor  $U : \mathcal{C}_T \longrightarrow \mathcal{C}$  creates colimits. Recall that an object of  $\mathcal{A}_T/(c, \gamma)$  is a triple  $(a, \alpha, f)$  such that  $(a, \alpha)$  is a coalgebra in  $\mathcal{A}_T$  and  $f : (a, \alpha) \longrightarrow (c, \gamma)$  is a coalgebra morphism; an arrow  $h : (a, \alpha, f) \longrightarrow (b, \beta, g)$  of  $\mathcal{A}_T/(c, \gamma)$  is a coalgebra morphism  $h : (a, \alpha) \longrightarrow (b, \beta)$  such that  $h \cdot g = f$ . The explicit description of the functor  $U_c$  is as follows: the triple  $(a, \alpha, f)$  is sent to the pair  $(a, f)$  and the arrow  $h : (a, \alpha, f) \longrightarrow (b, \beta, g)$  is sent to  $h : (a, f) \longrightarrow (b, g)$ .

We begin by showing that for a given object  $(a, f)$  of  $\mathcal{A}/c$ , we can find an object  $(b, \beta, g)$  of  $\mathcal{A}_T/(c, \gamma)$  and an arrow  $h : (a, f) \longrightarrow (b, g)$  in  $\mathcal{A}/c$ .

Recall that  $c = \text{colim } b_j$  where  $b : J \longrightarrow \mathcal{C}$  is a  $\lambda$ -directed diagram taking image in  $\mathcal{A}$ . Let  $(b_0, g_0) = (a, f)$ . Suppose that we have constructed an object  $(b_n, g_n)$  of  $\mathcal{A}/c$ , then we can construct a new object  $(g_{n+1}, b_{n+1})$  of  $\mathcal{A}/c$  and an arrow  $\beta_n : b_n \longrightarrow Tb_{n+1}$  such that the diagram

$$\begin{array}{ccc} b_n & \xrightarrow{\beta_n} & Tb_{n+1} \\ \downarrow g_n & & \downarrow Tg_{n+1} \\ c & \xrightarrow{\gamma} & Tc \end{array}$$

is commutative. This is possible, since  $b_n$  is  $\lambda$ -presentable,  $T$  is  $\lambda$ -accessible, so that  $(T\text{in}_j : Tb_j \longrightarrow Tc)_{j \in J}$  is a colimiting cocone.

Consider now the coalgebra

$$\coprod_{n \geq 0} b_n \xrightarrow{\coprod_{n \geq 0} \beta_n} \coprod_{n \geq 0} Tb_{n+1} \xrightarrow{\{T\text{in}_{b_{n+1}}\}} T(\coprod_{n \geq 0} b_n).$$

Its carrier  $\coprod_{n \geq 0} b_n$  is a  $\lambda$ -small colimit of  $\lambda$ -presentable objects, hence it is again  $\lambda$ -presentable. We are using here the fact that  $\lambda > \omega$ , so that a countable colimit of  $\lambda$ -presentable objects is again  $\lambda$ -presentable, cf. [4, §1.16].

Moreover  $\{g_n\}$  is a morphism of coalgebras to  $(c, \gamma)$ , by virtue of the following calculations:

$$\begin{aligned} \text{in}_{b_n} \cdot \left( \coprod_{n \geq 0} \beta_n \cdot \{T\text{in}_{b_{n+1}}\} \right) \cdot T\{g_n\} \\ &= \beta_n \cdot \text{in}_{Tb_{n+1}} \cdot \{T\text{in}_{b_{n+1}}\} \cdot T\{g_n\} \\ &= \beta_n \cdot T\text{in}_{b_{n+1}} \cdot T\{g_n\} \\ &= \beta_n \cdot Tg_{n+1} \\ &= g_n \cdot \gamma \\ &= \text{in}_{b_n} \cdot \{g_n\} \cdot \gamma. \end{aligned}$$

Summarizing, let  $b = \coprod_{n \geq 0} b_n$ ,  $\beta = \coprod_{n \geq 0} \beta_n \cdot \{T\text{in}_{b_{n+1}}\}$ ,  $g = \{g_n\}$ ,  $h = \text{in}_{b_0}$ , then  $(b, \beta, g)$  is the desired object of  $\mathcal{A}_T/(c, \gamma)$  and  $h : (a, f) \longrightarrow (b, g)$  is the desired arrow of  $\mathcal{A}/c$ , since  $\text{in}_{b_0} \cdot \{g_n\} = g_0 = f$ .

We show now that given two arrows  $h_i : (a, f) \longrightarrow U_c(b_i, \beta_i, g_i)$ ,  $i = 1, 2$ , we can find an object  $(d, \delta, k)$  and two arrows  $l_i : (b_i, \beta_i, g_i) \longrightarrow (d, \delta, k)$  such that  $h_1 \cdot l_1 = h_2 \cdot l_2$ . We are given the diagram

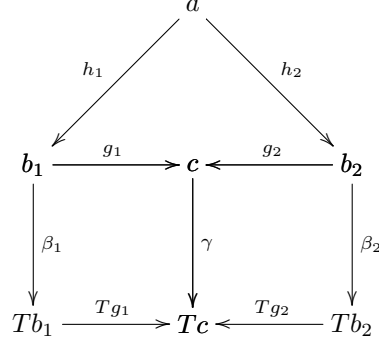

where  $f = h_1 \cdot g_1 = h_2 \cdot g_2$ . Form the pushouts from  $a$  to obtain the diagram:

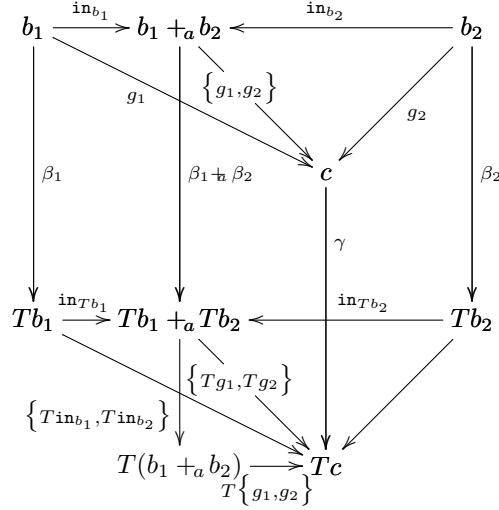

We let  $d = b_1 +_a b_2$ ,  $\delta = \beta_1 +_a \beta_2 \cdot \{T\text{in}_{b_1}, T\text{in}_{b_2}\}$ ,  $k = \{g_1, g_2\}$ , then  $(d, \delta, k)$  is an object of  $\mathcal{A}_T/(c, \gamma)$ :

$$\begin{aligned}
 \delta \cdot Tk &= \beta_1 +_a \beta_2 \cdot \{T\text{in}_{b_1}, T\text{in}_{b_2}\} \cdot T\{g_1, g_2\} \\
 &= \beta_1 +_a \beta_2 \cdot \{Tg_1, Tg_2\} \\
 &= \{g_1, g_2\} \cdot \gamma \\
 &= k \cdot \gamma.
 \end{aligned}$$

On the other hand, for  $i = 1, 2$ , we let  $l_i = \text{in}_{b_i}$ . Then  $l_i : (b_i, \beta_i, g_i) \longrightarrow (d, \delta, k)$

is a morphism in  $\mathcal{A}_T/(c, \gamma)$ :

$$\begin{aligned}
\mathbf{in}_{b_i} \cdot \delta &= \mathbf{in}_{b_i} \cdot (\beta_1 +_a \beta_2 \cdot \{T\mathbf{in}_{b_1}, T\mathbf{in}_{b_2}\}) \\
&= \beta_i \cdot \mathbf{in}_{Tb_i} \cdot \{T\mathbf{in}_{b_1}, T\mathbf{in}_{b_2}\} \\
&= \beta_i \cdot T\mathbf{in}_{b_i}, \\
\mathbf{in}_i \cdot k &= \mathbf{in}_i \cdot \{g_1, g_2\} \\
&= g_i.
\end{aligned}$$

Finally  $h_1 \cdot l_1 = h_2 \cdot l_2 : (a, f) \longrightarrow (d, k)$  is a commutative diagram in  $\mathcal{A}/c$ .  $\square$

**Proposition 3.12.** *Let  $\mathcal{C}, \mathcal{W}$  be locally  $\lambda$ -presentable categories and  $T : \mathcal{C} \times \mathcal{W} \longrightarrow \mathcal{C}$  be a  $\lambda$ -accessible functor,  $\lambda$  being a regular cardinal strictly greater than  $\omega$ . Then for each object  $w$  of  $\mathcal{W}$  a final  $T(-, w)$ -coalgebra  $(\mathbf{x}_w, \chi_w)$  exists and the induced functor  $\mathbf{x} : \mathcal{W} \longrightarrow \mathcal{C}$  is again  $\lambda$ -accessible.*

*Proof.* The existence of the final coalgebras  $(\mathbf{x}_w, \chi_w)$  has been proved for example in [6]. Let  $J$  be a  $\lambda$ -directed poset and  $w : J \longrightarrow \mathcal{W}$  be functor with limiting cocone

$$(\mathbf{in}_{w_j} : w_j \longrightarrow w)_{j \in J}.$$

The arrows  $\chi_{w_j} : \mathbf{x}_{w_j} \longrightarrow T(\mathbf{x}_{w_j}, w_j)$  are natural in  $j$ , so that we can take their colimit to construct the  $T(-, w)$ -coalgebra

$$\text{colim } \mathbf{x}_{w_j} \xrightarrow{\text{colim } \chi_{w_j}} \text{colim } T(\mathbf{x}_{w_j}, w_j) \xrightarrow{\{T(\mathbf{in}_{\mathbf{x}_{w_j}}, \mathbf{in}_{w_j})\}} T(\text{colim } \mathbf{x}_{w_j}, w).$$

We claim that this is a final  $T(-, w)$ -coalgebra. To prove the claim it is enough to show that if a the carrier of a  $T(-, w)$ -coalgebra  $(a, \alpha)$  is  $\lambda$ -presentable in  $\mathcal{C}$ , then there exists a unique coalgebra morphism into the coalgebra defined above. Indeed, we have shown that  $\mathcal{A}_{T(-, w)}$  is a strong generator for the category of  $T(-, w)$ -coalgebras, so that the claim follows by considering that every object of  $\mathcal{C}_{T(-, w)}$  is a colimit of objects from  $\mathcal{A}_{T(-, w)}$ .

Consider therefore a coalgebra  $(a, \alpha)$  in  $\mathcal{A}_{T(-, w)}$ . Then we can factor  $\alpha$  as  $\alpha_j \cdot T(a, \mathbf{in}_{w_j})$  for some  $j \in J$ , since  $(T(a, \mathbf{in}_{w_j}) : T(a, w_j) \longrightarrow T(a, w))_{j \in J}$  is a colimiting cone, the functor  $T(a, -)$  being  $\lambda$ -accessible. Let  $f_j$  be such that  $f_j \cdot \chi_{w_j} = \alpha_j \cdot T(f_j, w_j)$ , then  $f_j \cdot \mathbf{in}_{\mathbf{x}_{w_j}}$  is a morphism of coalgebras, as shown

in the next diagram:

$$\begin{array}{ccccc}
a & \xrightarrow{f_j} & \mathbf{x}_{w_j} & \xrightarrow{\mathbf{in}_{\mathbf{x}_{w_j}}} & \text{colim } \mathbf{x}_{w_j} \\
\downarrow \alpha_j & & \downarrow \chi_{w_j} & & \downarrow \text{colim } \chi_{w_j} \\
T(a, w_j) & \xrightarrow{T(f_j, w_j)} & T(\mathbf{x}_{w_j}, w_j) & \xrightarrow{\mathbf{in}_{T(\mathbf{x}_{w_j}, w_j)}} & \text{colim } T(\mathbf{x}_{w_j}, w_j) \\
\downarrow T(a, \mathbf{in}_{w_j}) & & \downarrow T(\mathbf{x}_{w_j}, \mathbf{in}_{w_j}) & & \downarrow \{T(\mathbf{in}_{\mathbf{x}_{w_j}}, \mathbf{in}_{w_j})\} \\
T(a, w) & \xrightarrow{T(f_j, w)} & T(\mathbf{x}_{w_j}, w) & \xrightarrow{T(\mathbf{in}_{\mathbf{x}_{w_j}}, w)} & T(\text{colim } \mathbf{x}_{w_j}, w)
\end{array}$$

$\alpha$   $\curvearrowright$  (curved arrow from  $a$  to  $T(a, w)$ )

On the other hand, suppose that  $\alpha \cdot T(f, w) = f \cdot \text{colim } \chi_{w_j} \cdot \{T(\mathbf{in}_{\mathbf{x}_{w_j}}, \mathbf{in}_{w_j})\}$  and choose liftings  $\alpha_i$  and  $f_j$  of  $\alpha$  and  $f$  respectively, as usual, since  $a$  is  $\lambda$ -presentable. Moreover, since  $J$  is directed, we can assume that  $i = j$ .

Recall that

$$(T(\mathbf{in}_{\mathbf{x}_{w_j}}, \mathbf{in}_{w_j}) : T(\mathbf{x}_{w_j}, w_j) \longrightarrow T(\text{colim } \mathbf{x}_{w_j}, w))_{j \in J}$$

is a colimiting cocone, hence  $f_j \cdot \chi_{w_j}$  and  $\alpha_j \cdot T(f_j, w_j)$  are two different liftings of the same arrow to this colimit:

$$\begin{aligned}
\alpha \cdot T(f, w) &= \alpha_j \cdot T(a, \mathbf{in}_{w_j}) \cdot T(f_j, w) \cdot T(\mathbf{in}_{\mathbf{x}_{w_j}}, w) \\
&= \alpha_j \cdot T(f_j, w_j) \cdot T(\mathbf{in}_{\mathbf{x}_{w_j}}, \mathbf{in}_{w_j}) \\
\alpha \cdot T(f, w) &= f \cdot \text{colim } \chi_{w_j} \cdot \{T(\mathbf{in}_{\mathbf{x}_{w_j}}, \mathbf{in}_{w_j})\} \\
&= f_j \cdot \mathbf{in}_{\mathbf{x}_{w_j}} \cdot \text{colim } \chi_{w_j} \cdot \{T(\mathbf{in}_{\mathbf{x}_{w_j}}, \mathbf{in}_{w_j})\} \\
&= f_j \cdot \chi_{w_j} \cdot T(\mathbf{in}_{\mathbf{x}_{w_j}}, \mathbf{in}_{w_j}).
\end{aligned}$$

Therefore there exists a  $k \in J$  such that  $j \leq k$  and moreover such that

$$f_j \cdot \chi_{w_j} \cdot T(\mathbf{x}_{w_{jk}}, w_{jk}) = \alpha_j \cdot T(f_j, w_j) \cdot T(\mathbf{x}_{w_{jk}}, w_{jk}).$$

By naturality of  $\chi$ , we have

$$\chi_{w_j} \cdot T(\mathbf{x}_{w_{jk}}, w_{jk}) = \mathbf{x}_{w_{jk}} \cdot \chi_{w_k},$$

and therefore we obtain the relation

$$f_j \cdot \mathbf{x}_{w_{jk}} \cdot \chi_{w_k} = \alpha_j \cdot T(a, w_{jk}) \cdot T(f_j \cdot \mathbf{x}_{w_{jk}}, w_k).$$

We conclude that  $f_j \cdot \mathbf{x}_{w_{jk}}$  is uniquely determined as the unique  $T(-, w_k)$ -coalgebra morphism from  $\alpha_j \cdot T(a, w_{jk})$  to the final one, and consequently also

$f$  is uniquely determined, because of

$$\begin{aligned} f &= f_j \cdot \mathbf{in}_{\mathbf{x}_{w_j}} \\ &= f_j \cdot \mathbf{x}_{w_j k} \cdot \mathbf{in}_{\mathbf{x}_{w_k}}. \end{aligned}$$

In order to conclude the argument it is enough to show  $\{\mathbf{x}_{\mathbf{in}_{w_j}}\}$  is a morphism of  $T(-, w)$ -algebras between two initial ones:

$$\begin{aligned} &\mathbf{in}_{\mathbf{x}_{w_i}} \cdot \{\mathbf{x}_{\mathbf{in}_{w_j}}\} \cdot \chi_w \\ &= \mathbf{x}_{\mathbf{in}_{w_j}} \cdot \chi_w \\ &= \chi_{w_j} \cdot T(\mathbf{x}_{\mathbf{in}_{w_j}}, \mathbf{in}_{w_j}) \\ &= \chi_{w_j} \cdot T(\mathbf{in}_{\mathbf{x}_{w_i}} \cdot \{\mathbf{x}_{\mathbf{in}_{w_j}}\}, \mathbf{in}_{w_j}) \\ &= \chi_{w_j} \cdot T(\mathbf{in}_{\mathbf{x}_{w_i}}, \mathbf{in}_{w_i}) \cdot T(\{\mathbf{x}_{\mathbf{in}_{w_j}}\}, w) \\ &= \chi_{w_j} \cdot \mathbf{in}_{T(\mathbf{x}_{w_i}, w_i)} \cdot \{T(\mathbf{in}_{\mathbf{x}_{w_j}}, \mathbf{in}_{w_j})\} \cdot T(\{\mathbf{x}_{\mathbf{in}_{w_j}}\}, w) \\ &= \mathbf{in}_{\mathbf{x}_{w_i}} \cdot \text{colim } \chi_{w_j} \cdot \{T(\mathbf{in}_{\mathbf{x}_{w_j}}, \mathbf{in}_{w_j})\} \cdot T(\{\mathbf{x}_{\mathbf{in}_{w_j}}\}, w), \end{aligned}$$

so that  $\{\mathbf{x}_{\mathbf{in}_{w_j}}\}$  is invertible.  $\square$

## 4 Parity Games as Functors

We have argued that  $\mu$ -functors are closed under parameterized initial algebras: by the Bekiĉ property, it becomes possible to construct initial solutions of systems of functorial equations by means of  $\mu$ -terms. The arising algebraic expressions representing the solution of a system are however large in the dimension of the system and are not unique. Moreover, a large algebraic expression could be useless for understanding its denotation in concrete categories. For this reason we would like to have some kind of “smooth” terms for the theory of  $\mu$ -bicomplete categories. These terms should have a compact representation and possibly they should be suggestive of their semantics. To achieve this goal, the central notion is that of parity game, cf. for example [35, 5]. We define it here in a slightly generalized way.

**Definition 4.1.** A *parity game* is a tuple  $G = \langle S, h, \kappa, \epsilon \rangle$ , where

- $S = \langle \partial_0, \partial_1 : M \longrightarrow P \rangle$  is a finite graph of positions and moves.
- $h : P \longrightarrow \{1, \dots, n, \omega\}$  is a function such that, if  $h(p) = \omega$ , then  $\{m \mid \partial_0(m) = p\} = \emptyset$ .
- $\kappa : \{1, \dots, n\} \longrightarrow \{\mu, \nu\}$ .
- $\epsilon : \{p \in P \mid h(p) \neq \omega\} \longrightarrow \{\sigma, \pi\}$ .

We fix some terminology and notation. If  $h : P \longrightarrow \{1, \dots, n, \omega\}$ , then we shall say that  $n$  is the *height* of  $G$  and write  $\text{hg}(G) = n$ . For each  $p \in P$ , we let

$M_p$  be the set  $\partial_0^{-1}(p)$ . We let  $P_i = h^{-1}(i)$ ,  $P_{<i} = \bigcup_{j<i} P_j$ ,  $P_{\leq i} = \bigcup_{j\leq i} P_j$  for  $i \in \{1, \dots, n, \omega\}$ . We shall also use the notation  $P_{\geq i}$  for the set  $\bigcup_{j\geq i} P_j$ . Unless specified we will assume that the underlying structure of a given parity game  $G$  is the tuple  $\langle S, h, \kappa, \epsilon \rangle$ ,  $S$  being the graph  $\langle P, M, \partial_0, \partial_1 \rangle$ . A pointed parity game is a pair  $\langle G, p \rangle$  where  $G$  is a parity game and  $p \in P$ .

We interpret the above data as a two person game  $G(E)$ , parameterized in a choice of sets  $E = \{E_x\}_{x \in P_\omega}$ . The graph  $S$  is a board with a set of positions  $P$  and a set of allowed moves  $M$ . A move  $m \in M$  is from position  $\partial_0(m)$  to position  $\partial_1(m)$ ; observe that we allow different moves relating the same pair of positions; also, the two players need not to alternate. From a position  $p$  the set of moves  $M_p$  is available and player  $\epsilon(p)$  among players  $\sigma$  and  $\pi$  must choose how to move. The normal play condition holds: if a player cannot move, then he loses. On an infinite play  $\gamma = \gamma_0 \rightarrow \gamma_1 \rightarrow \dots \gamma_n \rightarrow \dots$  we will be able to find regions among  $P_1, \dots, P_n$  which are visited infinitely often, and among them we will be able to pick a region  $P_i$  with  $i$  maximal. Then, this infinite path is a win for player  $\sigma$  if and only if  $i$  is colored by  $\nu$ . More formally, if we let

$$\text{In } \gamma = \{i \in \{1, \dots, n\} \mid \text{card}\{l \mid h(\gamma_l) = i\} = \omega\}, \quad (2)$$

then  $\gamma$  is a win for player  $\sigma$  if and only if

$$\kappa(\max \text{In } \gamma) = \nu.$$

If a play ends in a position  $x \in P_\omega$ , then player  $\sigma$  must choose an element  $e \in E_x$ , and then he wins. If  $E_x = \emptyset$ , then he loses.

We remark that if  $P_\omega = \emptyset$ , then the above data and game theoretic interpretation coincide with the usual one [5, §4]. From a game theoretic point of view, we are allowed to normalize the functions  $h$  and  $\kappa$ , so that we can always suppose that  $\kappa(i) = \nu$  if and only if  $i$  is odd. In this case an infinite play  $\gamma$  is a win for player  $\sigma$  if and only if the region visited infinitely often in  $\gamma$  of maximal height is odd, whence the name of ‘‘parity game’’.

In the theory of automata recognizing infinite objects the way of specifying a set of infinite paths in a graph is called an acceptance condition. The acceptance condition by which we specify the set of infinite winning plays for player  $\sigma$  was introduced by Mostowski in [25] and is also known as a Rabin chain condition. Under the hypothesis that  $\kappa(i) = \nu$  if and only if  $i$  is odd and that  $\text{hg}(G) = 2n$ , we can let  $F_k = P_{\geq 2k-1}$  and  $E_k = P_{\geq 2k}$  for  $k = 1, \dots, n$ . These sets form a decreasing chain and moreover the pairs  $(F_k, E_k)_{k=1, \dots, n}$  are Rabin pairs for the set of infinite winning plays for player  $\sigma$ , meaning that an infinite path  $\gamma$  is a win for player  $\sigma$  if and only if there exists  $k \in \{1, \dots, n\}$  such that  $\text{In } \gamma \cap F_k \neq \emptyset$  and  $\text{In } \gamma \cap E_k = \emptyset$ . There are other ways of characterizing this acceptance condition by means of Muller tables [24], but we won’t investigate this subject further. On the other hand we recall that parity games are essential tools for model checking. For example, it is shown in [13] that the problem of deciding whether player  $\sigma$  has a winning strategy from a given position of a parity game is equivalent – under linear reduction – to the problem of deciding whether a  $\mu$ -calculus formula holds in a given model.

The goal of adding positions at infinite height is to make it possible to analyze parity games inductively. The main tool for this is the predecessor game of a parity game, whose construction we illustrate in figure 1. The game on the right is obtained from the one on the left by erasing all the moves from the region of maximal finite height.

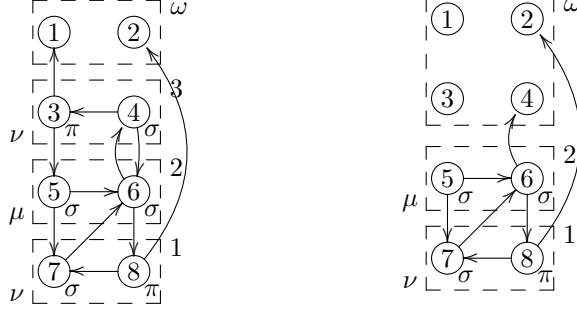

Figure 1: On the left a parity game, on the right its predecessor game.

**Definition 4.2.** If  $G = \langle S, h, \kappa, \epsilon \rangle$  is a parity game of height  $n > 0$ , then its predecessor game  $P(G)$ , of height  $n - 1$ , is obtained from  $G$  by erasing all the moves from  $P_n$ . More precisely,  $P(G) = \langle S', h', \kappa', \epsilon' \rangle$ , where:

- $S' = \langle \partial_0, \partial_1 : \partial_0^{-1}(P_{<n}) \longrightarrow P \rangle$ .
- $h'(p) = h(p)$  if  $h(p) < n$ , otherwise  $h'(p) = \omega$ .
- For  $i \in \{1, \dots, n - 1\}$ , we let  $\kappa'(i) = \kappa(i)$ .
- If  $h'(p) < n$ , then we let  $\epsilon'(p) = \epsilon(p)$ .

In the following we shall endow the data defining a parity game with an algebraic meaning. We let  $\mathcal{C}$  be a fixed category with finite products and finite coproducts. If  $G$  is a parity game, then for each  $p \in P_{<\omega}$  we let

$$\begin{aligned} \text{pr}(\partial_1, p) &= \langle \text{pr}_{\partial_1(m)} \rangle_{m \in M_p} & : \mathcal{C}^P &\longrightarrow \mathcal{C}^{M_p} \\ \mathcal{E}_p &= \begin{cases} \prod \circ \text{pr}(\partial_1, p), & \epsilon(p) = \pi \\ \coprod \circ \text{pr}(\partial_1, p), & \epsilon(p) = \sigma \end{cases} & : \mathcal{C}^P &\longrightarrow \mathcal{C}. \end{aligned}$$

For  $k = 1, \dots, \text{hg}(G)$  we let

$$\mathcal{E}_k = \langle \mathcal{E}_p \rangle_{p \in P_k} : \mathcal{C}^P \longrightarrow \mathcal{C}^{P_k}$$

and finally we let  $\mathcal{E}_G = \mathcal{E}_{\text{hg}(G)}$ .

**Definition 4.3.** We define a partial correspondence  $\| - \|$ , mapping a parity game  $G$  to a functor  $\| G \| : \mathcal{C}^{P_\omega} \longrightarrow \mathcal{C}^{P_{<\omega}}$ , by induction on the height, as follows. If  $\text{hg}(G) = 0$ , then  $P_{<\omega} = \emptyset$  so that there is a unique choice of  $\| G \|$ . Suppose that  $\text{hg}(G) = n > 0$  and that  $\| P(G) \|$  is defined. Let

$$F = \| P(G) \| \circ \text{pr}_{\mathcal{C}^{P_n} \times \mathcal{C}^{P_\omega}},$$

and consider the functor

$$\mathcal{C}^{P_{<n}} \times \mathcal{C}^{P_n} \times \mathcal{C}^{P_\omega} \xrightarrow{\langle F, \mathcal{E}_G \rangle} \mathcal{C}^{P_{<n}} \times \mathcal{C}^{P_n}.$$

If  $\kappa(n) = \mu$ , then we let  $\| G \|$  be the parameterized initial algebra of the above functor, otherwise, if  $\kappa(n) = \nu$ , we let  $\| G \|$  be its parameterized final coalgebra. If  $\| P(G) \|$  is undefined or if the required initial algebras or final coalgebras do not exist, then  $\| G \|$  is undefined. We say that  $\mathcal{C}$  is *complete with respect to parity games* if for each parity game  $G$ , the functor  $\| G \| : \mathcal{C}^{P_\omega} \longrightarrow \mathcal{C}^{P_{<\omega}}$  is defined.

Whenever the functor  $\| G \| : \mathcal{C}^{P_\omega} \longrightarrow \mathcal{C}^{P_{<\omega}}$  is defined, it is useful to extend it to a functor  $| G | : \mathcal{C}^{P_\omega} \longrightarrow \mathcal{C}^P$ , in the obvious way, by setting

$$| G | = \langle \| G \|, \text{id}_{\mathcal{C}^{P_\omega}} \rangle : \mathcal{C}^{P_\omega} \longrightarrow \mathcal{C}^{P_{<\omega}} \times \mathcal{C}^{P_\omega}.$$

Observe that, according to proposition 2.2, the functor  $\text{pr}_{\text{hg}(G)} \circ \| G \|$  is a parameterized initial algebra (or final coalgebra) of the functor  $\mathcal{E}_G \circ | P(G) |$ . Moreover, according to the same proposition, the value of  $\| G \|$  is completely determined up to natural isomorphism by  $\text{pr}_{\text{hg}(G)} \circ \| G \|$  and  $\| P(G) \|$ . Hence, in order to prove that  $\| G \|$  and  $\| H \|$  are naturally isomorphic, it is enough to prove that  $\mathcal{E}_G$  and  $\mathcal{E}_H$  are naturally isomorphic, that  $\kappa(\text{hg}(G)) = \kappa(\text{hg}(H))$ , and that  $\| P(G) \|$  is naturally isomorphic to  $\| P(H) \|$ .

**Definition 4.4.** We say that a functor  $F : \mathcal{C}^I \longrightarrow \mathcal{C}^J$  is a *parity functor* if it is naturally isomorphic to a functor of the form  $\text{pr}_J \circ | G |$ , where  $G$  is a parity game such that  $P_\omega = I$  and  $J \subseteq P$  is a subset of positions.

If in the previous lemma  $I = \{p\}$  is a singleton, we will use the notation  $| G |_p$  for the functor  $\text{pr}_p \circ | G |$ .

In the following two lemmas, needed in the proof of proposition 4.12, we exemplify how game theoretical ideas lift to the algebra. In 4.5 we introduce two constructions which respectively introduce and eliminate holes in the height. The first construction is exemplified in figure 2. In 4.7 and 4.8 we show that regions of contiguous heights can always be assumed to be non empty and have different colors  $\{\mu, \nu\}$ . These constructions are shown to be algebraic invariants.

In the following definition, let  $\hat{i} : \{1, \dots, n\} \longrightarrow \{1, \dots, n+1\}$  be the unique order preserving injection which avoids  $i \in \{1, \dots, n+1\}$ .

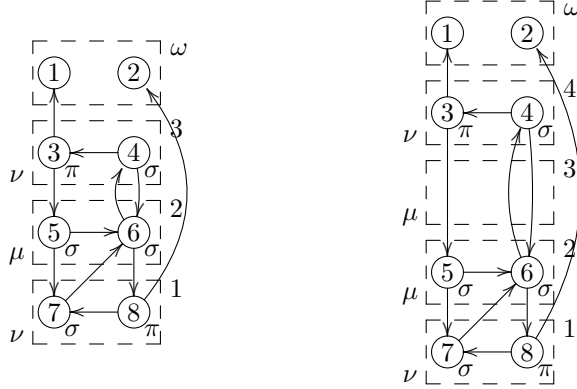

Figure 2: A game  $G$  on the left and the game  $G_{3,\mu}$  on the right.

**Definition 4.5.** Let  $G = \langle S, h, \kappa, \epsilon \rangle$  and suppose that  $\text{hg}(G) = n$ .

- For  $i = 1, \dots, n + 1$  and  $\theta \in \{\mu, \nu\}$ , we define  $G_{i,\theta} = \langle S, h_i, \kappa_{i,\theta}, \epsilon \rangle$  by letting  $h_i = h \cdot \hat{i}$  and  $\kappa_{i,\theta}(j) = \kappa(j)$  if  $j < i$ ,  $\kappa_{i,\theta}(i) = \theta$  and  $\kappa_{i,\theta}(j) = \kappa(j - 1)$  if  $j > i$ .
- We define  $G_\bullet = \langle S, h_\bullet, \kappa_\bullet, \epsilon \rangle$  as follows: we let  $h_\bullet \cdot j$  be the unique factorization of  $h$  such that  $h_\bullet : P \setminus P_\omega \longrightarrow \{1, \dots, k\}$  is surjective and  $j : \{1, \dots, k\} \hookrightarrow \{1, \dots, n\}$  is injective and order preserving; we let  $\kappa_\bullet = j \cdot \kappa$ .

Observe that  $\text{hg}(G_{i,\theta}) = n + 1$  and that, in the game  $G_\bullet$ ,  $P_j \neq \emptyset$  for  $j = 1, \dots, \text{hg}(G_\bullet)$ .

**Lemma 4.6.** *There exist natural isomorphisms  $\|G\| \cong \|G_{i,\theta}\|$  and  $\|G\| \cong \|G_\bullet\|$ .*

*Proof.* The isomorphism  $\|G_{n+1,\mu}\| \cong \|G\|$  follows by observing that  $P(G_{n+1,\mu}) = G$  and by letting  $\mathcal{C}$  be  $\mathcal{C}^{P_{\leq n}}$ ,  $\mathcal{D} = \mathcal{C}^{P_{n+1}} = \mathcal{C}^\emptyset = 1$ ,  $\mathcal{E} = \mathcal{C}^{P_\omega}$  in proposition 2.2: the left projection of  $\|G_{n+1,\mu}\| : \mathcal{C}^{P_\omega} \longrightarrow \mathcal{C}^{P_{\leq n}} \times 1$  is computed as  $\|G\|$ . An analogous observation shows that there is an isomorphism  $\|G_{n+1,\nu}\| \cong \|G\|$ .

If  $i \leq n$ , then we can reason by induction on the height, observing that  $P(G_{i,\theta}) = P(G)_{i,\theta}$  and  $\mathcal{E}_{G_{i,\theta}} = \mathcal{E}_G$ , so that  $\mathcal{E}_{G_{i,\theta}} \circ |P(G_{i,\theta})|$  and  $\mathcal{E}_G \circ |P(G)|$  are naturally isomorphic.

On the other hand, we argue that  $\|G\|$  and  $\|G_\bullet\|$  are naturally isomorphic as follows:  $j$  can be factored by a sequence of the functions  $\hat{i}$ , hence  $G$  can be obtained from  $G_\bullet$  by a sequence of the operations  $(-)_i,\theta$  and the result follows from our previous considerations.  $\square$

**Definition 4.7.** We say that a parity game  $G$  is *normalized* if  $\kappa(i) \neq \kappa(i + 1)$  for  $i = 1, \dots, \text{hg}(G) - 1$  and  $P_i \neq \emptyset$  for  $i = 1, \dots, \text{hg}(G)$ .

**Lemma 4.8.** *For each parity game  $G$  there exists a normalized parity game  $N(G)$  on the same set of positions of  $G$  such that  $\|G\| \cong \|N(G)\|$ .*

*Proof.* Let  $G = \langle S, h, \kappa, \epsilon \rangle$  be a game with  $\text{hg}(G) = n + 1 > 1$ . We first define a game  $G_N$ . If  $\kappa(n + 1) = \kappa(n)$ , then we let  $G_N = \langle S, h_N, \kappa, \epsilon \rangle$ , where  $h_N(p) = n$  if  $h(p) = n + 1$  and otherwise  $h_N(p) = h(p)$ . To verify that  $\|G\|$  is isomorphic to  $\|G_N\|$ , observe that  $P(G_N) = P(P(G))$  and that  $\mathcal{E}_{G_N} = \langle \mathcal{E}_{P(G)}, \mathcal{E}_G \rangle$  and therefore let  $F = \langle \|P(P(G))\| \circ \text{pr}_{P_{\geq n}}, \mathcal{E}_{P(G)} \rangle$  and  $G = \mathcal{E}_G$  in the statement of the Bekić property 2.1. Otherwise, if  $\kappa(n + 1) \neq \kappa(n)$ , then we let  $G_N = G$ .

We define then  $N(G)$  by induction on the height. If  $\text{hg}(G) \leq 1$ , then  $N(G) = G$ . Otherwise, in order to obtain  $N(G)$ , we first construct  $N(P(G))$ , and then a game  $G'$  by adding to the region of maximal height of  $G$  transitions so that  $\mathcal{E}_{G'} = \mathcal{E}_G$ . As the last step, we let  $N(G) = G'_N$ . By induction, it is shown that  $\|N(G)\| = \|G\|$ .  $\square$

The following theorem is the main result of this section and generalizes to categories the well known fact that a vectorial  $\mu$ -calculus has no more expressive power of its scalar version [5, §2.7].

**Theorem 4.9.** *A category is  $\mu$ -bicomplete with respect to parity games if and only if it is  $\mu$ -bicomplete.*

In order to prove the theorem we translate parity functors into collections of  $\mu$ -terms and vice-versa we represent  $\mu$ -terms by pointed parity games. To show that this translation is sound the main tool is the Bekić property discussed in section 2.3.

**Proposition 4.10.** *For each parity game  $G$  we can find a collection of  $\mu$ -terms  $\{s_p\}_{p \in P}$ , such that  $s_p \in \mu\mathcal{T}(P_\omega)$  and*

$$|G| := \langle \|s_p\| \rangle_{p \in P}.$$

The meaning of the symbol  $:=$  is that the functorial expression on the right determines the existence of the functorial expression on the left. That is, natural transformations (needed as projections, injections and as the structure part of initial algebras or final coalgebras) can be constructed out of the natural transformations given with the interpretations of the  $\mu$ -terms, so that the functorial expression on the right together with these new natural transformations have the universal property that determines the left-hand side of the equation up to canonical isomorphism. Thus it follows:

**Corollary 4.11.** *If  $\mathcal{C}$  is a  $\mu$ -bicomplete category, then  $\mathcal{C}$  is complete w.r.t. parity games.*

*Proof of proposition 4.10.* Clearly, it is enough to find a collection of  $\mu$ -terms indexed by  $P_{<\omega}$  such that  $\|G\| := \langle \|s_p\| \rangle_{p \in P_{<\omega}}$ , since then we can complete this collection to a collection representing  $|G|$ , by letting  $s_p$  be the  $\mu$ -term  $p \in \mu\mathcal{T}(P_\omega)$  if  $p \in P_\omega$ .

If  $\text{hg}(G) = 0$ , then the statement is true since  $P_{<\omega} = \emptyset$  and the empty collection of terms satisfies the requirements.

Suppose that  $\text{hg}(G) = n > 0$  and that that  $\kappa(n) = \mu$ . An analogous argument works if  $\kappa(n) = \nu$ .

By the induction hypothesis there are  $\mu$ -terms  $\{s_p\}_{p \in P}$  with  $s_p \in \mu\mathcal{T}(P_n \cup P_\omega)$  such that  $|P(G)| = \langle \|s_p\| \rangle_{p \in P}$ . According to proposition 2.2, we can construct the functor  $\|G\|$  by means of  $\mu$ -terms, provided we are able to show that the functor  $\mathcal{E}_G \circ |P(G)|$  admits a parameterized initial algebra which is representable by means of  $\mu$ -terms. We prove this by induction on the cardinality of  $P_n$ . If  $P_n = \emptyset$ , then there is nothing to prove. Otherwise, pick  $p_0 \in P$ , let  $P'_n = P_n \setminus \{p_0\}$  and represent the functor  $\mathcal{E}_G$  as  $\langle \mathcal{E}_{P'_n}, \mathcal{E}_{p_0} \rangle$  where  $\mathcal{E}_{P'_n} = \langle \mathcal{E}_p \rangle_{p \in P'_n}$ . We claim that an initial algebra of the functor  $\mathcal{E}_{P'_n} \circ |P(G)|$  exists and is constructible by means of  $\mu$ -terms. Indeed a parity game  $G' = \langle S', h', \kappa', \epsilon' \rangle$  on the same set of positions and with the same height as  $G$ , such that  $\kappa'(i) = \kappa(i)$  for  $i = 1, \dots, \text{hg}(G)$ ,  $P(G') = P(G)$ ,  $h'(p) = n$  if and only if  $p \in P'_n$  and  $\mathcal{E}_{G'} = \mathcal{E}_{P'_n}$ , is easily constructed out of  $G$ . Since  $\text{card } P'_n < \text{card } P_n$  by the induction hypothesis we have a desired representation of  $\|G'\|$  by  $\mu$ -terms  $t_p \in \mu\mathcal{T}(\{p_0\} \cup P_\omega)$ , for  $p \in P_{\leq n} \setminus \{p_0\}$ . It follows that  $\langle \|t_p\| \rangle_{p \in P'_n}$  is the desired representation of the initial algebra of  $\mathcal{E}_{P'_n} \circ |P(G)|$ , since by proposition 2.2  $\text{pr}_{P'_n} \circ |G'|$  is an initial algebra for  $\mathcal{E}_{G'} \circ |P(G')| = \mathcal{E}_{P'_n} \circ |P(G)|$ .

Let  $s : M_{p_0} \longrightarrow \mu\mathcal{T}(P_n \cup P_\omega)$  be the function defined by the relation

$$s(m) = s_{\partial_1 m}$$

and let  $u \in \mu\mathcal{T}(P_n \cup P_\omega)$  be the  $\mu$ -term defined as

$$u = \begin{cases} \bigwedge_{M_{p_0}} s, & \epsilon(p_0) = \pi \\ \bigvee_{M_{p_0}} s, & \epsilon(p_0) = \sigma, \end{cases}$$

then

$$\mathcal{E}_{p_0} \circ |P(G)| = \|u\| : \mathcal{C}^{P_n} \times \mathcal{C}^{P_\omega} \longrightarrow \mathcal{C}.$$

We can now construct an initial algebra of  $\mathcal{E}_G \circ |P(G)|$  according to the Bekić property. Let

$$v_{p_0} = \mu_{p_0} \cdot (u[t_p/p]_{p \in P'_n})$$

and for  $p \in P'_n$  let

$$v_p = t_p[v_{p_0}/p_0]$$

then the functor  $\langle \|v_p\| \rangle_{p \in P_n}$  carries a canonical structure of an initial algebra for the functor  $\mathcal{E}_{P_n} \circ |P(G)|$ .  $\square$

**Proposition 4.12.** *For each  $\mu$ -term  $s \in \mu\mathcal{T}(X)$  there exists a pointed parity game  $\langle G, p \rangle$  such that  $P_\omega = X$  and*

$$\|s\| := |G|_p.$$

Again, the meaning of the symbol  $:=$  is that the functorial expression on the right can be endowed with a structure so that it has the universal property which determines the left-hand side of the equation up to canonical isomorphism. Thus it follows:

**Corollary 4.13.** *If  $\mathcal{C}$  is a category complete w.r.t. parity games, then  $\mathcal{C}$  is  $\mu$ -bicomplete.*

**Lemma 4.14.** *Let  $G$  be a parity game, we define  $G^{p_0}$  to be the game obtained from  $G$  by adding a new position  $p_0$  to set of position at infinity  $P_\omega$ . Then there exists a natural isomorphism  $\|G^{p_0}\| \cong \|G\| \circ \mathbf{pr}_{\mathcal{C}^{P_\omega}}$ .*

*Proof.* The observation is obvious if  $\text{hg}(G) = 0$ . On the other hand, if  $\text{hg}(G) > 0$ , then  $P(G^{p_0}) = P(G)^{p_0}$  and  $\|P(G^{p_0})\| \cong \|P(G)\| \circ \mathbf{pr}_{n,\omega}$ , by induction. Moreover  $\mathcal{E}_{G^{p_0}} = \mathcal{E}_G \circ \mathbf{pr}_P$ , so that  $\|G^{p_0}\|$  is defined to be the initial algebra of the functor  $\langle \|P(G)\| \circ \mathbf{pr}_{n,\omega} \circ \mathbf{pr}_{n,\omega,p_0}, \mathcal{E}_{G^{p_0}} \rangle = \langle \|P(G)\| \circ \mathbf{pr}_{n,\omega}, \mathcal{E}_G \rangle \circ \mathbf{pr}_P$ . In order to conclude the argument, observe that the parameterized initial algebra of a functor of the form  $F \circ \mathbf{pr}_{\mathcal{C} \times \mathcal{D}} : \mathcal{C} \times \mathcal{D} \times \mathcal{E} \longrightarrow \mathcal{C}$  has the form  $F^\mu \circ \mathbf{pr}_{\mathcal{D}}$ , where  $F^\mu : \mathcal{D} \longrightarrow \mathcal{C}$  is the parameterized initial algebra of  $F : \mathcal{C} \times \mathcal{D} \longrightarrow \mathcal{C}$ .  $\square$

*Proof of proposition 4.12.* By induction on the structure of  $\mu$ -terms.

For the  $\mu$ -term  $x$  in context  $X$ , we let  $G$  be the parity game of height 0 on the set of positions  $X$ , with distinguished position  $x \in X$ .

We analyze now the case of a term of the form  $\bigwedge_I s$ . By duality, we implicitly analyze the case of a term of the form  $\bigvee_I s$ .

We first show that given a parity game  $G = \langle S, h, \kappa, \epsilon \rangle$  and a subset  $I \subseteq P$  of positions, it is possible to find a pointed parity game  $\langle G', p_0 \rangle$  such that  $|G'|_{p_0} \cong \prod_{i \in I} |G|_i$ . We define  $G' = \langle S', h', \kappa', \epsilon' \rangle$  as follows:  $S'$  is obtained from  $S$  by adding a new position  $p_0$  and moves  $p_0 \rightarrow i$  for each  $i \in I$ ,  $h'(p_0) = \text{hg}(G) + 1$  and  $h'(p) = h(p)$  otherwise,  $\kappa'(\text{hg}(G) + 1) = \mu$ , and  $\kappa'(j) = \kappa(j)$  if  $j \leq \text{hg}(G)$ ,  $\epsilon'(p_0) = \pi$  and  $\epsilon'(p) = \epsilon(p)$  otherwise. We could also have set  $\kappa'(\text{hg}(G) + 1) = \nu$ , leading to an equivalent construction.

Observe that  $P(G') = G^{p_0}$ , therefore

$$\begin{aligned} \|P(G')\| \circ \mathbf{pr}_{\mathcal{C}^{P'_\omega}} &= \|G^{p_0}\| \circ \mathbf{pr}_{\mathcal{C}^{\{p_0\}} \times \mathcal{C}^{P_\omega}} \\ &\cong \|G\| \circ \mathbf{pr}_{\mathcal{C}^{P_\omega}} \circ \mathbf{pr}_{\mathcal{C}^{\{p_0\}} \times \mathcal{C}^{P_\omega}} \\ &\cong \|G\| \circ \mathbf{pr}_{\mathcal{C}^{P_\omega}} \circ \mathbf{pr}_{\mathcal{C}^{P < \omega} \times \mathcal{C}^{P_\omega}}, \end{aligned}$$

and remark that an initial algebra for  $\|G\| \circ \mathbf{pr}_{\mathcal{C}^{P_\omega}}$  is exactly  $\|G\|$ . Similarly

$$\begin{aligned} \mathcal{E}_{p_0} &= \prod \circ \mathbf{pr}(\partial_1, p_0) \\ &\cong \left( \prod_{i \in I} \right) \circ \mathbf{pr}_{\mathcal{C}^{P < \omega} \times \mathcal{C}^{P_\omega}}. \end{aligned}$$

Using proposition 2.2 (switch the roles of  $F$  and  $G$ ), compute an initial algebra of a functor of the form  $\langle F \circ \mathbf{pr}_{\mathcal{C} \times \mathcal{E}}, G \circ \mathbf{pr}_{\mathcal{C} \times \mathcal{E}} \rangle : \mathcal{C} \times \mathcal{D} \times \mathcal{E} \longrightarrow \mathcal{C} \times \mathcal{D}$  as  $\langle F^\mu, G \circ F^\mu \rangle$ ,  $F^\mu$  being the initial algebra of  $F$ . In this formula let  $F$  be

$\|G\| \circ \mathbf{pr}_{\mathcal{C}^{P_\omega}}$  and  $G$  be  $(\prod_{i \in I})$ . It follows that  $|G'|_{p_0}$ , the right projection in this formula, is  $|G'|_{p_0} = \mathbf{pr}_{p_0} \circ \|G'\| \cong \prod_{i \in I} \circ \mathbf{pr}_i \circ \|G\| = \prod_{i \in I} |G|_i$ .

We come back to the original problem of finding a representation of the functor  $\bigwedge_I s$  as a parity functor. Observing that we have solved the case of representing  $\bigwedge_\emptyset$  in the previous discussion, we can suppose without loss of generality that  $I = \{l, r\}$ . Let  $\langle G^l, p^l \rangle, \langle G^r, p^r \rangle$  be two pointed parity games representing  $s_l$  and  $s_r$  respectively. Hence  $G^l$  and  $G^r$  share the same set of positions at infinity  $P_\omega = X$ . Because of lemmas 4.8 and 4.6, we can assume that  $\text{hg}(G^l) = \text{hg}(G^r) = n$  and that  $\kappa(i) = \mu$  if and only if  $i$  is odd for each  $i = 1, \dots, n$ . Given these assumptions, we can construct a game  $\{G^l, G^r\}$  of height  $n$ , having as set of positions the disjoint union of the sets  $P_\omega, P_{<\omega}^l, P_{<\omega}^r$ , by pasting together the local structures of  $G^l$  and  $G^r$ . Recall that, for a pair of functors  $F : \mathcal{C} \times \mathcal{E} \rightarrow \mathcal{C}$  and  $G : \mathcal{D} \times \mathcal{E} \rightarrow \mathcal{D}$ , a pair of initial algebras  $(F^\mu, \chi)$  and  $(G^\mu, \xi)$  gives rise to the algebra  $(\langle F^\mu, G^\mu \rangle, \langle \chi, \xi \rangle)$  of the functor  $\langle F \circ \mathbf{pr}_{\mathcal{C} \times \mathcal{E}}, G \circ \mathbf{pr}_{\mathcal{D} \times \mathcal{E}} \rangle : \mathcal{C} \times \mathcal{D} \times \mathcal{E} \rightarrow \mathcal{C} \times \mathcal{D}$ , which is moreover an initial one. Then it is easily verified that the relation

$$\|\{G^l, G^r\}\| \cong \langle \|G^l\|, \|G^r\| \rangle : \mathcal{C}^{P_\omega} \longrightarrow \mathcal{C}^{P_{<\omega}^l} \times \mathcal{C}^{P_{<\omega}^r}$$

holds. In this way we have reduced the problem of finding a representation of the  $\mu$ -functor  $\|s_l \wedge s_r\|$  to the problem of finding a representation of the functor  $\prod_{i \in \{p^l, p^r\}} |G^i|_i$  by a pointed parity game, which we have previously solved. Figure 3 displays the construction of the pointed parity game associated to  $s_l \wedge s_r$ .

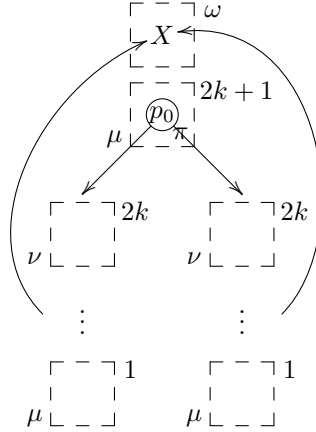

Figure 3: Pointed parity game for  $s_l \wedge s_r$ .

Finally, we analyze the case of a term  $\mu_x.s$ . By duality, we implicitly analyze the case of a term of the form  $\nu_x.s$ .

Let  $\langle G, p_0 \rangle$  be a parity game such that  $|G|_{p_0} \cong \|s\|$ . Define the game  $G' = \langle S', h', \kappa', \epsilon' \rangle$  as follows:

- $S'$  is obtained from  $S$  by adding the move  $x \rightarrow p_0$ .
- $h'(x) = \text{hg}(G) + 1$  and  $\kappa'(\text{hg}(G) + 1) = \mu$ , otherwise  $h'(p) = h(p)$  and  $\kappa'(i) = \kappa(i)$  if  $p \neq x$  and  $i \leq \text{hg}(G)$ .
- $\epsilon'(x) = \sigma$  and  $\epsilon'(p) = \epsilon(p)$  if  $p \neq x$ .

Observe that  $P(G') = G$  and recall that  $|G'|_x$  is the parameterized initial algebra of the functor in the top composite of the diagram below:

$$\begin{array}{ccccc}
\mathcal{C} \times \mathcal{C}^{X \setminus \{x\}} & \xrightarrow{|P(G')|} & \mathcal{C}^{P_{<\omega}} \times \mathcal{C}^X & & \\
\downarrow |G| & & \downarrow \text{pr}(\partial_1, x) & \searrow \mathcal{E}_x & \\
\mathcal{C}^{P_{<\omega}} \times \mathcal{C}^X & \xrightarrow{\text{pr}_{p_0}} & \mathcal{C} & \xrightarrow{\Pi} & \mathcal{C}
\end{array}$$

Thus deduce that  $|G'|_x$  is also the initial algebra of the functor  $\Pi \circ |G|_{p_0}$ . Since this functor is naturally isomorphic to  $|G|_{p_0}$  and therefore to  $\|s\|$ , we obtain the relation  $\|\mu_{x \cdot s}\| := |G'|_x$ .  $\square$

## 5 Parity Functors in the Category of Sets

We recall the game-theoretic interpretation of a parity game  $G = \langle S, h, \kappa, \epsilon \rangle$ , as a two person game  $G(E)$ , parameterized in a choice of sets  $E = \{E_x\}_{x \in P_\omega}$ . The graph  $S = \langle P, M, \partial_0, \partial_1 \rangle$  is a board with a set of positions  $P$  and a set of allowed moves  $M$ . A move  $m \in M$  is from position  $\partial_0(m)$  to position  $\partial_1(m)$ ; the graph  $S$  has multiple edges, hence distinct moves relating the same pair of positions are allowed. From a position  $p$ , the set of moves  $M_p = \partial_0^{-1}(p)$  is available, and player  $\epsilon(p)$  among players  $\sigma$  and  $\pi$  must choose how to move. If he cannot move, then he loses. An infinite play  $\gamma_0 \rightarrow \gamma_1 \rightarrow \dots \gamma_n \rightarrow \dots$  is a win for player  $\sigma$  if and only if  $\kappa(\max \text{In } \gamma) = \nu$ , the set  $\text{In } \gamma$  being defined by equation (2). If a play ends in a position  $x \in P_\omega$ , then player  $\sigma$  must choose an element  $e \in E_x$  and then he wins; if  $E_x = \emptyset$ , then he loses.

A typical element of an inductively defined set is a kind of finite tree; on the other hand, a typical element of a coinductively defined set is a kind of infinite tree. We shall see that a similar tree-like representation is available for parity functors on the category of sets.

**Definition 5.1.** Let  $\langle S, s_0 \rangle$  be a pointed graph, a *tree*  $T$  over  $\langle S, s_0 \rangle$  is a non-empty collection of finite paths  $\gamma$  in  $S$  such that  $\partial_0 \gamma = s_0$ , which is moreover closed under prefixes: if  $\gamma_1 \star \gamma_2 \in T$ , then  $\gamma_1 \in T$ .

Observe that a tree  $T$  over  $\langle S, s_0 \rangle$  is itself a graph if we set  $\gamma \rightarrow \gamma'$  if and only if  $\gamma' = \gamma \star m$  for some  $m \in M_{\partial_1 \gamma}$ ; moreover  $\partial_1 : T \longrightarrow S$  is a morphism of graphs. In particular it makes sense to talk about an infinite path in  $T$ .

**Definition 5.2.** Let  $G$  be a parity game and let  $E = \{E_x\}_{x \in P_\omega}$  be a collection of sets. A *deterministic winning strategy* for player  $\sigma$  from position  $p \in P$  in the game  $G(E)$  is a pair  $\langle T, \lambda \rangle$  where  $T$  is a tree over  $\langle S, p \rangle$  with the following properties:

- If  $\gamma \in T$ ,  $\epsilon(\partial_1 \gamma) = \pi$  and  $m \in M_{\partial_1 \gamma}$ , then  $\gamma \star m \in T$ .
- If  $\gamma \in T$  and  $\epsilon(\partial_1 \gamma) = \sigma$ , then there exists a unique  $m \in M_{\partial_1 \gamma}$  such that  $\gamma \star m \in T$ .
- Every infinite path in the tree  $T$  is a win for player  $\sigma$ , that is, if  $\gamma : \hat{\omega} \longrightarrow T$ , then  $\kappa(\max \text{In}(\gamma \cdot \partial_1)) = \nu$ .

On the other hand,  $\lambda$  is a labeling of paths  $\gamma \in T$  such that  $\partial_1 \gamma \in P_\omega$  by an element  $e = \lambda(\gamma) \in E_{\partial_1 \gamma}$ . We let  $\mathcal{S}_{G,p}(E)$  be the set of deterministic winning strategies for player  $\sigma$  in the game  $G(E)$  from position  $p$ .

We shall often use  $\tau[S], \ell[S]$  for the tree and the label of a strategy  $S$ , so that  $S = \langle \tau[S], \ell[S] \rangle$ . If  $\langle T, \lambda \rangle, \langle R, \rho \rangle \in \mathcal{S}_{G,p}(E)$ , then we shall write  $\langle T, \lambda \rangle \subseteq \langle R, \rho \rangle$  to mean that  $T \subseteq R$  and  $\lambda(\gamma) = \rho(\gamma)$  for all  $\gamma \in T$  such that  $\partial_1 \gamma \in P_\omega$ .

**Lemma 5.3.** *If  $\langle T, \lambda \rangle \subseteq \langle R, \rho \rangle$ , then  $T = R$  and  $\lambda = \rho$ .*

*Proof.* By induction on the length of  $\gamma \in R$ . If  $\#\gamma = 0$ , then  $\gamma = 1_p$ . Since  $T$  is non empty,  $1_p \star \gamma' \in T$ , hence  $1_p \in T$  ( $1_p$  belongs always to a winning strategy from position  $p$ ). If  $\#\gamma = n + 1$ , then we can write  $\gamma = \gamma' \star m$  where  $\#\gamma' = n$ . Since  $\gamma' \in R$ , by the induction hypothesis  $\gamma' \in T$  as well. If  $\epsilon(\partial_1 \gamma') = \pi$ , then  $\gamma' \star m' \in T$  for each  $m' \in M_{\partial_1 \gamma'}$ , in particular  $\gamma = \gamma' \star m \in T$ . If  $\epsilon(\partial_1 \gamma') = \sigma$ , then there exists  $m' \in M_{\partial_1 \gamma'}$  such that  $\gamma' \star m' \in T$ . This implies that  $\gamma' \star m', \gamma' \star m \in R$  and  $m = m'$ , since  $R$  is deterministic. Therefore  $\gamma' \star m \in T$ . Finally, let  $\gamma \in R$  be such that  $\partial_1 \gamma \in P_\omega$ . Since we have seen that  $\gamma \in T$ , it follows that  $\rho(\gamma) = \lambda(\gamma)$ .  $\square$

Observe that  $\mathcal{S}_{G,p}$  is a functor from the category  $\text{Set}^{P_\omega}$  to  $\text{Set}$ , the category of sets and functions. Given a collection of functions  $\{f_x : E_x \longrightarrow F_x\}_{x \in P_\omega}$ , we can transform a strategy  $\langle T, \lambda \rangle \in \mathcal{S}_{G,p}(E)$  into the strategy  $\langle T, f_{\partial_1} \circ \lambda \rangle \in \mathcal{S}_{G,p}(F)$ , where

$$(f_{\partial_1} \circ \lambda)(\gamma) = f_{\partial_1 \gamma}(\lambda(\gamma)).$$

Thus, we denote by  $\mathcal{S}_G : \text{Set}^{P_\omega} \longrightarrow \text{Set}^{P_{\leq n}}$  the functor whose  $p$ -projection is  $\mathcal{S}_{G,p}$ , i.e.  $\mathcal{S}_G(E) = \langle \mathcal{S}_{G,p}(E) \rangle_{p \in P_{\leq n}}$ . The following theorem is the main result of this section.

**Theorem 5.4.** *The equality*

$$\|G\|(E) := \mathcal{S}_G(E)$$

*holds.*

The equality above means that the collection of sets of deterministic winning strategies satisfies the universal property involved in the definition of the parity functor, so that it can be taken to be a concrete representation of the functor. This equality is reminiscent of the formula of the Propositional Modal  $\mu$ -Calculus which describes the set of winning position for player  $\sigma$  in a parity game, cf. [12, 34].

In the rest of this section we prove theorem 5.4. This is done by induction on the height, observing that it holds in an obvious way if the height of  $G$  is 0. Thus we shall suppose in the following that  $\text{hg}(G) = n > 0$  and that the statement holds for the predecessor game  $P(G)$ . To develop the proof, we shall need a modified version of the predecessor game that does not completely forget about the structure in the region of maximal finite height. The delooping game, displayed on the left in figure 4, is devised to detect first passages through the region of maximal finite height in a parity game.

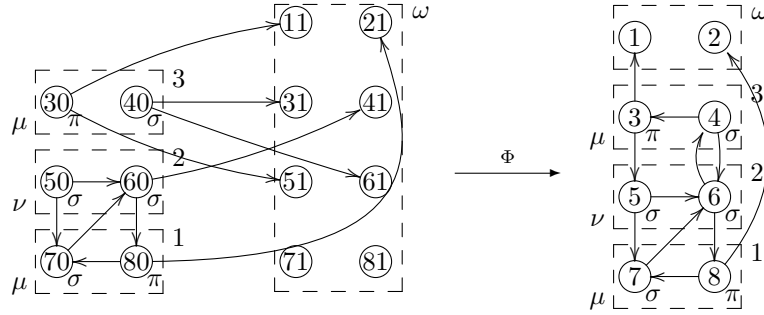

Figure 4: The delooping game of a parity game.

**Definition 5.5.** The *delooping game*  $D(G) = \langle S', h', \kappa', \epsilon' \rangle$  of a parity game  $G$  is defined as follows:

- $S'$  is the graph whose set of positions is  $P_{\leq n} \times \{0\} + P \times \{1\}$ . For each move  $m : p \rightarrow p'$  there is a move  $(m, 0) : (p, 0) \rightarrow (p', i)$ , where  $i = 1$  if and only if  $p' = \partial_1 m \in P_n \cup P_\omega$  or  $p = \partial_0 m \in P_n$ .
- $h'(p, 0) = h(p)$  and  $h(p, 1) = \omega$ .
- $\kappa'(i) = \kappa(i)$  for  $i = 1, \dots, n = \text{hg}(D(G)) = \text{hg}(G)$ .
- $\epsilon'(p, 0) = \epsilon(p)$ .

The delooping game  $D(G)$  comes with a morphism of graphs  $\Phi : S' \longrightarrow S$ , defined by  $\Phi(p, i) = p$  and  $\Phi(m, 0) = m$ .

The domain of the functor  $\mathcal{S}_{D(G)}$  is the category  $\text{Set}^{P_{\leq n} \times \{1\}} \times \text{Set}^{P_\omega \times \{1\}}$  and its codomain is the category  $\text{Set}^{P_{\leq n} \times \{0\}}$ . Under the obvious isomorphisms  $P \cong P \times \{1\}$  and  $P_{\leq n} \cong P_{\leq n} \times \{0\}$  we shall look at this functor as having the shape

$$\mathcal{S}_{D(G)} : \text{Set}^{P_{\leq n}} \times \text{Set}^{P_\omega} \longrightarrow \text{Set}^{P_{\leq n}} .$$

**Lemma 5.6.** *There is a natural isomorphism*

$$\mathcal{S}_{D(G)} \cong \langle \mathcal{S}_{P(G)} \circ \text{pr}_{P_n \cup P_\omega}, \mathcal{E}_G \rangle.$$

*Proof.* Let  $\{E_x\}_{x \in P}$  be a collection of sets. Observe that from a position  $(p, 0)$  with  $p \in P_{<n}$  the game  $D(G)(E)$  is exactly as the game  $P(G)(E')$ ,  $E'$  being the collection  $\{E_x\}_{x \in P_n \cup P_\omega}$ . On the other hand, if  $p \in P_n$  then a strategy from position  $(p, 0)$  in  $D(G)(E)$  is given by the choice of a tuple  $\{e_m \in E_{\partial_1 m}\}_{m \in M_p}$  if  $\epsilon(p) = \pi$ , or by the choice of a pair  $(e, m)$  with  $m \in M_p$  and  $e \in E_{\partial_1 m}$  if  $\epsilon(p) = \sigma$ .  $\square$

Therefore, by the previous lemma and by the induction hypothesis  $\|P(G)\| \cong \mathcal{S}_{P(G)}$ , in order to prove theorem 5.4 it is enough to show that the collection of sets  $\mathcal{S}_G(E)$  carries an invertible algebra structure for the functor  $\mathcal{S}_{D(G)}(-, E)$ , and that this structure leads to an initial algebra if  $\kappa(n) = \mu$  and to a final coalgebra if  $\kappa(m) = \nu$ .

Observe that an infinite play  $\delta$  is a win for player  $\sigma$  in  $D(G)$  if and only if  $\Phi\delta$  is an infinite winning play for player  $\sigma$  in  $G$ . Then, it is informally seen that a winning strategy  $\langle R, \rho \rangle$  for player  $\sigma$  from a position  $(p, 0)$  in  $D(G)(\mathcal{S}_G(E), E)$  gives rise to a strategy from position  $p$  in  $G(E)$  as follows: player  $\sigma$  uses  $\langle R, \rho \rangle$  as far as he can, by identifying a position  $p$  to the position  $(p, 0)$ ; if this is not anymore possible, since a position of the form  $(p', 1)$  with  $p' \in P_{\leq n}$  has been reached by means of a play  $\delta \in R$ , then player  $\sigma$  continues according to the strategy  $\rho(\delta) \in \mathcal{S}_{G, p'}(E)$ . Moreover, every winning strategy from  $p$  in  $G(E)$  arises in this way. We formalize these ideas next.

**Definition 5.7.**

- A path  $\delta$  of  $D(G)$  is called an *atom* if  $\#\delta > 0$ ,  $\partial_1 \delta \in P'_\omega$  and  $\partial_1 \Phi\delta \in P_{\leq n}$ . If  $R$  is a set of paths in  $D(G)$ , then we shall write  $A(R)$  for the set of atoms of  $R$ .
- Let  $\delta$  be a path of  $G$  and let  $T$  be a collection of paths of  $G$  with domain  $\partial_1 \delta$ . By  $\delta \star T$  we mean the set  $\{\delta \star \gamma \mid \gamma \in T\}$ .
- Let  $\langle T, \lambda \rangle \in \mathcal{S}_{G, p}(E)$  and  $\delta \in T$ . By  $\delta \setminus \langle T, \lambda \rangle$  we denote the winning strategy  $\langle T', \lambda' \rangle \in \mathcal{S}_{G, \partial_1 \delta}(E)$  where  $T'$  is the set  $\{\gamma \mid \delta \star \gamma \in T\}$  and  $\lambda'(\gamma) = \lambda(\delta \star \gamma)$  if  $\gamma \in T'$  and  $\partial_1 \gamma \in P_\omega$ . We call this strategy *the residual strategy* of  $\langle T, \lambda \rangle$  after the path  $\delta$ .

**Lemma 5.8.** *The pair  $\langle T', \lambda' \rangle = \delta \setminus \langle T, \lambda \rangle$  is a winning strategy for player  $\sigma$  in the game  $G(E)$  from position  $\partial_1 \delta$ .*

*Proof.* Let  $\gamma \in T'$ . If  $\partial_1 \gamma \in P_{\leq n}$ , then  $\partial_1(\delta \star \gamma) = \partial_1 \gamma \in P_{\leq n}$  as well. If  $\epsilon(\partial_1 \gamma) = \pi$ , then  $\delta \star \gamma \star m \in T$  and  $\gamma \star m \in T'$  for all  $m \in M_{\partial_1 \gamma}$ . If  $\epsilon(\partial_1 \gamma) = \sigma$ , then there exists an  $m \in M_{\partial_1 \gamma}$  such that  $\delta \star \gamma \star m \in T$ , and henceforth  $\gamma \star m \in T'$ . If  $\gamma \star m' \in T'$ , then  $\delta \star \gamma \star m' \in T$  and therefore  $m = m'$ . Let  $\gamma$  be an infinite

path in  $T'$ , then  $\delta \star \gamma$  is an infinite path in  $T$  and since  $\text{In}(\gamma) = \text{In}(\delta \star \gamma)$  we see that

$$\begin{aligned} \kappa(\max \text{In}(\gamma)) &= \kappa(\max \text{In}(\delta \star \gamma)) \\ &= \nu. \end{aligned}$$

□

**Definition 5.9.** We define an algebra

$$\chi : \mathcal{S}_{D(G)}(\mathcal{S}_G(E), E) \longrightarrow \mathcal{S}_G(E)$$

in the following way. If  $\langle R, \rho \rangle \in \mathcal{S}_{D(G)}(\mathcal{S}_G(E), E)$ , then we let  $\chi_p(R, \rho) = \langle R_\bullet, \rho_\bullet \rangle$  where

$$\begin{aligned} R_\bullet &= \Phi R \cup \bigcup_{\delta \in A(R)} \Phi \delta \star \tau[\rho(\delta)], \\ \rho_\bullet(\gamma) &= \begin{cases} \rho(\delta), & \gamma = \Phi \delta, \delta \in R, \\ \ell[\rho(\delta)](\gamma'), & \gamma = (\Phi \delta) \star \gamma', \delta \in A(R), \end{cases} \end{aligned}$$

if  $\gamma \in R_\bullet$  and  $\partial_1 \gamma \in P_\omega$ .

**Lemma 5.10.**  $\chi_p(R, \rho)$  is a winning strategy for player  $\sigma$  in the game  $G(E)$  from position  $p$ .

*Proof.* Let  $\gamma \in R_\bullet$  be such that  $\partial_1 \gamma \in P_{\leq n}$ . Either  $\gamma = \Phi \delta$  where  $\delta \in R$  is not an atom, or  $\gamma = \Phi \delta \star \gamma'$  where  $\delta \in A(R)$  and  $\gamma' \in \tau[\rho(\delta)]$ . Similarly, an infinite path  $\gamma$  in  $R_\bullet$  is either the image of infinite path in  $R$  or it is of the form  $\gamma = \Phi \delta \star \gamma'$  where  $\delta \in A(R)$  and  $\gamma'$  is an infinite path in  $\tau[\rho(\delta)]$ . The desired properties of  $R_\bullet$  follow then from the properties of  $R$  and from the properties of  $\rho(\delta)$ , respectively. For example, let  $\gamma = \Phi \delta$  where  $\delta \in R$  is not an atom. Suppose that  $\epsilon(\partial_1 \Phi \delta) = \sigma$  and observe that  $\epsilon(\partial_1 \delta) = \sigma$  as well, since  $\delta$  is not an atom. Hence we can find  $m \in M_{\partial_1 \delta}$  such that  $\delta \star m \in R$  and therefore  $\Phi \delta \star \Phi m \in R_\bullet$ . If  $\Phi \delta \star m' \in R_\bullet$ , then we can find  $\delta'$  such that  $\Phi \delta' = \Phi \delta \star m'$ . It follows that  $\delta' = \delta \star m''$ , where  $\Phi m'' = m'$ . Since  $R$  is deterministic,  $m'' = m$  and hence  $m' = \Phi m$ . □

**Definition 5.11.** We define a coalgebra

$$\xi : \mathcal{S}_G(E) \longrightarrow \mathcal{S}_{D(G)}(\mathcal{S}_G(E), E)$$

in the following way. If  $\langle T, \lambda \rangle \in \mathcal{S}_G(E)$ , then we let  $\xi_p(T, \lambda) = \langle T^\bullet, \lambda^\bullet \rangle$  where

$$\begin{aligned} T^\bullet &= \{ \delta \mid \Phi\delta \in T \} \\ \lambda^\bullet(\delta) &= \begin{cases} \lambda(\Phi\delta), & \partial_1\Phi\delta \in P_\omega, \\ \Phi\delta \setminus \langle T, \lambda \rangle, & \partial_1\Phi\delta \in P_{\leq n}, \end{cases} \end{aligned}$$

if  $\delta \in T^\bullet$  and  $\partial_1\delta \in P'_\omega$ .

**Lemma 5.12.**  $\xi_p(T, \lambda)$  is a winning strategy for player  $\sigma$  from position  $p$  in the game  $D(G)(\mathcal{S}_G(E), E)$ .

*Proof.* Let  $\delta \in T^\bullet$  and suppose that  $m \in M_{\partial_1\delta}$  and  $\epsilon(\partial_1\delta) = \pi$ . Then  $\epsilon(\partial_1\Phi\delta) = \pi$ , so that  $\Phi\delta \star \Phi m \in T$  and thus  $\delta \star m \in T^\bullet$ . If  $\epsilon(\partial_1\delta) = \sigma$ , then  $\delta$  is not an atom. Since  $\epsilon(\partial_1\Phi\delta) = \sigma$ , there exists an  $m$  such that  $\Phi\delta \star m \in T$ . Since  $\delta$  is not an atom, the move  $m$  can be lifted to a move  $m' \in M_{\partial_1\delta}$  such that  $\Phi m' = m$ . It follows that  $\delta \star m' \in T^\bullet$ . If  $\delta \star m'' \in T^\bullet$ , then  $\Phi m'' = m$ , since  $T$  is deterministic, and therefore  $m'' = m'$  since a lifting of  $m$  is unique. Finally, an infinite path  $\delta$  in  $T^\bullet$  gives rise to an infinite path  $\Phi\delta$  in  $T$ , which is a win for player  $\sigma$  in the game  $G$ . From this it follows that  $\delta$  is win for player  $\sigma$  in  $D(G)$ .  $\square$

**Proposition 5.13.** The functions  $\chi_p$  and  $\xi_p$  are inverse to each other.

*Proof.* Let  $\langle R, \rho \rangle \in \mathcal{S}_{D(G),p}(\mathcal{S}_G(E), E)$  and  $\langle T, \lambda \rangle \in \mathcal{S}_{G,p}(E)$ . We shall show that

$$\langle R, \rho \rangle \subseteq \xi_p(T, \lambda) \quad \text{iff} \quad \chi_p(R, \rho) \subseteq \langle T, \lambda \rangle.$$

The desired result will follow from lemma 5.3.

Suppose first that  $\langle R, \rho \rangle \subseteq \xi_p(T, \lambda)$ . Thus  $R \subseteq \Phi^{-1}T$  and  $\Phi R \subseteq T$ , and if  $\delta \in R$  is an atom, then  $\rho(\delta) = \lambda^\bullet(\delta) = \Phi\delta \setminus \langle T, \lambda \rangle$ . Hence

$$\begin{aligned} R_\bullet &= \Phi R \cup \bigcup_{\delta \in A(R)} \Phi\delta \star \tau[\Phi\delta \setminus \langle T, \lambda \rangle] \\ &\subseteq T. \end{aligned}$$

Consider a path  $\gamma \in R_\bullet$  such that  $\partial_1\gamma \in P_\omega$ . If  $\gamma = \Phi\delta$ , then  $\rho_\bullet(\gamma) = \rho(\delta) = \lambda^\bullet(\delta) = \lambda(\Phi\delta)$ , and if  $\gamma = \Phi\delta \star \gamma'$ , then  $\rho_\bullet(\gamma) = \ell[\rho(\delta)](\gamma') = \ell[\Phi\delta \setminus \langle T, \lambda \rangle](\gamma') = \lambda(\Phi\delta \star \gamma') = \lambda(\gamma)$ .

Suppose now that  $\chi_p(R, \rho) \subseteq \langle T, \lambda \rangle$ . Then  $\Phi R \subseteq T$  and therefore  $R \subseteq \Phi^{-1}T = T^\bullet$ . Consider a path  $\delta \in R$  such that  $\partial_1\delta \in P'_\omega$ . If  $\partial_1\Phi\delta \in P_\omega$  then  $\lambda^\bullet(\delta) = \lambda(\Phi\delta) = \rho_\bullet(\Phi\delta) = \rho(\delta)$ ; on the other hand, if  $\partial_1\Phi\delta \in P_{\leq n}$ , then  $\lambda^\bullet(\delta) = \Phi\delta \setminus \langle T, \lambda \rangle = \rho(\delta)$ , since  $\rho(\delta) \subseteq \Phi\delta \setminus \langle T, \lambda \rangle$ . This can be seen as follows: if  $\gamma \in \tau[\rho(\delta)]$  then  $\Phi\delta \star \gamma \in R_\bullet \subseteq T$ , so that  $\gamma \in \tau[\Phi\delta \setminus \langle T, \lambda \rangle]$ ; if moreover  $\partial_1\gamma \in P_\omega$ , then  $\ell[\rho(\delta)](\gamma) = \rho_\bullet(\Phi\delta \star \gamma) = \lambda(\Phi\delta \star \gamma) = \ell[\Phi\delta \setminus \langle T, \lambda \rangle](\gamma)$ .  $\square$

**Proposition 5.14.** *If  $\kappa(n) = \mu$ , then*

$$\chi : \mathcal{S}_{D(G)}(\mathcal{S}_G(E), E) \longrightarrow \mathcal{S}_G(E)$$

*is an initial  $\mathcal{S}_{D(G)}(-, E)$ -algebra.*

*Proof.* First we construct a graph  $\mathcal{G}$  as follows: its vertices are pairs  $(S, p)$  with  $p \in P_{\leq n}$  and  $S \in \mathcal{S}_{G,p}(E)$ . A transition of this graph is of the form

$$\delta : (S, p) \rightarrow (\Phi\delta \setminus S, p')$$

where  $\delta$  is an atom such that  $\Phi\delta \in S$ ,  $\partial_0\Phi\delta = p$  and  $\partial_1\Phi\delta = p'$ . Observe that the graph  $\mathcal{G}$  is well founded: given an infinite sequence  $\delta_i : (S_{i-1}, p_{i-1}) \rightarrow (S_i, p_i)$ ,  $i \geq 1$ , we can construct the infinite path  $\Phi\delta_1 \star \Phi\delta_2 \star \dots$  which belongs to  $S_0$  and contradicts the condition on infinite paths for a winning strategy. Observe moreover that if  $\langle T^\bullet, \lambda^\bullet \rangle = \xi_p(T, \lambda)$  and  $\delta \in A(T^\bullet)$ , then  $\lambda^\bullet(\delta) = \Phi\delta \setminus \langle T, \lambda \rangle$ , hence  $\delta : (\langle T, \lambda \rangle, p) \rightarrow \langle \lambda^\bullet(\Phi\delta), \partial_1\Phi\delta \rangle$ .

Thus, if  $\beta : \mathcal{S}_{D(G)}(B, E) \longrightarrow B$  is another algebra, then we can define  $f : \mathcal{S}_G(E) \longrightarrow B$ , by the formula:

$$\begin{aligned} f_p(T, \lambda) &= \beta_p(\mathcal{S}_{D(G),p}(f, E)(\xi_p(T, \lambda))) \\ &= \beta_p(\mathcal{S}_{D(G),p}(f, E)(T^\bullet, \lambda^\bullet)) \\ &= \beta_p(T^\bullet, \lambda') \end{aligned}$$

where

$$\lambda'(\delta) = \begin{cases} \lambda(\delta), & \partial_1\Phi\delta \in P_\omega \\ f_{\partial_1\Phi\delta}(\lambda^\bullet(\delta)), & \delta \text{ an atom} \end{cases}$$

using the induction hypothesis (on the well founded graph  $\mathcal{G}$ ) that we have previously defined  $f_{p'}(S')$  for each pair  $(S', p')$  such that  $(\langle T, \lambda \rangle, p) \rightarrow (S', p')$ . This is also the unique way to define  $f$  so that  $\chi \cdot f = \mathcal{S}_{D(G)}(f, E) \cdot \beta$ .  $\square$

**Proposition 5.15.** *If  $\kappa(n) = \nu$ , then*

$$\xi : \mathcal{S}_G(E) \longrightarrow \mathcal{S}_{D(G)}(\mathcal{S}_G(E), E)$$

*is a final  $\mathcal{S}_{D(G)}(-, E)$ -coalgebra.*

*Proof.* Consider a coalgebra

$$\beta : B \longrightarrow \mathcal{S}_{D(G)}(B, E),$$

we first define a graph  $\mathcal{G}_\beta$  as follows: a state of  $\mathcal{G}_\beta$  is a pair  $(b, p)$  such that  $p \in P_{\leq n}$  and  $b \in B_p$ , and a transition  $(b, p) \rightarrow (b', p')$  of  $\mathcal{G}_\beta$  is an atom  $\delta \in \tau[\beta_p(b)]$  such that  $\partial_1\Phi\delta = p'$  and  $\ell[\beta_p(b)](\delta) = b'$ . Observe that in the proof of proposition 5.14 the graph  $\mathcal{G}$  coincides with the graph  $\mathcal{G}_\xi$  defined here.

We now define a collection of functions  $\{f_p : B_p \longrightarrow \mathcal{S}_{G,p}(E)\}_{p \in P_{\leq n}}$  and then split the proof of proposition 5.15 in a sequence of lemmas: in 5.18 we show that these functions are well defined, in 5.19 we show that this defines a morphism of coalgebras, and finally in 5.20 we show that this is the unique such morphism.

**Definition 5.16.** For each  $p \in P_{\leq n}$  and  $b \in B_p$  we define  $f_p(b) = \langle T_b, \lambda_b \rangle \in \mathcal{S}_{G,p}(E)$  as follows. We say that  $\gamma \in T_b$  if and only if  $\gamma$  has a factorization of the form

$$\gamma = \Phi\delta_1 \star \dots \star \Phi\delta_k \star \Phi\delta_{k+1} \quad (3)$$

such that

1.  $\Delta = (\delta_1, \dots, \delta_k)$  is a path in  $\mathcal{G}_\beta$  such that  $\partial_0\Delta = (b, p)$  and  $\partial_1\Delta = (b', p')$ ,
2.  $\delta_{k+1} \in \tau[\beta_{p'}(b')]$  is not an atom.

If  $\partial_1\gamma \in P_\omega$ , then we let  $\lambda_b(\gamma) = \ell[\beta_{p'}(b')](\delta_{k+1})$ .

We remark that a factorization of the form (3), without the additional requirements 1. and 2., exists for any path  $\gamma$  and is unique. This follows from the observation that the set of paths  $\{\Phi\delta \mid \delta \text{ is an atom}\}$  does not contain comparable elements with respect to the prefix order. Using the language of the theory of codes [27], this set is a prefix code. Recall also that  $\delta_{k+1}$  is not an atom if either  $\#\delta_{k+1} = 0$  or  $\partial_1\delta_{k+1} \in P'_\omega$  implies  $\partial_1\Phi\delta_{k+1} \in P_\omega$ .

The game-theoretic interpretation of the strategy  $f_p(b)$  is as follows. From position  $p$ , player  $\sigma$  uses the strategy  $\beta_p(b)$  as long as he can. As soon as the play reaches a position  $p'$  such that either  $p' \in P_n$  or after one move if  $p \in P_n$ , this strategy becomes unavailable. However, if one of these two cases happens, the strategy  $\beta_p(b)$  gives player  $\sigma$  the choice of an element  $b' = \ell[\beta_p(b)](\delta)$  in  $B_{p'}$  and therefore the choice of a new strategy  $\beta_{p'}(b')$ . Thus player  $\sigma$  iterates this process. Iteration of this process is expressed by saying that the residual strategy of  $f_p(b)$  after the image of an atom  $\delta$  is the strategy  $f_{p'}(b')$ . This is the content of the next lemma.

**Lemma 5.17.** *Let  $\langle R, \rho \rangle = \beta_p(b)$  and let  $\delta \in A(R)$ . Then*

$$\Phi\delta \setminus f_p(b) = f_{\partial_1\Phi\delta}(\rho(\delta)).$$

*Proof.* Let  $\gamma \in \tau[f_{\partial_1\Phi\delta}(\rho(\delta))]$ , then we can write  $\gamma = \Phi\delta_1 \star \dots \star \Phi\delta_{k+1}$  and thus  $\Phi\delta \star \gamma = \Phi\delta \star \Phi\delta_1 \star \dots \star \Phi\delta_{k+1}$  shows that  $\Phi\delta \star \gamma \in \tau[f_p(b)]$  and  $\gamma \in \tau[\Phi\delta \setminus f_p(b)]$ . If  $\partial_1\gamma \in P_\omega$  then  $\ell[\Phi\delta \setminus f_p(b)](\gamma) = \ell[f_p(b)](\Phi\delta \star \gamma) = \ell[\beta_{p'}(b')](\delta_{k+1})$  and similarly  $\ell[f_{\partial_1\Phi\delta}(\rho(\delta))](\gamma) = \ell[\beta_{p'}(b')](\delta_{k+1})$ .  $\square$

**Lemma 5.18.** *The pair  $f_p(b) = \langle T_b, \lambda_b \rangle$  is a winning strategy for player  $\sigma$  in the game  $G(E)$  from position  $p$ .*

*Proof.* Let  $\gamma \in T_b$  have a factorization  $\Phi\delta_1 \star \dots \star \Phi\delta_{k+1}$ . Observe that  $\delta_1 \in \beta_p(b) \in \mathcal{S}_{D(G),p}(B, E)$  implies that  $\partial_0\delta_1 = (p, 0)$ , hence  $\partial_0\gamma = \partial_0\Phi\delta_1 = p$ . From the definition it is clear that  $T_b$  is closed under prefixes.

Let  $\gamma \in T_b$  and suppose first that  $\epsilon(\partial_1\gamma) = \pi$ . If  $m \in M_{\partial_1\gamma}$ , then  $(m, 0) \in M_{\partial_1\delta_{k+1}}$ , since  $\delta_{k+1}$  is not an atom, hence  $\delta'_{k+1} = \delta_{k+1} \star m \in \beta_{p'}(b')$ . If  $\delta'_{k+1}$  is not an atom, then we can write

$$\gamma \star m = \Phi\delta_1 \star \dots \star \Phi\delta_k \star \Phi\delta'_{k+1}$$

and if  $\delta'_{k+1}$  is an atom we can write

$$\gamma \star m = \Phi\delta_1 \star \dots \star \Phi\delta_k \star \Phi\delta'_{k+1} \star \Phi 1_{(\partial_1\Phi\delta'_{k+1}, 0)},$$

If we let  $p'' = \partial_1\Phi\delta'_{k+1}$  and  $b'' = \ell[\beta_{p'}(b')](\delta'_{k+1})$ , then we observe  $1_{(\partial_1\delta'_{k+1}, 0)} = 1_{(p'', 0)} \in \tau[\beta_{p''}(b'')]$ . In both cases we conclude that  $\gamma \star m \in T_b$ .

If  $\epsilon(\partial_1\gamma) = \sigma$ , then  $\epsilon'(\partial_1\delta_{k+1}) = \sigma$  so that  $\delta_{k+1} \star (m, 0) \in \beta_{p'}(b')$  for a unique  $m \in M_{\partial_1\gamma}$ . As before, we conclude that  $\gamma \star m \in T_b$ . On the other hand, if  $\gamma \star m' \in T_b$ , then  $\delta_{k+1} \star (m', 0) \in \beta_{p'}(b')$ , since such a factorization for  $\gamma$  is unique. Thus  $m = m'$ , since  $\beta_{p'}(b')$  is deterministic.

Consider now an infinite path  $\gamma$  in  $T_b$ . Either this infinite path visits the region  $P_n$  infinitely often, in which case it is a win for player  $\sigma$ , or we can write  $\gamma = \gamma' \star \Phi\delta$ , where  $\delta$  is an infinite play in  $D(G)(B, E)$ , played according to a given winning strategy for this game. This infinite play is a win for player  $\sigma$  in  $D(G)(B, E)$  which implies that  $\gamma$  is a win for player  $\sigma$  in  $G(E)$ .  $\square$

**Lemma 5.19.** *The diagram*

$$\begin{array}{ccc} B & \xrightarrow{f} & \mathcal{S}_G(E) \\ \downarrow \beta & & \downarrow \xi \\ \mathcal{S}_{D(G)}(B, E) & \xrightarrow{\mathcal{S}_{D(G)}(f, E)} & \mathcal{S}_{D(G)}(\mathcal{S}_G(E), E) \end{array}$$

*commutes.*

*Proof.* It is enough to show that for all  $p \in P_{\leq n}$  and  $b \in B_p$

$$\mathcal{S}_{D(G), p}(f, E)(\beta_p(b)) \subseteq \xi_p(f_p(b)).$$

Let  $\langle T_b, \lambda_b \rangle = f_p(b)$  and  $\langle R, \rho \rangle = \beta_p(b)$ . If  $\delta \in R$ , then  $\Phi\delta \in T_b$  so that  $\delta \in T_b^\bullet$ . Suppose now that  $\partial_1\delta \in P'_\omega$ . If  $\partial_1\Phi\delta \in P_\omega$ , then  $\lambda_b^\bullet(\delta) = \lambda_b(\Phi\delta) = \rho(\delta)$ . If  $\partial_1\Phi\delta \in P_{\leq n}$ , that is, if  $\delta$  is an atom, then  $\lambda_b^\bullet(\delta) = \Phi\delta \setminus f_p(b) = f_{\partial_1\Phi\delta}(\rho(\delta))$ , by lemma 5.17.  $\square$

**Lemma 5.20.** *If a collection of functions  $g : B \longrightarrow \mathcal{S}_G(E)$  satisfies the relation  $g \cdot \xi = \beta \cdot \mathcal{S}_{D(G)}(g, E)$ , then  $g = f$ .*

*Proof.* We will prove that  $g_p(b) \subseteq f_p(b)$  for all  $p \in P_{\leq n}$  and  $b \in B_p$ . In the following let  $\beta_p(b) = \langle R, \rho \rangle$  and recall that  $\mathcal{S}_{D(G)}(g, E)(R, \rho) = \langle R, \rho' \rangle$  where  $\rho'(\delta) = \rho(\delta)$  if  $\partial_1\Phi\delta \in P_\omega$  and  $\rho'(\delta) = g_{\partial_1\Phi\delta}(\rho(\delta))$  if  $\delta$  is an atom. Thus we have reduced the relation  $g_p(b) = \chi_p(\mathcal{S}_{D(G), p}(g, E)(\beta_p(b)))$  to the relation  $g_p(b) = \chi_p(R, \rho')$ .

As a first part, we prove by induction on the length of  $\gamma$  the following statement: *for each  $p \in P_{\leq n}$  and  $b \in B_p$ , if  $\gamma \in \tau[g_p(b)]$ , then  $\gamma \in \tau[f_p(b)]$ .*

The statement is trivial if  $\#\gamma = 0$ , since if  $\gamma \in \tau[g_p(b)]$ , then  $\gamma = 1_p$  and  $1_p$  belongs to any winning strategy from position  $p$ . If  $\#\gamma > 0$ , we argue using

the equality  $g_p(b) = \chi_p(R, \rho')$ . If  $\gamma = \Phi\delta$ , then  $\gamma \in T_b$  by its definition. If  $\gamma = \Phi\delta \star \gamma'$ , where  $\delta$  is an atom of  $R$  and  $\gamma' \in \tau[\rho'(\delta)] = \tau[g_{\partial_1\Phi\delta}(\rho(\delta))]$ , then  $\gamma' \in \tau[f_{\partial_1\delta}(\rho(\delta))]$ , since  $\#\gamma' < \#\gamma$  and using the induction hypothesis. Then it is easily seen that  $\gamma = \Phi\delta \star \gamma' \in \tau[f_p(b)]$  as well.

We now prove again by induction on the length the following statement: *for each  $p \in P_{\leq n}$  and  $b \in B_p$ , if  $\gamma \in g_p(b)$  and  $\partial_1\gamma \in P_\omega$ , then  $\ell[g_p(b)](\gamma) = \ell[f_p(b)](\gamma)$ .*

The statement is again obvious if  $\#\gamma = 0$ , since there is no such  $\gamma$  with  $\partial_0\gamma \in P_{\leq n}$  and  $\partial_1\gamma \in P_\omega$ . If  $\#\gamma > 0$ , then two cases. Either  $\gamma = \Phi\delta$  with  $\delta \in R$ , in which case  $\ell[g_p(b)](\gamma) = \rho' \bullet (\Phi\delta) = \rho'(\delta) = \rho(\delta) = \lambda_b(\gamma)$  by the definition of  $f$ . Or  $\gamma = \Phi\delta \star \gamma'$  where  $\delta$  is an atom of  $R$  and  $\gamma' \in \tau[\rho'(\delta)] = \tau[g_{\partial_1\delta}(\rho(\delta))]$ . In this case

$$\begin{aligned}
\ell[g_p(b)](\gamma) &= \rho' \bullet (\Phi\delta \star \gamma') & g_p(b) &= \chi_p(R, \rho') \\
&= \ell[\rho'(\delta)](\gamma') & &\text{def. of } \chi_p \\
&= \ell[g_{\partial_1\Phi\delta}(\rho(\delta))](\gamma') & &\text{def. of } \rho' \\
&= \ell[f_{\partial_1\Phi\delta}(\rho(\delta))](\gamma') & &\text{induction hypothesis on } \gamma' \\
&= \lambda_b(\Phi\delta \star \gamma') & \Phi\delta \setminus f_p(b) &= f_{\partial_1\Phi\delta}(\rho(\delta)) \\
&= \lambda_b(\gamma).
\end{aligned}$$

□

This ends the proof of proposition 5.15 too. □

Thus we have completed the proof of theorem 5.4. We end this section with some examples illustrating the theory so far developed.

**Example 5.21.** We consider the set of finite lists over a set of symbols  $E$ . This is initial algebra of the functor  $1+(Y \times E)$  and therefore it is the denotation of the  $\mu$ -term  $\mu_y.(\top \vee (y \wedge E))$ . In figure 5 we have translated this  $\mu$ -term into a pointed parity game, according to proposition 4.12 and to a well established practice in the model checking community. The conventions are the ones followed until now: positions of the games, labeled by  $\sigma$  or  $\pi$ , are grouped within boxes according to their height. The height is on the right of the boxes, the color is on the left. For convenience of exposition, we have labeled transitions in the figure, even if this is not strictly necessary.

It is immediate to realize that there is a bijection between lists and deterministic winning strategies in the parity game. If we let  $E = \{0, 1\}$ , we have represented in figure 5 the list  $\text{cons}(\text{cons}(\text{nil}, 0), 1)$  in the form of a winning strategy, the tree over the game. Observe that we cannot obtain infinite lists since every infinite path on the corresponding tree would be a loss for player  $\sigma$ .

**Example 5.22.** We want to calculate an algebraic expression describing the set of infinite trees with the following properties: 1) every node is labeled by an element of a given set  $E$ , 2) every node has a finite (possibly empty) list of sons.

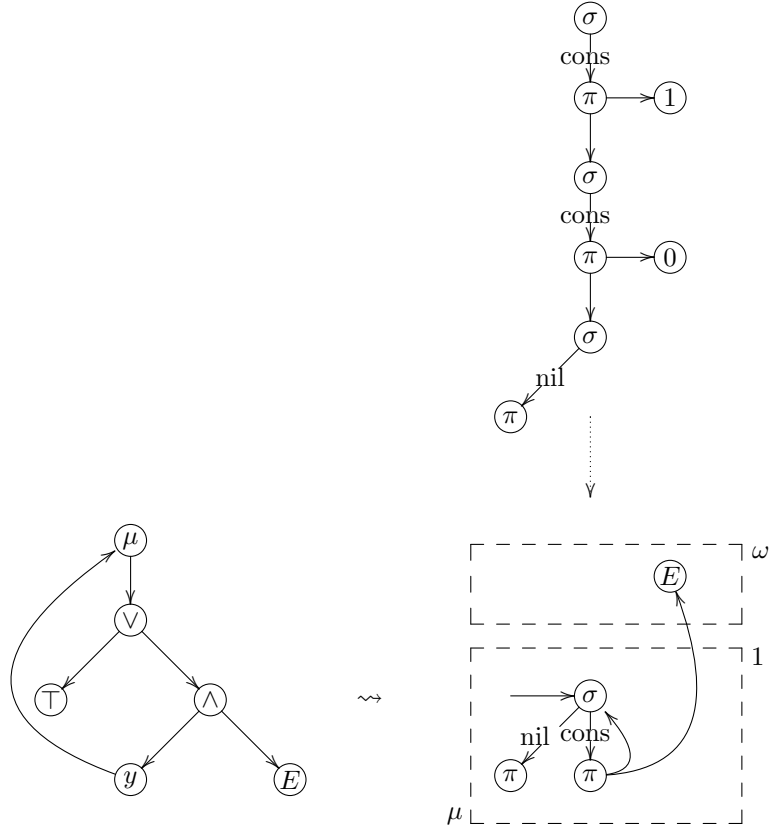

Figure 5: Lists as winning strategies.

According to experience, this set could be expressed as the greatest solution of the equation

$$X = E \times X^*,$$

that is, the final coalgebra of the functorial expression on the right. On the other hand, we know that  $X^*$  is the least solution of

$$Y = 1 + (Y \times X),$$

hence we guess that the desired algebraic expression is given by the  $\mu$ -term  $\nu_x.(E \wedge \mu_y.(\top \vee (y \wedge x)))$ . We can verify that this guess is correct by transforming the  $\mu$ -term into a pointed parity game, according to proposition 4.12, the result being the game on the right of figure 6. It is possible to convince oneself that a labeled tree with those properties gives rise to a deterministic winning strategy for player  $\sigma$  by interpreting a move by  $\pi$  as a question about the tree. Conversely, every such strategy comes from a unique tree of this kind.

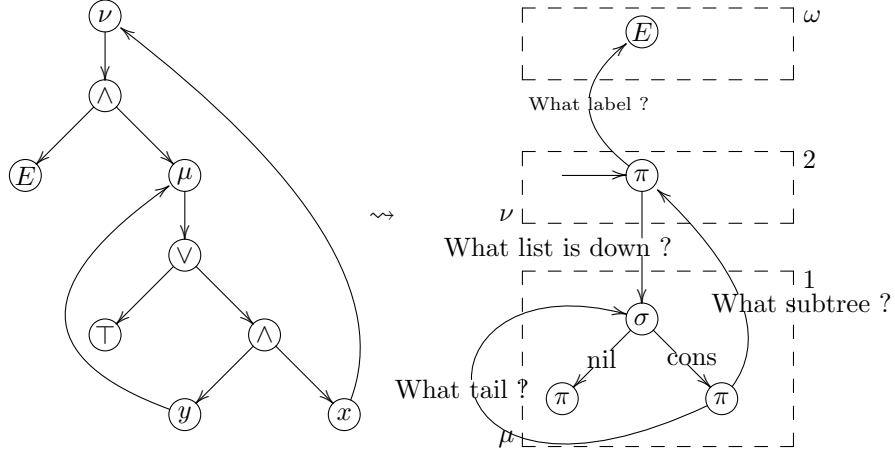

Figure 6: Infinite trees as winning strategies.

It is worth examining infinite paths in this game. Player  $\sigma$  cannot answer that a node has an infinite list of sons: this would be done by answering infinitely often “cons” to the question “What tail?”, without being asked the question “What list is down?”. The region visited infinitely often of maximal height in such a play is colored by  $\mu$ , hence it is a loss for player  $\sigma$ . On the other hand, player  $\sigma$  can answer infinitely often “cons” provided the play is going down in examining the tree, that is, provided this answer is alternating with the question “What list is down?”. The maximal region visited infinitely often in such a play is colored by  $\nu$ , hence it is a win for player  $\sigma$ .

**Example 5.23.** It is well known that infinite finitely branching trees can be encoded as infinite binary trees. Proposition 5.4 can be taken to be a generalization of this fact, in that it shows that the elements of every nullary parity functor can be encoded as infinite trees with a bounded out-degree.

**Example 5.24.** Charity [10] is a programming language designed out of categorical principles, thus recursion and corecursion are in this context synonymous for the universal properties of initial and final coalgebras. An important principle of this programming language states that it is possible to define an arrow  $f : \mu_x.T(x) \times B \longrightarrow C$  from an algebra in context  $g : T(C) \times B \longrightarrow C$ , provided  $T$  is a strong categorical datatype [9]. This means that  $T$  comes with a natural transformation (a strength)

$$\theta_{A,B}^T : T(A) \times B \longrightarrow T(A \times B)$$

satisfying associativity and unitary constrains. The explicit characterization of set-theoretic parity functors allows the direct computation of a strength. If  $A$  and  $B$  are two collections of sets indexed by  $P_\omega$ , then we can associate

to a strategy  $\langle T, \lambda \rangle \in \mathcal{S}_{G,p}(A)$  and to a collection  $b = \{b_x \in B_x\}_{x \in P_\omega}$  the strategy  $\langle T, \lambda^b \rangle \in \mathcal{S}_{G,p}(A \times B)$ , where if  $\gamma \in T$  and  $\partial_1 \gamma \in P_\omega$  then  $\lambda^b(\partial_1 \gamma) = (\lambda(\partial_1 \gamma), b_{\partial_1 \gamma})$ .

## 6 Conclusions

The main result of this paper is the combinatorial characterization of the functors on the category of sets and functions that are definable by means of  $\mu$ -terms. This characterization leads to show that the algebra of  $\mu$ -bicomplete categories, when realized in the category of sets, is closely related to the theory of automata recognizing infinite objects. For example an automaton recognizing – by parity condition – infinite strings over the finite alphabet  $\Sigma$  can be described as a triple  $\langle G, p, f \rangle$ , where  $\langle G, p \rangle$  is a pointed parity game such that  $P_\omega = \emptyset$ ,  $\epsilon(p) = \sigma$  for all  $p \in P$ , and  $f : |G|_p \longrightarrow \|\nu_x. \bigvee_\Sigma x\|$  is a function arising from labeling the transitions of  $G$  by symbols in  $\Sigma$ , function which turns out to be definable in the language of  $\mu$ -bicomplete categories. A subset  $L \subseteq \Sigma^\mathbb{N}$  is recognizable if and only if there exists such a triple  $\langle G, p, f \rangle$ , so that  $L$  is the image of  $f$ . A main motivation for developing this work was indeed to make available to this theory an algebraic language (the one of  $\mu$ -bicomplete categories) which is alternative but also analogous to the one of  $\mu$ -calculi [5].

The combinatorial characterization suggests also a way for enlarging the collection of categories which are known to be  $\mu$ -bicomplete. There are several toposes that occur in computer science – for example, the effective topos [17] – which are not complete or cocomplete, in particular they are neither locally presentable nor dually locally presentable. A detailed analysis of the work presented here could show that the explicit characterization of parity functors can be carried within intuitionistic logic. If this were the case, the characterization could be used to show that elementary toposes with a natural number object are  $\mu$ -bicomplete.

Finally, it is an open problem to understand whether this game-theoretic characterization is useful to understand  $\mu$ -functors in arbitrary categories. It is in general easier to understand several algebraic equivalences in terms of game equivalences. We have avoided to make precise this notion, but we conjecture that this can be done so that two parity games are game-theoretic equivalent if and only if their interpretations as functors are naturally isomorphic in every  $\mu$ -bicomplete category.

## References

- [1] P. Aczel. *Non-well-founded sets*. Stanford University Center for the Study of Language and Information, Stanford, CA, 1988.
- [2] P. Aczel, J. Adámek, and J. Velebil. A coalgebraic view of infinite trees and iteration. In Marina Lenisa Andrea Corradini and Ugo Montanari, editors, *Electronic Notes in Theoretical Computer Science*, volume 44. Elsevier Science Publishers, 2001.
- [3] J. Adámek and V. Koubek. Least fixed point of a functor. *J. Comput. System Sci.*, 19(2):163–178, 1979.
- [4] J. Adámek and J. Rosický. *Locally presentable and accessible categories*. Cambridge University Press, Cambridge, 1994.
- [5] A. Arnold and D. Niwinski. *Rudiments of mu-calculus*. Number 146 in Studies in Logic and the Foundations of Mathematics. Elsevier (North-Holland), 2001.
- [6] M. Barr. Terminal coalgebras in well-founded set theory. *Theoret. Comput. Sci.*, 114(2):299–315, 1993.
- [7] S. L. Bloom and Z. Ésik. *Iteration theories*. Springer-Verlag, Berlin, 1993. The equational logic of iterative processes.
- [8] S. L. Bloom, Z. Ésik, A. Labella, and E. G. Manes. Iteration 2-theories. *Appl. Categ. Structures*, 9(2):173–216, 2001.
- [9] J. R. B. Cockett and D. Spencer. Strong categorical datatypes. I. In *Category theory 1991 (Montreal, PQ, 1991)*, pages 141–169. Amer. Math. Soc., Providence, RI, 1992.
- [10] J. R. B. Cockett and D. Spencer. Strong categorical datatypes. II. A term logic for categorical programming. *Theoret. Comput. Sci.*, 139(1-2):69–113, 1995.
- [11] R. Cockett and T. Fukushima. About Charity. Yellow Series Report No. 92/480/18, Department of Computer Science, The University of Calgary, June 1992.
- [12] E. A. Emerson and C. S. Jutla. Tree automata, mu-calculus and determinacy (extended abstract). In *32nd Annual Symposium on Foundations of Computer Science*, pages 368–377. IEEE, 1991.
- [13] E. A. Emerson, C. S. Jutla, and A. P. Sistla. On model checking for the  $\mu$ -calculus and its fragments. *Theoret. Comput. Sci.*, 258(1-2):491–522, 2001.
- [14] Z. Ésik and A. Labella. Equational properties of iteration in algebraically complete categories. *Theoret. Comput. Sci.*, 195(1):61–89, 1998. Mathematical foundations of computer science (Cracow, 1996).

- [15] P. Freyd. Algebraically complete categories. In *Category theory (Como, 1990)*, pages 95–104. Springer, Berlin, 1991.
- [16] E. Giménez. A tutorial on recursive types in Coq. Technical Report 0221, INRIA, May 1998.
- [17] J. M. E. Hyland. The effective topos. In *The L.E.J. Brouwer Centenary Symposium (Noordwijkerhout, 1981)*, pages 165–216. North-Holland, Amsterdam, 1982.
- [18] A. Joyal. Free bicomplete categories. *C. R. Math. Rep. Acad. Sci. Canada*, 17(5):219–224, 1995.
- [19] A. Joyal. Free lattices, communication and money games. In *Logic and scientific methods (Florence, 1995)*, pages 29–68. Kluwer Acad. Publ., Dordrecht, 1997.
- [20] G. M. Kelly. Elementary observations on 2-categorical limits. *Bull. Austral. Math. Soc.*, 39(2):301–317, 1989.
- [21] J. Lambek. A fixpoint theorem for complete categories. *Math. Z.*, 103:151–161, 1968.
- [22] D. J. Lehmann and M. B. Smyth. Algebraic specification of data types: a synthetic approach. *Math. Systems Theory*, 14(2):97–139, 1981.
- [23] M. Makkai and R. Paré. *Accessible categories: the foundations of categorical model theory*. American Mathematical Society, Providence, RI, 1989.
- [24] R. McNaughton. Infinite games played on finite graphs. *Ann. Pure Appl. Logic*, 65(2):149–184, 1993.
- [25] A. W. Mostowski. Regular expressions for infinite trees and a standard form of automata. In *Computation theory (Zaborów, 1984)*, volume 208 of *Lect. Notes in Comput. Sci.*, pages 157–168. Springer, Berlin, 1985.
- [26] D. Niwiński. Equational  $\mu$ -calculus. In *Computation theory (Zaborów, 1984)*, volume 208 of *Lect. Notes in Comput. Sci.*, pages 169–176. Springer, Berlin, 1985.
- [27] C. Reutenauer. Ensembles libres de chemins dans un graphe. *Bull. Soc. Math. France*, 114(2):135–152, 1986.
- [28] J. J. M. M. Rutten. Universal coalgebra: a theory of systems. *Theoret. Comput. Sci.*, 249(1):3–80, 2000.
- [29] L. Santocanale. The alternation hierarchy for the theory of  $\mu$ -lattices. *Theory and Applications of Categories*, 9:166–197, January 2002. A special volume of articles from the Category Theory 2000 Conference (CT2000).

- [30] L. Santocanale. A calculus of circular proofs and its categorical semantics. In *FOSSACS02, Foundations of Software Science and Computation Structures*, volume 2303 of *Lect. Notes Comput. Sci.*, pages 357–371, 2002.
- [31] L. Santocanale. Free  $\mu$ -lattices. *J. Pure Appl. Algebra*, 168(2-3):227–264, 2002. Category theory 1999 (Coimbra).
- [32] A.K. Simpson and G.D. Plotkin. Complete axioms for categorical fixed-point operators. In *Proceedings of 15th Annual Symposium on Logic in Computer Science*, pages 30–41, 2000.
- [33] W. Thomas. Languages, automata, and logic. In Rozenberg G. and Salomaa A., editors, *Handbook of Formal Language Theory*, volume III. Springer-Verlag, New York, 1996.
- [34] I. Walukiewicz. Pushdown processes: games and model-checking. *Inform. and Comput.*, 164(2):234–263, 2001. FLOC '96 (New Brunswick, NJ).
- [35] W. Zielonka. Infinite games on finitely coloured graphs with applications to automata on infinite trees. *Theoret. Comput. Sci.*, 200(1-2):135–183, 1998.