



HAL
open science

About the equivalence between AWCness and DWCness

Nicolas Boutry, Laurent Najman, Thierry Géraud

► **To cite this version:**

Nicolas Boutry, Laurent Najman, Thierry Géraud. About the equivalence between AWCness and DWCness. [Research Report] LIGM - Laboratoire d'Informatique Gaspard-Monge; LRDE - Laboratoire de Recherche et de Développement de l'EPITA. 2016. hal-01375621v2

HAL Id: hal-01375621

<https://hal.science/hal-01375621v2>

Submitted on 9 Oct 2016

HAL is a multi-disciplinary open access archive for the deposit and dissemination of scientific research documents, whether they are published or not. The documents may come from teaching and research institutions in France or abroad, or from public or private research centers.

L'archive ouverte pluridisciplinaire **HAL**, est destinée au dépôt et à la diffusion de documents scientifiques de niveau recherche, publiés ou non, émanant des établissements d'enseignement et de recherche français ou étrangers, des laboratoires publics ou privés.

About the equivalence between AWCness and DWCness

Nicolas Boutry¹¹, Laurent Najman²¹, and Thierry Géraud³²

¹*Université Paris-Est, LIGM, Équipe A3SI, ESIEE, France*

²*EPITA Research and Development Laboratory (LRDE),
EPITA, France*

October 9, 2016

¹Electronic address: nicolas.boutry@lrde.epita.fr; Corresponding author

²Electronic address: laurent.najman@esiee.fr

³Electronic address: thierry.geraud@lrde.epita.fr

Abstract

In digital topology, it is well-known that, in 2D and in 3D, a set $X \subseteq \mathbb{Z}^n$ is *digitally well-composed (DWC)*, that is, does not contain any critical configuration, iff its immersion in the Khalimsky grids \mathbb{H}^n is *well-composed in the sense of Alexandrov (AWC)*, that is, its topological boundary is a disjoint union of discrete $(n - 1)$ -surfaces. This report shows that this is still true in n -D, $n \geq 2$, which is of primary importance since today 4D signals are more and more frequent. This means that the usual digital subsets of \mathbb{Z}^n that are DWC can be immersed in \mathbb{H}^n and the connected components of their boundaries will be discrete surfaces. Conversely, if any subset verifies that its immersion is AWC, we will know that this set is DWC. Note that the correctness of this proof is still not verified.

Keywords: well-composed, discrete surfaces, critical configurations, digital topology

Contents

1	Introduction	8
2	Digital topology and DWCness	9
2.1	Mathematical Basics in n -D	9
2.2	n -D DWCness	10
2.2.1	Well-composed gray-level n -D images	14
2.2.2	Characterizing DWC real-valued n -D images	15
3	Axiomatic Digital Topology and AWCness	16
3.1	Topology	16
3.2	Regular open/closed sets	18
3.3	T_0 -spaces and Alexandrov Spaces	18
3.4	Partially ordered sets	19
3.5	From posets to T_0 -spaces	22
3.6	Khalimsky Grids	23
3.7	Order Joins	30
3.8	n -surfaces	31
3.9	Closed Orders	35
3.10	Plain maps	35
3.11	AWCness in n -D	36
4	A sketch of the proof	38
4.1	From $(\frac{\mathbb{Z}}{2})^n$ to \mathbb{H}^n	38
4.2	Immersion into Khalimsky Grids	39
4.3	Stating the problem	39
4.4	Reformulating the topological boundary	40
4.5	Reformulating the problem in a local way	40
4.6	Study of the converse sense	42
4.7	Study of the direct sense	43
4.8	Conclusion for sets	48
4.9	Conclusion for plain maps	49

5	The complete proof	50
5.1	Some preliminaries	51
5.1.1	Cartesian product and basic operators	51
5.2	Isomorphism between $(\mathbb{Z}/2)^n$ and \mathbb{H}^n	52
5.2.1	Topological structure of $(\mathbb{Z}/2)^n$	53
5.2.2	Topological structure of \mathbb{H}^n	54
5.2.3	Isomorphism between $(\mathbb{Z}/2)^n$ and \mathbb{H}^n	54
5.2.4	From \mathbb{H}^n to $(\mathbb{Z}/2)^n$	56
5.3	Reformulating the formula of the boundary	59
5.4	Hypotheses of the problem	61
5.5	Stating the problem	61
5.6	Reformulating the problem	62
5.7	Proof of the converse implication	64
5.7.1	Complements about antagonism	64
5.7.2	Infimum of two faces	66
5.7.3	Link between antagonism and infimum	69
5.7.4	Existence of a <i>critical point</i> z^*	71
5.7.5	z^* belongs to \mathfrak{N}	72
5.7.6	Preamble to the calculus of $ \beta_{\mathfrak{N}}^{\square}(z^*) $	74
5.7.7	Calculus of $ \beta_{\mathfrak{N}}^{\square}(z^*) $	81
5.7.8	Some additionnal theoretical background about n -surfaces.	82
5.7.9	$ \beta_{\mathfrak{N}}^{\square}(z^*) $ is not a $(n - \dim(z^*) - 2)$ -surface.	83
5.7.10	Summary and conclusion for the converse sense.	84
5.8	Proof in the direct sense.	84
5.8.1	First properties of $\{F_i\}_{i \in \mathcal{I}}$	87
5.8.2	$\mathbb{1}(x)$ and $\frac{1}{2}(x)$	89
5.8.3	Covering and opposites	91
5.8.4	A very particular $(n - \dim(z) - 2)$ -surface	95
5.8.5	F_i cannot contain two opposite faces	99
5.8.6	F_i contains at most $(n - \dim(z)) (\dim(z) + 1)$ -faces	100
5.8.7	$\beta_{\mathfrak{N}}^{\square}(z)$ is a closure of $(n - 1)$ -faces in $\beta^{\square}(z)$	100
5.8.8	F_i is a closure of $(n - 1)$ -faces in $\beta^{\square}(z)$	104
5.8.9	F_i contains faces of each dimension into $[[\dim(z) + 1, n - 1]]$	105
5.8.10	Rank lemma	106
5.8.11	Definition and properties of $\mathcal{T}(u)$	108
5.8.12	Supremum of two faces	109
5.8.13	Decomposition lemma	112
5.8.14	Counting the k -faces into $\alpha(a) \cap \beta(b)$	115

5.8.15	Minimal number of $(\dim(z) + 1)$ -faces into F_i	116
5.8.16	Exact number of $(\dim(z) + 1)$ -faces into F_i	116
5.8.17	Decomposing components $\mathcal{T}(F_i)$	116
5.8.18	Characteristical points of each F_i	117
5.8.19	F_i is contained in the closure of its characteristical point	119
5.8.20	Structure of components F_i	120
5.8.21	The two characteristical points of $ \beta_{\mathfrak{R}}^{\square}(z) $	121
5.8.22	$\mathcal{Z}_n(\mathbf{a})$ and $\mathcal{Z}_n(\mathbf{b})$ are $(n - \dim(z))$ -antagonist	121
5.8.23	Connectivity of $S(z) \setminus \{\mathcal{Z}_n(\mathbf{a}), \mathcal{Z}_n(\mathbf{b})\}$ ($\dim(z) \leq (n - 3)$)	122
5.8.24	$S(z)$ contains a critical configuration	123
5.8.25	Summary of the direct sense.	124
5.8.26	Conclusion for sets	124
5.8.27	Conclusion for plain maps	125
6	Conclusion	126

List of Symbols

- basics:
 - n is the dimension of the space,
 - $\mathbb{B} = \{e^1, \dots, e^n\}$ is the canonical basis of \mathbb{Z}^n ,
 - x_i is the i^{th} coordinate, $i \in \llbracket 1, n \rrbracket$, of $x \in \mathbb{R}^n$,
 - $\#$ denotes the cardinal operator,
- neighborhoods and connectivity:
 - $\mathcal{N}_{2n}(p)$ is the $2n$ -neighborhood of p in \mathbb{Z}^n ,
 - $\mathcal{N}_{2n}^*(p)$ is the $2n$ -neighborhood of p minus p in \mathbb{Z}^n ,
 - $\mathcal{N}_{3^n-1}(p)$ is the $(3^n - 1)$ -neighborhood of p in \mathbb{Z}^n ,
 - $\mathcal{N}_{3^n-1}^*(p)$ is the $(3^n - 1)$ -neighborhood of p minus p in \mathbb{Z}^n
- blocks and antagonism:
 - $\mathcal{B}(A)$ is the set of blocks in the space A ,
 - $\mathcal{F} = (f^1, \dots, f^k) \subseteq \mathbb{B}$ is the family of vectors associated to a block,
 - $S(z, \mathcal{F})$ is the block associated to z and to the family \mathcal{F} ,
 - $S \in \mathcal{B}(A)$ is a block in A ,
 - k is the dimension of a block S associated to $\mathcal{F} = (f^1, \dots, f^k)$,
 - $\text{antag}_S(p)$ is the antagonist in the block S to $p \in S$,
- interval values:
 - $\text{intvl}(a, b)$ is the interval value $[\min(a, b), \max(a, b)]$ of the values $a, b \in \mathbb{R}$,

- $\text{Span}(V)$ is the span of the (finite) set of values $V \subset \mathbb{R}$,
- $\llbracket a, b \rrbracket$ is the discrete interval $[a, b] \cap \mathbb{Z}$ with $a, b \in \mathbb{Z}$ such that $a \leq b$,
- $\text{ConvHull}(A)$ is the convex hull of the set $A \subseteq \mathbb{R}^n$,
- $\left(\frac{\mathbb{Z}}{2}\right)^n$ as a poset:
 - $\mathbb{1}(x)$ is the set of *integral coordinates* of $x \in (\mathbb{Z}/2)^n$,
 - $\frac{1}{2}(x)$ is the set of *half coordinates* of $x \in (\mathbb{Z}/2)^n$,
- ordered sets:
 - R is a binary relation,
 - \mathcal{O} represents a set or arbitrary elements,
 - $|\mathcal{O}| = (\mathcal{O}, \alpha_{\mathcal{O}})$ is the set \mathcal{O} supplied with its order relation $\alpha_{\mathcal{O}}$,
 - α is the topological closure operator,
 - $\alpha^{\square}(x) = \alpha(x) \setminus \{x\}, \forall x \in \mathcal{O}$,
 - $\alpha_X = \alpha \cap X \times X$,
 - $\alpha(X) = \bigcup_{x \in X} \alpha(x)$,
 - β is the topological opening operator, the inverse of α ,
 - $\beta^{\square}(x) = \beta(x) \setminus \{x\}, \forall x \in \mathcal{O}$,
 - $\beta_X = \beta \cap X \times X$,
 - $\beta(X) = \bigcup_{x \in X} \beta(x)$,
 - $\theta = \alpha \cap \beta$ is the neighborhood,
 - $\theta^{\square}(x) = \theta(x) \setminus \{x\}, \forall x \in \mathcal{O}$,
 - $\theta_X = \theta \cap X \times X$,
 - $\theta(X) = \bigcup_{x \in X} \theta(x)$,
 - $\rho(h)$ is the rank of the face $h \in \mathcal{O}$,
 - $\rho(|\mathcal{O}|)$ is the rank of the order $|\mathcal{O}|$,
- from $(\mathbb{Z}/2)^n$ to Khalimsky grids:
 - \mathbb{H}^n denotes the Khalimsky grids of dimension n ,
 - $\mathbb{H}_k^n, k \in \llbracket 0, n \rrbracket$, denotes the elements of \mathbb{H}^n of dimension k ,

- $\mathcal{Z} : \mathbb{H}^1 \rightarrow (\mathbb{Z}/2)$ is the topological isomorphism between \mathbb{H}^1 and $(\mathbb{Z}/2)$,
 - $\mathcal{Z}_n : \mathbb{H}^n \rightarrow (\mathbb{Z}/2)^n$ is the topological isomorphism between \mathbb{H}^n and $(\mathbb{Z}/2)^n$,
 - \mathcal{H} is the inverse of the topological isomorphism \mathcal{Z} ,
 - \mathcal{H}_n is the inverse of the topological isomorphism \mathcal{Z}_n ,
 - $\mathcal{U}_{\mathbb{H}^1}$ is the topology of \mathbb{H}^1 ,
 - $\mathcal{U}_{(\mathbb{Z}/2)}$ is the topology associated to $(\mathbb{Z}/2)$ as an isomorph of \mathbb{H}^1 ,
 - $\mathcal{U}_{\mathbb{H}^n}$ is the topology of \mathbb{H}^n ,
 - $\mathcal{U}_{(\mathbb{Z}/2)^n}$ is the topology associated to $(\mathbb{Z}/2)^n$ as an isomorph of \mathbb{H}^n
- Khalimsky grids:
 - $a \wedge b = \sup(\alpha(a) \cap \alpha(b))$ is the *infimum* between a and b ,
 - $a \vee b = \inf(\beta(a) \cap \beta(b))$ is the *supremum* between a and b ,
 - $\dim(f)$ is the dimension of the face $f \in \mathbb{H}^n$,
- relative to the proof:
 - $X \subseteq \mathbb{Z}^n$ is a subset of \mathbb{Z}^n
 - $Y = \mathbb{Z}^n \setminus X$ is a subset of \mathbb{Z}^n
 - $\mathcal{X} = \mathcal{H}_n(X) \subseteq \mathbb{H}_n^n$ is the isomorph of X into the Khalimsky grids,
 - $\mathcal{Y} = \mathcal{H}_n(Y) \subseteq \mathbb{H}_n^n$ is the isomorph of Y into the Khalimsky grids,
 - $\mathcal{I}\mathcal{M}\mathcal{M}(X) = \text{Int}(\alpha(X))$ is the immersion of X into \mathbb{H}^n
 - $\mathfrak{N} = \partial\mathcal{I}\mathcal{M}\mathcal{M}(X)$ is the topological boundary of $\mathcal{I}\mathcal{M}\mathcal{M}(X)$
 - $\mathcal{C}\mathcal{C}(\mathfrak{N})$ are the connected components of $\mathfrak{N} \subseteq \mathbb{H}^n$,
 - $z^* = \mathcal{H}_n(p) \wedge \mathcal{H}_n(p')$ is a *critical point* when $X \cap S(p, p')$ is a primary/secondary critical configuration,
 - $(\mathcal{P}_k) \equiv \{\forall z \in N \cap \mathbb{H}_{n-k}^n, |\beta_{\mathfrak{N}}^{\square}(z)| \text{ is a } (n - 2 - \dim(z)) - \text{surface}\} \text{ .,}$
 - $(\mathcal{P}'_k) \equiv \{\forall z \in \mathfrak{N} \cap \mathbb{H}_{n-k}^n, |\beta_{\mathfrak{N}}^{\square}(z)| \text{ is connected}\} \text{ .,}$
 - \mathcal{I} is the family of indices s.t. $\{F_i\}_{i \in \mathcal{I}} = \mathcal{C}\mathcal{C}(|\beta_{\mathfrak{N}}^{\square}(z)|)$,
 - $\{F_i\}_{i \in \mathcal{I}}$ are the connected components of $|\beta_{\mathfrak{N}}^{\square}(z)|$,

- $S(z) \equiv \mathcal{Z}_n(\beta(z) \cap \mathbb{H}_n^n)$ is the block centered at $z \in \mathbb{H}^n$,
- $\mathcal{T}(u)$ is the set of $(\dim(z) + 1)$ -faces included into $\alpha(u) \cap \beta^\square(z)$,
- $\mathcal{T}(F_i)$ is the set of $(\dim(z) + 1)$ -faces of F_i ,
- $\mathbf{a} = \bigvee_{t \in \mathcal{T}(F_1)} t$ and $\mathbf{b} = \bigvee_{t \in \mathcal{T}(F_2)} t$ are the “characteristical points”.

Chapter 1

Introduction

A subset $X \subset \mathbb{Z}^n$ which is *digitally well-composed (DWC)* has many nice topological properties: its connectivities are globally and locally equivalent, they do not lead to topological paradoxes such as the connectivity paradox of Rosenfeld, and so on. However, they do not own continuity properties since they are defined in \mathbb{Z}^n . Nevertheless, in 2D and 3D, it is well-known that when we immerse them into the *Khalimsky grids*, they are *well-composed in the sense of Alexandrov (AWC)*, that is, the connected components of their topological boundaries are discrete surfaces, which is a very strong topological property. Unfortunately, this relation between the DWCness of a set and the AWCness of the immersion of this set has not yet been proven to be true in n -D, $n \geq 4$. This paper states that this equivalence is true in any finite dimension.

The plan of this report is the following: we recall the background in matter of digital topology necessary to define DWCness, then we recall the background in matter of Khalimsky grids and orders necessary to define AWCness. After that, we expose a sketch of the proof, such that the reader will be able to follow the reasoning of the next part: the complete proof. Then we conclude.

Let us note that the correctness of this proof is still not verified, and then should be read with prudence.

Chapter 2

Digital topology and DWCNess

In this chapter we recall the minimal background in digital topology necessary to define n -D DWCNess for sets and images.

2.1 Mathematical Basics in n -D

Let $\mathbb{B} = \{e^1, \dots, e^n\}$ be the (orthonormal) canonical basis of \mathbb{Z}^n . We use the notation x_i , where i belongs to $\llbracket 1, n \rrbracket$, to determine the i^{th} coordinate of the vector $x \in \mathbb{Z}^n$. We recall that the L^1 -norm of a point $x \in \mathbb{Z}^n$ is denoted by $\|\cdot\|_1$ and is equal to $\sum_{i \in \llbracket 1, n \rrbracket} |x_i|$ where $|\cdot|$ is the *absolute value*. Also, the L^∞ -norm is denoted by $\|\cdot\|_\infty$ and is equal to $\max_{i \in \llbracket 1, n \rrbracket} |x_i|$.

For a given point $x \in \mathbb{Z}^n$, the set of the $2n$ -neighborhood in \mathbb{Z}^n is noted $\mathcal{N}_{2n}(x)$ and is equal to $\{y \in \mathbb{Z}^n ; \|x - y\|_1 \leq 1\}$. In other words,

$$\mathcal{N}_{2n}(x) = \{x\} \cup \{x - e^1, x + e^1, \dots, x - e^n, x + e^n\}.$$

An element of the $2n$ -neighborhood of $x \in \mathbb{Z}^n$ is called a $2n$ -neighbor of x in \mathbb{Z}^n . The *starred $2n$ -neighborhood* of $x \in \mathbb{Z}^n$ is noted $\mathcal{N}_{2n}^*(x)$ and is equal to $\mathcal{N}_{2n}(x) \setminus \{x\}$. Two points $x, y \in \mathbb{Z}^n$ such that $x \in \mathcal{N}_{2n}^*(y)$ or equivalently $y \in \mathcal{N}_{2n}^*(x)$ are said to be $2n$ -adjacent.

Then, for a given point $x \in \mathbb{Z}^n$, the set of the $(3^n - 1)$ -neighborhood is noted $\mathcal{N}_{3^n-1}(x)$ and is equal to $\{y \in \mathbb{Z}^n ; \|x - y\|_\infty \leq 1\}$. In other words,

$$\mathcal{N}_{3^n-1}(x) = \left\{ x + \sum_{i \in \llbracket 1, n \rrbracket} \lambda_i e^i ; \lambda_i \in \{-1, 0, 1\}, \forall i \in \llbracket 1, n \rrbracket \right\}.$$

An element of the $(3^n - 1)$ -neighborhood of $x \in \mathbb{Z}^n$ is called a $(3^n - 1)$ -neighbor of x . The *starred* $(3^n - 1)$ -neighborhood of $x \in \mathbb{Z}^n$ is noted $\mathcal{N}_{3^n - 1}^*(x)$ and is equal to $\mathcal{N}_{3^n - 1}(x) \setminus \{x\}$. Two points $x, y \in \mathbb{Z}^n$ such that $x \in \mathcal{N}_{3^n - 1}^*(y)$ or equivalently $y \in \mathcal{N}_{3^n - 1}^*(x)$ are said to be $(3^n - 1)$ -adjacent.

Let x, y be two points in \mathbb{Z}^n and X be a subset of \mathbb{Z}^n . A (finite) $2n$ -path (respectively a (finite) $(3^n - 1)$ -path) joining x to y into X is a sequence $(p^0 = x, p^1, \dots, p^{k-1}, p^k = y)$ such that for any $i \in \llbracket 0, k \rrbracket$, p^i belongs to X and such that for any $i \in \llbracket 0, k-1 \rrbracket$, $p^{i+1} \in \mathcal{N}_{2n}^*(p^i)$ (respectively $p^{i+1} \in \mathcal{N}_{3^n - 1}^*(p^i)$). Such paths are said to be of *length* k .

A subset X of \mathbb{Z}^n such that its cardinal $\text{Card}(X)$ is finite is said to be a *digital set*. A (digital) set $X \subset \mathbb{Z}^n$ is said $2n$ -connected (respectively $(3^n - 1)$ -connected) iff for any couple of points $x, y \in X$, there exists a $2n$ -path (respectively a $(3^n - 1)$ -path) joining them into X . A subset C of X which is $2n$ -connected (respectively $(3^n - 1)$ -connected) and which is *maximal in the inclusion sense*, that is, there is no subset of X which is greater than C and which is connected, is said to be a $2n$ -component (respectively a $(3^n - 1)$ -component) of X .

A point $x \in \mathbb{Z}^n$ is said to be $2n$ -connected (respectively $(3^n - 1)$ -connected) to a set $Y \subseteq \mathbb{Z}^n$ iff there exists a point $y \in Y$ such that x and y are $2n$ -neighbors (respectively $(3^n - 1)$ -neighbors). Two sets $X, Y \subseteq \mathbb{Z}^n$ are said to be $2n$ -connected (respectively $(3^n - 1)$ -connected) iff there exists $x \in X$ such that x and Y are $2n$ -connected (respectively $(3^n - 1)$ -connected).

The set of connected components of a digital set $X \subseteq \mathbb{Z}^n$ based on the ξ -connectivity, $\xi \in \{2n, 3^n - 1\}$, is denoted by $\mathcal{CC}_\xi(X)$. Assuming that a point $x \in \mathbb{Z}^n$ belongs to a set $X \subset \mathbb{Z}^n$, the connected component of X based on the ξ -connectivity, $\xi \in \{2n, 3^n - 1\}$, is denoted by $\mathcal{CC}_\xi(X, x)$; in the contrary case, $\mathcal{CC}_\xi(X, x) = \emptyset$.

2.2 n -D DWCness

Now, we recall our definition of *digital well-composedness* for sets in \mathbb{Z}^n , that we call in this way because it is based on patterns called “ k -dimensional critical configurations”, $k \in \llbracket 2, n \rrbracket$, and these patterns can only occur in subsets of \mathbb{Z}^n . So let us introduce the basic mathematical background which will allow us to generalize the notion of well-composedness based on critical configurations to dimension $n \geq 2$.

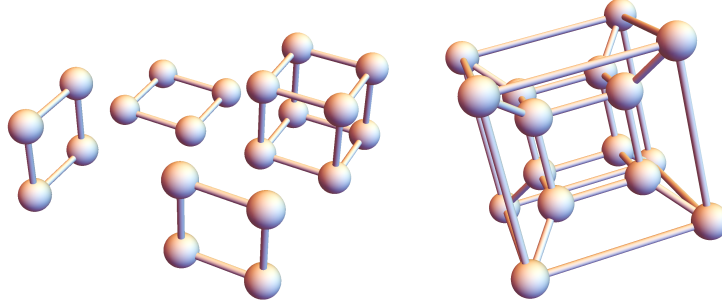

Figure 2.1: 2D, 3D and 4D blocks.

Like usual, $\mathbb{B} = \{e^1, \dots, e^n\}$ is the canonical basis of \mathbb{Z}^n .

Definition 1. Given a point $z \in \mathbb{Z}^n$ and a family of vector $\mathcal{F} = (f^1, \dots, f^k) \subseteq \mathbb{B}$, we define the block of \mathbb{Z}^n associated to the couple (z, \mathcal{F}) in this way:

$$S(z, \mathcal{F}) = \left\{ z + \sum_{i \in \llbracket 1, k \rrbracket} \lambda_i f^i \mid \lambda_i \in \{0, 1\}, \forall i \in \llbracket 1, k \rrbracket \right\}.$$

A subset $S \subset \mathbb{Z}^n$ is called a *block of \mathbb{Z}^n* iff there exists a couple $(z, \mathcal{F}) \in \mathbb{Z}^n \times \mathcal{P}(\mathbb{B})$ such that $S = S(z, \mathcal{F})$. Note that a block of \mathbb{Z}^n which is associated to a family $\mathcal{F} \in \mathcal{P}(\mathbb{B})$ of cardinal $k \in \llbracket 0, n \rrbracket$ is said to be of *dimension k* , what will be denoted by $\dim(S) = k$. Figure 2.1 shows 2D, 3D and 4D blocks. We can remark that their dimension does not depend on the space they lie in. We will denote the set of blocks of \mathbb{Z}^n by $\mathcal{B}(\mathbb{Z}^n)$.

Using this notion of blocks, we can define *antagonism*.

Definition 2. Two points $p, q \in \mathbb{Z}^n$ belonging to a block $S \in \mathcal{B}(\mathbb{Z}^n)$ are said to be *antagonist in S* iff their distance equals the maximal distance using the L^1 norm between two points into S . In other words, two points p and q in \mathbb{Z}^n are *antagonist in $S \in \mathcal{B}(\mathbb{Z}^n)$* iff $p, q \in S$ such that:

$$\|p - q\|_1 = \max\{\|x - y\|_1 ; x, y \in S\},$$

and in this case we write that $q = \text{antag}_S(p)$ or equivalently $p = \text{antag}_S(q)$.

The antagonist of a point p in a block $S \in \mathcal{B}(\mathbb{Z}^n)$ containing p exists and is unique. Sometimes we will use the notation $S(p, q)$ where $p, q \in \mathbb{Z}^n$

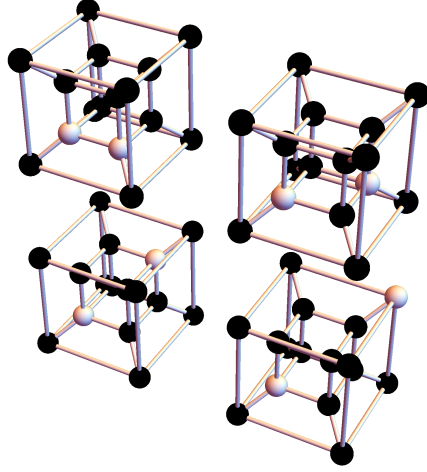

Figure 2.2: In the raster scan order: the white points are 1-antagonists, 2-antagonists, 3-antagonists, and 4-antagonists.

are $(3^n - 1)$ -neighbors to indicate the block in $\mathcal{B}(\mathbb{Z}^n)$ such that p and q are antagonist in this block.

Also, two points which are antagonist in a block of \mathbb{Z}^n of dimension $k \in \llbracket 0, n \rrbracket$ are said k -antagonist. In this case, k of their coordinates differ, and they differ from a value 1, the other coordinates being equal. Two points which are 0-antagonist are equal, two points which are 1-antagonist in a block of \mathbb{Z}^n are $2n$ -neighbours, and two points which are n -antagonist in a block $S \in \mathcal{B}(\mathbb{Z}^n)$ are $(3^n - 1)$ -neighbors. See Figure 2.2 for different possible couple of antagonists (in white) in a 4D space.

Now we are able to define *critical configurations* of dimension $k \in \llbracket 2, n \rrbracket$ in a n -D space:

Definition 3. A set of two points $\{p, q\} \in \mathbb{Z}^n$ such that p and q are antagonist in a block $S \in \mathcal{B}(\mathbb{Z}^n)$ of dimension $k \in \llbracket 2, n \rrbracket$ is called a primary critical configuration of dimension k . Any set equal to a block $S \in \mathcal{B}(\mathbb{Z}^n)$ of dimension $k \in \llbracket 2, n \rrbracket$ minus two points which are antagonist into S is called a secondary critical configuration of dimension k . More generally, a critical configuration (of dimension $k \in \llbracket 2, n \rrbracket$) is either a primary or a secondary critical configuration (of dimension k).

In other words, the set of primary critical configurations can be written

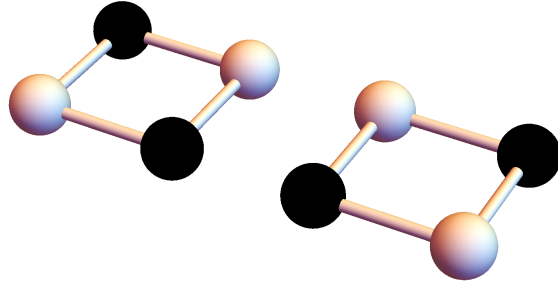

Figure 2.3: The white points on the left draw a 2D primary critical configuration, and the white points on the right draw a secondary 2D critical configuration.

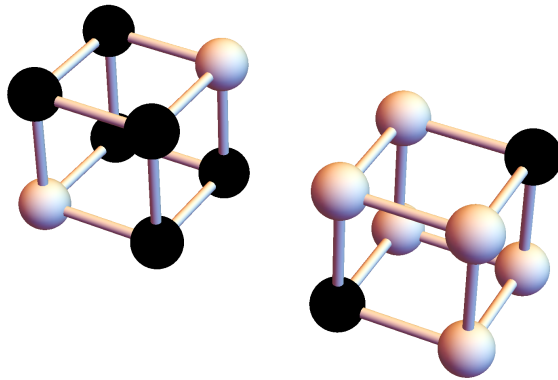

Figure 2.4: The white points on the left draw a 3D primary critical configuration, and the white points on the right draw a secondary 3D critical configuration.

as following:

$$\{\{p, \text{antag}_S(p)\} ; S \in \mathcal{B}(\mathbb{Z}^n), p \in S, \dim(S) \geq 2\},$$

and the set of the secondary critical configurations can be written in this way:

$$\{S \setminus \{p, \text{antag}_S(p)\} ; S \in \mathcal{B}(\mathbb{Z}^n), p \in S, \dim(S) \geq 2\}.$$

Figures 2.3, 2.4 and 2.5 depict 2D, 3D, and 4D critical configurations.

There comes our definition of digitally well-composed sets:

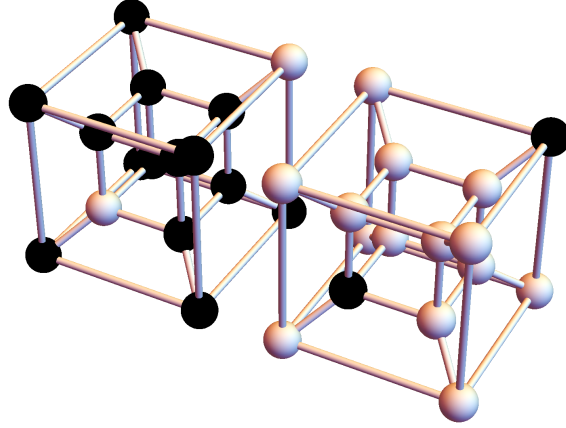

Figure 2.5: The white points on the left draw a 4D primary critical configuration, and the white points on the right draw a secondary 4D critical configuration.

Definition 4. A (digital) set $X \subset \mathbb{Z}^n$ is said digitally well-composed or DWC iff it does not contain any critical configurations, that is, for any block $S \in \mathcal{B}(\mathbb{Z}^n)$, the restriction $X \cap S$ is neither a primary nor a secondary critical configuration.

Obviously, this definition is self-dual, since a set $X \subset \mathbb{Z}^n$ contains a primary (respectively a secondary) critical configuration in the block $S \in \mathcal{B}(\mathbb{Z}^n)$ iff its complement X^c contains a secondary (respectively a primary) critical configuration in this same block S .

We can reformulate digital well-composedness based on $2n$ -paths in dimension 2, 3, but also in dimension $n \geq 4$ as showed by our n -D theorem:

Theorem 1. A set $X \subset \mathbb{Z}^n$ is digitally well-composed iff, for any block $S \in \mathcal{B}(\mathbb{Z}^n)$ and for any couple of points $(p, \text{antag}_S(p))$ such that they belong to $X \cap S$ (resp. $S \setminus X$), p and $\text{antag}_S(p)$ are $2n$ -connected in $X \cap S$ (resp. in $S \setminus X$).

2.2.1 Well-composed gray-level n -D images

Now let us recall the definition of *threshold sets*, coming from the cross-section topology [20, 9, 7, 8]. Let $u : \mathbb{Z}^n \rightarrow \mathbb{R}$ be an image, and let be $\lambda \in \mathbb{R}$ a given

threshold, a *large upper threshold set* is defined as:

$$[u \geq \lambda] = \{x \in \mathbb{Z}^n ; u(x) \geq \lambda\},$$

a *strict upper threshold set* is defined as:

$$[u > \lambda] = \{x \in \mathbb{Z}^n ; u(x) > \lambda\},$$

a *large lower threshold set* is defined as:

$$[u \leq \lambda] = \{x \in \mathbb{Z}^n ; u(x) \leq \lambda\},$$

and a *strict lower threshold set* is defined as:

$$[u < \lambda] = \{x \in \mathbb{Z}^n ; u(x) < \lambda\}.$$

Definition 5 (*n*-D DWC images). *A digital image $u : \mathbb{Z}^n \rightarrow \mathbb{R}$ is said digitally well-composed or DWC iff for every threshold $\lambda \in \mathbb{R}$, all the threshold sets of u are DWC.*

2.2.2 Characterizing DWC real-valued *n*-D images

Like exposed in [10], there exists a characterization for gray-level digitally well-composed images defined on bounded hyperrectangles. It is the natural extension of the characterization of Latecki for 2D images in [17].

Proposition 1. *Let $n \geq 2$ and $s \geq 1$ be two integers and H be a bounded hyperrectangle in \mathbb{Z}^n . A real-valued image $u : \mathcal{D} \subset \mathbb{Z}^n \rightarrow \mathbb{R}$ is digitally well-composed iff for any block $S \in \mathcal{B}(\mathcal{D})$ such that $\dim(S) \geq 2$ and for any couple of points $(p, p') \in S \times S$ such that $p' = \text{antag}_S(p)$, the following relation is true:*

$$\text{intvl}(u(p), u(p')) \cap \text{Span}\{u(p'') \mid p'' \in S \setminus \{p, p'\}\} \neq \emptyset.$$

Chapter 3

Axiomatic Digital Topology and AWCness

Our sources in matter of *Combinatorial Topology* and of *Piecewise Linear Topology* in this chapter are mainly: [12, 6, 1, 11, 14, 1, 4, 2, 18, 11].

3.1 Topology

Definition 6 (Topological spaces [15, 1]). *Let X be a set of points, and let \mathcal{U} be a set of subsets of X such that:*

- $X, \emptyset \in \mathcal{U}$, (TO1)
- any union of any family of elements in \mathcal{U} belongs to \mathcal{U} , (TO2)
- any finite intersection of any family of elements in \mathcal{U} belongs to \mathcal{U} . (TO3)

Then \mathcal{U} is said to be a topology, and the couple (X, \mathcal{U}) is called a topological space. The elements of X are called the points of (X, \mathcal{U}) , and the elements of \mathcal{U} are called the open sets of (X, \mathcal{U}) . We will abusively say that X is a topological space, assuming it is supplied with its topology \mathcal{U} .

An open set which contains a point of X is said to be a *neighborhood* of this point.

Definition 7 (Closed sets and Closure [1]). *Let (X, \mathcal{U}) be a topological space, and let S be a subset of X . A set $S \subseteq X$ is said closed iff it is the complement of an open set in X . The intersection of all the closed sets in X containing M is denoted by $\text{Clo}_{(X, \mathcal{U})}(S)$ and is called the closure of S . When no ambiguity is possible, we will abusively denote it $\text{Clo}(S)$.*

Proposition 2 (Properties of the closure [1]). *Let (X, \mathcal{U}) be a topological space, and let S, T be subsets of X , then:*

- $\text{Clo}(S \cup T) = \text{Clo}(S) \cup \text{Clo}(T)$,
- $S \subseteq \text{Clo}(S)$,
- $\text{Clo}(\emptyset) = \emptyset$.

Definition 8 (Interior [1]). *Let (X, \mathcal{U}) be a topological space. A point p in X is said to be an interior point of S relatively to the topology \mathcal{U} iff there exists $U \in \mathcal{U}$ such that $p \in U \subseteq S$. The set of all the interior points of a set $S \subseteq X$ is denoted by $\text{Int}_{(X, \mathcal{U})}(S)$.*

Note that the interior of a set $S \subseteq X$ is an open set in X .

Definition 9 (Topological boundary [1]). *Let (X, \mathcal{U}) be a topological space. The boundary of a set $S \subseteq X$ is $\text{Clo}(S) \setminus \text{Int}_{(X, \mathcal{U})}(S)$.*

Definition 10 (Relative topology [12]). *Let (X, \mathcal{U}) be a topological space and let S be a subset of X . We call relative topology induced in S by \mathcal{U} the set of all the sets which can be written $U \cap S$ where $U \in \mathcal{U}$. A set which is open in the relative topology of S is said to be a relatively open set.*

Definition 11 (Connectedness [12]). *Let (X, \mathcal{U}) be a topological space. A set $S \subset X$ is said to be connected iff there is no decomposition $S = T_1 \cup T_2$ such that $T_1 \cap T_2 = \emptyset$, both $T_1, T_2 \neq \emptyset$, and relatively open sets with respect to S .*

Proposition 3 (Union of non disjoint connected sets [1] (p.14, Prop. 3.13)). *Let (X, \mathcal{U}) be a topological space. Let A, B be two connected subsets of X . If $A \cap B \neq \emptyset$, then $A \cup B$ is connected.*

Definition 12 (Components [1]). *Let p a point of a topological space (X, \mathcal{U}) . The union of all connected sets containing p is connected, is the largest connected set in (X, \mathcal{U}) containing p , and is called the component of the point p in (X, \mathcal{U}) . We denote it $\mathcal{CC}(X, p)$ where X represents abusively (X, \mathcal{U}) .*

Proposition 4 (Continuous functions). *A function f mapping a topological space (X, \mathcal{U}) to (Y, \mathcal{V}) is said to be continuous iff for any set $U \subseteq Y$ which is open in Y , its inverse image:*

$$f^{-1}(U) \equiv \{x \in X ; f(x) \in U\}$$

is open in X .

Proposition 5 (Image of a connected set). *The image by a continuous mapping of a connected topological space is a connected topological space.*

3.2 Regular open/closed sets

Let \mathcal{T} be a topological space. Then, $\text{Int}_{\mathcal{T}}$ denotes the interior operator and $\text{Clo}_{\mathcal{T}}$ the closure operator in this topological space.

Definition 13. *A set X subset of a topological space \mathcal{T} is said to be a regular open set iff $X = \text{Int}_{\mathcal{T}}(\text{Clo}_{\mathcal{T}}(X))$.*

Definition 14. *A set X subset of a topological space \mathcal{T} is said to be a regular closed set iff $X = \text{Clo}_{\mathcal{T}}(\text{Int}_{\mathcal{T}}(X))$.*

3.3 T_0 -spaces and Alexandrov Spaces

Definition 15 (Degenerate sets [1]). *Let (X, \mathcal{U}) be a topological space. A set $M \subseteq (X, \mathcal{U})$ is said to be degenerate if it consists of only one point.*

Definition 16 (T_0 Axiom and T_0 -spaces [3, 15, 1]). *We say that a topological space (X, \mathcal{U}) verifies the T_0 axiom of separation iff it for any two different points in X , at least one has a neighborhood not containing the other, or equivalently iff two distinct degenerate subsets of X have distinct closures in (X, \mathcal{U}) . A topological space which verifies the T_0 axiom of separation is said to be a T_0 -space.*

Definition 17 (Discrete Spaces [4]). *A topological space (X, \mathcal{U}) is said discrete iff the intersection of any family of open sets of X is open in X , or equivalently iff the union of any family of closed sets of X is closed in X .*

Definition 18 (Alexandrov Spaces [12]). *A discrete T_0 -space is said to be an Alexandrov space.*

Proposition 6 (Smallest open/closed sets [12]). *Let (X, \mathcal{U}) be an Alexandrov space. For any point $P \in X$, there exists a smallest neighborhood of P in X :*

$$OP = \bigcap_{U \in \mathcal{U} \text{ s.t. } P \in U} U.$$

Due to the symmetry of Alexandrov spaces, there exists also a smallest closed set containing P :

$$CP = \bigcap_{U \text{ closed in } X \text{ s.t. } P \in U} U.$$

Alexandrov spaces get some interesting properties [12]:

Theorem 2. *Let (X, \mathcal{U}) be an Alexandrov space, and P, Q be two points of X .*

1. *if $P \neq Q$, then:*
 - $P \in OQ \Rightarrow Q \notin OP$,
 - $P \in CQ \Rightarrow Q \notin CP$,
2. $P \in CQ \Leftrightarrow Q \in OP$,
3. $CP \subseteq CQ \Leftrightarrow OQ \subseteq OP$.

Definition 19 (Locally finite). *A topological space (X, \mathcal{U}) is said to be locally finite if each point $P \in X$ has as finite neighborhood and a finite closed set containing P .*

Theorem 3 (Path-connectivity and Connectivity in Alexandrov spaces [12]). *Let (X, \mathcal{U}) be an Alexandrov space. Then $S \subseteq X$ is connected iff it is path-connected.*

3.4 Partially ordered sets

Definition 20 (Binary relation [6]). *Let X be an arbitrary set. A binary relation R on X is as subset of the cartesian product $X \times X$:*

$$R \subseteq X \times X.$$

Equivalently, a binary relation R on X is a mapping from $X \times X$ to $\{0, 1\}$ such that $\forall x, y \in X$:

$$\{(x, y) \in R\} \Rightarrow \{R(x, y) = 1\}, \text{ and } \{(x, y) \notin R\} \Rightarrow \{R(x, y) = 0\}.$$

Sometimes will denote by xRy or by $y \in R(x)$ the fact that $(x, y) \in R$.

Definition 21 (Properties of binary relations [6]). *A binary relation is said:*

- reflexive *iff*, $\forall x \in X, (x, x) \in R$,
- irreflexive *iff*, $\forall x \in X, (x, x) \notin R$,
- symmetrical *iff*, $\forall x, y \in X, (x, y) \in R \Leftrightarrow (y, x) \in R$,
- asymmetrical *iff*, $\forall x, y \in X, (x, y) \in R \text{ and } (y, x) \in R \Rightarrow x = y$,
- transitive *iff*, $\forall x, y, z \in X, (x, y) \in R \text{ and } (y, z) \in R \Rightarrow (x, z) \in R$.

Definition 22 (Inverse of a binary relation [6]). *Let X be a set, and R a relation order on X . We say that the binary relation R' on X such that $\forall x, y \in X, (x, y) \in R \Leftrightarrow (y, x) \in R'$, is the inverse of R .*

Notations 1 (R^\square [6]). *Let X be a set, and R a relation order on X . We will note R^\square the relation order defined such that, $\forall x, y \in X$:*

$$\{(x, y) \in R^\square\} \Leftrightarrow \{(x, y) \in R \text{ and } x \neq y\}.$$

Definition 23 (Order relation [6]). *Let \mathcal{O} be a set of arbitrary elements. An order relation on \mathcal{O} is a binary relation on X such that R is reflexive, antisymmetric, and transitive.*

Definition 24 (Posets/Orders [6]). *A set X of arbitrary elements supplied with an order relation R on X is denoted (X, R) or $|X|$ and is said to be a partially ordered set (poset) or simply an order. We will also say that the order relation R is associated to X , and that X is the domain of the poset (X, R) .*

Notations 2 (α, β and θ [6]). *Let $|X|$ be a partially ordered set. We will usually denote by α_X the order relation associated to its domain X , in such a way that $\mathcal{O} = (X, \alpha_X)$. Also, we will write β_X the inverse of α_X , and $\theta_X = \alpha_X \cup \beta_X$.*

Notations 3 (α, β and θ applied to sets). *By extension, we will define for any X subset of a partially ordered set:*

$$\alpha(X) = \bigcup_{x \in X} \alpha(x),$$

$$\beta(X) = \bigcup_{x \in X} \beta(x),$$

$$\theta(X) = \bigcup_{x \in X} \theta(x).$$

Notations 4 ($\alpha_X(x)$, $\beta_X(x)$, $\theta_X(x)$ [6]). Let $|X|$ be a partially ordered set, and let x be a point in its domain X . Then we denote:

- $\alpha_X(x) = \{p \in X ; p \leq x\}$,
- $\beta_X(x) = \{p \in X ; x \leq p\}$,
- $\theta_X(x) = \alpha_X(x) \cup \beta_X(x)$.

$\alpha_X(p)$ is called the closure of p in $|X|$ and is the minimal closed set in X containing x , $\beta_X(p)$ is called the star of p in $|X|$, and is the minimal open set in X containing X , and $\theta_X(x)$ is called the neighborhood of p in $|X|$.

To forge the intuition let us cite an example [1] of partially ordered sets: the set consisting of the points, straightlines, and planes of an Euclidian space is partially ordered by letting a point (respectively a straight line) precedes any straight line (respectively plane) containing it. In this case, if $p \in \mathcal{O}$ is a point, $\alpha(p)$ is simply the set made of this point $\{p\}$. If p is a straight line, $\alpha(p)$ is this straight line plus all the points lying on this line. If p is a plane, $\alpha(p)$ is this plane, plus all the straightlines lying in this plane, plus all the points lying in this plane. Also, if p is a point, $\beta(p)$ is this point, plus all the straightlines containing this point, plus all the planes containing this point. If p is a straight line, $\beta(p)$ is this straight line, plus all the planes containing this straightline. Finally, if p is a plane, $\beta(p)$ is the set made of this plane.

Note that the set \mathcal{O} of all the subsets of an arbitrary set M :

$$\mathcal{O} = \{A ; A \subseteq M\},$$

is also a partially ordered set. Futhermore, if $A_1, A_2 \in \mathcal{O}$, $A_1 > A_2$ means that A_2 is a proper subset of A_1 , which can be written $A_2 \subset A_1$. The resulting order is called the *natural order* in the collection of set \mathcal{O} . It is also called the *order based on the inclusion*. We will see the importance of this order using *Khalimsky grids* in a further subsection.

Definition 25 (Isomorphic orders [6]). Let $|X| = (X, \alpha_X)$ and $(|Y| = (Y, \alpha_Y)$ be two orders. Then, these two orders are said isomorphic (in the order sense) iff there exists an isomorphism in the order sense between $|X|$ and $|Y|$, that is, a bijection $f : X \rightarrow Y$ such that for any couple (x_1, x_2) of elements of X :

$$\{x_1 \in \alpha_X(x_2)\} \Leftrightarrow \{f(x_1) \in \alpha_Y(f(x_2))\}.$$

Notations 5 (Empty order [11]). *Note that all the orders whose domain is empty are isomorph, and we denote them by $|\emptyset|$.*

Definition 26 (Suborders [6]). *Let $|X| = (X, \alpha_X)$ be an order, and let S be a subset of X . The suborder of $|X|$ relative to S is the order (S, α_S) with $\alpha_S = \alpha_X \cap (S \times S)$. If no ambiguity is possible, we will write $(S, \alpha_S) = |S|$.*

Proposition 7 ($\alpha_S(x)$, $\beta_S(x)$, $\theta_S(x)$ [6]). *Let $(X, \alpha_X) = |X|$ be an order, and S be a subset of X inducing a suborder $(S, \alpha_S) = |S|$. Then for any $x \in S$, $\alpha_S(x) \equiv \alpha_X(x) \cap S$, $\beta_S(x) \equiv \beta_X(x) \cap S$, and $\theta_S(x) \equiv \theta_X(x) \cap S$.*

Definition 27 (Rank [6]). *Let $(X, \alpha_X) = |X|$ be an order. The rank $\rho_X(x)$ of an element x in $|X|$ is 0 if $\alpha_X^\square(x) = \emptyset$ and is equal to:*

$$\max_{y \in \alpha_X^\square(x)} (\rho_X(y)) + 1$$

either. The rank of an order $|X|$ is denoted by $\rho(|X|)$ and is equal to the maximal rank of its elements:

$$\rho(|X|) = \max_{x \in X} (\rho_X(x)).$$

As underlined by Daragon [11], the notion of dimensions and of ranks are different, even if they often match: the dimension of an object is inherent to an object, when the notion of rank depends of the elements that lie into the neighborhood.

Definition 28 (Point/ k -element [6]). *Let $(X, \alpha_X) = |X|$ be an order. An element of X such that $\rho_X(x) = k$ is called point or k -element of X .*

3.5 From posets to $T0$ -spaces

There comes a much important theorem of Alexandrov [1] relating orders and Alexandrov spaces.

Theorem 4 (Theorem 6.52 [1] (p.28)). *Let \mathcal{O} be a partially ordered set, and let A be a subset of \mathcal{O} . We shall say that A is closed iff for any $p, p' \in \mathcal{O}$:*

$$\{p \in A \text{ and } p' < p\} \Rightarrow \{p' \in A\}.$$

This topology (based on the closed sets) converts \mathcal{O} into an Alexandrov space $(X, \mathcal{U}) = f(\mathcal{O})$. Conversely, every Alexandrov space (X, \mathcal{U}) can be turned into a partially ordered set $\mathcal{O} = \phi((X, \mathcal{U}))$ if, for any two distinct elements $p, p' \in (X, \mathcal{U})$, $p' < p$ is taken to mean that $p' \in \alpha(p)$. It follows that $f(\phi((X, \mathcal{U}))) = (X, \mathcal{U})$ and $\phi(f(\mathcal{O})) = \mathcal{O}$.

As explained by this theorem [1], partially ordered sets can be identified with Alexandrov spaces in such a way that $\alpha_{\mathcal{O}}(p)$ is synonymous with the (topological) closure in the equivalent Alexandrov space $f(\mathcal{O})$, and $\beta_{\mathcal{O}}(p)$ is equal to the minimal (open) neighborhood of the point p in $f(\mathcal{O})$ (where $\beta = \alpha^{-1}$).

3.6 Khalimsky Grids

Definition 29 (Khalimsky Grids [16]). *The Khalimsky grid of dimension n is denoted $|\mathbb{H}^n| = (\mathbb{H}^n, \supseteq)$ and is defined as the order such that:*

$$\begin{aligned} \mathbb{H}_0^1 &= \{\{a\}; a \in \mathbb{Z}\}, \\ \mathbb{H}_1^1 &= \{\{a, a+1\}; a \in \mathbb{Z}\}, \\ \mathbb{H}^1 &= \mathbb{H}_0^1 \cup \mathbb{H}_1^1, \\ \mathbb{H}^n &= \{h_1 \times \cdots \times h_n; \forall i \in [1, n], h_i \in \mathbb{H}^1\}. \end{aligned}$$

Definition 30 (Cubical complexes). *Let \mathcal{X} be a subset of $(\mathbb{H}^n, \alpha_{\mathbb{H}^n})$. We say that \mathcal{X} is a cubical complex iff its is closed under inclusion, that is, for any element h of \mathcal{X} , all the elements h' of \mathbb{H}^n such that $h' \subseteq h$ are elements of \mathcal{X} . In other words, $X = \alpha_{\mathbb{H}^n}(\mathcal{X})$.*

Figure 3.1 shows two usual representations depicting a same cubical complex. On the left, we perceive the elements of \mathbb{H}^n as sets of points of \mathbb{Z}^n , and we clearly see when their intersection is empty or not. On the right, we perceive elements of \mathbb{H}^n as geometric objects (vertices, edges, squares, cubes, and so on), this is the *splitted representation*, whose name is justified by the fact that even elements whose intersection is non empty are separated on the representation.

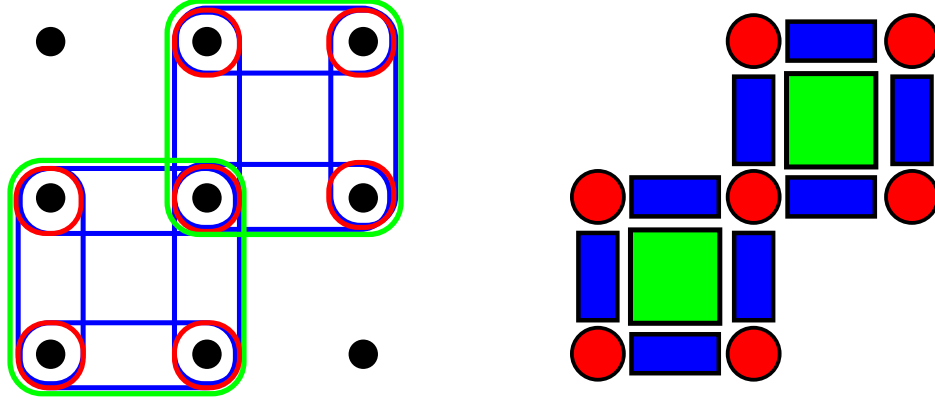

Figure 3.1: Different representations of the same cubical complex.

A consequence of Definition 29, showing that $\alpha = \supseteq$, is that for any $h \in \mathbb{H}^n$, we have the following equalities for the closure, the opening, and the neighborhood:

$$\begin{aligned}\alpha(h) &= \{h' \in \mathbb{H}^n ; h' \subseteq h\}, \\ \beta(h) &= \{h' \in \mathbb{H}^n ; h \subseteq h'\}, \\ \theta(h) &= \{h' \in \mathbb{H}^n ; h' \subseteq h \text{ or } h \subseteq h'\}.\end{aligned}$$

Obviously, any suborder $|X|$ of $|\mathbb{H}^n|$ verifies that its associated order relation α_X equals $\supseteq \cap X \times X$ which corresponds to the inclusion order restricted to X , and then for any $h \in X$:

$$\begin{aligned}\alpha_X(h) &= \{h' \in X ; h' \subseteq h\}, \\ \beta_X(h) &= \{h' \in X ; h \subseteq h'\}, \\ \theta_X(h) &= \{h' \in X ; h' \subseteq h \text{ or } h \subseteq h'\}.\end{aligned}$$

Definition 31 (Dimension and \mathbb{H}_k^n). *Any element h of \mathbb{H}^n which is the cartesian product of k elements, with $k \in \llbracket 0, n \rrbracket$, of \mathbb{H}_1^1 and of $(n-k)$ elements of \mathbb{H}_0^1 is said to be of dimension k , which is denoted by $\dim(h) = k$, and the set of all the elements of \mathbb{H}^n which are of dimension k is denoted by \mathbb{H}_k^n .*

Property 1. *For any $k \in \llbracket 0, n \rrbracket$, any element h in \mathbb{H}_k^n is of rank $\rho(h, |\mathbb{H}^n|) =$*

k . In other words, in the Khalimsky grids, the dimension is equal to the rank in $|\mathbb{H}^n|$.

Proof: Let us proceed by induction on the dimension of $h \in \mathbb{H}^n$.

Initialisation ($\dim(h) = 0$): When $\dim(h) = 0$, there exists $a \in \mathbb{Z}^n$ such that $h = \otimes_{i \in \llbracket 1, n \rrbracket} \{a_i\}$, and then by Lemma 1, $\alpha(h) = \otimes_{i \in \llbracket 1, n \rrbracket} \{\{a_i\}\} = \{h\}$, then $\alpha^\square(h) = \emptyset$, and then the rank of h in $|\mathbb{H}^n|$ is equal to 0.

Induction ($\dim(h) \in \llbracket 1, n \rrbracket$): We assume that for any $i \in \llbracket 0, k-1 \rrbracket$, when the dimension of h is lower than or equal to $(k-1)$, the dimension is equal to the rank in $|\mathbb{H}^n|$. Let us now assume that $\dim(h) = k$, we can rearrange the space coordinates such that h can be written:

$$h = \otimes_{i \in \llbracket 1, k \rrbracket} \{a_i, a_i + 1\} \otimes \otimes_{i \in \llbracket k+1, n \rrbracket} \{a_i\},$$

and then by the closure operator we obtain by Lemma 1:

$$\alpha(h) = \otimes_{i \in \llbracket 1, k \rrbracket} \{\{a_i\}, \{a_i, a_i + 1\}, \{a_i + 1\}\} \otimes \otimes_{i \in \llbracket k+1, n \rrbracket} \{\{a_i\}\}.$$

In other words, the only element of $\alpha(h)$ of dimension k is h itself, all the other elements being of dimension in $\llbracket 0, k-1 \rrbracket$, and then:

$$\max \{ \dim(h') ; h' \in \alpha^\square(h) \} = k - 1.$$

When the dimension is lower than or equal to $(k-1)$, the dimension equals the rank in $|\mathbb{H}^n|$, and then we obtain:

$$\max \{ \rho(h', |\mathbb{H}^n|) ; h' \in \alpha^\square(h) \} = k - 1,$$

and then the rank of h is k .

Finally, we obtained that for any value of k , and then for any element of \mathbb{H}^n , the dimension equals the rank in $|\mathbb{H}^n|$. \square

Proposition 8 (Khalimsky grids are Alexandrov spaces [6]). *For any $n \geq 1$, the Khalimsky grids $|\mathbb{H}^n = (\mathbb{H}^n, \alpha)|$ supplied with the order relation $\alpha = \supseteq$, as defined in Theorem 4, is an Alexandrov space.*

Figure 3.2, Figure 3.3, and Figure 3.4 show the different possible closures/openings/neighborhoods in the case of a “point”, an “edge”, and a “square” in \mathbb{H}^2 . We will see next that these *Kovalevsky cells* will be called

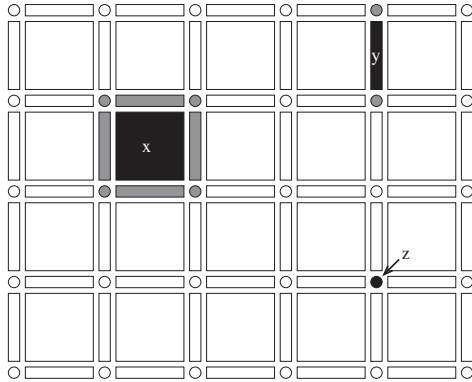

Figure 3.2: The closures $\alpha(x)$, $\alpha(y)$, $\alpha(z)$ in \mathbb{H}^2 [11] (p. 34)

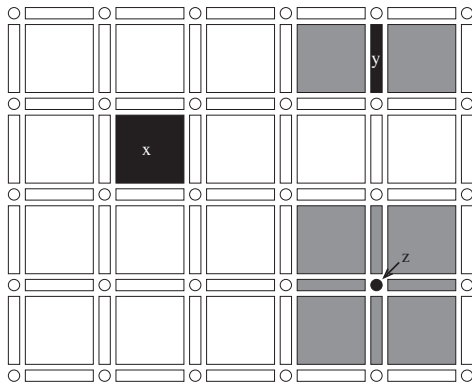

Figure 3.3: The openings $\beta(x)$, $\beta(y)$, $\beta(z)$ in \mathbb{H}^2 [11] (p. 34)

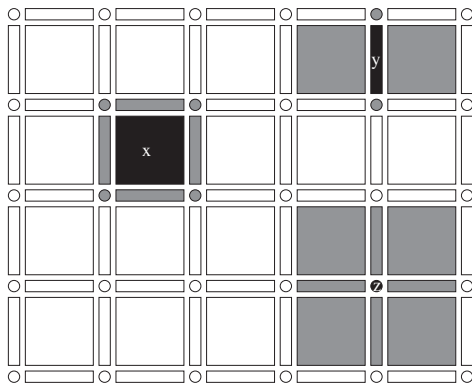

Figure 3.4: The neighborhoods $\theta(x)$, $\theta(y)$, $\theta(z)$ in \mathbb{H}^2 [11] (p. 34)

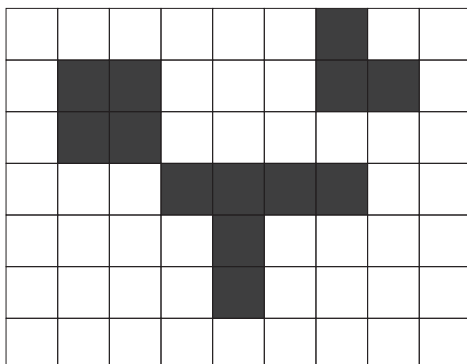

Figure 3.5: A binary image u_{bin} in \mathbb{Z}^2 [11] (p. 31)

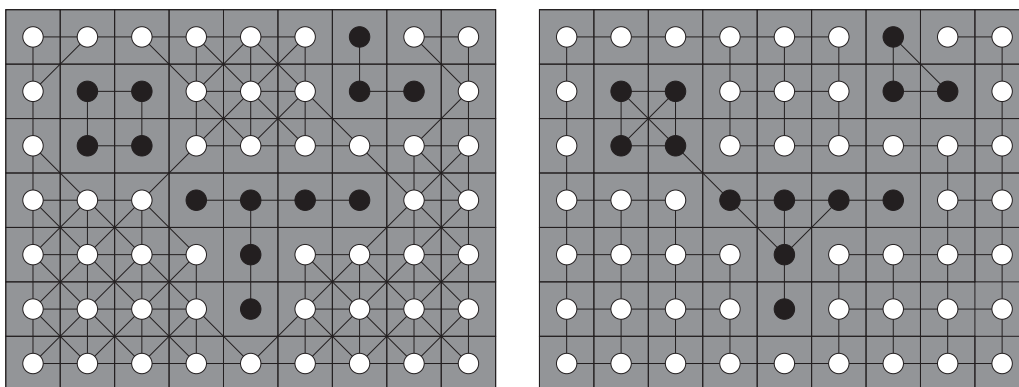

Figure 3.6: u_{bin} [11] (p. 31) supplied with the $(4, 8)$ -topology on the left and with the $(8, 4)$ -topology on the right (the foreground is in black and the background in white).

respectively 0 -faces, 1 -faces, and 2 -faces and that this notion exists in any finite dimension.

Starting from a binary image u_{bin} or equivalently from a set whose u_{bin} is the characteristic image depicted on Figure 3.5, we can supply this image with the $(4, 8)$ -topology, or the $(8, 4)$ -topology very usual in digital topology (see Figure 3.6). Just observe then the different connected components of the foreground that result from this choice: 3 components in the first choice, and 2 in the second choice.

No, let us immerse the image in \mathbb{H}^2 in different manners. In the raster scan order, the first is the most simple, we do a $(1 - 1)$ - mapping between the two

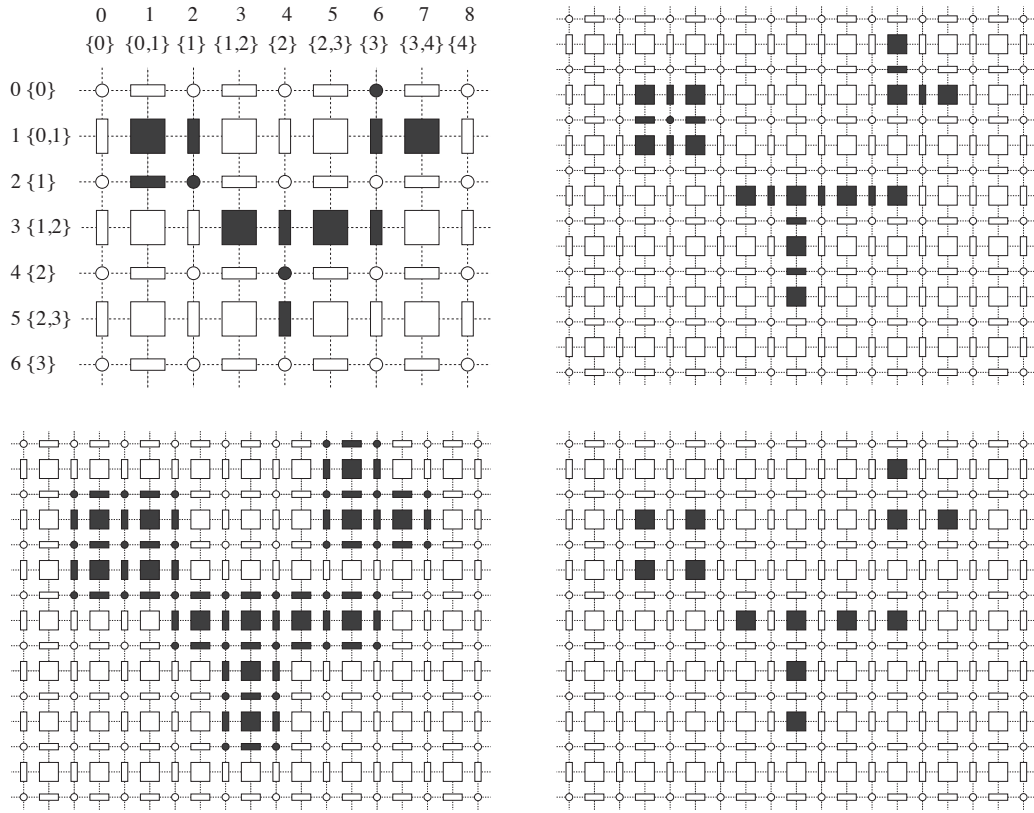

Figure 3.7: Different immersions of u_{bin} into \mathbb{H}^2 (the 3 first pictures are extracted from p. 31 of [11]).

spaces, but this space is not invariant by translation. The second approach uses the *miss strategy* (which reflects the $(4, 8)$ -topology): the elements of \mathbb{Z}^2 are mapped to the squares of \mathbb{H}^2 , and each point or edge in \mathbb{H}^2 whose all the neighboring squares are in the foreground are assigned as foreground too. The third approach uses the *hit strategy* (which reflects the $(8, 4)$ -topology): the elements of \mathbb{Z}^2 are mapped to the squares of \mathbb{H}^2 , and each point or edge in \mathbb{H}^2 which is a face of a square of the foreground is assigned as foreground too. The fourth approach corresponds to the isomorphism \mathcal{H}_n we are going to use, and which is such that elements of \mathbb{Z}^n become n -cubes.

Definition 32 (Paths [6]). *Let $|X|$ be an order. A path from $x \in X$ to $y \in X$ is a sequence $(p^0 = x, p^1, \dots, p^{k-1}, p^k = y)$ of elements of X such that for any $i \in \llbracket 0, k-1 \rrbracket$, $x \in \theta_X(y)$.*

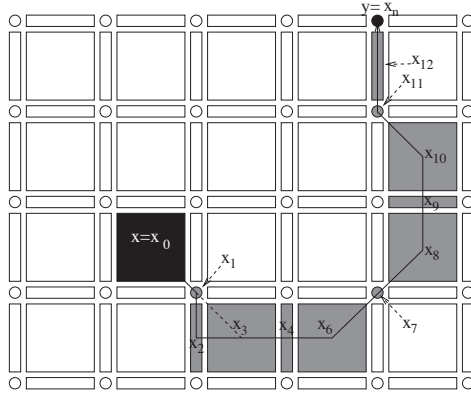

Figure 3.8: A path in \mathbb{H}^2 [11] (p.34)

Figure 3.8 depicts a path in \mathbb{H}^2 .

Definition 33 (Connectivity of an order [6]). *An order, as every topological space, is connected iff it cannot be partitioned into two non-empty open sets.*

Effectively, this definition holds since Alexandrov spaces and partially ordered sets are equivalent by Theorem 4 [1].

Definition 34 (Path-connectivity of an order [6]). *An order $|X|$ is said connected by path or path-connected iff for any couple (x, y) of elements of X , there exists a path from x to y into $|X|$.*

Theorem 5 (Connectivity VS path-connectivity [6]). *Let $|X|$ be a partially ordered set. Then $|X|$ is connect iff it is path-connected.*

Since the pathwise-connectivity between two points x, y belonging to an order constitutes a binary relation which is reflexive, symmetrical, and transitive, that is, an *equivalence relation* on X , we can define the equivalence classes of X in \mathbb{H}^n as the *connected components* of X in \mathbb{H}^n :

Definition 35 (Connected components [6]). *Let $|X|$ be an order. A connected component C of $|X|$ is a subset of X such that for any couple (x, y) of elements of C , there exists a path from x to y lying entirely into C , and such that C is maximal for this property.*

Definition 36 (Simple closed curve [6]). *An order $|X| = (X, \alpha_X)$ is a simple closed curve if for any point $x \in X$, $\text{Card}(\theta_X^\square(x)) = 2$ and such that the couple (y, z) of elements of $\theta_X^\square(x)$ verifies that $y \notin \theta_X^\square(z)$.*

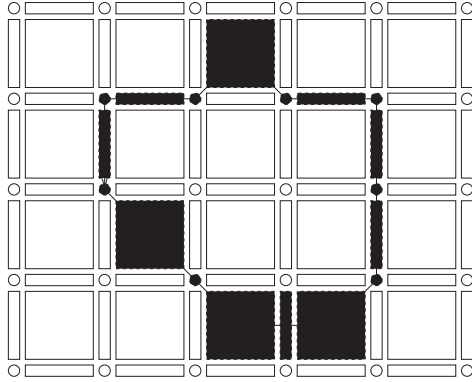

Figure 3.9: A simple closed curve in \mathbb{H}^2 [11] (p.34)

As proved in [16], a simple closed curve (see Figure 3.9) separates \mathbb{H}^2 and then satisfies an analog of the Jordan curve theorem in the 2D Khalimsky grids.

3.7 Order Joins

Definition 37 (Order Join [6]). *Let $|X|, |Y|$ be two orders. It is said that $|X|$ and $|Y|$ can be joined if $X \cap Y = \emptyset$. If $|X|$ and $|Y|$ can be joined, the join of $|X|$ and $|Y|$ is defined as the order:*

$$|X| * |Y| = (X \cup Y, \alpha_X \cup \alpha_Y \cup X \times Y).$$

Some properties [11] of the join are important to remark:

- the empty order $|\emptyset|$ is the neutral element of the join operator: $|X| * |\emptyset| = |\emptyset| * |X| = |X|$,
- the operator $*$ is not commutative,
- the operator $*$ does not create new elements, it adds some order relations between the elements of X and the elements of Y ,
- the elements of Y keep their initial rank when the join operation is applied, when the elements of X have a rank which is incremented by the rank of Y plus one.

The construction of an order join can be made in this way: we put on the top each element of X , and at the bottom all the elements of Y . Then we connect the elements of X according to α_X , and then the elements of Y according to α_Y . Finally, we connect each element of X to each element of Y , and we have obtained the Hasse diagram of the order join.

Property 2 (Order join and $\theta_X^\square(x)$ [11](Property 1)). *Let $|X|$ be an order. Then for any $x \in X$:*

$$|\theta_X^\square(x)| = |\beta_X^\square(x)| * |\alpha_X^\square(x)|.$$

We will see in this section that as is the thesis of Daragon [11], this equi-laty is particularly crucial, since it allows to “decompose” the neighborhood of a point of \mathbb{H}^n into two orders which own many very strong topological properties.

Property 3 ($\theta_{X*Y}^\square(x)$ [11](Property 2)). *Let $|X|$ and $|Y|$ be two orders that can be joined. Then let x be an element of X and y be an element of Y . Then we obtain that $|\theta_{X*Y}^\square(x)| = |\theta_X^\square(x)| * |Y|$ and $|\theta_{X*Y}^\square(y)| = |X| * |\theta_Y^\square(y)|$.*

On Figure 3.10, three orders of increasing complexity are depicted. Their joins are depicted on Figure 3.11 and Figure 3.12. Note that the Hasse diagrams are on the top, and the geometrical representation at the bottom. Observe that the rank of these orders is straightforward to compute looking at their Hasse diagrams.

3.8 n -surfaces

Definition 38 (CF-orders [6]). *Let $|X| = (X, \alpha_X)$ be a partially ordered set. $|X|$ is said countable iff its domain X is countable. Also, $|X|$ is said locally finite iff for any element $x \in X$, the set $\theta_X(x) = \{y \in X ; (x, y) \in \theta_X\}$ is finite. A partially ordered set which is countable and locally finite is said to be a CF-order.*

Now let us recall the definition of *discrete surfaces* or *n -surfaces* of Evako, Kopperman and Mukhin [13] which will be essential to define well-composedness in the sense of Alexandrov.

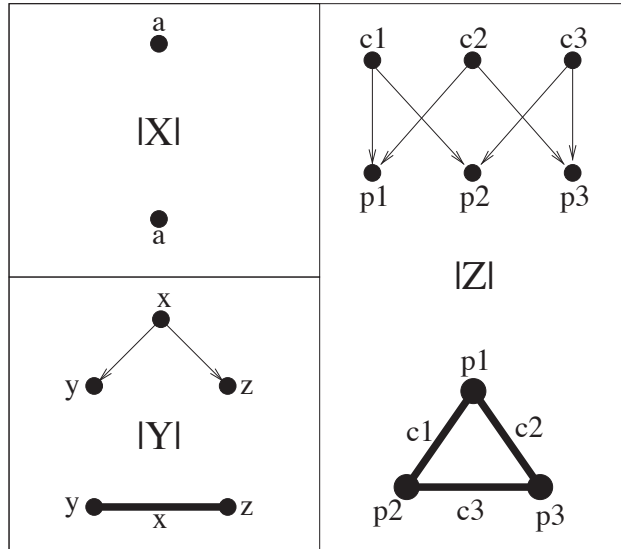

Figure 3.10: Three examples of orders $|X|, |Y|, |Z|$. [11] (p.37)

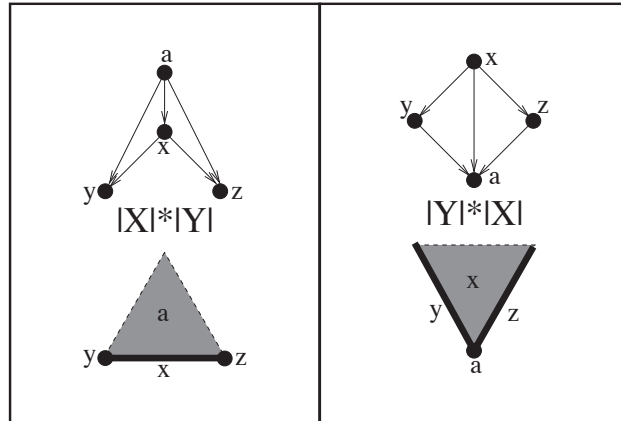

Figure 3.11: The join operator $*$ is not commutative. [11] (p.37)

Definition 39 (n -surface). Let $|X| = (X, \alpha_X)$ be a CF-order. The order $|X|$ is said to be:

- a (-1) -surface iff $X = \emptyset$,
- a 0 -surface iff X is made of two elements $x, y \in X$ which are not neighbors the one of the other one: $x \notin \alpha_X(y)$ and $y \notin \alpha_X(x)$,

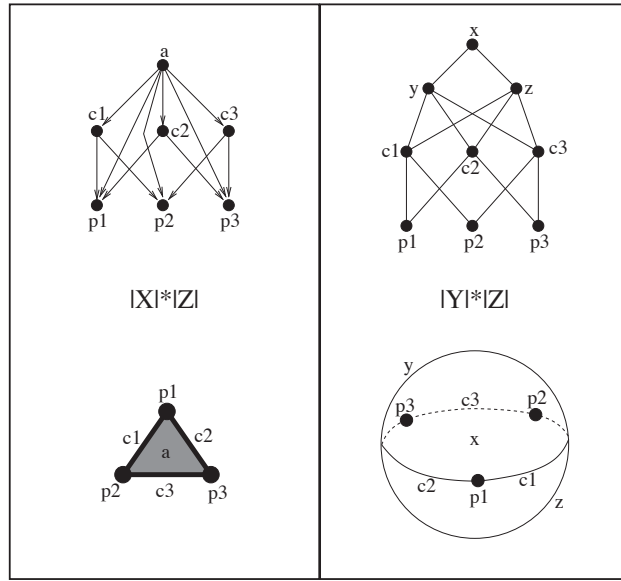

Figure 3.12: Some order joins representing a *simplicial complex* on the left and a sphere on the right [11] (p.37)

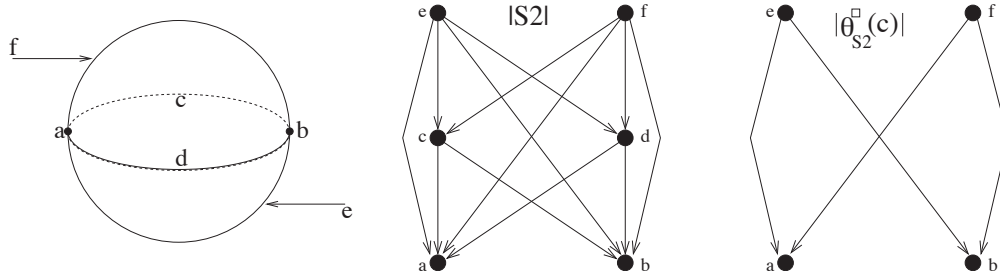

Figure 3.13: A 2-surface: the sphere \mathcal{S}_2 [11] (p.50)

- a n -surface, $n \geq 1$, iff $|X|$ is connected and for any $x \in X$, the order $|\theta_X^\square(x)|$ is a $(n - 1)$ -surface.

To forge the intuition on discrete surfaces, we propose to show an example extracted from [11]. On Figure 3.13, we can observe according to Daragon [11] the most simple 2-surface: the *sphere* $|\mathcal{S}_2|$. It is made of 6 elements: $\mathcal{S}_2 = \{a, b, c, d, e, f\}$, and any point $x \in \mathcal{S}_2$ verifies that its neighborhood $|\theta_{\mathcal{S}_2}^\square(x)|$ is a 1-surface. Effectively, the neighborhood of any point

$y \in \theta_{\mathbb{S}_2}^\square(x)$, we have that $\left| \theta_{\theta_{\mathbb{S}_2}^\square(x)}^\square(y) \right|$ is made of two points which are not neighbors, that is, is a 0-surface.

Another example of 2-surface is simply $|\mathbb{H}^2|$: the neighborhood of any point of \mathbb{H}^2 is a simple close curve. Effectively, as proven by Evako *et al.* in [13]:

Theorem 6. *The order $|\mathbb{H}^n|$ is a (discrete) n -surface.*

Note that this theorem is fundamental and will have many implications later in our proof that well-composedness in the sense of Alexandrov and digital well-composedness are equivalent.

Also, Daragon [11] proved this following theorem on partially ordered sets:

Theorem 7. *Let $|X|$ and $|Y|$ be two orders that can be joined, and let $n \in \mathbb{N}$ be an integer. The order $|X|*|Y|$ is a $(n + 1)$ -surface iff there exists some $p \in \llbracket -1, n + 1 \rrbracket$ such that $|X|$ is a p -surface and $|Y|$ is a $(n - p)$ -surface.*

The proof of this theorem is based on Property 3 due to Bertrand [6].

Definition 40 (Homogeneity [11]). *An order $|X|$ is said homogeneous iff for any element $x \in X$, $\theta_X(x)$ contains a n -element.*

Property 4 (Rank of a n -surface [13]). *Let $|X|$ be a n -surface. The rank of $|X|$ is equal to n .*

Property 5 (Homogeneity of n -surfaces [11]). *Let $|X|$ be a n -surface. Any element x of $|X|$ is θ -neighbor of a n -element of $|X|$.*

Property 6 (Decomposition of a n -surface (Property 10 in [11])). *Let $|X| = (X, \alpha_X)$ be an order. Then $|X|$ is a n -surface iff for any $x \in X$, $|\alpha_X^\square(x)|$ is a $(k - 1)$ -surface and $|\beta_X^\square(x)|$ is a $(n - k - 1)$ -surface, with $k = \rho(x, |X|)$.*

Since this property will be fundamental next, let us show an example of the β^\square -adherence and of the α^\square -adherence of a point $x \in \mathbb{H}^3$ of rank 2 in $|\mathbb{H}^3|$ (see Figure 3.14). Since x is a 2-element, its α^\square -adherence is a 1-surface, and its β^\square -adherence is a 0-surface.

Definition 41 (Separation [11]). *Let $|X|$ be an order, and let Y be a strict subset of X . Then it is said that $|Y|$ separates $|X|$ iff $|X \setminus Y|$ is not connected.*

For example, if $|X|$ is a n -surface, and Y is a strict subset of X such that $|Y|$ is a k -surface, then necessarily $k = n - 1$ (as in continuous topology using topological n -manifolds).

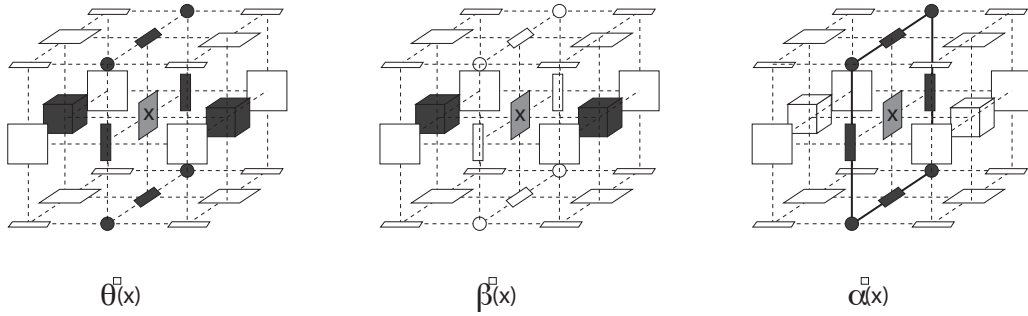

Figure 3.14: Different kinds of *adherences* of a 2-element in \mathbb{H}^3 [11] (p.54)

3.9 Closed Orders

Definition 42 (Closed orders [11]). Let $|X| = (X, \alpha_X)$ be an order. $|X|$ is said to be closed iff for any $z \in X$, and for any $y \in \alpha_X^\square(x)$, for any value $i \in [\rho(y, |X|), \rho(x, |X|)[$:

$$\exists z \in \alpha_X^\square(x) \cap \beta_X^\square(x) \text{ s.t. } \rho(z, |X|) = i.$$

In other words, this relation means that there exists in a closed order elements “between” x and y which are of any rank between the rank of x and the rank of y in the order. It recalls simplicial complexes which are *closed by inclusion* in the sense that for any k -simplex in a simplicial complex S , there exists at least one l -simplex in S which is a face of s for any value l in $\llbracket 0, k \rrbracket$ (since a simplicial complex contains by definition all the faces of its elements).

Property 7 (n -surfaces are closed orders [11] (Property 20 p.63)). Let $|X|$ be an order. If $|X|$ is a n -surface, $|X|$ is a closed order.

3.10 Plain maps

Let us now recall some mathematical background coming from [5, 21].

Let $\mathcal{A} = (X, \mathcal{U})$ be an Alexandrov space.

Definition 43. An application $F : X \rightarrow \mathcal{P}(\mathbb{R})$ (which is also written $F : X \rightsquigarrow \mathbb{R}$) is said to be a set-valued map. The domain of F is the set $\mathcal{D}(F) \subseteq X$ such that $\forall x \in X, F(x) \neq \emptyset \Leftrightarrow x \in \mathcal{D}(F)$.

Definition 44. A set-valued map $F : X \rightsquigarrow \mathbb{R}$ is said to be upper semi-continuous (USC) at $x \in \mathcal{D}(F)$, for any neighborhood \mathcal{U} of $F(x)$, $\forall x' \in \beta(x)$, $F(x') \subseteq \mathcal{U}$. A set-valued map is said to be upper semi-continuous (USC) iff it is USC at each point $x \in \mathcal{D}(F)$.

Definition 45. A set-valued USC map $F : X \rightsquigarrow \mathbb{R}$ is said to be a (closed) quasi-simple map iff for any $x \in \mathcal{D}(F)$, $F(x)$ is a closed connected set and furthermore, for any $x \in \mathcal{D}(F)$ such that $\{x\} = \beta(x)$, $F(x)$ is degenerate.

Definition 46. A quasi-simple map $F : X \rightsquigarrow \mathbb{R}$ is said to be a simple map iff for any quasi-simple map $F_2 : X \rightsquigarrow \mathbb{Z}$ such that $F(x) = F_2(x)$ when $x \in \mathcal{D}$ is such that $\beta(x) = \{x\}$, then for any $x \in \mathcal{D}(F)$, $F(x) \subseteq F_2(x)$.

Definition 47. A set-valued map $F : X \rightsquigarrow \mathbb{R}$ is said to be a plain map iff it is a closed-valued interval-valued simple map.

Now, let us assume that A and B are two topological spaces.

Definition 48. Let $F : A \rightsquigarrow B$ be a set-valued map. We call the inverse image of M by F the set $F^-(M) = \{x \in A ; F(x) \cap M \neq \emptyset\}$. Also, we call core of M by F the set $F^+(M) = \{x \in A ; F(x) \subseteq M\}$.

Then some properties [5] follow for USC maps:

Proposition 9. A set-valued map $F : A \rightsquigarrow B$ is USC at x iff the core of any neighborhood of $F(x)$ is a neighborhood of x . Hence, a set-valued map $F : A \rightsquigarrow B$ is USC iff the core of any open subset is open.

Proposition 10. If $\mathcal{D}(F)$ is closed, then F is USC iff the inverse image of any closed set is closed.

3.11 AWCness in n -D

Now we can define *well-composedness on Khalimsky grids (AWCness)* [21] in n -D.

Definition 49 (AWCness). A finite set $\mathcal{X} \subset \mathbb{H}^n$ is said well-composed in the sense of Alexandrov or AWC iff the connected components of its topological boundary are discrete $(n - 1)$ -surfaces.

On Khalimsky grids, for a given plain map $U : \mathbb{H}^n \rightsquigarrow \mathbb{R}$, the following threshold sets exist [21]:

$$\begin{aligned} [U \triangleright \lambda] &= \{z \in \mathbb{H}^n \mid \exists v \in U(z), v \geq \lambda\}, \\ [U \triangleright \lambda] &= \{z \in \mathbb{H}^n \mid \forall v \in U(z), v > \lambda\}, \\ [U \triangleleft \lambda] &= \{z \in \mathbb{H}^n \mid \forall v \in U(z), v < \lambda\}, \\ [U \triangleleft \lambda] &= \{z \in \mathbb{H}^n \mid \exists v \in U(z), v \leq \lambda\}. \end{aligned}$$

Definition 50. *Let $U : \mathbb{H}^n \rightsquigarrow \mathbb{R}$ be a given plain map. We say that this map is well-composed in the sense of Alexandrov or AWC iff, for any value of $\lambda \in \mathbb{R}$, the connected components of the topological boundary of each of its threshold sets $[U \triangleright \lambda]$, $[U \triangleright \lambda]$, $[U \triangleleft \lambda]$, and $[U \triangleleft \lambda]$ are $(n - 1)$ -surfaces.*

Chapter 4

A sketch of the proof

Let us present the main steps of the proof that AWCness and DWCness are equivalent on cubical grids.

4.1 From $(\mathbb{Z}/2)^n$ to \mathbb{H}^n

We define the bijection $\mathcal{H} : (\mathbb{Z}/2) \rightarrow \mathbb{H}^1$ such that:

$$\forall z \in (\mathbb{Z}/2), \mathcal{H}(z) = \begin{cases} \{z + 1/2\} & \text{if } z \in (\mathbb{Z}/2) \setminus \mathbb{Z}, \\ \{z, z + 1\} & \text{if } z \in \mathbb{Z}. \end{cases} \quad (4.1)$$

We can then deduce the bijection $\mathcal{H}_n : (\mathbb{Z}/2)^n \rightarrow \mathbb{H}^n$ defined such that:

$$\mathcal{H}_n = \otimes_{i \in [1, n]} \mathcal{H}(z_i),$$

where z_i denote the i^{th} coordinate of $z \in (\mathbb{Z}/2)^n$.

We can compute the inverse bijection of \mathcal{H} , that we denote by $\mathcal{Z} : \mathbb{H}^1 \rightarrow (\mathbb{Z}/2)$, and defined such that:

$$\forall h \in \mathbb{H}^1, \mathcal{Z}(h) = \begin{cases} a & \text{if } \exists a \in \mathbb{Z} \text{ s.t. } h = \{a, a + 1\}, \\ a - 1/2 & \text{if } \exists a \in \mathbb{Z} \text{ s.t. } h = \{a\}. \end{cases} \quad (4.2)$$

We can then deduce the bijection $\mathcal{Z}_n : \mathbb{H}^n \rightarrow (\mathbb{Z}/2)^n$ defined such that:

$$\mathcal{Z}_n = \otimes_{i \in [1, n]} \mathcal{Z}(h_i),$$

where h_i denote the i^{th} coordinate of $h \in \mathbb{H}^n$.

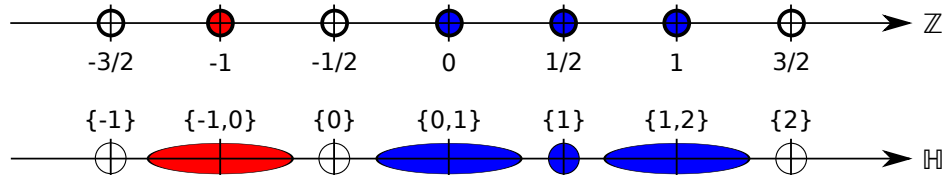

Figure 4.1: Bijection between \mathbb{H}^1 and $(\mathbb{Z}/2)$

Figure 5.2 shows how $(\mathbb{Z}/2)$ is mapped to \mathbb{H}^1 . Furthermore, it can be shown that supplying $(\frac{\mathbb{Z}}{2})^n$ with a particular topology, \mathcal{Z}_n (respectively \mathcal{H}_n) is in fact a *topological isomorphism*, that is a bicontinuous bijection, between \mathbb{H}^n and $(\frac{\mathbb{Z}}{2})^n$ (respectively between $(\frac{\mathbb{Z}}{2})^n$ and \mathbb{H}^n). In other words, these two spaces have the same topological structure.

4.2 Immersion into Khalimsky Grids

Starting from a given digital set $X \subset \mathbb{Z}^n$, we can immerse it into \mathbb{H}^n in the following manner:

$$\mathcal{I}\mathcal{M}\mathcal{M}(X) \equiv \text{Int}(\alpha(\mathcal{H}_n(X))),$$

where Int is the topological interior in \mathbb{H}^n :

$$\text{Int}(X) = \{h \in X ; \beta(h) \subseteq X\}.$$

4.3 Stating the problem

The context is the following: we have a set X made of points in \mathbb{Z}^n , from which we compute its immersion $\mathcal{I}\mathcal{M}\mathcal{M}(X)$ in the Khalimsky grids. X is digitally well-composed iff it does not contain any critical configuration, and $\mathcal{I}\mathcal{M}\mathcal{M}(X)$ is said well-composed in the sense of Alexandrov iff its topological boundary \mathfrak{N} defined such as:

$$\mathfrak{N} = \alpha(\mathcal{I}\mathcal{M}\mathcal{M}(X)) \cap \alpha(\mathbb{H}^n \setminus \mathcal{I}\mathcal{M}\mathcal{M}(X)),$$

is made of disjoint discrete $(n - 1)$ -surfaces.

We want to establish that these two concepts are rigorously equivalent.

4.4 Reformulating the topological boundary

The topological boundary $\partial\mathcal{LMM}(X)$ can be reformulated as a function of $\mathcal{X} = \mathcal{H}_n(X)$ and the complement $\mathcal{Y} = \mathbb{H}_n^n \setminus \mathcal{X}$ of \mathcal{X} in \mathbb{H}_n^n . Effectively, we have the following proposition:

$$\mathfrak{N} = \alpha(\mathcal{X}) \cap \alpha(\mathcal{Y}).$$

Summarily, we can reformulate this way the boundary because these following properties are verified in \mathbb{H}^n :

- \mathbb{H}^n is a n -surface and then is homogeneous,
- $\forall z \in \mathbb{H}^n, \alpha(\beta(z) \cap \mathbb{H}_n^n) = \alpha(\beta(z))$,
- $\forall z \in \mathbb{H}^n, \alpha(z)$ is a regular closed set,
- $\forall z \in \mathbb{H}^n, \beta(z)$ is a regular open set.

4.5 Reformulating the problem in a local way

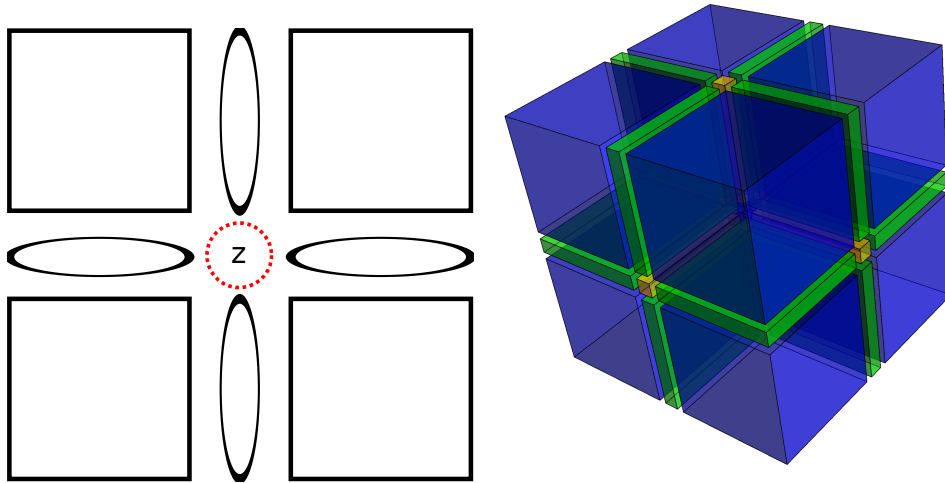

Figure 4.2: The subspace $|\beta^\square(z)|$ we are working in to study AWCness (2D/3D cases).

We could then directly prove that the fact that $\mathcal{IMM}(X)$ is well-composed in the sense of Alexandrov implies that X is digitally well-composed, and the converse, and we would be done. However, we observed that we can reformulate the condition “ $\mathcal{IMM}(X)$ is well-composed in the sense of Alexandrov” with another condition, much simpler to handle and manipulate, since it is a local criteria (as digital well-composedness is). Effectively, $\mathcal{IMM}(X)$ is well-composed in the sense of Alexandrov is equivalent to:

$$\{\forall z \in \mathfrak{N}, |\beta_{\mathfrak{N}}^{\square}(z)| \text{ is a } (n - 2 - \dim(z)) - \text{surface}\}.$$

Since $|\beta_{\mathfrak{N}}^{\square}(z)|$ is equal to $|\mathfrak{N} \cap \beta^{\square}(z)|$, we understand effectively that we are studying a restriction of the boundary \mathfrak{N} in a small subspace, that is, $|\beta^{\square}(z)|$, depicted on Figure 4.2, where we can observe that the point z in the middle of the subspace has been omitted, since it is not taken into account in the local criteria.

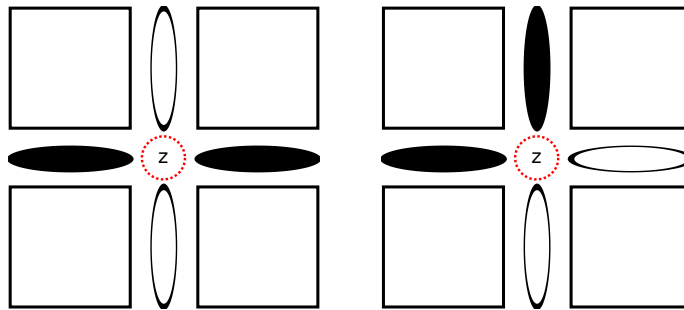

Figure 4.3: Examples of 0-surfaces (in black).

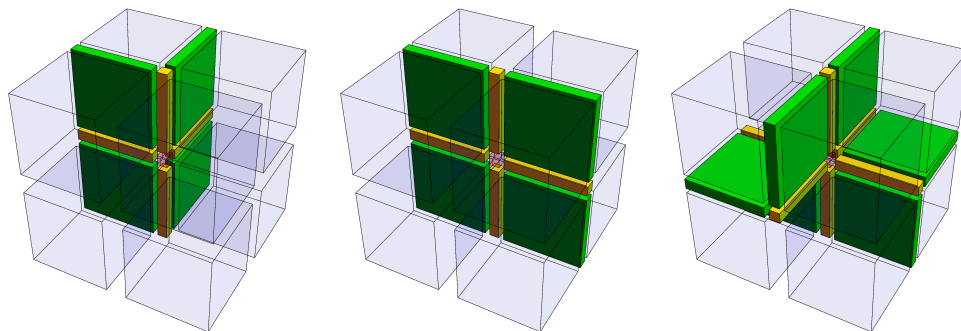

Figure 4.4: Examples of 1-surfaces.

The question is then: what does it mean that $|\beta_{\mathfrak{N}}^{\square}(z)|$ is an $(n - 2 - \dim(z))$ -surface? When $\dim(z) = (n - 2)$, that is, when $\beta(z)$ is a subspace of dimension 2 as on the left of Figure 4.2, it means that $|\beta_{\mathfrak{N}}^{\square}(z)|$ is a 0-surface, that is, the restriction $|\beta_{\mathfrak{N}}^{\square}(z)|$ of the boundary \mathfrak{N} to the subspace $\beta^{\square}(z)$ is made of two elements which are not neighbors the one of the other one (see Figure 4.3). When $\dim(z) = (n - 3)$, that is when $\beta(z)$ is a subspace of dimension 3 as on the right of Figure 4.2, it means that the restriction $|\beta_{\mathfrak{N}}^{\square}(z)|$ of the boundary \mathfrak{N} to the 3D subspace $\beta^{\square}(z)$ is a 1-surface, that is, a simple closed curve (see Figure 4.4).

Our aim is then to prove that X is digitally well-composed iff for any element z of the boundary \mathfrak{N} , we have that $|\beta_{\mathfrak{N}}^{\square}(z)|$ is a $(n - \dim(z) - 2)$ -surface.

4.6 Study of the converse sense

Let us begin with the converse sense: we admit that for any element z of the boundary \mathfrak{N} , we have that $|\beta_{\mathfrak{N}}^{\square}(z)|$ is a $(n - \dim(z) - 2)$ -surface, and we want to prove that X is digitally well-composed. For that, we will prove the counterposition: we assume that X is not digitally well-composed, and then contains a critical configuration, and we show that it implies that there exists a “critical point” z^* such that $|\beta_{\mathfrak{N}}^{\square}(z^*)|$ is not a discrete surface.

So, let assume that X contains a primary critical configuration in a block S of dimension $k \geq 2$, that is, $X \cap S = \{p, p'\}$ such that p and p' are antagonist into S (the secondary case follows the same reasoning, by duality of well-composedness in the sense of Alexandrov and digital well-composedness). It is then clear that all the other points of the block S belong to the complement Y of X in \mathbb{Z}^n .

Let us begin with the 2D case, that is, when the block S is of dimension $k = 2$ in \mathbb{Z}^n . In this case, its isomorph in \mathbb{H}^n , which is in reality made of n -cubes, can be represented using squares, as depicted on Figure 4.5. Then, the center of these four squares, that we will call z^* , has a dimension $(n - 2)$. Let us show that this point is critical in the sense that $|\beta_{\mathfrak{N}}^{\square}(z)|$ is not a 0-surface. For that, as shown on Figure 4.5, we work into the space $\beta^{\square}(z^*)$, which contains our four colored squares, and we compute their respective closures (into the subspace $\beta^{\square}(z^*)$), their intersection will then be $\beta_{\mathfrak{N}}^{\square}(z^*)$. Effectively, $|\beta_{\mathfrak{N}}^{\square}(z^*)|$ is not a 0-surface, because it is made of 4 points and a

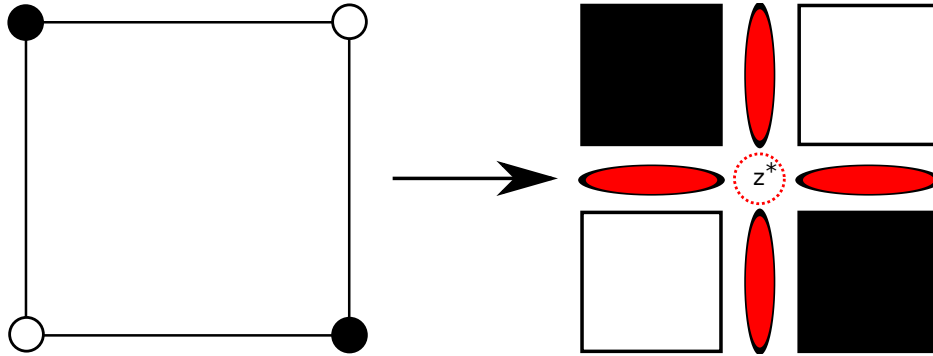

Figure 4.5: From a 2D critical configuration in \mathbb{Z}^2 to a critical point z^* in \mathbb{H}_0^2 .

0-surface is made of two points, then z^* is “critical” and we have “proven” the reciprocal sense for $k = 2$.

Let us now proceed to the 3D case, that is, when the block S is of dimension $k = 3$ in \mathbb{Z}^n . In this case, its isomorph in \mathbb{H}^n can be represented using cubes, as depicted on Figure 4.6. Then, the center z^* of these 8 cubes has a dimension $(n - 3)$ and is critical in the sense that $|\beta_{\mathfrak{N}}^{\square}(z^*)|$ is an union of two disjoint 1-surfaces, and then it is not a 1-surface. So we “proved” the case $k = 3$ too.

In fact, for the general case $k \in \llbracket 2, n \rrbracket$, it can be proven that, if we denote by \mathfrak{p} and \mathfrak{p}' the isomorphisms of the two points p and p' respectively into the cubical complexes \mathbb{H}^n , starting from the formulation $\mathfrak{N} = \alpha(\mathcal{X}) \cap \alpha(\mathcal{Y})$, we obtain:

$$\beta_{\mathfrak{N}}^{\square}(z^*) = (\alpha^{\square}(\mathfrak{p}) \cup \alpha^{\square}(\mathfrak{p}')) \cap \beta^{\square}(z^*),$$

which can be decomposed into two orders $|\alpha^{\square}(\mathfrak{p}) \cap \beta^{\square}(z^*)|$ and $|\alpha^{\square}(\mathfrak{p}') \cap \beta^{\square}(z^*)|$ which are disjoint $(n - 2 - \dim(z))$ -surfaces, and then their union is not a $(n - 2 - \dim(z))$ -surface.

4.7 Study of the direct sense

Since we have explained how we proceed in the countersense, let us show how we proceed in the direct sense.

We want to prove that if X is digitally well-composed, then $\mathcal{I}\mathcal{M}\mathcal{M}(X)$ is well-composed in the sense of Alexandrov, which can be proven by the

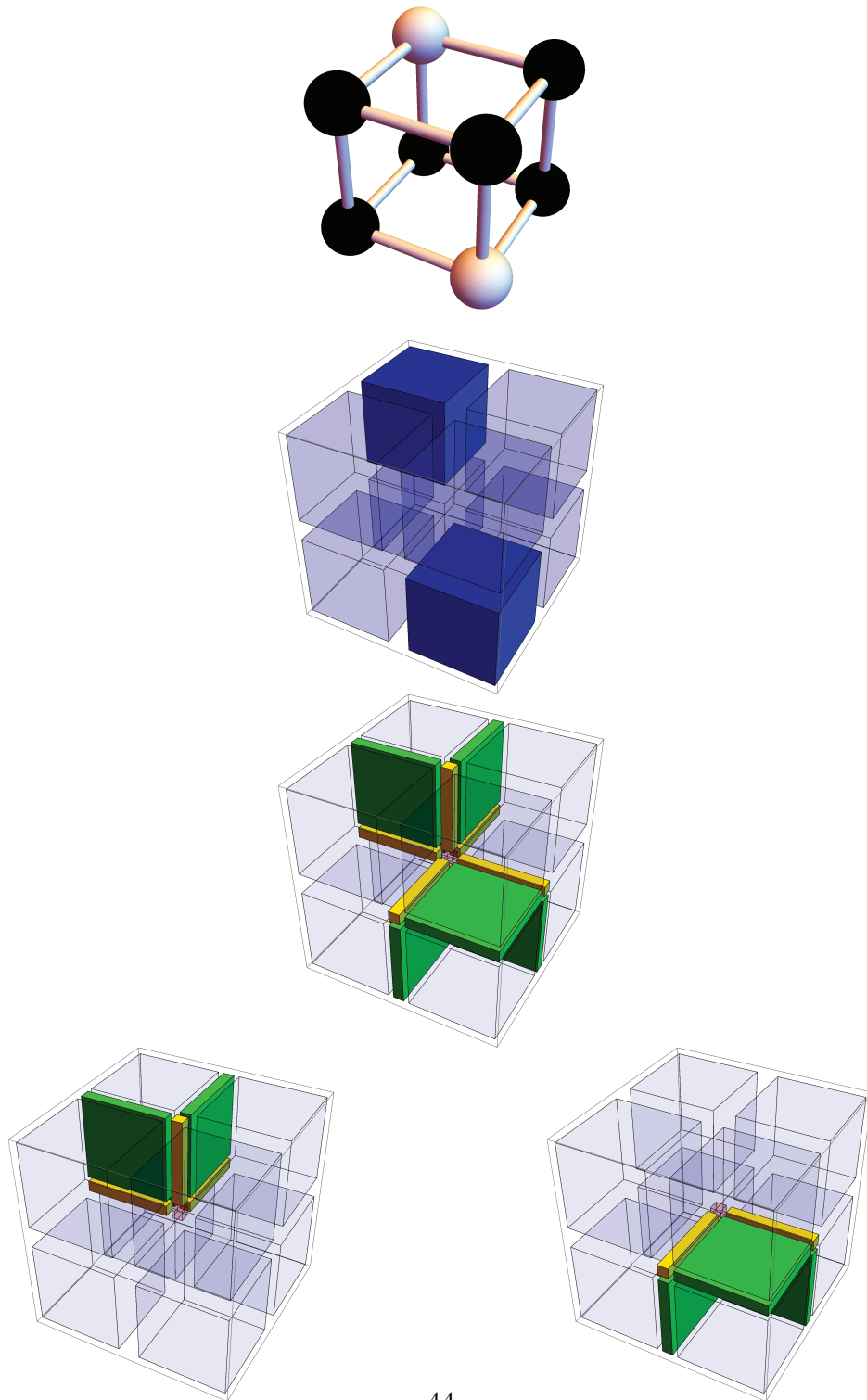

Figure 4.6: From the 3D critical configuration to the critical point.

fact that for any element z of the boundary \mathfrak{N} , we have that $|\beta_{\mathfrak{N}}^{\square}(z)|$ is a $(n - \dim(z) - 2)$ -surface. In fact, we will proceed by induction. We define the property (\mathcal{P}_k) such that if this property is true for any value $k \in \llbracket 1, n \rrbracket$, then X is well-composed in the sense of Alexandrov:

$$(\mathcal{P}_k) = \left\{ \forall z \in \mathfrak{N} \cap \mathbb{H}_{n-k}^n, |\beta_{\mathfrak{N}}^{\square}(z)| \text{ is a } (n - 2 - \dim(z)) \text{ - surface} \right\}.$$

Obviously, the case $k = 0$ is not necessary, since no point of the boundary \mathfrak{N} is a n -cube.

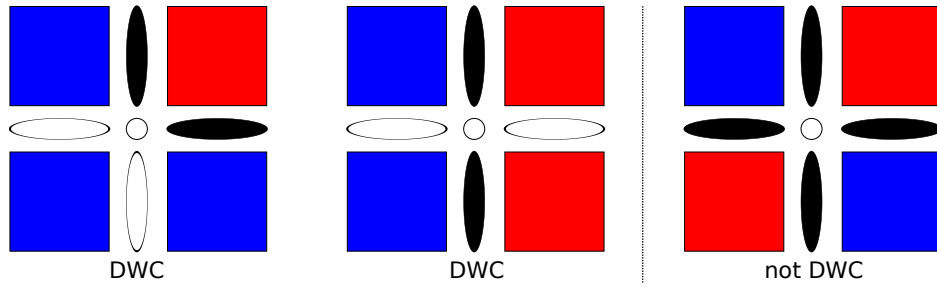

Figure 4.7: Assuming that X is DWC, $|\beta_{\mathfrak{N}}^{\square}(z)|$ is a 0-surface when $\dim(z) = n - 2$ ($k = 2$).

So let start with $k = 1$: in this case, z is a $(n - 1)$ -face, and then $\beta^{\square}(z)$ is empty, which means that $|\beta_{\mathfrak{N}}^{\square}(z)|$ is a (-1) -surface since it is the empty order. Let us continue with $k = 2$. In this case, z is a $(n - 2)$ -face, and then it is sufficient to proceed cases by case (modulo symmetry, rotation, and complementation), as shown by Figure 4.7. The isomorphism of X restricted to $\beta^{\square}(z)$ is depicted using blue faces, and the isomorphism of $Y = \mathbb{Z}^n \setminus X$ restricted to $\beta^{\square}(z)$ is depicted using red faces. Since we have the relation $\mathfrak{N} = \alpha(\mathcal{X}) \cap \alpha(\mathcal{Y})$, we obtain in the two DWC cases (on the left and at the middle) that the intersection of the closure of the blue faces and the closure of the red faces makes a 0-surface in $\beta^{\square}(z)$ (depicted in black), since its restriction to $\beta^{\square}(z)$ is made of two points which are not neighbors the one of the other one. The case $k = 2$ is then treated.

For the cases $k \in \llbracket 3, n \rrbracket$, we can proceed by induction on k since the initialization succeeded. So let us assume that $k \in \llbracket 3, n \rrbracket$ is given and that the property (\mathcal{P}_l) is true for any $l \in \llbracket 1, k - 1 \rrbracket$, we want to prove it for k .

In this case, z is a $(n - k)$ -face with $k \geq 3$, which means that $\dim(z) \leq (n - 3)$, and then $(n - 2 - \dim(z)) \geq 1$. It is clear then that $|\beta_{\mathfrak{N}}^{\square}(z)|$ is

a $(n - 2 - \dim(z))$ -surface iff we have two conditions: (1) $|\beta_{\mathfrak{M}}^\square(z)|$ must be connected, and (2) for any point u of $\beta_{\mathfrak{M}}^\square(z)$, $|\theta_{\beta_{\mathfrak{M}}^\square(z)}^\square|$ must be a $(n - 3 - \dim(z))$ -surface.

Even if the second condition seems to be much more complicated than the first one, it is in fact the converse. Effectively, it is easy to prove by a simple calculus that $|\theta_{\beta_{\mathfrak{M}}^\square(z)}^\square|$ is equal to:

$$|\beta_{\mathfrak{M}}^\square(u)| * |\alpha^\square(u) \cap \beta^\square(z)|,$$

which corresponds to an order join of $|\beta_{\mathfrak{M}}^\square(u)|$ which is a $(n - 2 - \dim(u))$ -surface by the induction hypothesis and $|\alpha^\square(u) \cap \beta^\square(z)|$, from which we can prove it is a $(\dim(u) - \dim(z) - 2)$ -surface. Since an order join of a k_1 -surface and of a k_2 -surface is a $(k_1 + k_2 + 1)$ -surface by Theorem 7, $|\theta_{\beta_{\mathfrak{M}}^\square(z)}^\square|$ is a $(n - 3 - \dim(z))$ -surface. Then (2) is proven.

To prove (1), we assume that there exists $z \in \mathbb{H}_{n-k}^n$ such that $|\beta_{\mathfrak{M}}^\square(z)|$ is not connected. We will see that this hypothesis is essential, since many properties will follow on, until we reach a contradiction.

Assuming $|\beta_{\mathfrak{M}}^\square(z)|$ is not connected obviously means that it is made of several connected components, that we will denote by $\{F_i\}_{i \in \mathcal{I}}$. The first fundamental property is that each component F_i , $i \in \mathcal{I}$, is a $(n - 2 - \dim(z))$ -surface because they are connected (by definition) and because we can prove that for any $u \in F_i$, we have $|\theta_{F_i}^\square|$ which is equal to $|\theta_{\beta_{\mathfrak{M}}^\square(z)}^\square|$, which is a $(n - 3 - \dim(z))$ -surface, and then F_i is a $(n - 2 - \dim(z))$ -surface.

Starting from this first property, a second fundamental property follows on: for $i \in \mathcal{I}$, a same component F_i cannot contain *opposite* faces relatively to z . Roughly speaking, opposite faces are two faces which are symmetrical relatively to a third face (see Figure 4.8). Effectively, we can feel that if one first component contains two opposite face in $\beta^\square(z)$, it will separate any other component of $|\beta_{\mathfrak{M}}^\square(z)|$, which is impossible since each F_i is connected by hypothesis.

Now that we know that each component F_i cannot contain two opposite faces, the third fundamental property can be proven: each of them contains exactly $(n - \dim(z))$ $(\dim(z) + 1)$ faces of $\beta^\square(z)$. For example, in the 3D case, that is for $\dim(z) = (n - 3)$ as on Figure 4.9, where $(\dim(z) + 1)$ -faces are depicted in red, each component contains exactly 3 $(\dim(z) + 1)$ -faces.

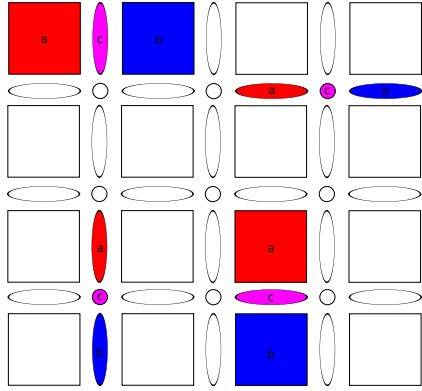

Figure 4.8: Examples of opposites in \mathbb{H}^2 .

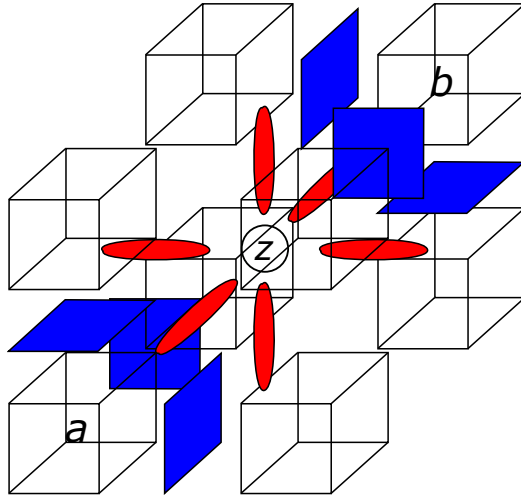

Figure 4.9: Structure of $\beta_{\mathfrak{H}^n}^\square(z)$ when we have $(n - \dim(z)) = 3$ assuming that $|\beta_{\mathfrak{H}^n}^\square(z)|$ is not connected.

Since there are $2(n - \dim(z))$ of these faces in $\beta^\square(z)$, $|\beta_{\mathfrak{N}}^\square(z)|$ is made of 2 components F_1 and F_2 .

Using these three fundamental properties, it can be proven that each of these two components F_1 and F_2 lies in the closure of *characteristical* n -faces $\mathbf{a}, \mathbf{b} \in \mathbb{H}_n^n$ that we define here as the supremum of the $(\dim(z) + 1)$ -faces contained in each of them. More precisely, $|F_1| \subseteq |\alpha^\square(\mathbf{a}) \cap \beta^\square(z)|$ and $|F_2| \subseteq |\alpha^\square(\mathbf{b}) \cap \beta^\square(z)|$. Furthermore, since we can prove that two k -surfaces which are included the one in the other one are equal and since $|\alpha^\square(\mathbf{a}) \cap \beta^\square(z)|$ and $|\alpha^\square(\mathbf{b}) \cap \beta^\square(z)|$ are two $(n - \dim(z) - 2)$ -surfaces like the components F_1 and F_2 , we obtain that:

$$\begin{aligned} |F_1| &= |\alpha^\square(\mathbf{a}) \cap \beta^\square(z)|, \\ |F_2| &= |\alpha^\square(\mathbf{b}) \cap \beta^\square(z)|. \end{aligned}$$

On Figure 4.9, representing the 3D case ($\dim(z) = n - 3$), the first component made of red 1-faces and of blue 2-faces on the left lies in the closure of the 3-face a (in the subspace $\beta^\square(z)$) and the second component made of red 1-faces and of blue 2-faces on the right lies in the closure of the 3-face b (in the subspace $\beta^\square(z)$).

The link between the configuration we obtained in \mathbb{H}_n^n by assuming that $|\beta_{\mathfrak{N}}^\square(z)|$ is not connected and a critical conguration is then clear: since $\beta_{\mathfrak{N}}^\square(z) \subseteq \mathfrak{N}$, if a belongs to X , then the rest of the block minus b belongs to Y , and then b belongs to X to, and we obtain a critical configuration of primary type in X . The dual reasoning leads to a secondary critical configuration in X . In both cases, we obtain a contradiction. Then $|\beta_{\mathfrak{N}}^\square(z)|$ is connected. Finally, $\mathcal{I}\mathcal{M}\mathcal{M}(X)$ is well-composed in the sense of Alexandrov when X is digitally well-composed.

4.8 Conclusion for sets

Finally, we obtain the property that a set $X \subset \mathbb{Z}^n$ is DWC iff its immersion $\mathcal{I}\mathcal{M}\mathcal{M}(X)$ into the Khalinsky grids $|\mathbb{H}^n|$ is AWC, that is, is such that its topological boundary $\partial\mathcal{I}\mathcal{M}\mathcal{M}(X)$ is made of disjoint $(n - 1)$ -surfaces.

4.9 Conclusion for plain maps

Starting from a function $u : \mathbb{Z}^n \rightarrow \mathbb{R}$, we can compute its *immersion* $U : \mathbb{H}^n \rightsquigarrow \mathbb{R}$ into the Khalimsky grids, defined such that:

$$\forall h \in \mathbb{H}^n, U(h) = \begin{cases} \{u(\mathcal{Z}_n(h))\} & \text{if } z \in \mathbb{H}_n^n, \\ \text{Span}\{U(q) ; q \in \beta(z) \cap \mathbb{H}_n^n\} & \text{either .} \end{cases}$$

We obtain finally that a real-valued image $u : \mathbb{Z}^n \rightarrow \mathbb{R}$ is DWC iff the plain map (see Section 3.10) resulting from its immersion $U : \mathbb{H}^n \rightsquigarrow \mathbb{R}$ into the Khalimsky grids is AWC.

Chapter 5

The complete proof

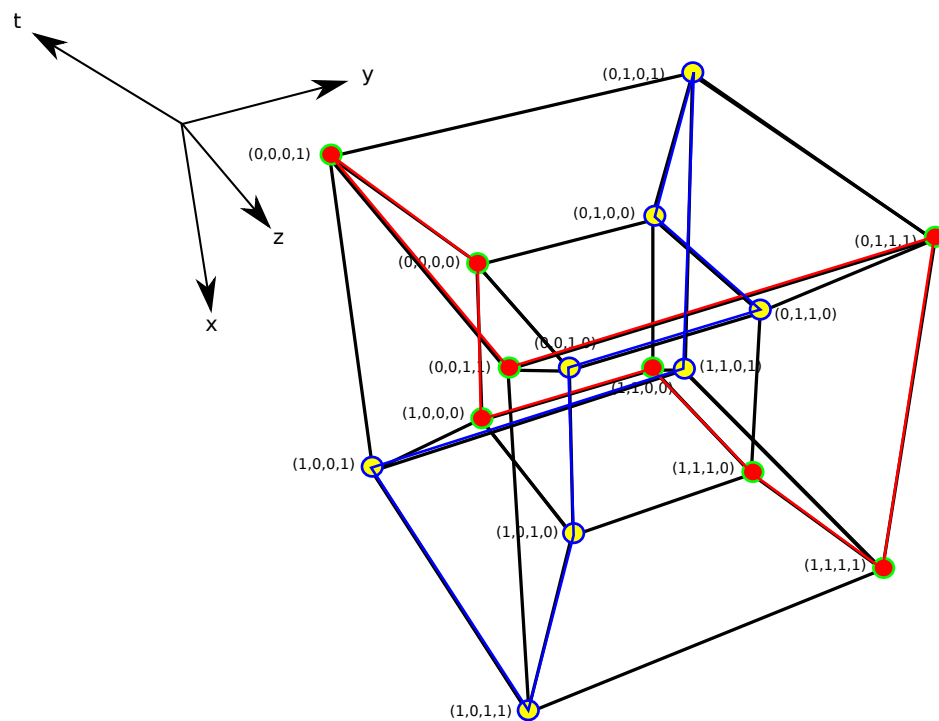

Figure 5.1: A 4D digitally well-composed set (depicted in blue) and its complement (in red).

Before beginning the complete proof of the equivalence between these two kinds of well-composedness, we propose to illustrate that the intu-

ition that “a digitally well-composed set should always be the limit of an increasing sequence of digitally well-composed sets” is false. A 4D example of digitally well-composed sets can prove this (see Figure 5.1). Effectively, removing/adding any point to this set made of yellow points and blue edges creates a critical configuration of dimension 2, and there there exists no strictly increasing/decreasing sequence of digitally well-composed sets which converges to this set.

5.1 Some preliminaries

These three easy lemmas will be useful in the sequel.

5.1.1 Cartesian product and basic operators

Let us denote by \otimes the *cartesian product*, defined such that for any A and B two spaces or arbitrary elements, $A \otimes B = \{(a, b) ; a \in A, b \in B\}$.

Lemma 1. *For each element a in \mathbb{H}^n , $\alpha(a) = \bigotimes_{m \in \llbracket 1, n \rrbracket} \alpha(a_m)$, where a_m is the m^{th} coordinate of a in \mathbb{H}^n and \otimes is the cartesian product.*

Proof: Let k, l two values of \mathbb{N} , and $a^k \in \mathbb{H}^m, a^l \in \mathbb{H}^n$. Then,

$$\begin{aligned} \alpha(a^k \otimes a^l) &= \{f \in \mathbb{H}^{k+l} ; f \leq a^k \otimes a^l\}, \\ &= \{f \in \mathbb{H}^{k+l} ; f = f^k \otimes f^l, f^k \leq a^k, f^l \leq a^l\}, \\ &= \{f \in \mathbb{H}^{k+l} ; f = f^k \otimes f^l, f^k \leq a^k\} \cap \{f \in \mathbb{H}^{k+l} ; f = f^k \otimes f^l, f^l \leq a^l\}, \\ &= \alpha(a^k) \otimes \mathbb{H}^l \cap \mathbb{H}^k \otimes \alpha(a^l), \\ &= \alpha(a^k) \otimes \alpha(a^l). \end{aligned}$$

In this way, for $a \in \mathbb{H}^n$, $a = \otimes_{i \in \llbracket 1, n \rrbracket} a_i$, and then we obtain:

$$\begin{aligned} \alpha(a) &= \alpha(\otimes_{i \in \llbracket 1, n \rrbracket} a_i), \\ &= \alpha(\otimes_{i \in \llbracket 1, n-1 \rrbracket} a_i) \otimes \alpha(a_n), \\ &= \dots, \\ &= \alpha(a_1) \otimes \dots \otimes \alpha(a_n), \\ &= \bigotimes_{m \in \llbracket 1, n \rrbracket} \alpha(a_m) \end{aligned}$$

□

Lemma 2. For each element a in \mathbb{H}^n , $\beta(a) = \bigotimes_{m \in \llbracket 1, n \rrbracket} \beta(a_m)$, where a_m is the m^{th} coordinate of a in \mathbb{H}^n and \otimes is the cartesian product.

Proof: Let k, l be two values of \mathbb{N} , and $a^k \in \mathbb{H}^k, a^l \in \mathbb{H}^l$. Then :

$$\begin{aligned} \beta(a^k \otimes a^l) &= \{f \in \mathbb{H}^{k+l} ; f \geq a^k \otimes a^l\}, \\ &= \{f \in \mathbb{H}^{k+l} ; f = f^k \otimes f^l, f^k \geq a^k, f^l \geq a^l\}, \\ &= \{f \in \mathbb{H}^{k+l} ; f = f^k \otimes f^l, f^k \geq a^k\} \cap \{f \in \mathbb{H}^{k+l} ; f = f^k \otimes f^l, f^l \geq a^l\}, \\ &= \beta(a^k) \otimes \mathbb{H}^l \cap \mathbb{H}^k \otimes \beta(a^l), \\ &= \beta(a^k) \otimes \beta(a^l). \end{aligned}$$

In this way, for $a \in \mathbb{H}^n$, $a = \otimes_{i \in \llbracket 1, n \rrbracket} a_i$, and then we obtain:

$$\begin{aligned} \beta(a) &= \beta(\otimes_{i \in \llbracket 1, n \rrbracket} a_i), \\ &= \beta(\otimes_{i \in \llbracket 1, n-1 \rrbracket} a_i) \otimes \beta(a_n), \\ &= \dots, \\ &= \beta(a_1) \otimes \dots \otimes \beta(a_n), \\ &= \bigotimes_{m \in \llbracket 1, n \rrbracket} \beta(a_m). \end{aligned}$$

□

Lemma 3. Let $\{\mathcal{O}_i\}_{i \in \mathbb{J}}$ be a family of open sets in \mathbb{H}^1 . Then the cartesian product $\bigotimes_{i \in \llbracket 1, n \rrbracket} \mathcal{O}_i$ is open in \mathbb{H}^n .

Proof: Let us define $\mathcal{O} = \otimes_{i \in \llbracket 1, n \rrbracket} \mathcal{O}_i$. Then it follows that:

$$\begin{aligned} h \in \mathcal{O} &\Leftrightarrow h \in \otimes_{i \in \llbracket 1, n \rrbracket} \mathcal{O}_i, \\ &\Leftrightarrow \forall i \in \llbracket 1, n \rrbracket, h_i \in \mathcal{O}_i, \\ &\Rightarrow \forall i \in \llbracket 1, n \rrbracket, \beta(h_i) \subseteq \mathcal{O}_i, \\ &\Rightarrow \otimes_{i \in \llbracket 1, n \rrbracket} \beta(h_i) \subseteq \otimes_{i \in \llbracket 1, n \rrbracket} \mathcal{O}_i, \\ &\Rightarrow \beta(h) \subseteq \mathcal{O}, \end{aligned}$$

which implies that \mathcal{O} is open in \mathbb{H}^n .

□

5.2 Isomorphism between $(\mathbb{Z}/2)^n$ and \mathbb{H}^n

Let us see that $(\mathbb{Z}/2)^n$ and \mathbb{H}^n supplied with some specific topologies are *isomorphic* in the sense that they have the same topological structure (the definition of isomorphic spaces comes later).

5.2.1 Topological structure of $(\mathbb{Z}/2)^n$

When Khalimsky grids are associated by “nature” to the inclusion order \supseteq , the set $(\mathbb{Z}/2)$ needs that we associate one topology to it to be able to speak about its topological structure.

For that, we can start from supplying $(\mathbb{Z}/2)$ with a topology. So, let be the following set:

$$\mathbb{I} = \{ [k, l] \cap (\mathbb{Z}/2) ; k, l \in \mathbb{Z}, k \leq l \}.$$

Then we generate the topology $\mathcal{U}_{(\mathbb{Z}/2)}$ as being any union of elements of \mathbb{I} and any finite intersection of \mathbb{I} , this way \mathbb{I} is the basis of $\mathcal{U}_{(\mathbb{Z}/2)}$.

Since closed in $(\mathbb{Z}/2)$ are complement of open sets, it is obvious that for any $a, b \in \mathbb{Z}$ such that $a \leq b$:

$$[a - 1/2, b + 1/2] \cap (\mathbb{Z}/2) = (\mathbb{Z}/2) \setminus \left(\bigcup_{c \in \mathbb{Z}, c \notin [a-1, b]} [c, c + 1] \cap (\mathbb{Z}/2) \right)$$

is closed as complement of an open set in $(\mathbb{Z}/2)$, and then intervals that have bounds which are both not integers will be closed in $(\mathbb{Z}/2)$. Furthermore, for any $a \in \mathbb{Z}$, $\{a - \frac{1}{2}, a, a + \frac{1}{2}\}$ is closed in $(\mathbb{Z}/2)$.

Then we can induce the topology $\mathcal{U}_{(\mathbb{Z}/2)^n}$ associated to $(\mathbb{Z}/2)^n$ using the cartesian product:

$$((\mathbb{Z}/2)^n, \mathcal{U}_{(\mathbb{Z}/2)^n}) = \bigotimes_{i \in [1, n]} ((\mathbb{Z}/2), \mathcal{U}_{(\mathbb{Z}/2)}).$$

In this manner, each open set of $(\mathbb{Z}/2)^n$ is an union of (cartesian) n -ary products of open sets of $(\mathbb{Z}/2)$ (and conversely).

Note that in this chapter we will say that a point in $(\mathbb{Z}/2)$ has an *integral coordinate* or is an *integral value* iff $z \in \mathbb{Z}$. Otherwise, we will say that z has a *half coordinate* or is an *half value*. By extension, for points of $(\mathbb{Z}/2)^n$, we will say that the i^{th} coordinate is *integral* if z_i is integral. Otherwise, we will say that this coordinate is *in half* or that z has an *half i^{th} coordinate*.

5.2.2 Topological structure of \mathbb{H}^n

Concerning $|\mathbb{H}^n|$, as we have seen before, it is associated to the inclusion order \supseteq . This way, as suggested by Alexandrov (see Theorem 4), we define every set $\alpha(p) = \{q \in \mathbb{H}^n ; q \subseteq p\}$ for any element $p \in \mathbb{H}^n$ as closed sets in \mathbb{H}^n as a topological space. Due to the symmetry of Alexandrov spaces, $\beta(p) = \{q \in \mathbb{H}^n ; p \subseteq q\}$ will be open sets of \mathbb{H}^n as a topological space. Finally, we can then define the topology of \mathbb{H}^n as:

$$\mathcal{U}_{\mathbb{H}^n} = \{O \subseteq \mathbb{H}^n ; \forall h \in O, \beta(h) \subseteq O\},$$

which means that every open set O in $(\mathbb{H}^n, \mathcal{U}_{\mathbb{H}^n})$ can be written such that:

$$O = \cup_{h \in O} \beta(h).$$

Also, we will extend the notion of α -adherence and β -adherence to sets:

Definition 51 (Adherence of a set). *Let X be a subset of \mathbb{H}^n . We define the set $\alpha(X) = \cup_{h \in X} \alpha(h)$, respectively the set $\beta(X) = \cup_{h \in X} \beta(h)$, as the α -adherence of X in \mathbb{H}^n . They are respectively the smallest closed and the smallest open sets containing X in \mathbb{H}^n . Following the same logic, we define the θ -adherence $\theta(X) = \cup_{h \in X} \theta(h)$ of X .*

5.2.3 Isomorphism between $(\mathbb{Z}/2)^n$ and \mathbb{H}^n

From now on, $(\mathbb{Z}/2)^n$ and \mathbb{H}^n will be assumed to be supplied with their respective topologies, and their subsets will be supplied with their respective relative topologies.

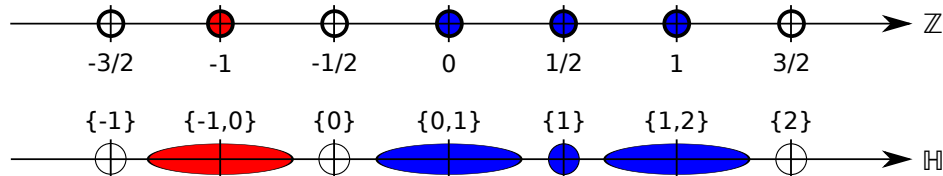

Figure 5.2: Topological isomorphism between $|\mathbb{H}^1|$ and $((\mathbb{Z}/2), \mathcal{U}_{(\mathbb{Z}/2)})$

Definition 52 (\mathcal{Z}). *Let us define the application $\mathcal{Z} : \mathbb{H}^1 \rightarrow (\mathbb{Z}/2)$ such that:*

$$\forall h \in \mathbb{H}^1, \mathcal{Z}(h) = \begin{cases} a & \text{if } \exists a \in \mathbb{Z} \text{ s.t. } h = \{a, a + 1\} \\ a - 1/2 & \text{if } \exists a \in \mathbb{Z} \text{ s.t. } h = \{a\} \end{cases} \quad (5.1)$$

This application maps elements of \mathbb{H}_0^1 to integral values, and elements of \mathbb{H}_1^1 to half values. Also, we can observe easily that this application is bijective. Figure 5.2 shows how open sets are preserved by the isomorphism: the set $\{-1\}$ is open and is mapped by the isomorphism to $\{-1, 0\}$ which is also an open set. In a same manner, the open (and not degenerated) set $\{0, \frac{1}{2}, 1\}$ is mapped to $\{0, 1, \{1, 2\}\}$ which is an open set in \mathbb{H}^1 . Furthermore, the blue and the red sets are connected into $(\mathbb{Z}/2)$ and such are their isomorphisms. However, the set made of blue and red points in $(\mathbb{Z}/2)$ is not connected since it is a disjoint union of two open sets, and it is mapped to a set which is not connected either. So we can see how isomorphisms preserve topological structures.

Definition 53 (Inverse of \mathcal{Z}). *We define the application $\mathcal{H} : (\mathbb{Z}/2) \rightarrow \mathbb{H}^1$ such that:*

$$\forall z \in (\mathbb{Z}/2), \mathcal{H}(z) = \begin{cases} \{z + 1/2\} & \text{if } z \in (\mathbb{Z}/2) \setminus \mathbb{Z} \\ \{z, z + 1\} & \text{if } z \in \mathbb{Z} \end{cases} \quad (5.2)$$

Obviously, \mathcal{H} is the inverse of \mathcal{Z} .

Definition 54 (\mathcal{Z}_n and \mathcal{H}_n). *We define the applications $\mathcal{Z}_n : \mathbb{H}^n \rightarrow (\mathbb{Z}/2)^n$ and $\mathcal{H}_n : (\mathbb{Z}/2)^n \rightarrow \mathbb{H}^n$, based on Definition 52 and Definition 53, using the cartesian product:*

$$\forall h \in \mathbb{H}^n, \mathcal{Z}_n(h) = \otimes_{i \in [1, n]} \mathcal{Z}(h_i), \quad (5.3)$$

$$\forall z \in (\mathbb{Z}/2)^n, \mathcal{H}_n(z) = \otimes_{i \in [1, n]} \mathcal{H}(z_i). \quad (5.4)$$

As proven in Section 5.1, \mathcal{Z}_n (and then \mathcal{H}_n) are *topological isomorphisms*, i.e., bicontinuous bijections, and for this reason we say that $((\mathbb{Z}/2)^n, \mathcal{U}_{(\mathbb{Z}/2)^n})$ and $(\mathbb{H}^n, \mathcal{U}_{\mathbb{H}^n})$ are *isomorphic* (they have the same topological structure).

This is illustrated on Figure 5.3 where we can see how points of \mathbb{Z}^2 become squares in \mathbb{H}^2 . Furthermore, we can observe that the set made of the blue point $p \in \mathbb{Z}^2$ and its 8-neighborhood $\mathcal{N}_{3^n-1}(p, (\mathbb{Z}/2)^n)$, which is a closed set as a cartesian product of two closed sets, is mapped to the α -adherence of the blue square, which is closed by construction. More complex structures like the red set plus its neighboring (black) points keep their structure intact by the isomorphism.

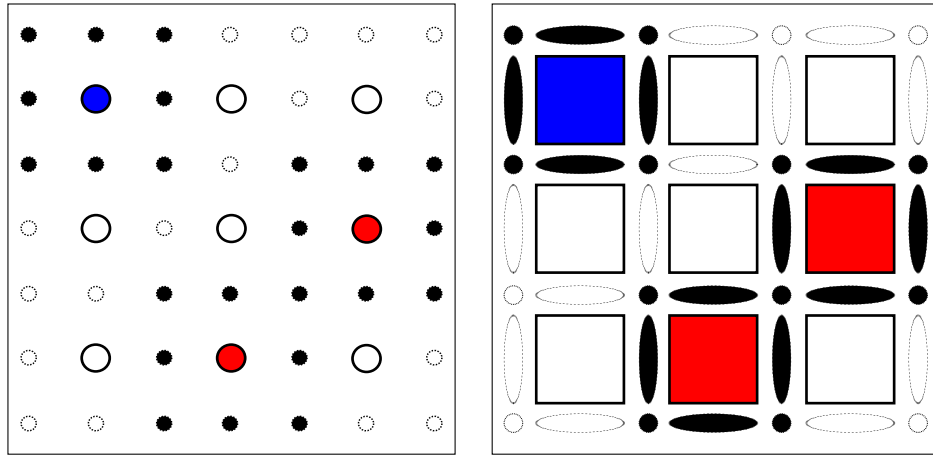

Figure 5.3: Topological isomorphism between $(\mathbb{Z}/2)^2$ and \mathbb{H}^2 supplied with their respective topologies.

5.2.4 From \mathbb{H}^n to $(\mathbb{Z}/2)^n$

Let us show that $\mathcal{Z}_n : \mathbb{H}^n \rightarrow (\mathbb{Z}/2)^n$ is a topological isomorphism, *i.e.* a bicontinuous bijection, between $((\mathbb{Z}/2)^n, \mathcal{U}_{(\mathbb{Z}/2)^n})$ and $(\mathbb{H}^n, \mathcal{U}_{\mathbb{H}^n})$.

\mathcal{Z} and \mathcal{Z}_n are bijections

Let us first prove that \mathcal{Z} is injective. Let h^1, h^2 be two elements of \mathbb{H}^1 . We assume that $\mathcal{Z}(h^1) = \mathcal{Z}(h^2)$. Either $\mathcal{Z}(h^1) \in \mathbb{Z}$, and in this case $h^1 = \{\mathcal{Z}(h^1), \mathcal{Z}(h^1) + 1\} = h^2$, or $\mathcal{Z}(h^1) \in (\mathbb{Z}/2) \setminus \mathbb{Z}$, and in this case $h^1 = \{\mathcal{Z}(h^1) - \frac{1}{2}\} = h^2$.

Now let us prove that \mathcal{Z} is surjective. For any value $z \in (\mathbb{Z}/2)$, there exists $h \in \mathbb{H}^1$ such that $\mathcal{Z}(h) = z$. Effectively, if $z \in \mathbb{Z}$, we can choose $h = \{z, z + 1\}$ to verify this property, and if $z \in (\mathbb{Z}/2) \setminus \mathbb{Z}$, we can choose $h = \{z - \frac{1}{2}\}$ to verify again this property.

Since we have proven that \mathcal{Z} is a bijection, it follows that \mathcal{Z}_n is a bijection as a cartesian product of bijections.

Continuity of \mathcal{Z}_n

We want to show here that for any open set \mathcal{O} of $(\mathbb{Z}/2)^n$, the inverse image of \mathcal{O} by \mathcal{Z}_n is open in \mathbb{H}^n .

Since the topology of $(\mathbb{Z}/2)^n$ is a product topology, \mathcal{O} is an union of cartesian products of open sets of $(\mathbb{Z}/2)$. In other words, we can write $\mathcal{O} = \bigcup_i \bigotimes_{j \in \llbracket 1, n \rrbracket} \mathcal{O}_j^i$ where \mathcal{O}_j^i is open in $(\mathbb{Z}/2)$.

Moreover, each \mathcal{O}_j^i can be written as an union of elementary open sets $\mathcal{E}_j^{i,k}$ such that $\mathcal{O}_j^i = \bigcup_m \mathcal{E}_j^{i,m}$ with $\mathcal{E}_j^{i,m} = ([k_m, l_m] \cap (\mathbb{Z}/2))$ where $k_m, l_m \in \mathbb{Z}$ are such that $k_m \leq l_m$. We can decompose $\mathcal{E}_j^{i,m}$ into two sets $\mathfrak{J}_j^{i,m}$ and $\mathfrak{J}'_j^{i,m}$ defined by:

$$\begin{cases} \mathfrak{J}_j^{i,m} = \bigcup \{ \{a\} ; a \in \mathbb{Z} \cap \mathcal{E}_j^{i,m} \}, \\ \mathfrak{J}'_j^{i,m} = \bigcup \{ [a, a+1] \cap (\mathbb{Z}/2) ; [a, a+1] \subseteq \mathcal{E}_j^{i,m}, a \in \mathbb{Z} \}. \end{cases} \quad (5.5)$$

Therefore we obtain that :

$$\begin{aligned} \mathcal{Z}_n^{-1}(\mathcal{O}) &= \bigcup_i \mathcal{Z}_n^{-1} \left(\bigotimes_{j \in \llbracket 1, n \rrbracket} \mathcal{O}_j^i \right) \\ &= \bigcup_i \bigotimes_{j \in \llbracket 1, n \rrbracket} \mathcal{Z}^{-1}(\mathcal{O}_j^i) \\ &= \bigcup_i \bigotimes_{j \in \llbracket 1, n \rrbracket} \mathcal{Z}^{-1} \left(\bigcup_m \mathcal{E}_j^{i,m} \right) \\ &= \bigcup_i \bigotimes_{j \in \llbracket 1, n \rrbracket} \left(\bigcup_m \mathcal{Z}^{-1}(\mathcal{E}_j^{i,m}) \right) \\ &= \bigcup_i \bigotimes_{j \in \llbracket 1, n \rrbracket} \left(\bigcup_m \mathcal{Z}^{-1}(\mathfrak{J}_j^{i,m} \cup \mathfrak{J}'_j^{i,m}) \right) \\ &= \bigcup_i \bigotimes_{j \in \llbracket 1, n \rrbracket} \left(\bigcup_m (\mathcal{Z}^{-1}(\mathfrak{J}_j^{i,m}) \cup \mathcal{Z}^{-1}(\mathfrak{J}'_j^{i,m})) \right) \end{aligned}$$

Since for all $a \in \mathbb{Z}$,

$$\mathcal{Z}^{-1}(\{a\}) = \{ \mathcal{Z}^{-1}(a) \} = \{ \{a, a+1\} \} = \beta(\{a, a+1\}),$$

it follows that $\mathcal{Z}^{-1}(\mathfrak{J}_j^{i,m})$ is open in \mathbb{H}^1 . Also, since for all $a \in \mathbb{Z}$,

$$\begin{aligned}\mathcal{Z}^{-1}([a, a+1] \cap (\mathbb{Z}/2)) &= \mathcal{Z}^{-1}(\{a, a + \frac{1}{2}, a+1\}), \\ &= \{\{a, a+1\}, \{a+1\}, \{a+1, a+2\}\} = \beta(\{a+1\}),\end{aligned}$$

it follows that $\mathcal{Z}^{-1}(\mathfrak{J}_j^{i,m})$ is open in \mathbb{H}^1 too. The consequence is that $\mathcal{Z}^{-1}(\mathfrak{J}_j^{i,m}) \cup \mathcal{Z}^{-1}(\mathfrak{J}_j^{i,m})$ is open into \mathbb{H}^1 and then $\mathcal{Z}_n^{-1}(\mathcal{O})$ is open in \mathbb{H}^n as union of cartesian products of open sets of \mathbb{H}^1 (see Lemma 3).

Defining the inverse applications of \mathcal{Z} and \mathcal{Z}_n

Starting from the definition of \mathcal{Z} , we can easily deduce the definition of its inverse $\mathcal{H} : (\mathbb{Z}/2) \rightarrow \mathbb{H}^1$ such that:

$$\forall z \in (\mathbb{Z}/2), \mathcal{H}(z) = \begin{cases} \{z + 1/2\} & \text{if } z \in (\mathbb{Z}/2) \setminus \mathbb{Z}, \\ \{z, z + 1\} & \text{if } z \in \mathbb{Z}. \end{cases} \quad (5.6)$$

Then we can define $\mathcal{H}_n : (\mathbb{Z}/2)^n \rightarrow \mathbb{H}^n$ as the n -ary cartesian product of \mathcal{H} :

$$\forall z \in (\mathbb{Z}/2)^n, \mathcal{H}_n(z) = \bigotimes_{i \in \llbracket 1, n \rrbracket} \mathcal{H}(z_i),$$

where z_i is the i^{th} coordinate, $i \in \llbracket 1, n \rrbracket$ of z .

It can be easily verified that \mathcal{H}_n is the inverse of \mathcal{Z}_n . Effectively, $\forall z \in (\mathbb{Z}/2)^n$:

$$\begin{aligned}\mathcal{Z}_n(\mathcal{H}_n(z)) &= \mathcal{Z}_n(\mathcal{H}_n(\bigotimes_{i \in \llbracket 1, n \rrbracket} z_i)), \\ &= \mathcal{Z}_n(\bigotimes_{i \in \llbracket 1, n \rrbracket} \mathcal{H}(z_i)), \\ &= \bigotimes_{i \in \llbracket 1, n \rrbracket} \mathcal{Z}(\mathcal{H}(z_i)), \\ &= \bigotimes_{i \in \llbracket 1, n \rrbracket} z_i, \\ &= z,\end{aligned}$$

since \mathcal{Z} and \mathcal{H} are inverse applications. A same reasoning will show that $\forall h \in \mathbb{H}^n, \mathcal{H}_n(\mathcal{Z}_n(h)) = h$.

Continuity of the inverse of \mathcal{Z}_n

Let \mathcal{O} be an open set of \mathbb{H}^n , we want to show that the inverse image of \mathcal{O} by \mathcal{H}_n is open in $(\mathbb{Z}/2)^n$.

Since \mathcal{O} is open into \mathbb{H}^n , we can write :

$$\mathcal{O} = \bigcup_{h \in \mathcal{O}} \beta(h),$$

and then

$$\mathcal{Z}_n(\mathcal{O}) = \mathcal{Z}_n \left(\bigcup_{h \in \mathcal{O}} \beta(h) \right) = \bigcup_{h \in \mathcal{O}} \mathcal{Z}_n(\beta(h)).$$

Using Lemma 2, we obtain:

$$\mathcal{Z}_n(\mathcal{O}) = \bigcup_{h \in \mathcal{O}} \mathcal{Z}_n(\otimes_{i \in [1, n]} \beta(h_i)) = \bigcup_{h \in \mathcal{O}} \otimes_{i \in [1, n]} \mathcal{Z}(\beta(h_i)).$$

Two only cases are then possible for each term h_i : either there exists an element $a \in \mathbb{Z}$ such that $h_i = \{a\}$, and then $\beta(h_i) = \{\{a-1, a\}, \{a\}, \{a, a+1\}\}$ which leads to $\mathcal{Z}(\beta(h_i)) = \{a-1, a-\frac{1}{2}, a\}$, or there exists an element $a \in \mathbb{Z}$ such that $h_i = \{a, a+1\}$, and then $\beta(h_i) = \{\{a, a+1\}\}$ which leads to $\mathcal{Z}(\beta(h_i)) = \{a\}$. In both cases, $\mathcal{Z}(\beta(h_i))$ is open in $(\mathbb{Z}/2)$ and then \mathcal{O} is open into $(\mathbb{Z}/2)^n$.

Relation between $(\mathbb{Z}/2)^n$ and \mathbb{H}^n

\mathcal{H}_n and \mathcal{Z}_n are inverse topological isomorphisms, and then $(\mathbb{Z}/2)^n$ and \mathbb{H}^n , supplied with their respective topologies, are topologically isomorphic, *i.e.*, they have the same topological structure. \square

5.3 Reformulating the formula of the boundary

Let us show that we can reformulate the topological boundary of $\mathcal{I}MM(X) = \text{Int}(\alpha(\mathcal{H}_n(X)))$ as a function of the isomorphism \mathcal{X} of X and its complement \mathcal{Y} in \mathbb{H}_n^n :

Proposition 11. *Let $X \subseteq \mathbb{Z}^n$ be a set. Now let us denote $\mathcal{X} = \mathcal{H}_n(X) \subseteq \mathbb{H}_n^n$, $\mathcal{Y} = \mathbb{H}_n^n \setminus \mathcal{X}$, and $\mathcal{I}MM(X) = \text{Int}(\alpha(\mathcal{X}))$. Then the topological boundary $\partial \mathcal{I}MM(X)$ can be reformulated such that:*

$$\mathfrak{N} = \alpha(\mathcal{X}) \cap \alpha(\mathcal{Y}).$$

Proof: Let us first remark that $\alpha(\mathcal{X})$ is a regular closed set. Effectively, we have that $\text{Int}(\alpha(\mathcal{X})) \subseteq \alpha(\mathcal{X})$, which implies that $\alpha(\text{Int}(\alpha(\mathcal{X}))) \subseteq \alpha(\mathcal{X})$ by transitivity of the operator α . Conversely, let p be an element of $\alpha(\mathcal{X})$, then there exists $x \in \mathcal{X}$ such that $p \in \alpha(x)$. Yet, $\text{Int}(\alpha(\mathcal{X})) = \{h \in \alpha(\mathcal{X}) ; \beta(h) \subseteq \alpha(\mathcal{X})\}$, and $x \in \mathbb{H}_n^n$ verifies that $\beta(x) = \{x\} \subseteq \text{Int}(\alpha(\mathcal{X}))$. Then $x \in \text{Int}(\alpha(\mathcal{X}))$, and then $p \in \alpha(x) \subseteq \alpha(\text{Int}(\alpha(\mathcal{X})))$. Then, $\alpha(\mathcal{X})$ is a regular closed set.

Using this fact, we can simplify the formula of \mathfrak{N} :

$$\begin{aligned} \mathfrak{N} &= \alpha(\mathcal{I}\mathcal{M}\mathcal{M}(X)) \cap \alpha(\mathbb{H}^n \setminus \mathcal{I}\mathcal{M}\mathcal{M}(X)), \\ &= \alpha(\text{Int}(\alpha(\mathcal{X}))) \cap \mathbb{H}^n \setminus \mathcal{I}\mathcal{M}\mathcal{M}(X), \\ &= \alpha(\mathcal{X}) \setminus \text{Int}(\alpha(\mathcal{X})), \\ &= \alpha(\mathcal{X}) \cap (\text{Int}(\alpha(\mathcal{X})))^c, \\ &= \alpha(\mathcal{X}) \cap \alpha(\text{Int}(\mathcal{X}^c)). \end{aligned}$$

Then we want to show that:

$$\alpha(\mathcal{X}) \cap \alpha(\text{Int}(\mathcal{X}^c)) = \alpha(\mathcal{X}) \cap (\mathcal{Y}).$$

Let us begin with the converse inclusion. Since $\mathcal{Y} = \mathbb{H}^n \setminus \mathcal{X} \subseteq \mathbb{H}^n \setminus \mathcal{X}$, it is clear that $\text{Int}(\mathcal{Y}) \subseteq \text{Int}(\mathbb{H}^n \setminus \mathcal{X})$. Since \mathcal{Y} is open as union of n -faces, we obtain then that $\mathcal{Y} \subseteq \text{Int}(\mathbb{H}^n \setminus \mathcal{X})$. Using the (increasing) operator α , it is clear that $\alpha(\mathcal{Y}) \subseteq \alpha(\text{Int}(\mathbb{H}^n \setminus \mathcal{X})) = \alpha(\text{Int}(\mathcal{X}^c))$, and then $\alpha(\mathcal{X}) \cap \alpha(\mathcal{Y}) \subseteq \alpha(\mathcal{X}) \cap \alpha(\text{Int}(\mathcal{X}^c))$.

Let us now prove the direct inclusion. Let us assume that z is an element of $\alpha(\mathcal{X}) \cap \alpha(\text{Int}(\mathcal{X}^c))$. We have three possibles cases. The first case corresponds to $\beta(z) \cap \mathbb{H}_n^n \subseteq \mathcal{X}$ (1), the second case corresponds to $\beta(z) \cap \mathbb{H}_n^n \subseteq \mathcal{Y}$ (2), and the thrid case correspond to $\beta(z) \cap \mathbb{H}_n^n \cap \mathcal{X} \neq \emptyset \neq \beta(z) \cap \mathbb{H}_n^n \cap \mathcal{Y}$ (3).

Before treating the first case, let us prove that $\alpha(\beta(z)) = \alpha(\beta(z) \cap \mathbb{H}_n^n)$ (P). The converse inclusion is obvious. Concerning the direct inclusion, let a be an element of $\alpha(\beta(z))$. Then there exists $p \in \beta(z)$ such that $a \in \alpha(p)$. Also, \mathbb{H}^n is a n -surface (see Theorem 6) and then is homogeneous (see Property 5). This implies that there exists $p^n \in \beta(p)$ such that $p^n \in \mathbb{H}_n^n$. Since $p^n \in \beta(p)$ and $p \in \beta(z)$, $p^n \in \beta(z) \cap \mathbb{H}_n^n$, and then the fact that a belongs to $\alpha(p)$ implies that $a \in \alpha(\beta(z) \cap \mathbb{H}_n^n)$. This way, (P) is true.

Now we can treat the first case: $\beta(z) \cap \mathbb{H}_n^n \subseteq \mathcal{X}$. This implies that $\text{Int}(\alpha(\beta(z) \cap \mathbb{H}_n^n)) \subseteq \text{Int}(\alpha(\mathcal{X}))$. Using (P), we obtain that $\text{Int}(\alpha(\beta(z))) \subseteq$

$\text{Int}(\alpha(\mathcal{X}))$. Since $\beta(z)$ is an open regular set, we obtain that $\beta(z) \subseteq \text{Int}(\alpha(\mathcal{X}))$. Yet, $\beta(z) \subseteq \alpha(\beta(z)) = \alpha(\mathcal{X})$ (since $\alpha(\mathcal{X})$ is a regular closed set). However, this implies that $\beta(z) = \text{Int}(\beta(z)) \subseteq \text{Int}(\alpha(\mathcal{X}))$, and then $z \notin (\text{Int}(\alpha(\mathcal{X})))^c$, which is a contradiction. This case is then impossible.

In the second case, $\beta(z) \cap \mathbb{H}_n^n \subseteq \mathcal{Y}$, which is equivalent to say that there do not exist any $x \in \mathcal{X}$ such that $x \in \beta(z)$, which is equivalent to say that there do not exist any $x \in \mathcal{X}$ such that $z \in \alpha(x)$, which is equivalent to $z \notin \alpha(\mathcal{X})$, which leads one more time to a contradiction. This case is then impossible too.

In the third case, $\beta(z) \cap \mathbb{H}_n^n \cap \mathcal{X} \neq \emptyset$ and $\beta(z) \cap \mathbb{H}_n^n \cap \mathcal{Y} \neq \emptyset$ implies that there exists some $x \in \mathcal{X}$ and $y \in \mathcal{Y}$ such that $z \in \alpha(x) \cap \alpha(y)$, and then $z \in \alpha(\mathcal{X}) \cap \alpha(\mathcal{Y})$. The proof is done. \square

5.4 Hypotheses of the problem

The two spaces we are working in are the discrete space $(\mathbb{Z}/2)^n$ and its topological isomorphism \mathbb{H}^n , which are both of dimension $n \geq 2$.

Notations 6 ($X, Y, \mathcal{X}, \mathcal{Y}, \mathfrak{N}$). *From now on, we define the set X as a given subset of \mathbb{Z}^n , and its complement Y in $\mathbb{Z}^n : Y = \mathbb{Z}^n \setminus X$. We also define their isomorphisms in \mathbb{H}^n using \mathcal{Z}_n as in Definition 54 such that $\mathcal{X} = \mathcal{H}_n(X)$ and $\mathcal{Y} = \mathcal{H}_n(Y)$. Then, we define the common boundary \mathfrak{N} of \mathcal{X} and \mathcal{Y} in \mathbb{H}^n such that:*

$$\mathfrak{N} = \alpha(\mathcal{X}) \cap \alpha(\mathcal{Y})$$

We can remark that $\mathcal{X} \cup \mathcal{Y} = \mathbb{H}_n^n$, $\mathcal{X} \cap \mathcal{Y} = \emptyset$ and for these reasons:

$$\mathbb{H}_n^n \cap \mathfrak{N} = \emptyset.$$

5.5 Stating the problem

In this section, we want to show that each finite set $X \subset \mathbb{Z}^n$ is digitally well-composed iff its immersion $\mathcal{I}\mathcal{M}\mathcal{M}(X)$ is well-composed in the sense of Alexandrov. In other words, we want to prove that the absence of critical configurations in X is equivalent to say that the connected components of the topological boundary \mathfrak{N} of $\mathcal{I}\mathcal{M}\mathcal{M}(X)$ are $(n - 1)$ -surfaces.

5.6 Reformulating the problem

After having recalled some basic definitions, let us show that we can reformulate the property that $\mathcal{I}MM(X)$ is AWC in a local way.

Definition 55 (Separated sets). *Let A, B two subsets of \mathbb{H}^n . We say that A and B are separated iff the following property holds:*

$$(A \cap (\beta(B))) \cup (\beta(A) \cap B) = \emptyset.$$

Now, let us show that this problem, which is basically *global* in the sense that AWCness is based on connected components, can be proven based on local properties.

Lemma 4. *Using Notations 6, $\mathcal{I}MM(X)$ is AWC iff for each $z \in \mathfrak{N}$, $|\theta_{\mathfrak{N}}^{\square}(z)|$ is a $(n - 2)$ -surface.*

Proof: Let us define $C_1, C_2 \in \mathcal{CC}(\mathfrak{N})$, where $\mathcal{CC}(\mathfrak{N})$ denotes the set of connected components of \mathfrak{N} . These two components are then *separated*, i.e.,

$$(\beta(C_1) \cap C_2) \cup (\beta(C_2) \cap C_1) = \emptyset,$$

which is equivalent to:

$$(\beta(C_1) \cap C_2) \cup (\alpha(C_1) \cap C_2) = \emptyset,$$

then we can deduce easily that $\theta(C_1) \cap C_2 = \emptyset$, and then for each point $z \in C_1$, $\theta(z) \cap C_2 \subseteq \theta(C_1) \cap C_2 = \emptyset$.

So let z be a point in C_1 , then we obtain:

$$|\theta_{\mathfrak{N}}^{\square}(z)| = |\theta^{\square}(z) \cap \mathfrak{N}| = |\theta^{\square}(z) \cap \bigcup_{C \in \mathcal{CC}(\mathfrak{N})} C| = |\bigcup_{C \in \mathcal{CC}(\mathfrak{N})} (\theta^{\square}(z) \cap C)| = |\theta_{C_1}^{\square}(z)|.$$

In this way, we can write:

$$\begin{aligned} \mathcal{I}MM(X) \text{ is AWC} &\Leftrightarrow \forall C \in \mathcal{CC}(\mathfrak{N}), C \text{ is a } (n - 1) - \text{surface} \\ &\Leftrightarrow \forall C \in \mathcal{CC}(\mathfrak{N}), \forall z \in C, |\theta_C^{\square}(z)| \text{ is a } (n - 2) - \text{surface,} \\ &\Leftrightarrow \forall C \in \mathcal{CC}(\mathfrak{N}), \forall z \in C, |\theta_{\mathfrak{N}}^{\square}(z)| \text{ is a } (n - 2) - \text{surface.} \\ &\Leftrightarrow \forall z \in \mathfrak{N}, |\theta_{\mathfrak{N}}^{\square}(z)| \text{ is a } (n - 2) - \text{surface.} \end{aligned}$$

□

Now let us follow with a simple proposition.

Proposition 12. *Using Notations 6, \mathfrak{N} is closed in $|\mathbb{H}^n|$.*

Proof: \mathfrak{N} is closed in $|\mathbb{H}^n|$ as intersection of $\alpha(\mathcal{X})$ and $\alpha(\mathcal{Y})$ which are both closed in $|\mathbb{H}^n|$. □

Using this proposition, we will observe that for any element $z \in \mathfrak{N}$, we obtain $\alpha_{\mathfrak{N}}^{\square}(z) = \alpha^{\square}(z)$, which means that we can obviate the restriction to \mathfrak{N} in the expression $\alpha_{\mathfrak{N}}^{\square}(z)$.

Proposition 13. *Let F be a closed subset of $|\mathbb{H}^n|$, then:*

$$F = \bigcup_{h \in F} \alpha(h).$$

Proof: It is simply due to the symmetry between closed sets and open sets in Alexandrov spaces. □

Proposition 14. *Let F be a closed set in $|\mathbb{H}^n|$, and h be an element of S . Then $\alpha(h) \subseteq F$.*

Proof: It is a direct consequence of Proposition 13. □

Proposition 15. *Using Notations 6, for any $z \in \mathfrak{N}$, $\alpha_{\mathfrak{N}}^{\square}(z) = \alpha^{\square}(z)$.*

Proof: For any $z \in \mathfrak{N}$, by Proposition 14 and Proposition 12, $\alpha(z) \subseteq \mathfrak{N}$, and then $\alpha^{\square}(z) \subseteq \mathfrak{N}$, which implies that $\alpha_{\mathfrak{N}}^{\square}(z) = \alpha^{\square}(z) \cap N = \alpha^{\square}(z)$. □

Now let us show that the term $|\alpha_{\mathfrak{N}}^{\square}(z)|$ has a particular structure:

Proposition 16. *Using Notations 6, for any $z \in \mathfrak{N}$:*

$$|\alpha_{\mathfrak{N}}^{\square}(z)| \text{ is a } (\dim(z) - 1)\text{-surface.}$$

Proof: By Proposition 15, for any $z \in \mathfrak{N}$, $\alpha_{\mathfrak{N}}^{\square}(z) = \alpha^{\square}(z) \equiv \alpha_{\mathbb{H}^n}^{\square}(z)$. Also, by Theorem 6, \mathbb{H}^n is a n -surface (according to Evako [13]). Then, $|\alpha_{\mathfrak{N}}^{\square}(z)|$ is a $(\rho(z, |\mathbb{H}^n|) - 1)$ -surface by Property 6. Since the rank of an element of $|\mathbb{H}^n|$ is equal to its dimension, we obtain finally that $|\alpha_{\mathfrak{N}}^{\square}(z)|$ is a $(\dim(z) - 1)$ -surface. □

This proposition is much important because it allows us to decompose the term $\theta_{\mathfrak{N}}^{\square}(z)$ in Lemma 4.

Lemma 5. *Using Notations 6, for any $z \in \mathfrak{N}$, $|\theta_{\mathfrak{N}}^{\square}(z)|$ is a $(n - 2)$ -surface iff $|\beta_{\mathfrak{N}}^{\square}(z)|$ is a $(n - 2 - \dim(z))$ -surface.*

Proof: It is the direct result of the combination of Theorem 7 [11] and Proposition 16. \square

It results the following theorem:

Theorem 8. *Using Notations 6, $\mathcal{I}MM(X)$ is AWC iff:*

$$\{\forall z \in \mathfrak{N}, |\beta_{\mathfrak{N}}^{\square}(z)| \text{ is a } (n - \dim(z) - 2) - \text{surface}\}.$$

Proof: we obtain this result by combining Lemma 5 and Lemma 4. \square

Our main goal is then to show that:

$$\{X \text{ is DWC}\} \Leftrightarrow \{\forall z \in \mathfrak{N}, |\beta_{\mathfrak{N}}^{\square}(z)| \text{ is a } (n - 2 - \dim(z)) - \text{surface}\}.$$

5.7 Proof of the converse implication

In this section, we prove that:

$$\{\forall z \in \mathfrak{N}, |\beta_{\mathfrak{N}}^{\square}(z)| \text{ is a } (n - 2 - \dim(z)) - \text{surface}\} \Rightarrow \{X \text{ DWC}\}.$$

For that, we are going to show the counterposition: if X is not digitally well-composed, then there exists a point $z^* \in \mathfrak{N}$, that we will call the *critical point*, such that $|\beta_{\mathfrak{N}}^{\square}(z^*)|$ is not a $(n - 2 - \dim(z))$ -surface.

5.7.1 Complements about antagonism

Let us recall that two points of \mathbb{Z}^n are antagonist in a block of dimension $k \in \llbracket 0, n \rrbracket$ iff they belong to this block and if they maximize the L^1 distance between two points of this block.

Lemma 6. *Let x, y be two elements of \mathbb{Z}^n . Then, x and y are antagonist in a block of \mathbb{Z}^n of dimension $k \in \llbracket 0, n \rrbracket$ iff:*

$$\left\{ \begin{array}{l} \text{Card} \{m \in \llbracket 1, n \rrbracket ; x_m = y_m\} = n - k, \quad (1) \\ \text{Card} \{m \in \llbracket 1, n \rrbracket ; |x_m - y_m| = 1\} = k. \quad (2) \end{array} \right.$$

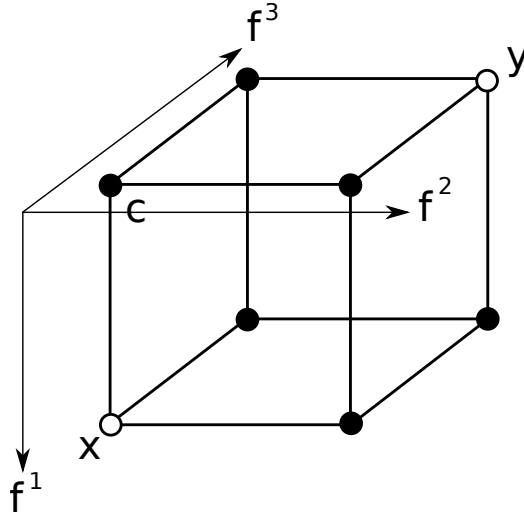

Figure 5.4: The points $x = c + f^1$ and $y = c + f^2 + f^3$ of \mathbb{Z}^n are antagonist in the block $S(c, \{f^1, f^2, f^3\})$ of dimension 3.

Proof: Let us begin with the converse implication. Let us assume that we start from $x, y \in \mathbb{Z}^n$ and $k \in \llbracket 0, n \rrbracket$ such that (1) and (2) are verified. Let us prove that x and y belong to a same block in $\mathcal{B}(\mathbb{Z}^n)$ of dimension k . For that, let us define $c \in \mathbb{Z}^n$ such that for any coordinate $i \in \llbracket 1, n \rrbracket$, $c_i = \min(x_i, y_i)$. This point will be characteristic of that block. Now, let us define:

$$\begin{aligned} \mathcal{I}_x &= \{i \in \llbracket 1, n \rrbracket ; c_i \neq x_i\}, \\ \mathcal{I}_y &= \{i \in \llbracket 1, n \rrbracket ; c_i \neq y_i\}, \end{aligned}$$

then it follows that:

$$\begin{cases} x = c + \sum_{i \in \mathcal{I}_x} e^i, & (3) \\ y = c + \sum_{i \in \mathcal{I}_y} e^i. & (4) \end{cases}$$

Also, we can remark that:

$$\begin{aligned} \mathcal{I}_x &= \{i \in \llbracket 1, n \rrbracket ; c_i = y_i \wedge x_i \neq y_i\}, \\ \mathcal{I}_y &= \{i \in \llbracket 1, n \rrbracket ; c_i = x_i \wedge x_i \neq y_i\}, \end{aligned}$$

and then $\mathcal{I}_x \cap \mathcal{I}_y = \emptyset$. It follows then that $\mathcal{F} = \{e^i \in \mathbb{B} ; i \in \mathcal{I}_x \cup \mathcal{I}_y\}$ is of dimension $\text{Card}(\mathcal{I}_x) + \text{Card}(\mathcal{I}_y)$, which is equal to k by (1) and (2). Finally, we obtain that the block $S(c, \mathcal{F}) \in \mathcal{B}(\mathbb{Z}^n)$ contains x and y by (3) and (4). Also, by (1) and (2), we know that $\|x - y\|_1 = k$, which is the maximal

distance in a block of dimension k . Then, x and y are antagonist in $S(c, \mathcal{F})$, which concludes the proof of the converse implication.

Let us now prove the direct implication. We assume that $x, y \in \mathbb{Z}^n$ are antagonist in a block $S(c, \mathcal{F})$ of \mathbb{Z}^n of dimension $k \in \llbracket 0, n \rrbracket$. Let i be an integer in $\llbracket 1, n \rrbracket$, then two cases are possible: either the i^{th} canonical vector e^i belongs to \mathcal{F} and then $|x_i - y_i| = 1$, or it does not belong to \mathcal{F} and in this case $x_i = y_i$. Since $\text{Card}(\mathcal{F}) = k$ by hypothesis, it concludes the proof. \square

5.7.2 Infimum of two faces

Let us study under which condition we can say that an *infimum* exists between two elements $a, b \in \mathbb{H}^n$, that is, when there exists a greatest element which is superior or equal to any element which is inferior to both a and b .

Definition 56 (Supremum). *Let X be a subset of \mathbb{H}^n . If there exists one element $x \in X$ such that for any $y \in X$, $y \subseteq x$, we say that x is the greatest element of X , and we denote it $\sup(X)$.*

Definition 57 (Infimum). *Let a, b be two elements of \mathbb{H}^n . When $\sup(\alpha(a) \cap \alpha(b))$ is well-defined, we denote it $a \wedge b$ and we call it the infimum between a and b .*

Lemma 7. *Let a, b be two elements of \mathbb{H}^n . Then,*

$$\{\alpha(a) \cap \alpha(b) \neq \emptyset\} \Leftrightarrow \{a \wedge b \text{ is well-defined}\}.$$

Furthermore, when $a \wedge b$ is well-defined, it verifies the relations:

$$\begin{cases} a \wedge b = \otimes_{i \in \llbracket 1, n \rrbracket} (a_i \wedge b_i), \\ \alpha(a \wedge b) = \alpha(a) \cap \alpha(b). \end{cases}$$

Proof: Let us treat the one-dimensional case $a_1, b_1 \in \mathbb{H}^1$, and let us proceed case by case.

- Either $a_1, b_1 \in \mathbb{H}_0^1$. Then there exist $i, j \in \mathbb{Z}$ s.t. $a_1 = \{i\}$ et $b_1 = \{j\}$. Then $\alpha(a_1) = \{\{i\}\}$ and $\alpha(b_1) = \{\{j\}\}$.
 - Either $i = j$ and $\alpha(a_1) \cap \alpha(b_1) = \{\{i\}\}$ then $\sup(\alpha(a_1) \cap \alpha(b_1)) = \{i\}$ and $\alpha(a_1 \wedge b_1) = \alpha(a_1) \cap \alpha(b_1)$.

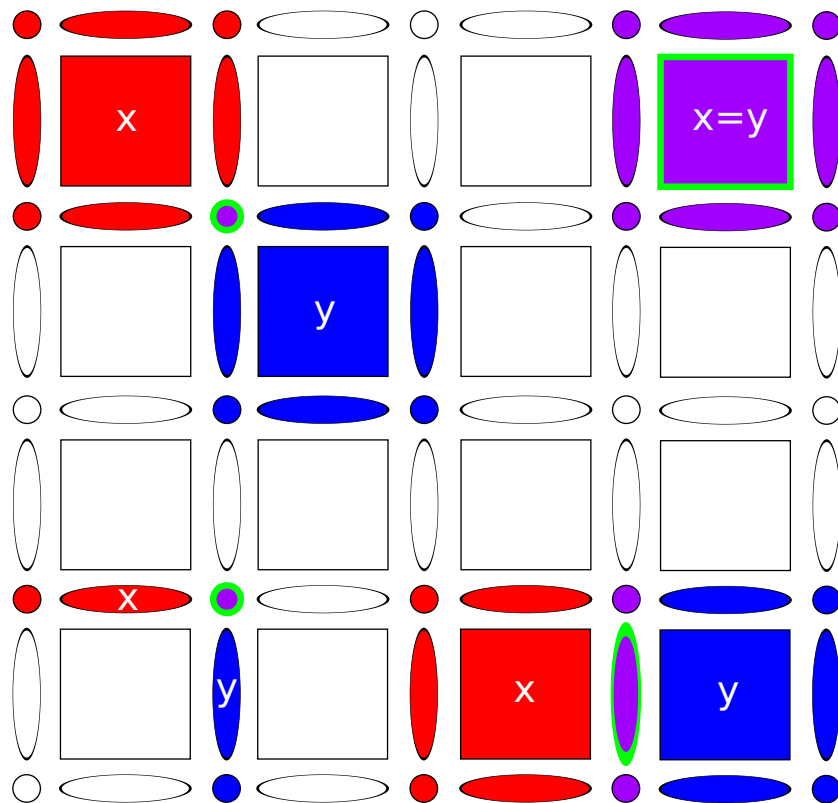

Figure 5.5: Examples of infimums between x and y : $\alpha(x)$ is in red, $\alpha(y)$ is in blue, their intersection is in purple, and the infimum of x and y has a green contour.

- Or $i \neq j$ and $\alpha(a_1) \cap \alpha(b_1) = \emptyset$, then $a_1 \wedge b_1$ does not exist.
- Or $a_1 \in \mathbb{H}_1^1$ and $b_1 \in \mathbb{H}_0^1$. Then there exists $i, j \in \mathbb{Z}$ s.t. $a_1 = \{i, i+1\}$ and $b_1 = \{j\}$. Then $\alpha(a_1) = \{\{i\}, \{i+1\}, \{i, i+1\}\}$ and $\alpha(b_1) = \{\{j\}\}$.
 - Either $i = j$, and $\alpha(a_1) \cap \alpha(b_1) = \{\{i\}\}$, $a_1 \wedge b_1 = \{i\}$, and $\alpha(a_1) \cap \alpha(b_1) = \alpha(a_1 \wedge b_1)$.
 - Or $i = j - 1$, $\alpha(a_1) \cap \alpha(b_1) = \{\{j\}\}$, $a_1 \wedge b_1 = \{j\}$, and $\alpha(a_1) \cap \alpha(b_1) = \alpha(a_1 \wedge b_1)$.
 - Or $i \notin \{j, j-1\}$, $\alpha(a_1) \cap \alpha(b_1) = \emptyset$ and $a_1 \wedge b_1$ does not exist.
- Or $a_1 \in \mathbb{H}_0^1$ and $b_1 \in \mathbb{H}_1^1$ and the reasoning is similar to the one before.
- Or $a_1, b_1 \in \mathbb{H}_1^1$. Then there exists $i, j \in \mathbb{Z}$ s.t. $a_1 = \{i, i+1\}$ and $b_1 = \{j, j+1\}$. We obtain $\alpha(a_1) = \{\{i\}, \{i+1\}, \{i, i+1\}\}$ and $\alpha(b_1) = \{\{j\}, \{j+1\}, \{j, j+1\}\}$.
 - Either $i = j$ and $\alpha(a_1) \cap \alpha(b_1) = \{\{i\}, \{i+1\}, \{i, i+1\}\}$, $a_1 \wedge b_1 = \{i, i+1\}$, and $\alpha(a_1) \cap \alpha(b_1) = \alpha(a_1 \wedge b_1)$.
 - Or $i = j - 1$, $\alpha(a_1) \cap \alpha(b_1) = \{\{j\}\}$, $a_1 \wedge b_1 = \{j\}$, and $\alpha(a_1) \cap \alpha(b_1) = \alpha(a_1 \wedge b_1)$.
 - Or $i = j + 1$, $\alpha(a_1) \cap \alpha(b_1) = \{\{j+1\}\}$, and $a_1 \wedge b_1 = \{j+1\}$ and $\alpha(a_1) \cap \alpha(b_1) = \alpha(a_1 \wedge b_1)$.
 - Or $i \notin \{j-1, j, j+1\}$ and $\alpha(a_1) \cap \alpha(b_1) = \emptyset$ and $a_1 \wedge b_1$ does not exist.

Then, when a, b belong to \mathbb{H}^n , $n \geq 1$, s.t. $\alpha(a) \cap \alpha(b) \neq \emptyset$, we can use Lemma 1 (see the Annex) and then we obtain that:

$$\begin{aligned}
\alpha(a) \cap \alpha(b) &= \alpha(\otimes_{i \in \llbracket 1, n \rrbracket} a_i) \cap \alpha(\otimes_{i \in \llbracket 1, n \rrbracket} b_i), \\
&= \otimes_{i \in \llbracket 1, n \rrbracket} \alpha(a_i) \cap \otimes_{i \in \llbracket 1, n \rrbracket} \alpha(b_i) \\
&= \otimes_{i \in \llbracket 1, n \rrbracket} (\alpha(a_i) \cap \alpha(b_i)), \\
&\neq \emptyset,
\end{aligned}$$

then for each value $i \in \llbracket 1, n \rrbracket$, $\alpha(a_i) \cap \alpha(b_i) \neq \emptyset$, and then $a_i \wedge b_i$ exists and $\alpha(a_i) \cap \alpha(b_i) = \alpha(a_i \wedge b_i)$.

In this way:

$$\begin{aligned}
 \alpha(a) \cap \alpha(b) &= \alpha(\otimes_{i \in \llbracket 1, n \rrbracket} a_i) \cap \alpha(\otimes_{i \in \llbracket 1, n \rrbracket} b_i), \\
 &= \otimes_{i \in \llbracket 1, n \rrbracket} (\alpha(a_i) \cap \alpha(b_i)), \\
 &= \otimes_{i \in \llbracket 1, n \rrbracket} \alpha(a_i \wedge b_i), \\
 &= \alpha(\otimes_{i \in \llbracket 1, n \rrbracket} (a_i \wedge b_i)),
 \end{aligned}$$

where the last line is due to Lemma 1, then the greatest element of $\alpha(a) \cap \alpha(b)$ is $\otimes_{i \in \llbracket 1, n \rrbracket} (a_i \wedge b_i)$, that is, exists and is unique. Furthermore, $a \wedge b = \otimes_{i \in \llbracket 1, n \rrbracket} (a_i \wedge b_i)$, and $\alpha(a \wedge b) = \alpha(a) \cap \alpha(b)$. □

5.7.3 Link between antagonism and infimum

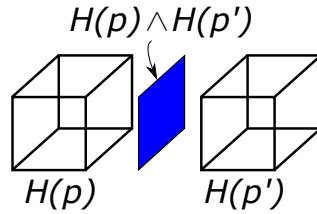

Figure 5.6: When two points p and p' defined in \mathbb{Z}^3 are 1-antagonist, the infimum $\mathcal{H}_n(p) \wedge \mathcal{H}_n(p')$ between their isomorphisms in \mathbb{H}^n is a 2-face.

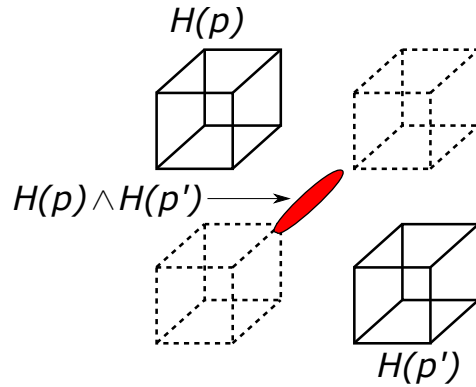

Figure 5.7: When two points p and p' defined in \mathbb{Z}^3 are 2-antagonist, the infimum $\mathcal{H}_n(p) \wedge \mathcal{H}_n(p')$ between their isomorphisms in \mathbb{H}^n is a 1-face.

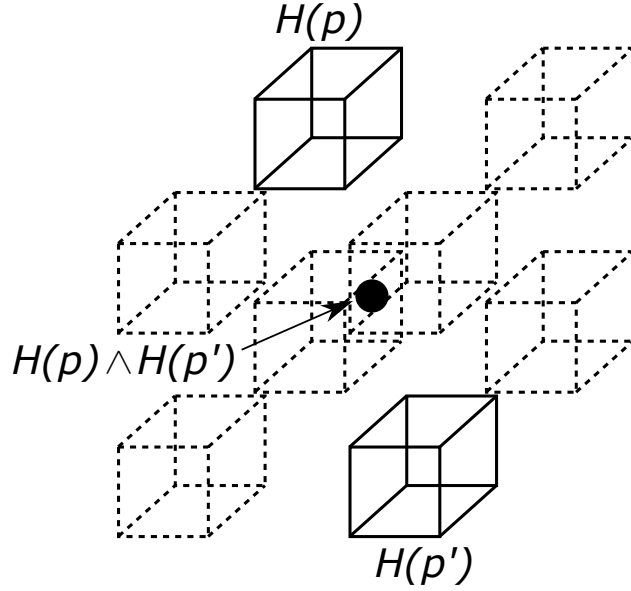

Figure 5.8: When two points p and p' defined in \mathbb{Z}^3 are 3-antagonist, the infimum $\mathcal{H}_n(p) \wedge \mathcal{H}_n(p')$ between their isomorphisms in \mathbb{H}^n is a 0-face.

Lemma 8. *Let p, p' be two elements of \mathbb{Z}^n . Then p and p' are antagonist in a block of dimension k , $k \in \llbracket 0, n \rrbracket$, in \mathbb{Z}^n iff $\mathcal{H}_n(p) \wedge \mathcal{H}_n(p')$ exists and belongs to \mathbb{H}_{n-k}^n .*

Proof: let us begin with the direct implication. Let p, p' be defined in \mathbb{Z}^n and $k \in \llbracket 0, n \rrbracket$ such that p and p' are k -antagonist. By Lemma 6, there exists $\mathfrak{J} \subseteq \llbracket 1, n \rrbracket$ such that $\text{Card}(\mathfrak{J}) = k$, and such that:

$$\begin{cases} \forall i \in \mathfrak{J}, & |p_i - p'_i| = 1, \\ \forall i \in \llbracket 1, n \rrbracket \setminus \mathfrak{J}, & p_i = p'_i. \end{cases}$$

Since for each $i \in \llbracket 1, n \rrbracket$, we have $p_i, p'_i \in \mathbb{Z}$, then $\mathcal{H}_n(p_i) = \{p_i, p_i + 1\}$, and $\mathcal{H}_n(p'_i) = \{p'_i, p'_i + 1\}$. Let us notate $z_i = \mathcal{H}_n(p_i)$ and $z'_i = \mathcal{H}_n(p'_i)$, then $z_i, z'_i \in \mathbb{H}_1^1$.

When i is in \mathfrak{J} , either $p'_i = p_i - 1$, and $\alpha(z_i) \cap \alpha(z'_i) = \{\{p_i\}\}$, and then $z_i \wedge z'_i = \{p_i\} \in \mathbb{H}_0^1$, or $p'_i = p_i + 1$, and $\alpha(z_i) \cap \alpha(z'_i) = \{\{p'_i\}\}$ and then $z_i \wedge z'_i = \{p'_i\} \in \mathbb{H}_0^1$.

When i belongs to $\llbracket 1, n \rrbracket \setminus \mathcal{J}$, $z_i = z'_i$ and $\alpha(z_i) \cap \alpha(z'_i) = \alpha(z_i)$ and then $z_i \wedge z'_i = z_i \in \mathbb{H}_1^1$.

It is then obvious that $\otimes_{i \in \llbracket 1, n \rrbracket} (z_i \wedge z'_i)$ belongs to \mathbb{H}_{n-k}^n .
Since we have $\alpha(z_i) \cap \alpha(z'_i) \neq \emptyset$ for any $i \in \llbracket 1, n \rrbracket$:

$$\begin{aligned} \alpha(\mathcal{H}_n(p)) \cap \alpha(\mathcal{H}_n(p')) &= \alpha(z) \cap \alpha(z'), \\ &= \alpha(\otimes_{i \in \llbracket 1, n \rrbracket} z_i) \cap \alpha(\otimes_{i \in \llbracket 1, n \rrbracket} z'_i), \\ &= \otimes_{i \in \llbracket 1, n \rrbracket} \alpha(z_i) \cap \otimes_{i \in \llbracket 1, n \rrbracket} \alpha(z'_i), \\ &= \otimes_{i \in \llbracket 1, n \rrbracket} (\alpha(z_i) \cap \alpha(z'_i)), \\ &\neq \emptyset, \end{aligned}$$

and then by Lemma 7, $\mathcal{H}_n(p) \wedge \mathcal{H}_n(p')$ exists and is equal to $\otimes_{i \in \llbracket 1, n \rrbracket} (z_i \wedge z'_i)$ which belongs to \mathbb{H}_{n-k}^n .

Let us proceed now to the converse implication. Let p, p' be two points of \mathbb{Z}^n , and $z = \mathcal{H}_n(p), z' = \mathcal{H}_n(p')$ such that $z \wedge z' \in \mathbb{H}_{n-k}^n$. It means that there exists $\mathcal{J} \subseteq \llbracket 1, n \rrbracket$ s.t. $\text{Card}(\mathcal{J}) = k$ and verifying:

$$\begin{cases} \forall i \in \mathcal{J}, & z_i \wedge z'_i \in \mathbb{H}_0^1, \\ \forall i \in \llbracket 1, n \rrbracket \setminus \mathcal{J}, & z_i \wedge z'_i \in \mathbb{H}_1^1. \end{cases}$$

However for $i \in \mathcal{J}$, $z_i \wedge z'_i \in \mathbb{H}_0^1$ implies $p'_i \in \{p_i - 1, p_i + 1\}$, and for $i \in \llbracket 1, n \rrbracket \setminus \mathcal{J}$, $z_i \wedge z'_i \in \mathbb{H}_1^1$ implies $z_i = z'_i$ and then $p_i = p'_i$, from which we deduce that k coordinates of p and p' are different, and they differ by one. They are then antagonist in a block of dimension k by Lemma 6. \square

Figures 5.6, 5.7, 5.8 depict examples of antagonists in blocks of \mathbb{Z}^3 such that the intersection of the closures of their isomorph is non-empty: the two cubes $\mathcal{H}_n(p)$ and $\mathcal{H}_n(p')$ share a 2-face when they correspond to 1-antagonists in \mathbb{Z}^n , a 1-face when they correspond to 2-antagonists in \mathbb{Z}^n , and a 0-face when they correspond to 2-antagonists in \mathbb{Z}^n . Then, the order of antagonism decreases when the dimension of the shared face increases.

5.7.4 Existence of a *critical point* z^*

Notations 7 (S, p, p', z^*). *Using Notations 6, we assume that X is not digitally well-composed, that is, there exists a block $S \in \mathcal{B}(\mathbb{Z}^n)$ of dimension $k \in \llbracket 2, n \rrbracket$, and two points p and p' which are antagonist in S s.t.*

$X \cap S = \{p, p'\}$ (primary case) or s.t. $S \setminus X = \{p, p'\}$ (secondary case). We will only treat the first case, since the reasoning is the same for the dual case. In this way, we will assume that :

$$\begin{cases} X \cap S = \{p, p'\}, \\ Y \cap S = S \setminus \{p, p'\}. \end{cases}$$

By Lemma 8, the fact that p, p' are k -antagonist implies that there exists an element $z^* \in \mathbb{H}^n$ s.t.:

$$z^* = \mathcal{H}_n(p) \wedge \mathcal{H}_n(p') \in \mathbb{H}_{n-k}^n.$$

We call z^* the critical point or critical face.

We will see after the reason for which we say that z^* is critical.

5.7.5 z^* belongs to \mathfrak{N}

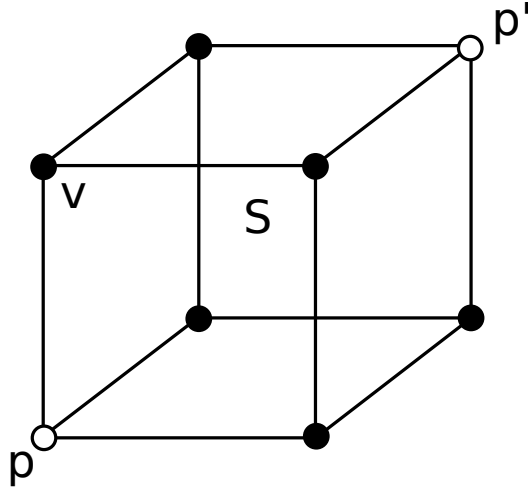

Figure 5.9: $\mathcal{H}_n(p) \wedge \mathcal{H}_n(p') \in \alpha(\mathcal{H}_n(p) \wedge \mathcal{H}_n(v))$.

Lemma 9. Let S be a block in \mathbb{Z}^n of dimension $k \geq 2$. Now, let p, p' be two antagonists in S , and v be a $2n$ -neighbor of p in S . Then, we have the following relation:

$$\mathcal{H}_n(p) \wedge \mathcal{H}_n(p') \in \alpha(\mathcal{H}_n(p) \wedge \mathcal{H}_n(v)). \quad (R)$$

Proof: We need first to prove that $\mathcal{H}_n(p) \wedge \mathcal{H}_n(p')$ and $\mathcal{H}_n(p) \wedge \mathcal{H}_n(v)$ are well-defined. By Lemma 8, since p and p' are antagonist in a block of dimension $k \geq 2$, $\mathcal{H}_n(p) \wedge \mathcal{H}_n(p')$ is well-defined (and belongs to \mathbb{H}_{n-k}^n), and since p and v are $2n$ -neighbours in \mathbb{Z}^n , they are 1-antagonist in the block $\{p, v\}$ of dimension 1, and then $\mathcal{H}_n(p) \wedge \mathcal{H}_n(v)$ is well-defined (and belongs to \mathbb{H}_{n-1}^n).

By Lemma 7, we can reformulate the first term in the relation (R):

$$\begin{aligned} \mathcal{H}_n(p) \wedge \mathcal{H}_n(p') &= \mathcal{H}_n(\otimes_{i \in \llbracket 1, n \rrbracket} p_i) \wedge \mathcal{H}_n(\otimes_{i \in \llbracket 1, n \rrbracket} p'_i), \\ &= \otimes_{i \in \llbracket 1, n \rrbracket} (\mathcal{H}(p_i)) \wedge \otimes_{i \in \llbracket 1, n \rrbracket} (\mathcal{H}(p'_i)), \\ &= \otimes_{i \in \llbracket 1, n \rrbracket} (\mathcal{H}(p_i) \wedge \mathcal{H}(p'_i)), \end{aligned}$$

and we can also reformulate the second term using Lemma 1:

$$\begin{aligned} \alpha(\mathcal{H}_n(p)) \cap \alpha(\mathcal{H}_n(v)) &= \alpha(\mathcal{H}_n(\otimes_{i \in \llbracket 1, n \rrbracket} p_i)) \cap \alpha(\mathcal{H}_n(\otimes_{i \in \llbracket 1, n \rrbracket} v_i)), \\ &= \alpha(\otimes_{i \in \llbracket 1, n \rrbracket} \mathcal{H}(p_i)) \cap \alpha(\otimes_{i \in \llbracket 1, n \rrbracket} \mathcal{H}(v_i)), \\ &= \otimes_{i \in \llbracket 1, n \rrbracket} \alpha(\mathcal{H}(p_i)) \cap \otimes_{i \in \llbracket 1, n \rrbracket} \alpha(\mathcal{H}(v_i)), \\ &= \otimes_{i \in \llbracket 1, n \rrbracket} (\alpha(\mathcal{H}(p_i)) \cap \alpha(\mathcal{H}(v_i))). \end{aligned}$$

Then we want to show that for all $i \in \llbracket 1, n \rrbracket$, $\mathcal{H}(p_i) \wedge \mathcal{H}(p'_i)$ belongs to $\alpha(\mathcal{H}(p_i)) \cap \alpha(\mathcal{H}(v_i))$.

Let \mathfrak{J} be the family of indices $\{i \in \llbracket 1, n \rrbracket ; p_i \neq p'_i\}$. Since v is a $2n$ -neighbor of p into \mathbb{Z}^n such that it belongs to S (see Figure 5.9), there exists an index i^* in \mathfrak{J} such that $v_{i^*} = p'_{i^*}$ and $\forall i \in \llbracket 1, n \rrbracket \setminus \{i^*\}, v_i = p_i$. Then we can study the different cases:

- if $i \in \llbracket 1, n \rrbracket \setminus \mathfrak{J}$, then $p_i = p'_i = v_i$ and then $\mathcal{H}(p_i) \wedge \mathcal{H}(p'_i) = \mathcal{H}(p_i) \in \alpha(\mathcal{H}(p_i)) = \alpha(\mathcal{H}(p_i)) \cap \alpha(\mathcal{H}(v_i))$.
- if $i \in \mathfrak{J}$, then two subcases are possible:
 - Either $i = i^*$ and then $v_i = p'_i$, which implies $\alpha(\mathcal{H}(p_i)) \cap \alpha(\mathcal{H}(v_i)) = \alpha(\mathcal{H}(p_i)) \cap \alpha(\mathcal{H}(p'_i)) = \alpha(\mathcal{H}(p_i) \wedge \mathcal{H}(p'_i)) \ni \mathcal{H}(p_i) \wedge \mathcal{H}(p'_i)$.

- Or $i \neq i^*$, and then $v_i = p_i$, which implies $\alpha(\mathcal{H}(p_i)) \cap \alpha(\mathcal{H}(v_i)) = \alpha(\mathcal{H}(p_i)) = \{\{p_i\}, \{p_i + 1\}, \{p_i, p_i + 1\}\}$. However, either $\mathcal{H}(p_i) \wedge \mathcal{H}(p'_i) = \{p_i\}$ (if $p'_i = p_i - 1$) or $\mathcal{H}(p_i) \wedge \mathcal{H}(p'_i) = \{p_i + 1\}$ (if $p'_i = p_i + 1$), then $\mathcal{H}(p_i) \wedge \mathcal{H}(p'_i) \in \alpha(\mathcal{H}(p_i)) \cap \alpha(\mathcal{H}(v_i))$.

Finally, for all $i \in \llbracket 1, n \rrbracket$, $\mathcal{H}(p_i) \wedge \mathcal{H}(p'_i)$ belongs to $\alpha(\mathcal{H}(p_i)) \cap \alpha(\mathcal{H}(v_i))$, and then (R) is true. \square

Property 8. *Using Notations 7, z^* belongs to \mathfrak{N} .*

Proof: We know that p and p' belong to X , and that they are antagonist in the block S such that $X \cap S = \{p, p'\}$. Then, any $2n$ -neighbor v of p in \mathbb{Z}^n such that it is contained in the block S of dimension $k \geq 2$ belongs to the complement of X in \mathbb{Z}^n , that is Y . Then, by definition of \mathfrak{N} :

$$\alpha(\mathcal{H}_n(p)) \cap \alpha(\mathcal{H}_n(v)) \subseteq \mathfrak{N}.$$

Also, since p and v are $2n$ -neighbours, they are 1-antagonist, and then by Lemma 8, $\mathcal{H}_n(p) \wedge \mathcal{H}_n(v)$ is well-defined and verifies by Lemma 7:

$$\alpha(\mathcal{H}_n(p) \wedge \mathcal{H}_n(v)) = \alpha(\mathcal{H}_n(p)) \cap \alpha(\mathcal{H}_n(v)).$$

We can also apply Lemma 9, and we obtain that:

$$\mathcal{H}_n(p) \wedge \mathcal{H}_n(p') \in \alpha(\mathcal{H}_n(p) \wedge \mathcal{H}_n(v)),$$

which allows to conclude that:

$$z^* = \mathcal{H}_n(p) \wedge \mathcal{H}_n(p') \in \alpha(\mathcal{H}_n(p) \wedge \mathcal{H}_n(v)) \subseteq \mathfrak{N}.$$

\square

5.7.6 Preamble to the calculus of $|\beta_{\mathfrak{N}}^{\square}(z^*)|$

Now that we know that we can write that $|\beta^{\square}(z^*) \cap \mathfrak{N}| = |\beta_{\mathfrak{N}}^{\square}(z^*)|$, we want to compute $|\beta_{\mathfrak{N}}^{\square}(z^*)|$, but let us introduce some lemmas to proceed.

Lemma 10. *Let a, b be two elements of \mathbb{Z}^n such that a and b are $(3^n - 1)$ -neighbors in \mathbb{Z}^n . Then, $\mathcal{H}_n((a + b)/2) = \mathcal{H}_n(a) \wedge \mathcal{H}_n(b)$.*

Proof: Since a and b are $(3^n - 1)$ -neighbors in \mathbb{Z}^n , they are k -antagonist for some $k \in \llbracket 0, n \rrbracket$, and then by Lemma 8, $\mathcal{H}_n(a) \wedge \mathcal{H}_n(b)$ is well-defined. Then, it is sufficient to prove that $(a + b)/2 = \mathcal{Z}_n(\mathcal{H}_n(a) \wedge \mathcal{H}_n(b))$. This is equivalent to say that for any $i \in \llbracket 1, n \rrbracket$, we have $(a_i + b_i)/2 = \mathcal{Z}(\mathcal{H}(a_i) \wedge \mathcal{H}(b_i))$ by Lemma 7. Since a and b are $(3^n - 1)$ -neighbors in \mathbb{Z}^n , they verify for any $i \in \llbracket 1, n \rrbracket$ that $a_i \in \{b_i - 1, b_i, b_i + 1\}$. Then, we just have to proceed case-by-case, starting from the equality $\mathcal{H}(a_i) \wedge \mathcal{H}(b_i) = \{a_i, a_i + 1\} \wedge \{b_i, b_i + 1\}$:

- when $a_i = b_i - 1$,

$$\mathcal{H}(a_i) \wedge \mathcal{H}(b_i) = \{b_i - 1, b_i\} \wedge \{b_i, b_i + 1\} = \{b_i\},$$

whose image by \mathcal{Z} is equal to $b_i - \frac{1}{2} = (a_i + b_i)/2$,

- when $b_i = a_i - 1$, we use a symmetrical reasoning leading to the same result,
- when $b_i = a_i$, the result is immediate.

This concludes the proof. \square

Lemma 11. For any element $h \in \mathbb{H}^n$, $\alpha^\square(h)$ is closed in \mathbb{H}^n .

Proof: It is simply due to the fact that $\alpha^\square(h) = \cup_{h' \in \alpha^\square(h)} \alpha(h')$ which is an union of closed sets, and then a closed set in \mathbb{H}^n . \square

Lemma 12. Let p be an element of \mathbb{Z}^n , then:

$$\alpha^\square(\mathcal{H}_n(p)) = \bigcup_{v \in \mathcal{N}_{3^n-1}^*(p)} \alpha(\mathcal{H}_n(p) \wedge \mathcal{H}_n(v)).$$

Proof: Let us proceed to some calculus:

$$\begin{aligned} \alpha^\square(\mathcal{H}_n(p)) &= \{f \in \mathbb{H}^n ; f \in \alpha^\square(\mathcal{H}_n(p))\}, \\ &= \{f \in \mathbb{H}^n ; \|\mathcal{Z}_n(f) - p\|_\infty = \frac{1}{2}\}, \\ &= \{f \in \mathbb{H}^n ; \|v^p - p\|_\infty = 1 ; v^p = 2\mathcal{Z}_n(f) - p\}, \\ &= \{f \in \mathbb{H}^n ; v^p \in \mathcal{N}_{3^n-1}^*(p) ; v^p = 2\mathcal{Z}_n(f) - p\}, \\ &= \{f \in \mathbb{H}^n ; v^p \in \mathcal{N}_{3^n-1}^*(p) ; \mathcal{Z}_n(f) = (v^p + p)/2\}, \\ &= \{f \in \mathbb{H}^n ; v^p \in \mathcal{N}_{3^n-1}^*(p) ; f = \mathcal{H}_n((v^p + p)/2)\}. \end{aligned}$$

Also, by Lemma 10:

$$\begin{aligned}\alpha^\square(\mathcal{H}_n(p)) &= \{f \in \mathbb{H}^n ; v^p \in \mathcal{N}_{3^n-1}^*(p) ; f = \mathcal{H}_n(v^p) \wedge \mathcal{H}_n(p)\}, \\ &= \{\mathcal{H}_n(v) \wedge \mathcal{H}_n(p) ; v \in \mathcal{N}_{3^n-1}^*(p)\},\end{aligned}$$

which leads to:

$$\alpha^\square(\mathcal{H}_n(p)) = \bigcup_{v \in \mathcal{N}_{3^n-1}^*(p)} \{\mathcal{H}_n(p) \wedge \mathcal{H}_n(v)\}.$$

Let us apply the operator α on each side of this relation, we obtain then by Lemma 11 the relation we are looking for. \square

Definition 58 (Center of a block). *Let $S \in \mathcal{B}(\mathbb{Z}^n)$ be a block, and let $z \in \mathbb{Z}^n$ and $\mathcal{F} \subset \mathbb{B}$ be the family of vectors such that $S = S(z, \mathcal{F})$. Then, we define:*

$$c = z + \sum_{f \in \mathcal{F}} \frac{f}{2},$$

as the center of the block S in $(\mathbb{Z}/2)^n$. We will also call abusively $\mathcal{H}_n(c)$ the center of the block S in \mathbb{H}^n .

Proposition 17 (Center and antagonists). *Let $S \in \mathcal{B}(\mathbb{Z}^n)$ be a block and let $p, p' \in S$ be two antagonists in S as a subset of \mathbb{Z}^n . Then the center of the block S in $(\mathbb{Z}/2)^n$ is equal to:*

$$\frac{p + p'}{2},$$

and the center of the same block S into \mathbb{H}^n is equal to:

$$\mathcal{H}_n(p) \wedge \mathcal{H}_n(p').$$

Proof: Starting from p, p' antagonist in S , we can compute $z \in \mathbb{Z}^n$ and $\mathcal{F} \subset \mathbb{B}$ such that $S = S(z, \mathcal{F})$. In fact, for all $i \in \llbracket 1, n \rrbracket$, $z_i = \min(p_i, p'_i)$, and $\mathcal{F} = \{e^i ; i \in \llbracket 1, n \rrbracket, p_i \neq p'_i\}$. Then, it is clear that:

$$\begin{aligned}p &= (p - z) + z = z + \sum_{e^i \in \mathcal{F}, p_i \neq z_i} e^i, \\ p' &= (p' - z) + z = z + \sum_{e^i \in \mathcal{F}, p'_i \neq z_i} e^i,\end{aligned}$$

and then:

$$p + p' = 2z + \sum_{f \in \mathcal{F}} f,$$

which shows that $\frac{p+p'}{2}$ is the center of S in $(\mathbb{Z}/2)^n$. To prove the second part of the proposition, we just have to use Lemma 10. This concludes the proof. \square

Proposition 18 (S(c)). *Let S be a block in \mathbb{Z}^n of dimension $k \in \llbracket 0, n \rrbracket$, and c be its center in $(\mathbb{Z}/2)^n$. Then we can reformulate S such that:*

$$S = \left\{ c + \sum_{i \in \frac{1}{2}(c)} \lambda_i e^i ; \forall i \in \frac{1}{2}(c), \lambda_i \in \left\{ -\frac{1}{2}, \frac{1}{2} \right\} \right\}.$$

Proof: Let us name $z \in \mathbb{Z}^n$ and $\mathcal{F} = \{f^1, \dots, f^k\} \subseteq \mathbb{B}$ respectively the point and the family of vectors associated to S such that $S = S(z, \mathcal{F})$. Let us recall that:

$$S = \left\{ z + \sum_{i \in \llbracket 1, k \rrbracket} \lambda_i f^i ; \forall i \in \llbracket 1, k \rrbracket, \lambda_i \in \{0, 1\} \right\},$$

and then, since $\frac{1}{2}(c)$ contains the indices of the vectors in \mathcal{F} (see Definition 58), it is clear that:

$$S = \left\{ z + \sum_{i \in \frac{1}{2}(c)} \lambda_i e^i ; \forall i \in \frac{1}{2}(c), \lambda_i \in \{0, 1\} \right\}.$$

Also, $c = z + \sum_{i \in \frac{1}{2}(c)} \frac{e^i}{2}$, and then:

$$S = \left\{ c + \sum_{i \in \frac{1}{2}(c)} (\lambda_i - \frac{1}{2}) e^i ; \forall i \in \frac{1}{2}(c), \lambda_i \in \{0, 1\} \right\}.$$

This concludes the proof. \square

The following lemma clearly expose the link between the relation in $(\mathbb{Z}/2)$ and the relation in \mathbb{H}^1 :

Lemma 13 (1D Switch Lemma). *Let c be a value in $(\mathbb{Z}/2) \setminus \mathbb{Z}$, and let y be a value in \mathbb{Z} . Then,*

$$y \in \{c - \frac{1}{2}, c + \frac{1}{2}\} \Leftrightarrow \beta(\mathcal{H}(y)) \subseteq \beta(\mathcal{H}(c)).$$

Proof: When c belongs to $(\mathbb{Z}/2) \setminus \mathbb{Z}$, $\mathcal{H}(c) = \{c + \frac{1}{2}\} \in \mathbb{H}_0^1$, and $\beta(\mathcal{H}(c)) = \{\{c - 1/2, c + 1/2\}, \{c + 1/2\}, \{c + 1/2, c + 3/2\}\}$. Also, when $y \in \mathbb{Z}$, $\mathcal{H}(y) = \{y, y + 1\} \in \mathbb{H}_1^1$, and $\beta(\mathcal{H}_n(y)) = \{\{y, y + 1\}\}$. If y belongs to $\{c - \frac{1}{2}, c + \frac{1}{2}\}$, we obtain effectively that $\beta(\mathcal{H}(y)) \subseteq \beta(\mathcal{H}(c))$. Conversely, if $\{\{y, y + 1\}\} \subseteq \{\{c - 1/2, c + 1/2\}, \{c + 1/2\}, \{c + 1/2, c + 3/2\}\}$, it means that $y \in \{c - 1/2, c + 1/2\}$. \square

Proposition 19 (Reformulation of a block). *Let S be a block in \mathbb{Z}^n , and c be its center in \mathbb{H}^n . Then we can reformulate S such that:*

$$S = \mathcal{Z}_n(\beta(c) \cap \mathbb{H}_n^n).$$

Proof: By Lemma 18:

$$S = \left\{ c + \sum_{i \in \frac{1}{2}(c)} \lambda_i e^i ; \forall i \in \frac{1}{2}(c), \lambda_i \in \left\{ -\frac{1}{2}, \frac{1}{2} \right\} \right\}.$$

Let us assume that y belongs to S , then, :

- when $i \in \llbracket 1, n \rrbracket \setminus \frac{1}{2}(c)$, $y_i = c_i$
- when $i \in \frac{1}{2}(c)$ such that $\lambda_i = 1/2$, $y_i = c_i + 1/2$ with $c_i \in (\mathbb{Z}/2) \setminus \mathbb{Z}$,
- and when $i \in \frac{1}{2}(c)$ such that $\lambda_i = -1/2$, $y_i = c_i - 1/2$ with $c_i \in (\mathbb{Z}/2) \setminus \mathbb{Z}$

Then, for any $i \in \llbracket 1, n \rrbracket$, by Lemma 13, $\mathcal{H}(y_i) \in \beta(\mathcal{H}(c_i))$, and then $\mathcal{H}_n(y) \in \beta(\mathcal{H}_n(c))$. Because $y \in \mathbb{Z}^n$, $\mathcal{H}_n(y) \in \mathbb{H}_n^n$, and then $\mathcal{H}_n(y) \in \beta(\mathcal{H}_n(c)) \cap \mathbb{H}_n^n$, which leads to $y \in \mathcal{Z}_n(\beta(\mathcal{H}_n(c)) \cap \mathbb{H}_n^n)$.

Now let us assume that $y \in \mathcal{Z}_n(\beta(\mathcal{H}_n(c)) \cap \mathbb{H}_n^n)$. It is clear that $\mathcal{H}_n(y) \in \beta(\mathcal{H}_n(c)) \cap \mathbb{H}_n^n$, which means that $y \in \mathbb{Z}^n$, and $\mathcal{H}_n(y) \in \beta(\mathcal{H}_n(c))$. In other words, for any $i \in \llbracket 1, n \rrbracket$, $\mathcal{H}(y_i) \in \beta(\mathcal{H}(c_i))$. Two cases are then possible:

- either $c_i \in \mathbb{Z}$ and $y_i = c_i$,
- or $c_i \in (\mathbb{Z}/2) \setminus \mathbb{Z}$, and by Lemma 13, $y_i \in \{c_i - \frac{1}{2}, c_i + \frac{1}{2}\}$,

and then we can affirm that $y \in S(c)$ by Lemma 18. \square

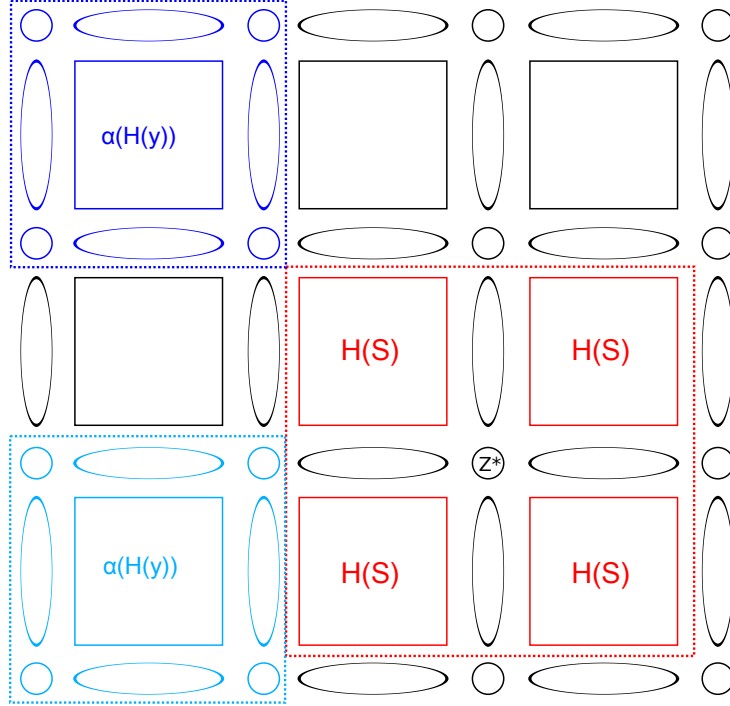

Figure 5.10: For any point $y \in \mathbb{Z}^n$ which is “exterior” to the block S centered at z^* , the closure of its isomorph does not intersect the smallest open set in the closure of the isomorph of this block.

Lemma 14. *Let S be a block of \mathbb{Z}^n , $p, p' \in S$ be two points such that $p' = \text{antag}_S(p)$ and $z^* \in \mathbb{H}^n$ be the center of S . For all $y \in \mathbb{Z}^n$:*

$$\{y \notin S \Rightarrow \alpha(\mathcal{H}_n(y)) \cap \beta(z^*) = \emptyset\}.$$

Proof: The existence and unicity of z^* is due to the fact that p and p' are antagonist in a block (see Lemma 8), and then $\alpha(\mathcal{H}_n(p)) \cap \alpha(\mathcal{H}_n(p')) \neq \emptyset$

by Lemma 7.

Assuming that for any $y \in \mathbb{Z}^n$, $\alpha(\mathcal{H}_n(y)) \cap \beta(z^*) \neq \emptyset$:

$$\otimes_{i \in \llbracket 1, n \rrbracket} (\alpha(\mathcal{H}(y_i)) \cap \beta(z_i^*)) \neq \emptyset,$$

and then by Lemma 1 and Lemma 2, for all $i \in \llbracket 1, n \rrbracket$:

$$\alpha(\mathcal{H}(y_i)) \cap \beta(z_i^*) \neq \emptyset \quad (R_i).$$

Now let us show that y belongs to S .

By (R_i) , it follows that there exists $p_i \in \alpha(\mathcal{H}(y_i)) \cap \beta(z_i^*)$, which implies by Theorem 2 that:

$$\begin{cases} \mathcal{H}(y_i) \in \beta(p_i), \\ p_i \in \beta(z_i^*), \end{cases},$$

which leads to $\mathcal{H}(y_i) \in \beta(z_i^*)$, and then $\mathcal{H}(y) \in \beta(z^*)$ by Lemma 2. Since $y \in \mathbb{Z}^n$, $\mathcal{H}_n(y) \in \mathbb{H}^n$, and then $\mathcal{H}(y) \in \beta(z^*) \cap \mathbb{H}_n^n$, which is equivalent to $y \in \mathcal{Z}_n(\beta(z^*) \cap \mathbb{H}_n^n)$, which is the alternative formulation of a block centered at z^* by Lemma 19. □

On Figure 5.10, the isomorphism in \mathbb{H}^n of a block $S(z^*)$ is depicted in red, and $\alpha(\mathcal{H}_n(y))$, where y is a point of \mathbb{Z}^n , is depicted in blue. We can observe that when $y \notin S(z^*)$, we obtain $\alpha(\mathcal{H}_n(y)) \cap \beta(z^*) = \emptyset$.

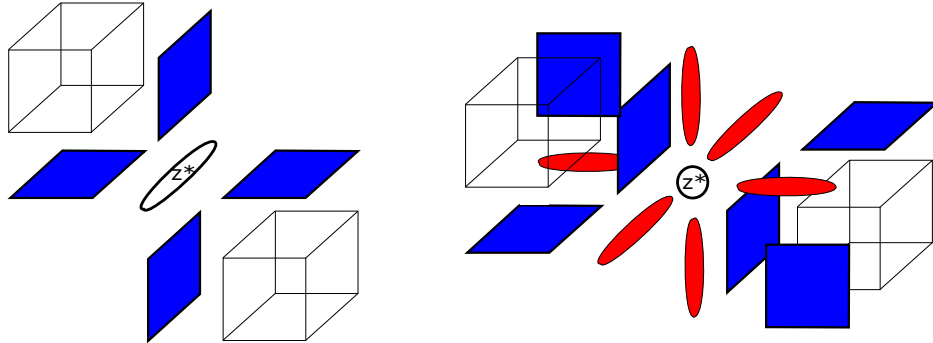

Figure 5.11: Example of $\beta_{\mathfrak{H}}^{\square}(z^*)$ in the 3D case. On the left, $z^* \in \mathbb{H}_1^3$ ($\beta_{\mathfrak{H}}^{\square}(z^*)$ is then the union of the blue faces), and on the right, $z^* \in \mathbb{H}_0^3$ ($\beta_{\mathfrak{H}}^{\square}(z^*)$ is then the union of the blue and red faces).

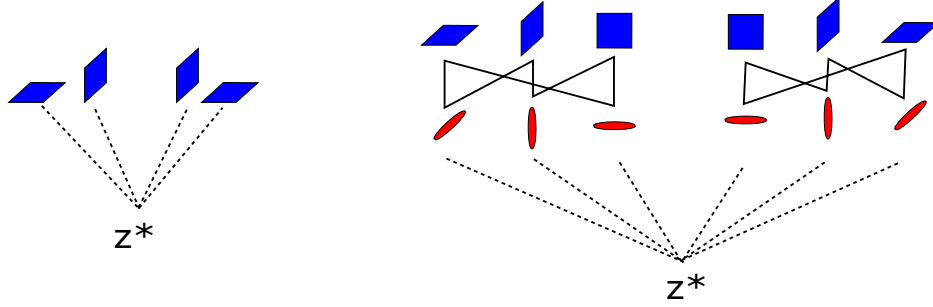

Figure 5.12: *Hasse diagrams* of $|\beta_{\mathfrak{H}}^{\square}(z^*)|$ of Figure 5.11. On the left, $z^* \in \mathbb{H}_1^3$ and $|\beta_{\mathfrak{H}}^{\square}(z^*)|$ is an union of two disjoint 0-surfaces. On the right, $z^* \in \mathbb{H}_0^3$ and $|\beta_{\mathfrak{H}}^{\square}(z^*)|$ is an union of two disjoint 1-surfaces.

5.7.7 Calculus of $|\beta_{\mathfrak{H}}^{\square}(z^*)|$

Property 9. *Using Notations 7:*

$$|\beta_{\mathfrak{H}}^{\square}(z^*)| = (\alpha^{\square}(\mathcal{H}_n(p)) \cup \alpha^{\square}(\mathcal{H}_n(p'))) \cap \beta^{\square}(z^*).$$

Proof: using Lemma 12 and Lemma 7:

$$\begin{aligned} \alpha^{\square}(\mathcal{H}_n(p)) \cap \beta^{\square}(z^*) &= \bigcup_{y \in \mathcal{N}_{3^n-1}^*(p)} \alpha(\mathcal{H}_n(p) \wedge \mathcal{H}_n(y)) \cap \beta^{\square}(z^*), \\ &= \bigcup_{y \in \mathcal{N}_{3^n-1}^*(p)} \alpha(\mathcal{H}_n(p)) \cap \alpha(\mathcal{H}_n(y)) \cap \beta^{\square}(z^*) \end{aligned}$$

However $y \notin S$ implies by Lemma 14 that $\alpha(\mathcal{H}_n(y)) \cap \beta^{\square}(z^*) = \emptyset$, and then under the union term, we write $y \in \mathcal{N}_{3^n-1}^*(p) \cap S$, which is also equivalent to $y \in S \setminus \{p\}$ since $S \subseteq \mathcal{N}_{3^n-1}(p)$:

$$\alpha^{\square}(\mathcal{H}_n(p)) \cap \beta^{\square}(z^*) = \bigcup_{y \in S \setminus \{p\}} \alpha(\mathcal{H}_n(p) \wedge \mathcal{H}_n(y)) \cap \beta^{\square}(z^*).$$

We can also observe that $\alpha(\mathcal{H}_n(p) \wedge \mathcal{H}_n(p')) \cap \beta^{\square}(z^*) = \alpha(z^*) \cap \beta^{\square}(z^*) = \emptyset$, and then:

$$\begin{aligned} \alpha^{\square}(\mathcal{H}_n(p)) \cap \beta^{\square}(z^*) &= \bigcup_{y \in S \setminus \{p, p'\}} \alpha(\mathcal{H}_n(p) \wedge \mathcal{H}_n(y)) \cap \beta^{\square}(z^*), \\ &= \alpha(\mathcal{H}_n(p)) \cap \alpha(\mathcal{H}_n(Y \cap S)) \cap \beta^{\square}(z^*). \end{aligned}$$

With the same calculus using p' instead of p , we obtain that:

$$\alpha^\square(\mathcal{H}_n(p')) \cap \beta^\square(z^*) = \alpha(\mathcal{H}_n(p')) \cap \alpha(\mathcal{H}_n(Y \cap S)) \cap \beta^\square(z^*),$$

and then:

$$(\alpha^\square(\mathcal{H}_n(p)) \cup \alpha^\square(\mathcal{H}_n(p'))) \cap \beta^\square(z^*) = \alpha(\mathcal{H}_n(X \cap S)) \cap \alpha(\mathcal{H}_n(Y \cap S)) \cap \beta^\square(z^*),$$

and remarking by Lemma 14 that:

$$\begin{aligned} \alpha(\mathcal{X}) \cap \alpha(\mathcal{Y}) \cap \beta^\square(z^*) &= \alpha(\mathcal{H}_n(X)) \cap \alpha(\mathcal{H}_n(Y)) \cap \beta^\square(z^*), \\ &= \alpha(\mathcal{H}_n(X)) \cap (\alpha(\mathcal{H}_n(Y)) \cap \beta^\square(z^*)), \\ &= \alpha(\mathcal{H}_n(X)) \cap (\alpha(\mathcal{H}_n(Y \cap S)) \cap \beta^\square(z^*)), \\ &= \alpha(\mathcal{H}_n(Y \cap S)) \cap (\alpha(\mathcal{H}_n(X)) \cap \beta^\square(z^*)), \\ &= \alpha(\mathcal{H}_n(Y \cap S)) \cap (\alpha(\mathcal{H}_n(X \cap S)) \cap \beta^\square(z^*)), \\ &= \alpha(\mathcal{H}_n(X \cap S)) \cap \alpha(\mathcal{H}_n(Y \cap S)) \cap \beta^\square(z^*), \end{aligned}$$

then $\beta_{\mathfrak{M}}^\square(z^*) = (\alpha^\square(\mathcal{H}_n(p)) \cup \alpha^\square(\mathcal{H}_n(p'))) \cap \beta^\square(z^*)$. \square

5.7.8 Some additional theoretical background about n -surfaces.

The following theorem is a direct consequence of the proof of Property 11 (pp. 55) extracted from the Ph. D. thesis of X. Daragon [11].

Theorem 9 (Inclusion of n -surfaces). *Let $|X| = (X, \alpha_X)$ and $|Y| = (Y, \alpha_Y)$ be two n -surfaces, $n \geq 0$. Then if $|X|$ is a suborder of $|Y|$, i.e., if $X \subseteq Y$ and $\alpha_X = \alpha_Y \cap X \times X$, then $|X| = |Y|$.*

Proof: Let us proceed by induction.

Initialization ($n = 0$): when $|X|$ and $|Y|$ are two 0-surfaces, the inclusion $X \subseteq Y$ implies directly that $X = Y$ since they have the same cardinality, and then $|X| = |Y|$.

Induction ($n \geq 1$): we assume that when two $(n-1)$ -surfaces verify an inclusion relationship, they are equal. Now, let $|X|$ and $|Y|$ be two n -surfaces, $n \geq 1$, such that $|X|$ is a suborder of $|Y|$. Then for all $x \in X$, $x \in Y$ and then we can write $\theta_X^\square(x) \subseteq \theta_Y^\square(x)$ since $X \subseteq Y$. However, $|\theta_X^\square(x)|$ and $|\theta_Y^\square(x)|$ are

$(n - 1)$ -surfaces s.t. $|\theta_X^\square(x)|$ is a suborder of $|\theta_Y^\square(x)|$, then $|\theta_X^\square(x)| = |\theta_Y^\square(x)|$.

Now let us assume that we have $X \subsetneq Y$. Then let x be a point of X and y a point of $Y \setminus X$. Since $|Y|$ is connected as a n -surface with $n \geq 1$, it is connected by path by Theorem 5, and then $x, y \in Y$ implies that there exists a path π joining them into Y . This way, there exists $x' \in X$ and $y' \in Y \setminus X$ s.t. $y' \in \theta^\square(x')$. In other words, $y' \in \theta_Y^\square(x') = \theta_X^\square(x')$ since $x' \in X$. This leads to $y' \in X$. We obtain a contradiction. Then we have $X = Y$, and this way, we have $|X| = |Y|$. □

Lemma 15 (Union of disjoint k -surfaces). *Let $|X_1| = (X_1, \alpha_{X_1})$ and $|X_2| = (X_2, \alpha_{X_2})$ be two non-empty disjoint k -surfaces ($k \geq 0$). Then the order $|X| = (X_1 \cup X_2, \alpha_X)$ such that $\alpha_{X_1} \cup \alpha_{X_2} \subseteq \alpha_X$, and such that $|X_1|$ or $|X_2|$ is a suborder of $|X|$ is not a k -surface. In other words, a disjoint union of two k -surfaces cannot be a k -surface for $k \geq 0$.*

Proof: Let $|X_1|$ and $|X_2|$ be two non-empty disjoint k -surfaces. If $|X_1|$ is a suborder of $|X|$, then by Theorem 9, $|X_1| = |X|$ since they are both k -surfaces, which leads to a contradiction because $X_1 \subsetneq X$ and then $|X_1| \neq |X|$. The same thing applies if $|X_2|$ is a suborder of $|X|$. □

5.7.9 $|\beta_{\mathfrak{H}^n}^\square(z^*)|$ is not a $(n - \dim(z^*) - 2)$ -surface.

Proposition 20. *Let a, b be two points of \mathbb{H}^n such that $a \in \beta^\square(b)$ ($\dim(a) \geq 1$). Then $|\alpha^\square(a) \cap \beta^\square(b)|$ is a $(\dim(a) - \dim(b) - 2)$ -surface.*

Proof: Since $|\mathbb{H}^n|$ is a n -surface by Theorem 6 (proven by Evako in [13]), by Property 6, $|\alpha^\square(a)|$ is a $(\rho(a, |\mathbb{H}^n|) - 1)$ -surface, and then a $(\dim(a) - 1)$ -surface.

Now, we can remark that because b belongs to $\alpha^\square(a)$:

$$\alpha^\square(a) \cap \beta^\square(b) = \beta_{\alpha^\square(a)}^\square(b),$$

and then, again by Property 6, $|\alpha^\square(a) \cap \beta^\square(b)|$ is a $((\dim(a) - 1) - \rho(b, |\alpha^\square(a)|) - 1)$ -surface.

Also, we can remark that $\rho(b, |\alpha^\square(a)|) = \rho(b, |\mathbb{H}^n|) = \dim(b)$, which concludes the proof. □

Property 10. *Using Notations 7, $|\beta_{\mathfrak{N}}^{\square}(z^*)|$ is a disjoint union of two $(n - 2 - \dim(z^*))$ -surfaces:*

$$\begin{cases} \alpha^{\square}(\mathcal{H}_n(p)) \cap \beta^{\square}(z^*), \\ \alpha^{\square}(\mathcal{H}_n(p')) \cap \beta^{\square}(z^*) \end{cases}$$

Proof: By Property 9:

$$\beta_{\mathfrak{N}}^{\square}(z^*) = (\alpha^{\square}(\mathcal{H}_n(p)) \cup \alpha^{\square}(\mathcal{H}_n(p'))) \cap \beta^{\square}(z^*),$$

which can be written as the union of $\alpha^{\square}(\mathcal{H}_n(p)) \cap \beta^{\square}(z^*)$ and $\alpha^{\square}(\mathcal{H}_n(p')) \cap \beta^{\square}(z^*)$ whose intersection is equal to:

$$\alpha^{\square}(\mathcal{H}_n(p)) \cap \alpha^{\square}(\mathcal{H}_n(p')) \cap \beta^{\square}(z^*) \subseteq \alpha(z^*) \cap \beta^{\square}(z^*) = \emptyset,$$

therefore these two terms are disjoint. Furthermore, p and p' belong to \mathbb{Z}^n , and then $\dim(\mathcal{H}_n(p)) = \dim(\mathcal{H}_n(p')) = n$, which means by Proposition 20 that $\alpha^{\square}(\mathcal{H}_n(p)) \cap \beta^{\square}(z^*)$ and $\alpha^{\square}(\mathcal{H}_n(p')) \cap \beta^{\square}(z^*)$ are $(n - \dim(z^*) - 2)$ -surfaces. \square

Property 11. *Using Notations 7, $|\beta_{\mathfrak{N}}^{\square}(z^*)|$ is not a $(n - 2 - \dim(z^*))$ -surface.*

Proof: It is the direct consequence of Lemma 15 applied to Property 10. \square

Examples of $|\beta_{\mathfrak{N}}^{\square}(z^*)|$ are depicted on Figure 5.11 and Figure 5.12).

5.7.10 Summary and conclusion for the converse sense.

We have finally proven the converse implication: if X is not DWC, it contains a (primary or secondary) critical configuration, then there exists a “critical point” $z^* \in \mathbb{H}^n$ such that $|\beta_{\mathfrak{N}}^{\square}(z^*)|$ is not a $(n - 2 - \dim(z^*))$ -surface, and then $\mathcal{I}\mathcal{M}\mathcal{M}(X)$ is not AWC.

5.8 Proof in the direct sense.

Using Notations 6, we want to prove that $\mathcal{I}\mathcal{M}\mathcal{M}(X)$ is AWC, or equivalently that $\forall z \in \mathfrak{N}$, $|\beta_{\mathfrak{N}}^{\square}(z)|$ is a $(n - 2 - \dim(z))$ -surface, when we assume that $X \subseteq \mathbb{Z}^n$ is digitally well-composed. To this aim, we will proceed by induction.

Notations 8. Using Notations 6, we define the following property for any $k \in \llbracket 1, n \rrbracket$:

$$(\mathcal{P}_k) = \{ \forall z \in \mathfrak{N} \cap \mathbb{H}_{n-k}^n, |\beta_{\mathfrak{N}}^{\square}(z)| \text{ is a } (n - 2 - \dim(z)) - \text{surface} \}.$$

Then, the obvious property follows:

Property 12. Using Notations 8, $\mathcal{I}MM(X)$ is AWC iff (\mathcal{P}_k) is verified for any $k \in \llbracket 1, n \rrbracket$.

Proof: We have to prove that $|\beta_{\mathfrak{N}}^{\square}(z)|$ is a $(n - \dim(z) - 2)$ -surface for any $z \in \mathfrak{N}$. Since $\mathfrak{N} \cap \mathbb{H}_n^n = \emptyset$, it is sufficient to prove the property (\mathcal{P}_k) for any $k \in \llbracket 1, n \rrbracket$. \square

Property 13. Using Notations 8, (\mathcal{P}_1) and (\mathcal{P}_2) are true.

Proof: When z belongs to $\mathbb{H}_{n-1}^n \cap \mathfrak{N}$, $|\beta_{\mathfrak{N}}^{\square}(z)| = |\emptyset|$ because $\beta^{\square}(z) \subseteq \mathbb{H}_n^n$ and $\mathfrak{N} \cap \mathbb{H}_n^n = \emptyset$, then $|\beta_{\mathfrak{N}}^{\square}(z)|$ is a (-1) -surface, and then (\mathcal{P}_1) is true.

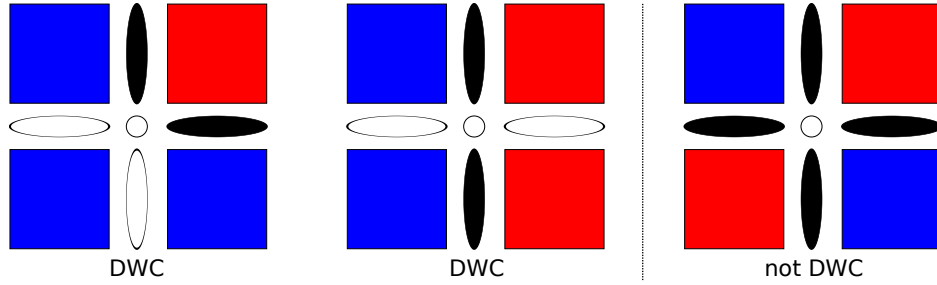

Figure 5.13: Assuming that X is DWC, $|\beta_{\mathfrak{N}}^{\square}(z)|$ is a 0-surface when $\dim(z) = n - 2$ ($k = 2$).

When z belongs to $\mathbb{H}_{n-2}^n \cap \mathfrak{N}$, we have only two possible configurations (modulo rotations, symmetry and complementation) as shown on Figure 5.13. $\mathcal{H}_n(X \cap S)$ is drawn in blue, $\mathcal{H}_n(Y \cap S)$ is drawn in red, $\beta_{\mathfrak{N}}^{\square}(z)$ is drawn in black, and z is the central point. The two DWC cases are on the left and in the middle while the non DWC case is on the right. Then we observe that in the two DWC cases, $\beta_{\mathfrak{N}}^{\square}(z)$ is the union of two elements of \mathbb{H}^n which are not neighbors the one of the other one, and then $|\beta_{\mathfrak{N}}^{\square}(z)|$ is a 0-surface. (\mathcal{P}_2) is then true. \square

Theorem 10. *Let X be a subset in \mathbb{Z}^2 which is digitally well-composed. Then $\mathcal{I}MM(X)$ is well-composed in the sense of Alexandrov.*

Proof: Since (\mathcal{P}_1) and (\mathcal{P}_2) are true, by Property 12, $\mathcal{I}MM(X)$ is AWC when X is DWC in the case $n = 2$. \square

Let use Notations 8, and let us assume that $n \geq 3$ is fixed, and that X is digitally well-composed. We want to prove that (\mathcal{P}_k) is true for any $k \in \llbracket 1, n \rrbracket$. We can proceed by induction on k : observing that (\mathcal{P}_1) and (\mathcal{P}_2) are true by Property 13, we can assume that for any $k \in \llbracket 3, n \rrbracket$, (\mathcal{P}_l) is true for any $l \in \llbracket 1, k - 1 \rrbracket$, and we want then to prove that (\mathcal{P}_k) is true. Since $k \geq 3$, any z belonging to \mathbb{H}_{n-k}^n verifies $\dim(z) \leq (n - 3)$, and then $(n - \dim(z) - 2) \geq 1$. This way, (\mathcal{P}_k) is equivalent to say that $\forall z \in \mathfrak{N} \cap \mathbb{H}_{n-k}^n$, $|\beta_{\mathfrak{N}}^{\square}(z)|$ is connected and that $\forall u \in \beta_{\mathfrak{N}}^{\square}(z)$, $|\theta_{\beta_{\mathfrak{N}}^{\square}(z)}^{\square}(u)|$ is a $(n - \dim(z) - 3)$ -surface. Then comes the following notation:

Notations 9. *Using Notations 8, we assume that $n \geq 3$, that X is digitally well-composed and that (\mathcal{P}_l) is true for any $l \in \llbracket 1, k - 1 \rrbracket$ (induction hypothesis). Then we define the following properties:*

$$\left\{ \begin{array}{l} \forall z \in \mathfrak{N} \cap \mathbb{H}_{n-k}^n, |\beta_{\mathfrak{N}}^{\square}(z)| \text{ is connected,} \\ \forall z \in \mathfrak{N} \cap \mathbb{H}_{n-k}^n, \forall u \in \beta_{\mathfrak{N}}^{\square}(z), |\theta_{\beta_{\mathfrak{N}}^{\square}(z)}^{\square}(u)| \text{ is a } (n - \dim(z) - 3)\text{-surface.} \end{array} \right. \quad \begin{array}{l} (\mathcal{P}'_k) \\ (\mathcal{P}^*_k) \end{array}$$

Proving (\mathcal{P}'_k) and (\mathcal{P}^*_k) for this value of k is then sufficient to prove that (\mathcal{P}_k) is true for any $k \in \llbracket 1, n \rrbracket$.

Property 14. *Using Notations 9, (\mathcal{P}^*_k) is true.*

Proof: Since \mathfrak{N} is a closed set, $\alpha(u) \subseteq \mathfrak{N}$ and then by Proposition 2:

$$\left| \theta_{\beta_{\mathfrak{N}}^{\square}(z)}^{\square}(u) \right| = \left| \beta_{\beta_{\mathfrak{N}}^{\square}(z)}^{\square}(u) \right| * \left| \alpha_{\beta_{\mathfrak{N}}^{\square}(z)}^{\square}(u) \right| = |\beta_{\mathfrak{N}}^{\square}(u)| * |\alpha^{\square}(u) \cap \beta^{\square}(z)|.$$

We can remark that $|\alpha^{\square}(u) \cap \beta^{\square}(z)|$ is a $(\dim(u) - \dim(z) - 2)$ -surface by Proposition 20 because u belongs to $\beta^{\square}(z)$. Also, we know that u belongs to $\mathbb{H}_{n-1}^n \cup \dots \cup \mathbb{H}_{n-k+1}^n$, and then by the induction hypothesis, $|\beta_{\mathfrak{N}}^{\square}(u)|$ is a $(n - 2 - \dim(u))$ -surface. The result is that (\mathcal{P}^*_k) is true by Theorem 7. \square

Lemma 16. *Using Notations 9:*

$$X \text{ is AWC} \Leftrightarrow (\mathcal{P}'_k).$$

Proof: By Property 14, it is clear that $\mathcal{I}\mathcal{M}\mathcal{M}(X)$ is AWC iff (\mathcal{P}'_k) is true. \square

In the sequel, we are going to reason *reducio ad absurdum*, by assuming that there exists a critical point $z \in \mathfrak{N}$ such that $\dim(z) \leq (n - 3)$ and such that $|\beta_{\mathfrak{N}}^{\square}(z)|$ is not connected:

Notations 10. *Using Notations 9, we assume that there exists $z \in \mathfrak{N}$ such that $\dim(z) \leq (n - 3)$ and:*

$$\{|\beta_{\mathfrak{N}}^{\square}(z)| \text{ is } \underline{\text{not}} \text{ connected}\}.$$

Then we can define the family of connected components of $|\beta_{\mathfrak{N}}^{\square}(z)|$:

$$\{F_i\}_{i \in \mathcal{I}} = \mathcal{CC}(|\beta_{\mathfrak{N}}^{\square}(z)|),$$

such that $\forall i, j \in \mathcal{I}, i \neq j$ implies $F_i \cap F_j = \emptyset$.

We are going to show that this family is supplied with several properties which finally lead to a contradiction.

5.8.1 First properties of $\{F_i\}_{i \in \mathcal{I}}$

Proposition 21. *Let (X, \mathcal{U}) be an Alexandrov space, and $F \subseteq X$ be a closed subset of X . Then the connected components of F are closed.*

Proof: Let F be closed in the Alexandrov space (X, \mathcal{U}) . Let assume that there exists a connected component $C \in \mathcal{CC}(F)$ such that it is not closed. Then $C \subsetneq \alpha(C)$, and then there exists $p^* \in \alpha(C) = \cup_{c \in C} \alpha(c)$ such that $p^* \notin C$. In other words, there exists $c^* \in C$ such that $p^* \in \alpha(c^*)$. Since F is closed and $c^* \in F$, $p^* \in \alpha(c^*) \subseteq F$, which means that $p^* \in F$. Also, C can be rewritten $C = \mathcal{CC}(F, c^*)$ and then contains p^* which is a neighbor of c^* and belongs to F . We obtain a contradiction since $p^* \notin C$. \square

Property 15. *Using Notations 10, F_i is closed into $\beta^{\square}(z)$ for any $i \in \mathcal{I}$.*

Proof: \mathfrak{N} is a closed set into \mathbb{H}^n as intersection of closed sets, and $\beta^\square(z)$ supplied with the induced topology is a subspace of \mathbb{H}^n . This way, $\beta_{\mathfrak{N}}^\square(z) = \mathfrak{N} \cap \beta^\square(z)$ is closed into $\beta^\square(z)$, and then by Proposition 21, each connected component of $|\beta_{\mathfrak{N}}^\square(z)|$ is closed into $\beta^\square(z)$. \square

Property 16. *Using Notations 10, for all i, j set in \mathcal{I} s.t. $i \neq j$:*

$$\beta(F_i) \cap F_j = \emptyset.$$

Proof: Let us assume that two components F_i and F_j , $i \neq j$, verify $\beta(F_i) \cap F_j \neq \emptyset$. Then there exists a point $x \in \beta(F_i) \cap F_j$ which proves that $F_i \cup F_j$ is pathwise connected. We obtain a contradiction since F_i and F_j are maximal components of $|\beta_{\mathfrak{N}}^\square(z)|$. \square

The following property is an immediate consequence of the separation property exposed above.

Property 17. *Using Notations 10, for all i, j chosen in \mathcal{I} s.t. $i \neq j$:*

$$\alpha(F_i) \cap F_j = \emptyset.$$

Proof: Let i, j be in \mathcal{I} s.t. $i \neq j$, then we know that $\beta(F_i) \cap F_j = \emptyset$ by Property 16. Let us assume now that $\alpha(F_i) \cap F_j \neq \emptyset$, then there exists $v \in \alpha(F_i) \cap F_j$, and then there exists too $f^i \in F_i$ s.t. $v \in \alpha(f^i)$. However $v \in \alpha(f^i)$ implies that $f^i \in \beta(v)$, and then $f^i \in \beta(F_j)$. $f^i \in \beta(F_j) \cap F_i$ implies then that this intersection is non-empty and then it leads to a contradiction.

Property 18. *Using Notations 10, then for each $u \in \beta_{\mathfrak{N}}^\square(z)$, there exists one unique index $i^* \in \mathcal{I}$ such that $u \in F_{i^*}$ and it verifies that:*

$$\left\{ \begin{array}{l} \alpha_{F_{i^*}}^\square(u) = \alpha_{\beta_{\mathfrak{N}}^\square(z)}^\square(u) \quad (1), \\ \beta_{F_{i^*}}^\square(u) = \beta_{\beta_{\mathfrak{N}}^\square(z)}^\square(u) \quad (2), \\ \theta_{F_{i^*}}^\square(u) = \theta_{\beta_{\mathfrak{N}}^\square(z)}^\square(u) \quad (3). \end{array} \right.$$

Let us prove the first assertion. Let u be an element of $\beta_{\mathfrak{M}}^{\square}(z)$, then:

$$\alpha_{\beta_{\mathfrak{M}}^{\square}(z)}^{\square}(u) = \alpha^{\square}(u) \cap \beta_{\mathfrak{M}}^{\square}(z) = \alpha^{\square}(u) \cap \bigcup_{i \in \mathcal{I}} F_i = \bigcup_{i \in \mathcal{I}} (\alpha^{\square}(u) \cap F_i).$$

Now let i^* be such that $u \in F_{i^*}$, then we obtain $\alpha^{\square}(u) \cap F_{i^*} = \alpha_{F_{i^*}}^{\square}(u)$. Conversely, if $i \in \mathcal{I}$ s.t. $i \neq i^*$, $\alpha^{\square}(u) \cap F_i = \emptyset$ (because $\alpha(F_{i^*}) \cap F_i = \emptyset$ by Property 17). Then we obtain: $\alpha_{\beta_{\mathfrak{M}}^{\square}(z)}^{\square}(u) = \alpha_{F_{i^*}}^{\square}(u)$.

The second assertion follows the same reasoning but uses Property 16 instead of Property 17.

The third assertion is a direct consequence of the two assertions we have just proven. \square

Property 19. *Using Notations 10, then for all $i \in \mathcal{I}$, $|F_i|$ is a $(n - \dim(z) - 2)$ -surface.*

Proof: Let i be in \mathcal{I} , F_i is connected by definition. Moreover, let u be an element of F_i , then:

$$|\theta_{F_i}^{\square}(u)| = |\theta_{\beta_{\mathfrak{M}}^{\square}(z)}^{\square}(u)|,$$

by Property 18, which means that $|\theta_{F_i}^{\square}(u)|$ is a $(n - \dim(z) - 3)$ -surface since (\mathcal{P}_k^*) is true by Property 14. Then F_i is a $(n - \dim(z) - 2)$ -surface. \square

5.8.2 $\mathbb{1}(x)$ and $\frac{1}{2}(x)$

Notations 11 (Integral and half coordinates). *From now on, for each point $x \in (\mathbb{Z}/2)^n$, we will write:*

$$\mathbb{1}(x) = \{i \in \llbracket 1, n \rrbracket ; x_i \in \mathbb{Z}\}.$$

Obviously,

$$\mathbb{1}(x) = \llbracket 1, n \rrbracket \setminus \frac{1}{2}(x),$$

and $\text{Card}(\mathbb{1}(x)) = \dim(\mathcal{H}_n(x))$.

Proposition 22. *Let p, c be two elements in \mathbb{H}^n . We have the following equivalence:*

$$\{p \in \beta(c)\} \Leftrightarrow \begin{cases} \forall i \in \mathbb{1}(\mathcal{Z}_n(p)) \cap \frac{1}{2}(\mathcal{Z}_n(c)), \mathcal{Z}(p_i) \in \{\mathcal{Z}(c_i) - \frac{1}{2}, \mathcal{Z}(c_i) + \frac{1}{2}\}, \\ \forall i \in \mathbb{1}(\mathcal{Z}_n(p)) \cap \mathbb{1}(\mathcal{Z}_n(c)), \mathcal{Z}(p_i) = \mathcal{Z}(c_i), \\ \forall i \in \frac{1}{2}(\mathcal{Z}_n(p)) \cap \mathbb{1}(\mathcal{Z}_n(c)), \mathcal{Z}(p_i) = \mathcal{Z}(c_i), \\ \frac{1}{2}(\mathcal{Z}_n(p)) \cap \mathbb{1}(\mathcal{Z}_n(c)) = \emptyset. \end{cases}$$

Proof: Let us prove first that $p \in \beta(c)$ implies this set of four properties. The relation $p \in \beta(p)$ is equivalent by Lemma 2 to say that for any $i \in \llbracket 1, n \rrbracket$, $p_i \in \beta(c_i)$. Each term p_i belongs to \mathbb{H}_1^1 or to \mathbb{H}_0^1 , and so does c_i , which leads to four cases. Then, assuming that for $i \in \llbracket 1, n \rrbracket$, we have $p_i \in \beta(c_i)$, we obtain that:

- either $p_i \in \mathbb{H}_1^1$ and $c_i \in \mathbb{H}_0^1$, then $p_i \in \beta(c_i)$ implies:

$$\mathcal{Z}(p_i) \in \left\{ \mathcal{Z}(c_i) - \frac{1}{2}, \mathcal{Z}(c_i) + \frac{1}{2} \right\},$$

- or $p_i \in \mathbb{H}_1^1$ and $c_i \in \mathbb{H}_1^1$, then $p_i \in \beta(c_i)$ implies $\mathcal{Z}(p_i) = \mathcal{Z}(c_i)$,
- or $p_i \in \mathbb{H}_0^1$ and $c_i \in \mathbb{H}_0^1$, then $p_i \in \beta(c_i)$ implies $\mathcal{Z}(p_i) = \mathcal{Z}(c_i)$,
- or $p_i \in \mathbb{H}_0^1$ and $c_i \in \mathbb{H}_1^1$, then $p_i \in \beta(c_i)$ leads to a contradiction.

In other words,

- either $i \in \mathbb{1}(\mathcal{Z}_n(p)) \cap \frac{1}{2}(\mathcal{Z}_n(c))$, and $\mathcal{Z}(p_i) \in \{\mathcal{Z}(c_i) - \frac{1}{2}, \mathcal{Z}(c_i) + \frac{1}{2}\}$,
- or $i \in \mathbb{1}(\mathcal{Z}_n(p)) \cap \mathbb{1}(\mathcal{Z}_n(c))$, and $\mathcal{Z}(p_i) = \mathcal{Z}(c_i)$,
- or $i \in \frac{1}{2}(\mathcal{Z}_n(p)) \cap \frac{1}{2}(\mathcal{Z}_n(c))$, and $\mathcal{Z}(p_i) = \mathcal{Z}(c_i)$,
- and $\frac{1}{2}(\mathcal{Z}_n(p)) \cap \mathbb{1}(\mathcal{Z}_n(c)) = \emptyset$,

which concludes the direct implication.

Conversely, if we have these four properties, $\frac{1}{2}(p) \cap \mathbb{1}(c) = \emptyset$ shows that:

$$(\mathbb{1}(p) \cap \frac{1}{2}(c)) \cup (\mathbb{1}(p) \cap \mathbb{1}(c)) \cup (\frac{1}{2}(p) \cap \frac{1}{2}(c)) = \llbracket 1, n \rrbracket,$$

and since in these three cases, we obtain that $p_i \in \beta(c_i)$, it is clear by Lemma 2 that $p \in \beta(c)$. \square

5.8.3 Covering and opposites

Definition 59 (Covering relation). *Let a, b be two elements of \mathbb{H}^n . We say that a covers b , iff $a \in \beta^\square(b)$ and there exists no element c of \mathbb{H}^n such that $a > c > b$. We denote it $a \succ b$. Also, in the case of the cubical complexes, $A \succ b$ iff $a \in \beta(b)$ and $\dim(a) = \dim(b) + 1$.*

Proposition 23. *Let p, c be two elements of \mathbb{H}^n . Then, $p \succ c$ iff there exists $m \in \llbracket 1, n \rrbracket$ such that:*

$$\mathbb{1}(\mathcal{Z}_n(p)) \cap \frac{1}{2}(\mathcal{Z}_n(c)) = \{m\} \quad \text{and} \quad \mathcal{Z}_n(p) \in \left\{ \mathcal{Z}_n(c) - \frac{1}{2}e^m, \mathcal{Z}_n(c) + \frac{1}{2}e^m \right\}.$$

Proof: We can reformulate the fact that $p \succ c$ in the following manner:

$$\begin{cases} \forall i \in \mathbb{1}(\mathcal{Z}_n(p)) \cap \frac{1}{2}(\mathcal{Z}_n(c)), \mathcal{Z}(p_i) \in \left\{ \mathcal{Z}(c_i) - \frac{1}{2}, \mathcal{Z}(c_i) + \frac{1}{2} \right\}, & (1) \\ \forall i \in \mathbb{1}(\mathcal{Z}_n(p)) \cap \mathbb{1}(\mathcal{Z}_n(c)), \mathcal{Z}(p_i) = \mathcal{Z}(c_i), & (2) \\ \forall i \in \frac{1}{2}(\mathcal{Z}_n(p)) \cap \frac{1}{2}(\mathcal{Z}_n(c)), \mathcal{Z}(p_i) = \mathcal{Z}(c_i), & (3) \\ \frac{1}{2}(\mathcal{Z}_n(p)) \cap \mathbb{1}(\mathcal{Z}_n(c)) = \emptyset, & (4) \\ \dim(p) = \dim(c) + 1. & (5) \end{cases}$$

By (4), $\mathbb{1}(\mathcal{Z}_n(c)) \subseteq \mathbb{1}(\mathcal{Z}_n(p))$, and then (2) can be reformulated:

$$\forall i \in \mathbb{1}(\mathcal{Z}_n(c)), \mathcal{Z}(p_i) = \mathcal{Z}(c_i),$$

which implies that at least the $\dim(c)$ integral coordinates of $\mathcal{Z}_n(c)$ are integral for $\mathcal{Z}_n(p)$. Since $\dim(p) = \dim(c) + 1$ by (5), p admits one more integral coordinate than c and it lies into $\mathbb{1}(\mathcal{Z}_n(p)) \setminus \mathbb{1}(\mathcal{Z}_n(c)) = \mathbb{1}(\mathcal{Z}_n(p)) \cap \frac{1}{2}(\mathcal{Z}_n(c))$, which means that:

$$\text{Card}(\mathbb{1}(\mathcal{Z}_n(p)) \cap \frac{1}{2}(\mathcal{Z}_n(c))) = 1,$$

and then there exists one index of coordinate $m \in \llbracket 1, n \rrbracket$ such that $\mathbb{1}(\mathcal{Z}_n(p)) \cap \frac{1}{2}(\mathcal{Z}_n(c)) = \{m\}$. By (1) to (4), we obtain then that on each coordinate $i \in \llbracket 1, n \rrbracket$, $\mathcal{Z}(p_i) = \mathcal{Z}(c_i)$ except for the case $i = m$ where:

$$\mathcal{Z}(p_i) \in \left\{ \mathcal{Z}(c_i) - \frac{1}{2}, \mathcal{Z}(c_i) + \frac{1}{2} \right\},$$

which concludes the direct sense.

Conversely, if there exists $m \in \llbracket 1, n \rrbracket$ such that $\mathbb{1}(\mathcal{Z}_n(p)) \cap \frac{1}{2}(\mathcal{Z}_n(c)) = \{m\}$ and $\mathcal{Z}_n(p) \in \left\{ \mathcal{Z}_n(c) - \frac{1}{2}e^m, \mathcal{Z}_n(c) + \frac{1}{2}e^m \right\}$, it is clear that (1) is verified by hypothesis. Also, for each $i \in \llbracket 1, n \rrbracket \setminus \{m\}$, we have $\mathcal{Z}(p_i) = \mathcal{Z}(c_i)$, which implies (2) and (3). Now let us assume that (4) is false, it means that there exists some $i \in \frac{1}{2}(\mathcal{Z}_n(p)) \cap \mathbb{1}(\mathcal{Z}_n(c))$ such that $\mathcal{Z}(c_i)$ is in half and such that $\mathcal{Z}(p_i)$ is integral. Then we obtain that $|\mathcal{Z}(c_i) - \mathcal{Z}(p_i)| = \frac{1}{2}$, which means that $i = m$ ($\mathcal{Z}_n(c)$ and $\mathcal{Z}_n(p)$ are different only on the m^{th} coordinate). However, i belongs to $\frac{1}{2}(\mathcal{Z}_n(p)) \cap \mathbb{1}(\mathcal{Z}_n(c))$ and m belongs to $\mathbb{1}(\mathcal{Z}_n(p)) \cap \frac{1}{2}(\mathcal{Z}_n(c))$. We obtain a contradiction:

$$\{i\} \in \mathbb{1}(\mathcal{Z}_n(p)) \cap \frac{1}{2}(\mathcal{Z}_n(c)) \cap \frac{1}{2}(\mathcal{Z}_n(p)) \cap \mathbb{1}(\mathcal{Z}_n(c)) = \emptyset,$$

then (4) is true. (5) is true because p has one more integral coordinate than c by hypothesis. \square

Definition 60 (Opposites [19]). *Let a, b, c be three elements of \mathbb{H}^n . We say that a and b are opposite relatively to c and we denote it $a = \text{opp}_c(b)$ iff $a \succ c, b \succ c$ and $\beta(a) \cap \beta(b) = \emptyset$.*

On Figure 5.14, some examples of opposite faces are depicted: we have $a = \text{opp}_c(b)$ with a in red, b in blue, and c in pink. As we can see, geometrical properties of symmetry follow on from the opposite relation between two faces.

Lemma 17. *Let a, b, c three elements of \mathbb{H}^n such that $a = \text{opp}_c(b)$, then there exists $m \in \llbracket 1, n \rrbracket$ such that:*

- either $\mathcal{Z}_n(a) = \mathcal{Z}_n(c) - \frac{1}{2}e^m$ and $\mathcal{Z}_n(b) = \mathcal{Z}_n(c) + \frac{1}{2}e^m$,
- or $\mathcal{Z}_n(a) = \mathcal{Z}_n(c) + \frac{1}{2}e^m$ and $\mathcal{Z}_n(b) = \mathcal{Z}_n(c) - \frac{1}{2}e^m$,

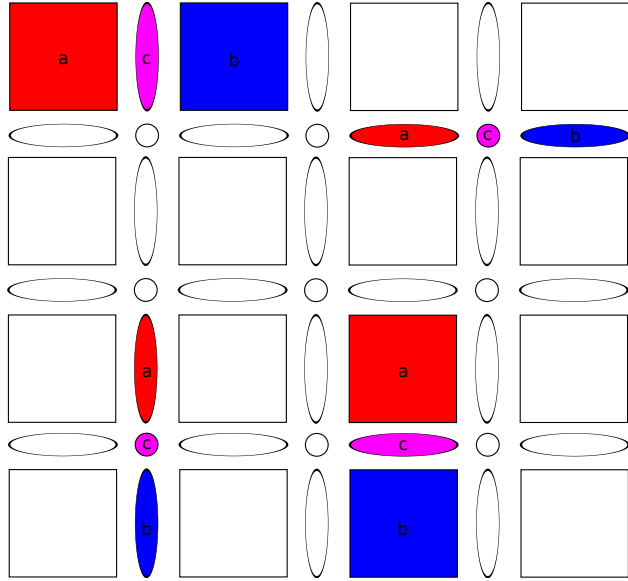

Figure 5.14: Examples of opposites in \mathbb{H}^2 .

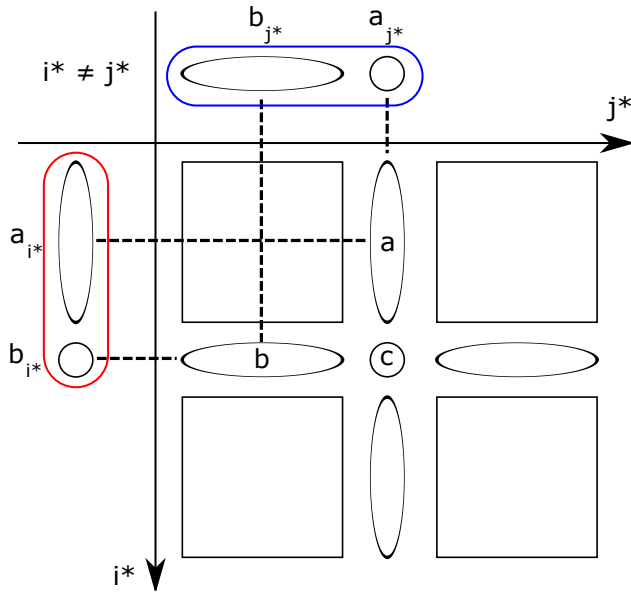

Figure 5.15: a and b covering c : when the index i^* defined such that $a_{i^*} \neq c_{i^*}$ and the index j^* defined such that $b_{j^*} \neq c_{j^*}$ are different, we obtain that $\beta(a) \cap \beta(b) \neq \emptyset$. *A fortiori*, if a and b are opposite, $i^* = j^*$.

which leads in both cases to:

$$\frac{\mathcal{Z}_n(a) + \mathcal{Z}_n(b)}{2} = \mathcal{Z}_n(c).$$

Furthermore,

$$\begin{cases} \mathbb{1}(\mathcal{Z}_n(a)) = \mathbb{1}(\mathcal{Z}_n(c)) \sqcup \{m\} = \mathbb{1}(\mathcal{Z}_n(b)), \\ \frac{1}{2}(\mathcal{Z}_n(a)) \sqcup \{m\} = \frac{1}{2}(\mathcal{Z}_n(c)) = \frac{1}{2}(\mathcal{Z}_n(b)) \sqcup \{m\}. \end{cases}$$

Proof: By Proposition 23, there exist $i^*, j^* \in \llbracket 1, n \rrbracket$ such that:

$$\begin{cases} \mathbb{1}(\mathcal{Z}_n(a)) \cap \frac{1}{2}(\mathcal{Z}_n(c)) = \{i^*\}, \\ \mathcal{Z}_n(a) \in \{\mathcal{Z}_n(c) - \frac{1}{2}e^{i^*}, \mathcal{Z}_n(c) + \frac{1}{2}e^{i^*}\}, \\ \mathbb{1}(\mathcal{Z}_n(b)) \cap \frac{1}{2}(\mathcal{Z}_n(c)) = \{j^*\}, \\ \mathcal{Z}_n(b) \in \{\mathcal{Z}_n(c) - \frac{1}{2}e^{j^*}, \mathcal{Z}_n(c) + \frac{1}{2}e^{j^*}\}. \end{cases}$$

Also, since a and b cover c , we have that $a \in \beta(c)$ and $b \in \beta(c)$. Applying β on these expressions, we obtain that $\beta(a) \subseteq \beta(c)$ and that $\beta(b) \subseteq \beta(c)$ (by transitivity of β). Then, by Lemma 2 combined to the fact that for each $i \in \llbracket 1, n \rrbracket$, we have $a_i = c_i$ iff $i \neq i^*$, and $b_j = c_j$ iff $j \neq j^*$, we have:

$$\begin{cases} \beta(a_{i^*}) \subset \beta(c_{i^*}), \\ \forall i \in \llbracket 1, n \rrbracket \setminus \{i^*\}, \beta(a_i) = \beta(c_i), \\ \beta(b_{j^*}) \subset \beta(c_{j^*}), \\ \forall i \in \llbracket 1, n \rrbracket \setminus \{j^*\}, \beta(b_i) = \beta(c_i), \end{cases}$$

If $i^* \neq j^*$ (see Figure 5.15), then when $m = i^*$, we have $\beta(a_m) \subset \beta(c_m) = \beta(b_m)$, when $m = j^*$, we have $\beta(b_m) \subset \beta(c_m) = \beta(a_m)$, and when $m \in \llbracket 1, n \rrbracket \setminus \{i^*, j^*\}$, we have $\beta(a_m) = \beta(c_m) = \beta(b_m)$. We obtain by Lemma 2 that $\beta(a) \cap \beta(b) = \otimes_{i \in \llbracket 1, n \rrbracket} (\beta(a_i) \cap \beta(b_i)) \neq \emptyset$, which contradicts the hypotheses that a and b are opposites, and then $i^* = j^*$.

Because $\mathcal{Z}_n(a), \mathcal{Z}_n(b) \in \{\mathcal{Z}_n(c) - \frac{1}{2}e^{i^*}, \mathcal{Z}_n(c) + \frac{1}{2}e^{i^*}\}$ and because they are distinct, we obtain that:

- either $\mathcal{Z}_n(a) = \mathcal{Z}_n(c) - \frac{1}{2}e^{i^*}$ and $\mathcal{Z}_n(b) = \mathcal{Z}_n(c) + \frac{1}{2}e^{i^*}$,
- or $\mathcal{Z}_n(a) = \mathcal{Z}_n(c) + \frac{1}{2}e^{i^*}$ and $\mathcal{Z}_n(b) = \mathcal{Z}_n(c) - \frac{1}{2}e^{i^*}$,

which leads obviously to:

$$\frac{\mathcal{Z}_n(a) + \mathcal{Z}_n(b)}{2} = \mathcal{Z}_n(c).$$

When $m \in \llbracket 1, n \rrbracket \setminus \{i^*\}$, we have then $\dim(a_m) = \dim(c_m) = \dim(b_m)$, and when $m = i^*$, we have $\dim(a_m) = \dim(c_m) + 1 = \dim(b_m)$. We can then conclude that:

$$\begin{cases} \mathbb{1}(\mathcal{Z}_n(a)) = \mathbb{1}(\mathcal{Z}_n(c)) \sqcup \{i^*\} = \mathbb{1}(\mathcal{Z}_n(b)), \\ \frac{1}{2}(\mathcal{Z}_n(a)) \sqcup \{i^*\} = \frac{1}{2}(\mathcal{Z}_n(c)) = \frac{1}{2}(\mathcal{Z}_n(b)) \sqcup \{i^*\}. \end{cases}$$

□

5.8.4 A very particular $(n - \dim(z) - 2)$ -surface

Notations 12 (Subspaces of \mathbb{H}^n). *Let h be an element \mathbb{H}^n , and let \mathcal{I} be a family of indices into $\llbracket 1, n \rrbracket$, and let \mathfrak{C} a collection of coefficients in $(\mathbb{Z}/2)$. Then we define the following set:*

$$\mathbb{H}_{\{h, \mathcal{I}, \mathfrak{C}\}}^n = \mathcal{H}_n \left\{ \mathcal{Z}_n(h) + \sum_{i \in \mathcal{I}} \lambda_i e^i ; \forall i \in \mathcal{I}, \lambda_i \in \mathfrak{C} \right\}.$$

It is then obvious that for any element $h \in \mathbb{H}^n$, we have the following relations:

Proposition 24. *For any element $h \in \mathbb{H}^n$,*

$$\begin{cases} \mathbb{H}_{\{h, \frac{1}{2}(\mathcal{Z}_n(h)), \{-\frac{1}{2}, 0, \frac{1}{2}\}\}}^n = \beta(h), \\ \mathbb{H}_{\{h, \mathbb{1}(\mathcal{Z}_n(h)), \{-\frac{1}{2}, 0, \frac{1}{2}\}\}}^n = \alpha(h), \\ \mathbb{H}_{\{h, \llbracket 1, n \rrbracket, (\mathbb{Z}/2)\}}^n = \mathbb{H}^n. \end{cases}$$

Proposition 25. *Let t, t', z three elements in \mathbb{H}^n such that t and t' are opposite relatively to z . Now let define $\mathcal{E} \stackrel{\text{def}}{=} \beta(z) \setminus (\beta(t) \cup \beta(t'))$, and let m^* be the only coordinate in $\llbracket 1, n \rrbracket$ such that $m^* \in \mathbb{1}(\mathcal{Z}_n(t)) \setminus \mathbb{1}(\mathcal{Z}_n(z))$. Then, the application $\mathfrak{Iso} : \mathcal{E} \rightarrow \mathbb{H}^n$ such that:*

$$\forall u \in \mathcal{E}, \mathfrak{Iso}(u) = \mathcal{H}_n \left(\mathcal{Z}_n(u) + (\mathcal{Z}(t_{m^*}) - \mathcal{Z}(z_{m^*})) e^{m^*} \right).$$

is an isomorphism (in the order sense) from \mathcal{E} to $\beta(t)$.

Proof: Let t, t', z be three elements of \mathbb{H}^n such that $t' = \text{opp}_z(t)$, then we obtain that there exists some value $m \in \llbracket 1, n \rrbracket$ such that $\frac{1}{2}(\mathcal{Z}_n(z)) \cap \mathbb{1}(\mathcal{Z}_n(t)) = \{m\}$, $\mathcal{Z}_n(t) = \mathcal{Z}_n(z) + \frac{1}{2}e^m$, and $\mathcal{Z}_n(t') = \mathcal{Z}_n(z) - \frac{1}{2}e^m$ (or the converse case $\mathcal{Z}_n(t) = \mathcal{Z}_n(z) - \frac{1}{2}e^m$, and $\mathcal{Z}_n(t') = \mathcal{Z}_n(z) + \frac{1}{2}e^m$ but by symmetry, we call neglect this case).

Also, we know that $\beta(t) = \mathbb{H}^n_{\{t, \frac{1}{2}(\mathcal{Z}_n(t)), \{-\frac{1}{2}, 0, \frac{1}{2}\}\}}$, $\beta(t') = \mathbb{H}^n_{\{t', \frac{1}{2}(\mathcal{Z}_n(t')), \{-\frac{1}{2}, 0, \frac{1}{2}\}\}}$. Since \mathcal{E} is equal to $\beta(z) \setminus (\beta(t) \cup \beta(t'))$, we can reformulate it using formulation defined in Notation 12. Effectively,

$$\begin{aligned} \beta(z) &= \mathbb{H}^n_{\{z, \frac{1}{2}(\mathcal{Z}_n(z)), \{-\frac{1}{2}, 0, \frac{1}{2}\}\}}, \\ &= \mathcal{H}_n \left\{ z + \sum_{i \in \frac{1}{2}(\mathcal{Z}_n(z))} \lambda_i e^i ; \lambda_i \in \left\{ -\frac{1}{2}, 0, \frac{1}{2} \right\} \right\}, \\ &= \mathcal{H}_n \left\{ z + \sum_{i \in \frac{1}{2}(\mathcal{Z}_n(t) \sqcup \{m\})} \lambda_i e^i ; \lambda_i \in \left\{ -\frac{1}{2}, 0, \frac{1}{2} \right\} \right\}, \\ &= \mathcal{H}_n \left\{ z + \lambda_m e^m + \sum_{i \in \frac{1}{2}(\mathcal{Z}_n(t))} \lambda_i e^i ; \lambda_m \in \left\{ -\frac{1}{2}, 0, \frac{1}{2} \right\}, \lambda_i \in \left\{ -\frac{1}{2}, 0, \frac{1}{2} \right\} \right\}, \\ &= \mathcal{H}_n \left\{ t + \sum_{i \in \frac{1}{2}(\mathcal{Z}_n(t))} \lambda_i e^i ; \lambda_i \in \left\{ -\frac{1}{2}, 0, \frac{1}{2} \right\} \right\}, \\ &\quad + \mathcal{H}_n \left\{ z + \sum_{i \in \frac{1}{2}(\mathcal{Z}_n(t))} \lambda_i e^i ; \lambda_i \in \left\{ -\frac{1}{2}, 0, \frac{1}{2} \right\} \right\}, \\ &\quad + \mathcal{H}_n \left\{ t' + \sum_{i \in \frac{1}{2}(\mathcal{Z}_n(t))} \lambda_i e^i ; \lambda_i \in \left\{ -\frac{1}{2}, 0, \frac{1}{2} \right\} \right\}, \\ &= \beta(t) \cup \mathcal{E} \cup \beta(t'). \end{aligned}$$

Since this is a disjoint union, it is clear that :

$$\mathcal{E} = \mathcal{H}_n \left\{ z + \sum_{i \in \frac{1}{2}(\mathcal{Z}_n(t))} \lambda_i e^i ; \lambda_i \in \left\{ -\frac{1}{2}, 0, \frac{1}{2} \right\} \right\}.$$

Now that we have this equality, we want to prove that there exists an isomorphism between $\beta(t)$, \mathcal{E} and $\beta(t')$. By symmetry, it is sufficient to prove that \mathcal{E} and $\beta(t)$ are isomorph. For that, we define the application $\tau^{+,m} : \mathbb{H}^n \rightarrow \mathbb{H}^n$ such that for any $u \in \mathbb{H}^n$:

$$\tau^{+,m}(u) = \mathcal{H}_n(\mathcal{Z}_n(u) + \frac{1}{2}e^m).$$

Let us show first that this application maps \mathcal{E} to $\beta(t)$. Let u be an element of \mathcal{E} , then there exists for any $i \in \frac{1}{2}(\mathcal{Z}_n(t))$ one value $\lambda_i \in \{-\frac{1}{2}, 0, \frac{1}{2}\}$ such that $u = \mathcal{H}_n(\mathcal{Z}_n(z) + \sum_{i \in \frac{1}{2}(\mathcal{Z}_n(t))} \lambda_i e^i)$. This way, $\tau^{+,m}(u) = \mathcal{H}_n(\mathcal{Z}_n(z) + \frac{1}{2}e^m + \sum_{i \in \frac{1}{2}(\mathcal{Z}_n(t))} \lambda_i e^i)$. Since $\mathcal{Z}_n(z) + \frac{1}{2}e^m = \mathcal{Z}_n(t)$, we obtain that $\tau^{+,m}(u) = \mathcal{H}_n(\mathcal{Z}_n(t) + \sum_{i \in \frac{1}{2}(\mathcal{Z}_n(t))} \lambda_i e^i)$, and then $\tau^{+,m}(u) \in \mathbb{H}^n_{\{t, \frac{1}{2}(\mathcal{Z}_n(t)), \{-\frac{1}{2}, 0, \frac{1}{2}\}\}}$ which is in fact $\beta(t)$.

Now we want to prove that $\tau^{+,m}$ is injective, which is immediate because it is a translation. To prove that $\tau^{+,m}$, let us proceed this way: let v be a point in $\beta(t)$, then there exists for any $i \in \frac{1}{2}(\mathcal{Z}_n(t))$ one value $\lambda_i \in \{-\frac{1}{2}, 0, \frac{1}{2}\}$ such that $v = \mathcal{H}_n(\mathcal{Z}_n(t) + \sum_{i \in \frac{1}{2}(\mathcal{Z}_n(t))} \lambda_i e^i)$. Its antecedent is simply $u = \mathcal{H}_n(\mathcal{Z}_n(z) + \sum_{i \in \frac{1}{2}(\mathcal{Z}_n(t))} \lambda_i e^i)$ which obviously belongs to \mathcal{E} .

This translation is then a bijection from \mathcal{E} to $\beta(t)$. Now we need to prove that it preserves the order: let a, b be two elements of \mathcal{E} such that $a \succ b$, then there exists a value $i \in \frac{1}{2}(\mathcal{Z}_n(t))$ such that:

$$\begin{cases} \mathcal{Z}_n(a) \in \{\mathcal{Z}_n(b) - \frac{1}{2}e^i, \mathcal{Z}_n(b) + \frac{1}{2}e^i\}, \\ \mathcal{Z}(a_i) \in \mathbb{Z}, \\ \mathcal{Z}(b_i) \in (\mathbb{Z}/2) \setminus \mathbb{Z}, \end{cases}$$

Now let us define $a' = \tau^{+,m}(a)$ and $b' = \tau^{+,m}(b)$. We want to prove that a' covers b . In other words, $a' = \mathcal{H}_n(\mathcal{Z}_n(a) + \frac{1}{2}e^m)$ and $b' = \mathcal{H}_n(\mathcal{Z}_n(b) + \frac{1}{2}e^m)$. We obtain then that:

$$\begin{aligned} \mathcal{Z}_n(a') &= \mathcal{Z}_n(a) + \frac{1}{2}e^m, \\ &\in \{\mathcal{Z}_n(b) - \frac{1}{2}e^i + \frac{1}{2}e^m, \mathcal{Z}_n(b) + \frac{1}{2}e^i + \frac{1}{2}e^m\}, \\ &\in \{\mathcal{Z}_n(b') - \frac{1}{2}e^i, \mathcal{Z}_n(b') + \frac{1}{2}e^i\}. \end{aligned}$$

It remains to show that $\mathcal{Z}(a_i)$ belongs to \mathbb{Z} and that $\mathcal{Z}(b_i)$ belongs to $(\mathbb{Z}/2) \setminus \mathbb{Z}$. Since $\mathcal{Z}(b_i)$ belongs to $(\mathbb{Z}/2) \setminus \mathbb{Z}$, $\mathcal{Z}_n(b') = \mathcal{Z}_n(b) + \frac{1}{2}e^m$, and $m \notin \frac{1}{2}(\mathcal{Z}_n(t))$ which contains i , then $m \neq i$, which leads to $\mathcal{Z}(b'_i) = \mathcal{Z}(b_i)$, and then $\mathcal{Z}(b'_i)$ belongs to $(\mathbb{Z}/2) \setminus \mathbb{Z}$. The fact that $\mathcal{Z}(a'_i)$ belongs to \mathbb{Z} comes from the fact that $\mathcal{Z}(a'_i) \in \{\mathcal{Z}(b'_i) - \frac{1}{2}e^i, \mathcal{Z}(b'_i) + \frac{1}{2}e^i\}$. This concludes the proof. \square

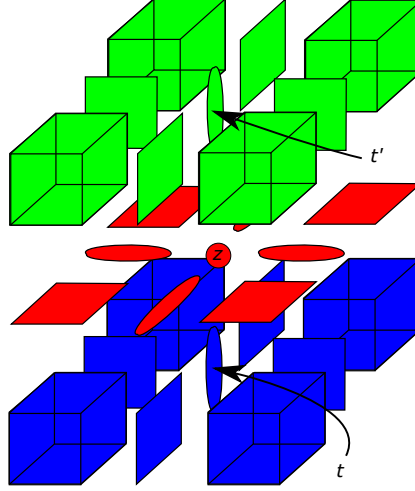

Figure 5.16: Isomorphic orders in \mathbb{H}^3 .

Lemma 18. *Assuming $n \geq 2$, let z be an element of $\mathbb{H}^n \setminus \mathbb{H}_n^n$ and t, t' be in $\mathbb{H}_{\dim(z)+1}^n$ such that they are opposite relatively to z . Then $|\beta^\square(z) \setminus (\beta(t) \cup \beta(t'))|$ is a $(n - \dim(z) - 2)$ -surface.*

Proof: Since t and t' are two opposites, $\mathbb{1}(\mathcal{Z}_n(t)) = \mathbb{1}(\mathcal{Z}_n(t'))$ by Lemma 17, and $\text{Card}(\mathbb{1}(\mathcal{Z}_n(t))) = \text{Card}(\mathbb{1}(\mathcal{Z}_n(z))) + 1$. Now let be m^* the only coordinate in $\llbracket 1, n \rrbracket$ such that $m^* \in \mathbb{1}(\mathcal{Z}_n(t)) \setminus \mathbb{1}(\mathcal{Z}_n(z))$. We can then write:

$$\mathcal{Z}_n(t) = \mathcal{Z}_n(z) + (\mathcal{Z}(t_{m^*}) - \mathcal{Z}(z_{m^*})) e^{m^*}.$$

Now let define $\mathcal{E} \stackrel{\text{def}}{=} \beta(z) \setminus (\beta(t) \cup \beta(t'))$, and let define the application $\mathfrak{Iso} : \mathcal{E} \rightarrow \mathbb{H}^n$ such that:

$$\forall u \in \mathcal{E}, \mathfrak{Iso}(u) = \mathcal{H}_n(\mathcal{Z}_n(u) + (\mathcal{Z}(t_{m^*}) - \mathcal{Z}(z_{m^*})) e^{m^*}).$$

Intuitively, this application translates the point u from \mathcal{E} to $\beta(t)$ directed by the vector e^{m^*} . More exactly, by Proposition 25, \mathfrak{Iso} is an isomorphism

from $|\mathcal{E}|$ to $|\beta(t)|$.

This way, $|\beta^\square(z) \setminus (\beta(t) \cup \beta(t'))| = |\mathcal{E} \setminus \{z\}|$ is isomorphic to $|\beta(t) \setminus \{\mathfrak{Iso}(z)\}| = |\beta^\square(t)|$ which is a $(n - \dim(t) - 1) = (n - 2 - \dim(z))$ -surface. \square

As depicted on Figure 5.16, when t and t' are opposite relatively to z , $|\mathcal{E}|$ depicted in red is isomorphic (as an order) to $|\beta(t)|$ depicted in blue and to $|\beta(t')|$ depicted in green. Take care that not every translation in the Khalimsky grid preserves the order.

5.8.5 F_i cannot contain two opposite faces

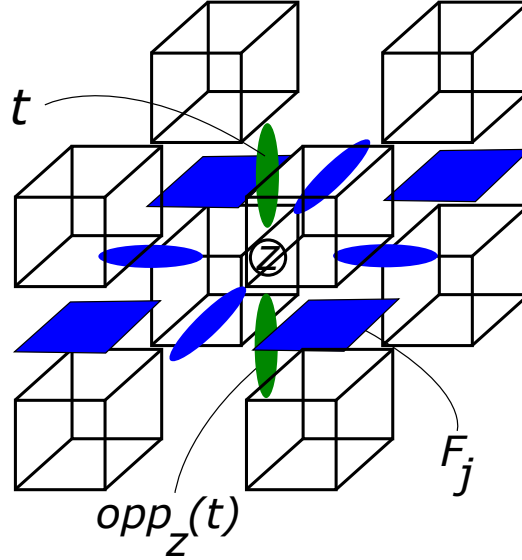

Figure 5.17: F_i cannot contain two opposite faces.

Property 20 (F_i cannot contain two opposite $(\dim(z) + 1)$ -faces). *Using Notations 10:*

$$\forall i \in \mathcal{I}, \forall t \in \mathbb{H}_{\dim(z)+1}^n, \{t \in F_i \Rightarrow \text{opp}_z(t) \notin F_i\}.$$

Proof: It is sufficient to show that the hypotheses of non connectivity of $|\beta_{\mathfrak{M}}^\square(z)|$ and of presence of two opposite faces in a same connected component

of $\beta_{\mathfrak{N}}^{\square}(z)$ are incompatible. The reasoning of this proof is depicted on Figure 5.17. Let i be in \mathcal{I} such that there exists $t, t' \in \mathbb{H}_{\dim(z)+1}^n \cap F_i$ verifying $t' = \text{opp}_z(t)$.

Then for all $j \in \mathcal{I}$, $j \neq i$, we have $\beta(F_i) \cap F_j = \emptyset$ by Property 16, and then $\beta(t) \cap F_j = \emptyset$, et $\beta(t') \cap F_j = \emptyset$. This way, $F_j \subseteq \beta^{\square}(z) \setminus (\beta(t) \cup \beta(t'))$, which is by Lemma 18 a $(n - \dim(z) - 2)$ -surface (like F_j). However, when two discrete surfaces of same rank verify an inclusion relationship, they are equal (see Theorem 9), then we have :

$$F_j = \beta^{\square}(z) \setminus (\beta(t) \cup \beta(t')).$$

This implies that F_i is included into $\beta(t) \cup \beta(t')$ and then $F_i = F_i \cap (\beta(t) \cup \beta(t'))$. Since t and t' belong to F_i , we obtain finally that:

$$F_i = \beta_{F_i}(t) \cup \beta_{F_i}(t'),$$

which is a disjoint union of two open non-empty sets, *i.e.*, F_i is not connected, which is impossible. □

5.8.6 F_i contains at most $(n - \dim(z))$ $(\dim(z) + 1)$ -faces

Property 21. *Using Notations 10, for each value i in \mathcal{I} , F_i contains at most $(n - \dim(z))$ $(\dim(z) + 1)$ -faces.*

Proof: $\beta^{\square}(z)$ contains exactly $2(n - \dim(z))$ couples of opposite $(\dim(z) + 1)$ -faces, and then for all i in \mathcal{I} , F_i contains at most $(n - \dim(z))$ $(\dim(z) + 1)$ -faces. □

5.8.7 $\beta_{\mathfrak{N}}^{\square}(z)$ is a closure of $(n - 1)$ -faces in $\beta^{\square}(z)$

Now let us prove somme lemmas useful in this subsection.

Lemma 19. *Let x, y be two elements of \mathbb{Z}^n and S be a block such that $x = \text{antag}_S(y)$. Then for all $z \in S$:*

$$\begin{cases} \alpha(\mathcal{H}_n(x)) \cap \alpha(\mathcal{H}_n(y)) \subseteq \alpha(\mathcal{H}_n(x)) \cap \alpha(\mathcal{H}_n(z)) \\ \alpha(\mathcal{H}_n(x)) \cap \alpha(\mathcal{H}_n(y)) \subseteq \alpha(\mathcal{H}_n(z)) \cap \alpha(\mathcal{H}_n(y)) \end{cases}$$

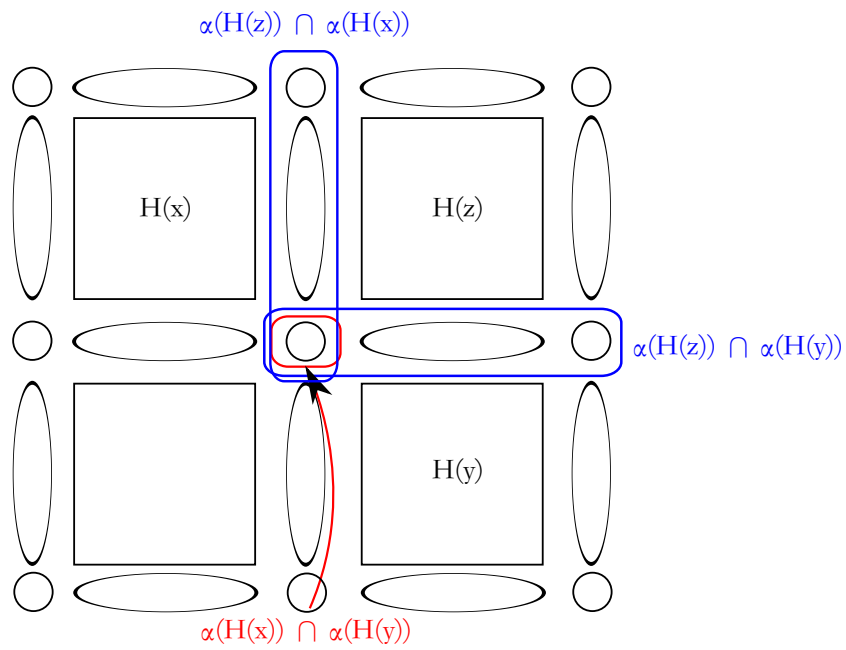

Figure 5.18: When z belongs to the block S where x and y are antagonist, we have the relation $\alpha(\mathcal{H}_n(x)) \cap \alpha(\mathcal{H}_n(y)) \subseteq \alpha(\mathcal{H}_n(z)) \cap \alpha(\mathcal{H}_n(y))$.

Proof: By symmetry, it is sufficient to show the first assertion (see Figure 5.18). Let $\mathfrak{J} = \{i \in \llbracket 1, n \rrbracket ; x_i \neq y_i\}$. Let z be an element of S , then for all $i \in \mathfrak{J}$, $z_i \in \{x_i, y_i\}$ and for all $i \in \llbracket 1, n \rrbracket \setminus \mathfrak{J}$, $x_i = y_i = z_i$.

When $i \in \llbracket 1, n \rrbracket \setminus \mathfrak{J}$, $x_i = y_i = z_i$ and then:

$$\alpha(\mathcal{H}(x_i)) \cap \alpha(\mathcal{H}(y_i)) = \alpha(\mathcal{H}(x_i)) = \alpha(\mathcal{H}(x_i)) \cap \alpha(\mathcal{H}(z_i)).$$

When $i \in \mathfrak{J}$, either $z_i = x_i$, and:

$$\alpha(\mathcal{H}(x_i)) \cap \alpha(\mathcal{H}(y_i)) \subseteq \alpha(\mathcal{H}(x_i)) = \alpha(\mathcal{H}(x_i)) \cap \alpha(\mathcal{H}(z_i)),$$

or $z_i = y_i$ and it is immediate that:

$$\alpha(\mathcal{H}(x_i)) \cap \alpha(\mathcal{H}(y_i)) \subseteq \alpha(\mathcal{H}(y_i)) = \alpha(\mathcal{H}(y_i)) \cap \alpha(\mathcal{H}(z_i)).$$

A simple application of the cartesian product is then sufficient to end the proof. \square

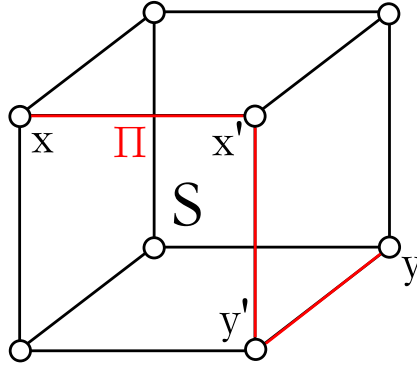

Figure 5.19: Let x be in X and y be in Y such that they are antagonist in a block $S \subset \mathbb{Z}^n$. They are joined by a $2n$ -path $\pi \subset S$ containing a couple $(x', y') \in X \times Y$ such that $x \in \mathcal{N}_{2n}^*(y)$.

Property 22 ($\beta_{\mathfrak{N}}^{\square}(z)$ is the closure of a set of $(n-1)$ -faces in $\beta^{\square}(z)$). Using Notations 10, for each $z \in \mathfrak{N}$:

$$\beta_{\mathfrak{N}}^{\square}(z) = \bigcup_{f \in \mathbb{H}_{n-1}^{\square} \cap \beta_{\mathfrak{N}}^{\square}(z)} \alpha(f) \cap \beta^{\square}(z),$$

in other words, $\beta_{\mathfrak{N}}^{\square}(z)$ is equal to the union of the closures (into $\beta^{\square}(z)$) of the $(n-1)$ -faces contained in it.

Proof: Since for all $f \in \beta_{\mathfrak{N}}^{\square}(z)$, $f \in \mathfrak{N}$, then $\alpha(f) \cap \beta^{\square}(z) \subseteq \beta_{\mathfrak{N}}^{\square}(z)$ because $\beta_{\mathfrak{N}}^{\square}(z)$ is closed in the subspace $\beta^{\square}(z)$, the reciprocal inclusion is immediate.

Now let u be in $\beta_{\mathfrak{N}}^{\square}(z)$. Let us recall that $S(z) \equiv \mathcal{Z}_n(\beta(z) \cap \mathbb{H}_n^n)$ is the block centered at z . Then by Lemma 14:

$$\begin{aligned}\beta_{\mathfrak{N}}^{\square}(z) &= \alpha(\mathcal{H}_n(X)) \cap \alpha(\mathcal{H}_n(Y)) \cap \beta^{\square}(z), \\ &= \alpha(\mathcal{H}_n(X \cap S(z))) \cap \alpha(\mathcal{H}_n(Y \cap S(z))) \cap \beta^{\square}(z).\end{aligned}$$

This way, there exists $x \in X \cap S(z)$ and $y \in Y \cap S(z)$ such that $u \in \alpha(\mathcal{H}_n(x)) \cap \alpha(\mathcal{H}_n(y))$. x and y belonging to the same block $S(z)$ and being distinct, they are k -antagonist, $k \geq 1$.

Now let be $\mathfrak{J} = \{i \in \llbracket 1, n \rrbracket ; x_i \neq y_i\}$, reindexed such that $\mathfrak{J} = \{e^{j_1}, \dots, e^{j_k}\}$. We can then define the $2n$ -path $\pi, i.e.,$ a sequence in \mathbb{Z}^n such as two consecutive elements in the sequence are $2n$ -neighbours in \mathbb{Z}^n , joining x and y into $S(z)$: $\pi = (p^0 = x, p^1, \dots, p^{k-1}, p^k = y)$, verifying the recursive relation:

$$\begin{cases} p^0 = x, \\ p^l = p^{l-1} + (y_{j_l} - x_{j_l}) \cdot e^{j_l}, \forall l \in \llbracket 1, k \rrbracket, \end{cases}$$

Now, let us define $l^* = (\min\{l \in \llbracket 1, k \rrbracket ; p^l \in Y\} - 1)$, then we obtain two points $x' \equiv p^{l^*} \in X$ and $y' \equiv p^{l^*+1} \in Y$ which are $2n$ -neighbors in the block $S(z)$ (voir Figure 5.19).

Since $y' - x = \sum_{l \in \llbracket 1, l^*+1 \rrbracket} (y_{j_l} - x_{j_l}) \cdot e^{j_l}$, y' and x are antagonist in a block of dimension $(l^* + 1)$ that we will call S' . Moreover:

$$\begin{cases} x' = x + \sum_{l \in \llbracket 1, l^* \rrbracket} (y_{j_l} - x_{j_l}) \cdot e^{j_l}, & (1) \\ y' = x + \sum_{l \in \llbracket 1, l^*+1 \rrbracket} (y_{j_l} - x_{j_l}) \cdot e^{j_l}, & (2) \end{cases}$$

then for all $i \in \{j_1, \dots, j_{l^*}\}$, $x'_i = y_i = y'_i$ by (1) and (2), then $\forall i \in \llbracket 1, n \rrbracket$, $x'_i \in \{y'_i, x_i\}$, which implies $x' \in S'$.

Then, using Lemma 19:

$$\alpha(\mathcal{H}_n(x)) \cap \alpha(\mathcal{H}_n(y')) \subseteq \alpha(\mathcal{H}_n(x')) \cap \alpha(\mathcal{H}_n(y')).$$

Moreover, $y' \in S$ where x and y are antagonist, so one more time using Lemma 19,

$$\alpha(\mathcal{H}_n(x)) \cap \alpha(\mathcal{H}_n(y)) \subseteq \alpha(\mathcal{H}_n(x)) \cap \alpha(\mathcal{H}_n(y')),$$

and then we obtain by transitivity that:

$$\alpha(\mathcal{H}_n(x)) \cap \alpha(\mathcal{H}_n(y)) \subseteq \alpha(\mathcal{H}_n(x')) \cap \alpha(\mathcal{H}_n(y')).$$

This way, $u \in \alpha(\mathcal{H}_n(x')) \cap \alpha(\mathcal{H}_n(y')) \subseteq \mathfrak{N}$ because $x' \in X$ and $y' \in Y$. x' and y' being $2n$ -neighbors, they are 1-antagonist and then u belongs to the closure of the $(n-1)$ -face $f = \mathcal{H}_n(x') \wedge \mathcal{H}_n(y')$. This face belongs to $\beta^\square(z)$ because $x', y' \in S(z)$ and this way $u \in \alpha(f) \cap \beta^\square(z)$ with $f \in \beta_{\mathfrak{N}}^\square(z) \cap \mathbb{H}_{n-1}^n$. \square

5.8.8 F_i is a closure of $(n-1)$ -faces in $\beta^\square(z)$

Property 23 (F_i is a closure of $(n-1)$ -faces in $\beta^\square(z)$). *Using Notations 10, $\forall i \in \mathcal{I}, \forall m \in \llbracket \dim(z)+1, n-1 \rrbracket$, F_i is the closure of an union of $(n-1)$ -faces in $\beta^\square(z)$, i.e.:*

$$F_i = \bigcup_{f \in \mathbb{H}_{n-1}^n \cap F_i} \alpha(f) \cap \beta^\square(z).$$

Proof: Using Property 22, we have:

$$\beta_{\mathfrak{N}}^\square(z) = \bigcup_{f \in \mathbb{H}_{n-1}^n \cap \beta_{\mathfrak{N}}^\square(z)} \alpha(f) \cap \beta^\square(z),$$

where for all $f \in \mathbb{H}_{n-1}^n \cap \beta_{\mathfrak{N}}^\square(z)$, the orders $|\alpha(f) \cap \beta^\square(z)|$ are connected: $|\alpha^\square(f) \cap \beta^\square(z)|$ is a $(\dim(f) - \dim(z) - 2)$ -surface, and then:

- if $\dim(z) = n-3$, $(\dim(f) - \dim(z) - 2) = ((n-1) - (n-3) - 2) = 0$, and then $|\alpha^\square(f) \cap \beta^\square(z)|$ is a 0-surface such that $|\alpha(f) \cap \beta^\square(z)|$ is connected: f is connected to the two points of $|\alpha^\square(f) \cap \beta^\square(z)|$.
- if $\dim(z) \leq n-4$, $|\alpha^\square(f) \cap \beta^\square(z)|$ is connected and then so does $|\alpha(f) \cap \beta^\square(z)|$ since f is a neighbor of $|\alpha^\square(f) \cap \beta^\square(z)|$.

Now, let us show by a double inclusion that we can prove the result we are looking for.

For any $i \in \mathcal{I}$, and for each $f \in \mathbb{H}_{n-1}^n \cap F_i$, $|\alpha(f) \cap \beta^\square(z)|$ is connected, and share f with F_i . Since they are both subsets of $\beta_{\mathfrak{H}}^\square(z)$, by definition of F_i ,

$$F_i \supseteq \alpha(f) \cap \beta^\square(z).$$

Hence,

$$F_i \supseteq \bigcup_{f \in \mathbb{H}_{n-1}^n \cap F_i} \alpha(f) \cap \beta^\square(z).$$

Conversely, F_i is a connected component of $|\beta_{\mathfrak{H}}^\square(z)|$ which is closed in $\beta^\square(z)$, and then is also closed in $\beta^\square(z)$, which means that for $f \in F_i$, $\alpha(f) \cap \beta^\square(z) \subseteq F_i$, then for any $f \in F_i \cap \mathbb{H}_{n-1}^n$, $\alpha(f) \cap \beta^\square(z) \subseteq F_i$, and then:

$$F_i \subseteq \bigcup_{f \in \mathbb{H}_{n-1}^n \cap F_i} \alpha(f) \cap \beta^\square(z).$$

That concludes the proof. \square

5.8.9 F_i contains faces of each dimension into $\llbracket \dim(z) + 1, n - 1 \rrbracket$

Lemma 20. *Let f, z be two elements of \mathbb{H}^n such that $f \in \beta(z)$, and let be $\mathfrak{J} = \{i \in \llbracket 1, n \rrbracket ; f_i \neq z_i\}$. Then,*

$$\dim(f) = \dim(z) + \text{Card}(\mathfrak{J}).$$

Proof: Since $f \in \beta(z)$, then for all $i \in \llbracket 1, n \rrbracket$, $f_i \in \beta(z_i)$ and then three cases are possible:

- either $\dim(z_i) = 1$, and then $f_i = z_i$ (because $\beta(z_i) = \{z_i\}$),
- or $\dim(z_i) = 0$ and $\dim(f_i) = 0$, then $f_i = z_i$ (because the only face of dimension 0 in $\beta(z_i)$ is z_i),
- or $\dim(z_i) = 0$ and $\dim(f_i) = 1$, and then $f_i \in \{\mathcal{H}(\mathcal{Z}(z_i) - \frac{1}{2}), \mathcal{H}(\mathcal{Z}(z_i) + \frac{1}{2})\}$.

In other words, the number of coordinates where f and z are different is equal to the the number of times when the dimension of f_i is strictly superior to the dimension of z_i when i is in $\llbracket 1, n \rrbracket$.

\square

Property 24. *Using Notations 10, $\forall i \in \mathcal{I}, \forall m \in \llbracket \dim(z) + 1, n - 1 \rrbracket$:*

$$F_i \cap \mathbb{H}_m^n \neq \emptyset.$$

Proof: Intuitively, F_i being an union of closing of $(n - 1)$ -faces in $\beta^\square(z)$ by Property 23, it contains faces of all dimensions between $(n - 1)$ and $(\dim(z) + 1)$. Formally, since F_i is non empty, there exists one face $f \in \mathbb{H}_{n-1}^n \cap F_i \subseteq \beta^\square(z)$ such that $\alpha(f) \cap \beta^\square(z)$ is included into F_i . Furthermore, $\alpha(f) \cap \beta^\square(z)$ is not empty because $f \in \beta^\square(z)$, then:

$$\alpha(f) \cap \beta^\square(z) = \{\mathcal{H}_n(u) ; u_i \in \{\mathcal{Z}(f_i), \mathcal{Z}(z_i)\}, \forall i \in \llbracket 1, n \rrbracket\} \setminus \{z\}.$$

Let us define $\mathfrak{J} = \{i \in \llbracket 1, n \rrbracket ; z_i \neq f_i\}$ reindexed such that $\mathfrak{J} = \{e^{j_0}, \dots, e^{j_k}\}$ where $k = \text{Card}(\mathfrak{J})$, and let us define the sequence $(u^l)_{l \in \llbracket 0, k \rrbracket}$ included into $\mathcal{Z}_n(\alpha(f) \cap \beta(z))$ defined such that:

$$\begin{cases} u^0 = \mathcal{Z}_n(f), \\ u^{l+1} = u^l + (\mathcal{Z}(z_{j_l}) - \mathcal{Z}(f_{j_l})) e^{j_l}, \forall l \in \llbracket 0, k - 1 \rrbracket. \end{cases}$$

Since f belongs to $\beta(z)$ by hypothesis, $|\mathcal{Z}(f_i) - \mathcal{Z}(z_i)| = \frac{1}{2}, \forall i \in \mathfrak{J}$. In this way, $\mathcal{H}_n(u^l)$ is of dimension $(\dim(f) - l)$ for any $l \in \llbracket 0, k \rrbracket$. By Lemma 20, $k = \dim(f) - \dim(z)$, and then $\dim(\mathcal{H}_n(u^l))$ ranges $\llbracket \dim(z) + 1, n - 1 \rrbracket$ when l ranges $\llbracket 0, k - 1 \rrbracket$. For this values of l , $\mathcal{H}_n(u^l)$ belongs to $\alpha(f) \cap \beta^\square(z)$, this concludes the proof. \square

5.8.10 Rank lemma

Lemma 21 (Rank lemma). *Using Notations 10,*

$$\forall i \in \mathcal{I}, \forall v \in F_i, \rho(v, |F_i|) = \dim(v) - \dim(z) - 1.$$

Proof: Let u be an element of F_i . We want to show by induction that $\rho(u, |F_i|) = k$ is equivalent to $\dim(u) = k + \dim(z) + 1$.

Initialization ($k = 0$): first, let us assume that u is of dimension $\dim(u) = \dim(z) + 1$. Since $F_i \subseteq \beta^\square(z)$, $\alpha^\square(u) \cap F_i \subseteq \alpha^\square(u) \cap \beta^\square(z) = \emptyset$, then $\alpha_{F_i}^\square(u) = \emptyset$, and then $\rho(u, |F_i|) = 0$. Now, let us assume that $\rho(u, |F_i|) = 0$, then u belongs to F_i which is closed in $\beta^\square(z)$, and then $\alpha(u) \cap \beta^\square(z) \subseteq F_i$. In this way, the only faces whose rank is 0 in F_i are the $(\dim(z) + 1)$ -faces of $\beta^\square(z)$. Finally

we have for each $u \in F_i$ the equivalence $\rho(u, |F_i|) = 0 \Leftrightarrow \dim(u) = \dim(z) + 1$.

Heredity ($k \geq 1$): we can assume that for each $l \in \llbracket 0, k-1 \rrbracket$, $\rho(u, |F_i|) = l \Leftrightarrow \dim(u) = \dim(z) + 1 + l$. Let us show that for all $v \in F_i$ and $k \geq 1$, we effectively have the equivalence $\rho(v, |F_i|) = k \Leftrightarrow \dim(v) = k + \dim(z) + 1$.

Let v be in F_i such that $\dim(v) = k + \dim(z) + 1$. Then, using the induction hypothesis, we obtain:

$$\begin{aligned} \rho(v, |F_i|) &= \max \left\{ \rho(u, |F_i|) ; u \in \alpha^\square(v) \cap F_i \right\} + 1, \\ &= \max \left\{ \dim(u) - \dim(z) - 1 ; u \in \alpha_{F_i}^\square(v) \right\} + 1, \\ &= \max \left\{ \dim(u) ; u \in \alpha_{F_i}^\square(v) \right\} - \dim(z). \end{aligned}$$

Since $v \in F_i$, $\alpha(v) \cap \beta^\square(z) \subseteq F_i$ and then $\alpha^\square(v) \cap \beta^\square(z) \subseteq \alpha_{F_i}^\square(v)$, which leads to:

$$\max \left\{ \dim(u) ; u \in \alpha_{F_i}^\square(v) \right\} \geq \max \left\{ \dim(u) ; u \in \alpha^\square(v) \cap \beta^\square(z) \right\} \geq \dim(v) - 1,$$

and in the same time, $\max \left\{ \dim(u) ; u \in \alpha_{F_i}^\square(v) \right\} \leq \dim(v) - 1$ (because $u \in \alpha^\square(v)$). This way, $\max \left\{ \dim(u) ; u \in \alpha_{F_i}^\square(v) \right\} = \dim(v) - 1$ and then $\rho(v, |F_i|) = \dim(v) - \dim(z) - 1 = k$. The direct implication is then proven.

Let us assume now that $v \in F_i$ verifies $\rho(v, |F_i|) = k$. By the induction hypothesis, we obtain one more time:

$$\rho(v, |F_i|) = \max \left\{ \dim(u) ; u \in \alpha_{F_i}^\square(v) \right\} - \dim(z).$$

In other words, $\max \left\{ \dim(u) ; u \in \alpha_{F_i}^\square(v) \right\} = k + \dim(z)$, and then:

$$\max \left\{ \dim(u) ; u \in \alpha^\square(v) \right\} \geq k + \dim(z).$$

v is then of dimension superior or equal to $(k + \dim(z) + 1)$.

Let us assume now that $\dim(v) \geq k + \dim(z) + 2$. Since $v \in F_i$, $\alpha(v) \cap \beta^\square(z) \subseteq F_i$, and then v covers one or several faces in F_i of dimension(s) superior or equal to $(k + \dim(z) + 1)$, and then $\max \left\{ \dim(u) ; u \in \alpha_{F_i}^\square(v) \right\} \geq k + \dim(z) + 1$, which implies that $\rho(v, |F_i|) \geq k + 1$, which is impossible. Then $\dim(v) = k + \dim(z) + 1$. The reciprocal implication is then proven. \square

5.8.11 Definition and properties of $\mathcal{T}(u)$

Notations 13. From now on, we will use the notation:

$$\forall z \in \mathbb{H}^n \setminus \mathbb{H}_n^n, \forall u \in \beta^\square(z), \mathcal{T}(u) \equiv \alpha(u) \cap \beta^\square(z) \cap \mathbb{H}_{\dim(z)+1}^n.$$

Lemma 22. For all $z \in \mathbb{H}^n \setminus \mathbb{H}_n^n$ and for all $u \in \beta^\square(z)$,

$$\mathcal{T}(u) = \left\{ \mathcal{H}_n(\mathcal{Z}_n(z) + (\mathcal{Z}(u_i) - \mathcal{Z}(z_i)).e^i) ; i \in \mathbb{1}(\mathcal{Z}_n(u)) \cap \frac{1}{2}(\mathcal{Z}_n(z)) \right\}.$$

Proof: Let us define:

$$\mathcal{A} = \left\{ \mathcal{H}_n(\mathcal{Z}_n(z) + (\mathcal{Z}(u_i) - \mathcal{Z}(z_i)).e^i) ; i \in \mathbb{1}(\mathcal{Z}_n(u)) \cap \frac{1}{2}(\mathcal{Z}_n(z)) \right\}.$$

Let us show first that $\mathcal{A} \subseteq \mathcal{T}(u)$. Since we have $u \in \beta^\square(z)$, $\mathbb{1}(\mathcal{Z}_n(u)) \cap \frac{1}{2}(\mathcal{Z}_n(z)) \neq \emptyset$. Then let t be a face in \mathcal{A} , t can be written:

$$t = \mathcal{H}_n(\mathcal{Z}_n(z) + (\mathcal{Z}(u_{i^*}) - \mathcal{Z}(z_{i^*})).e^{i^*}),$$

with $i^* \in \mathbb{1}(\mathcal{Z}_n(u)) \cap \frac{1}{2}(\mathcal{Z}_n(z))$. We recall that $\frac{1}{2}(\mathcal{Z}_n(u)) \cap \mathbb{1}(\mathcal{Z}_n(z)) = \emptyset$ because $u \in \beta^\square(z)$, we then have the different subcases when $i \in \llbracket 1, n \rrbracket$:

1. either $i \in (\mathbb{1}(\mathcal{Z}_n(u)) \cap \mathbb{1}(\mathcal{Z}_n(z))) \cup (\frac{1}{2}(\mathcal{Z}_n(u)) \cap \frac{1}{2}(\mathcal{Z}_n(z)))$, then $u_i = z_i$ and then $t_i = z_i = u_i$ implies that $t_i \in \alpha(u_i) \cap \beta(z_i)$.
2. or $i = i^* \in \mathbb{1}(\mathcal{Z}_n(u)) \cap \frac{1}{2}(\mathcal{Z}_n(z))$, then $t_i = u_i$ with $\mathcal{Z}(u_i) = \mathcal{Z}(z_i) \pm \frac{1}{2}$. Since $\mathcal{Z}(t_i) = \mathcal{Z}(z_i) \pm \frac{1}{2}$, we have then $t_i \in \{\{\mathcal{Z}(z_i) - 1/2, \mathcal{Z}(z_i) + 1/2\}, \{\mathcal{Z}(z_i) + 1/2, \mathcal{Z}(z_i) + 3/2\}\}$. Also, $\beta(z_i) = \{\{\mathcal{Z}(z_i) - 1/2, \mathcal{Z}(z_i) + 1/2\}, \{\mathcal{Z}(z_i) + 1/2\}, \{\mathcal{Z}(z_i) + 1/2, \mathcal{Z}(z_i) + 3/2\}\} \ni t_i$. This way, $t_i \in \alpha(u_i) \cap \beta(z_i)$.
3. or $i \in \mathbb{1}(\mathcal{Z}_n(u)) \cap \frac{1}{2}(\mathcal{Z}_n(z)) \setminus \{i^*\}$, then $t_i = z_i$ with $\mathcal{Z}(z_i) = \mathcal{Z}(u_i) \pm \frac{1}{2}$. Since $t_i = \{\mathcal{Z}(t_i) + \frac{1}{2}\}$, we have $\alpha(u_i) = \{\{\mathcal{Z}(u_i), \mathcal{Z}(u_i) + 1\}, \{\mathcal{Z}(u_i)\}, \{\mathcal{Z}(u_i) + 1\}\} \ni \{\mathcal{Z}(z_i) + \frac{1}{2}\} = t_i$. This way, $t_i \in \alpha(u_i) \cap \beta(z_i)$.

We have finally $t \in \alpha(u) \cap \beta(z)$, and since by construction we have $t \neq z$, $t \in \alpha(u) \cap \beta^\square(z)$. Furthermore, $\mathcal{Z}_n(t)$ owns the $\dim(z)$ integral coordinates of z more the i^* -th one, and then $t \in \mathbb{H}_{\dim(z)+1}^n$, then $\mathcal{A} \subseteq \mathcal{T}(u)$.

Let us show now that $\mathcal{T}(u) \subseteq \mathcal{A}$. Let t be in $\mathcal{T}(u)$. We recall that $\frac{1}{2}(\mathcal{Z}_n(u)) \cap \mathbb{1}(\mathcal{Z}_n(z)) = \emptyset$ because $u \in \beta^\square(z)$. Then we have the possible following cases:

1. either $i \in \mathbb{1}(\mathcal{Z}_n(u)) \cap \mathbb{1}(\mathcal{Z}_n(z)) = \mathbb{1}(\mathcal{Z}_n(z))$, then $\mathcal{Z}(t_i) = \mathcal{Z}(z_i) \in \mathbb{Z}$
2. or $i \in \mathbb{1}(\mathcal{Z}_n(u)) \cap \frac{1}{2}(\mathcal{Z}_n(z))$, then $t_i \in \{z_i, u_i\}$ and then $\mathcal{Z}(t_i) \in \mathbb{Z}$ if $t_i = u_i$ and $\mathcal{Z}(t_i) \in (\mathbb{Z}/2) \setminus \mathbb{Z}$ if $t_i = z_i$
3. or $i \in \frac{1}{2}(\mathcal{Z}_n(u)) \cap \frac{1}{2}(\mathcal{Z}_n(z)) = \frac{1}{2}(\mathcal{Z}_n(u))$, then $\mathcal{Z}(t_i) = \mathcal{Z}(u_i) \in (\mathbb{Z}/2) \setminus \mathbb{Z}$

This way, since $\{\forall i \in \llbracket 1, n \rrbracket, i \in \mathbb{1}(\mathcal{Z}_n(z)) \Rightarrow i \in \mathbb{1}(\mathcal{Z}_n(t))\}$ and since $t \in \mathbb{H}_{\dim(z)+1}^n$, there exists an unique coordinate $i^* \in \mathbb{1}(\mathcal{Z}_n(t)) \setminus \mathbb{1}(\mathcal{Z}_n(z))$. Then, $t_{i^*} = u_{i^*} \neq z_{i^*}$ and for all $i \in \llbracket 1, n \rrbracket \setminus \{i^*\}$, $t_i = z_i$. Since $i^* \in \mathbb{1}(\mathcal{Z}_n(u)) \cap \frac{1}{2}(\mathcal{Z}_n(z))$ (because $t \in \alpha(u)$), and since:

$$t = \mathcal{H}_n(\mathcal{Z}_n(z) + (\mathcal{Z}(u_{i^*}) - \mathcal{Z}(z_{i^*})) \cdot e^{i^*}),$$

we obtain that $t \in \mathcal{A}$. □

5.8.12 Supremum of two faces

Let us study under which condition we can say that an *supremum* exists between two elements $a, b \in \mathbb{H}^n$, that is, when there exists a smallest element which is inferior or equal to any element which is superior to both a and b .

Definition 61 (inf). *Let X be a subset of \mathbb{H}^n . If there exists one element $x \in X$ such that for any $y \in X$, $y \supseteq x$, we say that x is the smallest element of X , and we denote it $\inf(X)$.*

Definition 62 (Supremum). *Let a, b be two elements of \mathbb{H}^n . When $\inf(\beta(a) \cap \beta(b))$ is well-defined, we denote it $a \vee b$ and we call it the supremum between a and b .*

Lemma 23. *Let a, b be two elements of \mathbb{H}^n . Then,*

$$\{\beta(a) \cap \beta(b) \neq \emptyset\} \Leftrightarrow \{a \vee b \text{ is well-defined}\}.$$

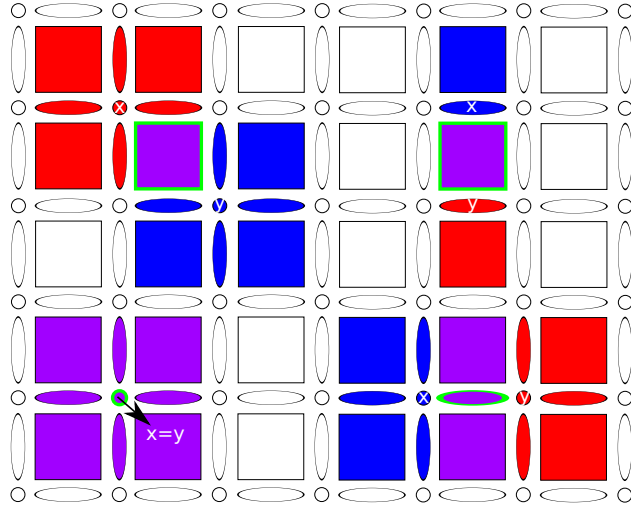

Figure 5.20: Examples of supremums between x and y : $\beta(x)$ is in red, $\beta(y)$ is in blue, their intersection is in purple, and the supremums of x and y has a green contour.

Furthermore, when $a \vee b$ is well-defined, it verifies the relations:

$$\begin{cases} a \vee b = \otimes_{i \in \llbracket 1, n \rrbracket} (a_i \vee b_i), \\ \beta(a \vee b) = \beta(a) \cap \beta(b). \end{cases}$$

Proof: Let us treat first the case $a_1, b_1 \in \mathbb{H}^1$ and let us proceed case by case.

- either a_1, b_1 are in \mathbb{H}_0^1 . Then there exists $i, j \in \mathbb{Z}$ such that $a_1 = \{i\}$ et $b_1 = \{j\}$. Then $\beta(a_1) = \{\{i-1, i\}, \{i\}, \{i, i+1\}\}$, $\beta(b_1) = \{\{j-1, j\}, \{j\}, \{j, j+1\}\}$.
 - Either $i = j$ and $\beta(a_1) \cap \beta(b_1) = \{\{i-1, i\}, \{i\}, \{i, i+1\}\}$ and $a_1 \vee b_1 = \{i\}$ which implies that $\beta(a_1) \cap \beta(b_1) = \beta(a_1 \vee b_1)$.
 - Or $i = j-1$, and $\beta(a_1) \cap \beta(b_1) = \{\{i, i+1\}\}$ and $a_1 \vee b_1 = \{i, i+1\}$, which implies $\beta(a_1) \cap \beta(b_1) = \beta(a_1 \vee b_1)$.
 - Or $i = j+1$, and $\beta(a_1) \cap \beta(b_1) = \{\{j, j+1\}\}$ and $a_1 \vee b_1 = \{j, j+1\}$, which implies $\beta(a_1) \cap \beta(b_1) = \beta(a_1 \vee b_1)$.

- Or $i \notin \{j-1, j, j+1\}$, then $\beta(a_1) \cap \beta(b_1) = \emptyset$ and $a_1 \vee b_1$ does not exist.
- or $a_1 \in \mathbb{H}_1^1$ and $b_1 \in \mathbb{H}_0^1$. Then there exist $i, j \in \mathbb{Z}$ such that $a_1 = \{i, i+1\}$ and $b_1 = \{j\}$. Then $\beta(a_1) = \{\{i, i+1\}\}$, $\beta(b_1) = \{\{j-1, j\}, \{j\}, \{j, j+1\}\}$.
 - Either $i = j$, $\beta(a_1) \cap \beta(b_1) = \{\{i, i+1\}\}$, $a_1 \vee b_1 = \{i, i+1\}$ and $\beta(a_1) \cap \beta(b_1) = \beta(a_1 \vee b_1)$.
 - Or $i = j-1$, $\beta(a_1) \cap \beta(b_1) = \{\{j-1, j\}\}$, $a_1 \vee b_1 = \{j-1, j\}$, and $\beta(a_1) \cap \beta(b_1) = \beta(a_1 \vee b_1)$.
 - Or $i \notin \{j-1, j\}$, then $\beta(a_1) \cap \beta(b_1) = \emptyset$ and $a_1 \vee b_1$ does not exist.
- or $a_1 \in \mathbb{H}_0^1$ and $b_1 \in \mathbb{H}_1^1$. Then the reasoning is the same as before.
- or $a_1, b_1 \in \mathbb{H}_1^1$. Then there exist $i, j \in \mathbb{Z}$ such that $a_1 = \{i, i+1\}$ and $b_1 = \{j, j+1\}$. We obtain then $\beta(a_1) = \{\{i, i+1\}\}$, $\beta(b_1) = \{\{j, j+1\}\}$.
 - Either $i = j$, then $\beta(a_1) \cap \beta(b_1) = \{\{i, i+1\}\}$, $a_1 \vee b_1 = \{i, i+1\}$ and $\beta(a_1) \cap \beta(b_1) = \beta(a_1 \vee b_1)$.
 - Or $i \neq j$, $\beta(a_1) \cap \beta(b_1) = \emptyset$ and $a_1 \vee b_1$ does not exist.

When a, b belong to \mathbb{H}^n , $n \geq 1$, such that $\beta(a) \cap \beta(b) \neq \emptyset$, we obtain by Lemma 2 that:

$$\begin{aligned}
\beta(a) \cap \beta(b) &= \beta(\otimes_{i \in \llbracket 1, n \rrbracket} a_i) \cap \beta(\otimes_{i \in \llbracket 1, n \rrbracket} b_i), \\
&= \otimes_{i \in \llbracket 1, n \rrbracket} \beta(a_i) \cap \otimes_{i \in \llbracket 1, n \rrbracket} \beta(b_i), \\
&= \otimes_{i \in \llbracket 1, n \rrbracket} (\beta(a_i) \cap \beta(b_i)), \\
&\neq \emptyset,
\end{aligned}$$

then for all $i \in \llbracket 1, n \rrbracket$, $\beta(a_i) \cap \beta(b_i) \neq \emptyset$, which implies that $a_i \vee b_i$ exists and $\beta(a_i) \cap \beta(b_i) = \beta(a_i \vee b_i)$. This way:

$$\begin{aligned}
\beta(a) \cap \beta(b) &= \beta(\otimes_{i \in \llbracket 1, n \rrbracket} a_i) \cap \beta(\otimes_{i \in \llbracket 1, n \rrbracket} b_i) \\
&= \otimes_{i \in \llbracket 1, n \rrbracket} (\beta(a_i) \cap \beta(b_i)) \\
&= \otimes_{i \in \llbracket 1, n \rrbracket} \beta(a_i \vee b_i) \\
&= \beta(\otimes_{i \in \llbracket 1, n \rrbracket} a_i \vee b_i)
\end{aligned}$$

whose infimum is $\otimes_{i \in \llbracket 1, n \rrbracket} a_i \vee b_i$ and then $a \vee b = \otimes_{i \in \llbracket 1, n \rrbracket} a_i \vee b_i$, and $\beta(a \vee b) = \beta(a) \cap \beta(b)$. □

5.8.13 Decomposition lemma

Now let us show that we can “decompose” any face of $\beta^\square(z)$ as a function of its $(\dim(z) + 1)$ -faces.

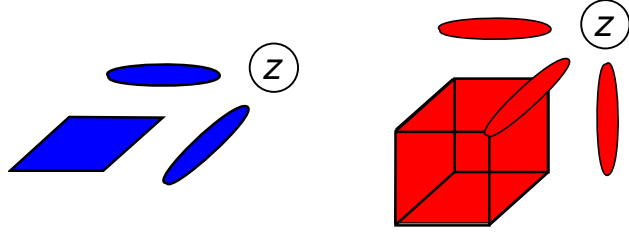

Figure 5.21: Decomposing faces of $\beta^\square(z)$ into $(\dim(z) + 1)$ -faces. On the left, a $(\dim(z) + 2)$ -face is decomposed into two $(\dim(z) + 1)$ -faces and on the right a $(\dim(z) + 3)$ -face is decomposed into three $(\dim(z) + 1)$ -faces.

Lemma 24 (Decomposition lemma). *Let z be a face in $\mathbb{H}^n \setminus \mathbb{H}_n^n$. Each face $u \in \beta^\square(z)$ can be decomposed in the following manner (see Figure 5.21):*

$$u = \bigvee_{v \in \mathcal{T}(u)} v.$$

Proof: we need first to show that $\bigvee_{v \in \mathcal{T}(u)} v$ exists. To this aim, it is sufficient to show that $\bigcap_{t \in \mathcal{T}(u)} \beta(t) \neq \emptyset$. However, $u \in \beta^\square(z)$ implies by Lemma 22

that $\mathcal{T}(u) = \{\mathcal{H}_n(\mathcal{Z}_n(z) + (\mathcal{Z}_n(u_i) - \mathcal{Z}_n(z_i)) \cdot e^i) ; i \in \mathbb{1}(\mathcal{Z}_n(u)) \cap \frac{1}{2}(\mathcal{Z}_n(z))\}$. For all $i^* \in \mathbb{1}(\mathcal{Z}_n(u)) \cap \frac{1}{2}(\mathcal{Z}_n(z))$, let us denote:

$$t^{i^*} \equiv \mathcal{H}_n(\mathcal{Z}_n(z) + (\mathcal{Z}_n(u_{i^*}) - \mathcal{Z}_n(z_{i^*})) e^{i^*}),$$

then $\mathcal{T}(u) = \{t^{i^*}\}_{i^* \in \mathbb{1}(\mathcal{Z}_n(u)) \cap \frac{1}{2}(\mathcal{Z}_n(z))}$.

This way, by Lemma 2:

$$\begin{aligned}
\bigcap_{t \in \mathcal{T}(u)} \beta(t) &= \bigcap_{i^* \in \mathbb{1}(\mathcal{Z}_n(u)) \cap \frac{1}{2}(\mathcal{Z}_n(z))} \beta(t^{i^*}) \\
&= \bigcap_{i^* \in \mathbb{1}(\mathcal{Z}_n(u)) \cap \frac{1}{2}(\mathcal{Z}_n(z))} \beta \left(\bigotimes_{m \in \llbracket 1, n \rrbracket} t_m^{i^*} \right) \\
&= \bigcap_{i^* \in \mathbb{1}(\mathcal{Z}_n(u)) \cap \frac{1}{2}(\mathcal{Z}_n(z))} \bigotimes_{m \in \llbracket 1, n \rrbracket} \beta(t_m^{i^*}) \\
&= \bigotimes_{m \in \llbracket 1, n \rrbracket} \bigcap_{i^* \in \mathbb{1}(\mathcal{Z}_n(u)) \cap \frac{1}{2}(\mathcal{Z}_n(z))} \beta(t_m^{i^*})
\end{aligned}$$

We want to show that for all $m \in \llbracket 1, n \rrbracket$, $\bigcap_{i^* \in \mathbb{1}(\mathcal{Z}_n(u)) \cap \frac{1}{2}(\mathcal{Z}_n(z))} \beta(t_m^{i^*}) \neq \emptyset$. Since

u belongs to $\beta(z)$, then:

- either $m \in \mathbb{1}(\mathcal{Z}_n(z)) \cup \frac{1}{2}(\mathcal{Z}_n(u))$, then $\mathcal{Z}(u_m) = \mathcal{Z}(z_m)$. And because $m \neq i^*$ for all $i^* \in \mathbb{1}(\mathcal{Z}_n(u)) \cap \frac{1}{2}(\mathcal{Z}_n(z))$, $t_m^{i^*} = z_m = u_m$, and:

$$\bigcap_{i^* \in \mathbb{1}(\mathcal{Z}_n(u)) \cap \frac{1}{2}(\mathcal{Z}_n(z))} \beta(t_m^{i^*}) = \beta(u_m) \neq \emptyset.$$

- or $m \in \mathbb{1}(\mathcal{Z}_n(u)) \cap \frac{1}{2}(\mathcal{Z}_n(z))$, then $\mathcal{Z}(u_m) \in \{\mathcal{Z}(z_m) - \frac{1}{2}, \mathcal{Z}(z_m) + \frac{1}{2}\}$. Then there exists a value $i^* \in \mathbb{1}(\mathcal{Z}_n(u)) \cap \frac{1}{2}(\mathcal{Z}_n(z))$ such that $i^* = m$, for which $\mathcal{Z}(t_m^{i^*}) = \mathcal{Z}(u_m) \in \{\mathcal{Z}(z_m) - \frac{1}{2}, \mathcal{Z}(z_m) + \frac{1}{2}\}$, and then:

$$\begin{aligned}
\bigcap_{i^* \in \mathbb{1}(\mathcal{Z}_n(u)) \cap \frac{1}{2}(\mathcal{Z}_n(z))} \beta(t_m^{i^*}) &= \beta(t_m^m) \cap \bigcap_{i^* \in \mathbb{1}(\mathcal{Z}_n(u)) \cap \frac{1}{2}(\mathcal{Z}_n(z)) \setminus \{m\}} \beta(t_m^{i^*}), \\
&= \beta(u_m) \cap \beta(z_m).
\end{aligned}$$

Two cases are possible. Either $\mathcal{Z}(u_m) = \mathcal{Z}(z_m) - \frac{1}{2}$, then:

$$\begin{aligned}
\beta(u_m) \cap \beta(z_m) &= \beta(\mathcal{H}_n(\mathcal{Z}(z_m) - \frac{1}{2})) \cap \beta(z_m) \\
&= \{\{\mathcal{Z}(z_m) - \frac{1}{2}, \mathcal{Z}(z_m) + \frac{1}{2}\}\} \\
&\quad \cap \left\{ \begin{array}{l} \{\mathcal{Z}(z_m) - 1/2, \mathcal{Z}(z_m) + 1/2\}, \\ \{\mathcal{Z}(z_m) + 1/2\}, \\ \{\mathcal{Z}(z_m) + 1/2, \mathcal{Z}(z_m) + 3/2\} \end{array} \right\} \\
&= \{\{\mathcal{Z}(z_m) - \frac{1}{2}, \mathcal{Z}(z_m) + \frac{1}{2}\}\} \\
&= \beta(u_m) \\
&\neq \emptyset
\end{aligned}$$

Or $\mathcal{Z}(u_m) = \mathcal{Z}(z_m) + \frac{1}{2}$, then:

$$\begin{aligned}
\beta(u_m) \cap \beta(z_m) &= \beta(\mathcal{H}_n(\mathcal{Z}(z_m) + \frac{1}{2})) \cap \beta(z_m) \\
&= \{\{\mathcal{Z}(z_m) + 1/2, \mathcal{Z}(z_m) + 3/2\}\} \\
&\quad \cap \left\{ \begin{array}{l} \{\mathcal{Z}(z_m) - 1/2, \mathcal{Z}(z_m) + 1/2\}, \\ \{\mathcal{Z}(z_m) + 1/2\}, \\ \{\mathcal{Z}(z_m) + 1/2, \mathcal{Z}(z_m) + 3/2\} \end{array} \right\} \\
&= \{\{\mathcal{Z}(z_m) + 1/2, \mathcal{Z}(z_m) + 3/2\}\} \\
&= \beta(u_m) \\
&\neq \emptyset
\end{aligned}$$

This way, for all $m \in \llbracket 1, n \rrbracket$, $\bigcap_{i^* \in \mathbb{1}(\mathcal{Z}_n(u)) \cap \frac{1}{2}(\mathcal{Z}_n(z))} \beta(t_m^{i^*}) \neq \emptyset$, and then

$\bigcap_{t \in \mathcal{T}(u)} \beta(t) \neq \emptyset$, which implies that $\bigvee_{t \in \mathcal{T}(u)} t$ exists in \mathbb{H}^n .

Let us compute now this term, following the calculus made before:

$$\begin{aligned}
\beta\left(\bigvee_{t \in \mathcal{T}(u)} t\right) &= \bigotimes_{m \in \llbracket 1, n \rrbracket} \bigcap_{i^* \in \mathbb{1}(\mathcal{Z}_n(u)) \cap \frac{1}{2}(\mathcal{Z}_n(z))} \beta(t_m^{i^*}) \\
&= \bigotimes_{m \in \llbracket 1, n \rrbracket} \beta(u_m) \\
&= \beta\left(\bigotimes_{m \in \llbracket 1, n \rrbracket} u_m\right) \\
&= \beta(u)
\end{aligned}$$

and then $u = \bigvee_{t \in \mathcal{T}(u)} t$. □

Lemma 25. *Let v, v' be two elements of $\beta^\square(z)$ such that $v \neq v'$. Then $\mathcal{T}(v) \neq \mathcal{T}(v')$.*

Proof: Let us prove the counterposition: if $\mathcal{T}(v) = \mathcal{T}(v')$, by Lemma 24, we obtain $v = v'$. This concludes the proof. □

5.8.14 Counting the k -faces into $\alpha(a) \cap \beta(b)$

Lemma 26. *Let v, f be two faces of \mathbb{H}^n such that $f \in \beta(v)$. For all $k \in \llbracket \dim(v), \dim(f) \rrbracket$:*

$$\text{Card}(\alpha(f) \cap \beta(v) \cap \mathbb{H}_k^n) = C_{\dim(f) - \dim(v)}^{k - \dim(v)}.$$

Proof: We recall that for all $w \in \mathbb{H}^n$, we have:

$$w \in \alpha(f) \cap \beta(v) \Leftrightarrow \left\{ \begin{array}{l} \forall m \in \mathbb{1}(\mathcal{Z}_n(f)) \cap \frac{1}{2}(\mathcal{Z}_n(v)), w_m \in \{v_m, f_m\}, \\ \forall m \in \frac{1}{2}(\mathcal{Z}_n(f)) \cup \mathbb{1}(\mathcal{Z}_n(v)), w_m = v_m (= f_m). \end{array} \right\}.$$

This way, $\dim(v)$ coordinates of $\mathcal{Z}_n(w)$ are integers, $(n - \dim(f))$ coordinates of w are not integers, and the $(\dim(f) - \dim(v))$ remaining coordinates are free to choose between $\mathcal{Z}_n(f)$ (then integers) or the ones of $\mathcal{Z}_n(v)$ (then not integers). Then we have a total number of $C_{\dim(f) - \dim(v)}^{k - \dim(v)}$ faces of dimension k into $\alpha(f) \cap \beta(v)$, since their topological isomorphism into $(\mathbb{Z}/2)^n$ have $(k - \dim(v))$ integral coordinates among the $(\dim(f) - \dim(v))$ coordinates not fixed by advance. □

5.8.15 Minimal number of $(\dim(z) + 1)$ -faces into F_i

Property 25. *Using Notations 10, for all $i \in \mathcal{I}$, F_i contains at least $(n - \dim(z)) (\dim(z) + 1)$ -faces.*

Proof: Let i be in \mathcal{I} , then for all $m \in \llbracket \dim(z) + 1, n - 1 \rrbracket$, $F_i \cap \mathbb{H}_m^n \neq \emptyset$ by Property 24. This way, there exists $t \in \mathbb{H}_{n-2}^n \cap F_i$, and because F_i is a $(n - 2 - \dim(z))$ -surface, $|\beta_{F_i}^\square(t)|$ is a $((n - \dim(z) - 2) - \rho(v, |F_i|) - 1) = 0$ -surface by Lemma 21. Then there exists $v, v' \in \mathbb{H}_{n-1}^n \cap F_i$ such that $v \notin \theta(v')$. However, $\alpha(v) \cap \beta^\square(z)$ and $\alpha(v') \cap \beta^\square(z)$ contain both $(n - \dim(z) - 1)$ $(\dim(z) + 1)$ -faces (cf. Lemma 26), and $v \neq v'$ implies that $\mathcal{T}(v) \neq \mathcal{T}(v')$ (cf. Lemma 25), and then there exists at least one face into $\mathcal{T}(v')$ which is not among the $(n - \dim(z) - 1)$ faces of $\mathcal{T}(v)$. However, $\mathcal{T}(v) \cup \mathcal{T}(v') \subseteq F_i$ (because F_i is closed into $\beta^\square(z)$). This way, $F_i \cap \mathbb{H}_{\dim(z)+1}^n$ contains at least $(n - \dim(z))$ faces. □

5.8.16 Exact number of $(\dim(z) + 1)$ -faces into F_i

Property 26. *Using Notations 10, for all $i \in \mathcal{I}$, F_i contains exactly $(n - \dim(z)) (\dim(z) + 1)$ -faces.*

Proof: This is the direct consequence of Property 21 and Property 25. □

5.8.17 Decomposing components $\mathcal{T}(F_i)$

From now on, for each $i \in \mathcal{I}$, we define:

$$\mathcal{T}(F_i) = F_i \cap \mathbb{H}_{\dim(z)+1}^n.$$

Property 27. *Using Notations 10, for all $i \in \mathcal{I}$, $\mathcal{T}(F_i)$ can be represented as an union of faces $\{t^m\}_{m \in \frac{1}{2}(\mathcal{Z}_n(z))}$ defined such that for all $m \in \frac{1}{2}(\mathcal{Z}_n(z))$:*

$$\mathcal{Z}_n(t^m) = \mathcal{Z}_n(z) + \lambda_m e^m,$$

with $\lambda_m \in \{-\frac{1}{2}, \frac{1}{2}\}$.

Proof: for each $m \in \frac{1}{2}(\mathcal{Z}_n(z))$, $\mathcal{H}_n(\mathcal{Z}_n(z) - \frac{1}{2}e^m)$ and $\mathcal{H}_n(\mathcal{Z}_n(z) + \frac{1}{2}e^m)$ belong to $\beta^\square(z)$. Then for all $m \in \frac{1}{2}(\mathcal{Z}_n(z))$, we have the possible cases:

- either $\mathcal{H}_n(\mathcal{Z}_n(z) - \frac{1}{2}e^m) \in \mathcal{T}(F_i)$, and then $\mathcal{H}_n(\mathcal{Z}_n(z) + \frac{1}{2}e^m) \notin \mathcal{T}(F_i)$ (by Property 20) (P1)
- or $\mathcal{H}_n(\mathcal{Z}_n(z) + \frac{1}{2}e^m) \in \mathcal{T}(F_i)$, and then $\mathcal{H}_n(\mathcal{Z}_n(z) - \frac{1}{2}e^m) \notin \mathcal{T}(F_i)$ (for the same reason as before) (P2)
- or $\{\mathcal{H}_n(\mathcal{Z}_n(z) - \frac{1}{2}e^m), \mathcal{H}_n(\mathcal{Z}_n(z) + \frac{1}{2}e^m)\} \cap \mathcal{T}(F_i) = \emptyset$ (P3)

By (P1) and (P2), we have at most $(n - \dim(z))$ faces into $\mathcal{T}(F_i) \subseteq \beta^\square(z)$. If there exists a coordinate $m \in \frac{1}{2}(\mathcal{Z}_n(z))$ such that (P3) is true, we will have less than $(n - \dim(z))$ $(\dim(z) + 1)$ -faces into $\mathcal{T}(F_i)$, what is impossible by Property 25, then (P3) is never verified. We have then either (P1) or (P2) for each $m \in \frac{1}{2}(\mathcal{Z}_n(z))$. This way, there exists for each $m \in \frac{1}{2}(\mathcal{Z}_n(z))$ one only $\lambda_m \in \{-\frac{1}{2}, \frac{1}{2}\}$ such that $\mathcal{H}_n(\mathcal{Z}_n(z) + \lambda_m e^m) \in \mathcal{T}(F_i)$, then $\{\mathcal{H}_n(\mathcal{Z}_n(z) + \lambda_m e^m)\}_{m \in \frac{1}{2}(\mathcal{Z}_n(z))} \subseteq \mathcal{T}(F_i)$. Since these two sets have $(n - \dim(z))$ faces and since they verify a inclusion relationship, they are equal, and then $\{\mathcal{H}_n(\mathcal{Z}_n(z) + \lambda_m e_m)\}_{m \in \frac{1}{2}(\mathcal{Z}_n(z))} = \mathcal{T}(F_i)$. \square

5.8.18 Characteristical points of each F_i

Property 28. Using Notations 10, for all $i \in \mathcal{I}$, $\bigvee_{t \in \mathcal{T}(F_i)} t$ exists.

Proof: Let i be a coordinate in \mathcal{I} . It is sufficient to show that:

$$\bigcap_{t \in \mathcal{T}(F_i)} \beta(t) \neq \emptyset.$$

By Property 27, there exists a family of faces $\{t^m\}_{m \in \frac{1}{2}(\mathcal{Z}_n(z))} = \mathcal{T}(F_i)$ such that for all $m \in \frac{1}{2}(\mathcal{Z}_n(z))$, $\mathcal{Z}_n(t^m) = \mathcal{Z}_n(z) + \lambda_m e^m$ with $\lambda_m \in \{\frac{1}{2}, -\frac{1}{2}\}$. This way:

$$\begin{aligned}
\bigcap_{t \in \mathcal{T}(F_i)} \beta(t) &= \bigcap_{m \in \frac{1}{2}(\mathcal{Z}_n(z))} \beta(t^m), \\
&= \bigcap_{m \in \frac{1}{2}(\mathcal{Z}_n(z))} \beta \left(\bigotimes_{j \in \llbracket 1, n \rrbracket} t_j^m \right), \\
&= \bigcap_{m \in \frac{1}{2}(\mathcal{Z}_n(z))} \bigotimes_{j \in \llbracket 1, n \rrbracket} \beta(t_j^m), \\
&= \bigotimes_{j \in \llbracket 1, n \rrbracket} \bigcap_{m \in \frac{1}{2}(\mathcal{Z}_n(z))} \beta(t_j^m).
\end{aligned}$$

When j belongs to $\mathbb{1}(\mathcal{Z}_n(z))$, we obtain $t_j^m = z_j$ (because t^m belongs to $\beta(z)$). Then $\bigcap_{m \in \frac{1}{2}(\mathcal{Z}_n(z))} \beta(t_j^m) = \beta(z_j) \neq \emptyset$.

When j belongs to $\frac{1}{2}(\mathcal{Z}_n(z))$,

$$\begin{aligned}
\bigcap_{m \in \frac{1}{2}(\mathcal{Z}_n(z))} \beta(t_j^m) &= \left(\bigcap_{m \in \frac{1}{2}(\mathcal{Z}_n(z)) \setminus \{j\}} \beta(t_j^m) \right) \cap \beta(t_j^j), \\
&= \beta(z_j) \cap \beta(\mathcal{H}(\mathcal{Z}(z_j) + \lambda_j)), \\
&= \{ \{ \mathcal{Z}(z_j) + \frac{1}{2} \}, \{ \mathcal{Z}(z_j) - \frac{1}{2}, \mathcal{Z}(z_j) + \frac{1}{2} \}, \{ \mathcal{Z}(z_j) + \frac{1}{2}, \mathcal{Z}(z_j) + 3/2 \} \}, \\
&\quad \cap \{ \{ \mathcal{Z}(z_j) + \lambda_j, \mathcal{Z}(z_j) + \lambda_j + 1 \} \}, \\
&= \{ \{ \mathcal{Z}(z_j) + \lambda_j, \mathcal{Z}(z_j) + \lambda_j + 1 \} \}, \\
&= \beta(t_j^j), \\
&\neq \emptyset.
\end{aligned}$$

Then each term $\bigcap_{m \in \frac{1}{2}(\mathcal{Z}_n(z))} \beta(t_j^m)$ is non empty, and then $\bigcap_{t \in \mathcal{T}(F_i)} \beta(t) \neq \emptyset$. □

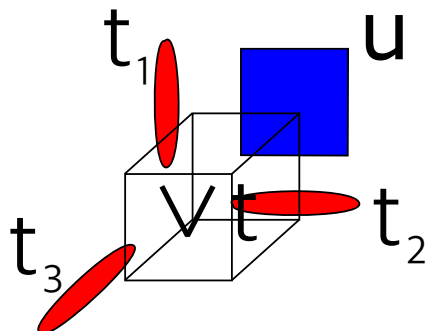

Figure 5.22: Each component F_i is contained into the closure of its “characteristical point”.

5.8.19 F_i is contained in the closure of its characteristical point

Property 29. *Using Notations 10, for each $i \in \mathcal{I}$:*

$$F_i \subseteq \alpha \left(\bigvee_{t \in \mathcal{T}(F_i)} t \right).$$

Proof: Let us begin with an intuitive explanation of this property in the 3D case using Figure 5.22. Let t_1, t_2, t_3 be three different $(\dim(z) + 1)$ -faces into F_i such they are not opposite the one to the other one. Let us define $u = t_1 \vee t_2$. It follows that $\bigvee_{t \in \mathcal{T}(F_i)} t = u \vee t_3$, and this way $u \in \alpha \left(\bigvee_{t \in \mathcal{T}(F_i)} t \right)$. We can pursue the reasoning by decomposing each face u of F_i by its $(\dim(z) + 1)$ -faces. F_i is then included into $\alpha \left(\bigvee_{t \in \mathcal{T}(F_i)} t \right)$.

Now, let us be more formal: let u be in F_i , $u \in \beta^\square(z)$, and then by Lemma 24, $u = \bigvee_{t \in \mathcal{T}(u)} t$. Since F_i is closed into $\beta^\square(z)$, $\alpha(u) \cap \beta^\square(z) \subseteq F_i$ and then $\mathcal{T}(u) \subseteq \mathcal{T}(F_i)$. This way,

$$\bigvee_{t \in \mathcal{T}(F_i)} t = \bigvee_{t \in \mathcal{T}(u)} t \bigvee \bigvee_{t \in \mathcal{T}(F_i) \setminus \mathcal{T}(u)} t = u \bigvee \bigvee_{t \in \mathcal{T}(F_i) \setminus \mathcal{T}(u)} t,$$

which implies that $\bigvee_{t \in \mathcal{T}(F_i)} t \in \beta(u)$ and then $u \in \alpha \left(\bigvee_{t \in \mathcal{T}(F_i)} t \right)$, from which we can deduce that $F_i \subseteq \alpha \left(\bigvee_{t \in \mathcal{T}(F_i)} t \right)$. □

5.8.20 Structure of components F_i

Property 30. *Using Notations 10, for each $i \in \mathcal{I}$:*

$$F_i = \alpha^\square \left(\bigvee_{t \in \mathcal{T}(F_i)} t \right) \cap \beta^\square(z).$$

Proof: Let i be a coordinate in \mathcal{I} . Then $F_i \subseteq \beta^\square(z)$, which implies by Property 29 that $F_i \subseteq \alpha \left(\bigvee_{t \in \mathcal{T}(F_i)} t \right) \cap \beta^\square(z)$. Nevertheless, $\bigvee_{t \in \mathcal{T}(F_i)} t$ belongs to \mathbb{H}_n^n because $\text{Card}(\mathcal{T}(F_i)) = (n - \dim(z))$ and because the faces of $\mathcal{T}(F_i)$ are different two by two. Also, $F_i \cap \mathbb{H}_n^n = \emptyset$, and then we have $F_i \subseteq \alpha^\square \left(\bigvee_{t \in \mathcal{T}(F_i)} t \right) \cap \beta^\square(z)$. Since $\bigvee_{t \in \mathcal{T}(F_i)} t \in \beta^\square(z)$ (by transitivity of β), $\alpha^\square \left(\bigvee_{t \in \mathcal{T}(F_i)} t \right) \cap \beta^\square(z)$ is a $(n - \dim(z) - 2)$ -surface by Proposition 20. This is also the case concerning F_i by Property 19. This way, $F_i = \alpha^\square \left(\bigvee_{t \in \mathcal{T}(F_i)} t \right) \cap \beta^\square(z)$ by Theorem 9. □

Number of components of $|\beta_{\mathfrak{M}}^\square(z)|$ (if not connected)

Property 31. *Using Notations 10:*

$$\text{Card}(\mathcal{I}) = 2.$$

Proof: The non connectivity of $|\beta_{\mathfrak{N}}^{\square}(z)|$ implies obviously that $\text{Card}(\mathcal{I}) \geq 2$. Moreover, for each $i \in \mathcal{I}$, F_i contains $(n - \dim(z)) (\dim(z) + 1)$ -faces, while $\beta^{\square}(z)$ contains $2(n - \dim(z)) (\dim(z) + 1)$ -faces, the maximum of components of $|\beta_{\mathfrak{N}}^{\square}(z)|$ s then equal to two. □

5.8.21 The two characteristical points of $|\beta_{\mathfrak{N}}^{\square}(z)|$

From now on, we will use the following notation:

Notations 14. Using Notations 10, we denote also:

$$\mathbf{a} = \bigvee_{t \in \mathcal{T}(F_1)} t, \text{ and } \mathbf{b} = \bigvee_{t \in \mathcal{T}(F_2)} t.$$

5.8.22 $\mathcal{Z}_n(\mathbf{a})$ and $\mathcal{Z}_n(\mathbf{b})$ are $(n - \dim(z))$ -antagonist

Lemma 27. Let us assume that $n \geq 2$. Let z be in \mathbb{H}^n such that $\dim(z) \leq n - 2$, and let a, b be in $\mathbb{H}_n^n \cap \beta^{\square}(z)$. Then $\alpha^{\square}(a) \cap \alpha^{\square}(b) \cap \beta^{\square}(z) = \emptyset$ implies that $\mathcal{Z}_n(a)$ and $\mathcal{Z}_n(b)$ are $(n - \dim(z))$ -antagonist into \mathbb{Z}^n .

Proof: $a, b \in \beta^{\square}(z)$ implies that $z \in \alpha^{\square}(a) \cap \alpha^{\square}(b)$, and then $\alpha(a) \cap \alpha(b) \neq \emptyset$, which implies that $a \wedge b$ exists and $\alpha(a) \cap \alpha(b) = \alpha(a \wedge b)$ by Lemma 7. This way, $z \in \alpha^{\square}(a) \cap \alpha^{\square}(b) \subseteq \alpha(a \wedge b)$, and then $a \wedge b \in \beta(z)$. Let us assume that we have $a = b$. Then $\alpha^{\square}(a) \cap \alpha^{\square}(b) \cap \beta^{\square}(z) = \alpha^{\square}(a) \cap \beta^{\square}(z)$ is a $(n - \dim(z) - 2)$ -surface by Proposition 20, and then is non empty (because $(n - \dim(z)) \geq 2$). This is impossible by hypothesis, and then we have $a \neq b$. Since a and b are different and they are both into \mathbb{H}_n^n , they are not neighbors and this way $\alpha^{\square}(a) \cap \alpha^{\square}(b) = \alpha(a) \cap \alpha(b) = \alpha(a \wedge b)$. We obtain that $\alpha(a \wedge b) \cap \beta^{\square}(z) = \emptyset$. We have seen that $z \in \alpha(a \wedge b)$, then $(\alpha(a \wedge b) \cap \beta^{\square}(z)) \cup \{z\} = \alpha(a \wedge b) \cap \beta(z) = \{z\}$, and then $z = a \wedge b$. By Lemma 8, we deduce that $\mathcal{Z}_n(a)$ and $\mathcal{Z}_n(b)$ are $(n - \dim(z))$ -antagonist. □

Property 32. Using Notations 14, $\mathcal{Z}_n(\mathbf{a})$ and $\mathcal{Z}_n(\mathbf{b})$ are $(n - \dim(z))$ -antagonist in \mathbb{Z}^n .

Proof: Since $F_1 = \alpha^\square(\mathbf{a}) \cap \beta^\square(z)$ and $F_2 = \alpha^\square(\mathbf{b}) \cap \beta^\square(z)$ are disjoint,

$$\alpha^\square(\mathbf{a}) \cap \alpha^\square(\mathbf{b}) \cap \beta^\square(z) = \emptyset.$$

By Lemma 27, $\mathcal{Z}_n(\mathbf{a})$ and $\mathcal{Z}_n(\mathbf{b})$ are then $(n - \dim(z))$ -antagonist. □

5.8.23 Connectivity of $S(z) \setminus \{\mathcal{Z}_n(\mathbf{a}), \mathcal{Z}_n(\mathbf{b})\}$ ($\dim(z) \leq (n - 3)$)

Lemma 28. *Let $n \geq 3$ be an integer. Let z be in \mathbb{H}^n such that $\dim(z) \leq n - 3$, and let a, b be in $S(z)$ such that $a = \text{antag}_{S(z)}(b)$. Then $S(z) \setminus \{a, b\}$ is $2n$ -connected into \mathbb{Z}^n .*

Proof: let x, y be in $S(z) \setminus \{a, b\}$ with $x \neq y$. Then there exists a value $k \in \llbracket 1, n - \dim(z) \rrbracket$ such that x and y are k -antagonist (since they belong to the block $S(z)$ of dimension $(n - \dim(z))$). Let us now proceed by induction on the value of k .

Initialization ($k = 1$): when x and y are 1-antagonist in \mathbb{Z}^n , they are $2n$ -neighbors and then there exists a $2n$ -path π joining them into $S(z) \setminus \{a, b\}$ such that $\pi = (x, y)$.

Induction ($k \in \llbracket 2, n - \dim(z) \rrbracket$): we assume that for all the elements x, y in $S(z) \setminus \{a, b\}$ such that they are $(k - 1)$ -antagonist into $S(z)$, there exists a $2n$ -path joining them into $S(z) \setminus \{a, b\}$. Let us show that when x and y are k -antagonist, x and y are $2n$ -connected into $S(z) \setminus \{a, b\}$. By hypothesis, x and y are k -antagonist with $k \geq 2$ and belong to $S(z)$, then they are antagonist in a block $S \subseteq S(z)$ of dimension k . This way, x admits in S a total number of k $2n$ -neighbors (which are different from itself) where at most one is into $\{a, b\}$. Effectively, if a and b were both neighbors of x , they would be identical or 2-antagonists. These two cases are impossible since a and b are $(n - \dim(z))$ -antagonist with $(n - \dim(z)) \geq 3$. Then there exists a $2n$ -neighbor v_x of x into $S \setminus \{a, b\}$. v_x is then $(k - 1)$ -antagonist of y and $2n$ -neighbor of x , then x and y are connected into $S(z) \setminus \{a, b\}$ thanks to the induction hypothesis. □

5.8.24 $S(z)$ contains a critical configuration

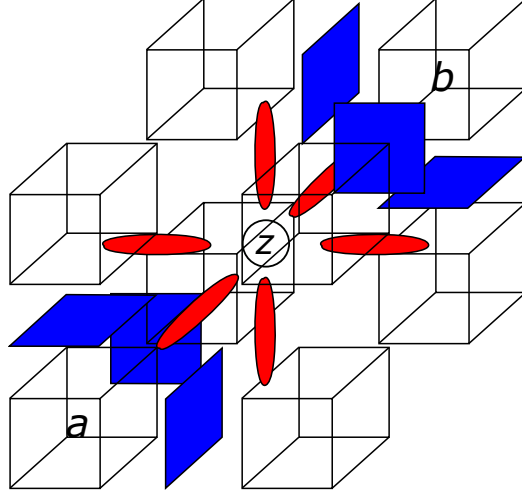

Figure 5.23: Structure of $\beta_{\mathfrak{N}}^{\square}(z)$ when we have $(n - \dim(z)) = 3$ assuming that $|\beta_{\mathfrak{N}}^{\square}(z)|$ is not connected.

Property 33. *Using Notations 14, $S(z)$ contains a critical configuration (either primary or secondary) of dimension $(n - \dim(z))$, i.e., either we have $X \cap S(z) = \{\mathcal{Z}_n(\mathbf{a}), \mathcal{Z}_n(\mathbf{b})\}$ or we have $X \cap S(z) = S(z) \setminus \{\mathcal{Z}_n(\mathbf{a}), \mathcal{Z}_n(\mathbf{b})\}$.*

Proof: Let u, v be in $S(z) \setminus \{\mathcal{Z}_n(\mathbf{a}), \mathcal{Z}_n(\mathbf{b})\}$. Since this set is $2n$ -connected for $(n - \dim(z)) \geq 3$ by Lemma 28, there exists a $2n$ -path $\pi = (p^0 = u, \dots, p^l = v)$ joining u and v into $S(z) \setminus \{\mathcal{Z}_n(\mathbf{a}), \mathcal{Z}_n(\mathbf{b})\}$ with $l \geq 1$. We can deduce from it a path π' into \mathbb{H}^n such that:

$$\pi' = (\mathcal{H}_n(p^0), \mathcal{H}_n(p^0) \wedge \mathcal{H}_n(p^1), \mathcal{H}_n(p^1), \dots, \mathcal{H}_n(p^{l-1}), \mathcal{H}_n(p^{l-1}) \wedge \mathcal{H}_n(p^l), \mathcal{H}_n(p^l)).$$

For all m into $\llbracket 0, l-1 \rrbracket$, we have $\mathcal{H}_n(p^{m-1}) \wedge \mathcal{H}_n(p^m) \in \mathbb{H}_{n-1}^n$ since p^{m-1} and p^m are $2n$ -neighbors into \mathbb{Z}^n .

Let us assume now that there exists a value $m \in \llbracket 0, l-1 \rrbracket$ such that $\mathcal{H}_n(p^{m-1}) \wedge \mathcal{H}_n(p^m) \in \mathfrak{N}$, then $\mathcal{H}_n(p^{m-1}) \wedge \mathcal{H}_n(p^m) \in \beta_{\mathfrak{N}}^{\square}(z)$ and then:

- either $\mathcal{H}_n(p^{m-1}) \wedge \mathcal{H}_n(p^m) \in \alpha^{\square}(\mathbf{a}) \cap \beta^{\square}(z)$ and then

$$\beta^{\square}(\mathcal{H}_n(p^{m-1}) \wedge \mathcal{H}_n(p^m)) = \{\mathcal{H}_n(p^{m-1}), \mathcal{H}_n(p^m)\}$$

contains \mathbf{a} , which is impossible by definition of π ,

- or $\mathcal{H}_n(p^{m-1}) \wedge \mathcal{H}_n(p^m) \in \alpha^\square(\mathbf{b}) \cap \beta^\square(z)$ and then

$$\beta^\square(\mathcal{H}_n(p^{m-1}) \wedge \mathcal{H}_n(p^m)) = \{\mathcal{H}_n(p^{m-1}), \mathcal{H}_n(p^m)\}$$

contains \mathbf{b} , which is impossible for the same reason.

This way, $\mathcal{H}_n(p^{m-1}) \wedge \mathcal{H}_n(p^m) \notin \mathfrak{N}$, and then either all the points of π belong to X or they all belong to Y . In other words, either $S(z) \setminus \{\mathcal{Z}_n(\mathbf{a}), \mathcal{Z}_n(\mathbf{b})\} \subseteq X$ or $S(z) \setminus \{\mathcal{Z}_n(\mathbf{a}), \mathcal{Z}_n(\mathbf{b})\} \subseteq Y$.

Now, let $v^{\mathbf{a}}$ be a $2n$ -neighbor of $\mathcal{Z}_n(\mathbf{a})$ (in $S(z) \setminus \{\mathcal{Z}_n(\mathbf{a}), \mathcal{Z}_n(\mathbf{b})\}$) and let $v^{\mathbf{b}}$ be a $2n$ -neighbor of $\mathcal{Z}_n(\mathbf{b})$ (into $S(z) \setminus \{\mathcal{Z}_n(\mathbf{a}), \mathcal{Z}_n(\mathbf{b})\}$). Then $\mathcal{H}_n(v^{\mathbf{a}}) \wedge \mathbf{a}$ and $\mathcal{H}_n(v^{\mathbf{b}}) \wedge \mathbf{b}$ belong to \mathfrak{N} (because they belong to $\beta_{\mathfrak{N}}^\square(z)$) and then we have the two possible configurations: either $\mathcal{Z}_n(\mathbf{a}) \in X$, then $v^{\mathbf{a}} \in Y$, from which we deduce that $v^{\mathbf{b}} \in Y$, and then $\mathcal{Z}_n(\mathbf{b}) \in X$ (and X contains a primary critical configuration), or $\mathcal{Z}_n(\mathbf{a}) \in Y$, then $v^{\mathbf{a}} \in X$, from which we deduce that $v^{\mathbf{b}} \in X$, and then $\mathcal{Z}_n(\mathbf{b}) \in Y$ (and X contains a secondary critical configuration). In both cases, we obtain a critical configuration. \square

Figure 5.23 shows the structure of $\beta_{\mathfrak{N}}^\square(z)$ when we have $(n - \dim(z)) = 3$, assuming that $|\beta_{\mathfrak{N}}^\square(z)|$ is not connected. We can observe that $|\beta_{\mathfrak{N}}^\square(z)|$ is the disjoint union of two 1-surfaces $|F_1| = |\alpha^\square(\mathbf{a}) \cap \beta^\square(z)|$ and $|F_2| = |\alpha^\square(\mathbf{b}) \cap \beta^\square(z)|$.

5.8.25 Summary of the direct sense.

We obtain the contradiction we were looking for, that is, X contains a critical configuration in $S(z)$, which is impossible since X is assumed to be digitally well-composed. $|\beta_{\mathfrak{N}}^\square(z)|$ is then connected, which means that (\mathcal{P}'_k) is true, and then $\mathcal{I}MM(X)$ is AWC. The direct implication is then proven.

5.8.26 Conclusion for sets

Theorem 11 (AWC VS DWC [Not Verified]). *A set $X \subset \mathbb{Z}^n$ is DWC iff its immersion $\mathcal{I}MM(X) = \text{Int}(\alpha(\mathcal{H}_n(X))) \subseteq \mathbb{H}^n$ into the Khalimsky grids $|\mathbb{H}^n|$ is AWC, that is, is such that the connected components of its topological boundary are disjoint $(n - 1)$ -surfaces.*

Summarily, the AWCness of a set is equivalent to the DWCness because of three main reasons: firstly, we can use the cartesian product in \mathbb{Z}^n and in \mathbb{H}_n^n in the same way (we can “decompose” cells thanks to their projections), and that is why well-composednesses in these two spaces are equivalent; secondly, cubical grids have regularity properties that characterize them (for example, they are *locally finite*, that is, any neighborhood in \mathbb{Z}^n like in \mathbb{H}^n has a finite cardinal, and so on); thirdly, we have proven that the two spaces where lies the studied sets are topologically isomorph, and then these spaces (and then the subspaces X and \mathcal{X}) have the same topological structure.

5.8.27 Conclusion for plain maps

Starting from a function $u : \mathbb{Z}^n \rightarrow \mathbb{R}$, we can compute its *immersion* $U = \mathcal{I}\mathcal{M}\mathcal{M}(u) : \mathbb{H}^n \rightsquigarrow \mathbb{R}$ into the Khalimsky grids, defined in the following manner:

Definition 63 (Immersion of an image). *Let $u : \mathbb{Z}^n \rightarrow \mathbb{R}$ be a function on \mathbb{Z}^n . Then we define its immersion $U = \mathcal{I}\mathcal{M}\mathcal{M}(u) : \mathbb{H}^n \rightsquigarrow \mathbb{R}$ into the Khalimsky grids such that:*

$$\forall h \in \mathbb{H}^n, U(h) = \begin{cases} \{u(\mathcal{Z}_n(h))\} & \text{if } z \in \mathbb{H}_n^n, \\ \text{Span} \{U(q) ; q \in \beta(z) \cap \mathbb{H}_n^n\} & \text{either .} \end{cases}$$

This leads us to the following theorem:

Theorem 12 (AWC VS DWC [Not Verified]). *A real-valued image $u : \mathbb{Z}^n \rightarrow \mathbb{R}$ is DWC iff its immersion $U = \mathcal{I}\mathcal{M}\mathcal{M}(u) : \mathbb{H}^n \rightsquigarrow \mathbb{R}$ into the Khalimsky grids is AWC.*

Proof: If U is AWC, then for any $\lambda \in \mathbb{R}$ $[U \triangleright \lambda]$ is AWC. Yet, $[U \triangleright \lambda] = \mathcal{I}\mathcal{M}\mathcal{M}([u > \lambda])$, which implies that $\mathcal{I}\mathcal{M}\mathcal{M}([u > \lambda])$ is AWC, and then $[u > \lambda]$ is DWC. u is then DWC.

Conversely, if u is DWC, then for any $\lambda \in \mathbb{R}$, $[u \geq \lambda]$ is DWC, and then $\mathcal{I}\mathcal{M}\mathcal{M}([u \geq \lambda])$ is AWC, which implies that $\alpha(\mathcal{I}\mathcal{M}\mathcal{M}([u \geq \lambda]))$ (they both have the same boundaries). Yet, $[U \triangleright \lambda] = \alpha(\mathcal{I}\mathcal{M}\mathcal{M}([u \geq \lambda]))$, and then is AWC too. u DWC implies also that $[u > \lambda]$ is DWC, which implies that $\mathcal{I}\mathcal{M}\mathcal{M}([u > \lambda]) = [U \triangleright \lambda]$ is AWC. By a dual reasoning, we obtain that $[U \triangleleft \lambda]$ and $[U \triangleleft \lambda]$ are AWC too, which shows that U is AWC. \square

Chapter 6

Conclusion

In this report, we prove that AWCness and DWCness equivalent in n -D, and not only in 2D and 3D. This means that the usual digital subsets of \mathbb{Z}^n that are DWC can be immersed in \mathbb{H}^n and the connected components of their boundaries will be discrete surfaces. Conversely, if any subset verifies that its immersion is AWC, we will know that this set is DWC. This equivalence holds for images thanks to threshold sets: an image u defined on \mathbb{Z}^n will be DWC iff its immersion in \mathbb{H}^n is AWC.

Bibliography

- [1] Pavel S Aleksandrov. *Combinatorial topology*, volume 1. Courier Corporation, 1956.
- [2] James W Alexander. The combinatorial theory of complexes. *Annals of Mathematics*, pages 292–320, 1930.
- [3] Paul Alexandroff and Heinz Hopf. *Topologie I: Erster Band. Grundbegriffe der Mengentheoretischen Topologie Topologie der Komplexe Topologische Invarianzsätze und Anschliessende Begriffsbildungen. Verschlingungen im n-Dimensionalen Euklidischen Raum Stetige Abbildungen von Polyedern*. Springer-Verlag, 2013.
- [4] P.S. Alexandrov. Diskrete räume. *Mat. Sb.*, 2(44):501–519, 1937.
- [5] Jean-Pierre Aubin and Hélène Frankowska. *Set-valued analysis*. Springer Science & Business Media, 2009.
- [6] Gilles Bertrand. New notions for discrete topology. In *Discrete Geometry for Computer Imagery*, pages 218–228. Springer, 1999.
- [7] Gilles Bertrand, Jean-Christophe Everat, and Michel Couprie. Topological approach to image segmentation. In *SPIE's 1996 International Symposium on Optical Science, Engineering, and Instrumentation*, pages 65–76. International Society for Optics and Photonics, 1996.
- [8] Gilles Bertrand, Jean-Christophe Everat, and Michel Couprie. Image segmentation through operators based on topology. *Journal of Electronic Imaging*, 6(4):395–405, 1997.
- [9] Serge Beucher and Fernand Meyer. The morphological approach to segmentation: the watershed transformation. *Optical Engineering - New York - Marcel Dekker Incorporated* -, 34:433–433, 1992.

- [10] Nicolas Boutry, Thierry Géraud, and Laurent Najman. How to make n -D functions digitally well-composed in a self-dual way. In *International Symposium on Mathematical Morphology and Its Applications to Signal and Image Processing*, pages 561–572. Springer, 2015.
- [11] Xavier Daragon. *Surfaces discrètes et frontières d’objets dans les ordres*. PhD thesis, Marne-la-Vallée, 2005.
- [12] Ulrich Eckhardt and Longin Latecki. *Digital topology*. Inst. für Angewandte Mathematik, 1994.
- [13] Alexander V Evako, Ralph Kopperman, and Yurii V Mukhin. Dimensional properties of graphs and digital spaces. *Journal of Mathematical Imaging and Vision*, 6(2-3):109–119, 1996.
- [14] John FP Hudson. Piecewise linear topology. *New York*, 1969.
- [15] John L Kelley. General topology. the university series in higher mathematics, 1955.
- [16] Efim Khalimsky, Ralph Kopperman, and Paul R Meyer. Computer graphics and connected topologies on finite ordered sets. *Topology and its Applications*, 36(1):1–17, 1990.
- [17] LJ Latecki. Well-composed sets. *ADVANCES IN IMAGING AND ELECTRON PHYSICS, VOL 112*, 112:95–163, 2000.
- [18] William Bernard Raymond Lickorish. Simplicial moves on complexes and manifolds. *Geometry and Topology Monographs*, 2(299-320):314, 1999.
- [19] Loïc Mazo, Nicolas Passat, Michel Couprie, and Christian Ronse. Digital imaging: A unified topological framework. *Journal of Mathematical Imaging and Vision*, 44(1):19–37, 2012.
- [20] Fernand Meyer. Skeletons and perceptual graphs. *Signal Processing*, 16(4):335–363, 1989.
- [21] Laurent Najman and Thierry Géraud. Discrete set-valued continuity and interpolation. In *Mathematical Morphology and Its Applications to Signal and Image Processing*, pages 37–48. Springer, 2013.