



HAL
open science

2 MHz high-density integrated power supply for gate driver in high-temperature applications

Remi Perrin, Bruno Allard, Cyril Buttay, Nicolas Quentin, Wenli Zhang, Rolando Burgos, Dushan Boroyevich, Philippe Preciat, Donatien Martineau

► **To cite this version:**

Remi Perrin, Bruno Allard, Cyril Buttay, Nicolas Quentin, Wenli Zhang, et al.. 2 MHz high-density integrated power supply for gate driver in high-temperature applications. APEC, Mar 2016, Long Beach, CA, United States. 10.1109/APEC.2016.7467922 . hal-01372141

HAL Id: hal-01372141

<https://hal.science/hal-01372141v1>

Submitted on 26 Sep 2016

HAL is a multi-disciplinary open access archive for the deposit and dissemination of scientific research documents, whether they are published or not. The documents may come from teaching and research institutions in France or abroad, or from public or private research centers.

L'archive ouverte pluridisciplinaire **HAL**, est destinée au dépôt et à la diffusion de documents scientifiques de niveau recherche, publiés ou non, émanant des établissements d'enseignement et de recherche français ou étrangers, des laboratoires publics ou privés.

2 MHz High-Density Integrated Power Supply for Gate Driver in High-Temperature Applications

Remi Perrin, Bruno Allard,
Cyril Buttay and Nicolas Quentin
Univ. Lyon, Ampere, INSA Lyon,
CNRS UMR 5005
21 avenue Jean Capelle,
France-69621 Villeurbanne

Wenli Zhang, Rolando Burgos and
Dushan Boroyevic
CPES - Virginia Tech
1185 Perry Street
Blacksburg, VA 24061
USA

Philippe Preciat and
Donatien Martineau
SAFRAN Labinal Power Systems
Rond Point Ren-Ravaud - BP42
77551 Moissy-Cramayel
France

Abstract—A PCB embedded transformer for harsh environment (i.e., ambient temperature above 200 °C) applications is presented and used in the design of a 2 MHz integrated power-supply prototype for gate driver. The main benefits of using this developed PCB embedding process are the capability to customize the air-gap for the flyback transformer and volume reduction for the converter. The easy modulation of the air-gap distance can be achieved using PCB material in specific thickness. Moreover, the design of a coplanar-winding transformer structure with very low inter-winding capacitance needs a large winding area and raises the interest for the PCB integration approach. Two-machined ferrite pieces in UI shape were sandwiched into a multi-layer PCB laminate with multiple pressing processes. A converter prototype built with the PCB embedded transformer and other components (GaN transistors, gate driver and passives) mounted above it shows 72% of power efficiency. One thousand thermal cycles between -55°C and 200°C were performed on the PCB embedded transformer without observation of any major defects, such as delamination and cracking. The thermal reliability test validates the compatibility between the selected ferrite core and PCB materials as well as the feasibility of this developed transformer embedding method. A three-time volume reduction is achieved when comparing with a benchmark converter prototype using discrete transformer.

I. INTRODUCTION

The integration of passive components is a key enabler for high-power-density power supply [1], [2]. The low-cost printed circuit board (PCB) is the most widely used substrate material in electronic applications. The PCB material selected as the substrate material to integrate a high power-density converter is mainly because of its capability for high-volume production using standard lamination process. The use of wide-band gap power transistors switched at above 1 MHz with soft-switching topology is favorable to reduce the size of passive components and thus to make it possible to embed passives into PCB substrate [3], [4].

Two methods for fabrication of PCB embedded transformers have been reported in [5]–[7]. The first approach introduces the use of a toroidal-shape core inside a PCB. The conductive vias and traces as winding are wrapped around the core formed by standard etching, drilling and plating processes. However, the reliability of the assembly against temperature variation is compromised due to the large number of winding vias. Additionally, this structure with the external windings generates a significant magnetic field emission, which cannot

fit with the aeronautical standard.

The second method is to pot the soft magnetic composite materials around conductive winding for the transformer fabrication. The transformer is connected by pin connection to a PCB stack with the active layer. But the low operating temperature of this soft magnetic material makes it not suitable for high-temperature ($> 200^{\circ}\text{C}$) applications.

A series of studies have been performed on the realization of

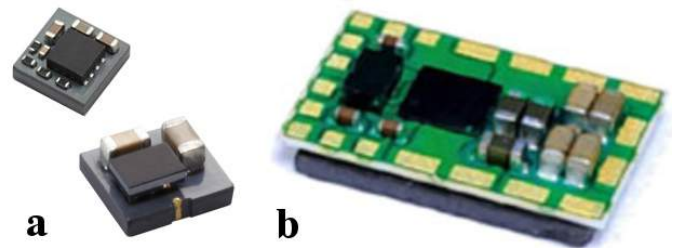

Fig. 1: Non-isolated LTCC inductor integrated POL converters a) Murata LTCC power supply [8]; b) CPES POL module with LTCC [9]

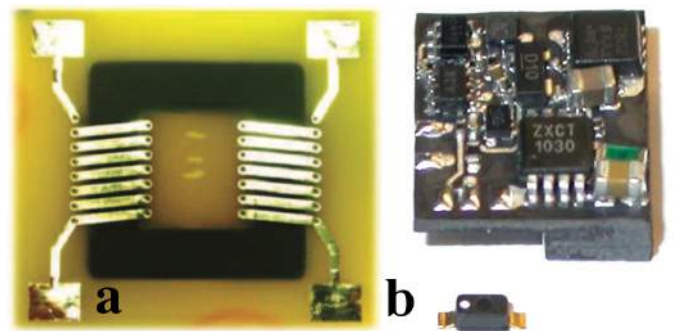

Fig. 2: a) PCB integrated EMI Filter with coupled inductor [10] ; b) Integrated flyback dc-dc converter built using ferrite-based LTCC materials [11]

multi-megahertz integrated POL converter with LTCC planar inductor and GaN devices [3], [7], [9]. Fig. 1(a) presents the Murata's Micro DC-DC converts, which use a LTCC inductor with a Flip-Chip IC on the top [12] and Fig. 1(b) shows a LTCC ferrite planar inductor and assembled POL module

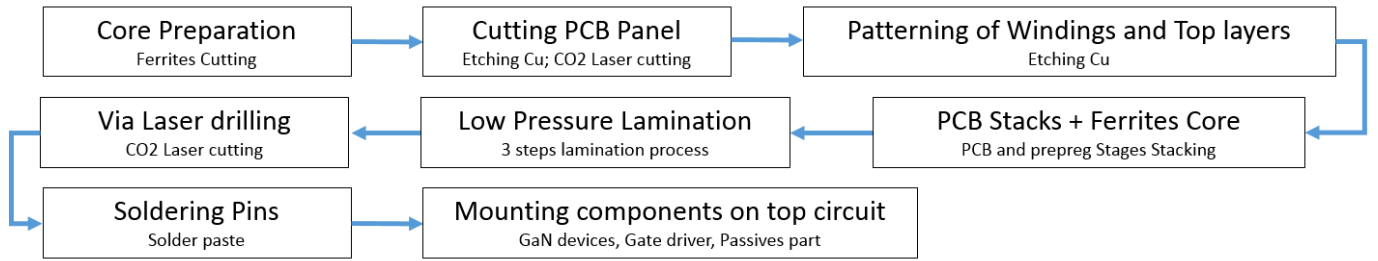

Fig. 3: Process flow for power supply with PCB embedded transformer

working at 5 MHz. Nevertheless, a few papers deal with the integration of fully isolated converters. Fig. 2(a) demonstrates a PCB integrated EMI filter with two coupled inductor with a toroidal core [10]. Fig. 2(b) present a LTCC transformer for high-voltage Flyback application, the transformer allows a low frequency switching frequency and the measured isolation capacitance is around 30 pF [11], [13]. [14] presents a PCB-integrated flyback transformer optimization for a 1 mm thin PFC rectifier without any experimental results.

The PCB embedding process presented in this work utilizes traditional Mn-Zn ferrite core and properly selected PCB materials with high glass-transition temperature (T_g) and low coefficient of thermal expansion (CTE) to develop a transformer with coplanar winding structure for the highly integrated power supply used in harsh environment.

II. PCB MATERIAL SELECTION

Most commercially available PCB materials with high T_g have very high CTE ($> 30 \cdot 10^{-6}/^{\circ}\text{C}$) along z-direction, as listed in Table I. The embedded Mn-Zn ferrite material has a CTE of around 7 to $10 \cdot 10^{-6}/^{\circ}\text{C}$. Significant amount of thermal stresses could be applied on both ferrite core and PCB laminate due to this dramatic CTE mismatch especially for high-temperature applications. Delamination on the multilayer PCB assembly and cracking of ferrite core are the two most expected defects in the embedded structure, which would cause failure of the integrated power supply.

The Panasonic R-1515 PCB material is a ceramic-fiber enforced PCB material and presents a low CTE of $22 \cdot 10^{-6}/^{\circ}\text{C}$ in z-axis (Table I) which is more compatible with that of ferrite materials. The reliability of embedded transformer would be improved accordingly. An embedded transformer prototype using traditional FR-4 material (epoxy resin with fiberglass) with higher CTEs ($60 \cdot 10^{-6}/^{\circ}\text{C}$ in z-axis) was also manufactured as benchmark. Thermal cycling test has been used to evaluate the impact of different CTE mismatches on the integrity of the assemblies.

III. PCB LAMINATION PROCESS

Fig. 4 shows a cross-section view of the PCB embedded transformer with different layers. The ferrite core and coplanar winding were embedded into the PCB (Panasonic R-1515W) to implement the transformer. All other components including active GaN devices were mounted on the top surface of the PCB substrate. This paper introduces the embedding process of transformer and the full integration process including active

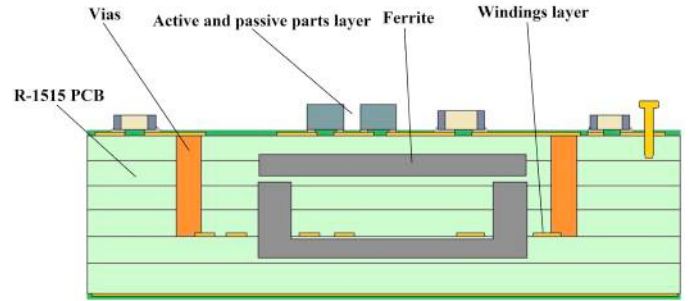

Fig. 4: Schematic of power supply with PCB embedded transformer

device. The detailed information about the PCB embedding process of transformer is introduced below:

- Two commercially available ferrite cores (ER 9.5, Ferroxcube) were machined to U- and I-shapes, respectively (Fig. 5). This Mn-Zn ferrite core material was used due to its low core loss density at 1-2 MHz and high Curie temperature (300°C) [15]. A sectioning machine with diamond blade and a grinding/polishing table were used to reshape the ferrite cores.

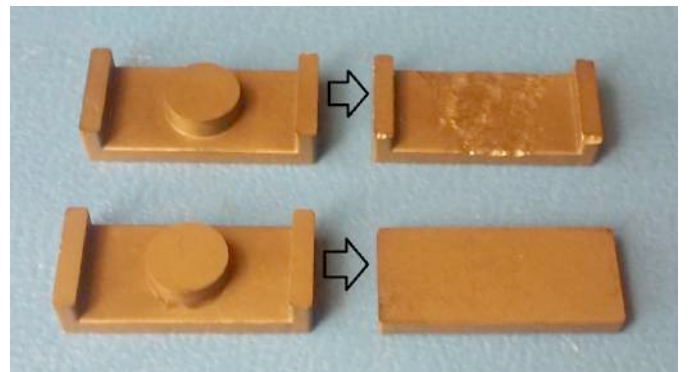

Fig. 5: Machined UI-shape ferrite core

- PCB panels were cut using a CO2 laser machine. Unneeded copper (Cu) on PCB panels was removed by ferric chloride etching solution.
- Two R-1515W laminate sheets with 1 oz. Cu were used for the preparation of embedded winding layer

TABLE I: High-Temperature PCB Materials

Manufacturer	PCB	Tg [C]	CTEz[10 ⁻⁶]	CTEx[10 ⁻⁶]	CTEy[10 ⁻⁶]	Material
Arlon	35N	250	51	16	16	Polymide
Arlon	85N	260	50	16	16	Polymide
Panasonic	R1515E	250	22	9	9	N/A
Panasonic	R1515W	250	22	9	9	N/A
Rogers	Duroid 6202R	326	30	15	15	PTFE

and the top active layer. The top Cu surfaces were patterned and etched to form the winding for transformer and circuitry for power supply, respectively.

- The PCB stack consisting of alternate c-stage laminates and b-stage prepregs was aligned with ferrite cores.
- The lamination process for the embedded transformer was divided into three steps: The flat I-shape ferrite core with the top circuitry layer was laminated into one piece at the first. Then, the U-shape core with the internal winding layer was embedded into the PCB multilayer substrate. The last lamination was performed to integrate the two parts made in the previous steps. The customized air-gap distance can be adjusted using different thicknesses and/or numbers of the bonding prepreg layer. Fig. 6 shows the picture of the final assembled passive substrate.
- Vias were drilled by a laser process, and the connections between the internal winding layer and the top circuitry were made with soldered Cu pins.



Fig. 6: Assembled passive substrate with embedded transformer

The integration process for the power supply with PCB embedded transformer is illustrated in Fig. 3. The total thickness of the assembled passive substrate is about 3.6 mm. The complete converter prototype was built by mounting other components on top of it.

IV. THERMAL CYCLING OF PCB EMBEDDED TRANSFORMER

The reliability of the PCB with embedded ferrite core transformer was evaluated using thermal cycling method. Due to the difference in CTE between the ferrite and PCB substrate materials, major defects such as delamination at interfaces

and cracking of ferrite core could happen. The cycling profile applied to the PCB samples follows the aeronautic constraint, with a temperature range from -55°C to 200°C in the heating/cooling rate of $20^{\circ}\text{C}/\text{min}$ and 20-min holding period at each extreme. In order to make a comparative study, two specific samples were manufactured for this test using Panasonic R-1515W and Isolac FR-406 PCB materials, respectively.

After 1000 cycles, no delamination and other major defects were observed on the sample using Panasonic PCB materials, as shown in Fig. 7b. The color changing may be the results of an oxidation and the air-void was created during the abrasive process for the sectional view. Serious delamination and ferrite cracking can be observed in Fig. 7d on the PCB-embedded sample using FR-4 materials after only 150 cycles.

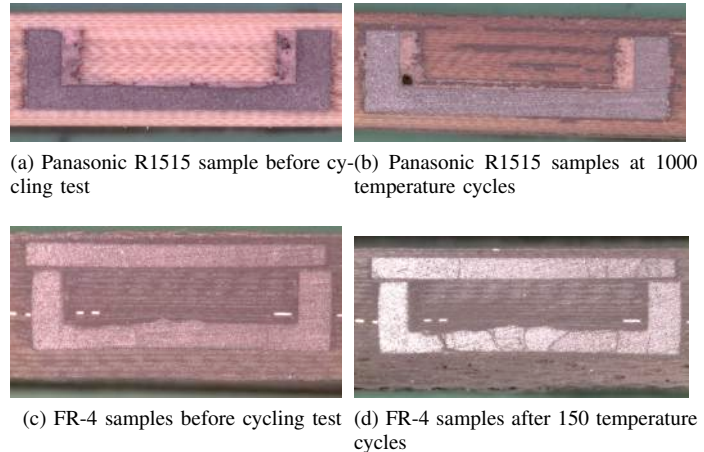

(a) Panasonic R1515 sample before cycling test (b) Panasonic R1515 samples at 1000 temperature cycles

(c) FR-4 samples before cycling test (d) FR-4 samples after 150 temperature cycles

Fig. 7: Temperature cycling test

V. EXPERIMENTAL RESULTS

The circuit diagram of this power-supply prototype with PCB embedded transformer is shown in Fig. 8. This converter uses an active-clamp flyback topology operating at resonant mode [16], [17]. The switching frequency is 2 MHz, 15 V for the input voltage and 6 V for the output voltage. This topology could compensate the high leakage inductance from the transformer using a clamp capacitor. The LC resonant tank was designed to achieve ZVS mode for the transistors and ZCS mode for the diodes in the rectifier. The volume of this fabricated converter is 15 mm x 22 mm x 3.6 mm (Fig. 10).

In Fig. 9, the resonant phase on the orange drain-source voltage (1) and the GaN body-diode conduction during the dead time (2), allow to check the right design of the resonant

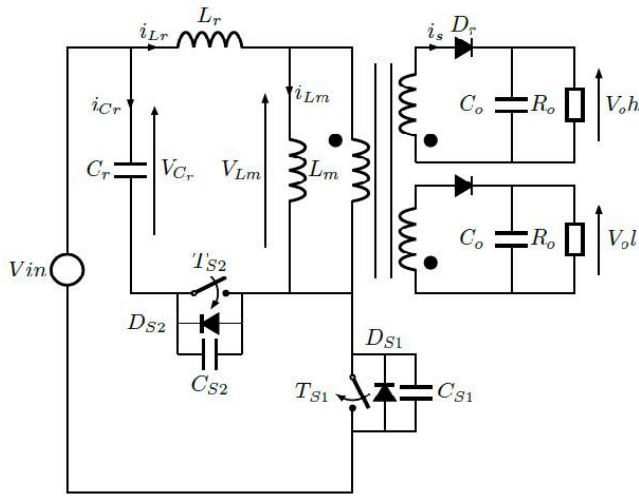

Fig. 8: Active Clamp Flyback circuit

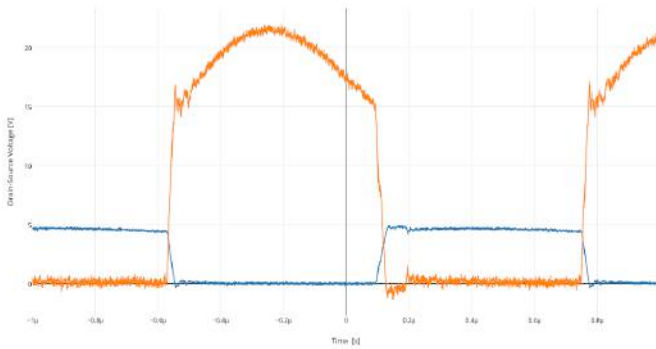

Fig. 9: T_{s1} and T_{s2} Drain Voltages

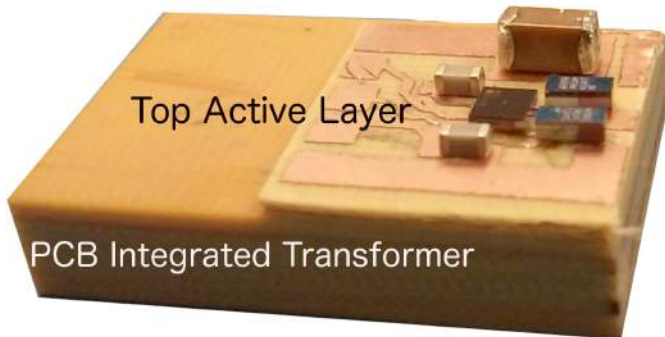

Fig. 10: First prototype with top components

point.

Low temperature gate driver and the EPCs GaN transistors (EPC8003) were used in the first prototype. But all passive components were chosen based on their high-temperature capabilities. The clamp capacitor is NPO Kemet ceramic capacitor and the decoupling capacitor comes from the high-temperature (250 °C) Ipedia silicon capacitor process. The PCB embedded transformer was characterized by measuring the primary and secondary inductances and the variation

between simulation and experimental results does not exceed 4%. The measured efficiency of this integrated converter is about 72% at 2 W output power. In Fig. 11 the efficiency of the

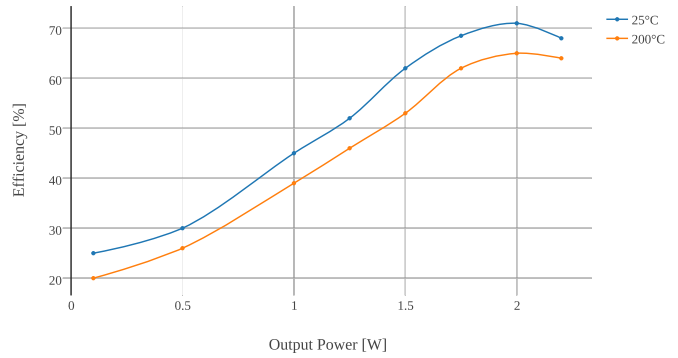

Fig. 11: Power supply efficiency at ambient temperature and 200 °C environment

power supply is experimentally verified. The decrease of the efficiency is mainly due to the increase of drop-voltage in the rectifier (0.8 to 1.3 V). The rectifier drop voltage is responsible of 55% of the global losses at 200 °C. The transformer losses are quite constant (25%) because of the low maximum value of the core saturation (0.15 mT). Different experimentation on JBS SiC diode technology are currently performed to reduce the drop-voltage in high-temperature.

VI. CONCLUSION

A new integration process for the PCB embedded transformer has been proposed in this paper. In comparison with the conventional tools and know-how, this developed fabrication process allows the embedding of commercial ferrites with a good control of the air-gap. The high-temperature application requires the use of a PCB material with high Tg and suitable CTE compatible with embedded ferrite core material. The reliability of PCB embedded transformer fabricated in this study has been demonstrated using thermal cycling test. The first 2-W converter prototype shows 72% power efficiency at 2 MHz switching frequency. The final assembly between the top active-layer and the PCB winding layer will be improved in the future work.

ACKNOWLEDGMENT

The authors would like to thank Panasonic for providing the PCB materials used in this study. And The MEGaN project.

REFERENCES

- [1] J. Popovic and J. Ferreira, "Converter concepts to increase the integration level," *Power Electronics, IEEE Transactions on*, vol. 20, no. 3, pp. 558–565, May 2005.
- [2] —, "An approach to deal with packaging in power electronics," *Power Electronics, IEEE Transactions on*, vol. 20, no. 3, pp. 550–557, May 2005.
- [3] Y. Su, Q. Li, and F. Lee, "Design and evaluation of a high-frequency ltecc inductor substrate for a three-dimensional integrated dc-dc converter," *Power Electronics, IEEE Transactions on*, vol. 28, no. 9, pp. 4354–4364, Sept 2013.

- [4] P. Artillan, M. Brunet, D. Bourrier, J.-P. Laur, N. Mauran, L. Bary, M. Dilhan, B. Estivals, C. Alonso, and J. Sanchez, "Integrated lc filter on silicon for dc-dc converter applications," *Power Electronics, IEEE Transactions on*, vol. 26, no. 8, pp. 2319–2325, Aug 2011.
- [5] M. Ludwig, M. Duffy, T. Donnell, and C. O Mathuna, "Pcb integrated inductors for low power dc-dc converter," in *Applied Power Electronics Conference and Exposition, 2002. APEC 2002. Seventeenth Annual IEEE*, vol. 1, 2002, pp. 319–325 vol.1.
- [6] Q. Chen, Z. Gong, X. Yang, Z. Wang, and L. Zhang, "Design considerations for passive substrate with ferrite materials embedded in printed circuit board (pcb)," in *Power Electronics Specialists Conference, 2007. PESC 2007. IEEE*, June 2007, pp. 1043–1047.
- [7] D. Hou, Y. Su, Q. Li, and F. Lee, "Improving the efficiency and dynamics of 3d integrated pol," in *Applied Power Electronics Conference and Exposition (APEC), 2015 IEEE*, March 2015, pp. 140–145.
- [8] Murata, "Ltc murata power supply lxdc55kaaa datasheet."
- [9] W. Zhang, Y. Su, M. Mu, D. Gilham, Q. Li, and F. Lee, "High-density integration of high-frequency high-current point-of-load (pol) modules with planar inductors," *Power Electronics, IEEE Transactions on*, vol. 30, no. 3, pp. 1421–1431, March 2015.
- [10] M. Ali, E. Laboure, F. Costa, B. Revol, and C. Gautier, "Hybrid integrated emc filter for cm and dm emc suppression in a dc-dc power converter," in *Integrated Power Electronics Systems (CIPS), 2012 7th International Conference on*, March 2012, pp. 1–6.
- [11] A. Roesler, J. Schare, and C. Hettler, "Integrated power electronics using a ferrite-based low-temperature co-fired ceramic materials system," in *Electronic Components and Technology Conference (ECTC), 2010 Proceedings 60th*, June 2010, pp. 720–726.
- [12] M. Note, "Low temperature co-fired ceramics (ltcc) multi-layer module boards," <http://www.murata.com/media/webrenewal/support/library/catalog/products/substrate/ltcc/n20e.ashx>, 01/2014.
- [13] A. Roesler, J. Schare, S. Glass, K. Ewsuk, G. Slama, D. Abel, and D. Schofield, "Planar ltcc transformers for high-voltage flyback converters," *Components and Packaging Technologies, IEEE Transactions on*, vol. 33, no. 2, pp. 359–372, June 2010.
- [14] C. Marxgut, J. Muhlethaler, F. Krismer, and J. Kolar, "Multi-objective optimization of ultra-flat magnetic components with a pcb-integrated core," in *Power Electronics and ECCE Asia (ICPE ECCE), 2011 IEEE 8th International Conference on*, May 2011, pp. 460–467.
- [15] "3f45 datasheet."
- [16] R. Watson, F. Lee, and G. Hua, "Utilization of an active-clamp circuit to achieve soft switching in flyback converters," *Power Electronics, IEEE Transactions on*, vol. 11, no. 1, pp. 162–169, Jan 1996.
- [17] B.-R. Lin, K. Huang, and D. Wang, "Analysis, design, and implementation of an active clamp forward converter with synchronous rectifier," *Circuits and Systems I: Regular Papers, IEEE Transactions on*, vol. 53, no. 6, pp. 1310–1319, June 2006.