

DIGIWORLD SUMMIT 2009

Rehabilitation and assistance

Medical Televigilance for elderly people

Jean-Louis Baldinger - Telecom SudParis (Evry)

Telesurveillance of Vital parameters from the Patient at Home : « Televigilance »

TSP Team:

- Permanent Staff : J.L. Baldinger, J. Boudy, F. Delavault
- Contractual Research Engineers : I. Belfeki, T. Guettari
- Doctorates: H. Medjahed (under cooperation with ESIGETEL and INSERM), P. Cavalcante (under cooperation with ESIGETEL and Uni-Ceara)

Close cooperation with:

- ESIGETEL, Fontainebleau : D. Istrate (associate partner of IE4IL)
- INSERM U558 Toulouse: F. Steenkeste (associate of IE4IL)
- SAMU-92 Garches : M. Baer (MD), A. Ozguler (MD), T. Loeb (MD) (associate of IE4IL)
- APHP-Broca: Anne-Sophie Rigaud (MD)
- UFES Vitoria, Bresil : Dr. Rodrigo Andreao (ECG identification)
- Uni-CEARA, Bresil: Prof. J.C. Moura-Mota (Telemedicine)
- Prof. Iancu Uni-Craiova & ESIGETEL : (ECG & Diabet signal processing)

TELEVIGILANCE CHAIN (TelePat Project 2003/05)

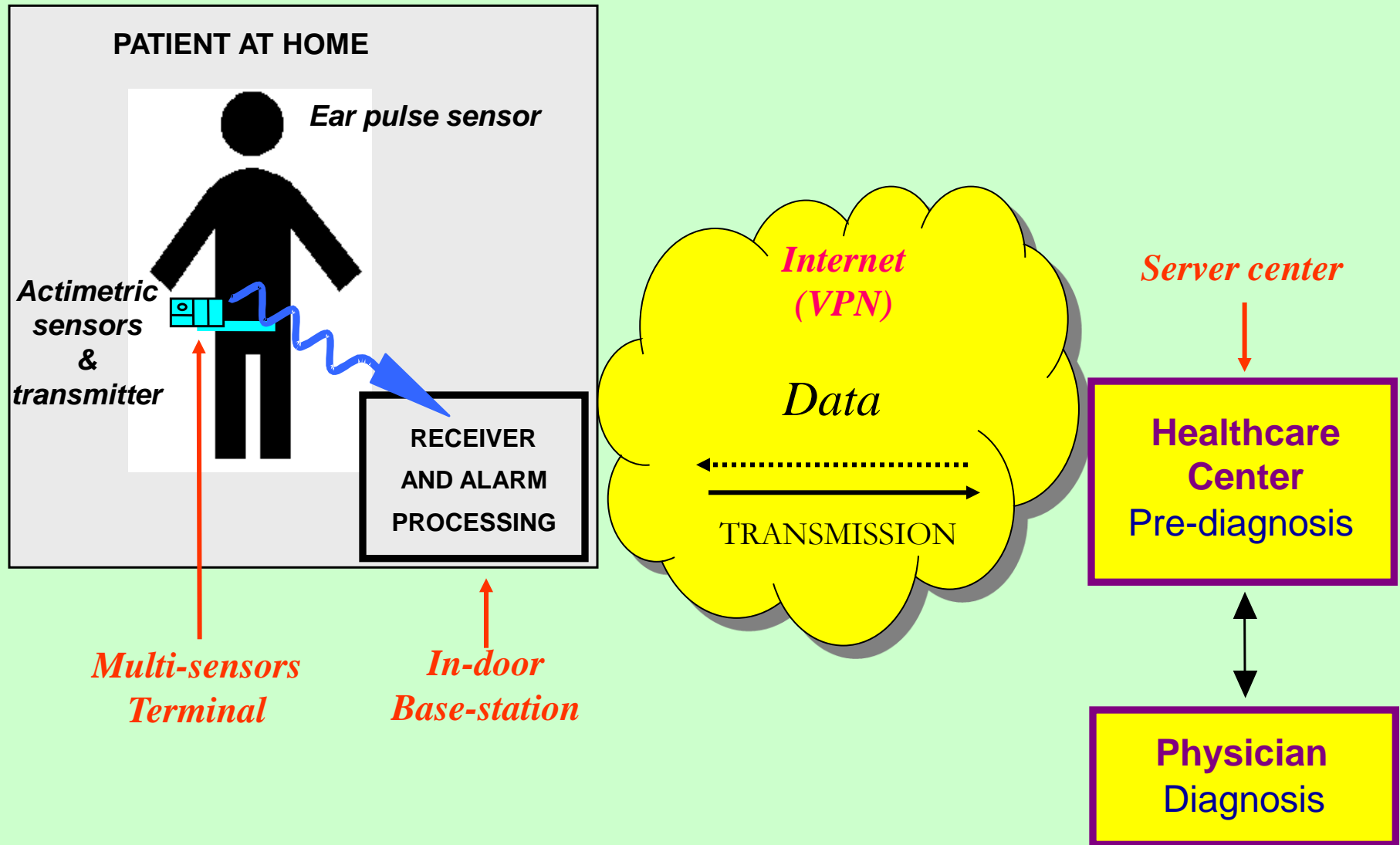

MULTI-SENSORS WEARABLE DEVICE

(TANDEM Project 2006/09)

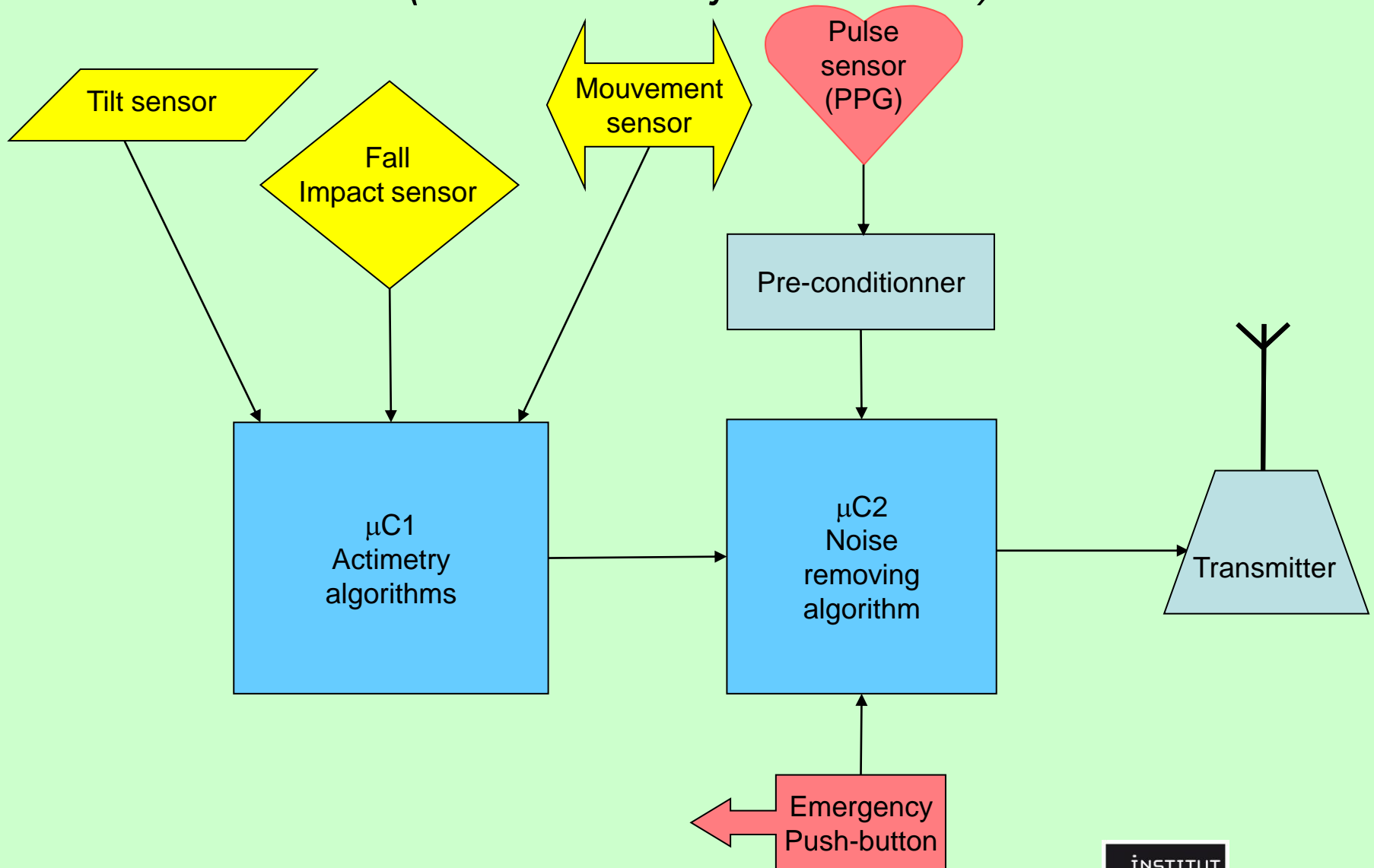

TELEVIGILANCE MONITORING CONTROL DISPLAY

TELEsurveillance de PATient à domicile (Projet TELEPAT)

Activité : taux(%) temporel de non-immobilité.

Pouls : en battements par minute.

Pouls = ? : capteur très perturbé par les mouvements du patient.

	Alarme	Position	Activité	Pouls	Batterie	Etiquette	M/A	Heure
35	/	DEBOUT/ASSIS	46	67	NORMAL	0	M	12:29:15
36	/	DEBOUT/ASSIS	6	67	NORMAL	0	M	12:29:45
20	CHUTE	ALLONGE	0	0	NORMAL	0	M	12:21:45
21	CHUTE	ALLONGE	0	0	NORMAL	0	M	12:22:15
22	CHUTE	ALLONGE	0	0	NORMAL	0	M	12:22:45
23	CHUTE	ALLONGE	0	0	NORMAL	0	M	12:23:15
24	CHUTE	ALLONGE	0	0	NORMAL	0	M	12:23:45
25	CHUTE	ALLONGE	0	0	NORMAL	0	M	12:24:15
26	POULS	DEBOUT/ASSIS	93	0	NORMAL	0	M	12:24:45
27	POULS	DEBOUT/ASSIS	80	1	NORMAL	0	M	12:25:15
28	POULS	DEBOUT/ASSIS	93	1	NORMAL	0	M	12:25:45
29	POULS	DEBOUT/ASSIS	86	9	NORMAL	0	M	12:26:15
30	POULS	DEBOUT/ASSIS	66	13	NORMAL	0	M	12:26:45
31	POULS	DEBOUT/ASSIS	80	27	NORMAL	0	M	12:27:15
32	/	DEBOUT/ASSIS	66	56	NORMAL	0	M	12:27:45
33	/	DEBOUT/ASSIS	33	65	NORMAL	0	M	12:28:15
34	/	DEBOUT/ASSIS	53	66	NORMAL	0	M	12:28:45

DA0100:2

Platform and Televigilance System in TSP

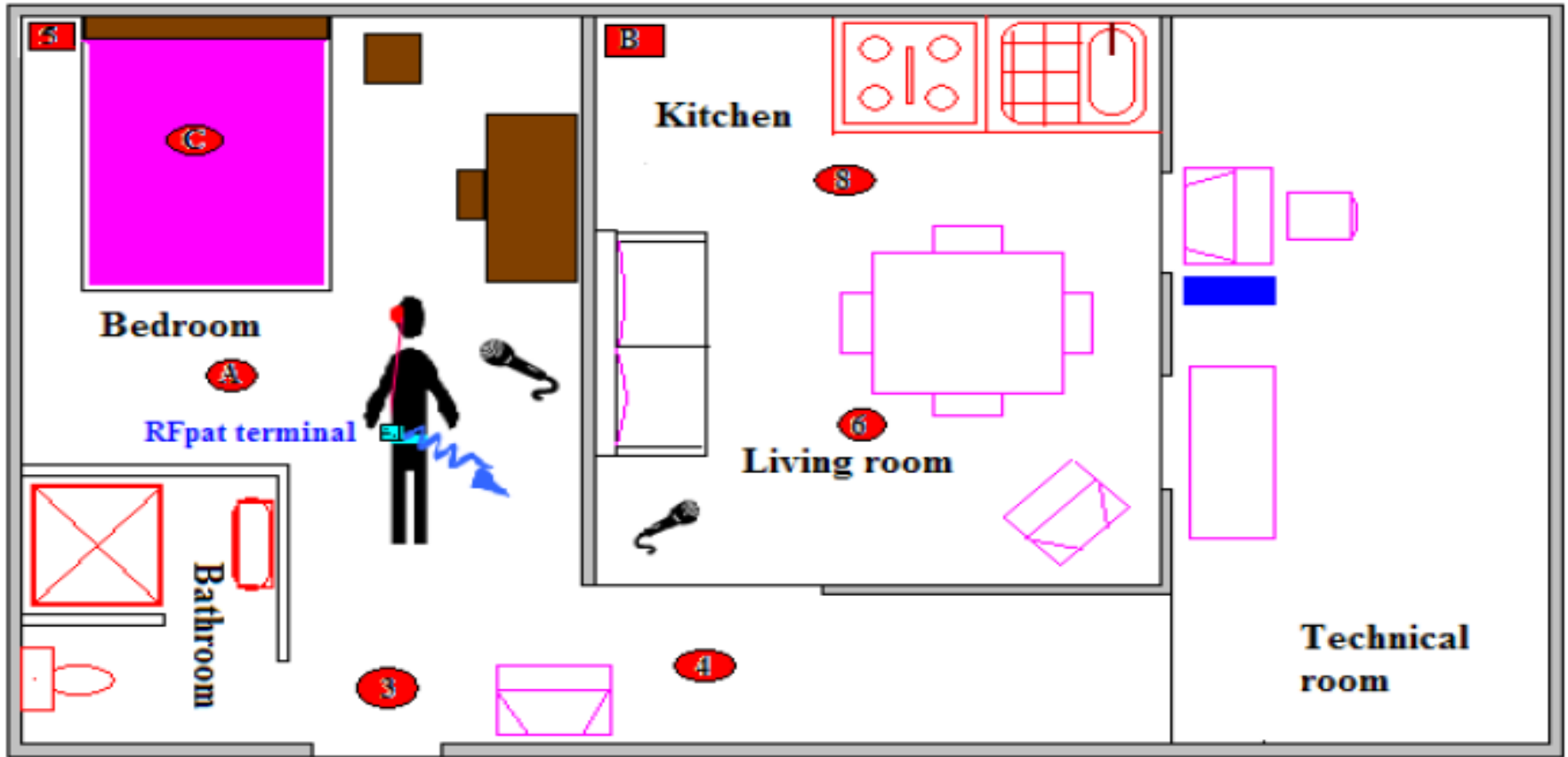

- Microphone
- Vertical infra-red sensor
- Horizontal infra-red sensor
- Server
- RFpat terminal
- Supervisor display

Televigilance System in TSP

- Software architecture (H. MEDJAHED, ESIGETEL-TSP-INSERM)

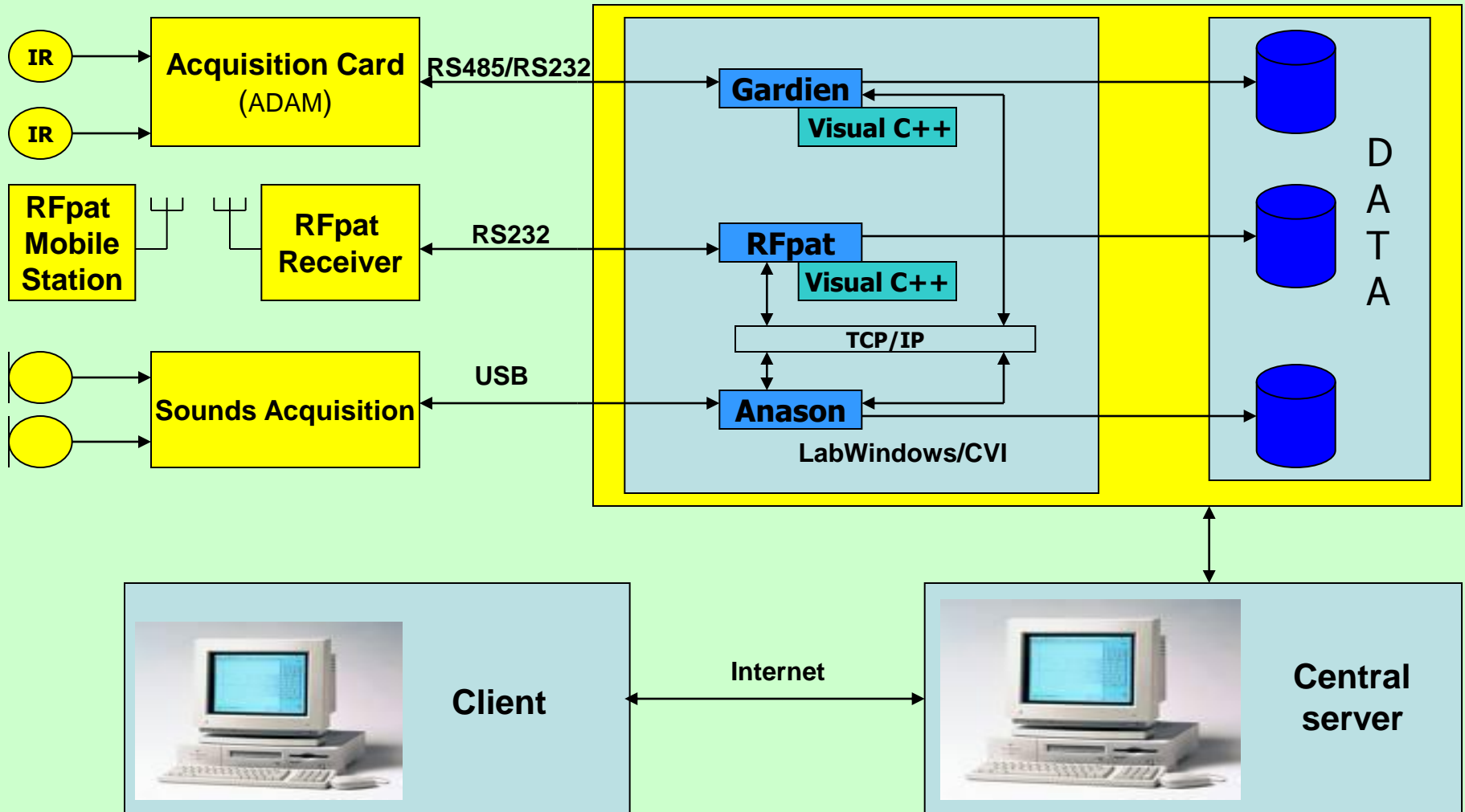

Wireless ECG (TelCard project - 2005)

Preprocessing : **Baseline straightening.**

Permanent ambulatory ECG acquisition implies ECG-baseline fluctuations (movements artefacts) added to myoelectrical noise and powerlines interference (50Hz).

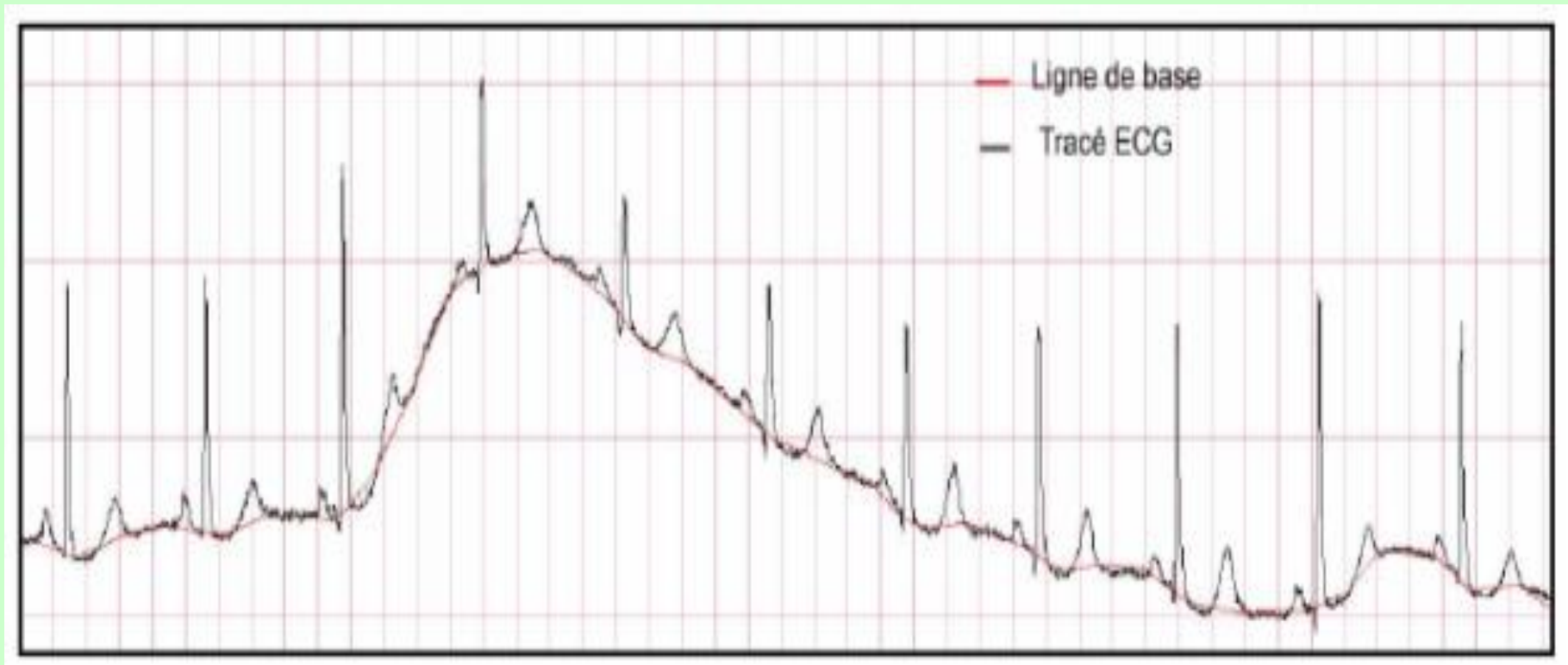

Transmitting ECG holter

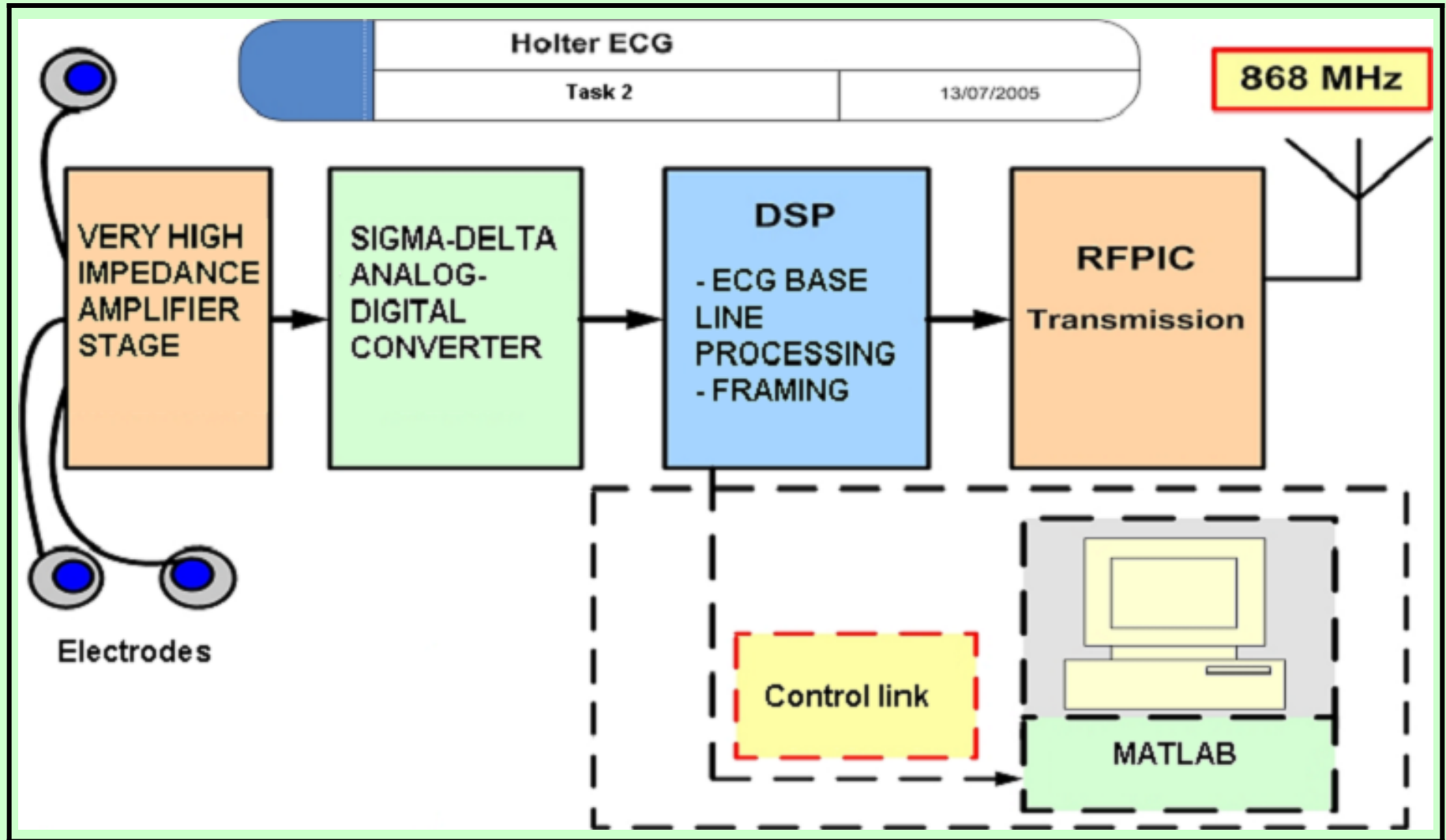

ECG baseline straightening

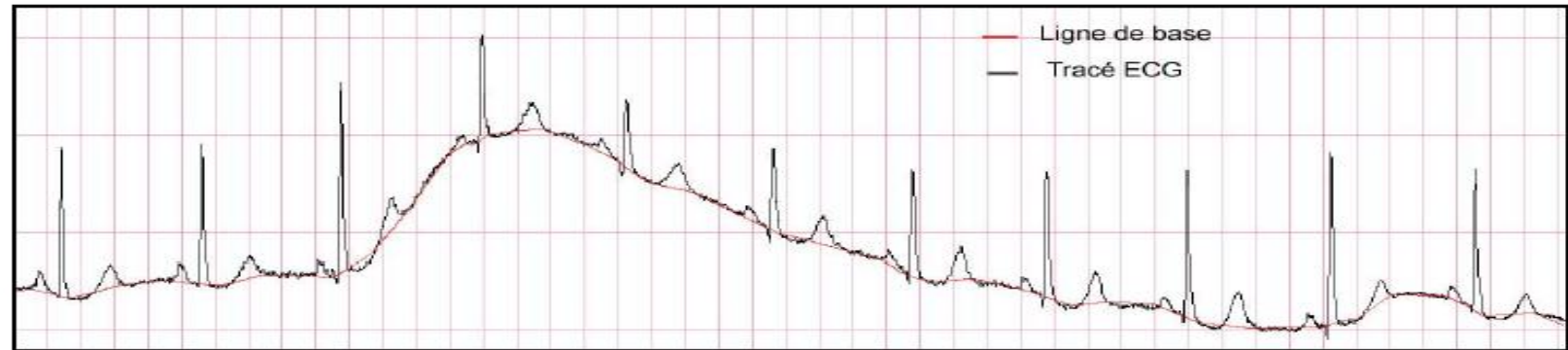

Ambulatory ECG record + movement artefacts only

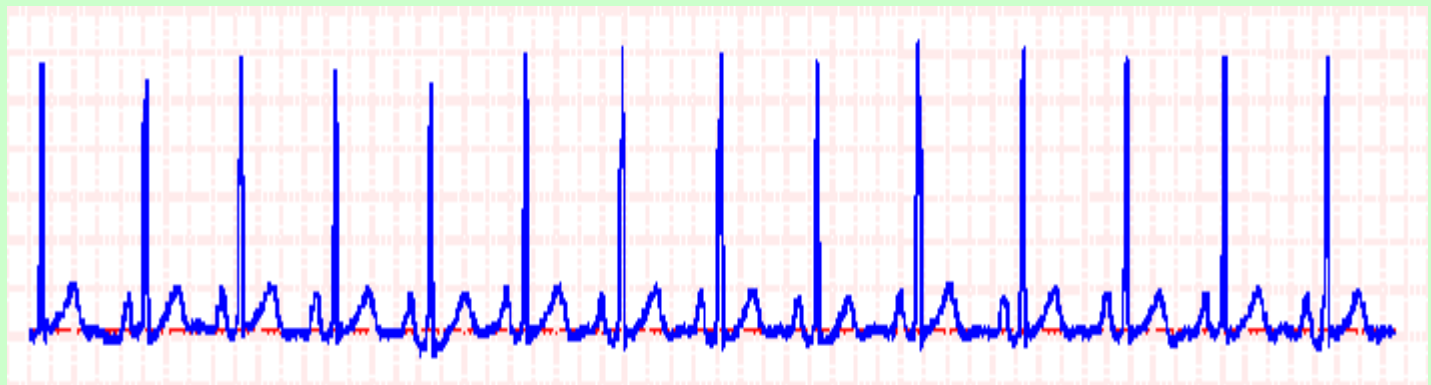

Clinical quality ECG record

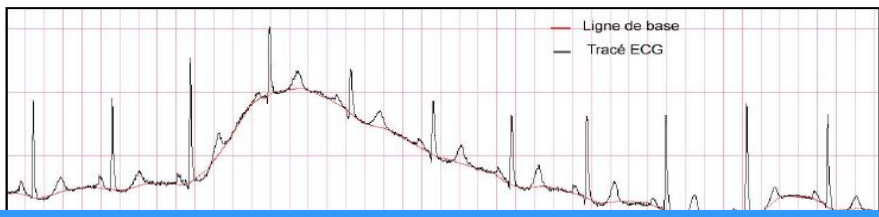

FILTERED SIGNAL
0.5 Hz – 40 Hz

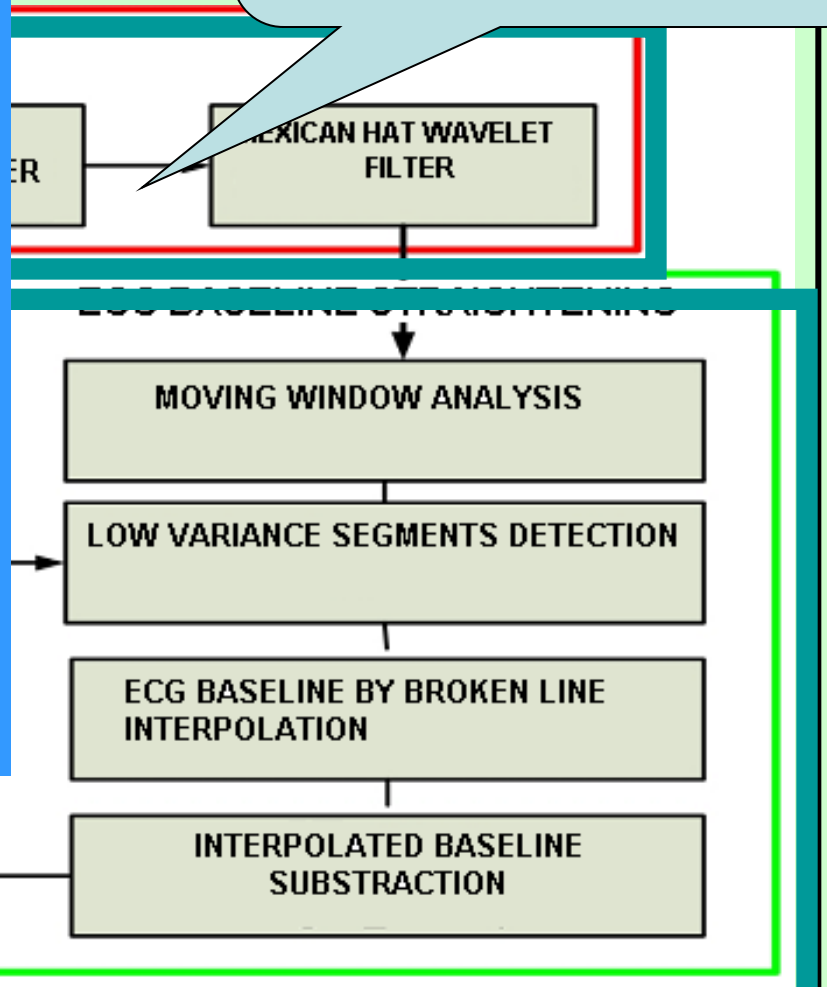
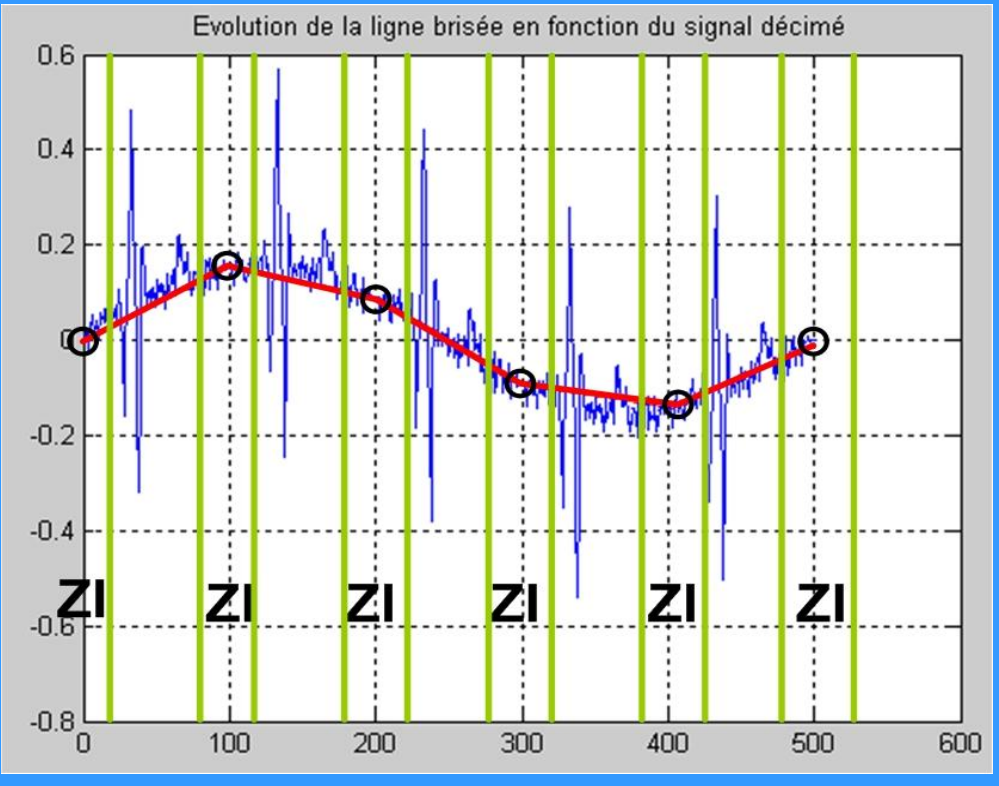

ECG WITH STRAIGHTENED BASELINE



Pulse oximetry (SpO₂) principle (1)

→ Operation of the SpO₂ sensor (Beer-Lambert law application)

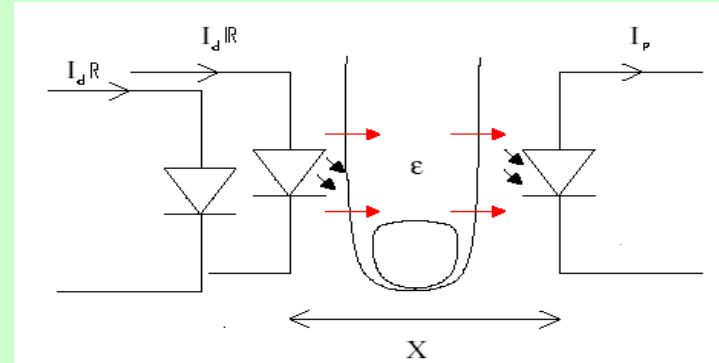
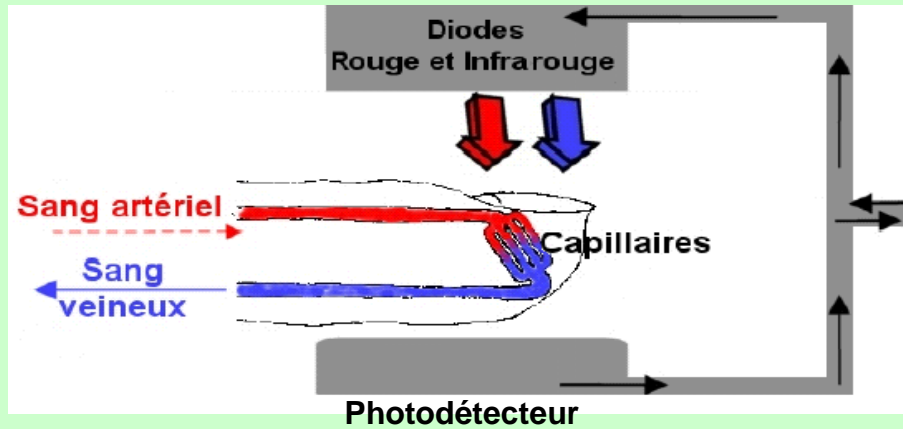

- HbO₂ (oxyhémoglobine) absorbe moins de lumière rouge que HB (hémoglobine)
- HB (hémoglobine) absorbe moins de lumière infrarouge que HbO₂ (oxyhémoglobine)
- Beer-Lambert law (clear solution)

$$I(\lambda, X) = I_0(\lambda) \cdot e^{-\alpha X r}$$

λ = wavelength (m)

I = transmitted light intensity

I_0 = incident light intensity

α = absorption coefficient (liter.cm⁻¹.mole⁻¹)

$X_{\bar{\alpha}}$ optical path length (m ou cm)

r = dissolved substance concentration (mol.m⁻³)

Pulse oximetry (SpO_2) principle (2)

Absorption coefficients:

Wavelength used: 660nm for red LED and 940nm for infrared light.

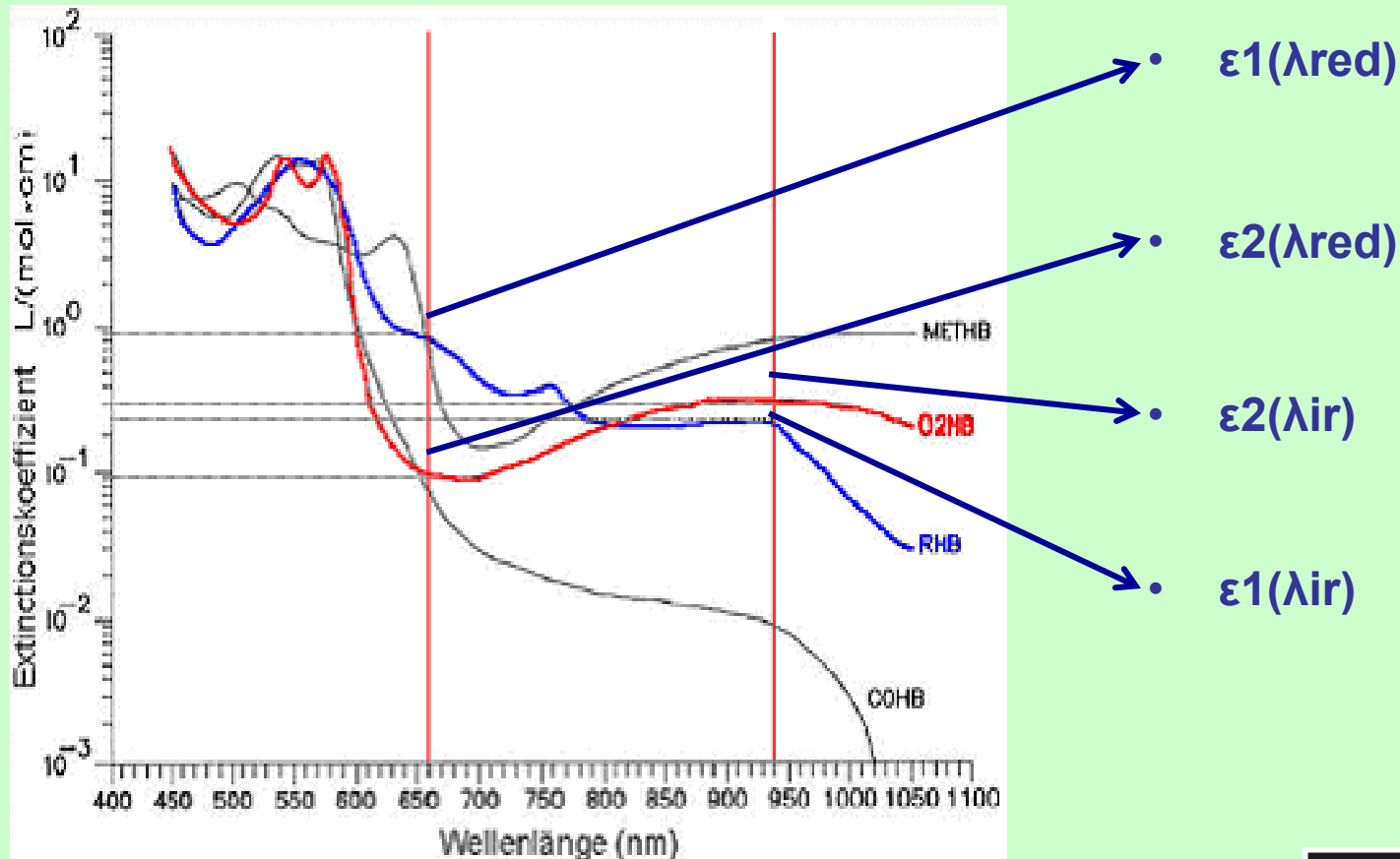

Method scheme

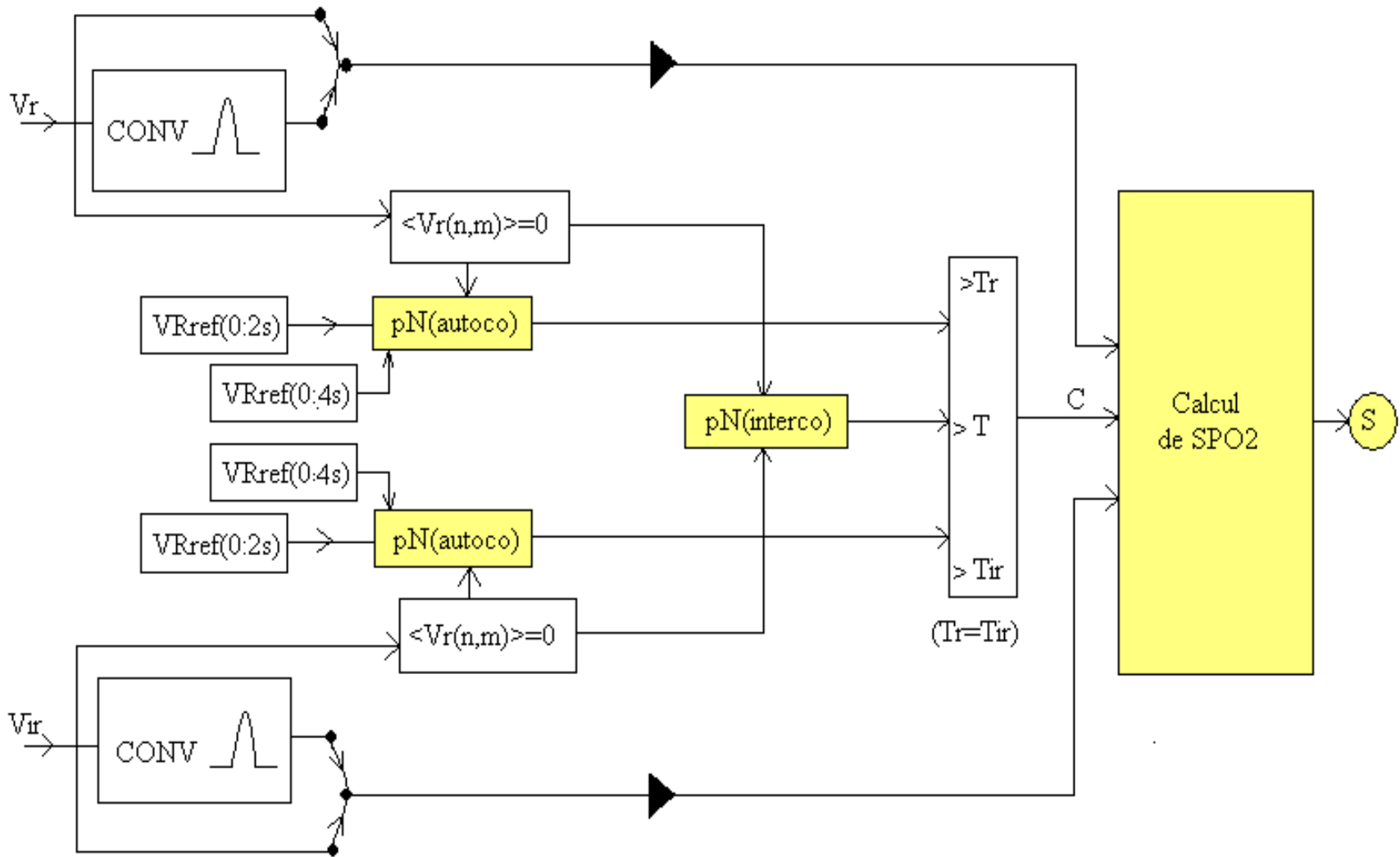

Red signal autocorrelation coefficients

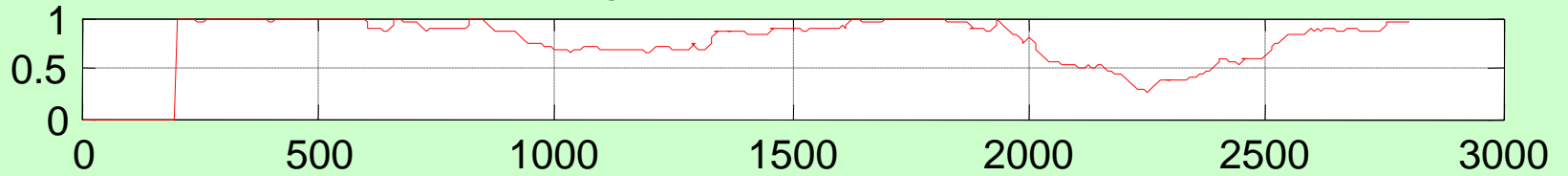

Red signal

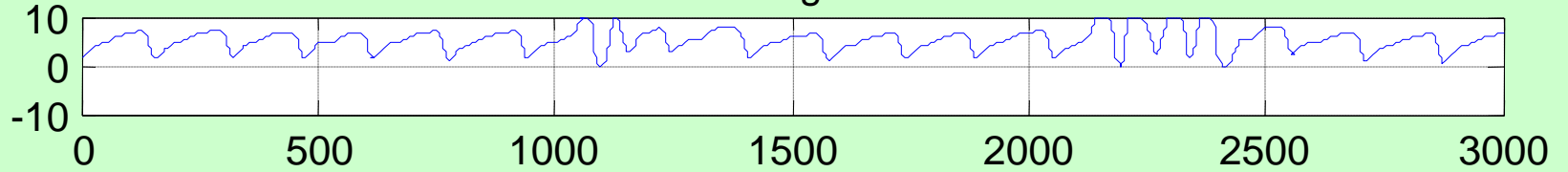

Red/Infrared intercorrelation coefficients

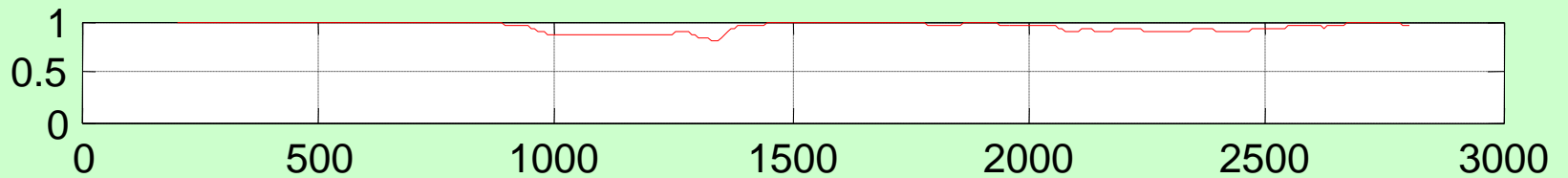

Infrared signal

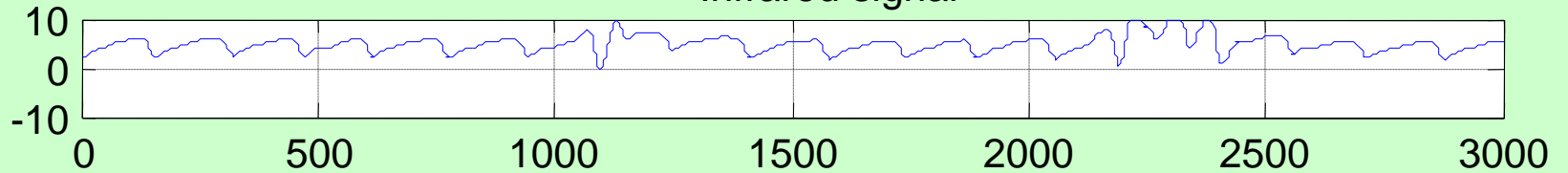

Red signal autocorrelation coefficient

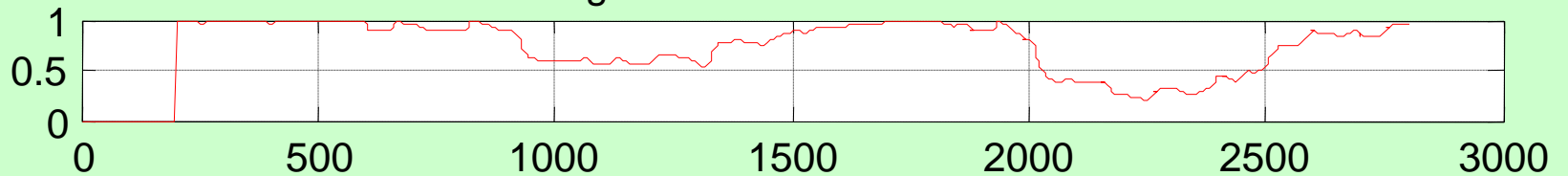

Signals indexation

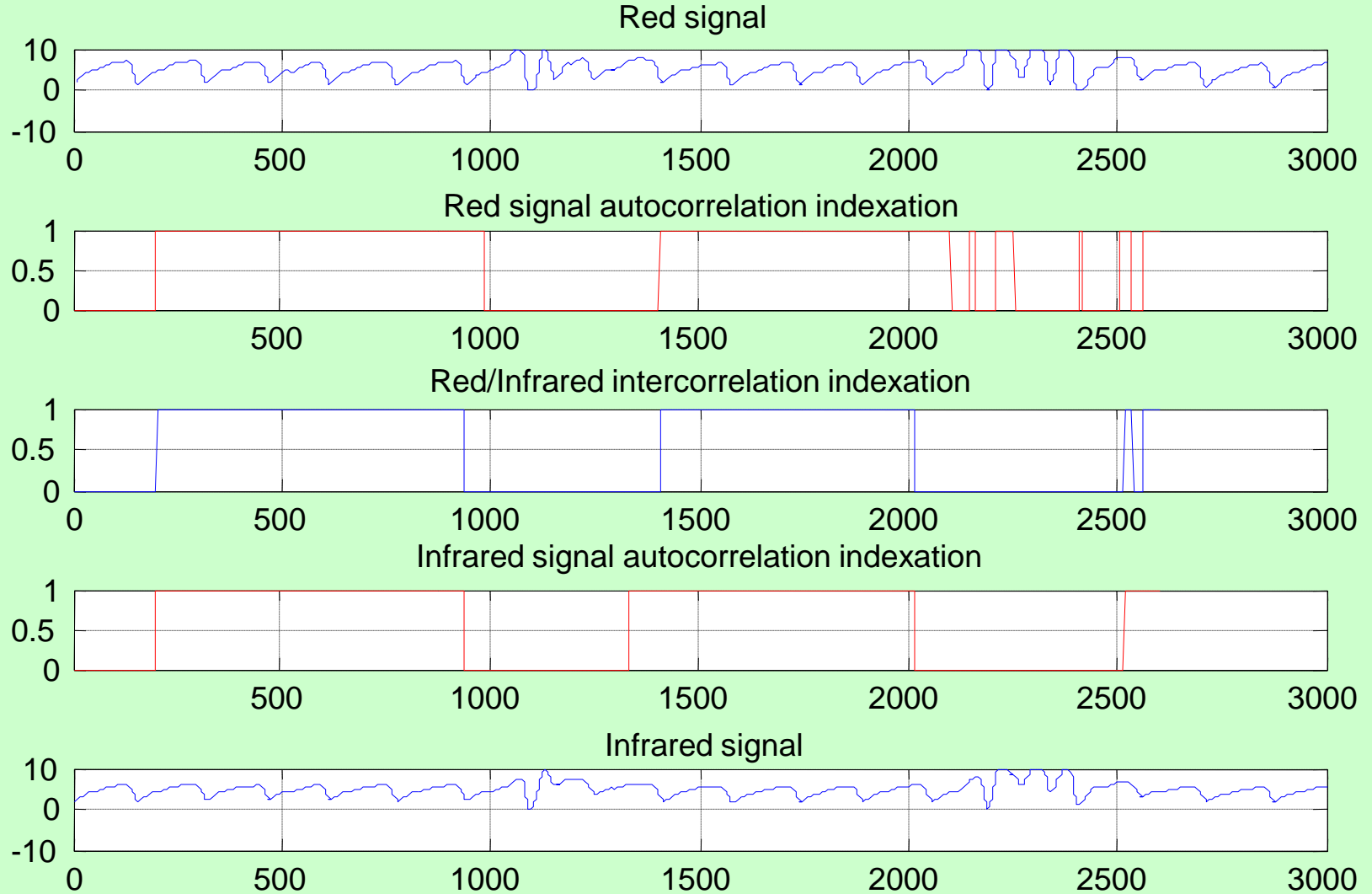

Thank you for your attention