



HAL
open science

Numerical Simulation of Reactive Flows in Ramjet Type Combustors and Associated Validation Experiments

T. Le Pichon, A. Laverdant

► **To cite this version:**

T. Le Pichon, A. Laverdant. Numerical Simulation of Reactive Flows in Ramjet Type Combustors and Associated Validation Experiments. *Aerospace Lab*, 2016, 11, pp.03. 10.12762/2016.AL11-03 . hal-01369688

HAL Id: hal-01369688

<https://hal.science/hal-01369688v1>

Submitted on 21 Sep 2016

HAL is a multi-disciplinary open access archive for the deposit and dissemination of scientific research documents, whether they are published or not. The documents may come from teaching and research institutions in France or abroad, or from public or private research centers.

L'archive ouverte pluridisciplinaire **HAL**, est destinée au dépôt et à la diffusion de documents scientifiques de niveau recherche, publiés ou non, émanant des établissements d'enseignement et de recherche français ou étrangers, des laboratoires publics ou privés.

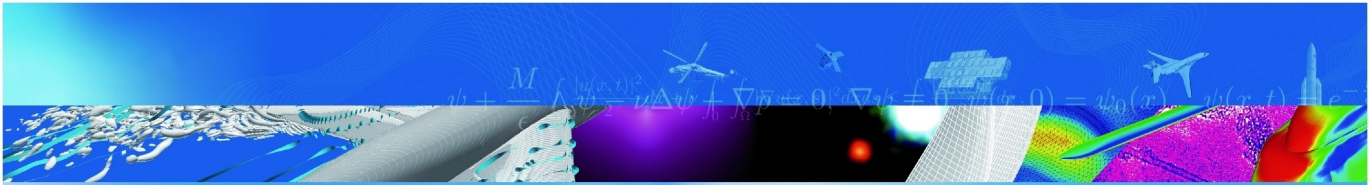

ARTICLE DE REVUE

**Numerical Simulation of Reactive
Flows in Ramjet Type Combustors
and Associated Validation
Experiments**

T. Le Pichon, A. Laverdant

AEROSPACELAB JOURNAL

No 11, AL11-03, 11 pages

TP 2016-552

70 2016
ans

ONERA

THE FRENCH AEROSPACE LAB

T. Le Pichon, A. Laverdant

E-mail: Thomas.Le_Pichon@onera.fr

DOI: 10.12762/2016.AL11-03

Numerical Simulation of Reactive Flows in Ramjet Type Combustors and Associated Validation Experiments

Twenty years ago, a review listed the main challenges to overcome to accurately predict the reactive flow fields in ramjet combustion chambers. These issues were grouped into five topics: flow organization, combustion phenomena, stability and performance, unsteady combustion and heat transfer. The aim of this paper is to give a brief overview of the numerical and experimental studies that have been carried out since this inventory in the specific program named “Research Ramjet” to improve CFD codes. First, the experimental setup designed to obtain a better understanding and to build-up an experimental database in order to validate numerical simulations is described. Then, the progress made with regard to these technical issues is presented. Significant improvements came from the implementation of Large Eddy Simulations. However, some challenges still remain, including the prediction of the overall performance parameters and the combustion instabilities.

Introduction

The ramjet is an air-breathing propulsion system very suitable for supersonic speeds, between Mach 2 and Mach 5. Sometimes referred to as an aerothermodynamical nozzle, or even a flying stovepipe, its basic concept is quite simple (Figure 1). The thermodynamic cycle, similar to that of gas turbines, is based on the Brayton cycle. Its main originality lies in the compression stage, which is accomplished thanks to the ramming effect of the incoming air flow: no rotating component is necessary. As always, there is a price to pay for this nice feature: ramjets develop no static thrust. An auxiliary engine is required for low-speed propulsion.

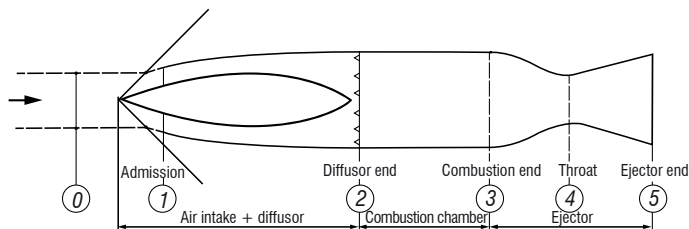

Figure 1 - Basic sketch of a ramjet combustor and characteristic sections [26]

Between the Thirties and the Sixties, ramjet was believed to be appropriate for aircraft propulsion. Several flying prototypes were built by the French engineer R. Leduc and Nord Aviation to demonstrate the feasibility of this engine [24][33]. However, gas turbine improvements during the same period put a curb on these developments. Meanwhile, the interest for ramjet-propelled missiles was skyrocketing. Several

experimental missiles were launched (e.g., ONERA's Stalattex, which reached Mach 5 in 1965) [27][28][29], and military applications were developed [15][29][55]. All of the first configurations were accelerated using an auxiliary jettisonable booster. A new concept arose in the Seventies, leading to a more compact missile: the Integral Rocket Ramjet (IRR) [33]. The basic idea is to use a common combustion chamber for the boosted and the sustained phases of flight. As a result, the solid booster is housed in the combustion chamber and the flameholders are removed. The dump-type configuration generates recirculation zones, which stabilize combustion (Figure 2). Two IRR were intensively studied in France: the Liquid-Fueled Ramjet (LFRJ) and the Solid Ducted Rocket (SDR). In the latter case, a fuel-rich solid propellant is used to generate a gaseous fuel supply.

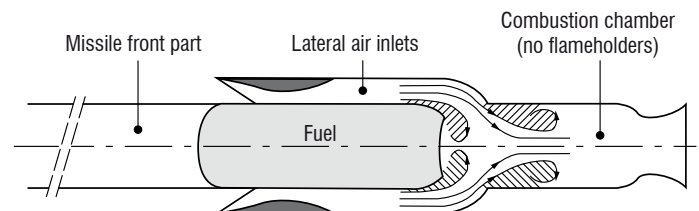

Figure 2 - Sketch of an Integral Rocket Ramjet (IRR) [4]

As for any engine, several phases are necessary to develop a new ramjet. Up to now, those steps were mainly based on a process of trial and error. Experimental research demanded a great deal of costly and time-expensive tests: design tests on components, connected-pipe tests, semi-free (or possibly free) jet tests, and finally, after several years, flight tests. Numerical simulations have been identified for

several years as one of the most promising tools to drastically reduce cost and time for the development of new engines. This could be accomplished provided that a CFD code, able to predict the performance parameters and the unsteady phenomena in any ramjet combustion chamber, is identified. Unfortunately, one can fairly admit that no CFD code has been able to demonstrate such abilities and many challenges are still to be faced.

Published material on reactive gaseous or two-phase flows in ramjet combustion chambers, which can be used to improve and validate numerical simulations, is very limited. The Lateral Injection Combustor (LIC) is a lab-scale two-inlet side-dump combustor, which has been extensively investigated in the EM2C laboratory [30][50]. Numerous experimental techniques have been used to study the non-reacting and reacting flows during stable or unstable operating conditions, and a significant database has been built. Nevertheless, significant features of the reactive flows in industrial SDR or LFRJ are missing: the internal flow is 2-D (the 3-D vortex motions resulting from the air stream impingement are not represented), boundary conditions (and especially inlet and outlets) are not representative of industrial combustors, and only gaseous fuel has been used. Experiments on industrial-type LFRJ side-dump combustors have been published, in the Eighties. These studies were aimed at understanding the impact of geometry on pressure oscillations [52][9] or on overall performance parameters [52][57]. Unfortunately, the internal combustor geometries are not exhaustively described, and the salient features of the internal reactive flows are not investigated.

In order to overcome this problem, a study named “Research Ramjet Program” was initiated some years ago at ONERA [39]. Within this framework, a specific side-dump combustion chamber has been designed in order to provide the experimental data necessary to validate CFD codes. This engine, quite unique in the world, is described in the first part of this paper.

About twenty years ago, a review article listed the main challenges to be overcome to improve the numerical simulations of ramjet combustors [22]. These technical issues were gathered into five topics: flow organization, combustion phenomena, performance and stability, unsteady combustion, and heat transfer. An in-depth analysis of each of these issues is beyond the scope of this paper. It is rather an attempt to highlight experimental and numerical studies that have been carried out at ONERA, within the framework of the Research Ramjet program, to tackle these problems.

Experimental apparatus

A combustion chamber has been designed, in order to examine and understand the basic physical phenomena that govern the flows in ramjet type combustors, and build an experimental database to assess, improve and validate computations.

As a result, a modular experimental setup, equipped with large windows, has been assembled (Figure 3). The configuration is a two-inlet side-dump ramjet combustor, which can be operated as a SDR or as a LFRJ. In the first case, gaseous propane is injected into the head-end through two circular tubes (Figure 4a). In the second one, liquid fuel injectors are installed in the two inlets (Figure 4b) and/or in the head-end.

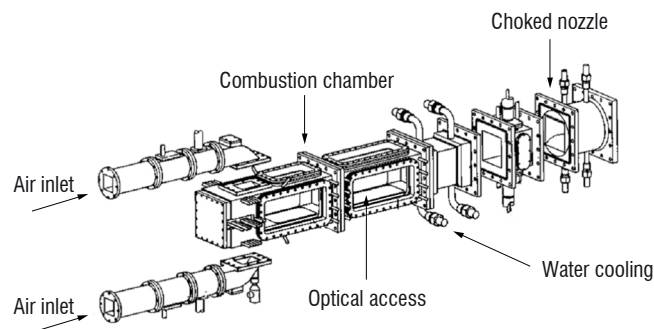

Figure 3 - Sketch of the modular Research Ramjet setup

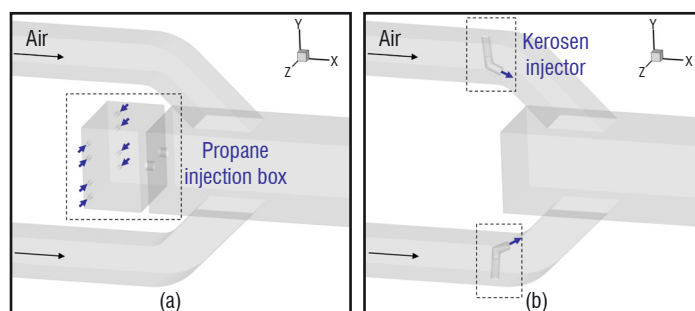

Figure 4 - Two potential configurations for the fuel injection: (a) gaseous propane in the head-end part of the combustor (SDR), (b) liquid kerosene in the air inlets (LFRJ)

The key dimensions (Figure 5) have been defined to be representative of real engines. The combustion chamber has a square cross-section (100 mm x 100 mm) and is fed by two lateral air inlets (50 mm x 50 mm). The square cross-section has been chosen to facilitate the integration of optical accesses, allowing direct views of flames and flow probing with laser sheets. There is an axisymmetric convergent - divergent nozzle at the end of the combustor. Note that, due to the modularity of the experimental setup, many geometric parameters can be varied.

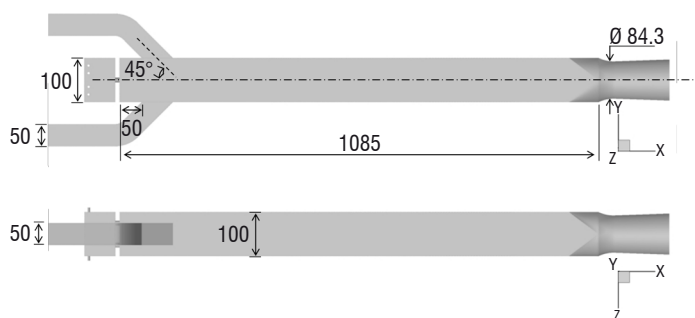

Figure 5 - Main dimensions (in mm) of the SDR configuration of the Research Ramjet combustion chamber

The setup is dedicated to connected-pipe tests, conducted in the ONERA air-breathing test facilities. An image of the ignited Research Ramjet combustor on a test-rig is given in Figure 6. Operating conditions, *i.e.*, incoming air mass flow rates (\dot{m}_2) and total temperatures (T_{t2}), are representative of real flight conditions (see Table 1). For each of these regimes, ranges of stagnation pressure in the aft part of the combustion chamber (P_{id}), which depend mainly on overall equivalence ratios, are given in Table 1. Note that the incoming air flow is not vitiated: a heat exchanger is used to increase its temperature.

Moreover, the air mass flow rate in each inlet is monitored with a sonic throat and the walls of the combustor are water-cooled to allow long-duration tests.

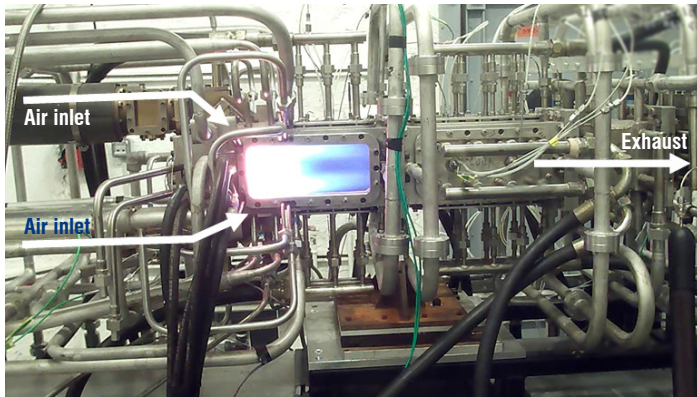

Figure 6 - The research ramjet combustion chamber on the test-rig in the ONERA facilities

In order to enable a more detailed characterization of the aerodynamics and fuel-to-air mixing process, a specific fully-transparent setup has been designed (Figure 7) [38][39]. In this case, only cold and non-reacting flows can be used for experimentations.

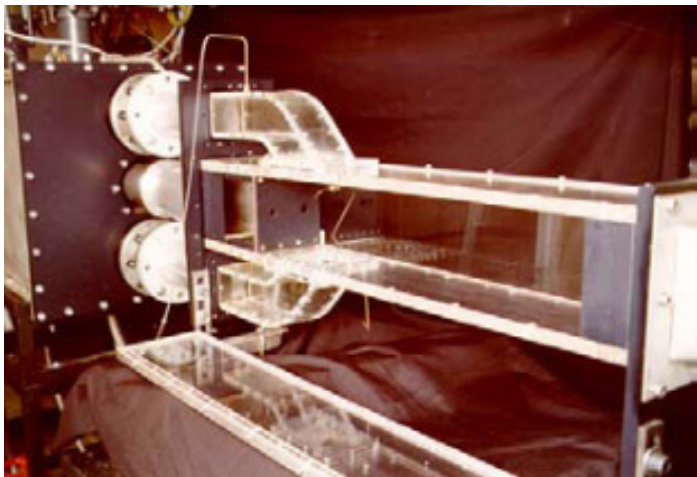

Figure 7. The transparent experimental setup

	\dot{m}_2 [kg.s ⁻¹]	T_{12} [K]	P_{i4} [bar]
High Altitude (HA)	0.9	750	1.5 – 2.5
Middle Altitude (MA)	1.9	600	3 – 5
Low Altitude (LA)	2.9	520	5 – 7

Table 1 - Operating conditions (air mass flow rate \dot{m}_2 and total temperature T_{12}) and approximate ranges of pressure in the combustion chamber (P_{i4})

Flow topology

As mentioned in [22], flow patterns inside side-dump ramjet combustors are fully three-dimensional, composed of vortex motions and axial recirculating flows. These complex features are mostly driven by the sudden expansion and the impingement of the air streams in the first part of the chamber.

Non-reacting flow topology on the Research Ramjet configuration was first examined by conducting water-tunnel experiments on the

transparent setup [20][40][41]. During those tests, water was made to flow through the two side inlets, while a dye (liquid fluorescein) was injected into the head-end. A laser sheet generator was used to light internal planes and highlight recirculation zones inside the chamber. The flow organization in the vertical symmetry plane and in three transverse sections as obtained with this technique is shown in Figure 8. The main recirculation (also named “dome”) is located near the head-end of the chamber, upstream from the jet-on-jet impingement zone. Two other significant recirculating regions (sometimes named “lateral zones”) are located downstream from the air inlets, on the top and bottom walls of the chamber. The dome and lateral zones are linked by the four corner vortices shown on the transverse sections in Figure 8.

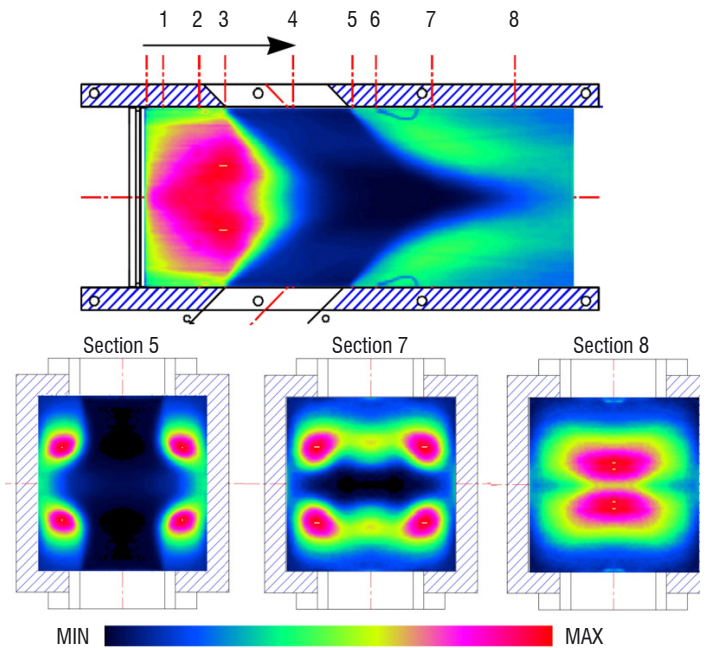

Figure 8 - Visualization of fuel-to-air mixing using the local colorimetry method on the transparent Research Ramjet configuration

An in-depth analysis of the fuel-to-air mixing in the non-reactive Research Ramjet configuration has been performed using the Particle Image Velocimetry (PIV) technique and gas sampling measurements [19][37][38][41][43]. This time, the side inlets of the transparent setup were fed with air, and gaseous carbon dioxide was injected into the head-end to simulate the fuel injection.

The reactive flow fields in the side-dump Research Ramjet configuration exhibit the same features as the non-reactive ones. This was demonstrated using Laser Doppler Velocimetry (LDV) and PIV measurements [5][37][42][43][44] applied to the Research Ramjet combustion chamber.

All of these data, mostly quantitative, obtained from non-reactive and reactive configurations, have been gathered in the experimental database and used to assess the capacity of numerical simulations to predict the flow patterns inside ramjet combustors.

Reynolds Averaged Navier-Stokes (RANS) computations, and later Large Eddy Simulations (LES), have been applied to predict the internal flow fields in the Research Ramjet configurations and compared to available measurements. Whenever only the overall topology is

sought, the mean flow given by RANS computations may be sufficient. Figure 9 illustrates the major features of the reactive flow field as evidenced with a RANS computation for the reactive High Altitude SDR case. As can be seen, the presence of the main recirculation zones is predicted by the steady calculation.

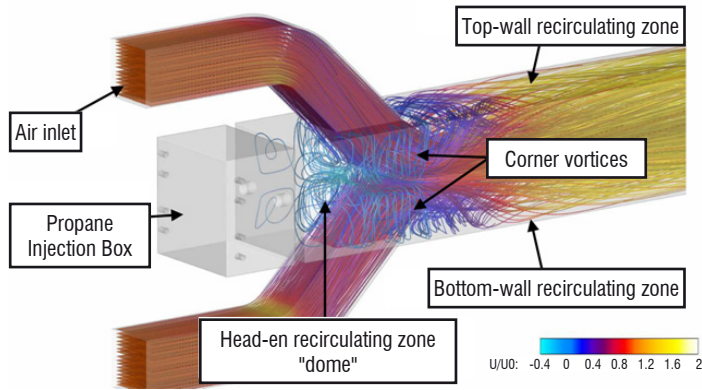

Figure 9 - Visualization of streamtraces colored by mean adimensionalized axial velocity for the SDR case provided by a RANS computation¹

However, as shown in [37], when it comes to the mean velocity and fuel concentration profiles in the recirculation zones, or to the size and length of these large structures, only LES can yield satisfactory results. This is due to the fact that the large scale turbulent motions of the flow, which control the flow patterns, are resolved by LES.

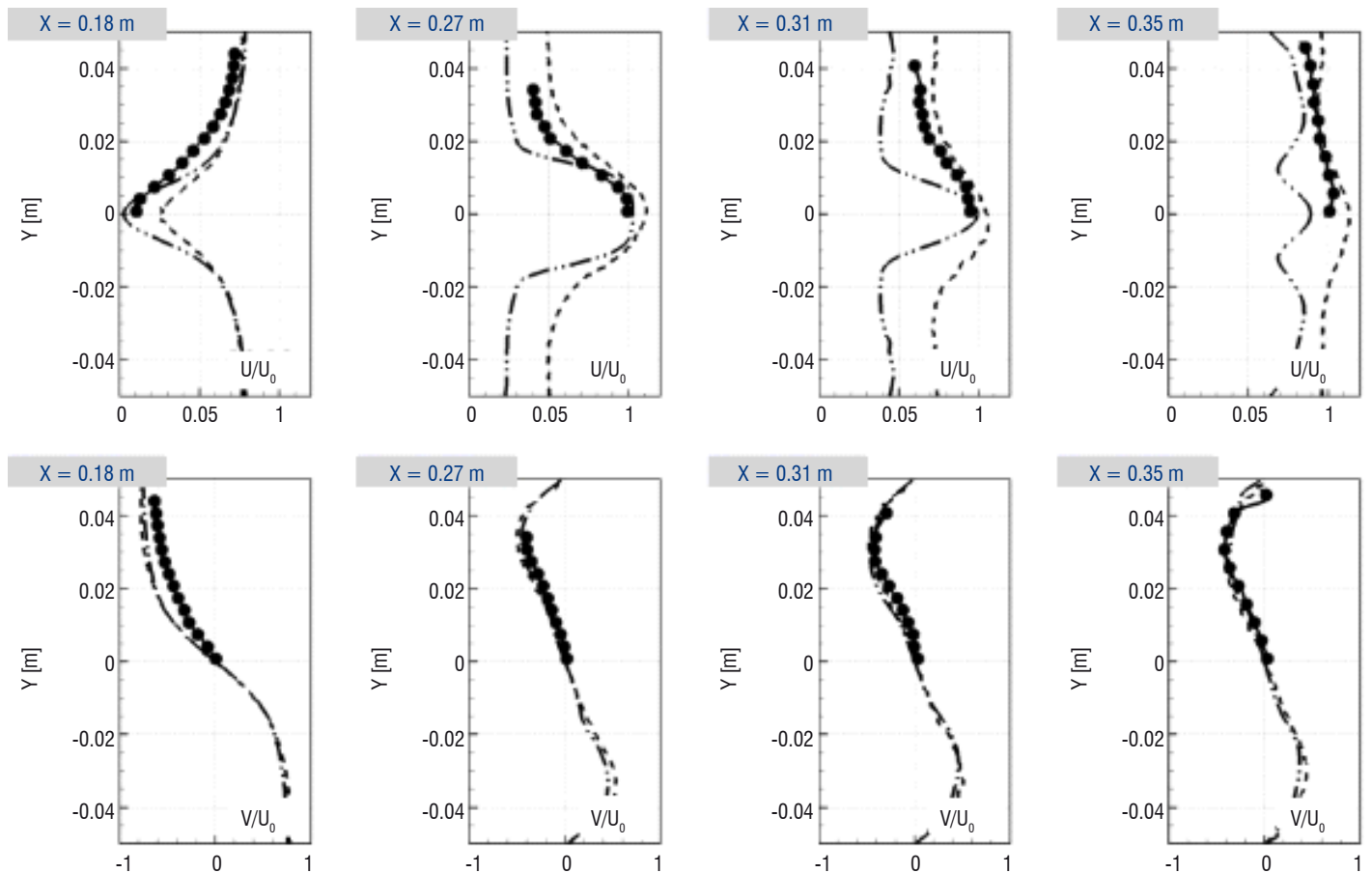

Figure 11 - Adimensionalized velocity profiles in the Research Ramjet combustor, for a High Altitude flight condition, at an overall equivalence ratio of 0.75. U refers to the axial velocity, V to the transverse velocity, and U_0 to the reference velocity. Comparison between experimental data (—●—), RANS (— · —) and LES (—)

¹ Main parameters are given in [23] and in Box 1 §1.

² Unpublished work. Main parameters are given in Box 1 §2.

As a result, significant improvements have been achieved concerning the prediction of the fuel concentration and velocities in the non-reactive transparent setup compared to RANS calculations [36][37] [43]. Concerning the reactive SDR configuration, axial and transverse adimensionalized velocity profiles as obtained with LES² and RANS¹ computations for the High Altitude flight regime at the equivalence ratio $\Phi = 0.75$ are given in Figure 11. The location of these profiles is given in Figure 10. As can be seen, the conclusion for the SDR reactive case is the same as for the non-reactive one: velocity profiles are better predicted using the LES approach.

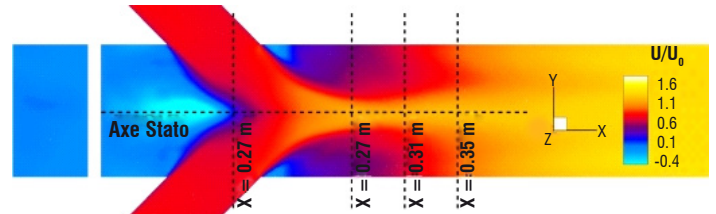

Figure 10 - Location of the velocity profiles

Significant improvements have been made over the past two decades with regard to the prediction of the flow organization, especially with the implementation of LES [37]. Even if the large scale structures, which are important features of the ramjet combustors, are present in the results of the RANS computations, LES is up to now the most predictive tool.

Combustion phenomena

Whichever configuration (SDR or LFRJ) or operating condition is used, combustion is likely to occur in three characteristic parts of the flow: (i) the top and bottom recirculating zone, (ii) the helicoid flows linking the head-end to the aft-part of the chamber and (iii) the head-end part of the chamber. Experimental observations have shown that flame anchoring is not spatially fixed. Without altering the operating conditions, combustion can be seen shifting periodically or intermittently from the top and bottom recirculating zone to the head-end part of the chamber [41][42].

The flame front location in the various configurations has been first exposed by direct visualizations of the OH* emission [40][41]. Furthermore, the OH-Planar Laser-Induced Fluorescence (OH-PLIF) technique has also been implemented to describe the spatial structure of the reaction zones [40][41]. Those visualizations have helped to develop a better understanding of the combustion regime of ramjet engines.

Time-averaged images provided with direct OH* visualizations showed that the flame position is strongly dependent on various parameters. Among them, the location of the fuel injection, or even the fuel itself, is a parameter that has a significant impact. The three visualizations of the OH* emission shown in Figure 12 were taken for a High Altitude flight regime at an overall equivalence ratio of 0.50. The difference between Figure 12a and Figure 12b is the fuel injected (respectively gaseous propane and liquid kerosene), and the difference between Figure 12b and Figure 12c is the position of the injectors (respectively in the head-end and in the air inlets).

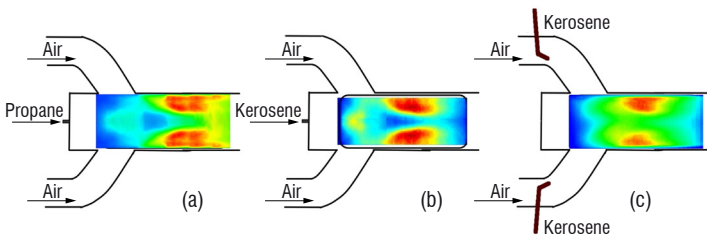

Figure 12 - Impact of fuel injection on mean flame front position revealed by OH* chemiluminescence for a High Altitude flight regime with an overall equivalence ratio of 0.50: (a) gaseous propane injected into the head-end, (b) liquid kerosene injected into the head-end, (c) liquid kerosene injected into the air inlets (arbitrary levels)

The overall equivalence ratio also has a significant impact on the flame front position. Figure 13 illustrates the fact that, for the SDR configuration, when the overall equivalence ratio is decreased, the mean flame front location moves upstream, from the lateral recirculation zone to the dome.

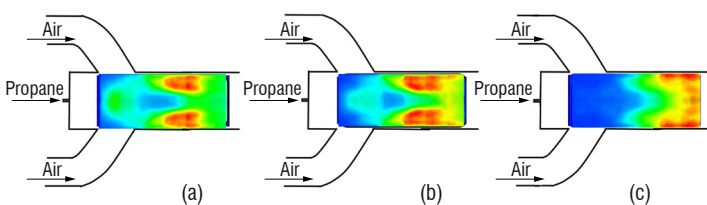

Figure 13 - Impact of the overall equivalence ratio on the mean flame front position revealed by OH* chemiluminescence for a High Altitude flight regime on the SDR configuration: (a) $\Phi = 0.35$, (b) $\Phi = 0.50$ and (c) $\Phi = 0.75$

The RANS approach was first applied to predict the influence of the equivalence ratio on the flame location. Unfortunately, one must admit that prediction of such influence with this steady approach is difficult. Figure 14 shows the temperature contours computed in the vertical symmetry plane for the two equivalence ratios 0.35 (Figure 14a, to be compared with Figure 13a) and 0.75 (Figure 14b, to be compared with Figure 13c): the mean flame position for the $\Phi=0.75$ case is quite well-predicted, but not the flame shift towards the head-end at $\Phi=0.35$. Nonetheless, one should specify that high speed camera visualizations have shown that combustion is intermittent in the head-end region, whatever the equivalence ratio [41]. Flames are anchored in the two lateral recirculation regions downstream from the air inlet and travel intermittently toward the head-end part of the combustor, along the four corner vortices. The lower the equivalence ratio, the deeper the travel upstream from the corner vortices in the dome region. Thus, given that only the mean flow field is computed with the RANS approach, this unsteady feature is not predicted, and flames stay only in the lateral zones.

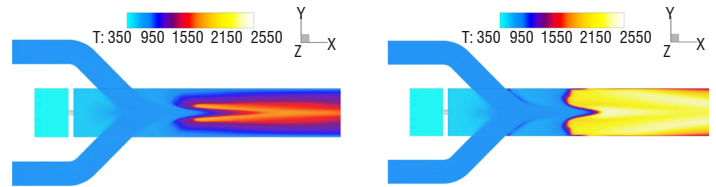

Figure 14 - Mean temperature in the vertical symmetry plane of the SDR Research Ramjet configuration computed with a RANS approach³ in the High Altitude flight regime: (a) $\Phi = 0.35$ and (b) $\Phi = 0.75$

Once more, improvements have been achieved with the implementation of the LES technique. The mean flame front displacement upstream as the equivalence ratio was decreased has been successfully predicted for the SDR Research Ramjet configuration [17][46]. The chemical kinetic scheme for the air-propane reaction, although very simple and reduced to a single global reaction, is a key for this success. In fact, the pre-exponential constant of Arrhenius' law has been adjusted to yield a correct laminar flame speed over an extended range of equivalence ratios, and especially in the rich zones. As a consequence, the prediction of the flame position was much more satisfactory than that obtained with other approaches that did not use such a correction (see for example [45]). In addition, this correction enables the two main low-frequency longitudinal modes of the combustor (at approximately 100 and 400 Hz) evidenced during the experiments for these operating conditions [46][47] to be recovered.

Nevertheless, this success in predicting the correct flame position for the SDR configuration does not mean that the modeling of the turbulent combustion inside ramjet combustors is no longer an issue. First of all, no information has been given about the combustion efficiency prediction with this approach (note that the performance parameters are discussed in the next paragraph). The number of species involved in the global scheme may be too small to accurately predict the temperature in the combustor, which affects the prediction of the performance parameter. Improvements could be achieved with the use of a more detailed scheme. Moreover, other flight conditions should be studied, as well as the two-phase reactive flows in the LFRJ configuration, which may add some difficulties in the combustion phenomena [22]. Finally, conditions near the stability limits of the combustor, as well as unstable conditions, should also be assessed.

³ Main parameters are given in [23] and in Box 1 §1

Performance and stability

Overall efficiencies

Two quantities are of prime interest when developing a new ramjet combustor: the combustion efficiency η_c and the pressure loss coefficient η_{24} . The combustion efficiency is defined as the ratio between the burnt equivalence ratio, determined at the end of the combustion chamber, and the injected equivalence ratio. The pressure loss coefficient is the ratio between the stagnation pressures at the end of the combustion chamber and at the end of the diffuser in the air inlets.

Pressure and temperature probes have been installed in reference sections of the Research Ramjet combustion chamber to evaluate, following a recommended procedure [1], these two performance parameters. Those quantities have been collected for each configuration, under various operating conditions.

One should admit that the accurate prediction of these two quantities is no easier today than it was twenty years ago [22]. Despite progress in numerical tools and modeling, no approach has demonstrated its capacity to predict these quantities, whatever the configuration or operating regime. Table 2 gathers some results obtained with different numerical approaches for the SDR configuration in the High Altitude flight regime at two equivalence ratios. The pressure loss coefficient is rather well predicted by all of the methods, with a gap ranging between 1 and 3 points. The comparison of the combustion efficiencies, however, brings to light wider discrepancies (between 2 and 14 points). Among the approaches selected here, none seems really adequate yet to predict this parameter.

The improvement of the models used in the numerical simulations to predict the performance parameters will be one of the main goals of future work. This issue is closely related to the others, as these two efficiencies are overall parameters that include a large number of physical phenomena (turbulence, combustion, wall friction, heat losses, etc.).

Overall equivalence ratio	Approach	Reference / main parameters	Pressure loss η_{24}	Combustion efficiency η_c
0.75	Experimental	-	0.88	0.81
	RANS	[23] + see Box 1 §1 for main parameters.	0.89	0.83
	LES	[37] + see Box 1 §2 for main parameters.	0.90	0.95
	LES	[46]	0.86	Not calculated
0.35	Experimental	-	0.87	0.80
	RANS	[23] + see Box 1 §1 for main parameters.	0.86	0.70
	LES	[46]	0.84	Not calculated

Table 2 - Prediction of overall efficiencies for two equivalence ratios in the High Altitude flight regime

Box 1 - Main parameters of the RANS and LES simulations performed with the CEDRE software and referred to in this paper

1 - RANS [SDR configuration]

Computational domain

3-D ; 1/4th of the geometry

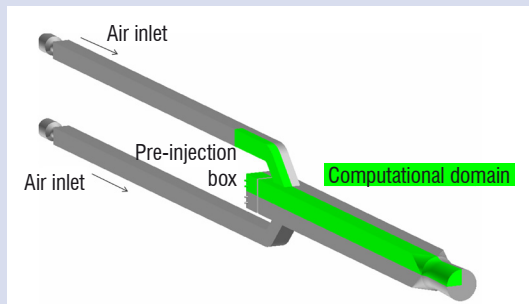

Mesh

Cell type: hexahedra
 No. of cells: 1.5×10^6 cells
 Average size: $\Delta x \approx 1$ mm in the dome region
 Near-wall size: $Y^+ \approx 100$

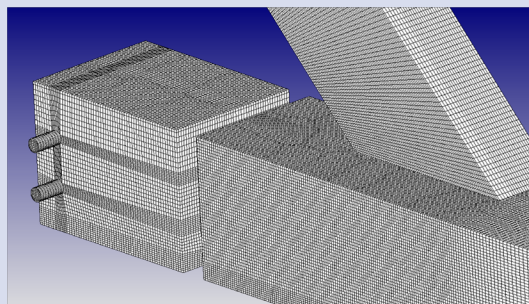

Numerical schemes

Spatial scheme: 2nd order

Temporal integration: Implicit 1st order

Physical models

Turbulence: Two-equation $k-\ell$ model

Combustion: RANS-PaSR [2],[31] + 4 steps reduced scheme for air-propane reaction [21]

2 - LES [SDR configuration]

Computational domain

3-D ; from the sonic throats in the air inlets to the exhaust nozzle

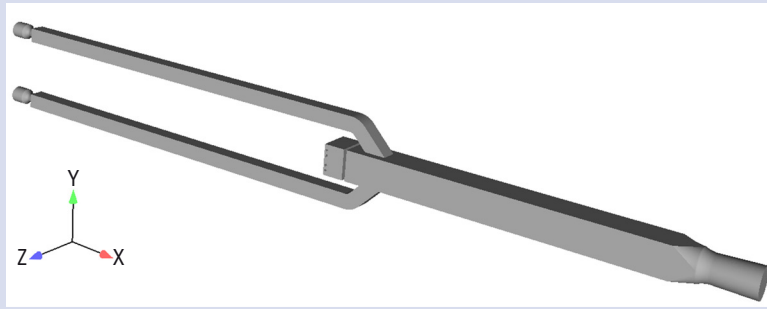

Mesh

Cell type: polyhedra
No. of cells: 2×10^6 cells
Average size: $\Delta x \approx 1$ mm in the dome region
Near-wall size: $Y^+ \approx 100$

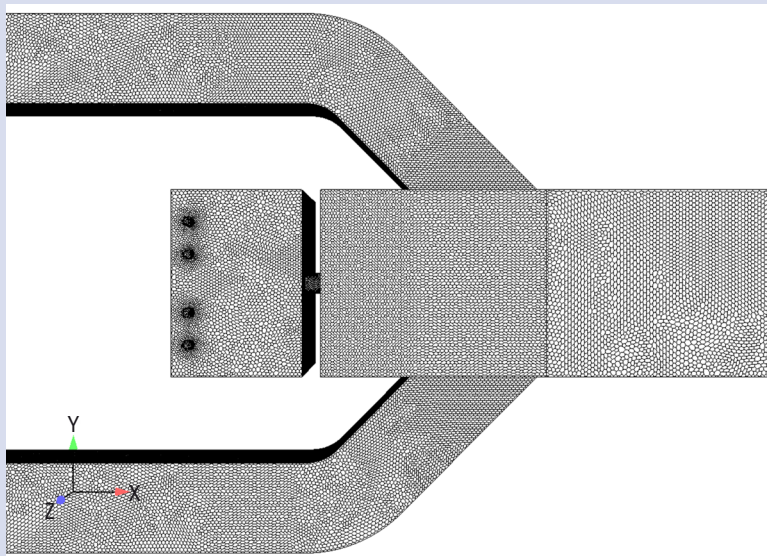

Numerical schemes

Spatial scheme: 2nd order

Temporal integration: Implicit 2nd order

Physical models

Turbulence: Smagorinsky closure [53]

Combustion: Arrhenius + 1 step adjusted reduced scheme for air-propane reaction [45]

Prediction of stability limits

At any flight regime, two limiting fuel/air ratios can be encountered: one involves excess fuel (rich) and the other involves excess air (lean) leading to the blow-off of the combustor. Of most practical interest is blow-off at fuel lean conditions, referred to as Lean Blow-Out (LBO). A study [23] has been carried out to improve the understanding of the physical processes involved in ramjet LBO and the calculations that could be done to predict this limit. In order to build an experimental database on this phenomenon, tests have been performed with the Research Ramjet: from a nominal operating condition, the overall equivalence ratio was progressively reduced until the flame blow-out. Combustion modeling related to the RANS approach is the first to

have been considered to address the problem of predicting the flame blow-out. In particular, a Partially Stirred Reactor (PaSR) combustion model has been used to predict the LBO of the Research Ramjet operated as a SDR combustor in the High Altitude flight regime.

The PaSR combustion model is based on the Eddy Dissipation Concept model introduced by Magnussen [25]. The fluid is divided into two zones: the fine-scale structure regions, which are spatially intermittent, and which occupy a volume that is only a small part of the domain of fluid, and the "surrounding fluid". Reactants are supposed to be homogeneously mixed inside the fine-scale structures of the flow. Therefore, the fine-scale structures are supposed to behave like well-stirred reactors, with uniform internal composition and temperature, and potentially high reaction rates due to favorable mixing condi-

tions. The PaSR model provides a system of equations that defines the volume of the fine-scale structures, describes the chemical reaction process inside the fine-scale structure regions, and then relates the fine-scale structure parameters to the surrounding fluid characteristics. Further details about this model can be found in [2] and [31]. This model is well-suited for numerical simulations of combustion in ramjet engines, as it meets two major criteria: chemistry is not supposed to be infinitely fast, and premixed and non-premixed flames can be handled (no assumption is made on the combustion regime). A criterion for the extinction of the fine-scale structure regions has been added to the PaSR model. The basic idea is as follows [6]: when the residence time in the fine-scale structures becomes smaller than a typical chemical time scale, extinction occurs. This critical time scale can be viewed as the blow-off residence time of the perfectly stirred reactor (PSR) corresponding to the fine-scale structure.

Significant results have been obtained [23]. In particular, using the PaSR combustion model and the local extinction criterion, the LBO limit is predicted at $\Phi = 0.30$, which is fully satisfactory compared to the measured limits, which lie between 0.28 and 0.30. This study has partly demonstrated the ability of this approach to predict the LBO limit of a practical ramjet combustion chamber. Nevertheless, further calculations are necessary to assess and validate the ability of numerical simulations to predict the LBO limits of any gaseous or liquid-fueled ramjet combustor.

Combustion instabilities

Understanding and predicting self-induced combustion instabilities in ramjet combustion chambers – and in any combustion chamber in general – is still a challenge. Combustion instabilities in ramjet combustors can have dramatic consequences: unstarting of the inlets, destruction of the thermal insulator, deterioration of the equipment attached to the engine structure, and even destruction of the burner.

Many driving mechanisms have been proposed to explain the transfer of energy to the unsteady motions in ramjet combustors. For liquid-fueled ramjets, a coupling between acoustics and the transient phenomena related to fuel injection, such as primary and secondary break-up, heating and vaporization, or with the fuel supply system itself, has been suggested [11]. Nevertheless, there is still a lack of experimental evidence to demonstrate that such couplings are responsible of combustion instabilities in ramjets. More attention has been paid to four other mechanisms: the unsteady behavior of the shock waves in the air inlets [10], the vortex shedding at the dump planes [51], the oscillations induced by the jet-on-jet impingement [32], and the coupling between the convective waves of entropy or vorticity and the acoustic waves [11]. All of those phenomena are prone to trigger instabilities, but, once again, being able to choose among them and point out, for any ramjet combustor, the root cause of the instability is still very difficult.

Concerning the experimental information available in the published material about unsteady motion in practical ramjet combustion chambers, only pressure measurements are available (e.g., [9] and [52]). One must recognize that it is insufficient to identify which mechanism is responsible for the unsteady behavior of the combustor. In this context, the Research Ramjet combustion chamber may be a very useful tool. First, pressure measurements have been performed to study the pressure oscillations encountered under various operating conditions, with piezoelectric transducers at a sampling frequency

of up to 40 kHz [41][42][44]. Then, high speed cameras have been implemented to study the flame front oscillations at a sampling frequency of 2 kHz [41][42][44]. The spectra obtained with the analysis of the visualizations for the SDR configuration in the High Altitude flight regime at $\Phi=0.35$ are displayed in Figure 15: the two main low-frequency modes of the burner at approximately 100 and 400 Hz, also evidenced by pressure transducers [41][42], are obtained by the study of the flame dynamics.

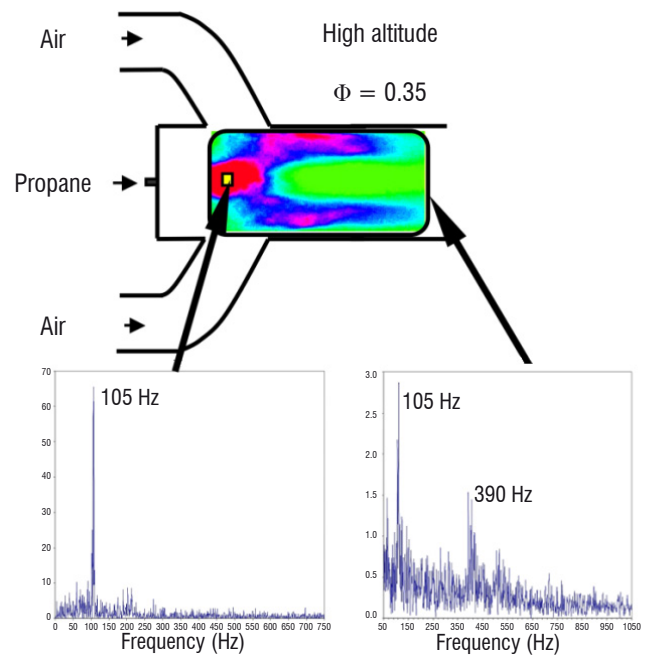

Figure 15 - FFT analysis of the flame visualizations obtained with a 2 kHz camera for the High Altitude $\Phi=0.35$ flight regime of the SDR configuration

In order to enable an in-depth analysis of the coupling mechanisms in a ramjet combustor that may be responsible for self-sustained unsteady motions, the coupling of unsteady experimental measurements is being applied within the framework of the Research Ramjet program. Thanks to this approach, very useful and quite unique data could be gathered. Recently, simultaneous visualizations of velocity fields, acquired with the PIV technique, and OH^* emission at a sampling rate of 2 kHz, combined and synchronized with high-frequency pressure probe measurements, have been performed [44]. In this first attempt on the Research Ramjet combustor, it was applied to a stable operating case. In the future, the coupling of these two techniques could be applied to study hydrodynamic instabilities and, especially, the interactions between the vortex shedding at the dump plane (through velocity measurements) and the heat release (through radical OH visualization), which is one of the most likely mechanisms for combustion instability in ramjet engines. Such measurements would be, anyway, very useful to validate unsteady numerical simulations.

LES appears as the main tool to predict the occurrence of combustion instabilities in ramjet combustors. However, as mentioned in [22], the simulation of combustion instabilities is more complicated than the other issues mentioned above. Among the technical difficulties to be addressed, one can mention:

- The necessity for accurately predicting the instantaneous heat release, as it is the main provider of the energy transferred to the acoustics. In this respect, special care must be taken when modeling the kinetics, the interaction of combustion and turbulence, etc. Combustion modeling within the framework of LES

is still an open issue, which is beyond the scope of this paper (for additional information see, for example, the reviews in [7], [34] or [35]);

- The requirement for having a good description of the boundary conditions. Of prime interest are the upstream (oscillatory shocks in the inlet diffusers) and downstream (choked nozzle) boundaries. Ramjet combustion chambers are usually compact enough to include air inlets and an exhaust nozzle in the computational domain at an affordable cost, making additional models like NSCBC unnecessary;
- The requirement for predicting the behavior of the disperse phase in the liquid-fueled ramjet combustors, and all of the phenomena related to it (secondary break-up, droplet heating and evaporation, droplet interaction with walls, etc.). Although it is not discussed in this paper, studies are being performed within the framework of the program to improve the simulation of the disperse phase in ramjet combustors;
- And, of course, the requirement for using a CFD code with numerical schemes as robust and accurate as possible, able to predict the propagation of the convective and acoustic waves without too much dissipation and dispersion, on unstructured meshes, with both supersonic and subsonic zones.

Results of LES aimed at predicting combustion instabilities in ramjet combustion chambers have not been published yet. However, increasing success of the LES approach to predict occurrence of combustion instabilities in other types of burners can be found in the literature (e.g., [13] [14] [16] [18] [54]). Consequently, there is no doubt that this technique may bring satisfactory results in the near future for ramjet combustors.

Conclusion and perspectives

A brief overview of the numerical and experimental studies conducted at ONERA to improve numerical simulations of ramjet combustors has been presented. Since the writing of a review article twenty years ago listing the main issues, many studies have been carried out to progress, especially within the framework of a specific program named "Research Ramjet". A specific combustion chamber has been designed and optical measurement techniques have been applied in order to build-up a detailed database on internal reactive and non-reactive flows. Improvements have been achieved in the understanding of the physical phenomena and in the predictability of the numerical prediction. However, further studies are still required to accurately predict any operating condition in the entire flight range. Intermediate results of numerical simulations have been presented. The Lean Blow-Out of the SDR combustor has been successfully predicted with a RANS-PaSR model. Nevertheless, further calculations are necessary to assess and validate the ability of this approach to predict the LBO limits of any gaseous or liquid-fueled ramjet combustor. Auspicious results have been provided by LES, concerning the internal gaseous reactive and stable flow of ramjet engines. Nevertheless, none of the simulations performed has demonstrated its ability to accurately predict the overall performance parameters of the combustion chamber, namely the combustion efficiency and the pressure loss. One of the most encouraging prospects is the improvement of the near-wall physical phenomena simulation, such as friction and convective heat transfer, which affect the overall efficiencies. This could be effectively achieved by Detached Eddy Simulation. Note that this technique has already been successfully implemented with CEDRE [48][49]. Future experimental and numerical work should also focus on the self-sustained unsteady motions in ramjet combustors, with the aim of understanding the coupling mechanisms and developing the capacity of LES to predict combustion instabilities. ■

Acknowledgements

The authors thank the French *Délégation Générale de l'Armement* (DGA) for its financial support in the Research Ramjet program and its permission to publish these results. The authors also wish to thank their colleagues at ONERA for their contributions to this work.

References

- [1] *Experimental and Analytical Methods for the Determination of Connected-Pipe Ramjet and Ducted Rocket Internal Performance*. AGARD Advisory Report 323, 1994.
- [2] M. BERGLUND, E. FEDINA, C. FUREBY, J. TEGNER, V. SABEL'NIKOV – *Finite Rate Chemistry Large-Eddy Simulation of Self-Ignition in a Supersonic Combustion Ramjet*. AIAA Journal, Vol. 48, No. 3, pp. 540–550, 2010.
- [3] N. BERTIER, L.-H. DOREY – *Mécanisme réactionnel avec PEA pour la combustion du kerosene dans l'air*. Rapport Technique RT 3/17454 DEFA, Onera, 2010.
- [4] P. BERTON, R. MARGUET, B. PETIT – *Le Statoréacteur à l'Onera. Histoire et Perspectives*. Colloquium AAAF “Le Statoréacteur en France : Histoire et Avenir”, 1991.
- [5] C. BROSSARD, P. GICQUEL, M. BARAT, A. RISTORI – *Experimental Study of a High Speed Flow Inside a Dual Research Ducted Rocket Combustor Using Laser Doppler*. 11th International Symposium on Applications of Laser Techniques to Fluid Mechanics, 2002
- [6] S. BYGGSTOYL – *A Model for Flame Extinction in Turbulent Flow*. 4th Symposium on Turbulent Shear Flows, 1983.
- [7] S. CANDEL – *Combustion Dynamics and Control: Progress and Challenges*. Proceedings of the Combustion Institute, Vol. 29, Issue 1, pp 1-28, 2002.
- [8] P. CAZIN – *Les Statoréacteurs à Combustible Liquide*. AGARD/PEP Lecture Series No.136 on “Ramjet and Ramrocket Propulsion Systems for Missiles”, 1984.
- [9] W. H. CLARK – *An Experimental Investigation of Pressure Oscillations in a Side Dump Ramjet Combustor*. AIAA/SAE/ASME 16th Joint Propulsion Conference, 1980.
- [10] F.E.C. CULICK, T. ROGERS – *The Response of Normal Shocks in Diffusers*. AIAA Journal, Vol. 21, No.10, pp. 1382-1390, 1983.
- [11] F.E.C. CULICK – *Combustion Instabilities in Liquid-Fueled Propulsion Systems – An overview*. AGARD Conference Proceedings, 450, 1988.
- [12] F.E.C. CULICK – *Unsteady Motions in Combustion Chambers for Propulsion systems*. RTO AGARDograph AG- AVT- 039, 2006.
- [13] C. DUWIG, C. FUREBY – *Large Eddy Simulation of Unsteady Lean Stratified Premixed Combustion*. Combustion and Flame, Vol. 151, pp. 85-103, 2007.
- [14] B. FRANZELLI, E. RIBER, L.Y.M. GICQUEL, T. POINSOT – *Large Eddy Simulation of Combustion Instabilities in a Lean Partially Premixed Swirled Flame*. Combustion and Flame, Volume 159, Issue 2, pp. 621-637, 2012.
- [15] R. S. FRY – *A Century of Ramjet Propulsion Technology Evolution*. Journal of Propulsion and Power, Vol. 20, No.1, 2004.
- [16] A. GHANI, T. POINSOT, L. GICQUEL, G. STAFFELBACH – *LES of Longitudinal and Transverse Self-excited Combustion Instabilities in a Bluff-body Stabilized Turbulent Premixed Flame*. Combustion and Flame, Vol. 162, Issue 11, pp. 4075-4083, 2015.
- [17] L. Y. M. GICQUEL, A. ROUX – *LES to Ease Understanding of Complex Unsteady Combustion Features of Ramjet Burners*. Flow Turbulence Combust., Vol. 87, pp. 449-472, 2011.
- [18] X. HAN, J. LI, A.S. MORGANS – *Prediction of Combustion Instability Limit Cycle Oscillations by Combining Flame Describing Function Simulations with a Thermoacoustic Network Model*. Combustion and Flame, Vol. 162, Issue 10, pp. 3632-3647, 2015.
- [19] G. HEID, A. RISTORI – *An Optical Method for Local Equivalence Ratio Measurements Applied to Hydraulic Simulation of a Ramjet Combustion Chamber*. Proceedings of PSFVIP-4, 2003.
- [20] G. HEID, A. RISTORI – *Local Fuel Concentration Measurements in a Research Ramjet Combustion Chamber by Gas Sampling Analysis with Carbon Dioxide Injection at the Head End of the Combustor*. 17th International Symposium on Air Breathing Engines (ISABE), 2005.
- [21] W. P. JONES, R. P. LINDSTEDT – *Global Reaction Schemes for Hydrocarbon Combustion*. Combustion and flame, Vol. 73, pp. 233-249, 1988.
- [22] A. LAVERDANT – *Basic Research on Liquid Fuel Ramjets, Bibliographical Review and Critical Analysis*. La Recherche Aérospatiale, Vol. 5, pp. 311-323, 1995
- [23] T. LE PICHON, V. SABEL'NIKOV, Y. MOULE, A. COCHET – *Assessment of a Partially Stirred Reactor Combustion Model to Predict the Lean Blow-Out limit of a Ramjet Combustor*. 18th AIAA International Space Planes and Hypersonic Systems and Technology Conference, 2012.
- [24] R. LEDUC – *Early Work and Latest Realizations with Ram-Jet Engines*. American Rocket Society Semi-Annual Meeting, Cleveland, Ohio, June 1956.
- [25] B. C. MAGNUSSEN – *The Eddy Dissipation Concept: a Bridge Between Science and Technology*. ECCOMAS Thematic Conference on Computational Combustion, Lisbon, Portugal, 2005.
- [26] R. MARGUET, M. BARRERE, R. CERESUELA – *Propulsion des véhicules hypersoniques*. Note technique ONERA No.169, 1970.
- [27] R. MARGUET – *Ramjet Research and Applications in France*. 9th International Symposium on Air Breathing Engines (ISABE), 1989.
- [28] R. MARGUET, P. BERTON, F. HIRSINGER – *L'étude du statoréacteur supersonique et hypersonique en France de 1950 à 1974 (Application aux moteurs combinés aérobies)*. 75th AGARD/PEP on Hypersonic Combined Cycle Propulsion, 1995.
- [29] R. MARGUET, P. CAZIN, F. FALEMPIN, B. PETIT – *Review and Comments on Ramjet Research in France*. 13th International symposium on Airbreathing engines (ISABE), 1997.
- [30] X. MONTAZEL – *Étude expérimentale et modélisation de la combustion turbulente dans les foyers de statoréacteurs*. PhD thesis, Ecole Centrale Paris, 1994.
- [31] Y. MOULE, V. SABEL'NIKOV, A. MURA – *Modeling of Self-Ignition Processes in Supersonic Non Premixed Coflowing Jets Based on a PaSR Approach*. 17th AIAA International Space Planes and Hypersonic Systems and Technologies Conference, 2011.
- [32] N. S. NOSSEIR, U. PELED – *The Pressure Field Generated by Jet-Jet Impingement*. 10th Aeroacoustics Conference, 1986.
- [33] B. PETIT – *Ramjets and Scramjets*. Encyclopedia of Physical Science and Technology, Third Edition, pp. 867-884, 2002.
- [34] H. PITTSCH – *Large-Eddy Simulation of Turbulent Combustion*. Annu. Rev. Fluid Mech., no 38, pp 453-482, 2006.
- [35] T. POINSOT, D. VEYNANTE - *Theoretical and Numerical Combustion*. Second Edition, 2005.
- [36] S. REICHSTADT, N. BERTIER, A. RISTORI, P. BRUEL – *Towards LES of Mixing Processes Inside a Research Ramjet Combustor*. 18th International Symposium on Air Breathing Engines (ISABE), 2007.
- [37] S. REICHSTADT – *Etude du mélange et de la combustion monophasique dans un statoréacteur de recherche*. PhD thesis, Université de Pau et des Pays de l'Adour, 2007.
- [38] A. RISTORI, G. HEID, A. COCHET, G. LAVERGNE – *Experimental and Numerical Study of the Turbulent Flow inside a Dual Inlet Research Ducted Rocket Combustor*. 14th International Symposium on Air Breathing Engines (ISABE), 1999.
- [39] A. RISTORI, A. COCHET – *Research Ramjet Program: an Initiative to Improve Knowledge on Ramjet Reactive Flowfields*. 4th Onera/DLR Aerospace Symposium, 2002.

- [40] A. RISTORI, G. HEID, C. BROSSARD, A. BRESSON – *Characterization of the Racting Two-Phase Flow Inside a Research Ramjet combustor*. International Conference on Liquid Atomization and Spray Systems (ICLASS), 2003.
- [41] A. RISTORI, G. HEID, C. BROSSARD, S. REICHSTADT – *Detailed Characterization of the Reacting One-Phase and Two-Phase Flow Inside a Research Ramjet Combustor*. 17th International Symposium on Air Breathing Engines (ISABE), 2005.
- [42] A. RISTORI, C. BROSSARD, P. GICQUEL, M. BARAT, F. SOULIGNAC – *Caractérisation détaillée de l'écoulement par PIV et des instabilités de combustion par caméra vidéo rapide intensifiée dans la région du dôme du Statoréacteur de Recherche*. Congrès francophone de Techniques Laser (CFTL), 2006.
- [43] A. RISTORI, S. REICHSTADT, C. BROSSARD, G. HEID – *PIV and Gas Sampling Analysis Measurements for Fuel-to-Air Mixing Study Inside a Research Ramjet Combustor*. 13th International Symposium on Flow Visualization / 12th French Congress on Visualization in Fluid Mechanics, 2008.
- [44] A. RISTORI, C. BROSSARD, T. LE PICHON – *Caractérisation de l'écoulement instationnaire dans un Statoréacteur de Recherche par PIV et visualisations OH* à hautes cadences simultanées*. 14^{ème} Congrès Francophone de Techniques Laser (CFTL), 2014.
- [45] A. ROUX, S. REICHSTADT, N. BERTIER, L. Y. M. GICQUEL, F. VUILLOT, T. POINSOT – *Comparison of Numerical Methods and Combustion Models for LES of a Ramjet*. C. R. Mécanique, Vol. 337, No.6, p. 352-361, 2009.
- [46] A. ROUX – *Simulation aux Grandes Echelles d'un statoréacteur*. PhD thesis, Institut National Polytechnique de Toulouse, 2009.
- [47] A. ROUX, L. Y. M. GICQUEL, S. REICHSTADT, N. BERTIER, G. STAFFELBACH, F. VUILLOT, T. J. POINSOT – *Analysis of Unsteady Reacting Flows and Impact of Chemistry Description in Large Eddy Simulations of Side-Dump Ramjet Combustors*. Combustion and Flame, Vol. 157, No.1, pp. 176-191, 2010.
- [48] B. SAINTE-ROSE, N. BERTIER, S. DECK, F. DUPOIRIEUX – *A DES Method Applied to a Backward Facing Step Reactive Flow*. C. R. Mécanique, Vol. 337, Issues 6–7, pp. 340-351, 2009.
- [49] B. SAINTE-ROSE, N. BERTIER, S. DECK, F. DUPOIRIEUX – *Numerical Simulations and Physical Analysis of an Overexpanded Reactive Gas Flow in a Planar Nozzle*. Combustion and Flame, Vol. 159, Issue 9, pp. 2856-2871, 2012.
- [50] J-M. SAMANIEGO – *Etude des instabilités de combustion dans les statoréacteurs*. PhD thesis, Ecole Centrale Paris, 1992.
- [51] K. C. SCHADOW, E. GUTMARK – *Combustion Instability Related to Vortex Shedding in Dump Combustors and their Passive Control*. Prog. Energy Combust. Sci., Vol. 18, pp. 117-132, 1992.
- [52] B. SJÖBLOM – *Full-Scale Liquid Fuel Ramjet Combustor Tests*. 9th International Symposium on Air Breathing Engines, Vol. 1, pp 273-281, 1989.
- [53] J. SMAGORINSKY – *General Circulation Experiments with the Primitive Equations. I. The Basic Experiment*. Monthly Weather Review, Vol. 91, No.3, 1963.
- [54] G. STAFFELBACH, L.Y.M. GICQUEL, G. BOUDIER, T. POINSOT – *Large Eddy Simulation of Self Excited Azimuthal Modes in Annular Combustors*. Proceedings of the Combustion Institute, Volume 32, Issue 2, pp. 2909-2916, 2009.
- [55] Y. M. TIMNAT – *Recent Developments in Ramjets, Ducted Rockets and Scramjets*. Prog. Aerospace Sci., Vol. 27, pp. 201-235, 1990.
- [56] C. WESTBROOK, F. DRYER – *Simplified Reaction Mechanisms for the Oxidation of Hydrocarbon Fuels in Flame*. Comb. Science and Technology, Vol. 27, pp. 31-43, 1981.
- [57] K-A. ZETTERSTRÖM, B. SJÖBLOM, A. JARNMO – *Solid Ducted Rocket Engine Combustor Tests*. 6th International Symposium on Air Breathing Engines, pp 9-16, 1983.

Acronyms

CEDRE	(Calculs d'Écoulements Diphasiques Réactifs pour l'Énergétique)	LDV	(Laser Doppler Velocimetry)
CFD	(Computational Fluid Dynamics)	LES	(Large Eddy Simulation)
CFL	(Courant Friedrichs Lewy)	LIC	(Lateral Injection Combustor)
DES	(Detached Eddy Simulation)	LFRJ	(Liquid-Fueled Ramjet)
EDC	(Eddy Dissipation Concept)	PaSR	(Partially-Stirred Reactor)
EM2C	(Énergétique Moléculaire et Macroscopique, Combustion)	PIV	(Particle Image Velocimetry)
HA	(High Altitude)	PSR	(Perfectly Stirred Reactor)
IRR	(Integral Rocket Ramjet)	RANS	(Reynolds Averaged Navier-Stokes)
LBO	(Lean Blow-Out)	RRP	(Research Ramjet Program)
		SDR	(Solid Ducted Rocket)

AUTHORS



Thomas Le Pichon graduated from ENSMA and joined ONERA in 2009 as a research engineer. His activities are mainly focused on ramjet propulsion, including experimental and numerical studies. He has been responsible for the Research Ramjet Program since 2009.



Alain Laverdant graduated in 1976 from ESTACA, obtained his Masters Degree in Energetics and Fluid Mechanics in 1978, and his PhD in 1981. He received his *Thèse d'Etat* in combustion in 1991. He has been a Research Engineer in the Energetics Department of ONERA since 1981, and his activities are focused on acoustic combustion instabilities and reactive numerical simulations. He received the Estrade-Delcros, Houlléviqgue, Saintour, Jules Mahyer Prize from the French Science Academy in 1991.

