



HAL
open science

Viscoelasticity measurement and identification of viscoelastic parametric models

Franck Renaud, Gaël Chevallier, Jean-Luc Dion, Remy Lemaire

► **To cite this version:**

Franck Renaud, Gaël Chevallier, Jean-Luc Dion, Remy Lemaire. Viscoelasticity measurement and identification of viscoelastic parametric models. IDETC ASME Whashington DC, 2011, Unknown, Unknown Region. hal-01369217

HAL Id: hal-01369217

<https://hal.science/hal-01369217>

Submitted on 21 Jan 2022

HAL is a multi-disciplinary open access archive for the deposit and dissemination of scientific research documents, whether they are published or not. The documents may come from teaching and research institutions in France or abroad, or from public or private research centers.

L'archive ouverte pluridisciplinaire **HAL**, est destinée au dépôt et à la diffusion de documents scientifiques de niveau recherche, publiés ou non, émanant des établissements d'enseignement et de recherche français ou étrangers, des laboratoires publics ou privés.

DETC2011-47545

**DRAFT: VISCOELASTICITY MEASUREMENT AND IDENTIFICATION OF
VISCOELASTIC PARAMETRIC MODELS**

Franck Renaud
Gael Chevallier
Jean-Luc Dion
LISMMA-EA2336
ISMEP (Supmeca)
Saint-Ouen 93400
France

Email: franck.renaud@supmeca.fr

Rémi Lemaire
Bosch CB/ETF4
Drancy 93700
France

ABSTRACT

Generally speaking, the behaviour of viscoelastic material is more complicated than the behaviour proposed by classical models as Voigt, Maxwell or Zener. The stiffness of such materials is a frequency dependent complex function. Above 1000Hz, classical measurements techniques are unable to achieve accurate measurements of the stiffness. In this paper, a new Dynamical Mechanical Analysis (DMA) tester is presented. It allows the characterization of the shear stiffness of preloaded viscoelastic materials between 200 and 3500Hz and without using time-temperature equivalences. Then the Generalized Maxwell model is used to describe behaviours measured with the DMA tester. A new iterative identification method of the parameter of the Generalized Maxwell model is described. This identification method is based on the asymptotes of the model.

NOMENCLATURE

σ Stress.
 ε Strain.
 $h(t)$ Relaxation function.
 δX Displacement.
 N Force factor.
 δV Tension.

F Force.
 Q Power of the driver.
 f Frequency of excitation.
 C_e Electrical capacity.
 M Mass.
 K Stiffness.
 C Damping.
 ω Angular frequency.
 $\chi = \log(\omega)$ Logarithm of the angular frequency.
 ω_p Pole.
 ω_z Zero.
 S Stiffening.
 A Area.

INTRODUCTION

Many mechanical systems are damped with viscoelastic materials. This helps to avoid instabilities and to limit the levels of vibration. Although the viscoelastic behavior of materials is of great importance in order to obtain accurate results, the assumption of purely elastic materials is very commonplace for frequency analysis with Finite Element (FE) models. In order to carry out realistic Complex Eigenvalue Analysis (CEA) in dynamics, one needs to model viscoelasticity. Linear viscoelastic-

ity has been described by many authors, for citing just a few of them: Ferry [1], Vinh [2], Caputo [3], Lakes [4], Chevalier [5]. Linear viscoelasticity assumes the existence of a relation between stress, σ , of a material and its strain, ε , history. Let us call $h(t)$, the relaxation function which is also an element of the complex stiffness tensor. Linear viscoelasticity is defined by the Equation (1). The Fourier transform is denoted with a hat and $H = \hat{h}(\omega)$.

$$\begin{cases} \sigma(t) = \int_{-\infty}^t h(t-\tau)\varepsilon(\tau)d\tau \\ \hat{\sigma}(t) = H\hat{\varepsilon}(\omega) \end{cases} \quad (1)$$

Viscoelastic behaviour of materials is difficult to measure over a large frequential bandwidth. For that, several methods of characterization exist. Oberst and Frankenfeld [6] proposed to study the first mode of a sandwich beam made up of metal skins and of a viscoelastic heart. Their method makes it possible to know the damping induced by the viscoelastic heart at the frequency of the mode. Several authors use this kind of technique for the identification of viscoelastic parameters, Barbosa and Farage [7] and Castello et al. [8]. It is also possible to deduce the mechanical properties from a viscoelastic material starting from the measurement of the various Eigen frequencies of a sample having a simple form, a beam for example, see Chevalier [9]. These methods are equivalent with the deduction of the mechanical properties starting from Frequency Response Function (FRF). This type of methods allows only the characterization of the frequencies of the Eigen modes and not on a large frequential bandwidth. Moreover these methods are valid only under the linear material assumption in amplitude of excitation. Chen [10] proposed to directly measure the functions of relieving and creep to deduce the coefficients from them from a series of Prony. However, it is difficult to impose a level of perfect displacement, thus this method, which gives access to the behaviour on a large frequential bandwidth, is accurate only at low frequencies. For the characterization of viscoelastic materials, the Dynamic Mechanical Analysis (DMA) is the most suited technique. It allows one to measure the stress and the deformation of materials and thus to calculate the dynamic rigidity of the samples according to the frequency. DMA testers work into quasi-static, i.e. at frequencies lower than the first Eigen mode of the test bench. Currently, the best DMA testers allow characterizations, without using time-frequency equivalences, until approximately 1000Hz. Thus there is a need of a new DMA tester in order to measure the viscoelastic behaviour at higher frequencies in quasi-static excitation.

Tests on viscoelastic materials led by many authors exhibit strong stiffness frequency dependence on both modulus and

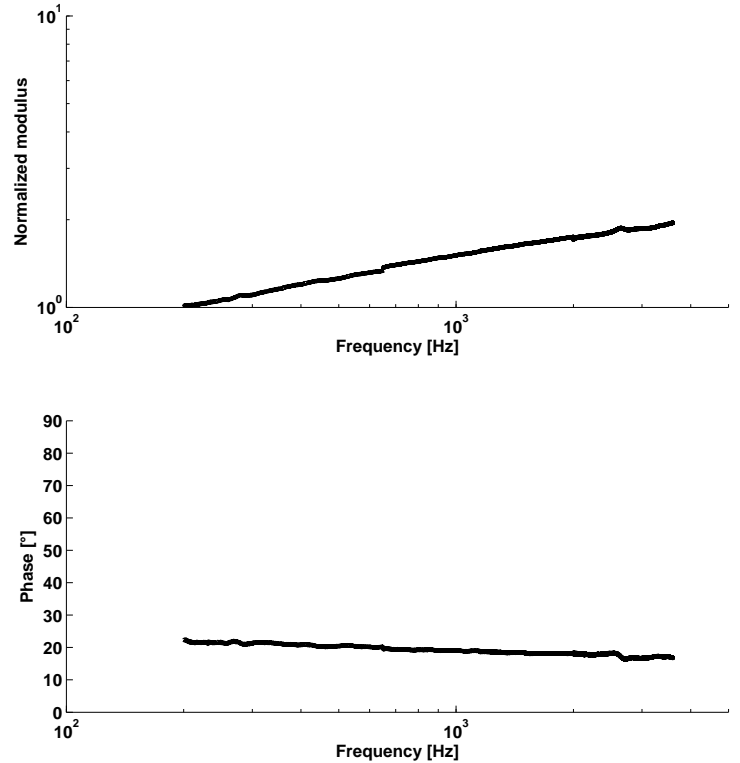

FIGURE 1. Complex shear stiffness of a multilayer viscoelastic material at ambient temperature in the [200-3500Hz] frequency range. The top graph represents the normalized modulus $H(f)/H(f = 200Hz)$ (dimensionless) and the bottom graph represents the phase ψ (in degrees).

phase, see Vinh [2], Soula [11]. For example, Figure 1 shows the stiffness of a multi layer material with layers of glue, rubber and steel. The non-zero value of the stiffness phase of viscoelastic materials is well known, because it generates damping. But the stiffness modulus is also frequency dependent, hence, simple models, with constant modulus, such as constant complex modulus or modal damping are not accurate. Many rheological models have been proposed for H , as the constant complex modulus, Maxwell, Voigt, Zener, etc (see Renaud et al. [12]). In the present paper Generalized Maxwell model is used. The parameters of this model will be identified from the curve of H against the angular frequency, see Renaud et al. [12].

Given an experimental transfer function characterizing a complex stiffness H , the identification of the parameters of the GMM can be carried out with some graphical methods. Two of them were described by Vinh [2] and Oustaloup [13]. These methods are led on a Pole-Zero Formulations which are equivalent to the GMM. The identification method presented here has been detailed in the article of Renaud et al. [12]. This method uses the characteristics of the asymptotes of Pole-Zero Formula-

tions and allows one to identify parameters from both the modulus and the phase curves.

PIEZOELECTRIC VISCOANALYZER (DMA) CONCEPT
Shear measurement principle

The DMA tester has been designed to characterize the dynamic shear stiffness of the samples under normal preload and in the frequential band between 1 to 5000Hz. The DMA tester works in quasi-static excitation, which means at any frequency below the first Eigen mode of the tester. The DMA tester can reach a maximum normal preload of 4MPa. Moreover this preload must be uniform on the whole sample surface.

The design of the DMA tester is shown on the Figure 2. The samples are gripped between the jaws and the holders of samples. Due to symmetry, this tester needs four samples for characterization. In contrary to the Oberst beam test and thanks to the symmetry principle, this DMA tester allows pure dynamical shear excitation without inflection. The normal preload is applied with a unique M6 bolt. The preload is limited to 5000N in order not to plasticize the jaws. The sample size, 20*30mm, is thus selected to ensure a pressure of 4MPa with a preload of 5000N.

The shearing of the samples is obtained by moving the supports in phase opposition. For that, two chains of actuation are placed between the holders. Thanks to the symmetry, there is no need to clamp the chains of actuation on a frame. These chains consist in a piezoelectric actuator, a connector and a force sensor.

Quasi static excitation

The piezoelectric actuators make it possible to reach high frequencies higher than 10 kHz. The frequential limit is set by the frequency of the first Eigen mode of the DMA tester. So this frequency must appear as high as possible. Consequently, the DMA tester is suspended by rubber bands to avoid Eigen modes coming from the frame. Actually, the tested viscoelastic materials have so low shear stiffness that the first Eigen mode is due to the mass of the holders and the actuation chains suspended by the tested samples. This Eigen mode generally appears around 4100Hz and limits the characterization to a frequency of 3500Hz.

The jaws are made in aluminium. Their design has been optimized so that the unique preloading bolt generates a uniform preload of the samples on their whole surface. This design also ensures the decoupling between the normal load and the shear load on the samples. The first Eigen mode of this jaw appears around 7500Hz.

The Figure 3 shows the capabilities of each piezoelectric

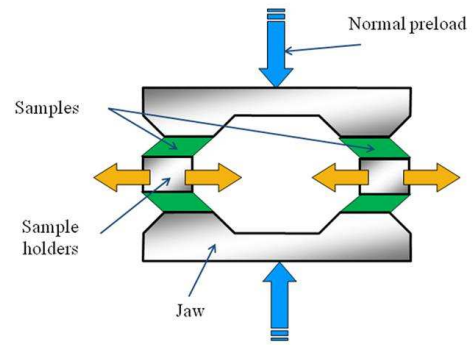

FIGURE 2. Principle and picture of the shear DMA tester.

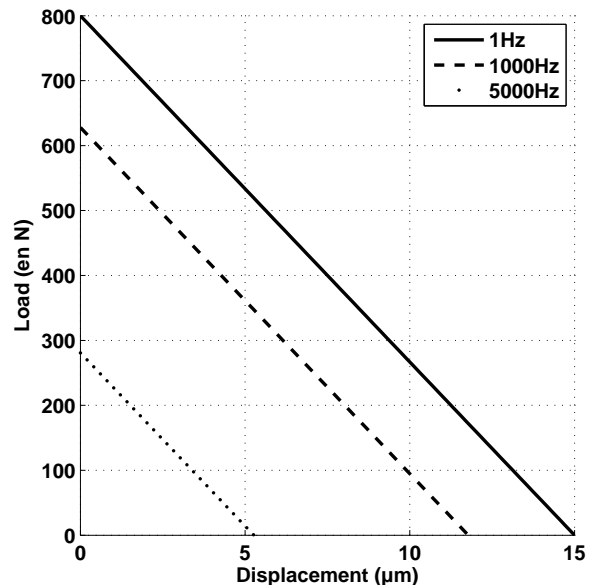

FIGURE 3. Real working characteristics of the piezoelectric actuators combined with a 30W driver.

actuator according to the Equation (2), with δX the displacement, F the force, K the stiffness of the actuator, δV the tension and N the force factor. The continuous line shows the force-displacement behavior of actuators, for the maximum electrical

alimantation: $\delta V = 100$ Volts.

$$\delta X = (N \delta V - F)/K \quad (2)$$

When their ends are blocked, the displacement is nil and the maximum pushing force they can generates is 800N. If their ends are free, the force is nil and the maximum displacement is $\delta X = 15$ m. Unfortunately, the actuators are similar to electric capacities, thus the more the frequency of excitation is raised and the more the actuators need current. Since, the power of the actuators driver is limited to $Q = 30$ Watts, the current is also limited, see Equation (4) and the real behaviors of actuators at $f = 1000$ Hz and $f = 5000$ Hz are shown in Figure 3.

$$Q = 2\pi f C_e V_p^2 \quad (3)$$

Test post processing

Basically, the complex shear stiffness of the samples is the ratio of the force spectra to the displacement spectra. However, the quasi-static excitation is applied until 3500Hz and some inertia effect must be taken into account in the post processing. Thus a simplified model of the DMA tester has been set, see Figure 4. The jaws are modeled by two identical masses, M_P , connected between them by a spring, K_{jaw} . The masses M_P represent the moving part of the jaw which undergoes the accelerations read by the accelerometers. Since, the DMA tester is quasi-symmetrical between the sides left and right, the central part of the jaws which constitutes the symmetry plane, does not move. Consequently, the masses of the screw M6 and the sensor of force do not move and one has $M_{P1} = M_{P2} = M_{jaw}/3 + M_{accelerometer}$. The spring K_{jaw} is the same one for the two jaws. It was evaluated starting from a calculation by finite elements. The two chains of actuation are identical and are made up of a sensor of force, a connector and a piezoelectric actuator. These two chains of actuation work in phase and push with the same force, thus they are regarded as one equivalent chain of actuation generating an equivalent force which is the sum of the forces of both $F_{piezo} = F_0 + F_1$. However, because of the efforts of inertia, the force measured on the level of the sensors, is neither equal to the force generated by the actuators nor equal to the force undergone by a sample. In order to take into account these efforts of inertia, the chains of actuation equivalent is modeled by three different masses M_{S1} , the mass of the support of left, M_R the mass of the connector and M_{S2} the mass of the support of right-hand side. F_{FS} is the force measured by the force sensors.

It is worth noticing that because of the efforts of inertia of the connector, the force generated by the piezoelectric actuators

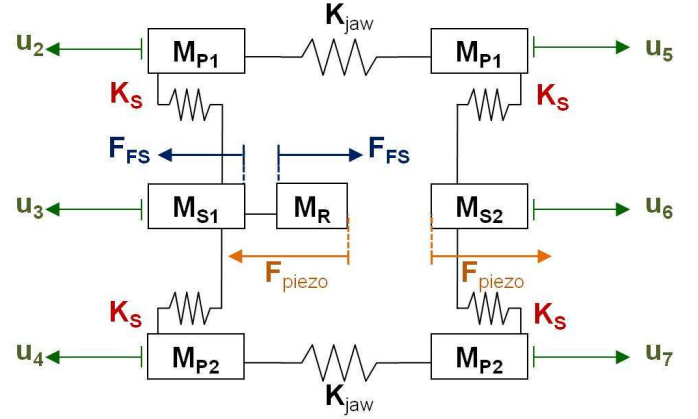

FIGURE 4. Model of the DMA tester for post processing.

is $F_{piezo} = M_R \ddot{u}_3 + F_{FS}$. The samples are modeled by pure stiffnesses, K_S . The equations of the dynamics of the system are given by the Equations (4).

$$\begin{aligned} (a) & \left\{ \begin{array}{l} M_{P1} \ddot{u}_2 = -K_{jaw}(u_2 + u_5) + K_S(u_3 - u_2) \\ M_{S1} \ddot{u}_3 = -K_S(2u_3 - u_2 - u_4) + F_{FS} \\ M_{P2} \ddot{u}_4 = -K_{jaw}(u_4 + u_7) + K_S(u_3 - u_4) \\ M_{P1} \ddot{u}_5 = -K_{jaw}(u_2 + u_5) + K_S(u_6 - u_5) \\ M_{S2} \ddot{u}_6 = -K_S(2u_6 - u_5 - u_7) + F_{FS} + M_R \ddot{u}_3 \\ M_{P2} \ddot{u}_7 = -K_{jaw}(u_4 + u_7) + K_S(u_6 - u_7) \end{array} \right. \quad (4) \end{aligned}$$

By calculating the sum of the relations (b)+(e), one obtains the stiffness, K_S , of the samples, see Equation (5)

$$K_S = \frac{(M_{S1} - M_R) \ddot{u}_3 + M_{S2} \ddot{u}_6 - 2F_{FS}}{u_2 + u_4 + u_5 + u_7 - 2u_3 - 2u_6} \quad (5)$$

Equation (5) is not used during post processing because displacements are calculated by double integration of accelerometer measurements. This double integration is carried out by the formula $\ddot{u} = -\omega^2 u$. Thus, the Equation is replaced by the Equation (6).

$$K_S = \omega^2 \frac{(M_{S1} - M_R) \ddot{u}_3 + M_{S2} \ddot{u}_6 - 2(F_0 + F_1)}{2\ddot{u}_3 + 2\ddot{u}_6 - \ddot{u}_2 - \ddot{u}_4 - \ddot{u}_5 - \ddot{u}_7} \quad (6)$$

Results on industrial specimens

The Figure 5 shows the complex shear stiffness of a multilayer viscoelastic material for two normal preloads : 500 and 5000N. This material is made of layers of glue, rubber and steel.

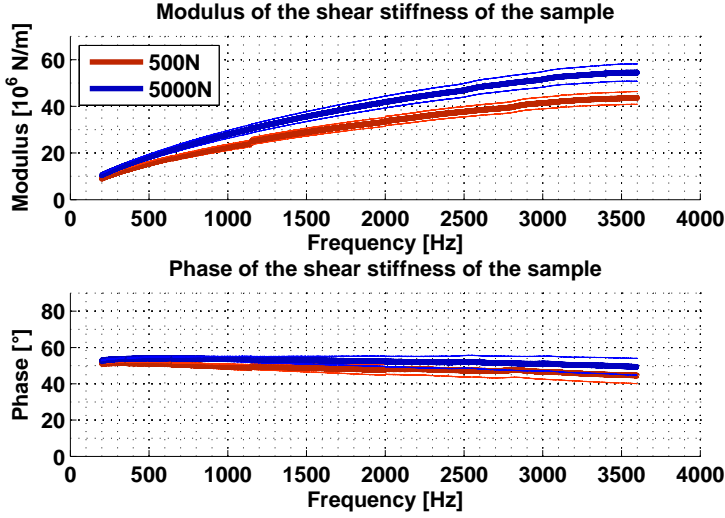

FIGURE 5. Modulus and phase of the shear stiffness of a multilayer viscoelastic material with layers of glue, rubber and steel. The blue curve has been obtained with a normal load of 5000N and the red one with a normal load of 500N.

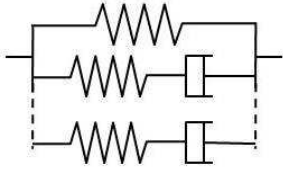

FIGURE 6. Rheological model of Generalized Maxwell.

One can see the stiffening effect of viscoelasticity. This stiffening effect cannot be taken into account by the common modal damping model. On the contrary, the Generalized Maxwell model is able to describe such behaviour.

IDENTIFICATION OF THE COMPLEX SHEAR MODULUS

The Generalized Maxwell model is a rheological model described by the Figure 6 and the Equation (7). It is composed of N Maxwell cells, with K_0 , the static stiffness, K_i the stiffness in the i^{th} Maxwell cell and C_i the damping in the i^{th} Maxwell cell.

$$Z(\omega) = K_0 + \sum_{i=1}^N \frac{j\omega K_i C_i}{K_i + j\omega C_i} \quad (7)$$

$$Z(\omega) = K_0 \prod_{i=1}^N \frac{1 + (j\omega/\omega_{z,i})}{1 + (j\omega/\omega_{p,i})} \quad (8)$$

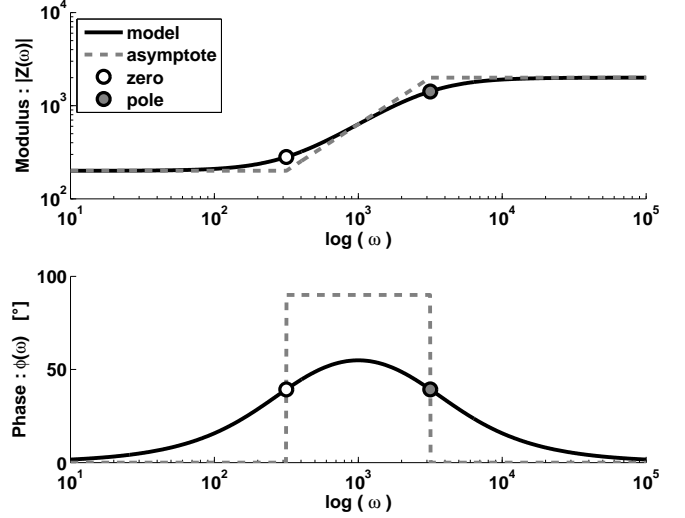

FIGURE 7. Behaviors of the modulus and the phase of one pole-zero couple and its asymptotes.

$$\begin{cases} K_i = K_0 \prod_{h=1}^N \left(\frac{\omega_{p,h}}{\omega_{z,h}} \right) \left(\frac{\omega_{p,i} - \omega_{z,h}}{\omega_{p,i} + \omega_{p,h}(\delta_{ih} - 1)} \right) \\ C_i = \frac{K_i}{\omega_{p,i}} \end{cases} \quad (9)$$

The identification of Generalized Maxwell parameters using a pole zero formulation has been fully detailed in the article of Renaud [12]. Let us summarize the main steps. First, it is worth noticing that in the logarithmic scale, the behaviour of a pole zero formulation is the sum of the behaviour of each pole zero couple. The modulus and the phase generated by one pole zero couple in logarithmic scale is given by the Equation (10).

$$\begin{cases} \log(|Z(\omega)|_i) = \frac{1}{2} \log \left(1 + \left(\frac{\omega}{\omega_{z,i}} \right)^2 \right) - \frac{1}{2} \log \left(1 + \left(\frac{\omega}{\omega_{p,i}} \right)^2 \right) \\ \phi_i(\omega) = \tan^{-1} \left(\frac{\omega}{\omega_{z,i}} \right) - \tan^{-1} \left(\frac{\omega}{\omega_{p,i}} \right) \end{cases} \quad (10)$$

Since this behaviour is non-linear against frequency, we will approach them with asymptotes, see Figure 7.

Let us define the stiffening $S(|Z|, \chi_a, \chi_b)$ and the area under the phase curve $A(\phi, \chi_a, \chi_b)$ by the Equation (11). The identification of poles and zeros will be led by equating the stiffening and the area of experimentally measured curves and the stiffening and the area of the model.

$\forall \chi_a = \log(\omega_a) \in \mathbb{R}$ and $\chi_b = \log(\omega_b) \in \mathbb{R}$,

$$\left\{ \begin{array}{l} S(|Z|, \chi_a, \chi_b) = \int_{\chi_a}^{\chi_b} \frac{\partial}{\partial \chi} \log(|Z(\chi)|) d\chi \\ \quad = \log(|Z(\chi_b)|) - \log(|Z(\chi_a)|) \\ \\ A(\varphi, \chi_a, \chi_b) = \int_{\chi_a}^{\chi_b} \varphi(\chi) d\chi \end{array} \right. \quad (11)$$

The stiffening and the area of the asymptotes are given by the Equation (12) and are easy to calculate. They are proportional to the gap between the pole and the zero: $\log(\omega_{p,i}) - \log(\omega_{z,i})$. Thus, by the knowledge of the stiffening and the area of experimentally measured curves, it is easy to obtain the gap between the pole and the zero.

$$\left\{ \begin{array}{l} S(|Z^{asy}(\chi)|_i, \chi_a, \chi_b) = \log(\omega_{p,i}) - \log(\omega_{z,i}) \\ A(\phi_i^{asy}(\chi), \chi_a, \chi_b) = \frac{\pi}{2} (\log(\omega_{p,i}) - \log(\omega_{z,i})) \end{array} \right. \quad (12)$$

The identification begins by an initialisation step. It consists in an apportionment of the frequency domain so that each sub domain has the same stiffening and phase area. Then the Equation (12) allows the calculation of one pole-zero couple in each sub domain. The initialisation step gives a first set of parameters which is optimized in a second step.

The difference between experimental curves and the model obtained after initialisation can be seen as local lacks and local excesses of stiffening and area. These local lacks and excesses are translated into difference between pole and zero, $\log(\omega_{p,i}) - \log(\omega_{z,i})$ by the Equation (12). It allows the adjustment of initial parameters by iteration.

For example, a local excess of stiffening appearing on the right of a pole-zero couple means that the pole has to tend towards the zero. On the contrary if this excess of stiffening appears on the left of a pole-zero couple, the zero has to tend towards the pole. Moreover, all pole-zero couples of the model are able to correct a local excess of stiffening, so all pole-zero couples of the model have to be adjusted. Actually, the behavior of the model at a frequency far from a pole-zero couple is quasi independent of this couple. Indeed, the contribution of a pole-zero couple, at a frequency far from it, is very low, see Figure 7. So the adjustment of a pole zero couple, because of a local difference, is weighted according to its local contribution

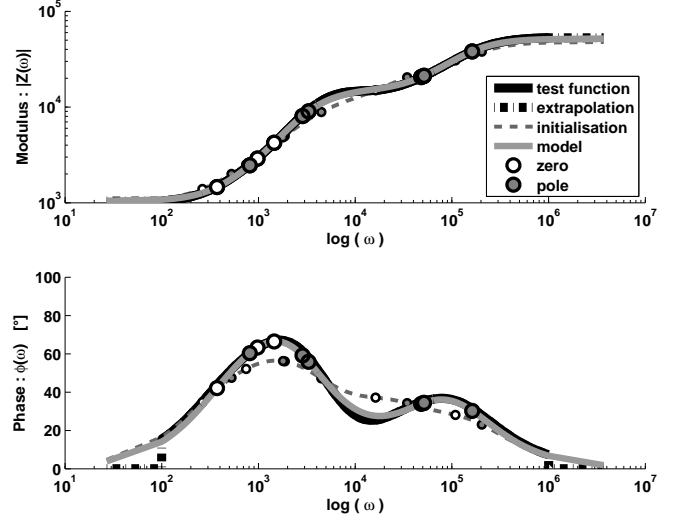

FIGURE 8. Given a test stiffness function, the identification is led in two steps: initialization and optimization.

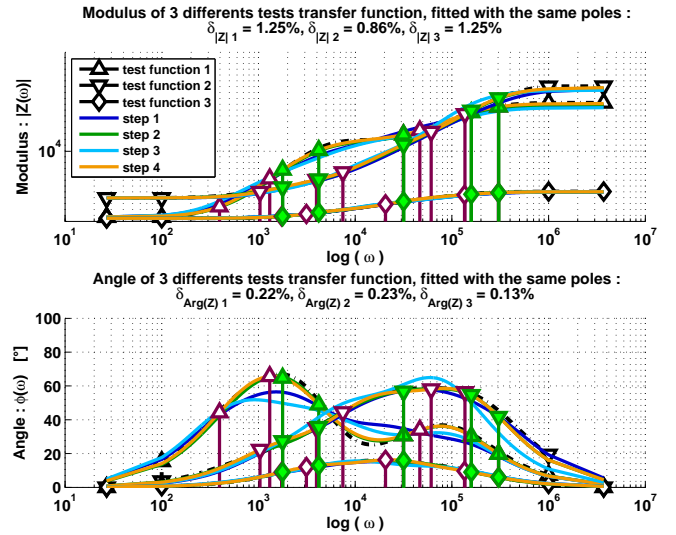

FIGURE 9. Identification of 3 viscoelastic materials in the same time, with the constraint of common poles

to the whole model.

This identification technique is efficient, see Figure 8. Unlike some others techniques based on non-linear optimization, it allows constraining the values of the zeros to be lower than the values of the poles to ensure the causality of the model, see Renaud [12]).

In general cases, several viscoelastic materials can appear in a same FE model. For some reasons concerning calculation

time, that are not developed here, it is better to have the same relaxation times for all materials. A relaxation time is equal to the inverse of a pole. So, in the case of 3 pole-zero models with 5 pole-zero couple, it means it is better to have 5 poles common to the 3 models. The inclusion of this constraint requires to do 2 more steps. The third one consists in calculating the mean value of the poles and recalculating the zeros. Then, the fourth step is an optimisation step analogous to the second one. The Figure 9 gives the final result of the identification process in the case of 3 test functions. The identification is still good.

CONCLUSIONS

A new Dynamical Mechanical Analysis (DMA) tester has been developed for the characterization of the shear stiffness of viscoelastic materials which are known to be frequency dependent. It allows direct characterization under preload, for frequencies starting from 200Hz to 3500Hz without using the time-temperature equivalences.

The Generalized Maxwell model has been chosen to describe the experimentally measured behavior of viscoelastic material. This rheological model is equivalent to a pole-zero formulation. An identification method has been developed. It allows to compute the poles and the zeros from the behavior of materials measured with the DMA tester. This method gives good results and allows ensuring the causality of the model by constraining the zeros to be lower than the poles. In the case of several materials to identify, this identification method allows computing same poles for all material. Since a pole is the inverse of a relaxation time, each material is thus modeled with the same relaxation times. This characteristic is of great importance for computation time reduction in FE models.

REFERENCES

- [1] Ferry, J. D., 1961. *Viscoelastic Properties Of Polymers*. John Wiley & Sons.
- [2] Vinh, T., 1967. “Sur le passage du régime harmonique au régime transitoire viscoélastique”. *Mémorial de l’artillerie française, 3ème fascicule*.
- [3] Caputo, M., and Mainardi, F., 1971. “Linear models of dissipation in anelastic solids”. In *La Rivista del Nuovo Cimento (1971-1977)*, I. P. Society, ed., Vol. 1. Italian Physical Society, avril, pp. 161–198.
- [4] Lakes, R. S., 1999. *Viscoelastic Solids*. CRC Press.
- [5] Chevalier, Y., and Vinh, J. T., 2010. *Mechanics of Viscoelastic Materials and Wave Dispersion*, Vol. 1. ISTE and John Wiley & Sons.
- [6] Oberst, H., and Frankenfeld, K., 1952. “Damping of the bending vibrations of thin laminated metal beams connected through adherent layer”. *Acustica 2*, pp. 181–194.
- [7] Barbosa, F., and Farage, M., 2008. “A finite element model for sandwich viscoelastic beams: Experimental and numerical assessment”. *Journal of Sound and Vibration*, **317**(1-2), pp. 91 – 111.
- [8] Castello, D., Rochinha, F., Roitman, N., and Magluta, C., 2008. “Constitutive parameter estimation of a viscoelastic model with internal variables”. *Mechanical Systems and Signal Processing*, **22**(8), pp. 1840 – 1857.
- [9] Chevalier, Y., 2002. Essais dynamiques sur composites. caractrisation aux basses frquences. Tech. rep., Techniques de l’ingnieur.
- [10] Chen, T., 2000. Determining a prony series for a viscoelastic material from time varying strain data. Tech. rep., NASA, may.
- [11] Soula, M., Vinh, T., Chevalier, Y., Beda, T., and Esteoule, C., 1997. “Measurements of isothermal complex moduli of viscoelastic materials over a large range of frequencies”. *Journal of Sound and Vibration*, **205**(2), pp. 167 – 184.
- [12] Renaud, F., Dion, J.-L., Chevallier, G., Tawfiq, I., and Lemaire, R., 2011. “A new identification method of viscoelastic behavior: Application to the generalized maxwell model”. *Mechanical Systems and Signal Processing*, **25**(3), pp. 991 – 1010.
- [13] Oustaloup, A., 1991. *La commande CRONE : commande robuste d’ordre non entier*. Hermès.